



LG

Life's Good

ENGLISH

OWNER'S MANUAL

IPS LED MONITOR (LED LCD MONITOR)

Please read this manual carefully before operating your set and retain it for future reference.

IPS LED(LED LCD) MONITOR MODEL

19MB35PM

22MB35PM

23MB35PM

WARNING: This product contains chemicals known to the State of California to cause cancer and birth defects or other reproductive harm. ***Wash hands after handling.***

CONTENTS

3 ASSEMBLING AND PREPARING

- 3 Unpacking
- 4 Parts and buttons
- 5 Setting up the Monitor set
- 5 - Attaching the Stand Base
- 5 - Detaching the stand base
- 6 - Detaching the stand body
- 7 - Mounting on a table
- 7 - Adjusting the angle
- 8 - Adjusting the stand height
- 8 - Using the Kensington locking device
- 9 - Swivel stand
- 9 - Using the Pivot function
- 10 - Mounting on a wall

11 USING THE MONITOR SET

- 11 Connecting to a PC
- 11 - D-SUB connection
- 11 - DVI-D connection
- 12 - Peripheral device connection

13 CUSTOMIZING SETTINGS

- 14 Customizing Settings
- 14 - Menu Settings
- 15 -Picture
- 16 -Color
- 17 -Display
- 18 -Others
- 19 READER Setting
- 20 -SUPER ENERGY SAVING

21 TROUBLESHOOTING

23 SPECIFICATIONS

- 23 19MB35PM
- 24 22MB35PM
- 25 23MB35PM
- 26 Preset Modes (Resolution)
- 26 Indicator

27 PROPER POSTURE

- 27 Proper posture for using the Monitor set.

ASSEMBLING AND PREPARING

Unpacking

Check your product box for the following items. If there are any missing accessories, contact the local dealer where you purchased your product. The illustrations in this manual may differ from the actual product and accessories.

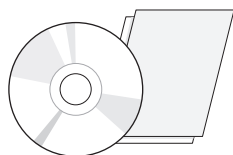

**CD(Owner's Manual) /
Card**

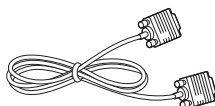

D-SUB Cable

(This cable is not included in all countries.)

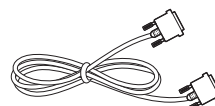

DVI-D Cable

(This cable is not included in all countries.)

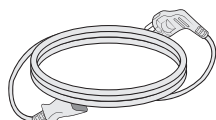

Power Cord

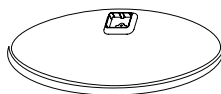

Stand Base



Audio Cable

(Depending on the country)



CAUTION

- Do not use any unapproved accessories to ensure the safety and product life span.
- Any damages or injuries by using unapproved accessories are not covered by the warranty.



NOTE

- The accessories supplied with your product may vary depending on the model.
- Product specifications or contents in this manual may be changed without prior notice due to upgrade of product functions.

Parts and buttons

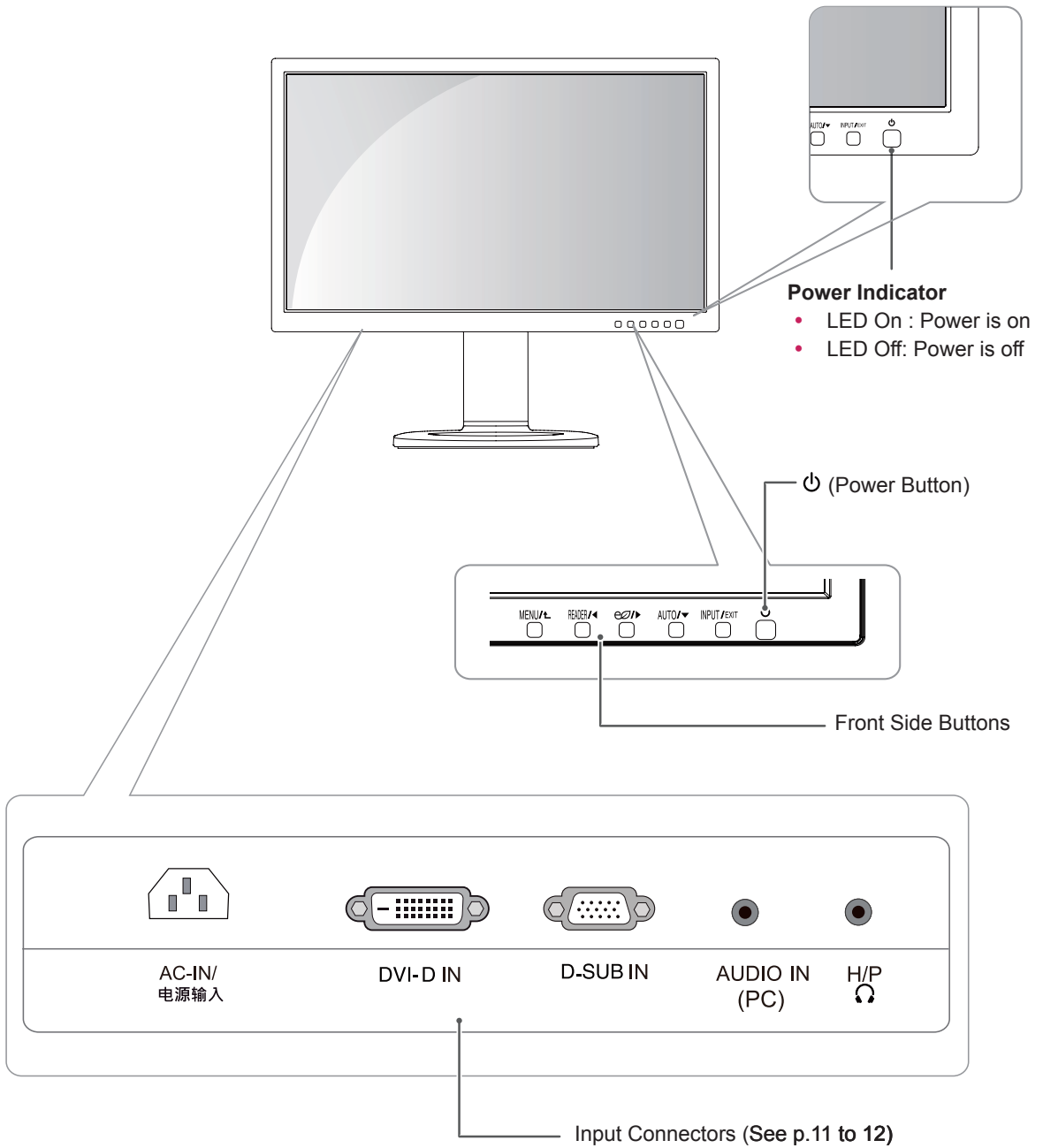

Setting up the Monitor set

Attaching the Stand Base

- 1 Place the Monitor set with the screen side down on a flat and cushioned surface.

CAUTION

- To protect the screen from scratches, cover the surface with a soft cloth.

- 2 Check the **position (at the front and rear)** of the stand body, then mount the **stand base** on the **stand body** as shown in the figure.

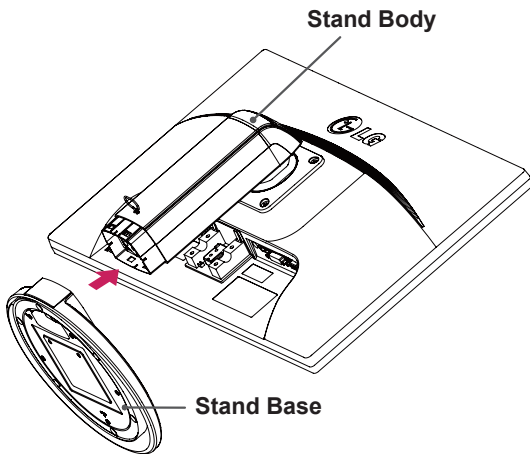

- 3 Using a coin, turn the screw clockwise to secure the **stand base**.

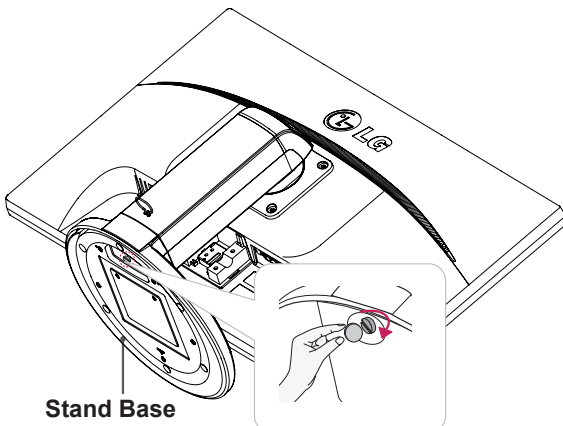

Detaching the stand base

- 1 Place the monitor's screen face down. To protect the screen from scratches, cover the surface with a soft cloth.
- 2 Using a coin, turn the screw in the stand base counterclockwise. Detach the **stand base** from the **stand body**.

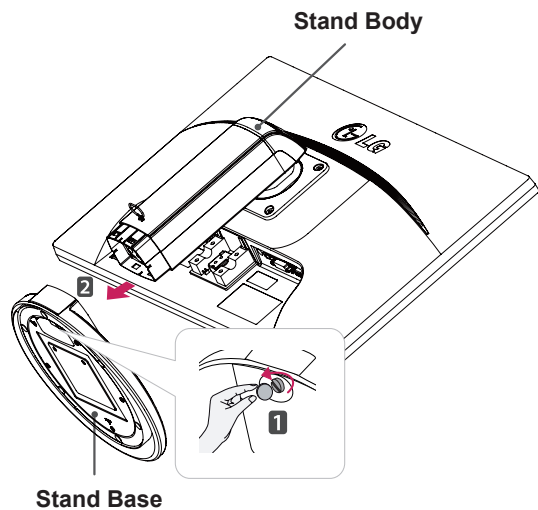

CAUTION

- The components appearing in the illustrations may look different from the actual product.
- Do not carry the monitor upside-down as this may cause it to fall off its stand, resulting in damage or injury.
- To avoid damaging the screen when lifting or moving the monitor, only hold the stand or the plastic cover. This avoids putting unnecessary pressure on the screen.
- Only remove the tape and the locking pin when the monitor is mounted on the stand base and is in an upright position. Otherwise, the stand body may protrude, which may lead to injury.

Detaching the stand body

- 1 Place the monitor's screen face down. To protect the screen from scratches, cover the surface with a soft cloth.
- 2 Using a screwdriver, remove the four screws and detach the stand from the monitor.

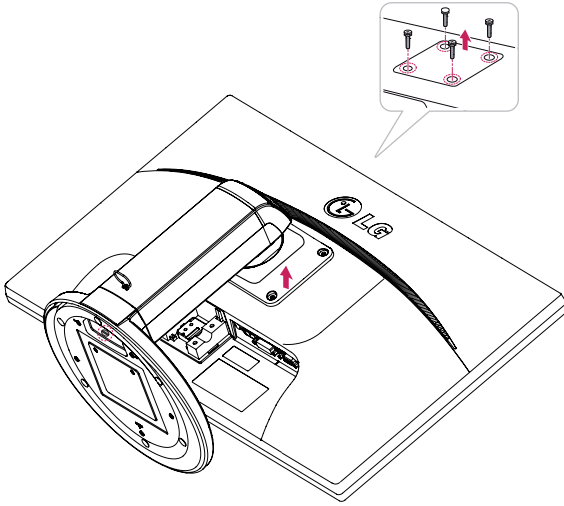

Mounting on a table

- 1 Lift the monitor and place it on the table in an upright position.

Install at least **10 cm** away from the wall to ensure sufficient ventilation.

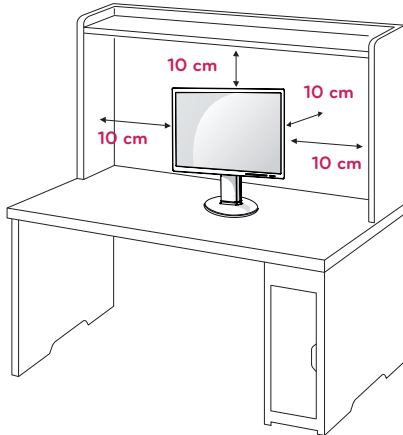

- 2 Connect the Power cord to the monitor, then plug the power cord into the wall outlet.

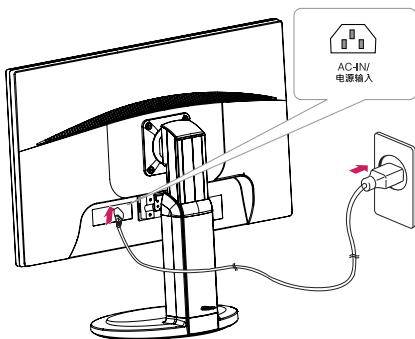

- 3 Press the ⏻ (Power) button on the front of the monitor to turn on the monitor.

CAUTION

- Unplug the power cord prior to moving or installing the monitor. There is risk of electric shock.

Adjusting the angle

- 1 Place the monitor mounted on the stand base in an upright position.
- 2 Adjust the angle of the screen. The angle of the screen can be adjusted up to 5° forwards and 20° backwards for a comfortable viewing experience.

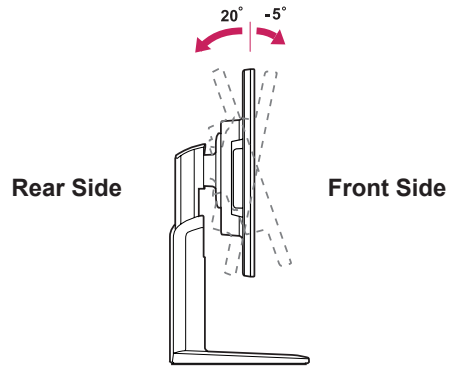

WARNING

- To avoid injury to the fingers when adjusting the screen, do not hold the lower part of the monitor's frame as illustrated below.

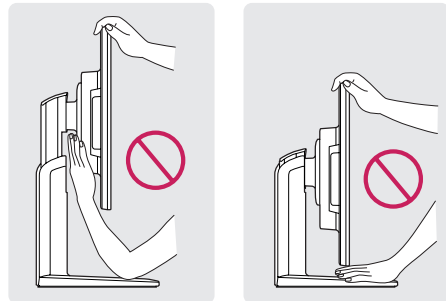

- Be careful not to touch or press the screen area when adjusting the angle of the monitor.

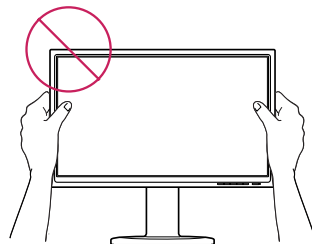

Adjusting the stand height

- 1 Place the monitor mounted on the stand base in an upright position.
- 2 Remove the **tape** attached at the bottom rear of the **stand body**, then pull out the **locking pin**.

Stand Body

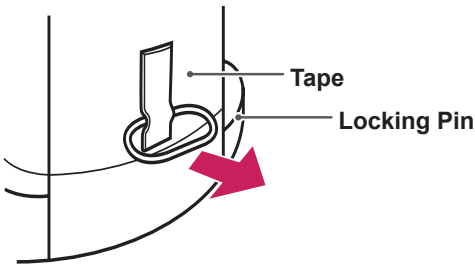

- 3 The height can be adjusted up to **110 mm**.

19MB35PM

22MB35PM

23MB35PM

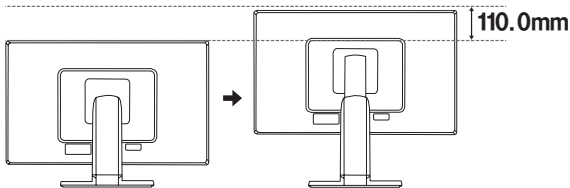

CAUTION

- Once the pin is removed, it is not necessary to re-insert it to adjust the height.



WARNING

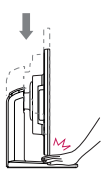

- Do not put your finger between the screen and the base (chassis) when adjusting the screen's height.

Using the Kensington locking device

The connector for the Kensington lock is located on the rear of the monitor.

For more information on installation and usage, refer to the Kensington lock user manual or visit the website at <http://www.kensington.com>.

Connect the monitor to the table with the Kensington lock cable.

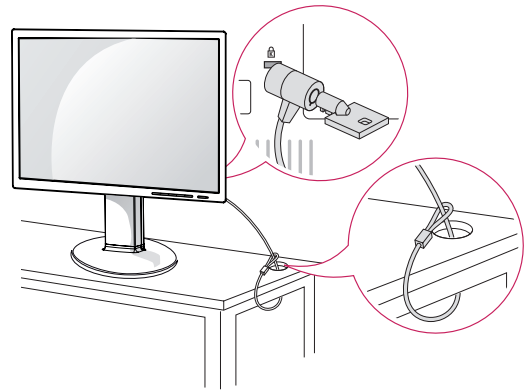

NOTE

- Using the Kensington lock is optional. The accessories can be purchased at your local electronics store.

Swivel stand

- Image shown may differ from your Monitor set.
- Swivel 355 degrees and adjust the angle of the Monitor set to suit your view.

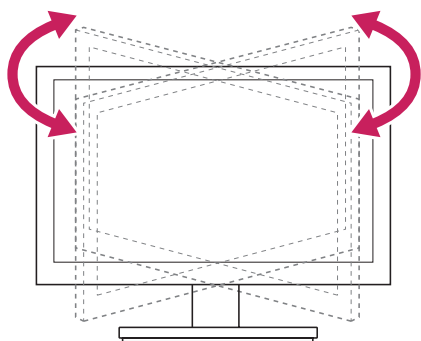

Using the Pivot function

The pivot function allows you to rotate the screen 90 degrees clockwise.

- Lift the monitor to its highest height to utilize the Pivot function.
- Landscape & Portrait : You can rotate the panel 90° clockwise. Please be cautious and avoid contact between the monitor head and the Stand Base when rotating the screen to access the Pivot function. If the monitor head touches the Stand Base, then the Stand Base could crack.

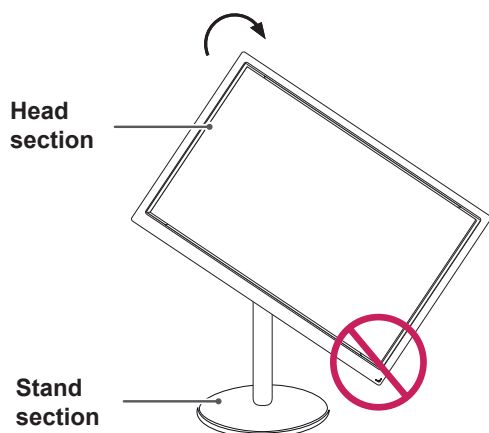

- Be careful with the cables when rotating the screen.

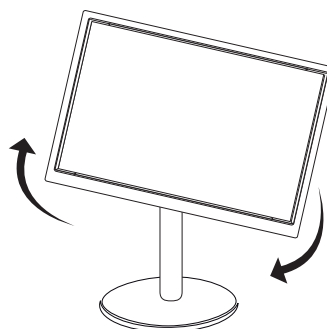
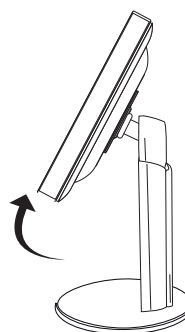
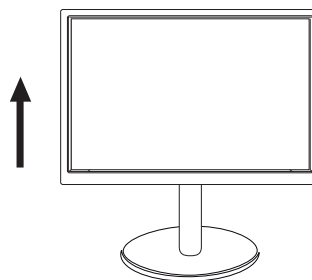

Mounting on a wall

For proper ventilation, allow a clearance of 10 cm on each side and from the wall. Detailed instructions are available from your dealer, see the optional Tilt Wall Mounting Bracket Installation and Setup Guide.

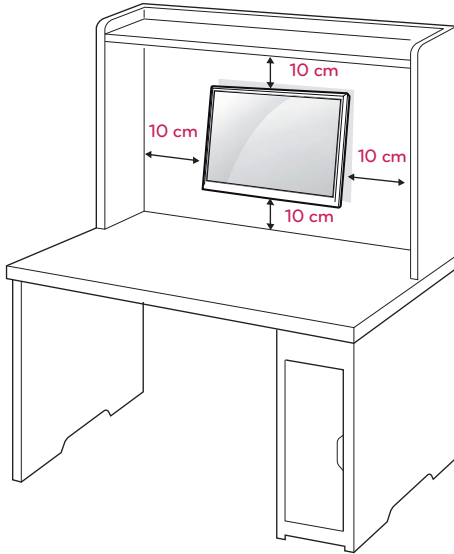

If you intend to mount the Monitor set to a wall, attach Wall mounting interface (optional parts) to the back of the set.

When you install the Monitor set using a wall mounting interface (optional parts), attach it carefully so it will not drop.

- 1 Please, Use the screw and wall mount interface in accordance with VESA Standards.
- 2 If you use screw longer than standard, the monitor might be damaged internally.
- 3 If you use improper screw, the product might be damaged and drop from mounted position. In this case, LG Electronics is not responsible for it.
- 4 VESA compatible.
- 5 Please use VESA standard as below.
 - 784.8 mm (30.9 inch) and under
 - * Wall Mount Pad Thickness : 2.6 mm
 - * Screw : Φ 4.0 mm x Pitch 0.7 mm x Length 10 mm
 - 787.4 mm (31.0 inch) and above
 - * Please use VESA standard wall mount pad and screws.

Model	19MB35PM	22MB35PM
	23MB35PM	
VESA (A x B)	75 x 75	100 x 100
Standard screw	M4	
Number of screws	4	



CAUTION

- Disconnect the power cord first, and then move or install the Monitor set. Otherwise electric shock may occur.
- If you install the Monitor set on a ceiling or slanted wall, it may fall and result in severe injury.
- Use only an authorized LG wall mount and contact the local dealer or qualified personnel.
- Do not over tighten the screws as this may cause damage to the Monitor set and void your warranty.
- Use only screws and wall mounts that meet the VESA standard. Any damages or injuries by misuse or using an improper accessory are not covered by the warranty.



NOTE

- Use the screws that are listed on the VESA standard screw specifications.
- The wall mount kit will include an installation manual and necessary parts.
- The wall mount bracket is optional. You can obtain additional accessories from your local dealer.
- The length of screws may differ depending on the wall mount. Be sure to use the proper length.
- For more information, refer to the instructions supplied with the wall mount.

USING THE MONITOR SET

Connecting to a PC

- Your Monitor set supports Plug & Play*.
- *Plug & Play: A PC recognizes a connected device that users connect to a PC and turn on, without device configuration or user intervention.

D-SUB connection

Transmits analog video from your PC to the Monitor set. Connect the PC and the Monitor set with the supplied D-sub 15 pin signal cable as shown in the following illustrations.

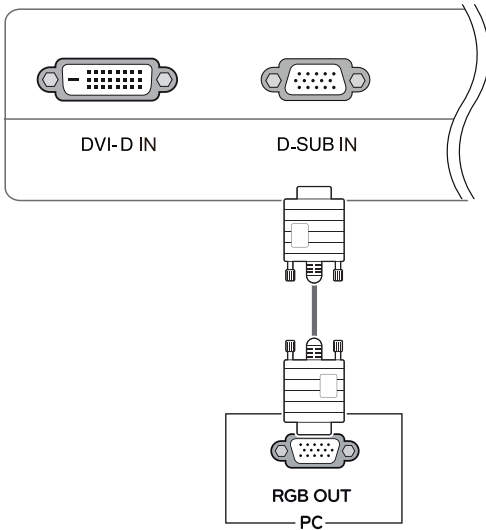

NOTE

- When using a D-Sub signal input cable connector for Macintosh

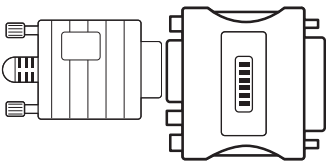

- Mac adapter**
For Apple Macintosh use, a separate plug adapter is needed to change the 15 pin high density (3 row) D-SUB VGA connector on the supplied cable to a 15 pin 2 row connector.

DVI-D connection

Transmits a digital video signal from your PC to the Monitor set. Connect the PC and the Monitor set with a DVI cable as shown in the following illustrations.

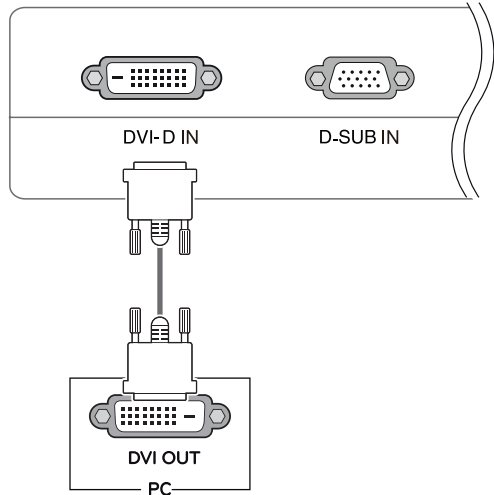

NOTE

- When you want to use two PC in our Monitor, please connect the signal cable(D-SUB/ DVI-D) respectively in Monitor set.
- If you turn the Monitor set on while it is cold, the screen may flicker. This is normal.
- Some red, green, or blue spots may appear on the screen. This is normal.

CAUTION

- Connect the signal input cable and tighten it by turning the screws clockwise.
- Do not press the screen with your finger for a long time as this may result in temporary distortion on the screen.
- Avoid displaying a fixed image on the screen for a long period of time to prevent image burn. Use a screensaver if possible.

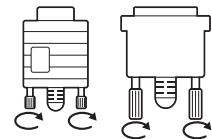

Peripheral device connection

Connect peripheral devices to the monitor using headphone ports.

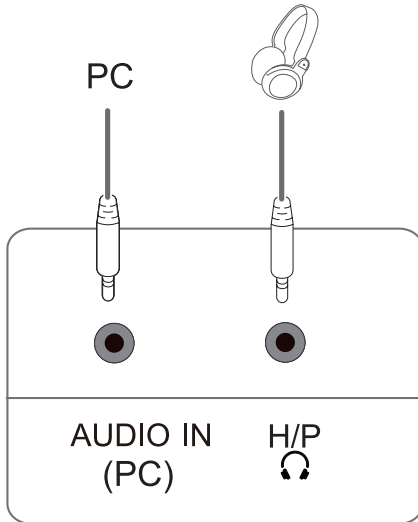

! NOTE

- Peripheral devices are sold separately.
- Cables with angled plugs may have clearance issues, use straight plugs when possible.



Angle Type

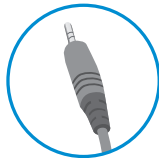

Straight Type

! NOTE

- Headphones or speakers may not work normally, depending on the server PC settings.

Self Image Setting Function

Press the power button on the bottom panel to turn the power on. When monitor power is turned on, the "Self Image Setting" Function is executed automatically. (Only supported in Analog Mode)

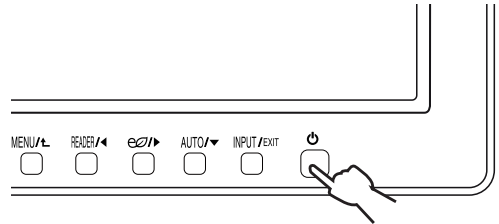

! NOTE

- **"Self Image Setting" Function.**
This function provides the user with optimal display settings. When the user connects the monitor for the first time, this function automatically adjusts the display to optimal settings for individual input signals. (Only supported in Analog Mode)
- **'AUTO' Function.**
When you encounter problems such as blurry screen, blurred letters, screen flicker or tilted screen while using the device or after changing screen resolution, press the AUTO function button to improve resolution. (Only supported in Analog Mode)

CUSTOMIZING SETTINGS

- 1 Press the desired button on the bottom of the Monitor set.
- 2 Change the value of the menu item by pressing the buttons on the bottom of the Monitor set.
To return to the upper menu or set other menu items, use the up arrow (⬆) button.
- 3 Select **EXIT** to leave the OSD menu.

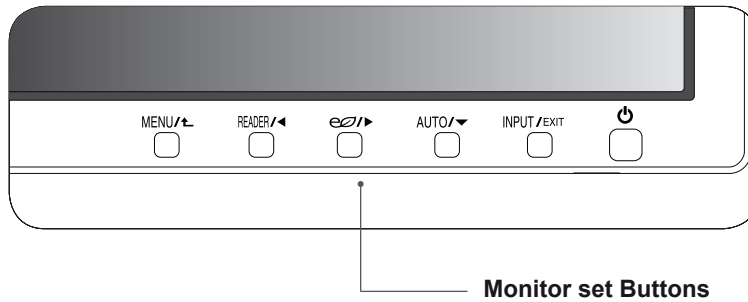

Button	Description
MENU / ⬆	<p>Accesses the main menus.(See p.14)</p> <p>OSD Locked/OSD Unlocked This function allow you to lock the current control settings, so that they cannot be inadvertently changed. Press and hold the MENU button for several seconds. Then OSD of "OSD Lock" will appear. After that, user can select lock or unlock by pressing left/right button. If user selects the "Lock" icon by pressing the "OK" button, the message "OSD Locked" will appear. Otherwise, "OSD Unlocked" will appear. After selecting the "Lock", If you want to change to Unlock, you can push the "MENU" button for several seconds. The message "OSD Unlocked" will appear.</p>
READER / ⬅	Use this button to enter Reader Mode menu. Its function works to display screen as paper-like picture for Eye comfort.If you want to more information.(See p.19)
e0 / ➡	Use this button to enter SUPER ENERGY SAVING menu.(See p.20)
AUTO / ▼	When adjusting your display settings, always press the AUTO button on the MONITOR SETUP OSD. (Only supported in Analog Mode)
	<p>The best display mode 19MB35PM:1280 x 1024 22MB35PM/23MB35PM:1920 x 1080</p>
INPUT / EXIT	<p>You can choose the input signal.</p> <ul style="list-style-type: none"> • When two input signals are connected, you can select the input signal (D-SUB/DVI) you want. • When only one signal is connected, it is automatically detected. The default setting is D-SUB. <p>EXIT</p> <p>Exit the OSD(On Screen Display).</p>
⏻ (Power Button)	Turns the power on or off.
	<p>Power Indicator The power indicator stays white if the display is running properly (On Mode). If the display is in Sleep Mode, the power indicator blinks white.</p>

Customizing Settings

Menu Settings

- 1 Press **MENU** button on the bottom of the Monitor set to display the **Menu** OSD.
- 2 Set the options by pressing the ◀ or ▶ or ▼ buttons.
- 3 Select the "**Next Menu**" button to enter the more option settings.
- 4 Select **EXIT** to leave the OSD menu.
To return to the upper menu or set other menu items, use the up arrow (⬆) button.

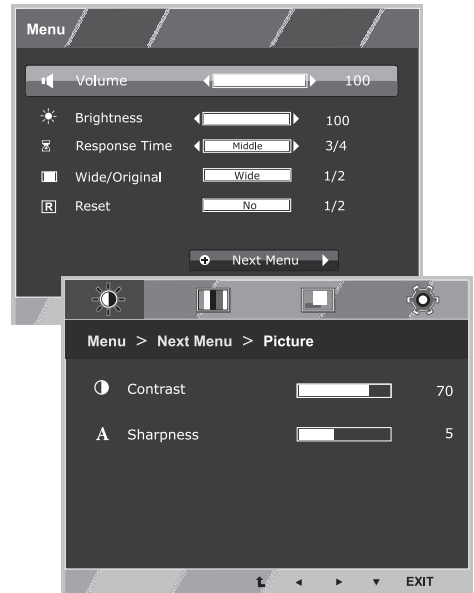

Each option is explained below.

Menu	Analog	Digital	Description
Volume	•	•	To adjust the volume
Brightness	•	•	To adjust the brightness of the screen
Response Time (only for 19MB35PM, 23MB35PM)	•	•	You can set a response time for displayed pictures based on the speed of the screen. For a normal environment, it is recommended that you use 'Off'. For a fast-moving picture, it is recommended that you use 'High'.
Wide/Original (only for 22MB35PM, 23MB35PM)	•	•	Wide
			Switch to full screen mode according to input image signal.
Reset	•	•	Original
			Change the input image signal ratio to original. * This function works only if input resolution is lower than Monitor set ratio (16:9).
Reset	•	•	Restore all factory default settings. Press the ◀ , ▶ buttons to reset immediately.

Menu > Next Menu		Analog	Digital	Description
Picture	Contrast	•	•	To adjust the contrast of the screen
	Sharpness	•	•	To adjust the clearness of the screen
Color	Gamma	•	•	To customize the color of the screen
	Color Temp			
	Six Color (only for 19MB35PM, 23MB35PM)			
	Color Reset (only for 19MB35PM, 23MB35PM)			
Display	Horizontal	•		To adjust the position of the screen
	Vertical			
	Clock	•		To improve the clarity and stability of the screen
	Phase			
Others	Language	•	•	To customize the screen status for a user's operating environment
	Power Indicator			
	Off Time Setting			

- **Analog:** D-SUB(Analog signal) input.
- **Digital:** DVI-D(Digital signal) input.

Picture

- 1 Press **MENU** button on the bottom of the Monitor set to display the **Menu** OSD.
- 2 Select the "**Next Menu**" button to enter the more option settings.
- 3 Enter to **Picture** by pressing the ▼ button.
- 4 Set the options by pressing the ◀ or ▶ or ▼ buttons.
- 5 Select **EXIT** to leave the OSD menu.
To return to the upper menu or set other menu items, use the up arrow (⬆) button.

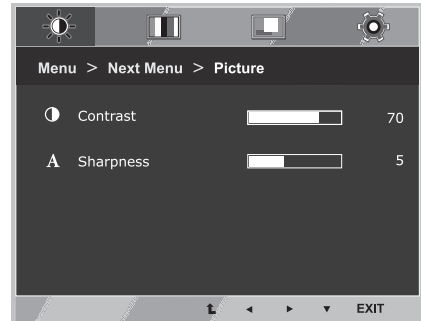

Each option is explained below.

Menu > Next Menu > Picture	Description
Contrast	To adjust the contrast of the screen.
Sharpness	To adjust the clearness of the screen.

Color

- 1 Press **MENU** button on the bottom of the Monitor set to display the **Menu OSD**.
- 2 Select the "**Next Menu**" button to enter the more option settings.
- 3 Select **Color** by pressing the **▶** button.
- 4 Enter to **Color** by pressing the **▼** button.
- 5 Set the options by pressing the **◀** or **▶** or **▼** buttons.
- 6 Select **EXIT** to leave the OSD menu.
To return to the upper menu or set other menu items, use the up arrow (**↑**) button.

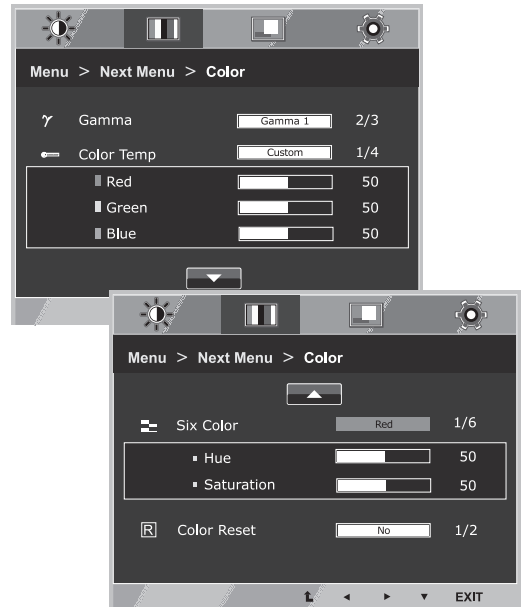

Each option is explained below.

Menu > Next Menu > Color	Description				
Gamma	Set your own gamma value. : Gamma 0, Gamma 1, Gamma 2 on the monitor, high gamma values display whitish images and low gamma values display blackish images.				
Color Temp	<p>Custom</p> <ul style="list-style-type: none"> • Red: Set your own red color levels. • Green: Set your own green color levels. • Blue: Set your own blue color levels. <p>Select the screen color. Warm: Set the screen to warm color temperature (more red). Medium: Set the screen to medium color temperature. Cool: Set the screen to cool color temperature (more blue).</p>				
Six Color (only for 19MB35PM, 23MB35PM)	<p>Sets and stores the hue and saturation for six colors(Red/Green/Blue/Cyan/Magenta/Yellow) to satisfy the color requirements of a user.</p> <table border="1"> <tr> <td>Hue</td> <td>Adjusts the screen hue.</td> </tr> <tr> <td>Saturation</td> <td>Adjusts the color sharpness on the screen. Lower values make the color sharpness weaker and colors lighter while higher values make the color sharpness stronger and colors dark.</td> </tr> </table>	Hue	Adjusts the screen hue.	Saturation	Adjusts the color sharpness on the screen. Lower values make the color sharpness weaker and colors lighter while higher values make the color sharpness stronger and colors dark.
Hue	Adjusts the screen hue.				
Saturation	Adjusts the color sharpness on the screen. Lower values make the color sharpness weaker and colors lighter while higher values make the color sharpness stronger and colors dark.				
Color Reset (only for 19MB35PM, 23MB35PM)	Resets the color settings to the factory default settings for the current input device.				

Display

- 1 Press **MENU** button on the bottom of the Monitor set to display the **Menu OSD**.
- 2 Select the "**Next Menu**" button to enter the more option settings.
- 3 Select **Display** by pressing the ► button.
- 4 Enter to **Display** by pressing the ▼ button.
- 5 Set the options by pressing the ◀ or ▶ or ▼ buttons.
- 6 Select **EXIT** to leave the OSD menu.
To return to the upper menu or set other menu items, use the up arrow (⬆) button.

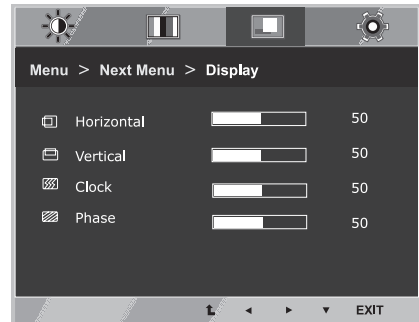

Each option is explained below.

Menu > Next Menu > Display	Description
Horizontal	To move image left and right.
Vertical	To move image up and down.
Clock	To minimize any vertical bars or stripes visible on the screen background. The horizontal screen size will also change.
Phase	To adjust the focus of the display. This item allows you to remove any horizontal noise and clear or sharpen the image of characters.

Others

- 1 Press **MENU** button on the bottom of the Monitor set to display the **Menu** OSD.
- 2 Select the "**Next Menu**" button to enter the more option settings.
- 3 Select **Others** by pressing the **▶** button.
- 4 Enter to **Others** by pressing the **▼** button.
- 5 Set the options by pressing the **◀** or **▶** or **▼** buttons.
- 6 Select **EXIT** to leave the OSD menu.
To return to the upper menu or set other menu items, use the up arrow (**⬆**) button.

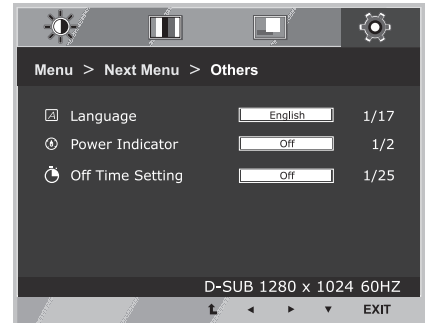

Each option is explained below.

Menu > Next Menu > Others	Description
Language	To choose the language in which the control names are displayed.
Power Indicator	Use this function to set the power indicator on the bottom side of the monitor to On or Off. If you set Off, it will go off. If you set On at any time, the power indicator will automatically be turned on.
Off Time Setting	The monitor set will switch to power off mode after the time to be chosen by user (1 ~ 24 hours)

READER Setting

- 1 Press **READER** button on the bottom of the Monitor set to display the **Reader Mode** OSD.
- 2 Set the options by pressing the ◀ buttons.

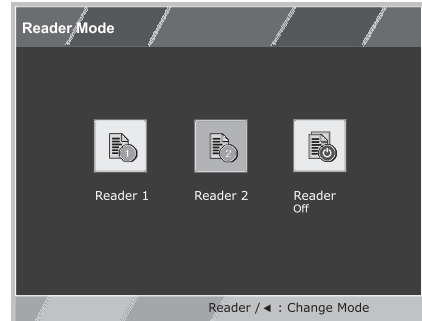

Each option is explained below.

Reader Mode	Description
Reader 1	It is a mode that the screen is adjusted to the best for the newspaper. If you want screen more bright, you can control brightness in Menu OSD.
Reader 2	It is a mode that the screen is adjusted to the best for the cartoon. If you want screen more bright, you can control brightness in Menu OSD.
Reader Off	It is a mode that reader mode is off.

! NOTE

If option of Reader Mode is Reader 1 or Reader 2, Picture Mode will automatically be Custom and Super Energy Saving will automatically be Off.

SUPER ENERGY SAVING

- 1 Press  button on the bottom of the Monitor set to display the **SUPER ENERGY SAVING** OSD.
- 2 Set the options by pressing the **▶** buttons.

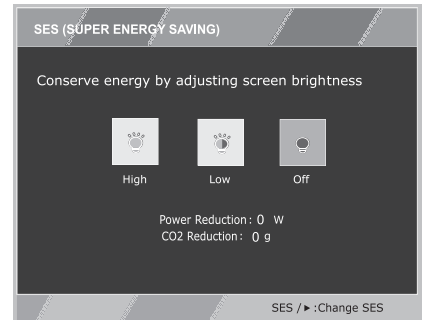

Each option is explained below.

SUPER ENERGY SAVING	Description
High	Enables SUPER ENERGY SAVING you can save energy with this energy- high efficient function.
Low	Enables SUPER ENERGY SAVING you can save energy with this energy- low efficient function.
Off	Disables SUPER ENERGY SAVING.

NOTE

- **TOTAL POWER REDUCTION:** How much power is saved while using the monitor.
- **TOTAL CO2 REDUCTION:** Change the TOTAL POWER REDUCTION to CO2.
- **SAVING DATA(W/h)**

	482 mm (19 inch)	546 mm (21.5 inch)	584 mm (23 inch)
SUPER SAVING (High)	3 W/h	4 W/h	4 W/h
SUPER SAVING (Low)	1 W/h	2 W/h	2 W/h

- Saving Data depends on the Panel. So,those values should be different from each panel and panel vendor.If option of Super Energy Saving is High or Low, monitor luminance become higher or lower depend on source.
- LG calculated these values by using **“broadcast video signal”** (including broadcast video: IEC 62087)
- SUPER SAVING refers to how much power can be saved using the SUPER ENERGY SAVING function.
- If option of Super Energy Saving is High or Low, Picture Mode will automatically be Custom and Reader Mode will automatically be Reader Off.

TROUBLESHOOTING

Check the following before calling for service.

No image appears	
Is the power cord of the display connected?	<ul style="list-style-type: none"> Check and see if the power cord is connected properly to the power outlet.
Is the power indicator light on?	<ul style="list-style-type: none"> Press the Power button.
Is the power on and the power indicator White?	<ul style="list-style-type: none"> Adjust the brightness and the contrast.
Is the power indicator flickering?	<ul style="list-style-type: none"> If the display is in power saving mode, try moving the mouse or pressing any key on the keyboard to bring up the screen. Try to turn on the PC.
Do you see an "OUT OF RANGE" message on the screen?	<ul style="list-style-type: none"> This message appears when the signal from the PC (video card) is out of horizontal or vertical frequency range of the display. See the 'Specifications' section of this manual and configure your display again.
Do you see a "NO SIGNAL" message on the screen?	<ul style="list-style-type: none"> When the monitor is on "No-Signal" in 5 minutes, the monitor goes to DPM mode.

Do you see a "OSD LOCKED" message on the screen?	
Do you see "OSD LOCKED" when you push MENU button?	<ul style="list-style-type: none"> You can secure the current control settings, so that they cannot be inadvertently changed. You can unlock the OSD controls at any time by pushing the MENU button for several seconds: the message "OSD UNLOCKED" will appear.

Display image is incorrect	
Display Position is incorrect.	<ul style="list-style-type: none"> Press the AUTO button to automatically adjust your display image to the ideal setting.
On the screen background, vertical bars or stripes are visible.	<ul style="list-style-type: none"> Press the AUTO button to automatically adjust your display image to the ideal setting.
Any horizontal noise appearing in any image or characters are not clearly portrayed.	<ul style="list-style-type: none"> Press the AUTO button to automatically adjust your display image to the ideal setting. Check Control Panel ► Display ► Settings and adjust the display to the recommended resolution or adjust the display image to the ideal setting. Set the color setting higher than 24 bits (true color).



CAUTION

- Check **Control Panel ► Display ► Settings** and see if the frequency or the resolution were changed. If yes, readjust the video card to the recommend resolution.
- If the recommended resolution (optimal resolution) is not selected, letters may be blurred and the screen may be dimmed, truncated or biased. Make sure to select the recommend resolution.
- The setting method can differ by computer and O/S (Operation System), and resolution mentioned above may not be supported by the video card performance. In this case, please ask to the computer or the video card manufacturer.

Display image is incorrect	
The screen color is mono or abnormal.	<ul style="list-style-type: none"> • Check if the signal cable is properly connected and use a screwdriver to fasten if necessary. • Make sure the video card is properly inserted in the slot. • Set the color setting higher than 24 bits (true color) at Control Panel ► Settings.
The screen blinks.	<ul style="list-style-type: none"> • Check if the screen is set to interlace mode and if yes, change it to the recommend resolution.

Do you see an "Unrecognized monitor, Plug&Play (VESA DDC) monitor found" message?	
Have you installed the display driver?	<ul style="list-style-type: none"> • Be sure to install the display driver from the display driver CD (or diskette) that comes with your display. Or, you can also download the driver from our web site: http://www.lg.com. • Make sure to check if the video card supports Plug&Play function.

SPECIFICATIONS

19MB35PM

Display	Screen Type	TFT (Thin Film Transistor) LCD (Liquid Crystal Display) Panel, Anti-Glare coating 48.2 cm visible diagonal (19 inch)
	Pixel Pitch	0.294 mm x 0.294 mm (Pixel Pitch)
Sync Input	Horizontal Frequency	30 kHz to 83 kHz (Automatic)
	Vertical Frequency	56Hz to 75Hz (D-SUB, DVI-D)
	Input Form	Separate Sync. Digital
Video Input	Signal Input	15 pin D-SUB Connector / DVI-D Connector (Digital)
	Input Form	RGB Analog (0.7 Vp-p/ 75 ohm), Digital
Resolution	Max	D-SUB(Analog) : 1280 x 1024 @ 60 Hz DVI (Digital) : 1280 x 1024 @ 60 Hz
	Recommend	VESA 1280 x 1024 @ 60 Hz
Plug & Play	DDC 2B(Analog, Digital)	
Power Consumption	On Mode : 15 W (ENERGY STAR® standard)* Sleep Mode ≤ 0.3 W Off Mode ≤ 0.3 W	
Power Input	AC 100-240V ~ 50/60Hz 0.8 A	
Speaker Wattage	1 W +1 W	
Dimensions (Width x Height x Depth)	With Stand	40.9 cm x 48.1 cm x 21.0 cm
	Without Stand	40.9 cm x 33.8 cm x 5.8 cm
Weight	3.8 kg	
Tilt Range	-5° to 20°	
Environmental conditions	Operating Temperature	10°C to 35 °C
	Operating Humidity	10 % to 80 %
	Storage Temperature	-20°C to 60 °C
	Storage Humidity	5 % to 90 % non-Condensing
Stand Base	Attached (), Detached (O)	
Power cord	Wall-outlet type	

Product specifications shown above may be changed without prior notice due to upgrade of product functions.

* The power consumption level can be different by operating condition and monitor setting.

* The On mode power consumption is measured with ENERGY STAR® test standard.

* ENERGY STAR® is a US registered mark of the United States Environmental Protection Agency.

SPECIFICATIONS

22MB35PM

Display	Screen Type	TFT (Thin Film Transistor) LCD (Liquid Crystal Display) Panel, Anti-Glare coating 54.6 cm visible diagonal (21.5 inch)
	Pixel Pitch	0.248 mm x 0.248 mm (Pixel Pitch)
Sync Input	Horizontal Frequency	30 kHz to 83 kHz (Automatic)
	Vertical Frequency	56Hz to 75Hz (D-SUB, DVI-D)
	Input Form	Separate Sync. Digital
Video Input	Signal Input	15 pin D-SUB Connector / DVI-D Connector (Digital)
	Input Form	RGB Analog (0.7 Vp-p/ 75 ohm), Digital
Resolution	Max	D-SUB(Analog) : 1920 x 1080 @ 60 Hz DVI (Digital) : 1920 x 1080 @ 60 Hz
	Recommend	VESA 1920 x 1080 @ 60 Hz
Plug & Play	DDC 2B(Analog, Digital)	
Power Consumption	On Mode : 20 W (ENERGY STAR® standard)* Sleep Mode ≤ 0.3 W Off Mode ≤ 0.3 W	
Power Input	AC 100-240V ~ 50/60Hz 1.0 A	
Speaker Wattage	1 W +1 W	
Dimensions (Width x Height x Depth)	With Stand	50.9 cm x 35.3 cm x 22.4 cm
	Without Stand	50.9 cm x 30.4 cm x 14.4 cm
Weight	3.9 kg	
Tilt Range	-5° to 20°	
Environmental conditions	Operating Temperature	10°C to 35 °C
	Operating Humidity	10 % to 80 %
	Storage Temperature	-20°C to 60 °C
	Storage Humidity	5 % to 90 % non-Condensing
Stand Base	Attached (), Detached (O)	
Power cord	Wall-outlet type	

Product specifications shown above may be changed without prior notice due to upgrade of product functions.

- * The power consumption level can be different by operating condition and monitor setting.
- * The On mode power consumption is measured with ENERGY STAR® test standard.
- * ENERGY STAR® is a US registered mark of the United States Environmental Protection Agency.

SPECIFICATIONS

23MB35PM

Display	Screen Type	TFT (Thin Film Transistor) LCD (Liquid Crystal Display) Panel, Anti-Glare coating 58.4 cm visible diagonal (23 inch)
	Pixel Pitch	0.2652 mm x 0.2652 mm (Pixel Pitch)
Sync Input	Horizontal Frequency	30 kHz to 83 kHz (Automatic)
	Vertical Frequency	56Hz to 75Hz (D-SUB, DVI-D)
	Input Form	Separate Sync. Digital
Video Input	Signal Input	15 pin D-SUB Connector / DVI-D Connector (Digital)
	Input Form	RGB Analog (0.7 Vp-p/ 75 ohm), Digital
Resolution	Max	D-SUB(Analog) : 1920 x 1080 @ 60 Hz DVI (Digital) : 1920 x 1080 @ 60 Hz
	Recommend	VESA 1920 x 1080 @ 60 Hz
Plug & Play	DDC 2B(Analog, Digital)	
Power Consumption	On Mode : 21 W (ENERGY STAR® standard)* Sleep Mode ≤ 0.3 W Off Mode ≤ 0.3 W	
Power Input	AC 100-240V ~ 50/60Hz 1.0 A	
Speaker Wattage	1 W +1 W	
Dimensions (Width x Height x Depth)	With Stand	54.8 cm x 36.7 cm x 24.6 cm
	Without Stand	54.8 cm x 33.5 cm x 16.6 cm
Weight	4.5 kg	
Tilt Range	-5° to 20°	
Environmental conditions	Operating Temperature	10°C to 35 °C
	Operating Humidity	10 % to 80 %
	Storage Temperature	-20°C to 60 °C
	Storage Humidity	5 % to 90 % non-Condensing
Stand Base	Attached (), Detached (O)	
Power cord	Wall-outlet type	

Product specifications shown above may be changed without prior notice due to upgrade of product functions.

* The power consumption level can be different by operating condition and monitor setting.

* The On mode power consumption is measured with ENERGY STAR® test standard.

* ENERGY STAR® is a US registered mark of the United States Environmental Protection Agency.

Preset Modes (Resolution)

19MB35PM

Display Modes (Resolution)	Horizontal Frequency(kHz)	Vertical Frequency(Hz)	Polarity(H/V)	
720 x 400	31.468	70	-/+	
640 x 480	31.469	60	-/-	
640 x 480	37.500	75	-/-	
800 x 600	37.879	60	+/+	
800 x 600	46.875	75	+/+	
1024 x 768	48.363	60	-/-	
1024 x 768	60.023	75	-/-	
1152 x 864	67.500	75	+/+	
1280 x 1024	63.981	60	+/+	
1280 x 1024	79.976	75	+/+	Recommend Mode

22MB35PM

23MB35PM

Display Modes (Resolution)	Horizontal Frequency(kHz)	Vertical Frequency(Hz)	Polarity(H/V)	
720 x 400	31.468	70	-/+	
640 x 480	31.469	60	-/-	
640 x 480	37.500	75	-/-	
800 x 600	37.879	60	+/+	
800 x 600	46.875	75	+/+	
1024 x 768	48.363	60	-/-	
1024 x 768	60.023	75	+/+	
1152 x 864	67.500	75	+/+	
1280 x 1024	63.981	60	+/+	
1280 x 1024	79.976	75	+/+	
1680 x 1050	65.290	60	-/+	
1920 x 1080	67.500	60	+/+	Recommend Mode

Indicator

Mode	LED Color
On Mode	White
Sleep Mode	Blinking White
Off Mode	Off

PROPER POSTURE

Proper posture for using the Monitor set.

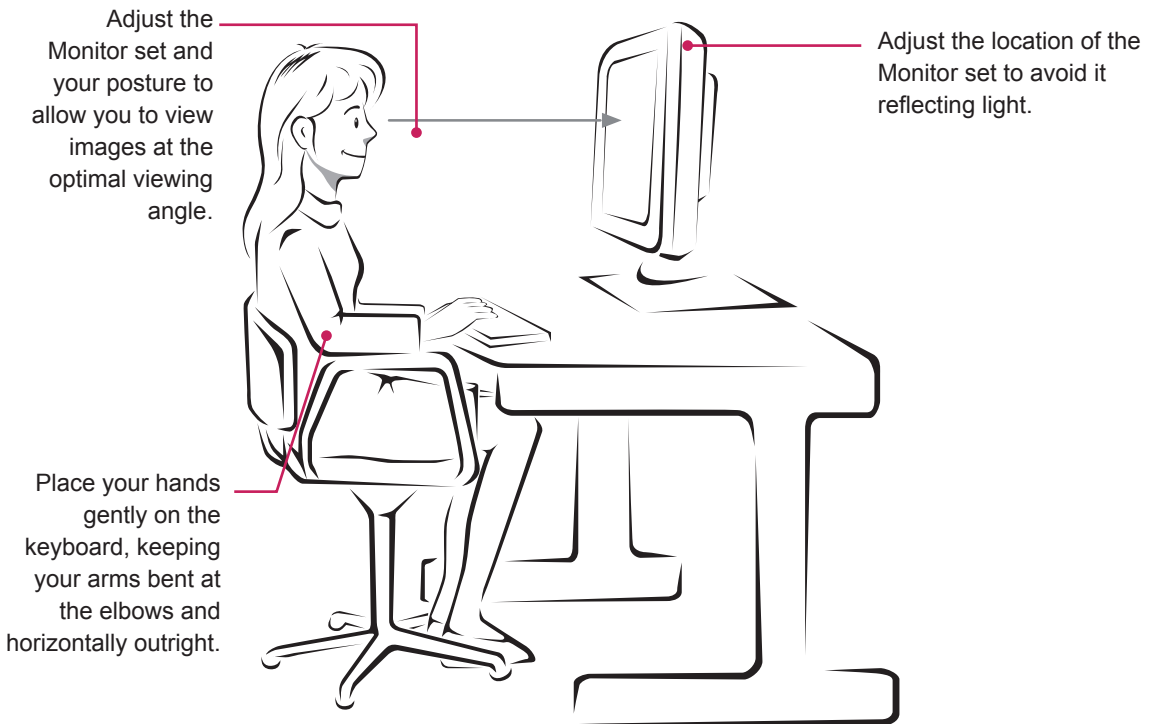



Declaration of Conformity

Trade Name: LG

Model : 19MB35PMF,22MB35PMF,23MB35PMF

Responsible Party: LG Electronics Inc.

Address : 1000 Sylvan Ave. Englewood Cliffs
NJ 07632 U.S.A

TEL: 201-266-2534

*above information is only for USA FCC Regulatory

Make sure to read the Safety Precautions before using the product.

Keep the Owner's Manual (CD) in an accessible place for future reference.

The model and serial number of the SET is located on the back and one side of the SET.

Record it below should you ever need service.

MODEL _____

SERIAL _____

ENERGY STAR is a set of power-saving guidelines issued by the U.S.Environmental Protection Agency(EPA).



As an ENERGY STAR Partner LGE U. S. A.,Inc. has determined that this product meets the ENERGY STAR guidelines for energy efficiency.

Free Manuals Download Website

<http://myh66.com>

<http://usermanuals.us>

<http://www.somanuals.com>

<http://www.4manuals.cc>

<http://www.manual-lib.com>

<http://www.404manual.com>

<http://www.luxmanual.com>

<http://aubethermostatmanual.com>

Golf course search by state

<http://golfingnear.com>

Email search by domain

<http://emailbydomain.com>

Auto manuals search

<http://auto.somanuals.com>

TV manuals search

<http://tv.somanuals.com>