

ThinkPad

User Guide

ThinkPad Edge E425 and E525

Notes: Before using this information and the product it supports, be sure to read the following:

- *Safety and Warranty Guide*
- *Regulatory Notice*
- “Important safety information” on page vi
- Appendix C “Notices” on page 147

The *Safety and Warranty Guide* and the *Regulatory Notice* have been uploaded to the Web site. To refer to them, go to <http://www.lenovo.com/support>, and then click **User Guides & Manuals**.

Second Edition (October 2011)

© Copyright Lenovo 2011.

LIMITED AND RESTRICTED RIGHTS NOTICE: If data or software is delivered pursuant a General Services Administration “GSA” contract, use, reproduction, or disclosure is subject to restrictions set forth in Contract No. GS-35F-05925.

Contents

Read this first **v**

Important safety information	vi
Conditions that require immediate action	vii
Safety guidelines	vii

Chapter 1. Product Overview **1**

Locating computer controls, connectors, and indicators.	1
Front view.	2
Right-side view.	6
Left-side view	7
Bottom view	9
Rear view	10
Status indicators	11
Locating important product information	13
Machine type and model label.	13
FCC ID and IC Certification number label	14
Certificate of Authenticity label	15
Features	15
ThinkPad Edge E425 features	15
ThinkPad Edge E525 features	16
Specifications	18
Operating environment	18
ThinkVantage Technologies and software	19
Accessing applications	19
Access Connections	21
Active Protection System.	21
Fingerprint Software.	21
Lenovo Solutions Center	21
Lenovo ThinkVantage Tools	22
Lenovo ThinkVantage Toolbox.	22
Message Center Plus	22
Password Manager	22
Power Manager	22
Product Recovery	23
Rescue and Recovery	23
System Update	23
ThinkVantage GPS	23

Chapter 2. Using your computer **25**

Registering your computer	25
Frequently asked questions	25
Special keys and buttons	26
ThinkPad Edge E425 special keys	27
Thinkpad Edge E525 special keys	29
Using the UltraNav pointing device.	31
Using the TrackPoint pointing device	31

Using the touch pad.	33
Using the UltraNav pointing device and an external mouse	34
Adding the UltraNav icon in the Windows notification area	34
Power management	34
Checking battery status	35
Using the ac power adapter.	35
Charging the battery	35
Maximizing battery life	36
Managing your battery power	36
Power-saving modes	36
Handling the battery.	37
Connecting to the network	39
Ethernet connections	39
Wireless connections	39
Using a projector or an external display	42
Changing display settings	42
Connecting a projector or an external display	42
Using dual displays	43
Using audio features	44
Using an integrated camera	45
Using the optical drive	46
Using a flash media Card	46
Inserting a flash media card.	46
Removing a flash media card	47

Chapter 3. You and your computer **49**

Accessibility and comfort	49
Ergonomic information.	49
Adjusting your computer to fit you	50
Accessibility information	51
Traveling with your computer	51
Travel tips.	51
Travel accessories	52

Chapter 4. Security **53**

Attaching a mechanical lock	53
Using passwords.	53
Passwords and sleep mode.	53
Typing passwords	54
Power-on password.	54
Hard disk passwords	55
Supervisor password	56
Hard disk security	58
Using a fingerprint reader	58

Notice on deleting data from your hard disk drive	60
Using firewalls	61
Protecting data against viruses	61

Chapter 5. Recovery overview 63

Creating and using recovery media	63
Creating recovery media	64
Using recovery media	64
Performing backup and recovery operations	64
Performing a backup operation	65
Performing a recovery operation	65
Using the Rescue and Recovery workspace	65
Creating and using a rescue medium	66
Creating a rescue medium	66
Using a rescue medium	66
Reinstalling preinstalled applications and device drivers	67
Solving recovery problems	68

Chapter 6. Replacing devices 69

Static electricity prevention	69
Replacing the battery	69
Replacing the hard disk drive	71
Replacing the optical drive	74
ThinkPad Edge E425	74
ThinkPad Edge E525	77
Replacing a PCI Express Mini Card for wireless LAN connection	78
Replacing a memory module	81
Replacing the keyboard	84
ThinkPad Edge E425	84
ThinkPad Edge E525	88

Chapter 7. Advanced configuration 93

Installing a new operating system	93
Before you begin	93
Installing Windows 7 operating system	94
Installing device drivers	95
Installing the driver for the 4-in-1 media card reader	95
Installing Intel Chipset Support for Windows 2000/XP/Vista/7	95
Installing drivers and software	95
ThinkPad Setup	95
Config menu	96
Date/Time menu	97
Security menu	97
Startup menu	98
Restart menu	99
ThinkPad Setup items	99
Updating your system UEFI BIOS	105

Chapter 8. Preventing problems 107

General tips for preventing problems	107
Making sure device drivers are current	108
Getting the latest drivers from the Web site	108
Getting the latest drivers using System Update	108
Taking care of your computer	108
Cleaning the cover of your computer	110

Chapter 9. Troubleshooting computer problems 113

Diagnosing problems	113
Troubleshooting	114
Computer stops responding	114
Spills on the keyboard	115
Error messages	115
Errors without messages	119
Beep errors	120
Memory module problems	120
Networking problems	120
Problems with the keyboard and other pointing devices	122
Display and multimedia devices	122
Fingerprint reader problems	127
Battery and power problems	127
Problems with drives and other storage devices	130
Software problems	132
Problems with ports and connectors	132

Chapter 10. Getting support 133

Before you contact Lenovo	133
Registering your computer	133
Downloading system updates	133
Recording information	133
Getting help and service	134
Using diagnostic programs	134
Lenovo Support Web site	134
Calling Lenovo	135
Finding ThinkPad options	135
Purchasing additional services	136

Appendix A. Regulatory information 137

Wireless related information	137
Location of the UltraConnect wireless antennas	138
Locating wireless regulatory notices	139
Export classification notice	139
Electronic emission notices	139
Federal Communications Commission Declaration of Conformity	139

Industry Canada Class B emission compliance statement	139
European Union - Compliance to the Electromagnetic Compatibility Directive . . .	140
German Class B compliance statement . . .	140
Korea Class B compliance statement . . .	140
Japan VCCI Class B compliance statement . .	141
Japan compliance statement for products which connect to the power mains with rated current less than or equal to 20 A per phase	141
Lenovo product service information for Taiwan	141
Additional regulatory information	141

Appendix B. WEEE and recycling statements 143

EU WEEE statements	143
China WEEE statement	143
Japan recycling statements	143
Recycling information for Brazil	144
Battery recycling information for Taiwan.	145
Battery recycling information for the United States and Canada.	145
Battery recycling information for the European Union	145

Appendix C. Notices. 147
 Trademarks 148

Read this first

Be sure to follow the important tips given here to continue to get the most use and enjoyment out of your computer. Failure to do so might lead to discomfort or injury, or cause your computer to fail.

Protect yourself from the heat that your computer generates.



When your computer is turned on or the battery is charging, the base, the palm rest, and some other parts may become hot. The temperature they reach depends on the amount of system activity and the level of charge in the battery.

Extended contact with your body, even through clothing, could cause discomfort or even a skin burn.

- Avoid keeping your hands, your lap, or any other part of your body in contact with a hot section of the computer for any extended time.
- Periodically take hands from using the keyboard by lifting your hands from the palm rest.

Protect yourself from the heat generated by the ac power adapter.



When the ac power adapter is connected to an electrical outlet and your computer, it generates heat.

Extended contact with your body, even through clothing, may cause a skin burn.

- Do not place the ac power adapter in contact with any part of your body while it is in use.
- Never use it to warm your body.

Prevent your computer from getting wet.



To avoid spills and the danger of electrical shock, keep liquids away from your computer.

Protect the cables from being damaged.

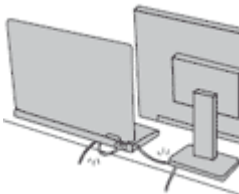

Applying strong force to cables may damage or break them.

Route communication lines, or the cables of an ac power adapter, a mouse, a keyboard, a printer, or any other electronic device, so that they cannot be walked on, tripped over, pinched by your computer or other objects, or in any way subjected to treatment that could interfere with the operation of your computer.

Protect your computer and data when moving it.



Before moving a computer equipped with a hard disk drive, do one of the following, and make sure that the power switch is off or is blinking:

- Turn it off.
- Put it in sleep mode.
- Press it in hibernation mode.

This will help to prevent damage to the computer, and possible loss of data.

Handle your computer gently.



Do not drop, bump, scratch, twist, hit, vibrate, push, or place heavy objects on your computer, display, or external devices.

Carry your computer carefully.



- Use a quality carrying case that provides adequate cushioning and protection.
- Do not pack your computer in a tightly packed suitcase or bag.
- Before putting your computer in a carrying case, make sure that it is off, in sleep mode, or in hibernation mode. Do not put a computer in a carrying case while it is turned on.

Important safety information

Note: Read important safety information first.

This information can help you safely use your notebook computer. Follow and retain all information included with your computer. The information in this document does not alter the terms of your purchase agreement or the Lenovo® Limited Warranty. For more information, see “Warranty Information” in the *Safety and Warranty Guide* that comes with your computer.

Customer safety is important. Our products are developed to be safe and effective. However, personal computers are electronic devices. Power cords, power adapters, and other features can create potential safety risks that can result in physical injury or property damage, especially if misused. To reduce these risks, follow the instructions included with your product, observe all warnings on the product and in the operating instructions, and review the information included in this document carefully. By carefully following the information contained in this document and provided with your product, you can help protect yourself from hazards and create a safer computer work environment.

Note: This information includes references to power adapters and batteries. In addition to notebook computers, some products (such as speakers and monitors) ship with external power adapters. If you have such a product, this information applies to your product. In addition, computer products contain a coin-sized internal battery that provides power to the system clock even when the computer is unplugged, so the battery safety information applies to all computer products.

Conditions that require immediate action

Products can become damaged due to misuse or neglect. Some product damage is serious enough that the product should not be used again until it has been inspected and, if necessary, repaired by an authorized servicer.

As with any electronic device, pay close attention to the product when it is turned on. On very rare occasions, you might notice an odor or see a puff of smoke or sparks vent from your product. Or you might hear sounds like popping, cracking or hissing. These conditions might merely mean that an internal electronic component has failed in a safe and controlled manner. Or, they might indicate a potential safety issue. However, do not take risks or attempt to diagnose the situation yourself. Contact the Customer Support Center for further guidance. For a list of Service and Support phone numbers, see the following Web site:
<http://www.lenovo.com/support/phone>

Frequently inspect your computer and its components for damage or wear or signs of danger. If you have any question about the condition of a component, do not use the product. Contact the Customer Support Center or the product manufacturer for instructions on how to inspect the product and have it repaired, if necessary.

In the unlikely event that you notice any of the following conditions, or if you have any safety concerns with your product, stop using the product and unplug it from the power source and telecommunication lines until you can speak to the Customer Support Center for further guidance.

- Power cords, plugs, power adapters, extension cords, surge protectors, or power supplies that are cracked, broken, or damaged.
- Signs of overheating, smoke, sparks, or fire.
- Damage to a battery (such as cracks, dents, or creases), discharge from a battery, or a buildup of foreign substances on the battery.
- A cracking, hissing or popping sound, or strong odor that comes from the product.
- Signs that liquid has been spilled or an object has fallen onto the computer product, the power cord or power adapter.
- The computer product, power cord, or power adapter has been exposed to water.
- The product has been dropped or damaged in any way.
- The product does not operate normally when you follow the operating instructions.

Note: If you notice these conditions with a product (such as an extension cord) that is not manufactured for or by Lenovo, stop using that product until you can contact the product manufacturer for further instructions, or until you get a suitable replacement.

Safety guidelines

Always observe the following precautions to reduce the risk of injury and property damage.

For more information, see “Important safety information” in the *Safety and Warranty Guide* that comes with your computer.

Service and upgrades

Do not attempt to service a product yourself unless instructed to do so by the Customer Support Center or your documentation. Only use a Service Provider who is approved to repair your particular product.

Note: Some computer parts can be upgraded or replaced by the customer. Upgrades typically are referred to as options. Replacement parts approved for customer installation are referred to as Customer Replaceable Units, or CRUs. Lenovo provides documentation with instructions when it is appropriate for

customers to install options or replace CRUs. You must closely follow all instructions when installing or replacing parts. The Off state of a power indicator does not necessarily mean that voltage levels inside a product are zero. Before you remove the covers from a product equipped with a power cord, always make sure that the power is turned off and that the product is unplugged from any power source. If you have any questions or concerns, contact the Customer Support Center.

Although there are no moving parts in your computer after the power cord has been disconnected, the following warnings are required for your safety.

CAUTION:

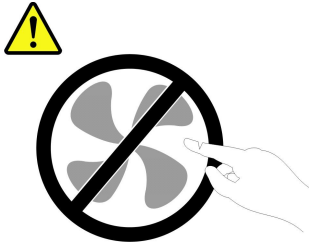

Hazardous moving parts. Keep fingers and other body parts away.

CAUTION:



Before replacing any CRUs, turn off the computer and wait three to five minutes to let the computer cool before opening the cover.

Power cords and power adapters



DANGER

Use only the power cords and power adapters supplied by the product manufacturer.

The power cords shall be safety approved. For Germany, it shall be H05VV-F, 3G, 0.75 mm², or better. For other countries, the suitable types shall be used accordingly.

Never wrap a power cord around a power adapter or other object. Doing so can stress the cord in ways that can cause the cord to fray, crack, or crimp. This can present a safety hazard.

Always route power cords so that they will not be walked on, tripped over, or pinched by objects.

Protect power cords and power adapters from liquids. For instance, do not leave your power cord or power adapter near sinks, tubs, toilets, or on floors that are cleaned with liquid cleansers. Liquids can cause a short circuit, particularly if the power cord or power adapter has been stressed by misuse. Liquids also can cause gradual corrosion of power cord terminals and/or the connector terminals on a power adapter, which can eventually result in overheating.

Always connect power cords and signal cables in the correct order and ensure that all power cord connectors are securely and completely plugged into receptacles.

Do not use any power adapter that shows corrosion at the ac input pins or shows signs of overheating (such as deformed plastic) at the ac input pins or anywhere on the power adapter.

Do not use any power cords where the electrical contacts on either end show signs of corrosion or overheating or where the power cord appears to have been damaged in any way.

Extension cords and related devices

Ensure that extension cords, surge protectors, uninterruptible power supplies, and power strips that you use are rated to handle the electrical requirements of the product. Never overload these devices. If power strips are used, the load should not exceed the power strip input rating. Consult an electrician for more information if you have questions about power loads, power requirements, and input ratings.

Plugs and outlets



If a receptacle (power outlet) that you intend to use with your computer equipment appears to be damaged or corroded, do not use the outlet until it is replaced by a qualified electrician.

Do not bend or modify the plug. If the plug is damaged, contact the manufacturer to obtain a replacement.

Do not share an electrical outlet with other home or commercial appliances that draw large amounts of electricity; otherwise, unstable voltage might damage your computer, data, or attached devices.

Some products are equipped with a three-pronged plug. This plug fits only into a grounded electrical outlet. This is a safety feature. Do not defeat this safety feature by trying to insert it into a non-grounded outlet. If you cannot insert the plug into the outlet, contact an electrician for an approved outlet adapter or to replace the outlet with one that enables this safety feature. Never overload an electrical outlet. The overall system load should not exceed 80 percent of the branch circuit rating. Consult an electrician for more information if you have questions about power loads and branch circuit ratings.

Be sure that the power outlet you are using is properly wired, easily accessible, and located close to the equipment. Do not fully extend power cords in a way that will stress the cords.

Be sure that the power outlet provides the correct voltage and current for the product you are installing.

Carefully connect and disconnect the equipment from the electrical outlet.

Power supply statement



Never remove the cover on a power supply or any part that has the following label attached.

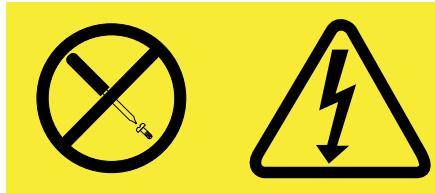

Hazardous voltage, current, and energy levels are present inside any component that has this label attached. There are no serviceable parts inside these components. If you suspect a problem with one of these parts, contact a service technician.

External devices

CAUTION:

Do not connect or disconnect any external device cables other than Universal Serial Bus (USB) cables while the computer power is on; otherwise, you might damage your computer. To avoid possible damage to attached devices, wait at least five seconds after the computer is shut down to disconnect external devices.

General battery notices



DANGER

Personal computers manufactured by Lenovo contain a coin cell battery to provide power to the system clock. In addition, many mobile products, such as notebook computers, utilize a rechargeable battery pack to provide system power when in portable mode. Batteries supplied by Lenovo for use with your product have been tested for compatibility and should only be replaced with approved parts.

Never attempt to open or service any battery. Do not crush, puncture, or incinerate batteries or short circuit the metal contacts. Do not expose the battery to water or other liquids. Only recharge the battery pack strictly according to instructions included in the product documentation.

Battery abuse or mishandling can cause the battery to overheat, which can cause gasses or flame to “vent” from the battery pack or coin cell. If your battery is damaged, or if you notice any discharge from your battery or the buildup of foreign materials on the battery leads, stop using the battery and obtain a replacement from the battery manufacturer.

Batteries can degrade when they are left unused for long periods of time. For some rechargeable batteries (particularly Lithium Ion batteries), leaving a battery unused in a discharged state could increase the risk of a battery short circuit, which could shorten the life of the battery and can also pose a safety hazard. Do not let rechargeable Lithium-Ion batteries completely discharge or store these batteries in a discharged state.

Rechargeable battery notice



DANGER

Do not attempt to disassemble or modify the battery pack. Attempting to do so can cause an explosion, or liquid leakage from the battery pack. A battery pack other than the one specified by Lenovo, or a disassembled or modified battery pack is not covered by the warranty.

If the rechargeable battery pack is incorrectly replaced, there is danger of an explosion. The battery pack contains a small amount of harmful substances. To avoid possible injury:

- Replace only with a battery of the type recommended by Lenovo.
- Keep the battery pack away from fire.
- Do not expose it to water or rain.
- Do not attempt to disassemble it.
- Do not short-circuit it.
- Keep it away from children.
- Do not drop the battery pack.

Do not put the battery pack in trash that is disposed of in landfills. When disposing of the battery, comply with local ordinances or regulations.

The battery pack should be stored at room temperature, charged to approximately 30 to 50% of capacity. We recommend that battery pack be charged about once per year to prevent overdischarge.

Lithium coin cell battery notice



DANGER

Danger of explosion if battery is incorrectly replaced.

When replacing the lithium coin cell battery, use only the same or an equivalent type that is recommended by the manufacturer. The battery contains lithium and can explode if not properly used, handled, or disposed of.

Do not:

- **Throw or immerse into water**
- **Heat to more than 100°C (212°F)**
- **Repair or disassemble**

Dispose of the battery as required by local ordinances or regulations.

The following statement applies to users in the state of California, U.S.A.

California Perchlorate Information:

Products containing CR (manganese dioxide) lithium coin cell batteries may contain perchlorate.

**Perchlorate Material - special handling may apply, See
<http://www.dtsc.ca.gov/hazardouswaste/perchlorate>**

Heat and product ventilation



DANGER

Computers, ac power adapters, and many accessories can generate heat when turned on and when batteries are charging. Notebook computers can generate a significant amount of heat due to their compact size. Always follow these basic precautions:

- When your computer is turned on or the battery is charging, the base, the palm rest, and some other parts may become hot. Avoid keeping your hands, your lap, or any other part of your body in contact with a hot section of the computer for any extended length of time. When you use the keyboard, avoid keeping your palms on the palm rest for a prolonged period of time. Your computer generates some heat during normal operation. The amount of heat depends on the amount of system activity and the battery charge level. Extended contact with your body, even through clothing, could cause discomfort or even a skin burn. Periodically take breaks from using the keyboard by lifting your hands from the palm rest; and be careful not to use the keyboard for any extended length of time.
- Do not operate your computer or charge the battery near flammable materials or in explosive environments.
- Ventilation slots, fans and/or heat sinks are provided with the product for safety, comfort, and reliable operation. These features might inadvertently become blocked by placing the product on a bed, sofa, carpet, or other flexible surface. Never block, cover, or disable these features.
- When the ac power adapter is connected to an electrical outlet and your computer, it generates heat. Do not place the adapter in contact with any part of your body while using it. Never use the ac power adapter to warm your body. Extended contact with your body, even through clothing, may cause a skin burn.

For your safety, always follow these basic precautions with your computer:

- Keep the cover closed whenever the computer is plugged in.
- Regularly inspect the outside of the computer for dust accumulation.
- Remove dust from vents and any perforations in the bezel. More frequent cleanings might be required for computers in dusty or high-traffic areas.
- Do not restrict or block any ventilation openings.
- Do not operate your computer inside furniture, as this might increase the risk of overheating.
- Airflow temperatures into the computer should not exceed 35°C (95°F).

Electrical current safety information



DANGER

Electric current from power, telephone, and communication cables is hazardous.

To avoid a shock hazard:

- Do not use your computer during a lightning storm.
- Do not connect or disconnect any cables or perform installation, maintenance, or reconfiguration of this product during an electrical storm.
- Connect all power cords to a properly wired and grounded electrical outlet.
- Connect to properly wired outlets any equipment that will be attached to this product.
- Whenever possible, use one hand only to connect or disconnect signal cables.
- Never turn on any equipment when there is evidence of fire, water, or structural damage.
- Disconnect the attached power cords, battery pack, and all the cables before you open the device covers, unless instructed otherwise in the installation and configuration procedures.
- Do not use you computer until all internal parts enclosures are fastened into place. Never use the computer when internal parts and circuits are exposed.



DANGER

Connect and disconnect cables as described in the following procedures when installing, moving, or opening covers on this product or attached devices.

To connect:

1. Turn everything OFF.
2. First, attach all cables to devices.
3. Attach signal cables to connectors.
4. Attach power cords to outlets.
5. Turn devices ON.

To disconnect:

1. Turn everything OFF.
2. First, remove power cords from outlets.
3. Remove signal cables from connectors.
4. Remove all cables from devices.

The power cord must be disconnected from the wall outlet or receptacle before installing all other electrical cables connected to the computer.

The power cord may be reconnected to the wall outlet or receptacle only after all other electrical cables have been connected to the computer.

Laser compliance statement



CAUTION:

When laser products (such as CD-ROMs, DVD drives, fiber optic devices, or transmitters) are installed, note the following:

- Do not remove the covers. Removing the covers of the laser product could result in exposure to hazardous laser radiation. There are no serviceable parts inside the device.
- Use of controls or adjustments or performance of procedures other than those specified herein might result in hazardous radiation exposure.



Some laser products contain an embedded Class 3A or Class 3B laser diode. Note the following.

Laser radiation when open. Do not stare into the beam, do not view directly with optical instruments, and avoid direct exposure to the beam.

Liquid crystal display (LCD) notice

CAUTION:

For products with mercury-containing fluorescent lamps (for example, non-LED)

- **The fluorescent lamp in the liquid crystal display contains mercury; dispose of according to local, state, or federal laws.**
- **The LCD is made of glass, and rough handling or dropping the computer can cause the LCD to break. If the LCD breaks and the internal fluid gets into your eyes or on your hands, immediately wash the affected areas with water for at least 15 minutes; if any symptoms are present after washing, get medical care.**

Using headphones or earphones

If your computer has both a headphone connector and an audio-out connector, always use the headphone connector for headphones (also called a headset) or earphones.

CAUTION:

Excessive sound pressure from earphones and headphones can cause hearing loss. Adjustment of the equalizer to maximum increases the earphone and headphone output voltage and the sound pressure level. Therefore, to protect your hearing, adjust the equalizer to an appropriate level.

Excessive use of headphones or earphones for a long period of time at high volume can be dangerous if the output of the headphone or earphone connectors do not comply with specifications of EN 50332-2. The headphone output connector of your computer complies with EN 50332-2 Sub clause 7. This specification limits the computer's maximum wide band true RMS output voltage to 150 mV. To help protect against hearing loss, ensure that the headphones or earphones you use also comply with EN 50332-2 (Clause 7 limits) for a wide band characteristic voltage of 75 mV. Using headphones that do not comply with EN 50332-2 can be dangerous due to excessive sound pressure levels.

If your Lenovo computer came with headphones or earphones in the package, as a set, the combination of the headphones or earphones and the computer already complies with the specifications of EN 50332-1. If different headphones or earphones are used, ensure that they comply with EN 50332-1 (Clause 6.5 Limitation Values). Using headphones that do not comply with EN 50332-1 can be dangerous due to excessive sound pressure levels.

Additional safety information



Plastic bags can be dangerous. Keep plastic bags away from babies and children to avoid danger of suffocation.

Notice for tablet personal computer users

Safety notice for users in Australia



Do not connect phone line while using tablet mode.

Notice for users in the U.S.A.

Many personal computer products and accessories contain cords, cables or wires, such as power cords or cords to connect the accessory to a personal computer. If this product has such a cord, cable or wire, then the following warning applies:

WARNING: Handling the cord on this product or cords associated with accessories sold with this product will expose you to lead, a chemical known to the State of California to cause cancer, and birth defects or other reproductive harm. ***Wash hands after handling.***

Save these instructions.

Chapter 1. Product Overview

This chapter provides information about the locations of connectors, locating important product information, computer features, specifications, operating environment, and preinstalled software programs.

This chapter contains the following topics:

- “Locating computer controls, connectors, and indicators” on page 1
- “Locating important product information” on page 13
- “Features” on page 15
- “Specifications” on page 18
- “Operating environment” on page 18
- “ThinkVantage Technologies and software” on page 19

Locating computer controls, connectors, and indicators

This section introduces the computer hardware features to give you the basic information you will need to start using the computer.

This section contains the following topics:

- “Front view” on page 2
- “Right-side view” on page 6
- “Left-side view” on page 7
- “Rear view” on page 10
- “Bottom view” on page 9
- “Status indicators” on page 11

Front view

ThinkPad Edge E425 front view



Figure 1. ThinkPad Edge E425 front view

1 UltraConnect™ wireless antennas (left)	2 Integrated camera
3 Built-in microphone	4 UltraConnect wireless antennas (right)
5 Power switch	6 Fingerprint reader
7 System status indicators (illuminated ThinkPad logo)	8 Built-in stereo speaker (right)
9 TrackPoint® pointing stick	10 TrackPoint buttons
11 Touch pad buttons	12 Touch pad
13 Built-in stereo speaker (left)	14 Bluetooth antenna
15 Volume control buttons	

1 UltraConnect wireless antennas (left) **4 UltraConnect wireless antennas (right)**

The built-in antennas for the wireless communication are located at the top left and top right portions of your computer display.

For details, refer to “Location of the UltraConnect wireless antennas” on page 138.

2 Integrated camera

Your computer might have an integrated camera. By using this camera, you can take pictures or hold a video conference.

For more information about how to use the camera, refer to “Using an integrated camera” on page 45.

3 Built-in microphone

The built-in microphone captures sound and voice when it is used with an application program capable of handling audio.

5 Power switch

Use the power switch to turn on the computer. To turn off your computer, use the **Start** menu shutdown option.

If you cannot turn off the computer by this method, press and hold the power switch for 2 seconds.

If your computer stops responding, and you cannot turn it off, press and hold the power switch for 4 seconds or more. If the system is still not reset, remove the ac power adapter and the battery.

The power switch also can be programmed through Power Manager to shut down the computer or put it into sleep or hibernation mode.

6 Fingerprint reader

Your computer might have an integrated fingerprint reader. The fingerprint authentication technology enables you to use your fingerprint to start the computer and access the ThinkPad® Setup program.

For details, refer to the instructions in “Using a fingerprint reader” on page 58.

7 System status indicators (illuminated ThinkPad logo)

Your computer has two system status indicators, one on the outer lid of your computer and the other on the palm rest. The illustration above shows the one on the palm rest. For details, see “System status indicators” on page 12.

8 Built-in stereo speaker (right)

13 Built-in stereo speaker (left)

The stereo speakers are built into your computer.

For details, refer to the instructions in “ThinkPad Edge E425 special keys” on page 27.

UltraNav pointing device

9 TrackPoint pointing stick

10 TrackPoint buttons

11 Touch pad buttons

12 Touch pad

Your computer comes with the UltraNav® pointing device. The UltraNav pointing device consists of the TrackPoint pointing device and the touch pad. With the TrackPoint pointing device, pointing, selecting, and dragging are all part of a single process that you can perform without moving your fingers from a typing position.

Move your fingertip across the touch pad to move the pointer.

The TrackPoint and touch pad buttons provide functions similar to those of a mouse and its buttons.

14 Bluetooth antenna

If your computer has integrated Bluetooth features, refer to “Using Bluetooth” on page 40 for more information.

15 Volume control buttons

The built-in volume control buttons enable you to quickly adjust the volume or mute the sound from your computer.

For details, refer to the instructions in “ThinkPad Edge E425 special keys” on page 27.

ThinkPad Edge E525 front view

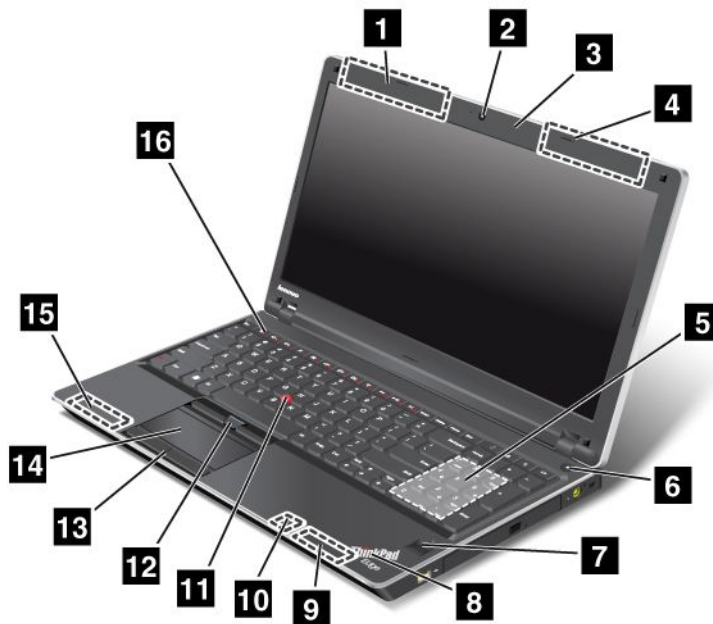

Figure 2. ThinkPad Edge E525 front view

1 UltraConnect wireless antennas (left)	2 Integrated camera
3 Built-in microphone	4 UltraConnect wireless antennas (right)
5 Numeric keypad	6 Power switch
7 Fingerprint reader	8 System status indicators (illuminated ThinkPad logo)
9 Built-in stereo speaker (right)	10 Bluetooth antenna
11 TrackPoint pointing stick	12 TrackPoint buttons
13 Touch pad buttons	14 Touch pad
15 Built-in stereo speaker (left)	16 Volume control buttons

1 UltraConnect wireless antennas (left)

4 UltraConnect wireless antennas (right)

The built-in antennas for the wireless communication are located at the top left and top right portions of your computer display.

For details, refer to “Location of the UltraConnect wireless antennas” on page 138.

2 Integrated camera

Your computer might have an integrated camera. By using this camera, you can take pictures or hold a video conference.

For more information about how to use the camera, refer to “Using an integrated camera” on page 45.

3 Built-in microphone

The built-in microphone captures sound and voice when it is used with an application program capable of handling audio.

5 Numeric keypad

Your computer has a numeric keypad that can be used to quickly input numbers.

6 Power switch

Use the power switch to turn on the computer. To turn off your computer, use the **Start** menu shutdown option.

If you cannot turn off the computer by this method, press and hold the power switch for 2 seconds.

If your computer stops responding, and you cannot turn it off, press and hold the power switch for 4 seconds or more. If the system is still not reset, remove the ac power adapter and the battery.

The power switch also can be programmed through Power Manager to shut down the computer or put it into sleep or hibernation mode.

7 Fingerprint reader

Your computer may have an integrated fingerprint reader. The fingerprint authentication technology enables you to use your fingerprint to start the computer and access the ThinkPad Setup program.

For details, refer to the instructions in “Using a fingerprint reader” on page 58.

8 System status indicators (illuminated ThinkPad logo)

Your computer has two system status indicators, one on the outer lid of your computer and the other on the palm rest. The illustration above shows the one on the palm rest. For details, see “System status indicators” on page 12.

9 Built-in stereo speaker (right)

15 Built-in stereo speaker (left)

The stereo speakers are built into your computer.

For details, refer to “Thinkpad Edge E525 special keys” on page 29.

10 Bluetooth antenna

If your computer has integrated Bluetooth features, refer to “Using Bluetooth” on page 40 for more information.

UltraNav pointing device

11 TrackPoint pointing stick

12 TrackPoint buttons

13 Touch pad buttons

14 Touch pad

Your computer comes with the UltraNav pointing device. The UltraNav pointing device consists of the TrackPoint pointing device and the touch pad. With the TrackPoint pointing device, pointing, selecting, and dragging are all part of a single process that you can perform without moving your fingers from a typing position.

Move your fingertip across the touch pad to move the pointer.

The TrackPoint and touch pad buttons provide functions similar to those of a mouse and its buttons.

16 Volume control buttons

The built-in volume control buttons enable you to quickly adjust the volume or mute the sound from your computer.

For details, refer to the instructions in “Thinkpad Edge E525 special keys” on page 29.

Right-side view

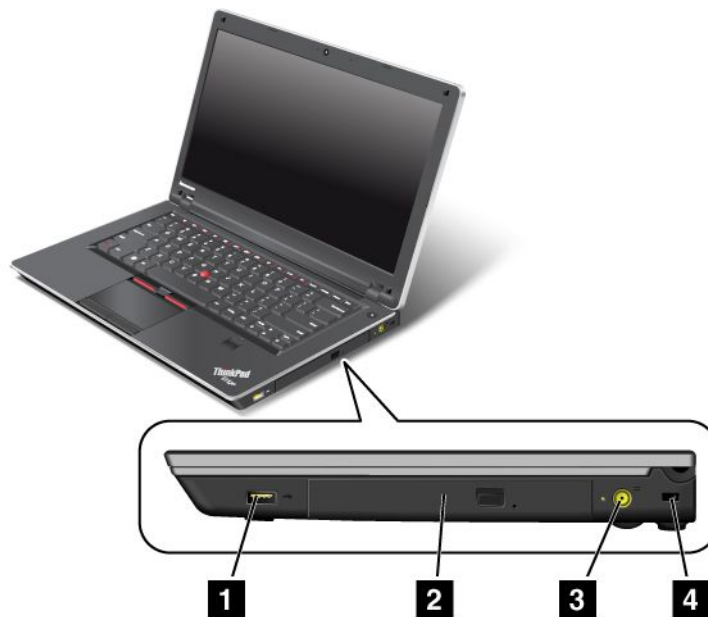

Figure 3. ThinkPad Edge E425 and E525 right-side view

Note: Your computer keyboard might look different from the illustration above.

1 Always On USB connector	2 Optical drive
3 Power jack	4 Security keyhole

1 Always On USB connector

The Always On USB connector is used for connecting devices compatible with a USB interface, such as a printer or a digital camera.

By default, even if your computer is in sleep mode, the Always On USB connector still enables you to charge some devices, such as iPod®, iPhone®, and BlackBerry® smartphones, by attaching the devices to the connector.

However, with the ac power adapter attached, if you want to charge these devices when your computer is in hibernation mode or powered off, you will need to open the Power Manager program and configure corresponding settings to enable the Always On USB connector. For details about how to enable the Always On USB connector, refer to the on-line help of the Power Manager program.

Note: Your computer is compatible with USB 1.1 and 2.0.

2 Optical drive

Your computer has a slot for an optical drive.

3 Power jack

The ac power adapter cable connects to the computer power jack to provide power to the computer and charge the battery.

An indicator to the left of the connector shows the status of ac power. When the ac power adapter is connected, the indicator is lit. If a battery is installed in the computer, the indicator is green when the battery charges.

4 Security keyhole

Your computer comes with a security keyhole. You can purchase a security cable lock to fit this keyhole.

Left-side view

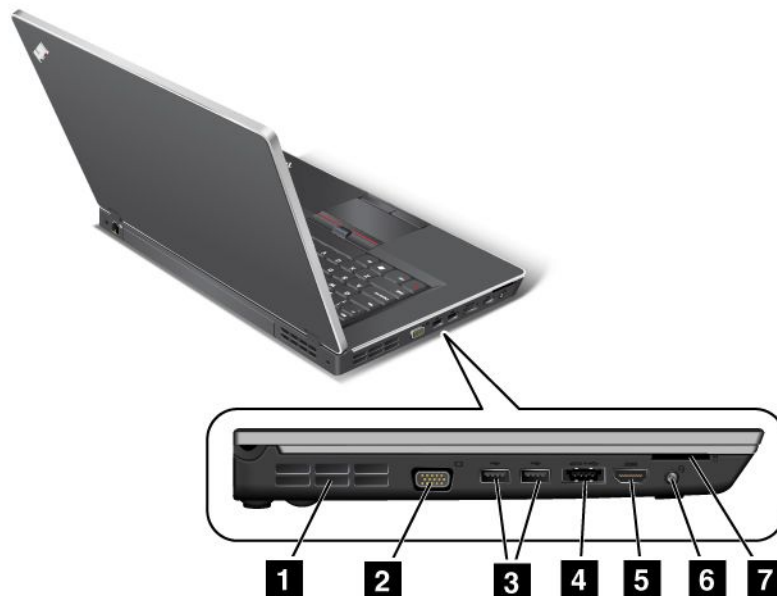

Figure 4. ThinkPad Edge E425 and E525 left-side view

Note: Your computer keyboard might look different from the illustration above.

1 Fan louvers (left)	2 Monitor connector
3 USB connectors	4 eSATA/USB combo connector
5 HDMI port	6 Combo audio jack
7 Media card reader slot	

1 Fan louvers (left)

The internal fan and louvers enable air to circulate in the computer and cool the CPU.

Note: To avoid impeding airflow, do not place any obstacle in front of the fan.

2 Monitor connector

The monitor connector is used to connect an external monitor or projector to your computer.

For details, refer to the instructions in “Attaching an external monitor” on page 42.

3 USB connectors

The USB connectors are used for connecting devices compatible with a USB interface, such as a printer or a digital camera.

Note: Your computer is compatible with USB 1.1 and 2.0.

4 eSATA/USB combo connector

The eSATA/USB connector is used for connecting devices compatible with a USB interface, such as a printer or a digital camera. You can also connect an external SATA device, such as an external hard disk drive, to this connector.

Note: Your computer is compatible with USB 1.1 and 2.0.

5 HDMI port

Your computer supports the high-definition multimedia interface (HDMI) port, a digital audio and video interface that can connect a compatible digital audio device or video monitor such as an HDTV.

6 Combo audio jack

To listen to the sound from your computer, connect a headphone or a headset, that has a 3.5 mm 4-pole plug, to the combo audio jack.

Notes:

- If you are using a headset with a function switch, for example, a headset for an iPhone mobile digital device, do not press this switch while using the headset. If you press it, the headset microphone will be disabled, and the internal microphone will be enabled instead.
- The combo audio jack does not support a conventional microphone. For more information about the audio devices supported by the combo audio jack, see “Using audio features” on page 44.

7 Media card reader slot

Depending on the model, your computer might have a media card reader slot. The media card reader supports the following four types of cards:

- SD cards
- SDHC cards
- SDXC cards

- MultiMediaCards

Note: Your computer does not support the Content Protection for Recordable Media (CPRM) feature for SD cards.

For details, refer to the instructions in “Using a flash media Card” on page 46.

Bottom view

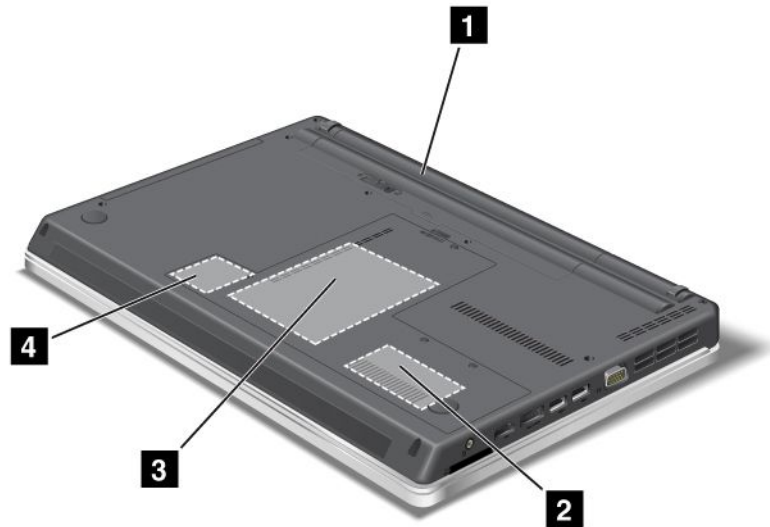

Figure 5. ThinkPad Edge E425 and E525 bottom view

1 Battery	2 Memory-upgrade slot
3 Hard disk drive	4 PCI Express Mini Card slot for wireless LAN

1 Battery

Use your computer with battery power whenever ac power is unavailable.

By installing an extended life battery available as an option, you can extend the operating time of the computer.

You can also use the Power Manager program to adjust your power setting as needed. For details, refer to the instructions in “Power Manager” on page 22.

2 Memory-upgrade slot

You can increase the amount of memory in your computer by installing a memory module in the memory slot. Memory modules are available as options.

3 Hard disk drive

Your computer might have a large-capacity, customer-upgradable hard disk drive that can meet a variety of storage demands. To keep the drive safe, the Active Protection System™ program is installed on your computer. For details, refer to “Active Protection System” on page 21.

Note: The hidden service partition is the reason why there is less free space than expected on your hard disk drive.

4 PCI Express Mini Card slot for wireless LAN

Your computer might include a PCI Express Mini Card for wireless LAN in the PCI Express Mini Card slot for wireless LAN communications.

Rear view

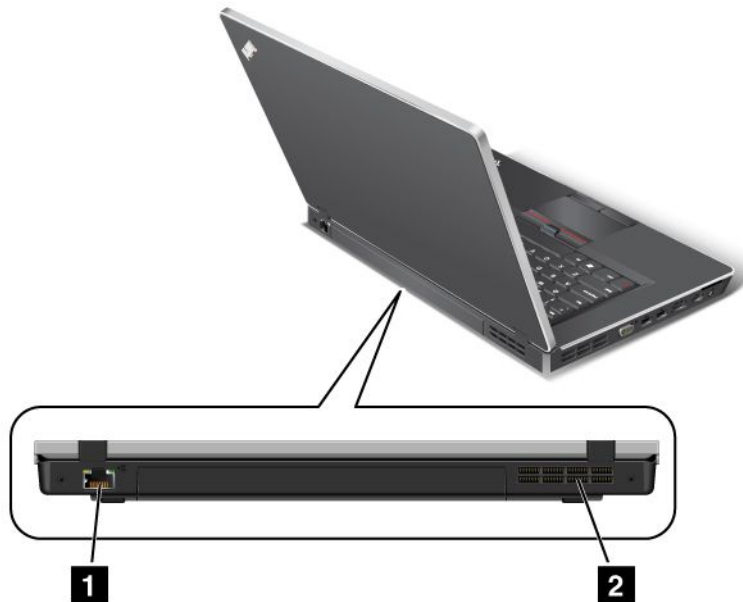

Figure 6. ThinkPad Edge E425 and E525 rear view

1 Ethernet connector	2 Fan louvers (rear)
-----------------------------	-----------------------------

1 Ethernet connector

The Ethernet connector is used to connect your computer to a LAN.



To avoid the risk of electrical shock, do not connect the telephone cable to the Ethernet connector. You can only connect an Ethernet cable to this connector.

Two indicators, to the lower right and left of the connector, show the status of the network connection. When your computer connects to a LAN and a session with the network is available, the lower right indicator is solid green. While data is being transmitted, the lower left indicator blinks yellow.

For details, refer to the instructions in “Access Connections” on page 21.

2 Fan louvers (rear)

The internal fan and louvers enable air to circulate in the computer and cool the CPU.

Note: To avoid impeding airflow, do not place any obstacle in front of the fan.

Status indicators

The status indicators show the current status of your computer.

System status indicators



Note: Your computer keyboard might look different from the illustration above.

The illuminated dot in the ThinkPad logo on the outer lid of your computer and on the palm rest works as a system status indicator: it shows whether the computer is in sleep, hibernation, or normal mode.

The meaning of the indicator is as follows:

- **Red:** The computer is on (in normal mode).
- **Fast blinking red:** The computer is entering sleep or hibernation mode.
- **Slow blinking red:** The computer is in sleep mode.
- **Off:** The computer is off or in hibernation mode.

Power status indicator

Your computer has an indicator that shows the status of ac power.



Note: Your computer keyboard might look different from the illustration above.

The meaning of the indicator is as follows:

- **Green:** The ac power adapter is connected.
- **Off:** The ac power adapter is not connected.

Indicators on the screen

Caps Lock indicator

Caps Lock mode is enabled. You can enter all alphabetic characters (A-Z) in uppercase without pressing the **Shift** key.

Wireless status indicator

Press F9 to enable or disable the wireless features. You can quickly change the power state of each feature in the list. For information on the wireless features, refer to “Wireless connections” on page 39.

Locating important product information

This section provides information to help you locate your machine type and model label, FCC ID and IC Certification label, and the Microsoft® Certificate of Authenticity (COA) label.

Machine type and model label

The machine type and model label identifies your computer. When you contact Lenovo for help, the machine type and model information helps support technicians to identify your computer and provide faster service.

You can find the machine type and model of your computer in the label as shown below:

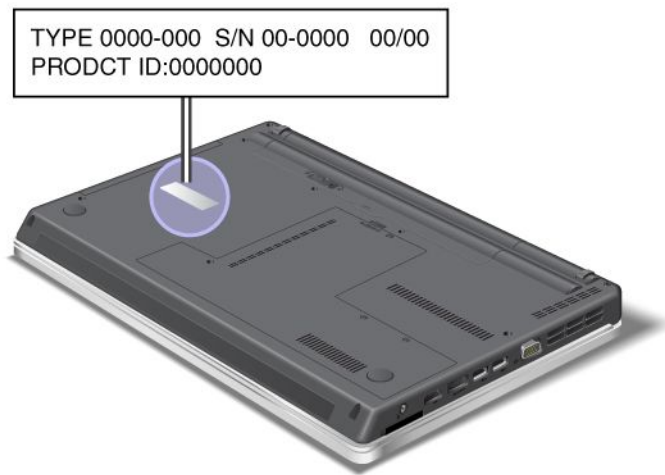

FCC ID and IC Certification number label

There is no FCC ID or IC Certification number for the PCI Express Mini Card shown on the enclosure of your computer. The FCC ID and IC Certification number label is affixed on the card installed in the PCI Express Mini Card slot of your computer.

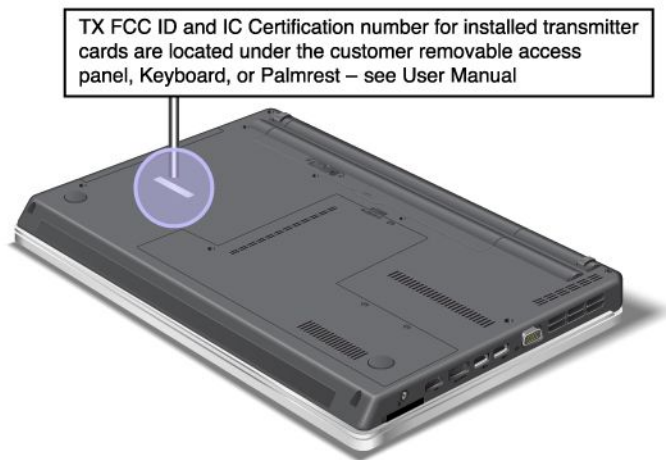

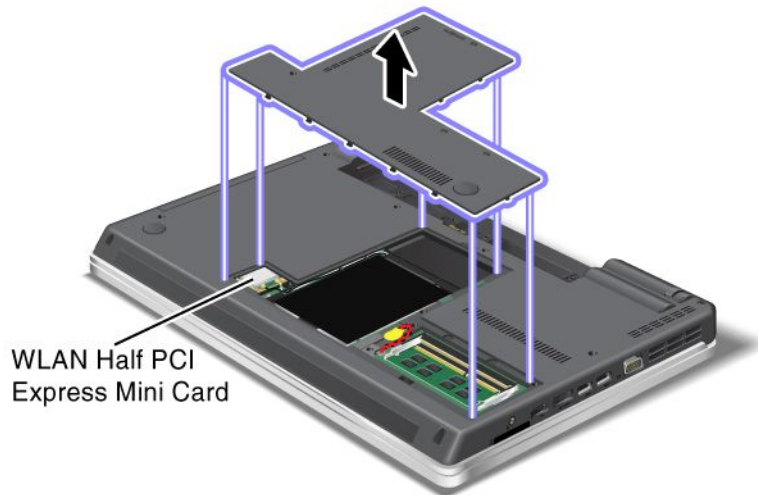

If no integrated wireless PCI Express Mini Card has been preinstalled in your computer, you can install one. To do this, follow the procedure in “Replacing a PCI Express Mini Card for wireless LAN connection” on page 78.

Certificate of Authenticity label

The Certificate of Authenticity label for the preinstalled operating system is attached. Printed on this label are the product ID and the product key information for your computer. Record this information and keep it in a safe place. You might need these numbers to start your computer or reinstall the operating system.

The Certificate of Authenticity label of your computer is shown as below:

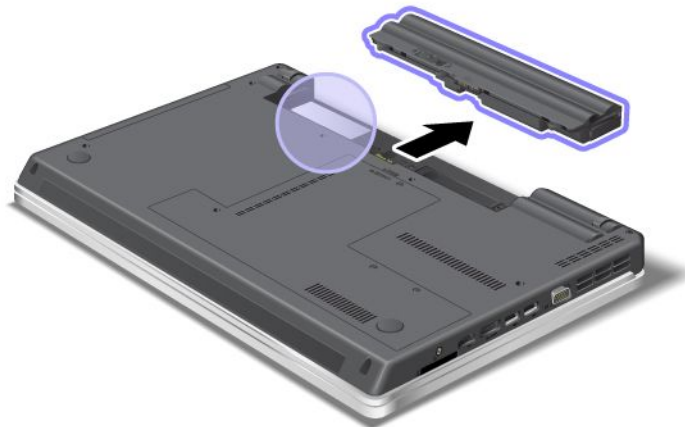

Features

This topic lists the features of your computer.

ThinkPad Edge E425 features

Processor

- To see the system properties of your computer, click **Start**, right-click **Computer**; then select **Properties** from the pull-down menu.

Memory

- Double data rate 3 synchronous dynamic random access memory modules (DDR3 SDRAMM)

Storage device

- 2.5-inch (64 mm) hard disk drive

Display

The color display uses TFT technology:

- Size: 14.0 inches (355.6 mm)
- Resolution:
 - LCD: Up to 1366x768
 - External monitor: Up to 2048x1536
- Brightness control
- Integrated camera (on some models)
- Built-in microphone

Keyboard

- 84-key, 85-key, or 89-key
- UltraNav pointing device (TrackPoint and multi-touch touch pad)
- Fn key

Interface

- External monitor connectors (VGA connector and HDMI connector)
- Combo audio jack
- 2 USB connectors
- 1 Always On USB connector
- 1 eSATA/USB connector
- RJ45 Ethernet connector
- 4-in-1 digital media card reader

Optical drive

- Multi-Burner drive

Wireless features

- Integrated wireless LAN
- Integrated Bluetooth (on some models)

Security features

- Fingerprint reader (on some models)

ThinkPad Edge E525 features

Processor

- To see the system properties of your computer, click **Start**, right-click **Computer**; then select **Properties** from the pull-down menu.

Memory

- Double data rate 3 synchronous dynamic random access memory modules (DDR3 SDRAMM)

Storage device

- 2.5-inch (64 mm) hard disk drive

Display

The color display uses TFT technology:

- Size: 15.6 inches (396.2 mm)
- Resolution:
 - LCD: Up to 1366x768
 - External monitor: Up to 2048x1536
- Brightness control
- Integrated camera (on some models)
- Built-in microphone

Keyboard

- 105-key, 106-key, or 110-key
- UltraNav pointing device (TrackPoint and multi-touch touch pad)
- Fn key
- Numeric keypad

Interface

- External monitor connectors (VGA connector and HDMI connector)
- Combo audio jack
- 2 USB connectors
- 1 Always On USB connector
- 1 eSATA/USB connector
- RJ45 Ethernet connector
- 4-in-1 digital media card reader

Optical drive

- Multi-Burner drive

Wireless features

- Integrated wireless LAN
- Integrated Bluetooth (on some models)

Security features

- Fingerprint reader (on some models)

Specifications

This section lists the physical specifications for your computer.

Size

- For ThinkPad Edge E425 models:
 - Width: 343.4 mm (13.52 inches)
 - Depth: 235 mm (9.25 inches)
 - Height: 28.7 to 36.4 mm (1.13 to 1.43 inches)
- For ThinkPad Edge E525 models:
 - Width: 380.3 mm (14.97 inches)
 - Depth: 248.75 mm (9.79 inches)
 - Height: 30.6 to 38.3 mm (1.20 to 1.50 inches)

Heat output

- 65 W (222 Btu/hr) maximum or 90 W (307 Btu/hr) maximum (depending on the model)

Power source (ac power adapter)

- Sine-wave input at 50 to 60 Hz
- Input rating of the ac power adapter: 100 to 240 V ac, 50 to 60 Hz

Battery pack

- Lithium-ion (Li-Ion) battery pack

Battery life

- For percentage of the remaining battery power, see the Power Manager battery gauge on the task bar.
- The Power Manager program also displays a green, yellow, or red indication. A battery under warranty with a red indication is eligible for a warranty replacement.

Operating environment

This section provides information about your computer operating environment.

Environment:

- Maximum altitude without pressurization: 3048 m (10,000 ft)
- Temperature
 - At altitudes up to 2438 m (8000 ft)
 - Operating: 5.0°C to 35.0°C (41°F to 95°F)
 - Storage: 5.0°C to 43.0°C (41°F to 109°F)
 - At altitudes above 2438 m (8000 ft)
 - Maximum temperature when operating under the unpressurized condition: 31.3°C (88°F)

Note: When you charge the battery pack, its temperature must be at least 10°C (50°F).

- Relative humidity:

- Operating: 8% to 80%
- Storage: 5% to 95%

If possible, place your computer in a well-ventilated and dry area without direct exposure to sunshine.

Keep electrical appliances such as an electric fan, radio, high-powered speakers, air conditioner, and microwave oven away from your computer because the strong magnetic fields generated by these appliances can damage the monitor and data on the hard disk drive.

Do not place any beverages on top of or beside the computer or other attached devices. If liquid is spilled on or in the computer or an attached device, a short circuit or other damage might occur.

Do not eat or smoke over your keyboard. Particles that fall into your keyboard can cause damage.

ThinkVantage Technologies and software

ThinkVantage® Technologies and some other software programs are preinstalled on your computer to help you work more easily and securely.

The following sections provide information about ThinkVantage Technologies and other computing solutions offered by Lenovo.

- “Accessing applications” on page 19
- “Access Connections” on page 21
- “Active Protection System” on page 21
- “Fingerprint Software” on page 21
- “Lenovo Solutions Center” on page 21
- “Lenovo ThinkVantage Tools” on page 22
- “Lenovo ThinkVantage Toolbox” on page 22
- “Message Center Plus” on page 22
- “Password Manager” on page 22
- “Power Manager” on page 22
- “Product Recovery” on page 23
- “Rescue and Recovery” on page 23
- “System Update” on page 23
- “ThinkVantage GPS” on page 23

Note: To learn more about ThinkVantage Technologies and other computing solutions offered by Lenovo, go to: <http://www.lenovo.com/support>

Accessing applications

You can access applications from the Lenovo ThinkVantage Tools program or from Control Panel.

- Access applications from the Lenovo ThinkVantage Tools program
Click **Start** → **All Programs** → **Lenovo ThinkVantage Tools**. Double-click an application icon to access the application.

Note: If an application icon in the Lenovo ThinkVantage Tools application navigation window is dimmed, it indicates that you need to install the application manually. To install the application manually, double-click

the application icon. Then, follow the instructions on the screen. When the installation process completes, the application icon will be activated.

Table 1. Applications in the Lenovo ThinkVantage Tools program

Application	Icon name
Access Connections	Internet Connection
Active Protection System	Airbag Protection
Fingerprint Software	Fingerprint Reader
Lenovo ThinkVantage Toolbox or Lenovo Solution Center	System Health and Diagnostics
Mobile Broadband Activate	3G Mobile Broadband
Password Manager	Password Vault
Power Manager	Power Controls
Recovery Media	Factory Recovery Disks
Rescue and Recovery	Enhanced Backup and Restore
System Update	Update and Drivers
ThinkVantage GPS	GPS

- Access applications from Control Panel

Click **Start → Control Panel**. Depending on the application you want to access, click the corresponding section and then click the corresponding green text.

Note: If you do not find the application you need in Control Panel, open the Lenovo ThinkVantage Tools application navigation window and double-click the dimmed icon to install the application you need. Then, follow the instructions on the screen. When the installation process completes, the application icon will be activated, and you can find the application in Control Panel.

The sections in Control Panel, the green texts, and the applications are listed in the following table.

Table 2. Applications in Control Panel

Application	Control Panel section	Green text in Control Panel
Access Connections	Network and Internet	Lenovo - Internet Connection
Active Protection System	System and Security Hardware and Sound	Lenovo - Airbag Protection
Communications Utility	Hardware and Sound	Lenovo - Web Conferencing
Fingerprint Software	System and Security Hardware and Sound	Lenovo - Fingerprint Reader or Lenovo - Notebook Fingerprint Reader
Lenovo ThinkVantage Toolbox or Lenovo Solution Center	System and Security	Lenovo - System Health and Diagnostics
Mobile Broadband Activate	Network and Internet	Lenovo - 3G Mobile Broadband
Password Manager	System and Security User Accounts and Family Safety	Lenovo - Password Vault

Table 2. Applications in Control Panel (continued)

Application	Control Panel section	Green text in Control Panel
Power Manager	Hardware and Sound System and Security	Lenovo - Power Controls
Recovery Media	System and Security	Lenovo - Factory Recovery Disks
System Update	System and Security	Lenovo - Update and Drivers
Rescue and Recovery	System and Security	Lenovo - Enhanced Backup and Restore
ThinkVantage GPS	Network and Internet System and Security	Lenovo - GPS

Access Connections

The Access Connections™ program is a connectivity assistant program for creating and managing location profiles. Each location profile stores all the network and Internet configuration settings needed for connecting to a network infrastructure from a specific location such as a home or an office.

By switching between location profiles as you move your computer from place to place, you can quickly and easily connect to a network with no need to reconfigure your settings manually and restart the computer each time.

For instructions on accessing the Access Connections program, see “Accessing applications” on page 19.

Active Protection System

The Active Protection System program protects your hard disk drive when the shock sensor inside your computer detects a condition that could damage the drive, such as system tilt, excessive vibration, or shock. The hard disk drive is less vulnerable to damage when it is not operating. This is because when the hard disk drive is not operating, the system stops it from spinning, and may also move the read and write heads of the drive to areas that do not contain data. As soon as the shock sensor senses that the environment is stable again (minimal change in system tilt, vibration, or shock), it turns the hard disk drive on.

For instructions on accessing the Active Protection System program, see “Accessing applications” on page 19.

Fingerprint Software

If your system comes with a fingerprint reader, the Fingerprint Software program enables you to enroll your fingerprint and associate it with your Windows® password. As a result, the fingerprint authentication can replace your password and enable simple and secure user access.

For instructions on accessing the Fingerprint Software program, see “Accessing applications” on page 19.

Lenovo Solutions Center

Note: Depending on the date when your computer was manufactured, your computer is preinstalled with either the Lenovo Solution Center program or the Lenovo ThinkVantage Toolbox program for diagnostic purposes. For additional information about the Lenovo ThinkVantage Toolbox program, see “Lenovo ThinkVantage Toolbox” on page 22.

The Lenovo Solution Center program enables you to troubleshoot and resolve computer problems. It combines diagnostic tests, system information collection, security status, and support information, along

with hints and tips for maximum system performance. For more information, see “Diagnosing problems” on page 113.

To start the Lenovo Solution Center program in Windows 7, see “Accessing applications” on page 19.

Lenovo ThinkVantage Tools

The Lenovo ThinkVantage Tools program helps you work more easily and securely by providing easy access to various technologies, such as:

- Lenovo Solution Center or Lenovo ThinkVantage Toolbox (depending on the date of manufacture)
- Power Manager
- Rescue and Recovery
- System Update

To access the Lenovo ThinkVantage Tools program, click **Start → All Programs → Lenovo ThinkVantage Tools**.

Lenovo ThinkVantage Toolbox

Note: Depending on the date when your computer was manufactured, your computer is preinstalled with either the Lenovo Solution Center program or the Lenovo ThinkVantage Toolbox program for diagnostic purposes. For additional information about the Lenovo Solution Center program, see “Lenovo Solutions Center” on page 21.

The Lenovo ThinkVantage Toolbox program enables you to view symptoms of computer problems and find solutions for them. It also includes automatic notification when action is required, computing assistance, advanced diagnostics, and diagnostic history.

For instructions on accessing the Lenovo ThinkVantage Toolbox program, see “Accessing applications” on page 19.

For additional information about running the Lenovo ThinkVantage Toolbox program, refer to the Lenovo ThinkVantage Toolbox help information system.

Message Center Plus

The Message Center Plus program displays messages to inform you about helpful software that has been preinstalled on your computer. The software enables you to manage wired and wireless connections, protect your data in the event of a problem, and automatically diagnose and resolve potential problems with your computer. The Message Center Plus program can also provide messages about new updates available to keep your computer current.

Password Manager

The Password Manager program automatically captures and fills in authentication information for Windows applications and Web sites.

For instructions on accessing the Password Manager program, see “Accessing applications” on page 19.

Power Manager

The Power Manager program provides convenient, flexible, and complete power management for your computer. By using the Power Manager program, you can adjust your power settings to give you the best balance between performance and power saving.

For instructions on accessing the Power Manager program, see “Accessing applications” on page 19.

Product Recovery

The Product Recovery program enables you to restore the contents of the hard disk drive to the factory default settings.

For information about how to access and use this program, refer to “Creating and using recovery media” on page 63.

Rescue and Recovery

The Rescue and Recovery® program is a one button recovery and restore solution that includes a set of self-recovery tools to help you diagnose computer problems, get help, and recover from system crashes, even if you cannot start the Windows operating system.

For instructions on accessing the Rescue and Recovery program, see “Accessing applications” on page 19.

System Update

The System Update program helps you keep the software on your computer up-to-date by downloading and installing software packages (ThinkVantage applications, device drivers, UEFI BIOS updates, and other third party applications).

For instructions on accessing the System Update program, see “Accessing applications” on page 19.

ThinkVantage GPS

If the PCI Express Mini Card installed in your computer supports GPS, your computer can receive signals from GPS satellites and determine its location. If your computer is connected to the Internet, you can find your location on a real-time map provided by Google Maps or Microsoft Bing™ Maps.

For instructions on accessing the ThinkVantage GPS program, see “Accessing applications” on page 19.

Chapter 2. Using your computer

This chapter provides information on using some of the computer components.

This chapter contains the following topics:

- “Registering your computer” on page 25
- “Frequently asked questions” on page 25
- “Special keys and buttons” on page 26
- “Using the UltraNav pointing device” on page 31
- “Power management” on page 34
- “Connecting to the network” on page 39
- “Using a projector or an external display” on page 42
- “Using audio features” on page 44
- “Using an integrated camera” on page 45
- “Using the optical drive” on page 46
- “Using a flash media Card” on page 46

Registering your computer

When you register your computer, information is entered into a database, which enables Lenovo to contact you in case of a recall or other severe problems. In addition, some locations offer extended privileges and services to registered users.

When you register your computer with Lenovo, you will also receive the following benefits:

- Quicker service when you call Lenovo for help
- Automatic notification of free software and special promotional offers

To register your computer with Lenovo, go to: <http://www.lenovo.com/register>. Then follow the instructions on the screen.

Frequently asked questions

The following are a few tips that will help you optimize the use of your computer.

To ensure that you receive the best performance from your computer, go to the following Web page to find information such as aids for troubleshooting and answers to frequently asked questions:
<http://www.lenovo.com/support/faq>

Can I get my user guide in another language?

- To download the user guide in another language, go to: <http://www.lenovo.com/support>. Then follow the instructions on the screen.

How to use the batter power more effectively?

- To conserve power, or to suspend operation without exiting applications or saving files, see “Power-saving modes” on page 36.

- To achieve the best balance between performance and power saving, create and apply power plans by use of Power Manager.
- If your computer will be turned off for an extended period of time, you can prevent battery power from draining by removing the battery. Look for more information about using the battery in “Power management” on page 34.

How to securely dispose of data stored on the hard disk drive?

- Study the Chapter 4 “Security” on page 53 to find out how you can protect your computer from theft and unauthorized use.
- Before you dispose of the data on the hard disk drive, be sure to read “Notice on deleting data from your hard disk drive” on page 60.

Is getting connected in different locations a challenge?

- To troubleshoot a wireless networking issue, go to:
<http://www.lenovo.com/support/faq>
- Take advantage of the networking features by use of the Access Connections program.
- To learn more about using the wireless features of your computer, refer to “Wireless connections” on page 39.
- To travel more confidently, be sure to check the tips in “Traveling with your computer” on page 51.
- Press F9 to enable or disable the wireless features.

Need to give presentations or attach an external monitor often?

- Make sure that you follow the procedure for “Attaching an external monitor” on page 42.
- With the Extend desktop function, you can display output on both the computer display and an external monitor.

Need to attach or replace a device?

- See Chapter 6 “Replacing devices” on page 69 for more information about replacing the devices of your computer.

You have been using your computer for some time already, and it is getting slower?

- Follow the “General tips for preventing problems” on page 107.
- You can diagnose problems yourself by using the preinstalled software. See “diagnose problems” on page 113.
- Check for recovery solutions in Chapter 5 “Recovery overview” on page 63.

Print the following sections and keep them with your computer in case you are unable to access this online user guide when necessary.

- “Installing a new operating system” on page 93
- “Computer stops responding” on page 114
- “Power problems” on page 128

Special keys and buttons

Your computer has several special keys and buttons to help you work more easily and effectively. For the Windows 7 operating system, the On Screen Display program is preinstalled on your computer to enable you to toggle between the default and standard settings of the ThinkPad F1-F12 key functionality.

To toggle the F1-F12 key functionality on the Windows 7 operating system, do either of the following:

- From Control Panel:
 1. Click **Start → Control Panel**.
 2. In the icons view, click **Keyboard** and the Keyboard Properties window is displayed.
 3. Configure the key functionality as desired.
- Pressing Fn for four seconds and the ThinkPad Keyboard Properties window is displayed. Then configure the key functionality as desired.

ThinkPad Edge E425 special keys

Your computer has several special keys **1** and **2**. To take advantage of each function, directly press the desired key.

Notes: To use F1-F12 as standard function keys, do either of the following:

- In the keyboard properties window, click the **ThinkPad F1-F12 keys** tab, select **Legacy**, and then click **OK**.
- On the ThinkPad Setup program main menu, select **Config → Keyboard/Mouse → Change to F1-F12 keys → Legacy**.



1 Volume and mute keys

To quickly adjust the volume of the sound from your computer, mute the sound entirely, set the microphone to mute, or control the video output from the integrated camera, press one of the following keys.

Speaker mute (F1)

Speaker volume down (F2)

Speaker volume up (F3)

If you mute the sound and then turn off your computer, the sound will remain muted when you turn on your computer again. To turn on the sound, press the **Speaker volume up** or **Speaker volume down** keys.

Microphone mute (F4)

Press the microphone mute key to mute or unmute all of the recording devices.

Launching the camera and audio settings (F5)

If you press F5, the camera and audio settings window is opened and the camera preview is turned on. From this window, you can change the camera and audio settings.

Display management keys

Switching the display output location (F6)

Press this key to switch between the computer display and an external monitor. The following options will be displayed:

- Computer display only (LCD)
- Computer display and external monitor (same image)
- Computer display and external monitor (the Extend desktop function)
- External monitor only

Note: To switch between the computer display and an external monitor, the Windows+P key combination is also available.

Display brightness down (F7)

When you press this key, the computer display becomes dimmer. The purpose of this method is to change the brightness level temporarily. To change the default brightness level, use the Power Manager program, or go into **Control Panel → Performance and Maintenance → Power Options** and make changes as desired.

Display brightness up (F8)

When you press this key, the computer display becomes brighter. The purpose of this method is to change the brightness level temporarily. To change the default brightness level, use the Power Manager program, or go into **Control Panel → Performance and Maintenance → Power Options** and make changes as desired.

Wireless radio control key (F9)

Press this key to enable or disable the built-in wireless networking features. When you press this key, a list of wireless features is displayed. You can quickly change the state of each feature on the list.

Notes: If you want to use this button to enable or disable the wireless features, the following device drivers must be installed on your computer beforehand:

- Power Management driver
- OnScreen Display Utility
- Wireless device drivers

For detailed information on the wireless features, refer to “Wireless connections” on page 39.

2 Windows key

Press this key to display or hide the **Start** menu.

For information about using the Windows key with other keys, refer to the help information system of the Windows operating system.

Note: Though your keyboard comes with a ThinkLight icon on the space key, the ThinkLight light function is not available on ThinkPad E425 models.

Thinkpad Edge E525 special keys

Your computer has several special keys **1**, **2**, **3**, and **4**. To take advantage of each function, directly press the desired key.

Notes: To use F1-F12 as standard function keys, do either of the following:

- In the keyboard properties window, click the **ThinkPad F1-F12 keys** tab, select **Legacy**, and then click **OK**.
- On the ThinkPad Setup program main menu, select **Config** → **Keyboard/Mouse** → **Change to F1-F12 keys** → **Legacy**.



Volume and mute keys

To quickly adjust the volume of the sound from your computer, mute the sound entirely, set the microphone to mute, or control the video output from the integrated camera, press one of the following keys.

Speaker mute (F1)

Speaker volume down (F2)

Speaker volume up (F3)

If you mute the sound and then turn off your computer, the sound will remain muted when you turn on your computer again. To turn on the sound, press the **Speaker volume up** or **Speaker volume down** keys.

Microphone mute (F4)

Press the microphone mute key to mute or unmute all of the recording devices.

Launching the camera and audio settings (F5)

If you press F5, the camera and audio settings window is opened and the camera preview is turned on. From this window, you can change the camera and audio settings.

Display management keys

Switching the display output location (F6)

Press this key to switch between the computer display and an external monitor. The following options will be displayed:

- Computer display only (LCD)
- Computer display and external monitor (same image)
- Computer display and external monitor (the Extend desktop function)
- External monitor only

Note: To switch between the computer display and an external monitor, the Windows+P key combination is also available.

Display brightness down (F7)

When you press this key, the computer display becomes dimmer. The purpose of this method is to change the brightness level temporarily. To change the default brightness level, use the Power Manager program, or go into **Control Panel → Performance and Maintenance → Power Options** and make changes as desired.

Display brightness up (F8)

When you press this key, the computer display becomes brighter. The purpose of this method is to change the brightness level temporarily. To change the default brightness level, use the Power Manager program, or go into **Control Panel → Performance and Maintenance → Power Options** and make changes as desired.

Wireless radio control key (F9)

Press this key to enable or disable the built-in wireless networking features. When you press this key, a list of wireless features is displayed. You can quickly change the state of each feature on the list.

Notes: If you want to use this button to enable or disable the wireless features, the following device drivers must be installed on your computer beforehand:

- Power Management driver
- OnScreen Display Utility
- Wireless device drivers

For detailed information on the wireless features, refer to “Wireless connections” on page 39.

Windows key

Press this key to display or hide the **Start** menu.

For information about using the Windows key with other keys, refer to the help information system of the Windows operating system.

Numeric keypad

You can use this numeric keypad to input numbers quickly.

Additional shortcut keys

Your computer has four additional shortcut keys above the numeric keypad:

- Launch calculator
- Lock operating system
- Open operating system search
- Open **Computer**

Using the UltraNav pointing device

Your computer comes with the UltraNav pointing device. The UltraNav pointing device consists of the TrackPoint pointing device and the touch pad, each of which is itself a pointing device with both basic and extended functions. You can configure both devices by choosing the settings you prefer, as follows:

- **Set both the TrackPoint pointing device and the touch pad as pointing devices.**

This setting enables the use of all the basic and extended functions of the TrackPoint pointing device and the touch pad.

- **Set the TrackPoint pointing device as the main pointing device and the touch pad for extended functions only.**

This setting enables the use of all basic and extended functions with the TrackPoint pointing device while limiting the use of the touch pad to scrolling, tap zones, and slow-motion pointer functions.

- **Set the touch pad as the main pointing device and the TrackPoint pointing device for the extended functions only.**

This setting enables the use of all basic and extended functions with the touch pad while limiting the use of the TrackPoint pointing device to scrolling and Magnifying Glass functions.

- **Set the TrackPoint pointing device as the main pointing device, and disable the touch pad.**
- **Set the touch pad as the main pointing device, and disable the TrackPoint pointing device.**

Changing the UltraNav settings

On the **UltraNav** tab of the Mouse Properties window, you can change your of UltraNav pointing device settings by clicking **Start → Control Panel → Hardware and Sound → Mouse → UltraNav**.

You can also change the UltraNav pointing device settings by clicking the **UltraNav** icon in the Windows notification area. To display the **UltraNav** icon in the Windows notification area, see “Adding the UltraNav icon in the Windows notification area” on page 34.

Using the TrackPoint pointing device

The TrackPoint pointing device consists of a pointing stick **1** on the keyboard and three click buttons at the bottom of the keyboard. To move the pointer **5** on the screen, you apply pressure to the nonslip cap on the pointing stick in any direction parallel to the keyboard; the pointing stick itself does not move. The speed at which the pointer moves depends on the pressure you apply to the pointing stick. The functions of the left **4** and right **2** click buttons correspond to those of the left and right mouse buttons on a conventional mouse. The TrackPoint center button **3**, called the scroll bar, enables you to scroll Web pages or documents in any direction with no need to use the graphic scroll bars on the side of the window.

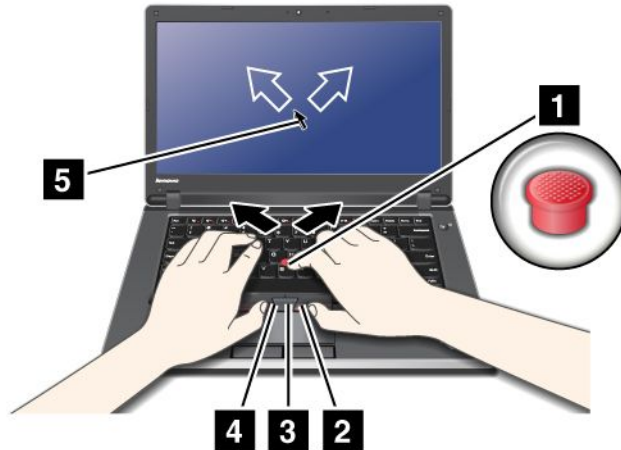

Note: Your computer keyboard might look slightly different from the illustration above.

If you are not familiar with the TrackPoint pointing device, these instructions will help you get started:

1. Place your hands in the typing position, and press gently with an index finger or a middle finger on the pointing stick in the direction in which you want the pointer to move.

To move the pointer, press the pointing stick away from you to move it up, toward you to move it down, to one side or the other to move it sideways.

Note: The pointer might drift. This is not a defect. Stop using the TrackPoint pointing device for a few seconds; the pointer will stop moving.

2. To select and drag as required by your software, press the left or right click button with either thumb and move the TrackPoint pointing stick.

Customizing the TrackPoint pointing device

You can customize the TrackPoint pointing device and its buttons as follows:

- Switch the functions of the left and right buttons.
- Change the sensitivity of the TrackPoint pointing device.
- Enable the Magnifying Glass.
- Enable the TrackPoint scrolling function.
- Enable the TrackPoint Scrolling Tips.

Changing the cap

The cap **1** on the end of the TrackPoint pointing stick is removable. You can replace it as shown in the drawing.

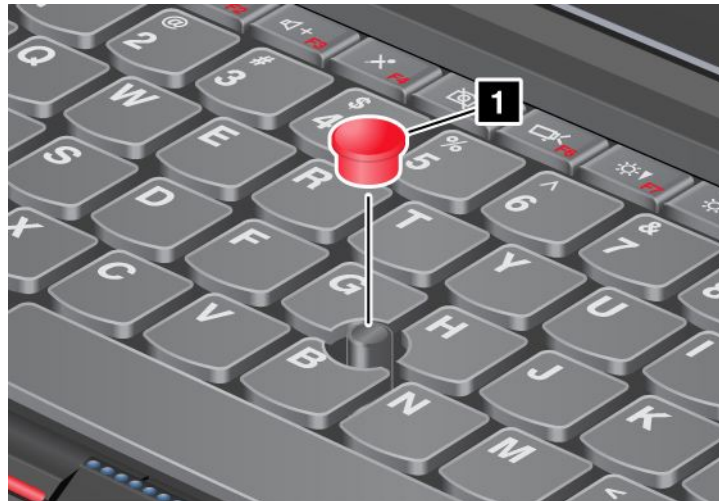

Note: If you replace the keyboard, a new keyboard is shipped with the default cap. If you wish, you can keep the cap from your old keyboard and use it on the new one.

Using the touch pad

The touch pad consists of a pad **1** and two click buttons below the TrackPoint buttons at the bottom of the keyboard. To move the pointer **4** on the screen, slide your fingertip over the pad in the direction in which you want the pointer to move. The functions of the left **3** and right **2** click buttons correspond to those of the left and right mouse buttons on a conventional mouse.

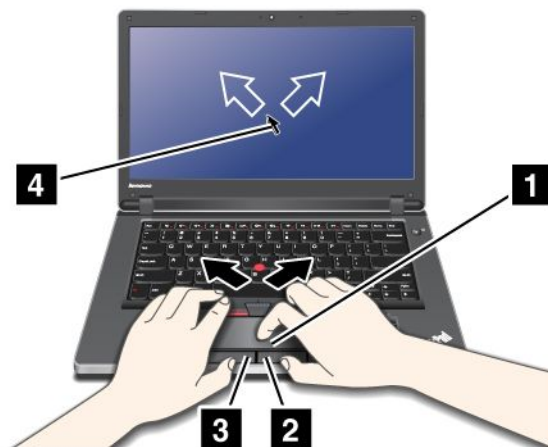

Note: Your computer keyboard might look slightly different from the illustration above.

Using the multi-touch touch pad

The touch pad of your computer supports multi-touch with which you can zoom in, zoom out, scroll, or rotate on the screen while browsing the Internet or reading or editing a document.

For details, refer to the UltraNav help information system.

Customizing the touch pad

To customize the touch pad, do the following:

1. Click **Start**, and then click **Control Panel**.
2. Click **Hardware and Sound**, and then click **Mouse**.
3. Click the **UltraNav** tab and proceed to customize the touch pad.

For details, refer to the ThinkPad Setup help information system.

Using the UltraNav pointing device and an external mouse

If you attach an external mouse to a USB connector, you can use the external mouse simultaneously with the TrackPoint pointing device and the touch pad.

Disabling the TrackPoint pointing device or the touch pad

If you want to disable the TrackPoint pointing device or the touch pad, do the following:

1. Click **Start**, and then click **Control Panel**.
2. Click **Hardware and Sound**, and then click **Mouse**.
3. Click the **UltraNav** tab.
4. To disable the TrackPoint pointing device, clear the check box for **Enable TrackPoint**. To disable the touch pad, clear the check box for **Enable touch pad**.
5. Click **OK**.

Note: You can also open the UltraNav properties window by clicking the UltraNav icon in the Windows notification area. For details, refer to the instructions in “Adding the UltraNav icon in the Windows notification area” on page 34.

Adding the UltraNav icon in the Windows notification area

For easy access to the UltraNav properties, you can enable the display of the **UltraNav** icon in the Windows notification area.

To enable the display of the **UltraNav** icon in the Windows notification area, do the following:

1. Click **Start**, and then click **Control Panel**.
2. Click **Hardware and Sound**, and then click **Mouse**.
3. Click the **UltraNav** tab.
4. Select the check box for **Show UltraNav icon on the system tray**.
5. Click **OK** or **Apply**.

You can now change the properties of UltraNav by clicking the **UltraNav** icon in the Windows notification area.

Power management

When you need to use your computer away from electrical outlets, you depend on battery power to keep your computer running. Different computer components consume power at different rates. The more you use the power-intensive components, the faster you consume battery power.

Spend more time unplugged with ThinkPad batteries. Mobility has revolutionized business by allowing you to take your work wherever you go. With ThinkPad batteries, you will be able to work longer without being tied to an electrical outlet.

Checking battery status

The Power Manager battery gauge on the taskbar displays the percentage of battery power remaining.

The rate at which you use battery power will determine how long you can use the battery of your computer between charges. Because each computer user has different habits and needs, it is difficult to predict how long a battery charge will last. There are two main factors:

- How much energy is stored in the battery when you begin to work.
- The way you use your computer: how often you access the hard disk drive, how bright you make the computer display.

Using the ac power adapter

The power to run your computer can come either from the lithium-ion (Li-ion) battery pack provided with it, or from ac power through the ac power adapter. While you use ac power, the battery charges automatically.

The ac power adapter that comes with your computer has two basic components:

- The transformer pack that converts ac power adapter for use with the computer.
- The power cord that plugs into the ac outlet and into the transformer pack.

Attention: Using an improper power cord could cause severe damage to your computer.

Connecting the ac power adapter

To use the ac power adapter, do the following. Be sure to take these steps in the order in which they are given here.

1. Connect the ac power adapter to the power jack of the computer.
2. Connect the power cord to the transformer pack.
3. Plug the power cord into an electrical outlet.

Tips on using the ac power adapter

- When the ac power adapter is not in use, disconnect it from the electrical outlet.
- Do not bind the power cord tightly around the ac power adapter transformer pack when it is connected to the transformer.
- Before you charge the battery, make sure that its temperature is at least 10 degrees Celsius (50 degrees Fahrenheit).
- You can charge the battery when the ac power adapter is connected to the computer and the battery is installed. You need to charge it in any of the following conditions:
 - When you purchase a new battery
 - If the battery meter at the bottom of your display shows the battery charge is low
 - If the battery has not been used for a long time

Charging the battery

When you check battery status and find that the percentage of power remaining is low or when the power alarm alerts you that the remaining power is low, you need to charge your battery or replace it with a charged battery.

If an ac outlet is convenient, plug the ac power adapter into it, and then insert the jack into the computer. The battery will charge in about 3 to 6 hours. This is affected by the battery size and the physical environment.

The battery status indicator will let you know that the battery is charging, and will also notify you when the battery is fully charged.

Note: To increase the life of the battery, the computer does not start recharging the battery if the remaining power is greater than 95%.

Maximizing battery life

To maximize the life of the battery, do the following:

- Use the battery until the charge is completely depleted; that is, use the battery until the battery status indicator starts blinking orange.
- Recharge the battery completely before using it. The battery is fully charged if the battery indicator shows green when the ac power adapter is plugged in.
- Always use power management features such as power modes, screen blank, sleep, and hibernation.

Managing your battery power

With Power Manager, you can adjust your power settings to give you the best balance between performance and power saving.

For instructions on accessing the Power Manager program, see “Accessing applications” on page 19.

For more information about the Power Manager program, refer to the Power Manager help information system.

Power-saving modes

There are several modes that you can use at any time to conserve power. This section introduces each mode and gives tips on the effective use of the battery power.

Introducing the power-saving modes

- **Screen blank.**

The computer display requires considerable battery power. To turn off power to the display, do the following:

1. Right-click the Power Manager battery gauge on the taskbar.
2. Select **Power off display**.

- **Sleep.**

In sleep mode, your work is saved to memory, and then the hard disk drive and the computer display are turned off. When your computer wakes up, your work is restored within seconds. To put your computer into sleep mode, do the following:

1. Click **Start**.
2. Click the triangle mark on the right side of the **Shut down** icon; then select **Sleep**.

- **Hibernation.**

By using this mode, you can turn off your computer completely without saving files or exiting from any applications that are running. When you enter hibernation, all open applications, folders, and files are saved to the hard disk, and then the computer turns off. To enter hibernation, do the following:

1. Click **Start**.
2. Click the triangle mark on the right side of the **Shut down** icon; then select **Hibernate**.

To resume your session, press the power button for no more than 4 seconds.

When you are not using the wireless features, such as Bluetooth or wireless LAN, turn them off. This will help conserve power. To turn off the wireless features, press **F9**.

Enabling the wakeup function

If you put your computer into hibernation mode, and the wakeup function is disabled (this is the default setting), the computer does not consume any power. If the wakeup function is enabled, it consumes a small amount of power. To enable the function, do the following:

1. Click **Start** → **Control Panel** → **System and Security**.
2. Click **Administrative Tools**.
3. Double-click **Task Scheduler**. If you are prompted for an administrator password or confirmation, type the password or provide confirmation.
4. From the left pane, select the task folder for which you want to enable the wakeup function. The scheduled tasks are displayed.
5. Click a scheduled task, and then click the **Conditions** tab.
6. Under **Power**, select the check box for **Wake the computer to run this task**.

Enabling the battery alarm

You can program your computer so that when the battery power falls below a certain level, three events occur: the alarm goes off, a message is displayed, and the LCD is turned off. To enable the function, do the following:

1. Start Power Manager.
2. Click the **Global Power Settings** tab.
3. For **Low battery alarm** or **Critically low battery alarm**, set the percentage of the power level and set the action.

Note: If your computer enters sleep or hibernation mode when the battery is low, but the alarm message has not yet been displayed, the message will be displayed when the computer resumes. To resume normal operation, click **OK**.

Handling the battery



Do not attempt to disassemble or modify the battery pack.

Attempting to do so can cause an explosion, or liquid leakage from the battery pack.

A battery pack other than the one specified by Lenovo, or a disassembled or modified battery pack is not covered by the warranty.

 **DANGER**

If the rechargeable battery pack is incorrectly replaced, there is danger of an explosion. The battery pack contains a small amount of harmful substances. To avoid possible injury:

- Replace only with a battery of the type recommended by Lenovo.
- Keep the battery pack away from fire.
- Do not expose it to excessive heat.
- Do not expose it to water or rain.
- Do not short-circuit it.
- Store it in a cool dry place.
- Keep it away from children.

The battery pack is a consumable supply.

If your battery begins to discharge too quickly, replace the battery pack with a new one of the type recommended by Lenovo. For more information on replacing the battery pack, contact your Customer Support Center.

 **DANGER**

Do not drop, crush, puncture, or subject to strong forces. Battery abuse or mishandling can cause the battery to overheat, which can cause gasses or flame to “vent” from the battery pack or coin cell. If your battery is damaged, or if you notice any discharge from your battery or the buildup of foreign materials on the battery leads, stop using the battery and obtain a replacement from the battery manufacturer.

 **DANGER**

Only recharge the battery pack strictly according to instructions included in the product documentation.

 **DANGER**

Do not put the battery pack in trash that is disposed of in landfills. When disposing of the battery, comply with local ordinances or regulations and your company's safety standards.

 **DANGER**

There is a danger of an explosion if the backup battery is incorrectly placed. The lithium battery contains lithium and can explode if it is not properly handled, or disposed of. Replace only with a battery of the same type. To avoid possible injury or death, do not: (1) throw or immerse into water, (2) allow it to heat to more than 100°C (212°F), or (3) attempt to repair or disassemble it. Dispose of it as required by local ordinances or regulations and your company's safety standards.

Connecting to the network

Your computer has one or more network cards for connecting to the Internet and to your company's wired LAN or wireless LAN network.

Access Connections is a connectivity assistant program for creating and managing location profiles. Each location profile stores all the network and Internet configuration settings needed for connecting to a network infrastructure from a specific location such as a home or an office.

Ethernet connections

You can connect to your network or a broadband connection, such as DSL or CATV, by use of the Ethernet feature built into your computer. This feature enables you to do 1Gbps half or full duplex data transmission.

To connect to a network through Ethernet, you can use Access Connections.



Your computer has an Ethernet connector. To avoid the risk of electrical shock, do not connect the telephone cable to the Ethernet connector.

Wireless connections

Wireless connection is the transfer of data without the use of cables by means of radio waves only.

Depending on the frequency used for data transmission, the area covered, or the type of the device used for data transfer, the following categories of wireless networks might be available to you:

Wireless LAN

A wireless LAN covers a relatively small geographic area, such as an office building or a house. Devices based on the 802.11 standards can connect to this network.

Bluetooth

Bluetooth is one of a number of technologies used to create a wireless personal area network. Bluetooth can connect devices a short distance from one another, and is commonly used for connecting peripheral devices to a computer, transferring data between hand-held devices and a personal computer, or remotely controlling and communicating with devices such as mobile phones.

Making wireless LAN connections

Your computer comes with a built-in wireless network card and a configuration utility to help you make wireless connections and monitor the status of your connection, so that you can stay connected to your network while you are in the office, in a meeting room, or at home, with no need for a wired connection.

Attention:

- If you carry your computer with the wireless LAN feature into an airplane, check the services with the airline before boarding the airplane.
- If there are restrictions on the use of computers on an airplane with the wireless feature, you need to disable it before boarding. To disable it, refer to the instructions in “Enabling or disabling the wireless feature” on page 41.

Note: You can purchase a wireless network card as an option. For more information, refer to “Finding ThinkPad options” on page 135.

Tips for using the wireless LAN feature

- Place your computer so that there are as few obstacles as possible between the wireless LAN access point and the computer.
- For the best connection of the wireless LAN feature, open your computer display to an angle of slightly more than 90 degrees.
- If you use the wireless feature (the 802.11 standard) of your computer simultaneously with a Bluetooth option, data transmission speed can be delayed and the performance of the wireless feature can be degraded.

Wireless networking setup

To use the built-in wireless network card (the 802.11 standard) to communicate, start Access Connections.

Note: Before you start setting up wireless networking connections by using Access Connections, obtain a Network Name (SSID) and your encryption information from your network administrator.

Access Connections, a connectivity assistant program, can easily enable one network card and disable the other cards on demand. After setting up your wireless networking connection, you can use the program to quickly switch the network settings.

Using Bluetooth

If your computer is equipped with the Integrated Bluetooth features, you can enable or disable the features by pressing F9. If you press F9, a list of wireless features is displayed. You can enable or disable the Bluetooth features with a single click.

To configure a Bluetooth device or manage connection settings, you can use **Bluetooth Devices** in Control Panel. To access Bluetooth Devices in Control Panel, click **Start → Control Panel → Hardware and Sound → Devices and Printers**.

To send data to a Bluetooth-enabled device, do the following:

1. Right-click the data that you want to send.
2. Select **Send To → Bluetooth Devices**.

For details, refer to the Windows help information system.

Note: If you use the wireless feature (the 802.11 standard) of your computer simultaneously with a Bluetooth option, data transmission speed can be delayed and the performance of the wireless feature can be degraded.

Checking wireless connection status

You can check your computer wireless connection status through the Access Connections gauge on the taskbar, or through the Access Connections icon and wireless status icon on the taskbar.





Access Connections Gauge

The Access Connections gauge on the taskbar displays the signal strength and status of your wireless connection.

Note: To display the Access Connections gauge on the taskbar, see the Access Connections help information system.

You can find more detailed information about the signal strength and status of your wireless connection by opening Access Connections or by right-clicking the Access Connections gauge on the taskbar and selecting **View Status of Wireless Connection**.

Access Connections gauge states: wireless LAN

-  Power to the wireless radio is off or no signal.
-  Power to the wireless radio is on. The signal strength of the wireless connection is poor. To improve signal strength, move your system closer to the wireless access point.
-  Power to the wireless radio is on. The signal strength of the wireless connection is marginal.
-  Power to the wireless radio is on. The signal strength of the wireless connection is excellent.

Note: For more information about the Access Connections Gauge, see the Access Connections help information system.









Access Connections icon and wireless status icon

The Access Connections icon displays general connection status.

The wireless status icon displays the signal strength and status of your wireless connection.

You can find more detailed information about the signal strength and status of your wireless connection either by opening Access Connections or by double-clicking the Access Connections wireless status icon on the taskbar.

Note: To display the Access Connections icon and wireless status icon, click **Show hidden icons** on the taskbar. To add the icons to the taskbar permanently, click **Customize** and proceed to customize the settings. For more information about the icons, see the Access Connections help information system.

- Access Connections icon states
 -  No location profile is active or none exists.
 -  Current location profile is disconnected.
 -  Current location profile is connected.
- Wireless status icon states: wireless LAN
 -  Power to the wireless radio is off.
 -  Power to the wireless radio is on. No association.
 -  Power to the wireless radio is on. No signal.
 -  Power to the wireless radio is on. The signal strength of the wireless connection is excellent.
 -  Power to the wireless radio is on. The signal strength of the wireless connection is marginal.
 -  Power to the wireless radio is on. The signal strength of the wireless connection is poor. To improve signal strength, move your system closer to the wireless access point.

Note: If you have trouble in making a connection, try moving your computer closer to your wireless access point.

Enabling or disabling the wireless feature

To enable or disable the wireless feature, press F9. A list of wireless features is displayed. You can turn the feature on and off with a single click.

You can also enable or disable the feature by the following procedures.

To enable the wireless feature, do the following:

1. Click the Access Connections wireless status icon in the Windows notification area.
2. Click **Power On Wireless Radio**.

To disable the wireless feature, do as follows:

1. Click the Access Connections wireless status icon in the Windows notification area.
2. Click **Power Off Wireless Radio**.

Note: Click **Show hidden icons** on the task bar and the Access Connections wireless status icon is displayed. To add it to the taskbar permanently, click **Customize** and proceed to customize the settings. For more information about the icon, see the Access Connections help information system.

Using a projector or an external display

Your computer comes with many features to increase the enjoyment of your computer and help you give presentations with confidence.

Changing display settings

You can change the display settings, such as font size or color mode or numeric lock.

Font size

To make a font size larger, do the following:

1. Right-click on the desktop, and click **Personalize**.
2. Click **Display** at the left.
3. Select the **Medium** or **Larger** radio button.
4. Click **Apply**. The change will take effect after you log off.

Connecting a projector or an external display

This topic provides information about connecting a projector or an external display.

Attaching an external monitor

Your computer can support a maximum video resolution of up to 2048x1536, provided that the external monitor also supports that resolution. For more details, refer to the manuals provided with your monitor.

You can set any resolution for either the computer display or the external monitor. When you use both at the same time, the resolution of both is the same. If you set a higher resolution for the computer display, you can see only part of the screen at a time. You can see other parts by moving the image with the TrackPoint pointing device or another pointing device.

You can move the display output to the computer display, the external monitor, or both in the Display Settings window.

Connecting an external monitor

To attach an external monitor, do the following:

1. Connect the external monitor to the monitor connector; then connect the monitor to an electrical outlet.
2. Turn on the external monitor.
3. Change the display output location by pressing F6. This enables you to switch between viewing output on the external display, the computer display, and both displays.

Note: If your computer cannot detect the external monitor, right-click on the desktop, then select **Screen resolution**. Click the **Detect** button.

Setting the monitor types

To set your monitor type, do the following:

1. Connect the external monitor to the monitor connector, and then connect the monitor to an electrical outlet.
2. Turn on the external monitor.
3. Right-click on the desktop, and click **Screen resolution**.

Note: If your computer cannot detect the external monitor, click the **Detect** button.

4. Click the icon for the desired monitor (the **Monitor-2** icon is for the external monitor).
5. Set **Resolution**.
6. Click **Advanced Settings**.
7. Click the **Monitor** tab. Check the monitor information window to make sure that the monitor type is correct. If it is, click **OK** to close the window; otherwise do the following:
8. If more than two monitor types are displayed, select **Generic PnP Monitor** or **Generic Non-PnP Monitor**.
9. Click **Properties**. If you are prompted for an administrator password or confirmation, type the password or provide confirmation.
10. Click the **Driver** tab.
11. Click **Update Driver**.
12. Click **Browse my computer for driver software**, and then click **Let me pick from a list of device drivers on my computer**.
13. Clear the **Show compatible hardware** check box.
14. Select **Manufacturer** and **Model** for your monitor. If you cannot find your monitor on the list, stop the installation of this driver and use the driver shipped with your monitor.
15. After updating the driver, click **Close**.
16. Click **OK**.

Note: To change the color settings, right-click on the desktop, and click **Screen resolution**. Click **Advanced Settings**, select the **Monitor** tab, then set **Colors**.

Considerations for attaching an external monitor

- When installing an operating system, you must install the display driver for your monitor that is supplied with the computer, and the monitor INF file that is supplied with the external monitor.
- If you set a resolution higher than the resolution you are using on the panel, and use a panel that does not support that resolution, take advantage of the virtual screen function, which enables you to display only a part of the high-resolution screen image your computer produces. You can see other parts of the image by moving the screen with the TrackPoint pointing device or another pointing device.

Note: The virtual screen function is not supported.

- If the external monitor you are using is outdated, the resolution and the refresh rate might be limited.

Using dual displays

This section introduces the Extend desktop function that enables you to display output (the same or different) on both the computer display and an external monitor.

Using the Extend desktop function

Your computer supports a function named the Extend desktop. With the Extend desktop function, you can display output on both the computer display and an external monitor. You can also display different desktop images on each monitor.

You can use the Extend desktop function without changing any settings. If the function does not work, refer to “Enabling the Extend desktop function” on page 44 to enable it.

Considerations for using the Extend desktop function

- If you want to show DOS full-screen while in the Extend desktop mode, only the primary display shows DOS; the other display is blacked out.

If your computer has the AMD® display adapter, you can designate the other display as the primary display by doing the following:

1. Right-click on the desktop, then select **Screen resolution**.
 2. Select **Extend these displays** in **Multiple Displays**.
 3. Change the setting to designate the primary display.
- When an application using DirectDraw or Direct3D is played in full-screen mode, it is shown only on the primary display.
 - You cannot use the display switching function when you are in the Extend desktop mode.

Enabling the Extend desktop function

To enable the Extend desktop function, do the following:

1. Connect the external monitor to the monitor connector; then connect the monitor to an electrical outlet.
2. Turn on the external monitor.
3. Press F6, then select **Extend**.

To change the resolution for each monitor, do the following:

1. Right-click on the desktop, and click **Screen resolution**.
2. Click the **Monitor-1** icon (for the primary display, the computer display).
3. Set the resolution for the primary display.
4. Click the **Monitor-2** icon (for the secondary display, the external display).
5. Set the resolution for the secondary display.
6. Place the icons for the monitors so that they touch.

Note: You can set the monitors in any relative position, but the icons must touch each other.

7. Click **OK** to apply the changes.

Note: To change the color settings, right-click on the desktop, and click **Screen resolution**. Click **Advanced Settings**, select the **Monitor** tab, then set **Colors**.

Using audio features

Your computer is equipped with the following:

- Combo audio jack, 1/8 inch (3.5 mm) in diameter
- Built-in stereo speakers
- Built-in monaural digital microphone

Your computer also has an audio chip that enables you to enjoy various multimedia audio features:

- Compliant with Intel High Definition Audio
- Recording and playback of PCM and WAV files in 16-bit or 24-bit format
- Playback of a WAV file at a sample rate of 44.1KHz to 192 KHz
- Playback of MIDI files through a Wave table synthesizer under Microsoft Windows operating systems
- Playback of MP3 files through the Windows Media Player or a software MP3 player
- Recording from various sound sources

Note: The combo audio jack does not support a conventional microphone. If a conventional headphone is attached to it, the headphone function is supported. If a headset with a 3.5mm 4-pole plug is attached to it, both headphone and microphone functions are supported.

The following table shows which functions of the audio devices attached to the jacks on your computer are supported.

Table 3. Audio feature list

Jack	Headset with a 3.5 mm 4-pole plug	Conventional headphone	Conventional microphone
Combo audio jack	Headphone and microphone functions supported	Headphone function supported	Not supported

Configuring for sound recording

For instructions on configuring the microphone for optimized sound recording, open the SmartAudio window and click **Start → Control Panel → Hardware and Sound → SmartAudio**. The SmartAudio window opens.

Using an integrated camera

If your computer has an integrated camera, when you press F5 to open the Communications settings window, the camera will be launched and the green camera-in-use indicator will turn on automatically. In the Communications settings window, you can preview your video image and take a snapshot of your current image.

You can also use the integrated camera with other programs that provide features such as photographing, video capturing, and video conferencing. To use the integrated camera with other programs, open one of the programs and start the photographing, video capturing, or videoconferencing function. Then, the camera will start automatically and the green camera-in-use indicator will turn on. For more information about using the camera with a program, refer to the documentation that came with the program.

If you do not want the camera to be launched automatically when you press F5 or when you use a program, press F5 to open the Communications settings window and click the **Hide my camera image** button to disable the camera.

Configuring camera settings

You can configure the camera settings to meet your needs, such as adjusting the quality of the video output.

To configure the camera settings, do the following:

1. Press F5. The Communications settings window opens.
2. Click the **Manage Settings** button. The Communications Utility window opens.
3. In the Communications Utility window, configure the camera settings depending on your individual needs.

Using the optical drive

Note: Your computer only supports the MultiBurner drive.

MultiBurner drive

This drive can read DVD-ROM discs, DVD-R discs, DVD-RAM discs, DVD-RW discs, and all types of CDs, such as CD-ROM discs, CD-RW discs, CD-R discs, and audio CDs. In addition, it can record on DVD-R discs, DVD-RW discs, type II DVD-RAM discs, CD-RW standard and high speed discs, and CD-R discs.

Using a flash media Card

Your computer has one Media Card Reader slot.

The Media Card Reader slot supports the following four types of cards:

- SD cards
- SDHC cards
- SDXC cards
- MultiMediaCards

Note: When transferring data to or from a media card, such as an SD card, do not put your computer in sleep or hibernation mode before the data transfer is complete. To do so might cause damage to your data.

For more information on flash media cards, refer to any of the following topics:

- “Inserting a flash media card” on page 46
- “Removing a flash media card” on page 47

Inserting a flash media card

Attention: Before you start installing any of the following cards, touch a metal table or a grounded metal object. This action reduces any static electricity from your body. The static electricity could damage the card.

- SD card
- SDHC card
- SDXC card
- MultiMediaCard

To insert a flash media card into the 4-in-1 media card reader slot, do the following:

1. Make sure that the card is correctly oriented.
2. Insert the card firmly into the 4-in-1 media card reader slot. The card might stop before it is completely installed into the slot.

If the flash media card is not Plug and Play, do the following:

1. Click **Start** → **Control Panel** → **Hardware and Sound** → **Device Manager**. If you are prompted for an administrator password or confirmation, type the password or provide confirmation.
2. From the **Action** menu, select **Add legacy hardware**. The Add Hardware Wizard starts.
3. Follow the instructions on the screen.

Removing a flash media card

To remove a flash media card, do the following:

1. Click **Show hidden icons** on the taskbar.
2. Right-click the **Safely Remove Hardware and Eject Media** icon.
3. Select the corresponding item to eject the card from the Windows operating system.
4. Press the card to eject it from your computer.
5. Remove the card from your computer and store it safely for future use.

Note: If you do not remove the card from your computer after you eject the card from the Windows operating system, the card can no longer be accessed. To access the card, you must remove it once, then insert it again.

Chapter 3. You and your computer

This chapter provides information about accessibility, comfort, and travelling with your computer.

This chapter contains the following topics:

- “Accessibility and comfort” on page 49
- “Traveling with your computer” on page 51

Accessibility and comfort

Good ergonomic practice is important to get the most from your personal computer and to avoid discomfort. Arrange your workplace and the equipment you use to suit your individual needs and the kind of work that you perform. In addition, use healthy work habits to maximize your performance and comfort while using your computer.

The following topics provide information about arranging your work area, setting up your computer equipment, and establishing healthy work habits.

Lenovo is committed to providing the latest information and technology to our customers with disabilities. Refer to our accessibility information which outlines our efforts in this area.

Ergonomic information

Working in the virtual office might mean adapting to frequent changes in your environment. Following some simple rules will make things easier and bring you the maximum benefits of your computer. Keeping in mind such basics as good lighting and proper seating, for example, can help you improve your performance and achieve greater comfort.

Note: This example shows someone in a conventional setting. Even when not in such a setting, you can follow many of these tips. Develop good habits, and they will serve you well.

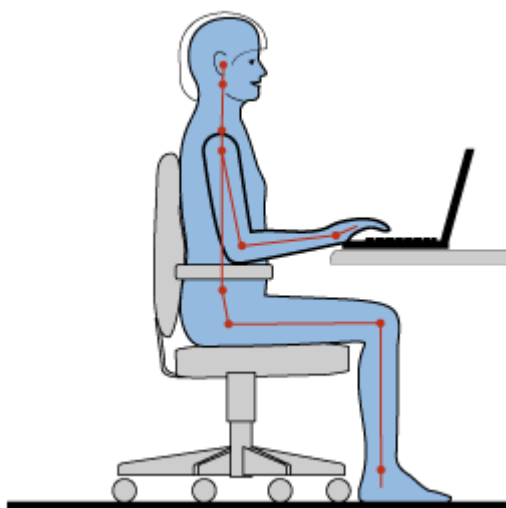

General posture: The following are some general recommendations for assuming a healthy working posture. It is best to periodically make minor modifications in your working posture to deter the onset of discomfort

caused by long periods of working in the same position. Frequent, short breaks from your work will also help to prevent any minor discomfort associated with your working posture.

Display: Position the display to maintain a comfortable viewing distance of 510-760 mm (20-30 inch). Avoid glare or reflections on the display from overhead lighting or outside sources of light. Keep the display screen clean and set the brightness to levels that enable you to see the screen clearly. Press Fn+Home or End to adjust display brightness.

Head position: Keep your head and neck in a comfortable and neutral (vertical, or upright) position.

Chair: Use a chair that gives you good back support and seat height adjustment. Use chair adjustments to best suit your desired posture.

Arm and hand position: If available, utilize chair arm rests or an area on your working surface to provide weight support for your arms. Keep your forearms, wrists, and hands in a relaxed and neutral (horizontal) position. Type with a soft touch without pounding the keys.

Leg position: Keep your thighs parallel to the floor and your feet flat on the floor or on a footrest.

What if you are traveling?

It might not be possible to observe the best ergonomic practices when you are using your computer while on the move or in a casual setting. Regardless of the setting, try to observe as many of the tips as possible. Sitting properly and using adequate lighting, for example, will help you maintain desirable levels of comfort and performance.

Questions about vision?

The visual display screens of ThinkPad notebook computers are designed to meet the highest standards and to provide you with clear, crisp images and large, bright displays that are easy to see, yet easy on the eyes. Of course, any concentrated and sustained visual activity can be tiring. If you have questions on eye fatigue or visual discomfort, consult a vision care specialist for advice.

Adjusting your computer to fit you

Refer to the following tips to improve performance and achieve greater comfort:

Active sitting and rest breaks: The longer you sit and work with your computer the more important it is to observe your working posture. Following the instructions in “Ergonomic information” on page 49 and practicing “active sitting” are the best ways to avoid discomfort associated with your working postures. Making minor voluntary postural changes and taking short frequent work breaks are the key ingredients for healthy computing. Your computer is a light and mobile system; remember that it can easily be repositioned on your working surface to accommodate many posture modifications you might wish to make.

Work area setup options: Familiarize yourself with all of your office furniture so that you know how to adjust your work surface, seat, and other work tools to accommodate your preferences for comfort. If your work area is not in an office setting, be sure to take special note of employing active sitting and utilizing work breaks. Note that there are many ThinkPad product solutions available to help you modify and expand your computer to best suit your needs. Access the following Web site to view some of these options: <http://www.lenovo.com/accessories/services/index.html>. Explore your options for docking solutions and external products that can provide the adjustability and features that you want.

ThinkPad features that promote comfort: There are easy-to-use ThinkPad features that can help make your computer more comfortable to use.

Accessibility information

Lenovo is committed to providing people with disabilities greater access to information and technology. As a result, the following information provides ways to help users that have hearing, vision, and mobility limitations get the most out of their computer experience.

Assistive technologies enable users to access information in the most appropriate way. Some of these technologies are already provided in your operating system, others can be purchased through vendors, or accessed through the World Wide Web <http://www.lenovo.com/healthycomputing>.

Assistive technologies

Some accessibility technologies are available through the Accessibility Options program. Depending on your operating system, the number of accessibility options available varies. In general, accessibility options enhance the way users with hearing, vision, or mobility limitations navigate and use their computer. For example, some users might not have the fine motor skills required to use a mouse or select key combinations. Other users might require larger fonts or high-contrast display modes. In some cases, magnifiers and built-in speech synthesizers are available. For detailed information about each of these features, consult the Microsoft help information system.

To use the Accessibility Options program, click **Start → Control Panel → Ease of Access → Ease of Access Center**.

This help information system supports the accessibility features provided by your Windows operating system, screen readers designed to operate in the Windows environment, and Windows keyboard navigation. For a complete listing of Microsoft Windows Keyboard Guide, go to: <http://www.microsoft.com/enable/Products/altkeyboard.aspx>

Screen reader technologies are primarily focused on software application interfaces, help information systems, and a variety of online documents. However, in the case where a screen reader cannot read documents, the document must first go through a conversion process. One solution converts Adobe PDF files into a format that is read by the screen-reader programs. This solution is a Web-based service provided by Adobe Systems Incorporated. Through <http://access.adobe.com>, Adobe PDF documents can be converted to HTML or plain text in many languages. One conversion option converts PDF documents on the Internet. A second option enables users to submit the URL of an Adobe PDF file through e-mail to convert it to HTML or ASCII text. Adobe PDF files on a local hard disk drive, local CD-ROM, or LAN can also be converted by attaching the Adobe PDF file to an e-mail message.

Traveling with your computer

This topic provides information to help you work with your computer when you are travelling with your computer abroad.

Travel tips

Use the following travel tips to travel more confidently and efficiently with your computer.

1. While it is safe to allow your computer to go through the x ray machines at airport security stations, it is important to keep your eyes on the computer at all times to prevent theft.
2. Consider bringing an airplane or automobile adapter for your computer.
3. If you carry an ac power adapter, detach the ac cord from it to avoid damaging the cord.

Travel tips on airplanes

If you carry your computer into an airplane, check the travel tips.

Attention:

- For using onboard computer or wireless (such as Internet, *Bluetooth*, etc.) service, check the services with the airline before boarding the airplane.
- If there are restrictions on the use of computers with the wireless feature on an airplane, you need to disable it before boarding. To disable it, refer to the instructions in “Enabling or disabling the wireless feature” on page 41.

Follow the tips below:

1. Be careful about the seat in front of you on airplanes. Angle your computer display so that it does not get caught when the person in front of you leans back.
2. Remember to hibernate or turn off your computer when taking off.

Travel accessories

The following is a checklist of things to consider packing when you are going to be out of the office:

Travel essentials

- ThinkPad ac power adapter
- External mouse, if you are accustomed to using one
- Ethernet cable
- Standard phone cable and modular jack (RJ-11)
- Extra battery, charged
- A quality carrying case that provides adequate cushion and protection

If you are traveling to another country, you might want to consider the following:

- An ac power adapter for the country that you are traveling to

Other items you might wish to consider:

- ThinkPad AC/DC Combo Adapter
- External storage device

Chapter 4. Security

This chapter provides information about how to protect your computer from theft and unauthorized use.

- “Attaching a mechanical lock” on page 53
- “Using passwords” on page 53
- “Hard disk security” on page 58
- “Using a fingerprint reader” on page 58
- “Notice on deleting data from your hard disk drive” on page 60
- “Using firewalls” on page 61
- “Protecting data against viruses” on page 61

Attaching a mechanical lock

You can attach a mechanical lock to your computer, to help prevent it from being removed without your permission.

Attach a mechanical lock to the keyhole of the computer; then secure the chain on the lock to a stationary object. Refer to the instructions shipped with the mechanical lock.

Note: You are responsible for evaluating, selecting, and implementing the locking devices and security features. Lenovo makes no comments, judgments, or warranties about the function, quality, or performance of locking devices and security features.

Using passwords

By using passwords, you can help prevent your computer from being used by others. Once you set a password, a prompt appears on the screen each time you power on the computer. Enter your password at the prompt. You cannot use the computer unless you type the correct password.

Make sure that only authorized individuals access your computer. Establishing different kinds of passwords requires that other possible users know the proper passwords in order to access your computer or your data.

Click on the items below to find out more about passwords and how to use them to protect your computer.

- “Passwords and sleep mode” on page 53
- “Typing passwords” on page 54
- “Power-on password” on page 54
- “Hard disk security” on page 58
- “Supervisor password” on page 56

Passwords and sleep mode

If you have set passwords and you put your computer into sleep mode, the procedure for resuming operation is as follows:

- You are not prompted to type the password when resuming operation.
- If any hard disk drive has a hard disk password, it is unlocked automatically when you resume operation.

Note: If a Windows password has been set, you will be prompted to enter it.

Typing passwords



If this icon is displayed, type a power-on password or a supervisor password.



If this icon is displayed, type a user hard disk password. If you want to type a master hard disk password, do the following:

1. Press F1. The icon changes to this: 
2. Now type the master hard disk password.

Note: To return to the first icon, press F1 again.



If this icon is displayed, type a supervisor password.

Note: You can press Backspace if you press a wrong key while you are typing your password.

Power-on password

You can set a power-on password to help protect your computer against access by unauthorized users.

If you set a power-on password, the password prompt appears on the screen whenever you turn on the computer. You must enter the correct password to start using the computer.

Setting a power-on password

1. Print these instructions.
2. Save all open files, and exit all applications.
3. Turn your computer off and then turn it on again.
4. When the logo screen is displayed, press F1. The ThinkPad Setup program main menu opens.
5. Select **Security**, using the cursor directional keys to move down the menu.
6. Select **Password**.
7. Select **Power-on Password**.
8. Choose your power-on password, and type it within the brackets in the **Enter New Password** field.

Note: You can set the minimum length of a power-on password. For details, refer to “Security menu” on page 97.

9. Press Enter once to move to the next line. Retype the password you just entered, to verify it.
10. Commit your password to memory.

Note: You might want to note your power-on password in a safe place. Otherwise, if you forget it, you have to take your computer to a Lenovo reseller or a marketing representative to have the password canceled.

11. Press F10 to exit.
12. Select **Yes** in the Setup Notice window.

Changing or removing the power-on password

To change the power-on password, follow the steps 1 through 7. Enter your current password. When the **Enter New Password** field opens, type a new password in the field and then retype it to verify. To remove

the password, follow steps 1 through 7. Type your current password. When the **Enter New Password** field opens, leave it blank and press Enter twice.

Hard disk passwords

Two types of hard disk passwords help protect the information stored on the hard disk drive:

- User hard disk password
- Master hard disk password, which requires a user hard disk password

If a user hard disk password has been set, but no master hard disk password has been, the user must enter the user hard disk password in order to gain access to files and applications on the hard disk.

The master password can be set and used only by a system administrator. Like a master key, it enables the administrator to get access to any hard disk drive in a system. The administrator sets the master password; no one else knows it. Then the administrator sets a user password for each computer in the network, and tells each user the password for his or her computer. The user can then change the user password as desired, but the administrator can still get access by using the master password.

Setting a hard disk password

1. Print these instructions.
2. Save all open files, and exit all applications.
3. Turn your computer off and then on again.
4. When the logo screen is displayed, press F1. The ThinkPad Setup program main menu opens.
5. Select **Security**, using the cursor directional keys to move down the menu.
6. Select **Password**.
7. Select **Hard Disk 1 Password**.
8. A password window opens. You are prompted to select **User** or **User + Master**. Select **User** if you want to set only one hard disk password. If you are an administrator or supervisor, you can select **User + Master** to set two passwords. (The user can change the user password later.)
9. If you select **User + Master**, go to step 12.
10. If you select **User** only, a window for typing the new password opens. Type your new password in the **Enter New Password** field.

Note: You can set the minimum length of a hard disk password. For details, refer to “Security menu” on page 97.

11. Press Enter once to move to the next line. Retype the password you just entered to verify it. Go to step 18 to complete the procedure.
12. If you select **User+ Master**, a message window opens and prompts you to set up a user hard disk password first. Click **Continue**.
13. A window for typing the new user hard disk password opens. Type your new password in the **Enter New Password** field.
14. Press Enter once to move to the next line. Retype the password you just entered to verify it.
15. A message window opens and prompts you to set the master hard disk password. Click **Continue**.
16. A window for typing the new master hard disk password opens. Type your new password in the **Enter New Password** field.
17. Press Enter once to move to the next line. Retype the password you just entered to verify it.
18. Commit any password to memory.

Attention: You might want to note your passwords and keep them in a safe place. Otherwise, if you forget the user password, or both user and master passwords, Lenovo cannot reset your passwords or recover data from the hard disk drive. You must take your computer to a Lenovo reseller or a marketing representative to have the hard disk drive replaced. Proof of purchase is required, and a fee will be charged for parts and service.

19. Press F10 to exit. In the Setup Notice window, select **Yes**.

The next time you turn on your computer, you will have to type the user or master hard disk password in order to start your computer and get access to your operating system.

Changing or removing a hard disk password

Follow steps 1 through 7 in “Setting a hard disk password” on page 55, typing your password to get access to the ThinkPad Setup program.

To change or remove the User hard disk password, do the following:

- To change the hard disk password, type the current password in the **Enter Current Password** field. Then type the new password in the **Enter New Password** field, and retype the password you just entered to verify it in the **Confirm New Password** field. Press Enter, and a Setup Notice window is displayed. Press F10 to exit from the Setup Notice window. The user hard disk passwords will be changed.
- To remove the hard disk password, type the current password in the **Enter Current Password** field. Then leave the **Enter New Password** and **Confirm New Password** fields blank, and press Enter. A Setup Notice window is displayed. Press F10 to exit from the Setup Notice window. The user hard disk passwords will be removed.

To change or remove the **User + Master** hard disk password, select **User HDP** or **Master HDP**.

If you choose **User HDP**, do one of the following:

- To change the user hard disk password, type the current user hard disk password or the current master hard disk password in the **Enter Current Password** field. Then type the new user hard disk password in the **Enter New Password** field, and retype the password you just entered to verify it in the **Confirm New Password** field. Press Enter, and a Setup Notice window is displayed. Press F10 to exit from the Setup Notice window. Both the user and master hard disk passwords will be changed.
- To remove the user hard disk password, type the current master hard disk password in the **Enter Current Password** field. Then leave the **Enter New Password** and **Confirm New Password** fields blank, and press Enter. A Setup Notice window is displayed. Press F10 to exit from the Setup Notice window. Both the user and master hard disk passwords will be removed.

If you choose **Master HDP**, do one of the following:

- To change the master hard disk password, type the current master hard disk password in the **Enter Current Password** field. Then type the new master hard disk password in the **Enter New Password** field, and retype the password you just entered to verify it in the **Confirm New Password** field. Press Enter, and a Setup Notice window is displayed. Press F10 to exit from the Setup Notice window. Both the user and master hard disk passwords will be changed.
- To remove the master hard disk password, type the current master hard disk password in the **Enter Current Password** field. Then leave the **Enter New Password** and **Confirm New Password** fields blank, and press Enter. A Setup Notice window is displayed. Press F10 to exit from the Setup Notice window. Both the user and master hard disk passwords will be removed.

Supervisor password

The supervisor password protects the system information stored in the ThinkPad Setup program. Without it, no one can change the configuration of the computer. It provides the following security features:

- If a supervisor password is set, a password prompt appears when you try to start the ThinkPad Setup program. Unauthorized users cannot get access to configuration data.
- The system administrator can use the supervisor password to get access to a computer even if the user of that computer has set a power-on password. The supervisor password overrides the power-on password.
- If both a supervisor password and a power-on password are set, you can do the following only if you have the supervisor password:
 - Deleting the power-on password
 - Changing or deleting the supervisor password
 - Enabling or disabling the Internal Network Option ROM feature
 - Changing date and time
 - Enabling or disabling the Lock UEFI BIOS Setting feature
 - Enabling or disabling the Password at unattended boot feature
 - Specifying the minimum length for power-on passwords and hard disk passwords
 - Enabling or disabling the Boot Device List F12 Option feature
 - Enabling or disabling the Boot Order Lock feature
 - Enabling or disabling the Flash BIOS Updating by End-Users feature
 - Enabling or disabling the internal Network device
 - Enabling or disabling the internal Wireless device
 - Enabling or disabling the internal Bluetooth device
 - Enabling or disabling the Security mode
 - Enabling or disabling the fingerprint reader priority
 - Erasing the fingerprint data

Notes:

- The system administrator can set the same supervisor password on many ThinkPad notebook computers to make administration easier.
- By enabling the Lock UEFI BIOS Settings on the **Password** menu when you set the supervisor password, you make it impossible for anyone but you to make changes.

Setting, changing, or removing a supervisor password

Only a system administrator will be able to apply this procedure.

1. Print these instructions.
2. Save all open files, and exit all applications.
3. Turn your computer off and then turn it on again.
4. When the logo screen is displayed, press F1. The ThinkPad Setup program main menu opens.
5. Select **Security**, using the cursor directional keys to move down the menu.
6. Select **Password**.
7. Select **Supervisor Password**.
8. A window opens, prompting you to enter a new password. Depending on your needs, do one of the following:
 - To set a password, do the following:
 - a. Choose your supervisor password and type it in the **Enter New Password** field; then press Enter.
 - b. Press Enter to move to the next line. Retype the password you just entered to verify it.

- To change a password, do the following:
 - a. In the **Enter Current Password** field, type the current supervisor password.
 - b. In the **Enter New Password** field, type the new supervisor password; then retype the password you just entered to verify it in the **Confirm New Password** field.
 - To remove a password, do the following:
 - a. In the **Enter Current Password** field, type the current supervisor password.
 - b. Leave the **Enter New Password** and **Confirm New Password** fields blank.
9. Commit your password to memory and press Enter. A Setup Notice window is displayed.

Attention: You might want to note your password and keep it in a safe place. If you forget your supervisor password, Lenovo cannot reset your password. You must take your computer to a Lenovo reseller or a Lenovo marketing representative to have the system board replaced. Proof of purchase is required, and a fee will be charged for parts and service.

10. Press F10 to exit from the Setup Notice window.

The next time you open the ThinkPad Setup program, you will be prompted to type your password to proceed.

Hard disk security

Your computer supports an enhanced security solution for hard disk drive. To protect passwords from unauthorized security attacks, several of the latest technologies and algorithms are integrated into UEFI BIOS and hardware design of ThinkPad notebook computers.

To maximize security, do the following:

1. Set a power-on password as well as a hard disk password for your internal hard disk drive. Refer to the procedures in “Power-on password” on page 54 and “Hard disk passwords” on page 55. For enhanced security, a strong password is recommended.
2. If a Disk Encryption hard disk drive is installed in your computer, be sure to protect the contents of your computer memory from unauthorized access by use of drive encryption software.
3. Before you dispose of, sell, or hand over your computer, make sure to delete data stored on it. Refer to “Notice on deleting data from your hard disk drive” on page 60.

Note: The hard disk drive built into your computer can be protected by UEFI BIOS.

Disk Encryption hard disk drive

Some models contain the Disk Encryption hard disk drive. This feature helps to protect your computer against security attacks on media, NAND flash, or device controllers by use of a hardware encryption chip. For the efficient use of the encryption feature, be sure to set a password for the internal storage device. Refer to Hard disk passwords.

Using a fingerprint reader

Your computer might have an integrated fingerprint reader. Fingerprint authentication can replace passwords and enable simple and secure user access. By enrolling your fingerprint and associating it with a Windows password you can log on to the computer by swiping your finger over the reader, without typing passwords.

Enrolling your fingerprint

To use the integrated fingerprint reader, begin by enrolling your fingerprint as follows:

1. Turn on your computer.
2. To start the Lenovo Fingerprint software, refer to “Fingerprint Software” on page 21.

3. Follow the instructions on the screen to enroll your fingerprint. For details, refer to the help information system for the program.

Swiping your finger over the reader

To swipe your finger over the reader, do the following:

1. Place the ball of your finger (the central part of the fingerprint) on the small circle above the reader. Make sure that the entire top joint of the finger is on the reader.

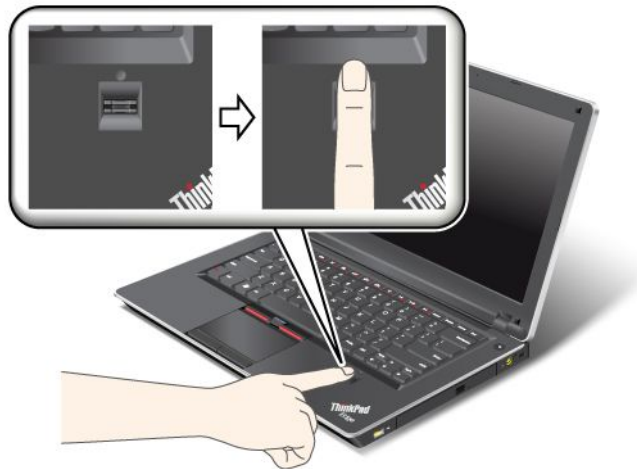

Note: Your computer keyboard might look different from the illustration above.

2. Apply light pressure and swipe your finger across the reader in one smooth motion.

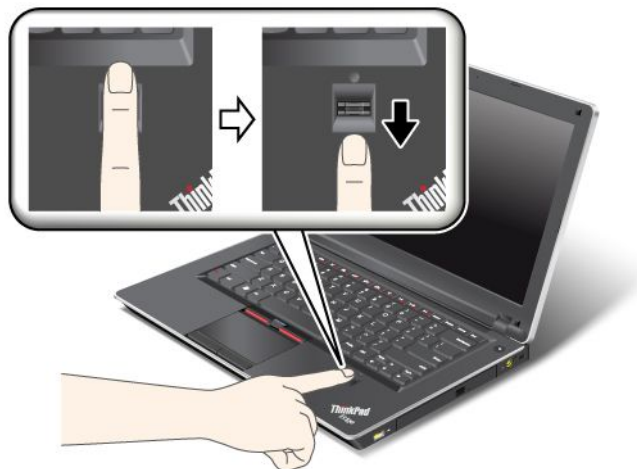

Note: Your computer keyboard might look different from the illustration above.

Maintaining the fingerprint reader

The following actions could damage the fingerprint reader or cause it not to work properly:

- Scratching the surface of the reader with a hard, pointed object.
- Scraping the surface of the reader with your fingernail or anything hard.
- Using or touching the reader with a dirty finger.

If you notice any of the following conditions, gently clean the surface of the reader with a dry, soft, lint-free cloth:

- The surface of the reader is dirty or stained.
- The surface of the reader is wet.
- The reader often fails to enroll or authenticate your fingerprint.

If your finger has any of the following conditions, you might not be able to register or authenticate it:

- Your finger is wrinkled.
- Your finger is rough, dry, or injured.
- Your finger is very dry.
- Your finger is stained with dirt, mud, or oil.
- The surface of your finger is very different from when you enrolled your fingerprint.
- Your finger is wet.
- A finger that has not been enrolled is used.

To improve the situation, try the following:

- Clean or wipe your hands to remove any excess dirt or moisture from the fingers.
- Enroll and use a different finger for authentication.
- If your hands are too dry, apply lotion to them.

Notice on deleting data from your hard disk drive

As computers spread into every corner of life, they process more and more information. The data on your computer, some of which is sensitive, is stored on a hard disk drive. Before you dispose of, sell, or hand over your computer, be sure to delete data stored on it.

Handing your computer over to someone else without deleting the loaded software, such as operating systems and application software, may even violate License Agreements. You are advised to check the terms and conditions of those License Agreements.

There are methods that seem to delete the data:

- Move the data to the recycle bin, and then click **Empty recycle bin**.
- Use the **Delete** option.
- Format your hard disk drive, using the software for initializing it.
- Using the recovery program, provided by Lenovo, bring the hard disk drive back to factory-ship state.

These operations, however, only change the file allocation of the data; they do not delete the data itself. In other words, the data retrieval processing is disabled under an operating system such as Windows. The data is still there, even though it seems to be lost. Thus, it is sometimes possible to read the data by use of special software for data recovery. There is a risk that people of bad faith may read and misuse the critical data on hard disk drives for unexpected purposes.

To prevent leakage of data, it becomes very important that you take responsibility for deleting all the data from the hard disk drive when you dispose of, sell, or hand over your computer. You can destroy the data physically by smashing the hard disk drive with a hammer, or magnetically by means of strong magnetic power, thus making the data unreadable. But we recommend that you make use of the software (payware) or service (pay service) specifically developed for the purpose.

For disposing of data on the hard disk drive, Lenovo provides the Secure Data Disposal tool. To download the application, go to:
<http://www.lenovo.com/support>

Note: Running the application will take a couple of hours.

Using firewalls

If your system is preinstalled with a firewall program, it protects against computer Internet security threats, unauthorized access, intrusions, and Internet attacks. It also protects your privacy.

For more information about how to use the firewall program, refer to the help information system that comes with the program.

Protecting data against viruses

Your computer is preinstalled with an antivirus program so you can detect and eliminate viruses. The antivirus program is designed to help you detect and eliminate viruses.

Lenovo provides a full version of antivirus software on your computer with a free 30-day subscription. After 30 days, you must renew the license to continue receiving the antivirus software updates.

For more information about how to use your antivirus software, refer to the help information system of your antivirus software.

Chapter 5. Recovery overview

This chapter provides information about the recovery solutions provided by Lenovo.

This chapter contains the following topics:

- “Creating and using recovery media” on page 63
- “Performing backup and recovery operations” on page 64
- “Using the Rescue and Recovery workspace” on page 65
- “Creating and using a rescue medium” on page 66
- “Reinstalling preinstalled applications and device drivers” on page 67
- “Solving recovery problems” on page 68

Notes:

1. There are a variety of methods to choose from when considering how to recover in the event of a software- or hardware-related problem. Some methods vary depending on the type of your operating system.
2. The product on the recovery media may be used only for the following purposes:
 - Restore the product preinstalled on your computer
 - Reinstall the product
 - Modify the product using the Additional Files

Notes: To prevent potential performance risks or unexpected behavior that might be caused by the new hard disk drive technology, it is recommended that you use one of the following back-up software programs:

- ThinkVantage Rescue and Recovery version 4.3 or later
- Symantec Norton Ghost version 15 or later

Notes: To use this program, do the following:

1. Click **Start** → **Run**. The Run window opens.
 2. Type `cmd` in the field. Then click **OK**.
 3. Type `ghost -align=1mb` and press Enter.
- Acronis True Image 2010 or later
 - Paragon Backup & Recovery 10 Suit or later, Paragon Backup & Recovery 10 Home or later

Creating and using recovery media

You can use recovery media to restore the hard disk drive to the factory default settings. Recovery media are useful if you transfer the computer to another area, sell the computer, recycle the computer, or put the computer in an operational state after all other methods of recovery have failed. As a precautionary measure, it is important to create recovery media as early as possible.

Note: The recovery operations you can perform using recovery media vary depending on the operating system from which the recovery media were created. The recovery media might contain a boot medium and a data medium. Your Microsoft Windows license permits you to create only one data medium, so it is important that you store the recovery media in a safe place after you have made them.

Creating recovery media

This section provides instructions on how to create recovery media.

Note: You can create recovery media using discs or external USB storage devices.

To create recovery media, click **Start → All Programs → Lenovo ThinkVantage Tools → Factory Recovery Disks**. Then, follow the instructions on the screen.

Using recovery media

This section provides instructions on how to use recovery media on different operating systems.

- You can use recovery media to restore the computer to the factory default settings only. You can use recovery media to put the computer in an operational state after all other methods of recovery have failed.

Attention: When you use recovery media to restore the computer to the factory default settings, all the files currently on the hard disk drive will be deleted and replaced by the factory default settings.

To use recovery media, do the following:

1. Depending on the type of your recovery media, connect the boot medium (memory key or other USB storage device) to the computer, or insert the boot disc into the optical drive.
2. Repeatedly press and release the F12 key when turning on the computer. When the **Startup Device Menu** opens, release the F12 key.
3. Select the desired startup device and press Enter. The restore process begins.
4. Follow the instructions on the screen to complete the operation.

Notes:

1. After restoring your computer to the factory default settings, you might have to reinstall device drivers for some devices. See “Reinstalling preinstalled applications and device drivers” on page 67.
2. Some computers come with Microsoft Office or Microsoft Works preinstalled. If you need to recover or reinstall your Microsoft Office or Microsoft Works applications, you must use the *Microsoft Office CD* or *Microsoft Works CD*. These discs are provided only with computers preinstalled with Microsoft Office or Microsoft Works.

Performing backup and recovery operations

The Rescue and Recovery program enables you to back up all your hard disk drive contents including the operating system, data files, software programs, and personal settings. You can designate where the Rescue and Recovery program stores the backup:

- In a protected area of your hard disk drive
- On the secondary hard disk drive if a secondary hard disk drive is installed in your computer
- On an attached external USB hard disk drive
- On a network drive
- On recordable discs (a recordable optical drive is required for this option)

After you have backed up the contents on the hard disk drive, you can restore the complete contents of the hard disk drive, restore only the selected files, or restore only the Windows operating system and applications.

Performing a backup operation

This section provides instructions on how to perform a backup operation using the Rescue and Recovery program.

To perform a backup operation using the Rescue and Recovery program, do the following:

1. From the Windows desktop, click **Start → All Programs → Lenovo ThinkVantage Tools → Enhanced Backup and Restore**. The Rescue and Recovery program opens.
2. In the Rescue and Recovery main window, click the **Launch advanced Rescue and Recovery** arrow.
3. Click **Back up your hard drive** and select backup operation options. Then, follow the instructions on the screen to complete the backup operation.

Performing a recovery operation

This section provides instructions on how to perform a recovery operation using the Rescue and Recovery program.

1. From the Windows desktop, click **Start → All Programs → Lenovo ThinkVantage Tools → Enhanced Backup and Restore**. The Rescue and Recovery program opens.
2. In the Rescue and Recovery main window, click the **Launch advanced Rescue and Recovery** arrow.
3. Click the **Restore your system from a backup** icon.
4. Follow the instructions on the screen to complete the recovery operation.

For more information about performing a recovery operation from the Rescue and Recovery workspace, see “Using the Rescue and Recovery workspace” on page 65.

Using the Rescue and Recovery workspace

The Rescue and Recovery workspace resides in a protected, hidden area of your hard disk drive that operates independently from the Windows operating system. This enables you to perform recovery operations even if you cannot start the Windows operating system. You can perform the following recovery operations from the Rescue and Recovery workspace:

- **Rescue files from your hard disk drive or from a backup** The Rescue and Recovery workspace enables you to locate files on your hard disk drive and transfer them to a network drive or other recordable media, such as a USB device or a disc. This solution is available even if you did not back up your files or if changes were made to the files since your last backup operation. You can also rescue individual files from a Rescue and Recovery backup located on your local hard disk drive, a USB device, or a network drive.
- **Restore your hard disk drive from a Rescue and Recovery backup** If you have backed up your hard disk drive using the Rescue and Recovery program, you can restore the hard disk drive from a Rescue and Recovery backup, even if you cannot start the Windows operating system.
- **Restore your hard disk drive to the factory default settings** The Rescue and Recovery workspace enables you to restore the complete contents of your hard disk drive to the factory default settings. If you have multiple partitions on your hard disk drive, you have the option to restore the factory default settings to the C: partition and leave the other partitions intact. Because the Rescue and Recovery workspace operates independently from the Windows operating system, you can restore the factory default settings even if you cannot start the Windows operating system.

Attention: If you restore the hard disk drive from a Rescue and Recovery backup or restore the hard disk drive to the factory default settings, all files on the primary hard disk drive partition (usually drive C:) will be deleted in the recovery process. If possible, make copies of important files. If you are unable to start the Windows operating system, you can use the rescue files feature of the Rescue and Recovery workspace to copy files from your hard disk drive to other media.

To start the Rescue and Recovery workspace, do the following:

1. Make sure the computer is turned off.
2. Repeatedly press and release the F11 key when turning on the computer. When you hear beeps or see a logo screen, release the F11 key.
3. If you have set a Rescue and Recovery password, type your password when prompted. The Rescue and Recovery workspace opens after a short delay.

Note: If the Rescue and Recovery workspace fails to open, see “Solving recovery problems” on page 68.

4. Do one of the following:
 - To rescue files from your hard disk drive or from a backup, click **Rescue files** and follow the instructions on the screen.
 - To restore your hard disk drive from a Rescue and Recovery backup or to restore your hard disk drive to the factory default settings, click **Restore your system** and follow the instructions on the screen.

For more information about the features of the Rescue and Recovery workspace, click **Help**.

Notes:

1. After restoring your hard disk drive to the factory default settings, you might have to reinstall device drivers for some devices. See “Reinstalling preinstalled applications and device drivers” on page 67.
2. Some computers come with Microsoft Office or Microsoft Works preinstalled. If you need to recover or reinstall your Microsoft Office or Microsoft Works applications, you must use the *Microsoft Office CD* or *Microsoft Works CD*. These discs are provided only with computers preinstalled with Microsoft Office or Microsoft Works.

Creating and using a rescue medium

With a rescue medium, such as a disc or a USB hard disk drive, you can recover the computer from failures that prevent you from gaining access to the Rescue and Recovery workspace on your hard disk drive.

Notes:

1. The recovery operations you can perform using a rescue medium vary depending on the operating system.
2. The rescue disc can be started in all types of optical drives.

Creating a rescue medium

This section provides instructions on how to create a rescue medium.

To create a rescue medium, do the following:

1. From the Windows desktop, click **Start → All Programs → Lenovo ThinkVantage Tools → Enhanced Backup and Restore**. The Rescue and Recovery program opens.
2. In the Rescue and Recovery main window, click the **Launch advanced Rescue and Recovery** arrow.
3. Click the **Create Rescue Media** icon. The Create Rescue and Recovery Media window opens.
4. In the **Rescue Media** area, select the type of the rescue medium you want to create. You can create a rescue medium using a disc, or a USB hard disk drive.
5. Click **OK** and follow the instructions on the screen to create a rescue medium.

Using a rescue medium

This section provides instructions on how to use the rescue medium you have created.

- If you have created a rescue medium using a disc, use the following instructions to use the rescue medium:

1. Turn off your computer.
 2. Repeatedly press and release the F12 key when turning on the computer. When the **Startup Device Menu** opens, release the F12 key.
 3. On the **Startup Device Menu**, select the desired optical drive as the first boot device. Then, insert the rescue disc into the optical drive and press Enter. The rescue medium starts.
- If you have created a rescue medium using a USB hard disk drive, use the following instructions to use the rescue medium:
 1. Attach the USB hard disk drive to one of the USB connectors on your computer.
 2. Repeatedly press and release the F12 key when turning on the computer. When the **Startup Device Menu** opens, release the F12 key.
 3. On the **Startup Device Menu**, select the USB hard disk drive as the first boot device and press Enter. The rescue medium starts.
 - If you have created a rescue medium using the secondary internal hard disk drive, set the secondary internal hard disk drive as the first boot device in the startup device sequence to start the rescue medium. See “Startup menu” on page 98.

When the rescue medium starts, the Rescue and Recovery workspace opens. The help information for each feature is available from the Rescue and Recovery workspace. Follow the instructions to complete the recovery process.

Reinstalling preinstalled applications and device drivers

Your computer has provisions that enable you to reinstall selected factory-installed applications and device drivers.

Reinstalling preinstalled applications

To reinstall selected application programs, do the following:

1. Turn on your computer.
2. Go to the C:\SWTOOLS directory.
3. Open the APPS folder. In it are several subfolders named for the various preinstalled applications.
4. Open the subfolder for the application you are reinstalling.
5. Double-click **Setup**, and then follow the instructions on the screen to complete the installation.

Reinstalling preinstalled device drivers

Attention: When you reinstall device drivers, you are changing the current configuration of your computer. Reinstall device drivers only when it is necessary to correct a problem with your computer.

To reinstall the device driver for a factory-installed device, do the following:

1. Turn on your computer.
2. Go to the C:\SWTOOLS directory.
3. Open the DRIVERS folder. Within the DRIVERS folder are several subfolders named for the various devices installed in your computer (for example, AUDIO and VIDEO).
4. Open the subfolder for the device.
5. Reinstall the device driver by doing one of the following:
 - In the subfolder for the device, look for a text file (a file with the extension .txt). The text file contains information on how to reinstall that device driver.

- If the subfolder for the device contains a file of setup information (a file with the extension .inf), you can use the Add New Hardware program (in the Windows Control Panel) to reinstall the device driver. Not all device drivers can be reinstalled by use of this program. In the Add New Hardware program, when prompted for the device driver you want to install, click **Have Disk** and **Browse**. Then select the device driver file from the device subfolder.
- In the subfolder for the device, look for the file for the application (a file with the extension .exe). Double-click the file, and follow the instructions on the screen.

Attention: If you need updated device drivers, do not download them from the Windows Update Web site. Obtain them from Lenovo. For more information, see “Making sure device drivers are current” on page 108.

Solving recovery problems

If you are unable to access the Rescue and Recovery workspace or the Windows environment, do one of the following:

- Use a rescue medium to start the Rescue and Recovery workspace. See “Using a rescue medium” on page 66.
- Use recovery media if all other methods of recovery have failed and you need to restore the hard disk drive to the factory default settings. See “Using recovery media” on page 64.

Note: If you are unable to access the Rescue and Recovery workspace or the Windows environment from a rescue medium or recovery media, you might not have the rescue device (an internal hard disk drive, a disc, a USB hard disk drive, or other external devices) set as the first boot device in the startup device sequence. You must first make sure that your rescue device is set as the first boot device in the startup device sequence in the ThinkPad Setup program. See “Startup menu” on page 98 for detailed information about temporarily or permanently changing the startup device sequence. For more information about the ThinkPad Setup program, see “ThinkPad Setup” on page 95.

It is important to create a rescue medium and a set of recovery media as early as possible and store them in a safe place for future use.

Chapter 6. Replacing devices

You can increase the capacity of the memory or the hard disk drive by replacing the original, built-in device with an optional one. Or, if you need to, you can replace the PCI Express Mini Card by following the procedures in this chapter.

This chapter provides information on the following topics:

- “Static electricity prevention” on page 69
- “Replacing the battery” on page 69
- “Replacing the hard disk drive” on page 71
- “Replacing the optical drive” on page 74
- “Replacing a PCI Express Mini Card for wireless LAN connection” on page 78
- “Replacing a memory module” on page 81
- “Replacing the keyboard” on page 84

Static electricity prevention

Static electricity, although harmless to you, can seriously damage computer components and options. Improper handling of static-sensitive parts can cause damage to the part. When you unpack an option or a CRU, do not open the static-protective package containing the part until the instructions direct you to install it.

When you handle options or CRUs, or perform any work inside the computer, take the following precautions to avoid static-electricity damage:

- Limit your movement. Movement can cause static electricity to build up around you.
- Always handle components carefully. Handle adapters, memory modules, and other circuit boards by the edges. Never touch exposed circuitry.
- Prevent others from touching components.
- When you install a static-sensitive option or CRU, touch the static-protective package containing the part to a metal expansion-slot cover or other unpainted metal surface on the computer for at least two seconds. This reduces static electricity in the package and your body.
- When possible, remove the static-sensitive part from the static-protective packaging and install the part without setting it down. When this is not possible, place the static-protective packaging on a smooth, level surface and place the part on it.
- Do not place the part on the computer cover or other metal surface.

Replacing the battery

Before you start, print these instructions.

This system might not support batteries that are not genuine Lenovo-made or authorized. These systems will continue to boot, but might not charge unauthorized batteries.

Attention: Lenovo has no responsibility for the performance or safety of unauthorized batteries, and provides no warranties for failures or damage arising out of their use.

To replace the battery with a new one, read the following prerequisites.

Prerequisites for the procedure



If the rechargeable battery pack is incorrectly replaced, there is danger of an explosion. The battery pack contains a small amount of harmful substances. To avoid possible injury:

- Replace only with a battery of the type recommended by Lenovo.
- Keep the battery pack away from fire.
- Do not expose it to excessive heat.
- Do not expose it to water or rain.
- Do not short-circuit it.
- Do not drop, crush, puncture, or subject to strong forces. Battery abuse or mishandling can cause the battery to overheat, which can cause gasses or flame to “vent” from the battery pack or coin cell.

Replacing the battery

To replace the battery, do the following:

1. Turn off the computer, or enter hibernation mode. Then disconnect the ac power adapter and all cables from the computer.
2. Close the computer display, and turn the computer over.
3. Slide and hold the battery latch to the unlock position **1**, and remove the battery **2**.

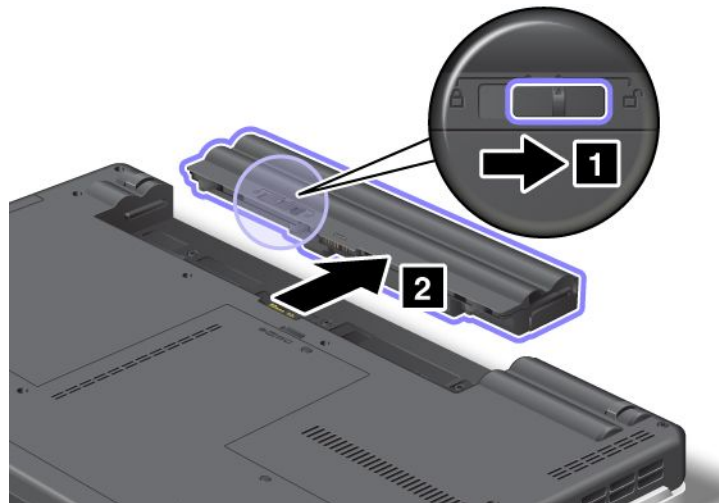

4. Insert a fully charged battery until it clicks into place **1**, and then slide the battery latch to the locked position **2**.

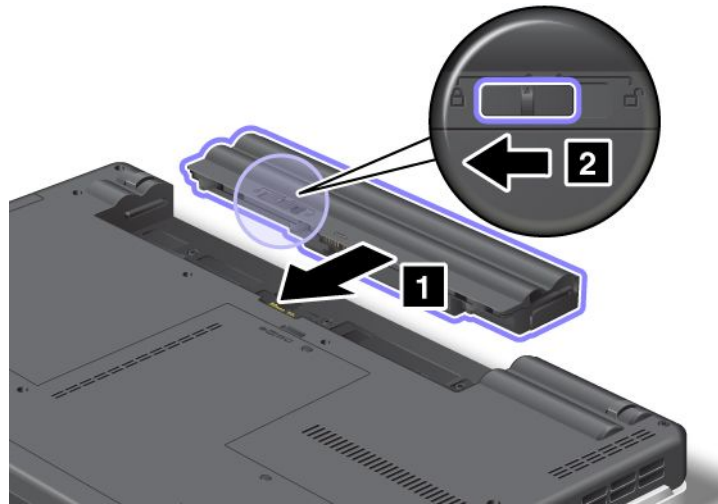

5. Turn the computer over again. Connect the ac power adapter and the cables to the computer.

Replacing the hard disk drive

Before you start, print these instructions.

You can replace the hard disk drive with a new one that can be purchased from your Lenovo reseller or a marketing representative. To replace the hard disk drive, read the following prerequisites.

Note: Replace the hard disk drive only if you upgrade it or have it repaired. The connectors and slot of the hard disk drive were not designed for frequent changes or drive swapping.

Prerequisites for the procedure

When replacing the drive, be sure to follow the precautions.

Attention: When you are handling a hard disk drive:

- Do not drop the drive or subject it to physical shocks. Put the drive on a material, such as soft cloth, that absorbs any physical shocks.
- Do not apply pressure to the cover of the drive.
- Do not touch the connector.

The drive is very sensitive. Incorrect handling can cause damage and permanent loss of data.

Before removing the hard disk drive, make a backup copy of all the information on it, and then turn the computer off.

Never remove the drive while the system is operating, in sleep mode, or in hibernation mode.

Replacement instructions

To replace the hard disk drive, do the following:

1. Turn off the computer; then disconnect the ac power adapter and all cables from the computer.
2. Close the computer display, and turn the computer over.

3. Remove the battery. For more information about how to remove the battery, refer to “Replacing the battery” on page 69.
4. Loosen the screws **1**, and then remove the cover **2**.

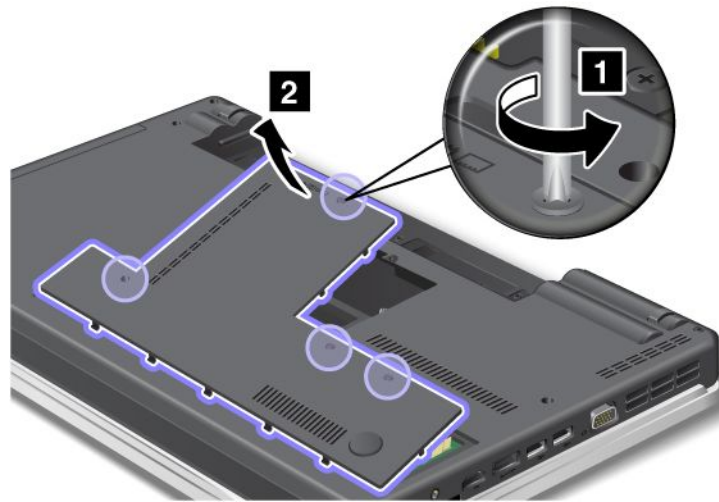

5. Remove the screws **1**, and then slide the hard disk drive **2** out.

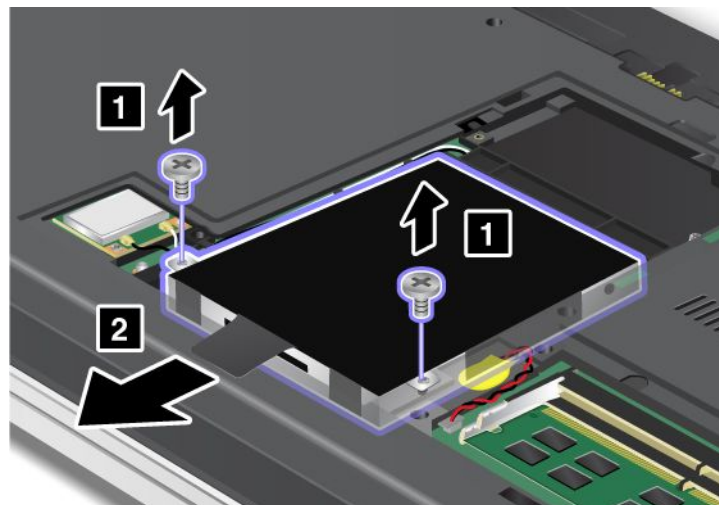

6. Remove the hard disk drive by lifting the tab.

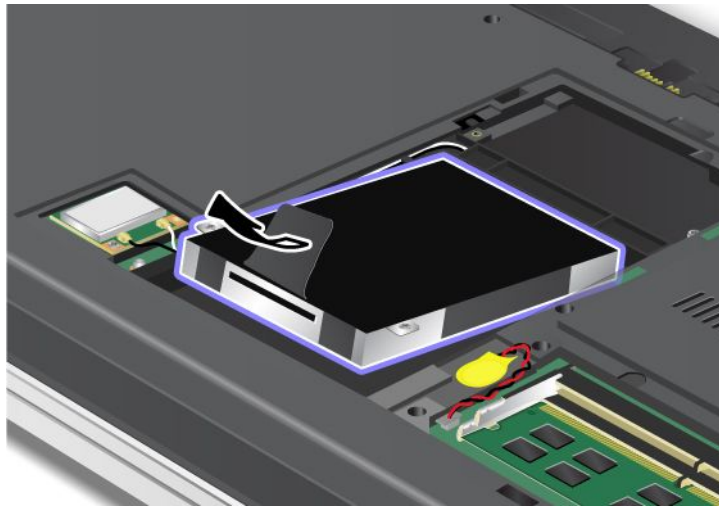

7. Place the new hard disk drive into the hard disk drive bay.

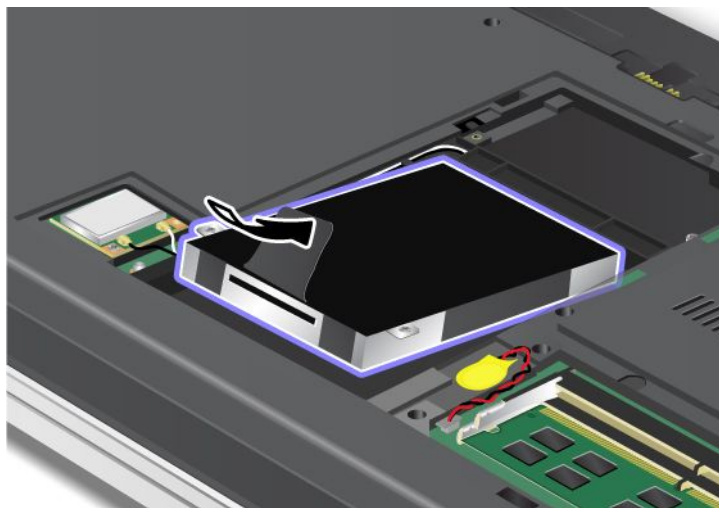

8. Slide the hard disk drive firmly into the connector **1**, and then reinstall the screws **2**.

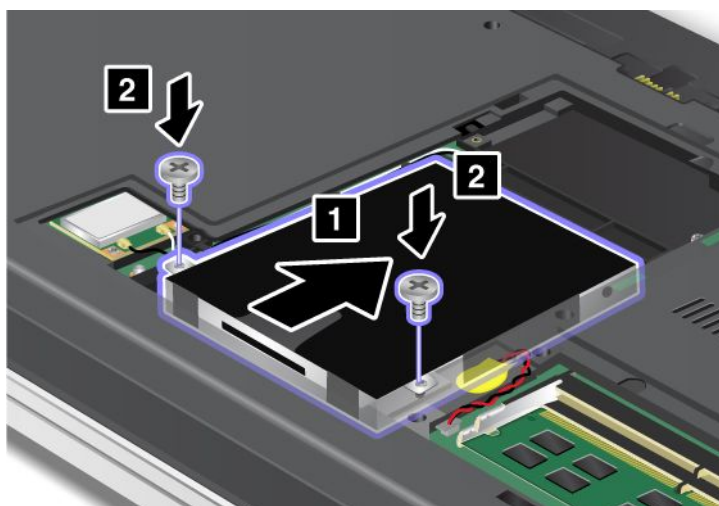

9. Reinstall the computer cover **1**. Then tighten the screws **2**.

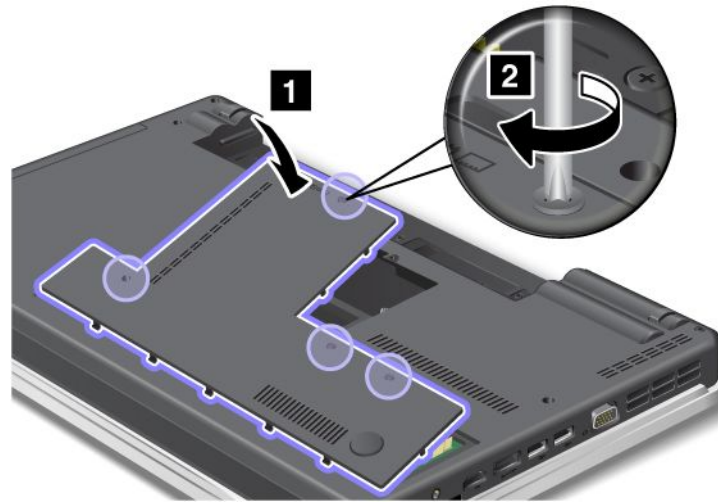

10. Reinstall the battery. For more information about how to reinstall the battery, refer to “Replacing the battery” on page 69.
11. Turn the computer over again. Connect the ac power adapter and the cables to the computer.

Replacing the optical drive

ThinkPad Edge E425

Before you start, print these instructions.

An optical drive is preinstalled in the optical drive bay. If it needs to be repaired, remove it by doing the following:

1. Turn off the computer; then disconnect the ac power adapter and all cables from the computer. Wait for a few minutes, till the inside of the computer cools, before you start the following procedures.
2. Remove the battery.
3. Close the computer display, and turn the computer over.
4. Loosen the screws **1**, and then remove the cover **2**.

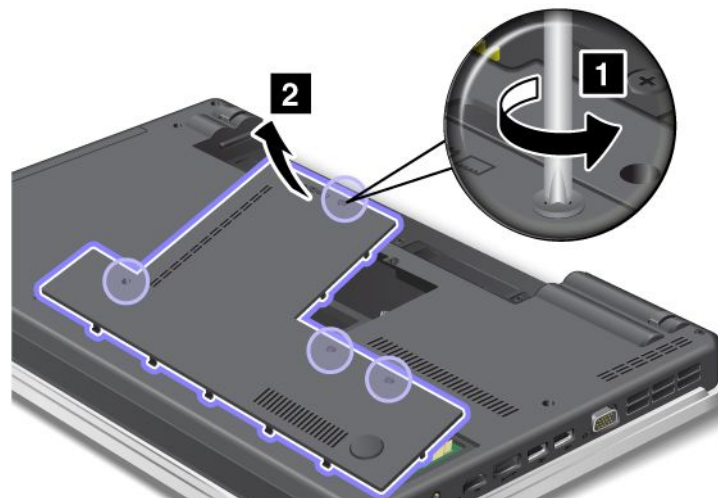

5. Remove the screw.

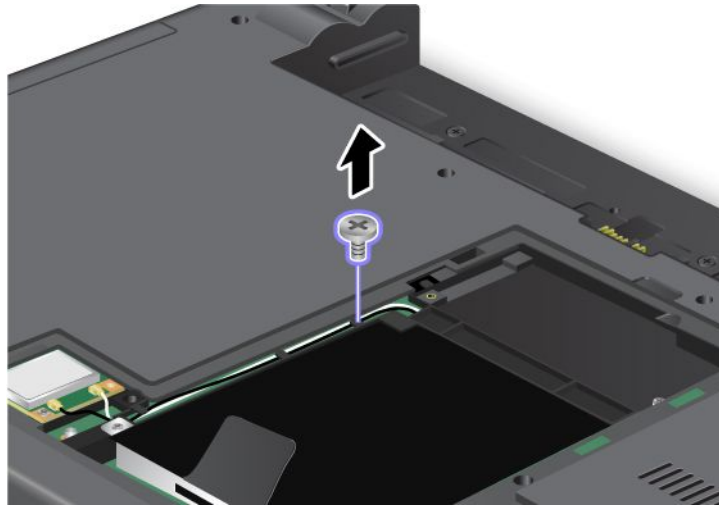

6. Pull out the drive.

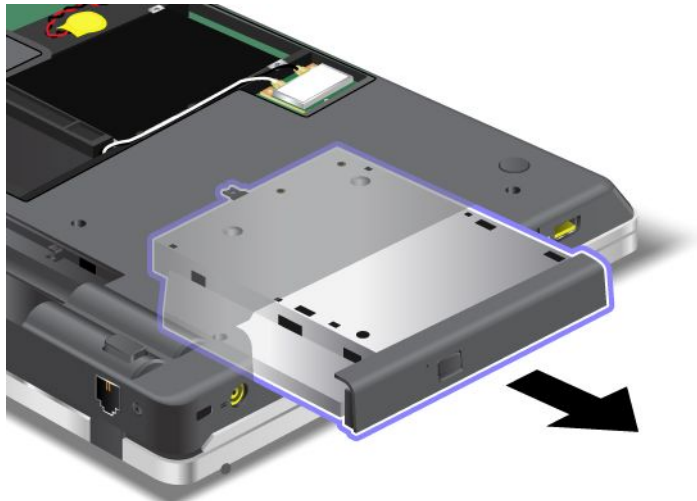

To install a repaired drive or a new one, do the following:

1. Insert the drive in the bay, and then press it firmly into the connector.

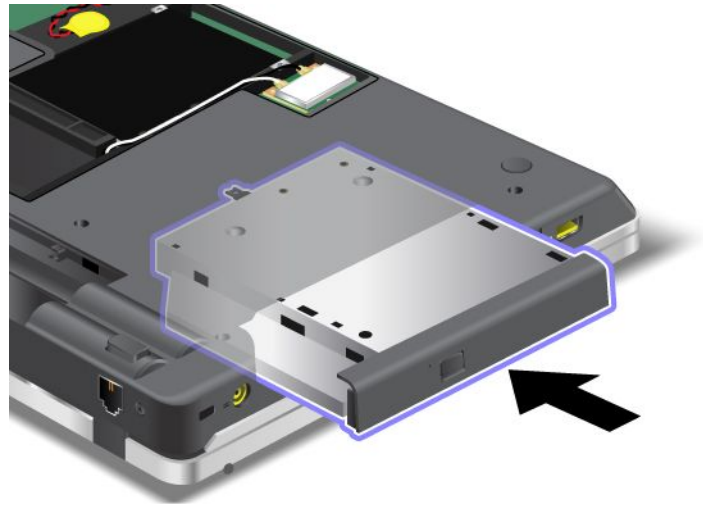

2. Reinstall the screw.

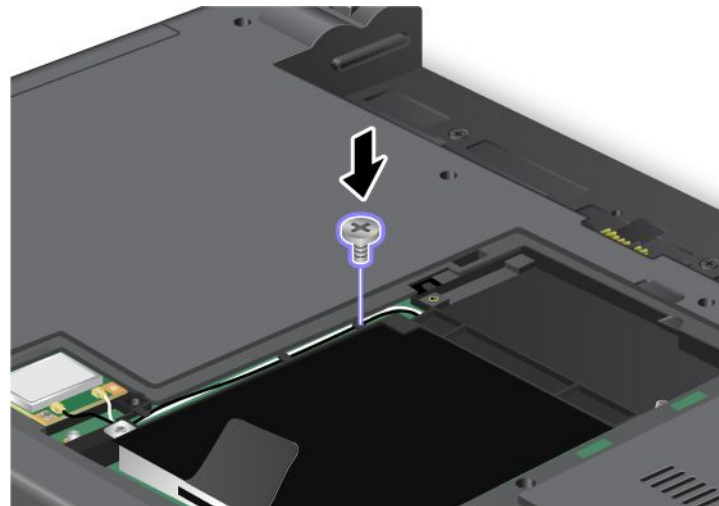

3. Reinstall the computer cover **1**. Then tighten the screws **2**.

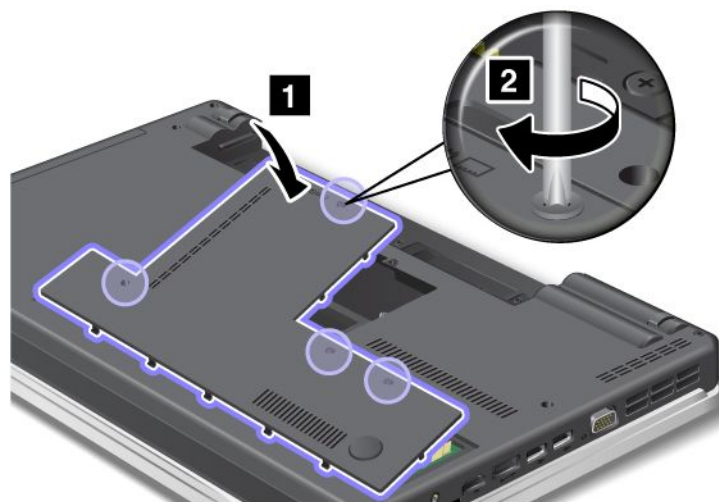

4. Reinstall the battery. For more information about how to reinstall the battery, refer to “Replacing the battery” on page 69.
5. Turn the computer over again. Connect the ac power adapter and the cables to the computer; then turn it on.

ThinkPad Edge E525

Before you start, print these instructions.

An optical drive is preinstalled in the bay. If it needs to be repaired, remove it by doing the following:

1. Turn off the computer; then disconnect the ac power adapter and all cables from the computer. Wait for a few minutes, till the inside of the computer cools, before you start the following procedures.
2. Remove the battery. For more information about how to remove the battery, refer to “Replacing the battery” on page 69.
3. Close the computer display, and turn the computer over.
4. Loosen the screw that secures the drive **1**, and remove it **2**.

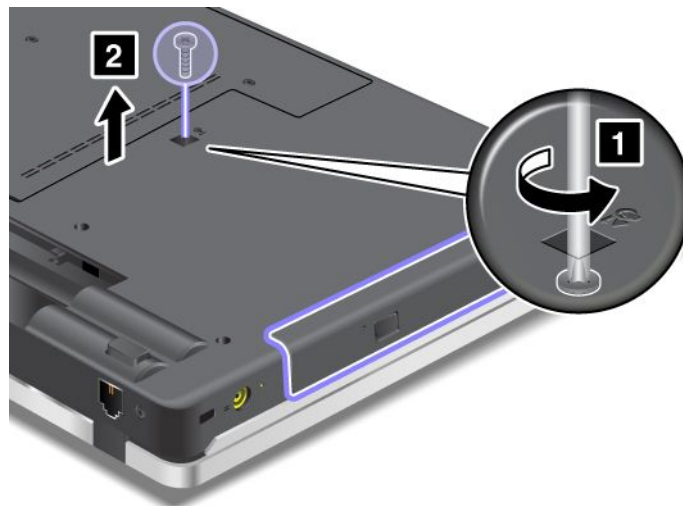

5. Press the edge of the drive outwards, using the tip of a thin screwdriver as shown in the drawing **1**, and then pull out the drive **2**.

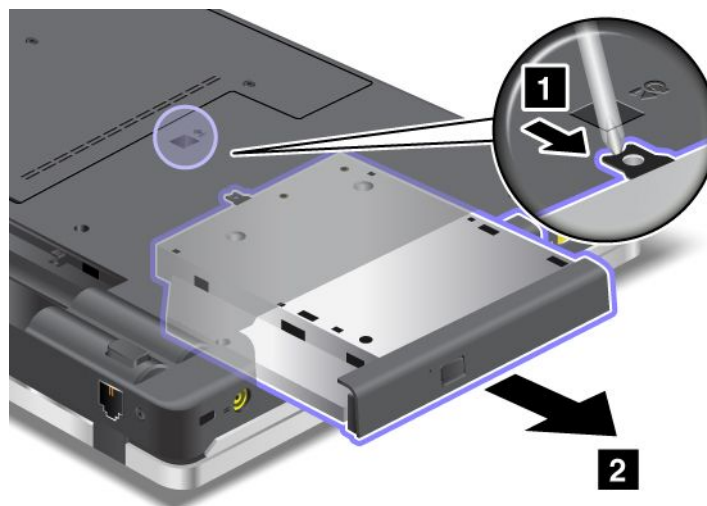

To install a repaired drive or a new one, do the following:

1. Insert the drive in the bay, and then press it firmly to the connector.

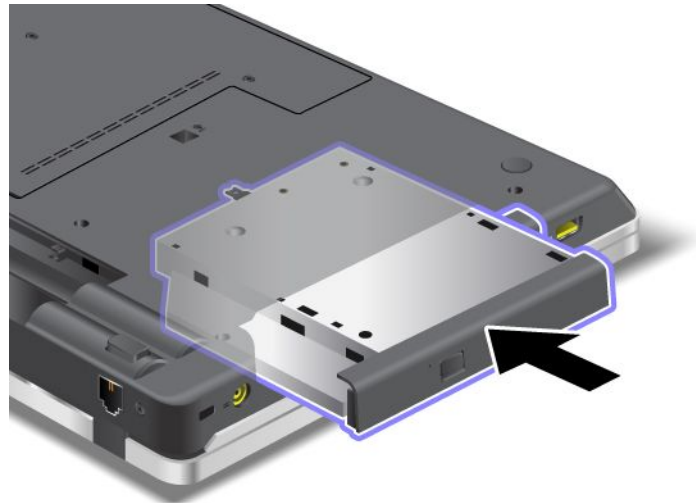

2. Reinstall the screw **1**, and tighten it **2**.

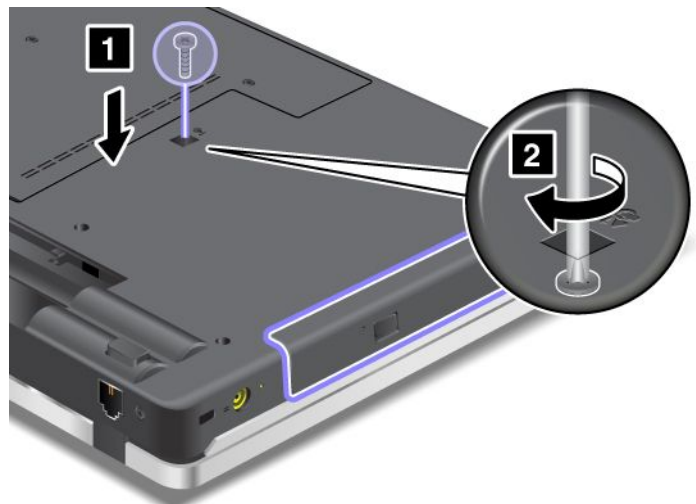

3. Reinstall the battery. For more information about how to reinstall the battery, refer to “Replacing the battery” on page 69.
4. Turn the computer over again. Connect the ac power adapter and the cables to the computer; then turn it on.

Replacing a PCI Express Mini Card for wireless LAN connection

Before you start, print these instructions.

Your computer has a PCI Express Mini Card slot for connection to a wireless LAN. To replace the PCI Express Mini Card with a new one, read the following prerequisites.

Prerequisites for the procedure



During electrical storms, do not connect the cable to or disconnect it from the telephone outlet on the wall.



Electric current from power, telephone, and communication cables is hazardous. To avoid shock hazard, disconnect the cables before opening the cover of this slot.

Attention: Before you start installing a PCI Express Mini Card, touch a metal table or a grounded metal object. This action reduces any static electricity from your body. The static electricity could damage the card.

Replacing a PCI Express Mini Card

1. Turn off the computer; then disconnect the ac power adapter and all cables from the computer. Wait for a few minutes, till the inside of the computer cools, before you start the following procedures.
2. Close the computer display, and turn the computer over.
3. Remove the battery. For more information about how to remove the battery, refer to “Replacing the battery” on page 69.
4. Loosen the screws **1**, and then remove the cover **2**.

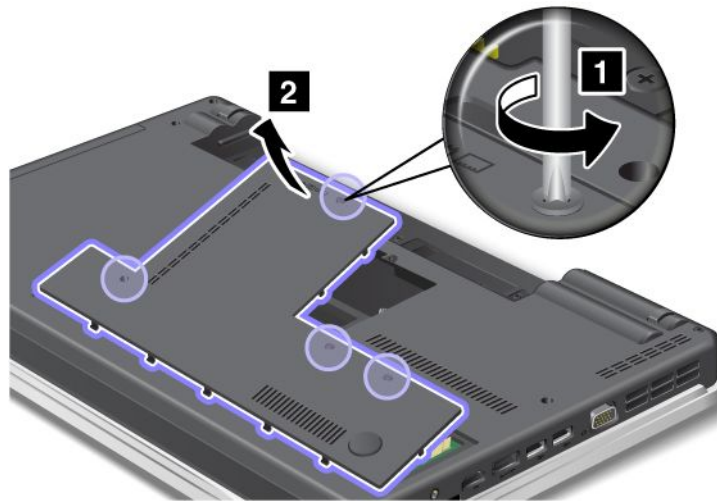

5. If a tool for removing connectors is included in the package with the new card, use it to disconnect the cables from the card. If no such tool is included, disconnect the cables by picking up the connectors with your fingers and gently unplugging them.

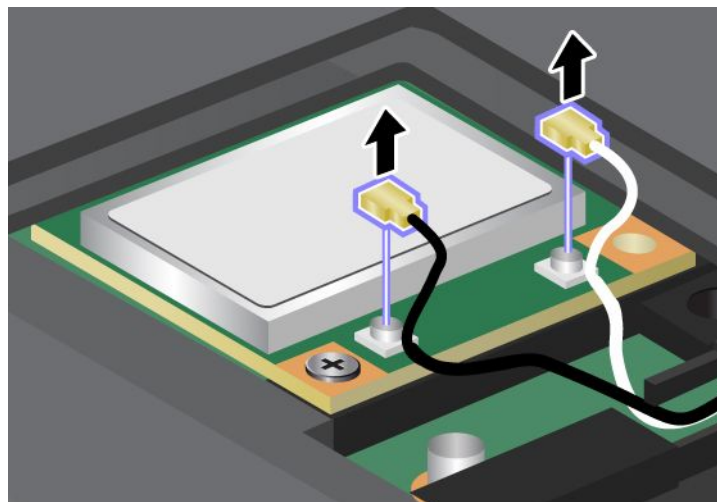

6. Remove the screw **1**. The card pops up **2**. Remove the card.

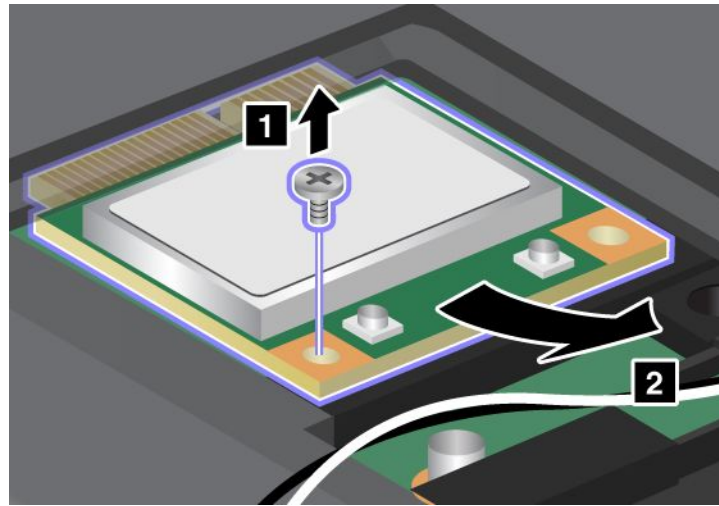

7. Align the contact edge of the new PCI Express Mini Card with the corresponding socket **1**. Pivot the card until you can snap it into place. Secure the card with the screw **2**.

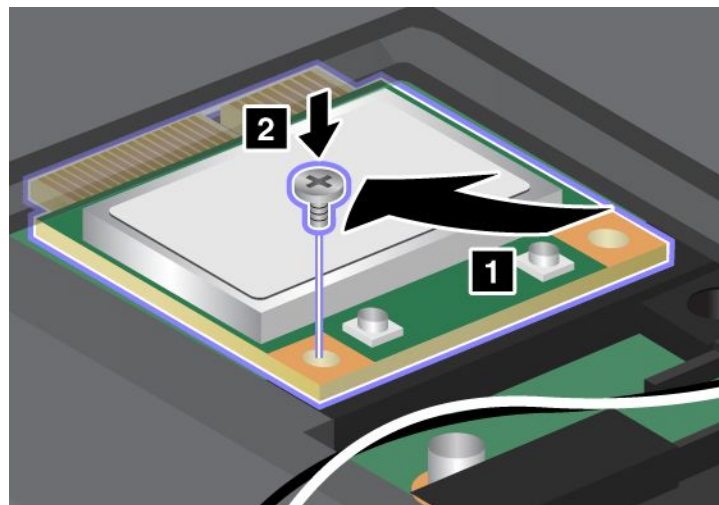

8. Connect the antenna cables to the new PCI Express Mini Card as shown in the drawing.

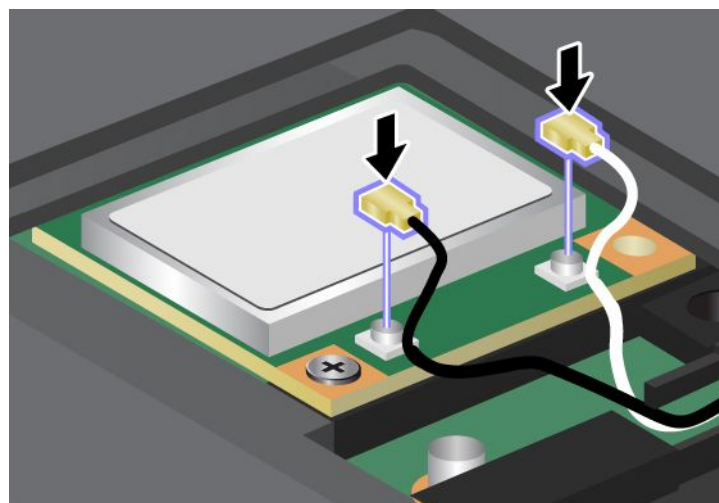

9. Reinstall the computer cover **1**. Then tighten the screws **2**.

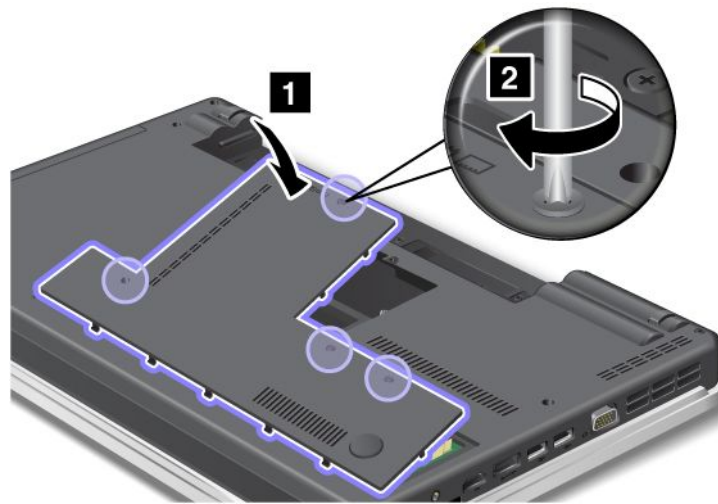

10. Reinstall the battery. For more information about how to reinstall the battery, refer to “Replacing the battery” on page 69.
11. Turn the computer over again. Connect the ac power adapter and cables to the computer; then turn it on.

Replacing a memory module

Before you start, print these instructions.

Increasing memory capacity is an effective way to make programs run faster. To replace or add memory module, read the following prerequisites, and then the instruction.

Prerequisites for the procedure

When replacing a memory module, be sure to follow the precautions.

Note: The operating speed of the memory module depends on the system configuration of your computer and its combination with the memory module installed on your computer. In some conditions, the memory module in your computer might not be able to operate at the maximum speed.

Attention: Before you start installing a memory module, touch a metal table or a grounded metal object. This action reduces any static electricity from your body. The static electricity could damage the memory module.

Replacing a memory module

To replacing a memory module, do the following:

1. Turn off the computer; then disconnect the ac power adapter and all cables from the computer.
2. Close the computer display, and turn it over.
3. Remove the battery. For information about how to remove the battery, refer to “Replacing the battery” on page 69.

4. Loosen the screws **1**, and then remove the cover **2**.

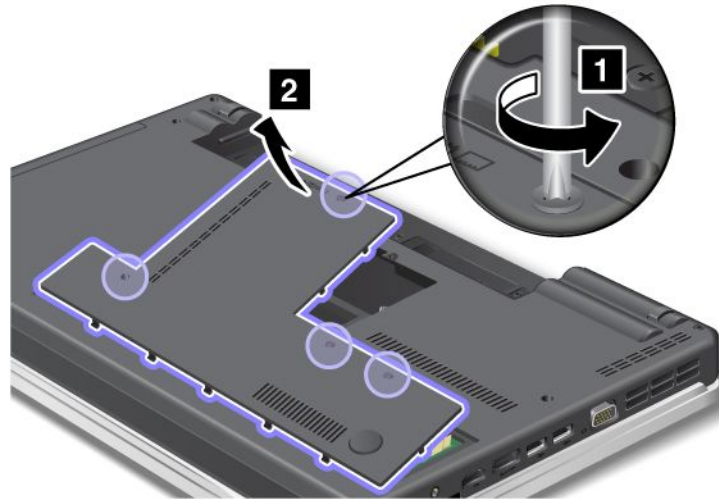

5. If the two memory modules are already in the memory slots, press out the latches on both edges of the socket at the same time **1**, and then remove a memory module **2** to make room for the new one. Be sure to save it for future use.

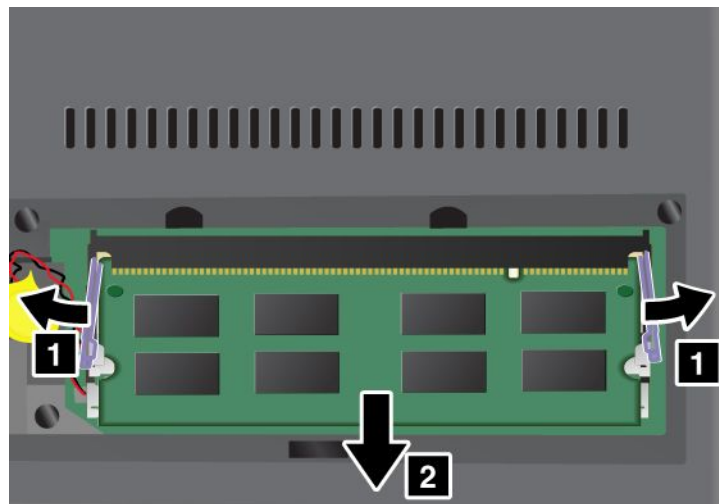

6. Find the notch on the contact edge side of the memory module you are installing.

Attention: To avoid damaging the memory module, do not touch its contact edge.

7. With the notched end of the memory module toward the contact edge side of the socket, insert the memory module **1** into the socket at an angle of about 20 degrees; then press it in firmly **2**.

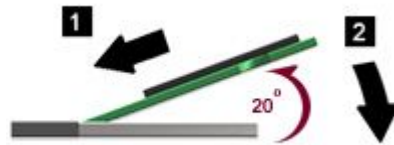
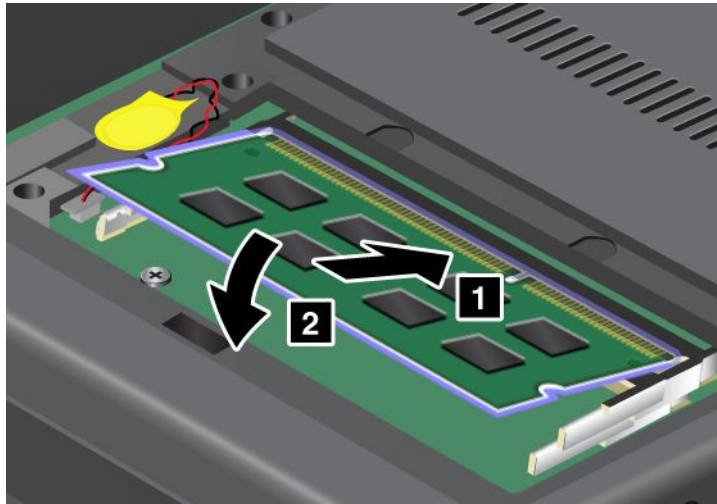

Note: If you install a memory module in only one of the two memory slots, install it in the bottom slot.

8. Pivot the memory module downward until it snaps into place.
9. Make sure that the memory module is firmly seated in the slot and cannot be moved easily.
10. Reinstall the computer cover **1**. Then tighten the screws **2**.

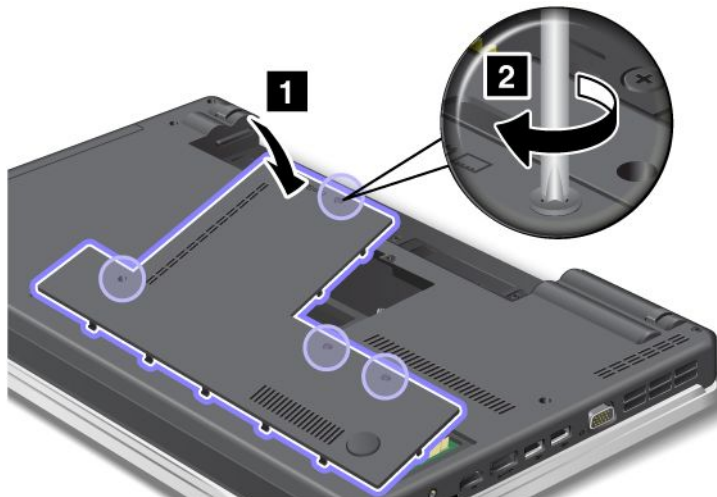

11. Reinstall the battery. For more information about how to reinstall the battery, refer to “Replacing the battery” on page 69.
12. Turn the computer over again and reconnect the cables.

Replacing the keyboard

Before you start, print these instructions.

You can use the following procedures to replace the keyboard with a new one, available as an option.

Prerequisites for the procedure



During electrical storms, do not connect the cable to or disconnect it from the telephone outlet on the wall.



Electric current from power, telephone, and communication cables is hazardous. To avoid shock hazard, disconnect the cables before opening the cover of this slot.

ThinkPad Edge E425

Removing the keyboard

To remove the keyboard, do the following:

1. Turn off the computer; then disconnect the ac power adapter and all cables from the computer. Wait for a few minutes, till the inside of the computer cools, before you start the following procedures.
2. Close the computer display, and turn the computer over.
3. Remove the battery. For information about how to remove the battery, refer to “Replacing the battery” on page 69.
4. Loosen the screws **1**, and then remove the cover **2**.

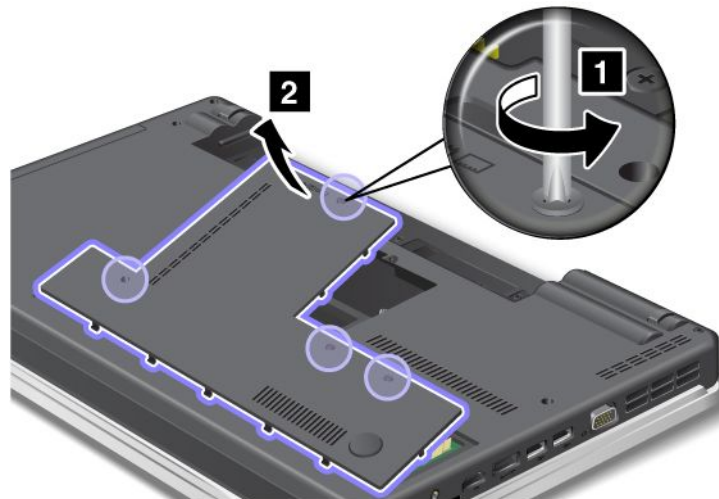

5. Remove the screws **1** and **2**.

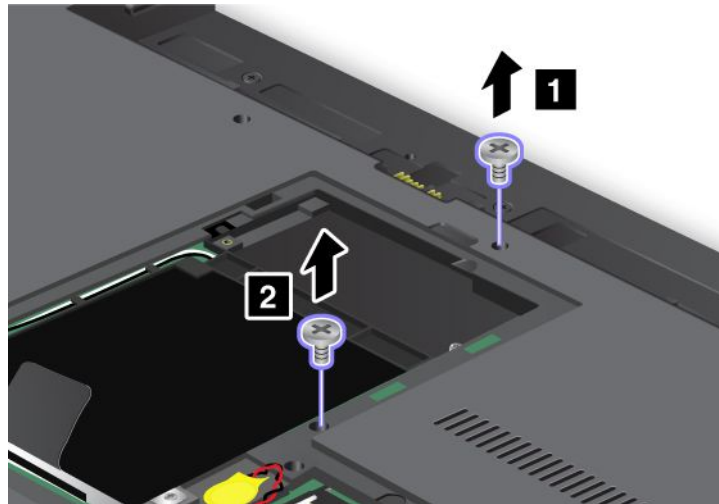

6. Push hard in the direction shown by the arrows **1** in the drawing to unlatch the front side of the keyboard. The keyboard will open up slightly **2**.

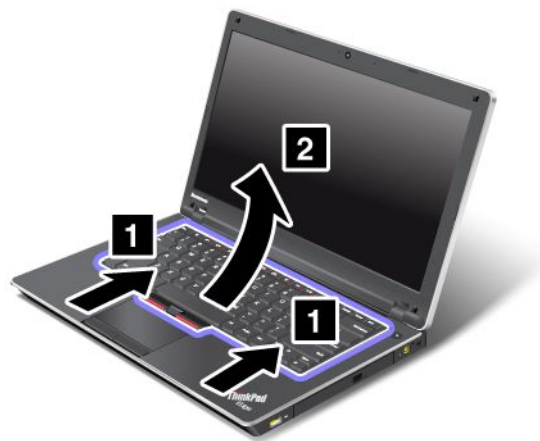

7. Remove the cables **2** and **4** by flipping the connectors **1** and **3** upwards. Now the keyboard has been removed.



Installing the keyboard

To install the keyboard, do the following:

1. Attach the cables **1** and **3** by flipping the connectors **2** and **4** downwards.



2. Insert the keyboard. Make sure that the rear edge of the keyboard is under the frame, as shown by the arrows.



3. Slide the keyboard as shown by the arrows.



4. Reinstall the screws **1** and **2**.

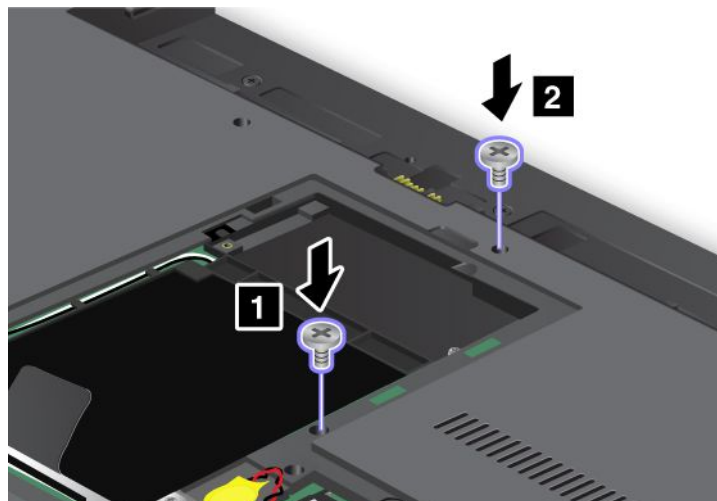

5. Reinstall the computer cover **1**. Then tighten the screws **2**.

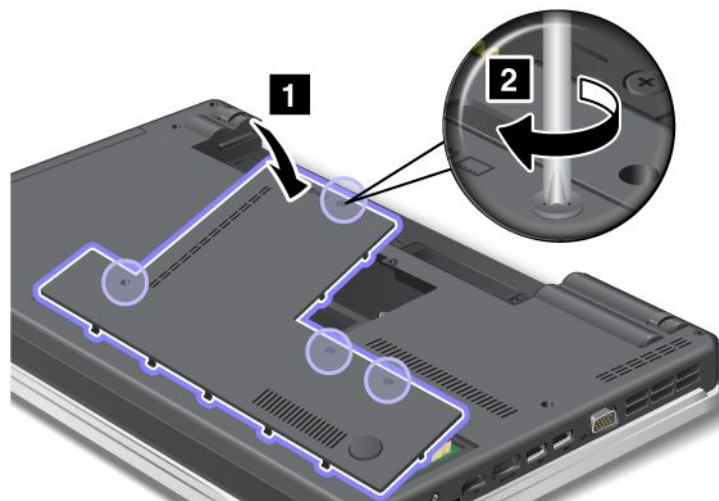

6. Reinstall the battery. For more information about how to reinstall the battery, refer to “Replacing the battery” on page 69.
7. Turn the computer over again. Connect the ac power adapter and cables to the computer; then turn it on.

ThinkPad Edge E525

Removing the keyboard

To remove the keyboard, do the following:

1. Turn off the computer; then disconnect the ac power adapter and all cables from the computer. Wait for a few minutes, till the inside of the computer cools, before you start the following procedures.
2. Close the computer display, and turn the computer over.
3. Remove the battery. For more information about how to remove the battery, refer to “Replacing the battery” on page 69.
4. Loosen the screws **1**, and then remove the cover **2**.

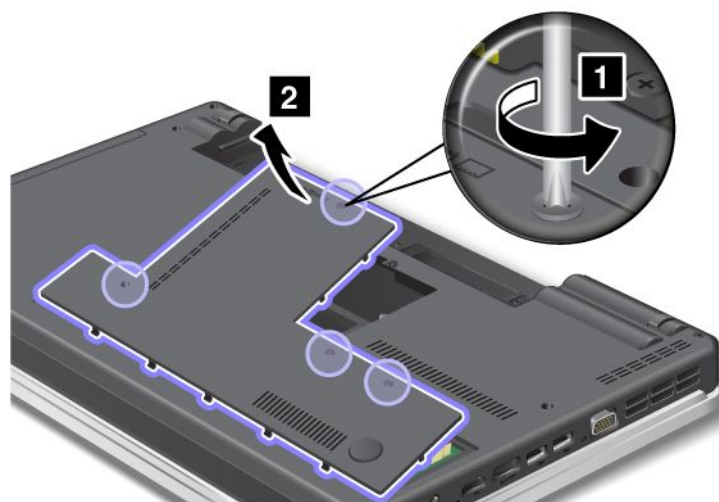

5. Remove the screws **1** and **2**.

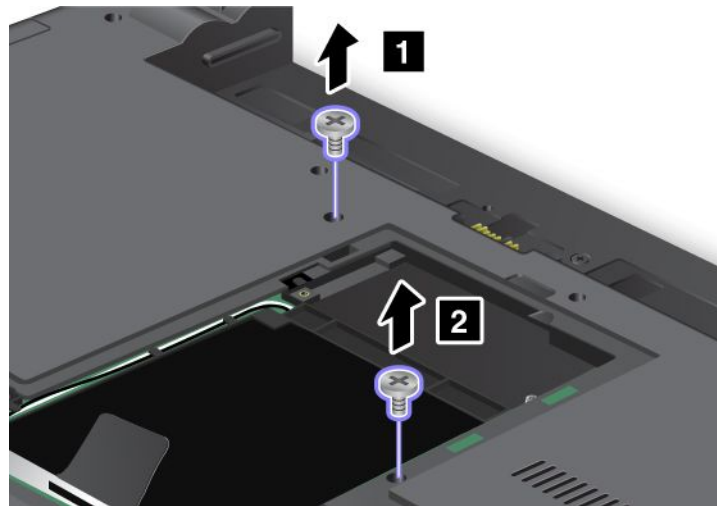

6. Push hard in the direction shown by the arrows **1** in the drawing to unlatch the front side of the keyboard. The keyboard will open up slightly **2**.

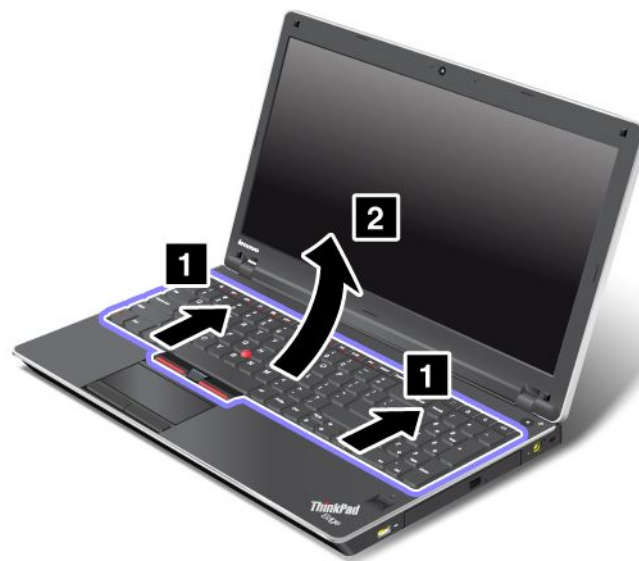

- Remove the cables **2** and **4** by flipping the connectors **1** and **3** upwards. Now the keyboard has been removed.



Installing the keyboard

To install the keyboard, do the following:

- Attach the cables **1** and **3** by flipping the connectors **2** and **4** downwards.



2. Insert the keyboard. Make sure that the rear edge of the keyboard is under the frame, as shown by the arrows.



3. Slide the keyboard as shown by the arrows.



4. Reinstall the screws **1** and **2**.

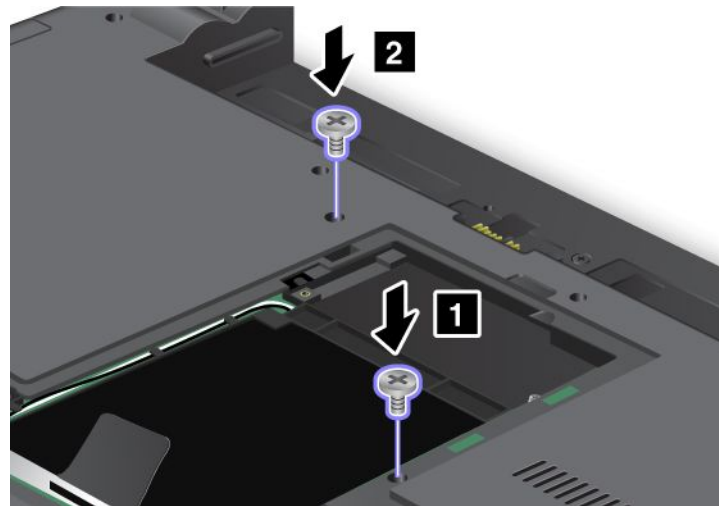

5. Reinstall the computer cover **1**. Then tighten the screws **2**.

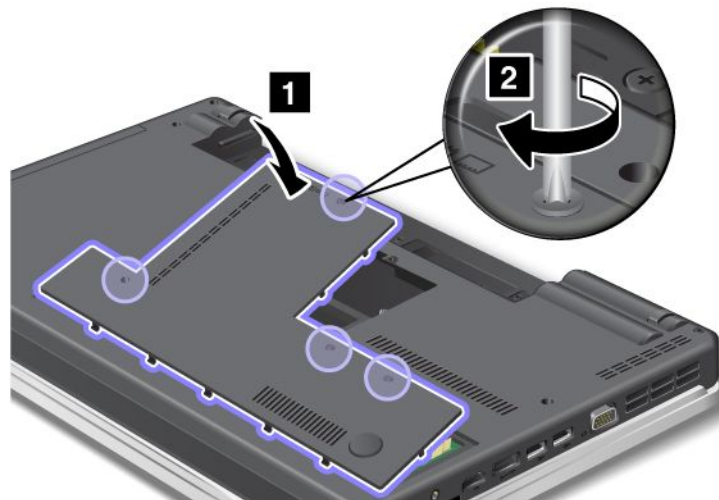

6. Reinstall the battery. For more information about how to reinstall the battery, refer to “Replacing the battery” on page 69.
7. Turn the computer over again. Connect the ac power adapter and cables to the computer; then turn it on.

Chapter 7. Advanced configuration

While it is important to protect files, data, and settings that are on the hard disk drive, you might also need to install a new operating system, install new device drivers, update your system UEFI BIOS, or recover preinstalled software. This information will help you handle your computer with proper care and keep it in top working shape.

- “Installing a new operating system” on page 93
- “Installing device drivers” on page 95
- “ThinkPad Setup” on page 95

Installing a new operating system

If you install a new operating system in your computer, you need to install the Supplement files and ThinkPad device drivers for it at the same time. The necessary files are located in the following directories of your hard disk drive:

- The Supplement files for the operating system supported are in the C:\SWT00LS\0SFIXES directory.
- The device drivers for the operating system supported are in the C:\SWT00LS\DRIVERS directory.
- The preloaded software applications are in the C:\SWT00LS\APPS directory.

Notes:

- The process of installing the new operating system deletes all the data on your hard disk drive, including backups or images that were stored in a hidden folder by use of the Rescue and Recovery program.
- If you cannot find the Supplement files, the device drivers, and application software you need on your hard disk drive, or if you want to receive updates and the latest information about them, refer to the ThinkPad Web site at <http://www.lenovo.com/ThinkPadDrivers>.

Before you begin

Before you install the operating system, do the following:

- Copy all the subdirectories and files in the C:\SWT00LS directory to a removable storage device, to avoid losing files during the installation.
- Print the instructions in “Installing Windows 7 operating system” on page 94.

Note: The UEFI BIOS features are supported only on the 64-bit version of the Windows 7 operating system.

If you want to start the Windows Recovery Environment (WinRE) using the installation DVD of a 64-bit version of the Windows operating system, you should not change the initial **UEFI/Legacy Boot** setting in ThinkPad Setup. The **UEFI/Legacy Boot** setting must be the same as it was when the Windows Operating system image was installed. Otherwise, you will see an error.

For the country or region code required in the installation, use one of the following:

Country or region: Code

- China: SC
- Denmark: DK
- Finland: FI
- France: FR

- Germany: GR
- Italy: IT
- Japan: JP
- Netherlands: NL
- Norway: NO
- Spain: SP
- Sweden: SV
- Taiwan and Hong Kong: TC
- United States: US

Installing Windows 7 operating system

To install Windows 7 operating system and its related software on your computer, do the following:

1. Start the ThinkPad Setup program.
2. Select **Startup** .
3. Select **UEFI/Legacy Boot**.
4. Do one of the following:
 - If you want to install the Windows 7 (32-bit) operating system, select **Legacy Only** or **Both**.
 - If you want to install the Windows 7 (64-bit) operating system in Legacy mode, select **Legacy Only**.
 - If you want to install the Windows 7 (64-bit) operating system in UEFI mode, select **UEFI Only**.
5. Press F10.
6. Insert the Windows 7 operating system installation DVD into the DVD drive, and restart the computer.
7. Install ThinkPad AMD SMBus Driver for Windows 7 and ThinkPad AMD SATA Controller Driver for Windows 7.
8. Install device drivers. To do this, refer to “Installing drivers and software” on page 95.

Installing Registry Patch for Windows 7

- Registry patch enabling Wake Up on LAN from Standby for Energy Star

To install this Registry Patch, go to:

<http://www.lenovo.com/support>.

Installing the Windows 7 update module package

The Windows 7 update modules are in the following directory:

C:\SWTOOLS\OSFIXES\

The name of each subfolder is the number of a fix module. For information about each fix module, go to the Microsoft Knowledge Base homepage at <http://support.microsoft.com/>, type the number of the fix module you need in the search field, and click **Search**.

Note: The Web site address might change without notice. If the homepage is not displayed, search for it from the Microsoft top page.

To install a fix module, run the EXE file in a subfolder and follow the instructions on the screen.

Note: If you remove the hard disk drive from the computer with a single-core processor and install it on a computer with a dual-core processor, you can get access to the hard disk drive. The opposite, however, is

not true: If you remove the hard disk drive from a computer with a dual-core processor and install it on a computer with a single-core processor, you cannot get access to the hard disk drive.

Installing device drivers

To install device drivers, go to:
<http://www.lenovo.com/support>

Installing the driver for the 4-in-1 media card reader

To use the 4-in-1 media card reader, you need to download and install the Ricoh Multi Card Reader Driver. To download it, go to the Lenovo Web site at:
<http://www.lenovo.com/ThinkPadDrivers>

Installing Intel Chipset Support for Windows 2000/XP/Vista/7

Before you begin the installation, copy all the subdirectories and files in the C:\SWT00LS directory to a removable storage device, to avoid losing files during the installation.

To install Intel Chipset Support for Windows 2000/XP/Vista/7, do the following:

1. Restore the C:\SWT00LS folder from the backup copy you made before the installation.
2. Run the `infinst_autol.exe` file in the C:\SWT00LS\DRIVERS\INTELINF directory.

Installing drivers and software

The device drivers are provided in the C:\SWT00LS\DRIVERS directory on your hard disk drive. You will also need to install application software, which is provided in the C:\SWT00LS\APPS directory on your hard disk drive. To do this, refer to the instructions in “Reinstalling preinstalled applications and device drivers” on page 67.

Note: If you cannot find the Supplement files, device drivers, and application software you need on your hard disk drive, or if you want to receive updates and the latest information about them, go to the ThinkPad Web site at:
<http://www.lenovo.com/ThinkPadDrivers>

ThinkPad Setup

Your computer comes with the ThinkPad Setup program to enable you to select various setup parameters.

To start ThinkPad Setup, do the following:

1. To protect yourself against accidental loss of data, back up your computer registry. See “Performing backup and recovery operations” on page 64.
2. If the diskette drive is connected to the computer, remove any diskette from the diskette drive, and then turn off the computer.
3. Turn on the computer. When the logo screen is displayed, press the F1 key. The ThinkPad Setup program main menu opens.

If you have set a supervisor password, the ThinkPad Setup program main menu will be displayed after you enter the password. You can start ThinkPad Setup by pressing Enter instead of entering the supervisor password. However, you cannot change the parameters that are protected by the supervisor password. For more information, refer to “Using passwords” on page 53.

The following is an example of the ThinkPad Setup program main menu.

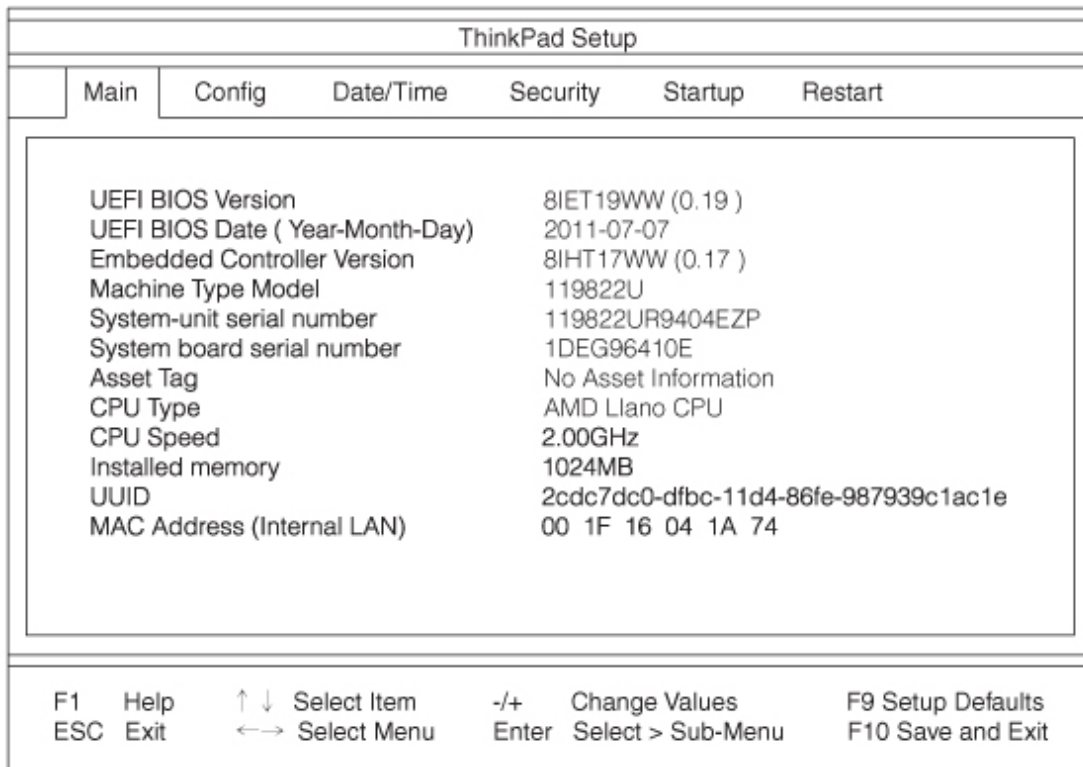

- Using the cursor keys, move to an item you want to change. When the item you want is highlighted, press Enter. A submenu is displayed.
- Change the items you wish to change. To change the value of an item, press the + or - key. If the item has a submenu, you can display it by pressing Enter.
- Press Esc to exit from the submenu.
- If you are in a nested submenu, press Esc repeatedly until you reach the **ThinkPad Setup** program main menu.

Note: If you need to restore the settings to their original state as of the time of purchase, press F9 to load the default settings. You can also select an option on the **Restart** submenu to load the default settings or discard the changes.

- Select **Restart**. Move the cursor to the option you want for restarting your computer; then press **Enter**. Your computer restarts.

Config menu

If you need to change the configuration of your computer, select **Config** from the ThinkPad Setup program main menu.

Notes:

- The default settings are already optimized for you. If you consider changing the computer configuration, proceed with extreme caution. Setting the configuration incorrectly might cause unexpected results.
- On each submenu, you can enable a function by selecting **Enabled**, or disable it by selecting **Disabled**.

The following submenu is displayed:

- Network:** Set the LAN function.
- USB:** Enable or disable USB related functions.

- **Keyboard/Mouse:** Set the keyboard and the mouse related functions.
- **Display:** Specify the settings for display output.
- **Power:** Set power management related functions.
- **Beep and Alarm:** Enable or disable the audio related functions.
- **Serial ATA (SATA):** Specify the settings for the hard disk drive.

Date/Time menu

If you need to set the current date and time of your computer, select **Date/Time** from the ThinkPad Setup program main menu. The following submenu is displayed:

- System Date
- System Time

To change the date and time, do the following:

1. Using the up and down arrow keys, select the item to change date or time.
2. Press Tab, Shift+Tab, or Enter to select a field.
3. Type the date or time.

Note: Another way to adjust date and time is pressing + or –.

4. Press F10 to save the changes and restart the system.

Security menu

If you need to set the security features of your computer, select **Security** from the ThinkPad Setup program main menu.

Notes:

- The default settings are already optimized for you. If you consider changing the computer configuration, proceed with extreme caution. Setting the configuration incorrectly might cause unexpected results.
- On each submenu, you can enable a function by selecting **Enabled**, or disable it by selecting **Disabled**.

The following submenu is displayed:

- **Password:** Set a password.
- **UEFI BIOS Update Option:** Specify the settings for Flash UEFI BIOS update.
- **Memory Protection:** Specify the settings for the Data Execution Prevention feature.
- **Virtualization:** Enable or disable the settings for AMD-V™ and Intel VT-d Feature.
- **I/O Port Access:** Enable or disable the access to individual I/O ports.
- **Anti-Theft:** Enable or disable the UEFI BIOS interface to activate Anti-Theft services, such as Computrace.

To set a password, go to the **Security** menu and select **Password**. The following submenu is displayed:

- **Supervisor Password**
- **Lock UEFI BIOS Settings**
- **Set Minimum Length**
- **Password at unattended boot**
- **Password at restart**
- **Power-On Password**
- **Hard Disk x Password**

Note: **Hard Disk 1** means the hard disk drive built into your computer.

The **Lock UEFI BIOS Settings** option enables or disables the function that protects items in the ThinkPad Setup program from being changed by a user who does not have the supervisor password. By default, this is set to **Disabled**. If you set the supervisor password and enable this function, no one but you can change any items in the ThinkPad Setup program.

If you select **Set Minimum Length**, you can specify a minimum length for the power-on password and hard disk password. By default, this is set to **Disabled**. If you set the supervisor password and specify a minimum length for passwords, no one but you can change the length.

If you select and enable **Password at unattended boot**, a password prompt is displayed when the computer is turned on, from either a power-off state or hibernation. If you select **Enabled**, no password prompt is displayed; the computer goes ahead and loads the operating system. To prevent unauthorized access, set the user authentication on the operating system.

If you select and enable **Password at restart**, a password prompt is displayed when you restart the computer. If you select **Disabled**, no password prompt is displayed; the computer goes ahead and loads the operating system. To prevent unauthorized access, set the user authentication on the operating system.

Startup menu

You might need to change the startup sequence of your computer. For example, if you have different operating systems on different devices, you can have the system start up from either of them.

Attention: After you change your startup sequence, you must be extremely careful not to specify a wrong device during a copy, a save, or a format operation. If you specify a wrong device, your data and programs might be erased or overwritten.

Attention: If you are using the BitLocker® drive encryption, you should not change the startup sequence. BitLocker drive encryption detects the change of startup sequence and locks the computer from booting.

Changing the startup sequence

Selecting **Startup** to display the **Boot** submenu.

To change the startup sequence, do the following:

1. Select **Boot**; then press Enter.

You can use the **Boot** submenu to specify the startup sequence that runs when you turn on the power. Refer to “Boot submenu” on page 99.

2. Select the device you want to start first.
3. Press F10 to save the changes and restart the system.

To change the startup sequence temporarily so that the system starts up from a different drive, do the following:

1. Turn off the computer.
2. Turn on the computer; then, while the message “To interrupt normal startup, press Enter” is displayed in the lower left corner of the screen, press F12.
3. Select the device you want to start first from the **Boot** menu.

Note: The **Boot** menu will be displayed when the operating system is not found or when the computer cannot boot from any devices.

Boot submenu

The following list, showing the order in which devices will be started up, is always displayed. Even devices that are not attached to or installed on your computer are listed. For each device that is attached to or installed on the computer, information about it is presented after the colon.

1. USB CD:
2. USB FDD:
3. ATAPI CD0:
4. ATA HDD0:
5. USB HDD:
6. PCI LAN:

Other items on the Startup menu

The following items are also displayed on the **Startup** menu of the ThinkPad Setup program:

- **UEFI/Legacy Boot:** Select system boot capability.
- **UEFI/Legacy Boot Priority:** Select priority of boot option between UEFI and Legacy.
- **Boot Mode:** Enable or disable the diagnostics boot mode.
- **Option Key Display:** Choose whether to display the option key message when the system is booted.
- **Boot device List F12 Option:** Choose whether to display the pop-up list of the boot devices.
- **Boot Order Lock:** Enable or disable the Boot Priority Order lock.

Restart menu

If you need to close the ThinkPad Setup program and restart the system, select **Restart** from the ThinkPad Setup program main menu. The following submenu is displayed:

- **Exit Saving Changes:** Restart the system after saving the changes.
- **Exit Discarding Changes:** Restart the system without saving the changes.
- **Load Setup Defaults:** Load the default setting that was in effect at the time of purchase.
- **Discard Changes:** Discard the changes.
- **Save Changes:** Save the changes.

ThinkPad Setup items

This topic provides detailed explanations on the following ThinkPad Setup program menu items:

- “Config menu items” on page 100
- “Security menu items” on page 102
- “Startup menu” on page 104

Note: Some items are displayed on the menu only if the computer supports the corresponding features.

Notes:

- **Enabled** means that the function is configured.
- **Disabled** means that the function is not configured.
- Default values are in **boldface**.

Config menu items

Table 4. Config menu items

Menu item	Submenu item	Selection	Comments
Network	Ethernet LAN Option ROM	<ul style="list-style-type: none"> • Disabled • Enabled 	Loads the Ethernet LAN Option ROM to enable startup from an integrated network device.
	Wireless LAN and WiMAX Radio	<ul style="list-style-type: none"> • On • Off 	If you select "On," the internal wireless radio is turned on. If you select "Off," the internal wireless radio is turned off.
USB	USB UEFI Support	<ul style="list-style-type: none"> • Disabled • Enabled 	Enables or disables boot support for USB diskette and USB CD-ROM.
	Always On USB	<ul style="list-style-type: none"> • Disabled • Enabled 	If you select "Disabled," the external USB devices cannot be charged through USB connectors.
	Always On USB Charge in off mode	<ul style="list-style-type: none"> • Disabled • Enabled 	<p>If you select "Enabled," the Always On USB connector enables you to charge some devices, such as iPod and iPhone and BlackBerry smartphones, by attaching the devices to the connector.</p> <p>Note: If you want to charge these devices when your computer is in hibernation mode or powered off, you will need to open the Power Manager program and configure corresponding settings to enable the Always On USB connector. For details about how to enable the Always On USB connector, refer to the help information system of the Power Manager program.</p>
Keyboard/Mouse	Fn and Ctrl Key swap	<ul style="list-style-type: none"> • Disabled • Enabled 	<p>If you select "Enabled," the Fn key works as the Ctrl key, and the Ctrl key works as the Fn key.</p> <p>Note: Even when "Enabled" is selected, you need to press the Fn key to return the computer from sleep mode to normal operation.</p>
	Fn Key Lock	<ul style="list-style-type: none"> • Disabled • Enabled 	Enable or disable the Fn key lock.

Table 4. Config menu items (continued)

Menu item	Submenu item	Selection	Comments
	Change to “F1–F12 keys”	<ul style="list-style-type: none"> • Default • Legacy 	If you select “Default,” pressing F1–F12 initiates special functions illustrated on each key. If you select “Legacy,” you can use F1–F12 as standard function keys.
Display	Boot Display Device	<ul style="list-style-type: none"> • ThinkPad LCD • Analog (VGA) • Digital on ThinkPad 	Select the display device that is to be activated at boot time. This selection is effective for boot time, password prompt, and ThinkPad Setup.
	Graphics Device	<ul style="list-style-type: none"> • Integrated Graphics • Switchable Graphics 	The Integrated Graphics mode provides longer battery life, while the Switchable Graphics mode enhances performance.
	OS Detection for Switchable Graphics	<ul style="list-style-type: none"> • Disabled • Enabled 	If you select “Enabled,” the system UEFI automatically switches the graphics device setting to Switchable Graphics mode if the operating system supports this feature, and to Integrated Graphics mode if the operating system does not support this feature.
Power	Optical Drive Speed	<ul style="list-style-type: none"> • High Performance • Normal • Silent 	Set the optical drive speed.
	CPU Power Management	<ul style="list-style-type: none"> • Disabled • Enabled 	Unless this power-saving feature is disabled, it stops the processor clock automatically when there is no system activity. You usually do not need to change this function.
	PCI Express Power management	<ul style="list-style-type: none"> • Disabled • Enabled 	Enables or disables a feature that automatically adjusts power management when there is no PCI Express activity. You usually do not need to change this function.

Table 4. Config menu items (continued)

Menu item	Submenu item	Selection	Comments
Beep and Alarm	Power Control Beep	<ul style="list-style-type: none"> • Disabled • Enabled 	If this function is enabled, a beep sounds when the computer enters a power management mode, when it resumes operational mode, and when the ac power adapter is connected or disconnected.
	Low Battery Alarm	<ul style="list-style-type: none"> • Disabled • Enabled 	Enables or disables the low battery alarm.
	Password Beep	<ul style="list-style-type: none"> • Disabled • Enabled 	If you enable this function, a beep sounds when a password prompt is displayed, and again if you type a wrong password.
	Keyboard Beep	<ul style="list-style-type: none"> • Enabled • Disabled 	Enables or disables keyboard beep when unmanageable key combinations are pressed.
Serial ATA (SATA)	SATA Controller Mode Option	<ul style="list-style-type: none"> • Compatibility • AHCI 	Selects SATA controller operation mode. If you select “Compatibility mode,” SATA controller operates in compatibility mode.

Security menu items

Table 5. Security menu items

Menu item	Submenu item	Selection	Comments
Password			Refer to “Security menu” on page 97 and “Using passwords” on page 53.
UEFI BIOS Update Option	Flash BIOS Updating by End-Users	<ul style="list-style-type: none"> • Disabled • Enabled 	If you select “Enabled,” all users can update the UEFI BIOS. If you select “Disabled,” only the person who knows the supervisor password can update the UEFI BIOS.
Memory Protection	Execution Prevention	<ul style="list-style-type: none"> • Disabled • Enabled 	Some computer viruses and worms cause memory buffers to overflow by running code where only data is allowed. If the Data Execution Prevention feature can be used with your operating system, then by selecting “Enabled” you can protect your computer against attacks by such viruses and worms. If after choosing “Enabled” you

Table 5. Security menu items (continued)

Menu item	Submenu item	Selection	Comments
			find that an application program does not run correctly, select “Disabled” and reset the setting.
Virtualization	Intel Virtualization Technology	<ul style="list-style-type: none"> • Disabled • Enabled 	If you select “Enabled,” a VMM (Virtual Machine Monitor) can utilize the additional hardware capabilities provided by Intel Virtualization Technology.
	AMD-V Technology	<ul style="list-style-type: none"> • Disabled • Enabled 	If you select “Enabled,” a VMM (Virtual Machine Monitor) can utilize the additional hardware capabilities provided by Virtualization Technology.
I/O Port Access	Ethernet LAN	<ul style="list-style-type: none"> • Disabled • Enabled 	If you select “Enabled,” you can use the Ethernet LAN device.
	Wireless LAN	<ul style="list-style-type: none"> • Disabled • Enabled 	If you select “Enabled,” you can use the Wireless LAN device.
	<i>Bluetooth</i>	<ul style="list-style-type: none"> • Disabled • Enabled 	If you select “Enabled,” you can use the <i>Bluetooth</i> device.
	USB Port	<ul style="list-style-type: none"> • Disabled • Enabled 	If you select “Enabled,” you can use the USB connectors.
	Optical	<ul style="list-style-type: none"> • Disabled • Enabled 	If you select “Enabled,” you can use the optical device.
	eSATA Port	<ul style="list-style-type: none"> • Disabled • Enabled 	If you select “Enabled,” you can use the eSATA port.
	Memory Card Slot	<ul style="list-style-type: none"> • Disabled • Enabled 	If you select “Enabled,” you can use the Memory Card slot for SD cards or MultiMediaCards.
	Integrated Camera	<ul style="list-style-type: none"> • Disabled • Enabled 	If you select “Enabled,” you can use the integrated camera.
	Microphone	<ul style="list-style-type: none"> • Disabled • Enabled 	If you select “Enabled,” you can use the microphone (internal, external, or line-in).
	Fingerprint Reader	<ul style="list-style-type: none"> • Disabled • Enabled 	If you select “Enabled,” you can use the fingerprint reader.
Anti-Theft	Computrace Module Activation	<ul style="list-style-type: none"> • Disabled • Enabled 	Enables or disables the UEFI BIOS interface to activate the Computrace module. Computrace is an

Table 5. Security menu items (continued)

Menu item	Submenu item	Selection	Comments
		<ul style="list-style-type: none"> Permanently Disabled 	<p>optional monitoring service from Absolute Software.</p> <p>Note: If you set the Computrace module activation to “Permanently Disabled,” you will be unable to enable this setting again.</p>

Startup menu items

Table 6. Startup menu items

Menu item	Selection	Comments
Boot		Refer to “Startup menu” on page 98.
Network Boot		Refer to “Startup menu” on page 98.
UEFI/Legacy Boot	<ul style="list-style-type: none"> Both UEFI Only Legacy Only 	Enables the UEFI/Legacy boot.
UEFI/Legacy Boot Priority	<ul style="list-style-type: none"> UEFI First Legacy First 	Selects priority of boot option between UEFI and Legacy.
Boot Mode	<ul style="list-style-type: none"> Quick Diagnostics 	<p>Screen during POST:</p> <ul style="list-style-type: none"> Quick: The ThinkPad Logo screen is displayed. Diagnostics: Test messages are displayed. <p>Beep at POST completion:</p> <ul style="list-style-type: none"> Quick: No. Sounds on error cases only. Diagnostics: Yes. Always sounds. <p>“Ctrl-S” prompt for on-board Ethernet:</p> <ul style="list-style-type: none"> Quick: No. Diagnostics: Yes. <p>Memory testing during POST:</p> <ul style="list-style-type: none"> Quick: Quick test (or no test). Diagnostics: Full test. <p>Testing other devices during POST:</p> <ul style="list-style-type: none"> Quick: Minimum test (or no test). Diagnostics: Can perform necessary testing for critical devices.

Table 6. Startup menu items (continued)

Menu item	Selection	Comments
		Note: You can also enter the “Diagnostic” mode by pressing Esc during POST.
Option Keys Display	<ul style="list-style-type: none"> • Disabled • Enabled 	If you select “Disabled,” then the message “To interrupt normal startup, press Enter” is not displayed during the POST.
Boot Device List F12 Option	<ul style="list-style-type: none"> • Disabled • Enabled 	If you select “Enabled,” the F12 key is recognized and the Boot Menu is displayed.
Boot Order Lock	<ul style="list-style-type: none"> • Disabled • Enabled 	If you select “Enabled,” the Boot Priority Order is locked for your future use.

Updating your system UEFI BIOS

The Unified Extensible Firmware Interface (UEFI) BIOS is a part of the system programs that make up the basic layer of software built into your computer. The UEFI BIOS translates the instructions from other software layers.

Your computer system board has a module called electrically erasable programmable read-only memory (EEPROM, also referred to as flash memory). You can update the UEFI BIOS and the Configuration/ThinkPad Setup program by starting your computer with a flash update optical disc or flash update tool application running in the Windows environment.

In some instances when you add software, hardware, or a device driver, you might be informed that you need to update your UEFI BIOS in order for the new addition to work properly.

To update your UEFI BIOS, go to the following Web site and follow the instructions on the screen:
<http://www.lenovo.com/ThinkPadDrivers>

Chapter 8. Preventing problems

An important part of owning a ThinkPad notebook computer is maintenance. With proper care, you can avoid common problems. The chapter provides information that can help you keep your computer running smoothly.

- “General tips for preventing problems” on page 107
- “Making sure device drivers are current” on page 108
- “Taking care of your computer” on page 108

General tips for preventing problems

1. Check the capacity of your hard disk drive from time to time. If the hard disk drive gets too full, Windows operating system will slow down and might produce errors. Click **Start → Computer**.
2. Empty your recycle bin on a regular basis.
3. Use disk defragment tool regularly on your hard disk drive to improve data seek and read times.
4. To free up disk space, uninstall unused application programs.
Note: You might also want to look for application program duplication or overlapping versions.
5. Clean out your Inbox, Sent, and Trash folders from your e-mail client program.
6. back up your data at least once a week. If critical data is present, it is a good idea to perform a daily backup. Lenovo has many backup options available for your computer. Rewritable optical drives are available for most machines and can be installed easily.
7. Use or schedule System Restore to take a system snapshot periodically. For more information about System Restore, see Chapter 5 “Recovery overview” on page 63.
8. Update device drivers and UEFI BIOS when needed.
9. Profile your machine at <http://www.lenovo.com/support> to keep up-to-date with current drivers and revisions.
10. Keep up-to-date for device drivers on other non-Lenovo hardware. You might want to read the device driver information release notes prior to updating for compatibility or known issues.
11. Keep a log book. Entries might include major hardware or software changes, driver updates, minor issues you have experienced and how you resolved them.
12. If you ever need to run a recovery on your computer to return the preload onto the machine, the following tips might help along the way:
 - Remove all external devices such as the printer, keyboard, and so on.
 - Make sure that your battery is charged and that you have the ac power connected.
 - Boot into the UEFI and load the default settings.
 - Restart the machine and start the recovery.
 - If your machine uses discs as the recovery media, *do not* remove the disc from the drive until prompted to do so.
13. For suspected hard disk drive issues, refer to “Diagnosing problems” on page 113 and run a diagnostic test of the drive before you call the Customer Support Center. If your computer does not start up, download the files to create a bootable self-test medium from the following Web site: <http://www.lenovo.com/hddtest>. Run the test and record any messages or error codes. If the test returns any failing error codes or messages, call the Customer Support Center with the codes or messages and the computer in front of you. A technician will assist you further.
14. If required, you can find your country's Customer Support Center at the following Web address: <http://www.lenovo.com/support/phone>. When calling the Customer Support Center, make sure you

have your machine model type, serial number and the computer in front of you. Also, if the machine is producing error codes, it is helpful to have the error screen on or the message written down.

Making sure device drivers are current

Device drivers are programs that contain instructions for the operating system about how to operate or “drive” a certain piece of hardware. Each hardware component on your computer has its own specific driver. If you add a new component, the operating system needs to be instructed on how to operate that piece of hardware. After you install the driver, the operating system can recognize the hardware component and understand how to use it.

Note: Because drivers are programs, like any other file on your computer, they are susceptible to corruption and might not perform correctly if corruption occurs.

It is not always necessary to download the latest drivers. However, you should download the latest driver for a component if you notice poor performance from that component or if you added a new component. This may eliminate the driver as the potential cause of the problem.

Getting the latest drivers from the Web site

You can download and install updated device drivers from the Lenovo Web site by doing the following:

1. Connect to the Internet.
2. Go to:
<http://www.lenovo.com/ThinkPadDrivers>
3. Find your computer entry and click it.
4. Follow the directions on the screen and install the necessary software.

Getting the latest drivers using System Update

The System Update program helps you keep the software on your system up-to-date. Update packages are stored on Lenovo servers and can be downloaded from the Lenovo Support Web site. Update packages can contain applications, device drivers, UEFI BIOS flashes, or software updates. When the System Update program connects to the Lenovo Support Web site, the System Update program automatically recognizes the machine type and model of your computer, the installed operating system, and the language of the operating system to determine what updates are available for your computer. The System Update program then displays a list of update packages and categorizes each update as critical, recommended, or optional to help you understand the importance. You have complete control of which updates to download and install. After you select the update packages you want, the System Update program automatically downloads and installs the updates without any further intervention from you.

The System Update program is preinstalled on your computer and is ready to run. The only prerequisite is an active Internet connection. You can start the program manually, or you can use the schedule feature to enable the program to search for updates automatically at specified intervals. You also can predefine scheduled updates to search by severity (critical updates, critical and recommended updates, or all updates) so the list you choose from contains only those update types that are of interest to you.

For more information about how to use System Update, refer to “System Update” on page 23.

Taking care of your computer

Although your computer is designed to function reliably in normal work environments, you need to use common sense in handling it. By following these important tips, you will get the most use and enjoyment out of your computer.

Be careful about where and how you work



Your computer has an Ethernet connector. To avoid the risk of electrical shock, do not connect the telephone cable to the Ethernet connector.

- Store packing materials safely out of the reach of children to prevent the risk of suffocation from plastic bags.
- Keep your computer away from magnets, activated cellular phones, electrical appliances, or speakers (within 13 cm or 5 inches).
- Avoid subjecting your computer to extreme temperatures (below 5°C/41°F or above 35°C/95°F).
- Some appliances, such as certain portable desktop fans or air purifiers, can produce negative ions. If a computer is close to such an appliance, and is exposed for an extended time to air containing negative ions, it may become electrostatically charged. Such a charge may be discharged through your hands when you touch the keyboard or other parts of the computer, or through connectors on I/O devices connected to it. Even though this kind of electrostatic discharge (ESD) is the opposite of a discharge from your body or clothing to the computer, it poses the same risk of a computer malfunction.

Your computer is designed and manufactured to minimize any effects of electrostatic charge. An electrostatic charge above a certain limit, however, can increase the risk of ESD. Therefore, when using the computer close to an appliance that can produce negative ions, give special attention to the following:

- Avoid directly exposing your computer to the air from an appliance that can produce negative ions.
- Keep your computer and peripherals as far as possible from such an appliance.
- Wherever possible, ground your computer to facilitate safe electrostatic discharge.

Note: Not all such appliances cause a significant electrostatic charge.

Be gentle with your computer

- Avoid placing any objects (including paper) between the display and the keyboard or the palm rest.
- Your computer display is designed to be opened and used at an angle slightly greater than 90 degrees. Do not open the display beyond 180 degrees, as this might damage the computer hinge.
- Do not turn your computer over while the ac power adapter is plugged in. This could break the adapter plug.

Carry your computer properly

- Before moving your computer, be sure to remove any media, turn off attached devices, and disconnect cords and cables.
- When picking up your open computer, hold it by the bottom. Do not pick up or hold your computer by the display.

Handle storage media and drives properly

- If your computer comes with an optical drive, do not touch the surface of a disc or the lens on the tray.
- Wait until you hear the CD or DVD click into the center pivot of the drive before closing the tray.
- When installing the hard disk drive or optical drive, follow the instructions shipped with your hardware, and apply pressure only where needed on the device.
- Turn off your computer if you are replacing the hard disk drive.
- When replacing the primary hard disk drive, reattach the cover of the drive slot.

- Store your external and removable hard disk or optical drives in the appropriate containers or packaging when they are not being used.
- Before you install any of the following devices, touch a metal table or a grounded metal object. This action reduces any static electricity from your body. The static electricity could damage the device.
 - Memory module
 - PCI Express Mini Card
 - Memory card, such as SD card, SDHC card, SDXC card, and MultiMediaCard.

Note: Not all listed devices are included in your computer.

This action reduces any static electricity from your body. The static electricity could damage the device.

- When transferring data to or from a flash media card, such as an SD card, do not put your computer in sleep or hibernation mode before the data transfer is complete. To do so might cause damage to your data.

Take care in setting passwords

Remember your passwords. If you forget a supervisor or hard disk password, Lenovo will not reset it, and you might have to replace your system board or hard disk drive.

Care for the fingerprint reader

The following actions could damage the fingerprint reader or cause it not to work properly:

- Scratching the surface of the reader with a hard, pointed object.
- Scraping the surface of the reader with your fingernail or anything hard.
- Using or touching the reader with a dirty finger.

If you notice any of the following conditions, gently clean the surface of the reader with a dry, soft, lint-free cloth:

- The surface of the reader is dirty or stained.
- The surface of the reader is wet.
- The reader often fails to enroll or authenticate your fingerprint.

Register your computer

Register your ThinkPad products with Lenovo at: <http://www.lenovo.com/register>. This can help authorities return your computer to you if it is lost or stolen. Registering your computer also enables Lenovo to notify you about possible technical information and upgrades.

Be sure not to modify your computer

- Only an authorized ThinkPad repair technician should disassemble and repair your computer.
- Do not modify or tape the latches to keep the display open or closed.

Cleaning the cover of your computer

Occasionally clean your computer by doing the following:

1. Prepare a mixture of a gentle kitchen-use detergent (one that does not contain abrasive powder or strong chemicals such as acid or alkaline). Use 5 parts water to 1 part detergent.
2. Absorb the diluted detergent into a sponge.
3. Squeeze excess liquid from the sponge.
4. Wipe the cover with the sponge, using a circular motion and taking care not to let any excess liquid drip.

5. Wipe the surface to remove the detergent.
6. Rinse the sponge with clean running water.
7. Wipe the cover with the clean sponge.
8. Wipe the surface again with a dry, soft lint-free cloth.
9. Wait for the surface to dry completely and remove any fibers from the cloth.

Cleaning your computer keyboard

To clean the computer keyboard, do the following:

1. Apply some isopropyl rubbing alcohol to a soft, dust-free cloth.
2. Wipe each keytop surface with the cloth. Wipe the keys one by one; if you wipe several keys at a time, the cloth might hook onto an adjacent key and possibly damage it. Make sure that no liquid drips onto or between the keys.
3. Allow to dry.
4. To remove any crumbs or dust from beneath the keys, you can use a camera blower with a brush or cool air from a hair dryer.

Note: Avoid spraying cleaner directly onto the display or the keyboard.

Cleaning your computer display

To clean the computer display, do the following:

1. Gently wipe the display with a dry, soft lint-free cloth. If you see a scratchlike mark on your display, it might be a stain transferred from the keyboard or the TrackPoint pointing stick when the cover was pressed from the outside.
2. Wipe or dust the stain gently with a soft, dry cloth.
3. If the stain remains, moisten a soft, lint-free cloth with water or a 50-50 mixture of isopropyl alcohol and water that does not contain impurities.
4. Wring out as much of the liquid as you can.
5. Wipe the display again; do not let any liquid drip into the computer.
6. Be sure to dry the display before closing it.

Chapter 9. Troubleshooting computer problems

This chapter provides information on what to do if you experience a problem with your computer.

This chapter contains the following topics:

- “Diagnosing problems” on page 113
- “Troubleshooting” on page 114

Diagnosing problems

If you experience problems with your computer, use diagnostic solutions as a starting point for solving them.

Depending on the preinstalled operating system and the date when your computer was manufactured, Lenovo provides one of the following diagnostic solutions:

- Lenovo Solution Center: See “Using the Lenovo Solution Center program” on page 113.
- Lenovo ThinkVantage Toolbox: See “Using the Lenovo ThinkVantage Toolbox program” on page 113.
- Web-based diagnostic solutions: See “Using the Lenovo Support Web site” on page 114.

Using the Lenovo Solution Center program

Note: The Lenovo Solution Center program is available only on some models that are preinstalled with the Windows 7 operating system. If your Windows 7 model is not preinstalled with the program, you can download it from <http://www.lenovo.com/support>.

The Lenovo Solution Center program enables you to troubleshoot and resolve computer problems. It combines diagnostic tests, system information collection, security status, and support information, along with hints and tips for maximum system performance.

When you are setting up your computer, the Lenovo Solution Center program prompts you to create recovery media, which you can use to restore the hard disk drive to the factory default state. For more information, see “Creating and using recovery media” on page 63.

To run the Lenovo Solution Center program, see “Accessing applications” on page 19.

For additional information, refer to the Lenovo Solution Center help system.

Note: If you are unable to isolate and repair the problem yourself after running the program, save and print the log files created by the program. You will need the log files when you speak to a Lenovo technical support representative.

Using the Lenovo ThinkVantage Toolbox program

The Lenovo ThinkVantage Toolbox program enables you to view symptoms of computer problems and find solutions for them. It also includes automatic notification when action is required, computing assistance, advanced diagnostics, and diagnostic history.

If the Lenovo ThinkVantage Toolbox program is available on your computer, do either of the following to run the program:

- For Window 7: Click **Start → Control Panel → System and Security → Lenovo - System Healthy and Diagnostics**.

When the application is launched, select a diagnostic test to run. If there is any problem, besides the error messages, a guidance also will be displayed to guide you to fix the problem.

For additional information, refer to the ThinkVantage Toolbox help system.

Note: If you are unable to isolate and repair the problem yourself after running the program, save and print the log files created by the program. You will need the log files when you speak to a Lenovo technical support representative.

Using the Lenovo Support Web site

If your computer has neither the Lenovo Solution Center program nor the Lenovo ThinkVantage Toolbox program installed, go to <http://www.lenovo.com/diagnose> for the latest information on diagnostics for your computer.

Note: Running any test might take up to several minutes or longer. Make sure that you have time to run the entire test. Do not interrupt the test while it is running.

Troubleshooting

If your computer has an error, it typically displays a message or an error code, or a beep sounds when you turn it on. When you experience a problem, refer to the corresponding sections in this topic to try to solve the problem by yourself.

Computer stops responding

Print these instructions now and keep it with your computer for reference later.

If your computer is completely unresponsive (you cannot use the UltraNav pointing device or the keyboard), do the following:

1. Push and hold the power switch until the computer turns off. After the computer is turned off, restart by pressing the power switch. If it does not turn on, continue to step 2.

Note: Do not remove the battery and ac power to reset the computer.

2. While the computer is turned off, remove all power sources from the computer (battery and ac power). Hold down the power button for 10 seconds. Plug in the ac power while keeping the battery out of the computer. If the computer does not turn back on, continue to step 3.

Note: Once the computer starts up and enters Windows environment, use the proper shutdown procedure to turn the computer off. Once the computer is off, reattach the battery and restart the computer. If the computer does not start with the battery reattached, remove the battery and again start with step 2. If the computer starts with ac power but does not start when the battery is attached, call the Customer Support Center for support.

3. While the machine is off, remove all sources of power from the machine (battery and ac power). Remove all external devices that are attached to your computer (keyboard, mouse, printer, scanner, and so on.). Repeat step 2. If step 2 is unsuccessful, continue to step 4.

Note: The following steps involve removing static sensitive components from your computer. Make sure that you are properly grounded and remove all sources of power attached to the computer. If you are uncomfortable or unsure about removing components, call the Customer Support Center for assistance.

4. While the computer is off, remove all sources of power and external hardware. Refer to the procedure in “Replacing a memory module” on page 81 on how to remove and reseat the memory modules. Remove any non-original memory module added to your computer. After removing the extra memory module and reseating the original memory module, repeat step 2. If the computer still does not turn on, consult the user's reference guide for other customer-replaceable components that are attached to your computer.

If the computer still does not start up, call the Customer Support Center and a Customer Support specialist will assist you.

Spills on the keyboard

With a mobile computer, there are increased chances of spilling liquids on the keyboard. Because most liquids conduct electricity, liquid spilled on the keyboard could create numerous short circuits, potentially causing irreparable damage to your computer.

If you spill something on your computer:

Attention: Be sure that no liquid creates a short circuit between you and the ac power adapter (if in use). Although you might lose some data or work by turning off the computer immediately, leaving the computer on might make your computer unusable.

1. Carefully unplug the ac power adapter immediately.
2. Turn off the computer immediately. If the computer does not turn off, remove the battery. The more quickly you stop the current from passing through the computer the more likely you will reduce damage from short circuits.
3. Wipe your computer dry with a paper towel.
4. Before turning on your computer, make sure that all the liquid has dried.

Note: If you want to replace your keyboard, contact the Customer Support Center. Refer to “Calling Lenovo” on page 135.

Error messages

- **Message:** 0175: Bad CRC1, stop POST task.
Solution: The EEPROM checksum is not correct (block #6). Have the computer serviced.
- **Message:** 0177: Bad SVP data, stop POST task.
Solution: Checksum of the supervisor password in the EEPROM is not correct. The system board should be replaced. Have the computer serviced.
- **Message:** 0182: Bad CRC2. Enter ThinkPad Setup and load Setup defaults.
Solution: Checksum of the CRC2 setting in the EEPROM is not correct. Press F1 to go to ThinkPad Setup. Press F9 and then press Enter to load the default setting. Press F10 and then press Enter to restart the system.
- **Message:** 0185: Bad startup sequence settings. Enter ThinkPad Setup and load Setup defaults.
Solution: Checksum of the startup sequence setting in the EEPROM is not correct. Press F1 to go to ThinkPad Setup. Press F9 and then press Enter to load the default setting. Press F10 and then press Enter to restart the system.
- **Message:** 0187: EAIA data access error.
Solution: The access to EEPROM is failed. Have the computer serviced.
- **Message:** 0188: Invalid RFID Serialization Information Area.
Solution: The EEPROM checksum is not correct (block # 0 and 1). The system board should be replaced, and the box serial number needs to be reinstalled. Have the computer serviced.
- **Message:** 0189: Invalid RFID configuration information area.

Solution: The EEPROM checksum is not correct (block # 4 and 5). The system board should be replaced, and the UUID needs to be reinstalled. Have the computer serviced.

- **Message:** 0190: Critical low-battery error.

Solution: The computer turns off, because the battery is low. Connect the ac power adapter to the computer and charge the battery, or replace the battery with a fully charged one.

- **Message:** 0191: System Security - Invalid remote change requested.

Solution: The system configuration change has failed. Confirm the operation and try again. To clear the error, enter the ThinkPad Setup program.

- **Message:** 0199: System Security - Security password retry count exceeded.

Solution: This message is displayed if you enter a wrong supervisor password more than three times. Confirm the supervisor password and try again. To clear the error, enter the ThinkPad Setup program.

- **Message:** 0200: Hard disk error.

Solution: The hard disk is not working. Make sure the hard disk drive is attached firmly. Run the ThinkPad Setup program; then make sure the hard disk drive is not disabled on the **Startup** menu.

- **Message:** 021x: Keyboard error.

Solution: Make sure that there are no objects placed on the keyboard, or if you have one, the external keyboard. Turn off the computer, and turn off all attached devices. Turn on the computer first; then turn on the attached devices.

If you still see the same error code, do the following:

- If an external keyboard is connected, do the following:
 - Make sure that the external keyboard is connected to the correct connector.
 - Turn off the computer and disconnect the external keyboard; then turn on the computer. Make sure that the built-in keyboard operates correctly. If it was, have the external keyboard serviced.
- Test the computer by using the Lenovo ThinkVantage Toolbox program. If the computer stops during the test, have the computer serviced.

- **Message:** 0230: Shadow RAM error.

Solution: The shadow RAM failed. Test your computer memory with Lenovo ThinkVantage Toolbox. If you added a memory module just before turning the computer on, reinstall it. Then test the memory with Lenovo ThinkVantage Toolbox.

- **Message:** 0231: System RAM error.

Solution: The system RAM failed. Test your computer memory with Lenovo ThinkVantage Toolbox. If you added a memory module just before turning the computer on, reinstall it. Then test the memory with Lenovo ThinkVantage Toolbox.

- **Message:** 0232: Extended RAM error.

Solution: The extended RAM failed. Test your computer memory with Lenovo ThinkVantage Toolbox. If you have added a memory module just before turning the computer on, reinstall it. Then test the memory with Lenovo ThinkVantage Toolbox.

- **Message:** 0250: System battery error.

Solution: The backup battery, which is used to preserve the configuration information, such as the date and time, while the computer is tuned off, is depleted. Replace the battery and run ThinkPad Setup to verify the configuration. If you still have a problem, have the computer serviced.

- **Message:** 0251: System CMOS checksum bad.
Solution: The system CMOS might have been corrupted by an application program. The computer uses the default settings. Run ThinkPad Setup to reconfigure the settings. If you still see the same error code, have the computer serviced.
- **Message:** 0260: System timer error.
Solution: Have the computer serviced.
- **Message:** 0270: Real time clock error.
Solution: Have the computer serviced.
- **Message:** 0271: Date and time error.
Solution: Neither the date nor the time is set in the computer. Set the date and time, using ThinkPad Setup.
- **Message:** 0280: Previous boot incomplete.
Solution: Your computer was unable to complete the boot process.
Turn the computer off; then turn it on to start ThinkPad Setup. Verify the configuration and then restart the computer either by choosing the **Exit Saving Changes** option under the **Restart** item or by pressing F10. If you still see the same error code, have the computer serviced.
- **Message:** 02D0: System cache error.
Solution: The cache is disabled. Have the computer serviced.
- **Message:** 02F4: EISA CMOS not writable.
Solution: Have the computer serviced.
- **Message:** 02F5: DMA test failed.
Solution: Have the computer serviced.
- **Message:** 02F6: Software NMI failed.
Solution: Have the computer serviced.
- **Message:** 02F7: Fail-safe timer NMI failed
Solution: Have the computer serviced.
- **Message:** 1802: Unauthorized network card is plugged in - Power off and remove the network card.
Solution: The mini PCI Express network card is not supported on this computer. Remove it.
- **Message:** 1803: Unauthorized daughter card is plugged in - Power off and remove the daughter card.
Solution: The daughter card is not supported on this computer. Remove it.
- **Message:** 1805: Unauthorized Wireless USB card is plugged in - Power off and remove the Wireless USB card.
Solution: The Wireless USB card is not supported on this computer. Remove it.
- **Message:** 2100: Initialization error on HDD0 (Main HDD).
Solution: The hard disk drive is not working. Have the hard disk drive serviced.

- **Message:** 2110: Read error on HDD0 (Main HDD).
Solution: The hard disk drive is not working. Have the hard disk drive serviced.
- **Message:** The power-on password prompt
Solution: A power-on password or a supervisor password is set. Type the password and press Enter to use the computer (refer to “Using passwords” on page 53). If the power-on password is not accepted, a supervisor password might have been set. Type the supervisor password and press Enter. If you still see the same error message, have the computer serviced.
- **Message:** The hard disk password prompt
Solution: A hard disk password is set. Type the password and press Enter to use the computer (refer to “Hard disk passwords” on page 55).
- **Message:** Hibernation error
Solution: The system configuration changed between the time your computer entered hibernation mode and the time it left this mode, and your computer cannot resume normal operation.
 - Restore the system configuration to what it was before your computer entered hibernation mode.
 - If the memory size has been changed, re-create the hibernation file.
- **Message:** Operating system not found.
Solution: Verify the following:
 - The hard disk drive is correctly installed.
 - A startable disc is in the drive.
 If you still see the same error message, check the boot sequence using ThinkPad Setup.
- **Message:** Fan error
Solution: Cooling fan has failed. Have the computer serviced.
- **Message:** EMM386 Not Installed-Unable to Set Page Frame Base Address.
Solution: Edit C:\CONFIG.SYS and change a line from device = C:\WINDOWS\EMM386.EXE RAM to device = C:\WINDOWS\EMM386.EXE NOEMS and save this file.
- **Message:** CardBus Configuration Error-Device Disabled.
Solution: Press F1 to go to ThinkPad Setup. Press F9 and then press Enter to load the default setting. Press F10 and then press Enter to restart the system.
- **Message:** Thermal sensing error
Solution: The thermal sensor is not functioning correctly. Have the computer serviced.
- **Message:** Cannot boot from any device.
Solution: The thermal sensor is not functioning correctly. Have the computer serviced.
 - Device not found
Check the device you want to boot from.
 - Device error
Check the device you want to boot from.
 - No valid operating system
Check that the operating system has no failure and is installed correctly.

Excluded from boot order
Open ThinkPad Setup and add the device to boot order.

Errors without messages

- **Problem:** My screen keeps blanking when I do not want it to.

Solution: You can disable any system timers, such as the LCD turn-off timer or the blank timer by doing the following:

1. Start Power Manager.
2. Click the **Power plan** tab, and then select **Maximum Performance** from the predefined power plans.

- **Problem:** When I turn on the machine, nothing appears on the screen and the machine does not beep while starting up.

Note: If you are not sure whether you heard any beeps, turn off the computer by pressing and holding the power switch for 4 seconds or more. Turn it on and listen again.

Solution: Make sure that:

- The battery is installed correctly.
- The ac power adapter is connected to the computer and the power cord is plugged into a working electrical outlet.
- The computer is turned on. (Turn the power switch on again for confirmation.)

If a power-on password is set:

- Press any key to display the prompt for the power-on password. If the brightness level of the screen is low, increase it by pressing Home.
- Type the correct password and press Enter (refer to Power-on password).

If these items are correctly set, and the screen remains blank, have the computer serviced.

- **Problem:** When I turn on the machine, only a white cursor appears on a blank screen.

Solution: If you have modified a partition on your hard disk drive by using a partition software, information about that partition, or the master boot record might have been destroyed.

1. Turn off the computer, and then turn it on again.
2. If you still see only the cursor on the screen, do the following:
 - If you have used the partition software, examine the partition on the hard disk drive by using the software, and recover the partition if required.
 - Use either the Rescue and Recovery workspace or the recovery discs to restore the system to the factory state. For details about restoring the system to the factory state, see “Creating and using recovery media” on page 63.

If the problem persists, have the computer serviced.

- **Problem:** My screen goes blank while the computer is on.

Solution: Your screen saver or power management may be enabled. Do either of the following:

- Touch the TrackPoint or the touch pad, or press a key to exit the screen saver.
- Press the power switch to resume from sleep or hibernation.

Beep errors

Table 7. Beep errors

Problem	Solution
One short beep, pause, three short beeps, pause, three more short beeps, and one short beep	Make sure that memory modules are installed correctly. If they are, and you still hear the beeps, have the computer serviced.
One long and two short beeps	The video function has a problem. Have the computer serviced.
Five beeps	The system board has a problem. Have the computer serviced.

Memory module problems

Print these instructions now and keep it with your computer for reference later.

If your memory module is not operating properly, check the following items:

1. Verify that the memory module is installed and seated correctly in your computer.

It might be necessary to remove all added memory modules to test the computer with only the factory-installed memory modules, and then reinstall the memory module one at a time to ensure a proper connection. For the procedures to remove and reinstall a memory module, refer to “Replacing a memory module” on page 81.

2. Check for error messages during startup.

Follow the appropriate corrective actions for Power-on self-test (POST) error messages, see “Error messages” on page 115.

3. Verify that the latest UEFI BIOS for your model has been installed.

4. Verify the proper memory configuration and compatibility including the maximum memory size and the memory speed.

For details, refer to the instructions in “Replacing a memory module” on page 81.

5. Run diagnostic programs. See “Diagnosing problems” on page 113.

Networking problems

The following are the most common networking problems.

Ethernet problems

- **Problem:** Your computer cannot connect to the network.

Solution: Make sure that:

- The cable is installed properly.

The network cable must be securely connected both to the Ethernet connector of your computer and to the RJ45 connector of the hub. The maximum allowable distance from the computer to hub is 100 meters. If the cable is connected and the distance is within acceptable limits but the problem persists, try a different cable.

- You are using the correct device driver.

1. Click **Start → Control Panel → Hardware and Sound → Device Manager**. If you are prompted for an administrator password or confirmation, type the password or provide confirmation.
2. If the ! mark is to the left of the adapter name under **Network adapters**, you might not use the correct driver or the driver is not enabled. To update the driver, right-click the highlighted adapter.

3. Click **Update Driver Software**, and then follow the instructions on the screen.

- The switch port and the adapter have the same duplex setting.

If you configured the adapter for full duplex, make sure the switch port is also configured for full duplex. Setting the wrong duplex mode can degrade performance, cause data loss, or result in lost connections.

- You have installed all networking software that is necessary for your network environment.

Check with your LAN administrator for the necessary networking software.

- **Problem:** The adapter stops working for no apparent reason.

Solution: The network driver files might be corrupt or missing. Update the driver by referring to the “Solution” description in the preceding problem for the procedure to make sure that the correct device driver is installed

- **Problem:** If your computer is a Gigabit Ethernet model and you use the a speed of 1000 Mbps, the connection fails or errors occur.

Solution:

- Use Category 5 wiring and make sure that the network cable is securely connected.
- Connect to a 1000 BASE-T hub/switch (not 1000 BASE-X).

- **Problem:** Your computer cannot connect to the network at 1000 Mbps. Instead, it connects at 100 Mbps.

Solution:

- Try another cable.
- Make sure that the link partner is set to auto-negotiate.
- Make sure that the switch is 802.3ab-compliant (gigabit over copper).

A wireless LAN problem

- **Problem:** You cannot connect using the built-in wireless network card.

Solution: Make sure that your wireless LAN driver is the latest version installed. Check the Web site and confirm the driver version supported by Access Connections is the latest documented in the readme file.

Make sure that your computer is within range of a wireless access point.

Make sure that the wireless radio is enabled by double-clicking the Access Connections icon on the taskbar.

Note: For instructions on how to display the Access Connections status icon and the wireless status icon in the Windows notification area, refer to the Access Connections help information system.

Check Network Name (SSID) and your encryption information. Use the Access Connections program to verify this case-sensitive information.

Bluetooth problems

- **Problem:** Sound does not come from the Bluetooth headset or headphone but comes from the local speaker even though the headset or headphone is connected using a Headset profile or AV profile.

Solution: Do the following:

1. Exit the application that uses the sound device (for example, Windows Media Player).
2. Open Control Panel by clicking **Start → Control Panel**, and click **Hardware and Sound → Sound** then select the **Playback** tab.
3. If you are using a Headset profile, select **Bluetooth Hands-free Audio** and click the **Set Default** button. If you are using an AV profile, select **Stereo Audio** and click the **Set Default** button.
4. Click **OK** to close the Sound window.

- **Problem:** PIM (Personal Information Manager) items sent from Windows 7 operating system cannot be received correctly into the address book of any other Bluetooth-enabled device.

Solution: Windows 7 operating system sends PIM items in XML format, but most Bluetooth-enabled devices handle PIM items in vCard format. If another Bluetooth-enabled device can receive a file through Bluetooth, a PIM item sent from Windows 7 operating system might be saved as a file with the extension .contact.

Problems with the keyboard and other pointing devices

The following are the most common problems with keyboards and other pointing devices.

UltraNav problems

Problem: The pointer drifts when the computer is turned on or after it resumes normal operation.

Solution: The pointer might drift when you are not using the TrackPoint pointing device during normal operation. This is a normal characteristic of the TrackPoint pointing device and is not a defect. Pointer drifting might occur for several seconds under the following conditions:

- When the computer is turned on
- When the computer resumes normal operation
- When the TrackPoint pointing device is pressed for a long time
- When the temperature changes

Problem: The TrackPoint pointing device or touch pad does not work.

Solution: Make sure that the TrackPoint pointing device or touch pad is enabled in the UltraNav Device Setting window.

Note: To open the UltraNav Device Setting window, Click **Start → Control Panel → Hardware and Sound → Mouse**, and then click the **UltraNav** tab.

Keyboard problems

- **Problem:** All or some keys on the keyboard do not work.

Solution: Make sure that the correct device driver is installed.

1. Click **Start → Control Panel**. Change the view of the Control Panel from Category to Large icons or Small icons.
2. Click **Keyboard**.
3. Select the **Hardware** tab. In the Device Properties section, make sure that the Device Status is **This device is working properly**.

If keys on the keyboard still do not work, have the computer serviced.

- **Problem:** All or some keys on the external numeric keypad do not work.

Solution: Make sure that the external numeric keypad is correctly connected to the computer.

Display and multimedia devices

This section includes the most common display and multimedia devices problems which are Computer screen, External monitor, Audio, and Optical drive. Check these topics to learn more information.

Computer screen problems

- **Problem:** The screen is blank.

Solution: Do the following:

- Press F6 to bring up the image.
- If you are using the ac power adapter, or using the battery and the Power Manager battery gauge shows that the battery is not depleted, press F8 to make the screen brighter.
- If your computer is in sleep mode, press Fn to resume from the sleep mode.
- If the problem persists, follow the solution for the following problem.

- **Problem:** The screen is unreadable or distorted.

Solution: Make sure that:

- The display device driver is installed correctly.
- The screen resolution and color quality are correctly set.
- The monitor type is correct.

To check these settings, do the following:

1. Right-click on the desktop, and click **Screen resolution**.
2. Click **Advanced Settings**.
3. Click the **Adapter** tab.
4. Make sure that the correct device driver name is shown in the adapter information window.

Note: The device driver name depends on the video chip that has been installed on your computer.

5. Click the **Properties** button. If you are prompted for an administrator password or confirmation, type the password or provide confirmation. Check the “Device status” box and make sure the device is working properly. If not, click the **Troubleshoot** button. Close the **Properties** window.
6. Click the **Monitor** tab. Check whether the color quality is correctly set. Make sure other information is also correct.
7. Click the **Properties** button. If you are prompted for an administrator password or confirmation, type the password or provide confirmation. Check the “Device status” box and make sure the device is working properly. If not, click the **Troubleshoot** button.

- **Problem:** Incorrect characters appear on the screen.

Solution: Did you install the operating system or application program correctly? If they are installed and configured correctly, have the computer serviced.

- **Problem:** The screen stays on even after you turn off your computer.

Solution: Press and hold the power switch for 4 seconds or more to turn off your computer; then turn it on again.

- **Problem:** Missing, discolored, or bright dots appear on the screen every time you turn on your computer.

Solution: This is an intrinsic characteristic of the TFT technology. Your computer display contains multiple thin-film transistors (TFTs). A small number of missing, discolored, or bright dots on the screen might exist all the time.

External monitor problems

- **Problem:** The external monitor is blank.

Solution: To bring up the image, press F6 and select the desired monitor. If the problem persists, do the following:

1. Connect the external monitor to another computer to make sure it works.
2. Reconnect the external monitor to your computer.

3. Refer to the manual shipped with the external monitor to check the resolutions and refresh rates that are supported.
 - If the external monitor supports the same resolution as the computer display or a higher resolution, view output on the external monitor or on both the external monitor and the computer display.
 - If the external monitor supports a lower resolution than the computer display, view output on the external monitor only. (If you view output on both the computer display and the external monitor, the external monitor screen will be blank or distorted.)

Problem: You cannot set a higher resolution than the present one on your external monitor.

Solution:

- Make sure that monitor information is correct. Do the following:

1. Right-click on the desktop, and click **Screen resolution**.

Note: If your computer cannot detect the external monitor, click the **Detect** button.

2. Click the icon for the desired monitor (the **Monitor-2** icon is for the external monitor).
3. Click **Advanced Settings**.
4. Click the **Adapter** tab.
5. Make sure that the correct device driver name is shown in the adapter information window.

Note: The device driver name depends on the video chip that has been installed on your computer.

6. Click **OK**.

If the information is incorrect, reinstall the device driver. See below for more information.

- Check the monitor type and, if necessary, update the driver by doing the following:

1. Connect the external monitor to the monitor connector, and then connect the monitor to an electrical outlet.
2. Turn on the external monitor and the computer.
3. Right-click on the desktop, and click **Screen resolution**.

Note: If your computer cannot detect the external monitor, click the **Detect** button.

4. Click the icon for the desired monitor (the **Monitor-2** icon is for the external monitor).
5. Click **Advanced Settings**.
6. Click the **Monitor** tab. Check the monitor information window to make sure that the monitor type is correct. If it is, click **OK** to close the window; otherwise do the following.
7. If more than one monitor type is displayed, select **Generic PnP Monitor** or **Generic Non-PnP Monitor**.
8. Click **Properties**. If you are prompted for an administrator password or confirmation, type the password or provide confirmation.
9. Click the **Driver** tab.
10. Click **Update Driver**.
11. Click **Browse my computer for driver software**, and then click **Let me pick from a list of device drivers on my computer**.
12. Clear the **Show compatible hardware** check box.
13. Select your monitor manufacturer and model.
14. After updating the driver, click **Close**.
15. Set **Resolution**.

Note: To change the color settings, select the **Monitor** tab, then set **Colors**.

16. Click **OK**.

- **Problem:** The screen is unreadable or distorted.

Solution: Make sure that the monitor information is correct. (Refer to the “Solution” to “Problem: You cannot set a higher resolution than the present one on your external monitor.” on page 124.)

Make sure that the appropriate monitor type is selected. (Refer to the “Solution” to “Problem: You cannot set a higher resolution than the present one on your external monitor.” on page 124)

Make sure that an appropriate refresh rate is selected by doing the following:

1. Connect the external monitor to the monitor connector, and then connect the monitor to an electrical outlet.
2. Turn on the external monitor and the computer.
3. Right-click on the desktop, and click **Screen resolution**.

Note: If your computer cannot detect the external monitor, click the **Detect** button.

4. Click the icon for the desired monitor (the **Monitor-2** icon is for the external monitor).
5. Click **Advanced Settings**.
6. Click the **Monitor** tab.
7. Select the correct screen refresh rate.

- **Problem:** Wrong characters appear on the screen.

Solution: Did you follow the correct procedure in installing the operating system or application program? If you did, have the external monitor serviced.

- **Problem:** The Extend desktop function does not work.

Solution: Enable the Extend desktop function by doing the following:

1. Connect the external monitor to the monitor connector, and then connect the monitor to an electrical outlet.
2. Turn on the external monitor and the computer.
3. Right-click on the desktop, and click **Screen resolution**.
4. Click the **Monitor-2** icon.
5. Select **Extend these displays** for multiple displays.
6. Click the **Monitor-1** icon (for the primary display, the computer display).
7. Select the resolution of the primary display.
8. Click the **Monitor-2** icon (for the external monitor).
9. Select the resolution of the secondary display.
10. Set the relative position of each monitor by dragging its icon. You can set the monitors in any relative position, but the icons must touch each other.
11. Click **OK** to apply the changes.

Note: To change the color settings, right-click on the desktop, and click **Screen resolution**. Click **Advanced Settings**, select the **Monitor** tab, then set **Colors**.

- **Problem:** Display switching does not work.

Solution: If you use the Extend desktop function, disable it, and change the display output location. If a DVD movie or a video clip is playing, stop the playback, close the application, and then change the display output location.

- **Problem:** If you use the Extend desktop function, you cannot set a higher resolution or higher refresh rate on the secondary display.

Solution: Change the resolution and the color depth to lower settings for the primary display by doing the following:

Change the resolution depth to lower settings for the primary display. Refer to the “Solution” for “The Extend desktop function does not work” above.

- **Problem:** The screen position on the external monitor is incorrect when that monitor is set for a high resolution.

Solution: Sometimes, when you use a high resolution such as 1600x1200, the image is shifted to left or right on the screen. To correct this, first make sure that your external monitor supports the display mode (the resolution and the refresh rate) that you have set. If it does not, set a display mode that the monitor supports. If it does support the display mode you have set, go to the setup menu for the monitor itself and adjust the settings there. Usually the external monitor has buttons for access to the setup menu. For details, see the reference manual for the monitor.

Audio problems

- **Problem:** Wave or MIDI sound does not play correctly.

Solution: Make sure the built-in audio device is configured correctly.

1. Click **Start → Control Panel → Hardware and Sound → Device Manager**. If you are prompted for an administrator password or confirmation, type the password or provide confirmation.
2. Double-click **Sound, video and game controllers**.
3. Make sure the Conexant Pebble High Definition SmartAudio device is enabled and configured correctly.

- **Problem:** Recordings made by using the microphone input are not loud enough.

Solution: Make sure that Microphone Boost is turned on and set as follows:

1. Click **Start → Control Panel → Hardware and Sound → Sound**.
2. Click the **Recording** tab in the Sound window.
3. Select **Microphone**, and click the **Properties** button.
4. Click the **Levels** tab, and move the **Microphone Boost** slider upwards.
5. Click **OK**.

Note: For details about controlling volume, refer to your Windows help information system.

- **Problem:** A volume or balance slider cannot be moved.

Solution: The slider might be dimmed. This means that its position is fixed by the hardware and cannot be changed.

- **Problem:** The volume sliders do not stay in place when some audio applications are used.

Solution: It is normal for the sliders to change position when certain sound applications are used. An example is the Windows Media Player. Usually the application has sliders available to control the sound from within the application.

- **Problem:** The balance slider cannot completely mute one channel.

Solution: The control is designed to compensate for minor differences in balance and does not completely mute either channel.

- **Problem:** There is no volume control for MIDI sound in the Volume Mixer window .

Solution: Use the hardware volume control. This is because the built-in synthesizer software does not support the control.

- **Problem:** The sound cannot be turned off completely even if you set the master volume control at minimum.

Solution: You can still hear some sound even though you have set the master volume control at minimum. To turn off the sound completely, go to the master volume control window and select **Mute speakers**.

Fingerprint reader problems

- **Problem:** The surface of the reader is dirty, stained, or wet.

Solution: Gently clean the surface of the reader with a dry, soft, lint-free cloth.

- **Problem:** The reader often fails to enroll or authenticate your fingerprint.

Solution: If the surface of the reader is dirty, stained, or wet, gently clean the surface of the reader with a dry, soft, lint-free cloth.

If your finger has any of the following conditions, you might not be able to register or authenticate it:

- Your finger is wrinkled.
- Your finger is rough, dry, or injured.
- Your finger is very dry.
- Your finger is stained with dirt, mud, or oil.
- The surface of your finger is very different from when you enrolled your fingerprint.
- Your finger is wet.
- A finger that has not been enrolled is used.

To improve the situation, try the following:

- Clean or wipe your hands to remove any excess dirt or moisture from the fingers.
- Enroll and use a different finger for authentication.
- If your hands are too dry, apply lotion to them.

Battery and power problems

This section tells what to do if you have a battery and power problem.

This section includes five topics: Battery, ac power adapter, Power, Power button, Startup and Sleep and hibernation. Check these topics to find the related information.

Battery problems

Problem: The battery pack cannot be fully charged by the power-off method in the standard charge time for your computer.

Solution: The battery pack might be over-discharged. Do the following:

1. Turn off the computer.
2. Make sure that the over-discharged battery pack is in the computer.
3. Connect the ac power adapter to the computer and let it charge.

If a quick charger is available, use it to charge the over-discharged battery pack.

If the battery pack cannot be fully charged in 24 hours, use a new battery pack.

Problem: Your computer shuts down before the battery status indicator shows empty, or your computer operates after the battery status indicator shows empty.

Solution: Discharge and recharge the battery pack.

Problem: The operating time for a fully charged battery pack is short.

Solution: Discharge and recharge the battery pack. If your battery operating time is still short, use a new battery pack.

Problem: The computer does not operate with a fully charged battery pack.

Solution: The surge protector in the battery pack might be active. Turn off the computer for one minute to reset the protector; then turn on the computer again.

Problem: The battery pack cannot be charged.

Solution: You cannot charge the battery when it is too hot. If the battery feels hot, remove it from the computer and allow it to cool to room temperature. After it cools, reinstall it and recharge the battery. If it still cannot be charged, have it serviced.

AC power adapter problems

Problem: The ac power adapter is connected to the computer and the working electrical outlet, but the power adapter (power plug) icon is not displayed on the taskbar. Also the ac power indicator does not light up.

Solution: Do the following:

1. Make sure that the connection of the ac power adapter is correct. For connecting the ac power adapter, see *Setup Instructions* that comes with your computer.
2. If the above step is correct, turn off the computer, then disconnect the ac power adapter and remove the main battery.
3. Reinstall the battery and reconnect the ac power adapter, then turn on the computer.
4. If the power adapter icon still does not appear on the taskbar and the ac power indicator does not light up, have the ac power adapter and your computer serviced.

Note: To display the power adapter (power plug) icon, click **Show hidden icons** on the taskbar.

Power problems

Print these instructions now and keep it with your computer for reference later.

If your computer is getting no power at all, check the following items:

1. Verify the power switch. Refer to “System status indicators” on page 12. The power switch is lit whenever the computer is on.
2. Check all power connections. Remove any power strips and surge protectors to connect the ac power adapter directly to the ac power outlet.
3. Inspect the ac power adapter. Check for any physical damage, and make sure that the power cable is firmly attached to the adapter brick and the computer.
4. Verify the ac power source is working by attaching another device to the outlet.
5. Remove all devices and then test for system power with minimal devices attached.

- a. Disconnect the ac power adapter and all cables from the computer.
- b. Close the computer display, and turn the computer over.
- c. Remove the battery. Refer to “Replacing the battery” on page 69.
- d. Remove the memory module. Refer to “Replacing a memory module” on page 81.
- e. Remove the PCI Express Mini Card. Refer to “Replacing a PCI Express Mini Card for wireless LAN connection” on page 78.
- f. Remove the hard disk drive. Refer to “Replacing the hard disk drive” on page 71 .
- g. Wait for 30 seconds, and then reinstall the memory module and the known good battery or the ac power adapter to test the computer with minimal devices attached first.
- h. Reinstall each device one at a time that you have removed in the earlier steps.

If your computer does not run on battery power, check the following items:

1. Remove and reseat the battery to make sure that it is properly connected. Refer to “Replacing the battery” on page 69.
2. Swap batteries with another similar model, if available.
If another similar ThinkPad model is available, then verify that the battery pack works in the other computer and that the battery pack for the other model works in this computer.
3. Verify the battery-status indicator. Refer to “Power status indicator” on page 13.

A power button problem

- **Problem:** The system does not respond, and you cannot turn off the computer.
Solution: Turn off the computer by pressing and holding the power button for 4 seconds or more. If the system is still not reset, remove the ac power adapter and the battery.

Startup problems

Print these instructions now and keep them with your computer for reference later.

If you receive an error message before the operating system loads, follow the appropriate corrective actions for Power-on self-test error messages.

If you receive an error message while the operating system is loading the desktop configuration after the POST is completed, check the following items:

1. Go to the Lenovo Support Web site at <http://www.lenovo.com/support> and search for the error message.
2. Go to the Microsoft Knowledge Base homepage at <http://support.microsoft.com/> and search for the error message.

Sleep and hibernation problems

- **Problem:** The computer enters sleep mode unexpectedly.
Solution: If the processor overheats, the computer automatically enter sleep mode to allow the computer to cool and to protect the CPU and other internal components. Check the settings for sleep mode, using Power Manager.
- **Problem:** The computer enters sleep mode (the sleep indicator turns on) immediately after the POST.
Solution: Make sure that:
 - The battery is charged.
 - The operating temperature is within the acceptable range. Refer to “Features” on page 15, “Specifications” on page 18, and “Operating environment” on page 18.

If the battery is charged and the temperature is within range, have the computer serviced.

- **Problem:** The message “critical low-battery error” is displayed, and the computer immediately turns off.

Solution: The battery power is getting low. Connect the ac power adapter to the computer and plug it into an electrical outlet, or replace the battery with a charged one.

- **Problem:** The computer display remains blank after you press Fn to return from sleep mode.

Solution: Check whether an external monitor was disconnected or turned off while the computer was in sleep mode. If you disconnected or turned off the external monitor, connect it or turn it on before resuming the computer from the sleep mode. When resuming the computer from the sleep mode without attaching the external monitor or turning it on, and the computer display remains blank, press F6 to bring up the computer display.

- **Problem:** The computer does not return from sleep mode, or the system status indicator (illuminated ThinkPad logo) blinks slowly and the computer does not work.

Solution: If the system does not return from sleep mode, it might have entered sleep or hibernation mode automatically because the battery is depleted. Check the sleep indicator.

- If the system status indicator (illuminated ThinkPad logo) blinks slowly, your computer is in sleep mode. Connect the ac power adapter to the computer; then press Fn.
- If the system status indicator (illuminated ThinkPad logo) is off, your computer is in power-off state or in hibernation mode. Connect the ac power adapter to the computer; then press the power button to resume operation.

If the system still does not return from sleep mode, your system may stop responding and you might not be able to turn off the computer. In this case, you need to reset the computer. If you have not saved your data, it might be lost. To reset the computer, press and hold the power button for 4 seconds or more. If the system is still not reset, remove the ac power adapter and the battery.

- **Problem:** Your computer does not enter sleep or hibernation mode.

Solution: Check whether any option has been selected to disable your computer from entering sleep or hibernation mode.

If your computer tries to enter sleep mode but the request is rejected, the device in the USB connector might be disabled. If this occurs, do a hot-unplug-and-plug operation for the USB device.

- **Problem:** The battery discharges slightly while the computer is in hibernation mode.

Solution: If the wakeup function is enabled, the computer consumes a small amount of power. This is not a defect. For details, refer to “Power-saving modes” on page 36.

Problems with drives and other storage devices

This section includes hard disk drive problems and optical drive problems.

Hard disk drive problems

Problem: The hard disk drive makes a rattling noise intermittently.

Solution: The rattling noise might be heard:

- When the hard disk drive begins or finishes getting access to data.
- When you carry the hard disk drive.
- When you carry your computer.

This is a normal characteristic of a hard disk drive and is not a defect.

Problem: The hard disk drive does not work.

Solution: On the startup menu of ThinkPad Setup, make sure that the hard disk drive is on the “Boot priority order” list. If it is on the “Excluded from boot order” list, it is disabled. Select the entry for it on the list and press the Shift+1 key. This moves the entry to the “Boot priority order” list.

Problem: After setting a hard disk password on the hard disk drive of the computer, you moved the drive to another computer. Now you cannot unlock the hard disk password.

Solution: Your computer supports an enhanced password algorithm. Computers older than yours may not support such a security function.

Optical drive problems

- **Problem:** The optical drive, such as a CD, DVD, or CD-RW drive, does not work.

Solution: Make sure that the computer is turned on and a CD, DVD, or CD-RW is properly loaded on the center pivot of the drive. (You should hear a click.)

Make sure that the drive connector is firmly connected to the computer. If you use an option that has a bay for installing the drive, make sure that the option is firmly connected to the computer and works properly.

Make sure that the drive tray is firmly closed.

Make sure that the device drivers are correctly installed.

- **Problem:** You hear a noise from the drive when the CD, DVD, or CD-RW is spinning.

Solution: If the disc is not properly loaded on the center pivot of the drive, it might rub against the drive cover and make a noise. Make sure that the disc is loaded properly in the drive.

- **Problem:** The tray does not open even if you press the eject button.

Solution: When your computer is not turned on, pressing the eject button does not cause the drive tray to open. Make sure that the computer is turned on and that the drive connector is firmly connected to the computer.

If the tray still does not open, make sure that the computer is running, and insert the end of a straightened paper clip into the emergency eject hole. The tray will open.

- **Problem:** An optical medium, such as a CD, a DVD, or a CD-RW, cannot be read.

Solution: Make sure that the CD, DVD, or CD-RW is not dirty. If it is, clean it with a cleaner kit.

Test another CD, DVD, or CD-RW. If the computer can read the other CD, DVD, or CD-RW, the first CD, DVD, or CD-RW might be defective

Make sure that the CD, DVD, or CD-RW is loaded on the center pivot of the drive with the label side up. (You should hear a click.)

Make sure that the CD, DVD, or CD-RW is in one of the following formats:

- Music CD
- CD-ROM or CD-ROM XA
- Multisession photo CD
- Video CD
- DVD-ROM (DVD-video)

- **Problem:** The computer cannot play a CD, or the sound quality is not good.

Solution: Be sure that the disk meets the standards for your country. Usually, a disk that meets the local standards is marked with a CD logo on the label. If you use a disc that does not meet these standards, we cannot guarantee that it will play, or that, if it does play, the sound quality will be good.

- **Problem:** WinDVD8 has an HD DVD tab, but I cannot use it.
Solution: Your computer does not support an HD DVD drive.

Software problems

Problem: An application does not run correctly.

Solution: Make sure that the problem is not being caused by the application.

Check that your computer has the minimum required memory to run the application. Refer to the manuals supplied with the application.

Check the following:

- The application is designed to operate with your operating system.
- Other applications run correctly on your computer.
- The necessary device drivers are installed.
- The application works when it is run on some other computer.

If an error message is displayed while you are using the application program, refer to the manuals supplied with the application.

If the application still does not run correctly, contact your place of purchase or a service representative for help.

Problems with ports and connectors

The following are the most common ports and connectors problems:

USB problems

- **Problem:** A device connected to the USB connector does not work.

Solution: Open the Device Manager window. Make sure that the USB device setup is correct, and that the assignment of computer resource and the installation of the device driver are correct. Click **Start → Control Panel → Hardware and Sound → Device Manager**. If you are prompted for an administrator password or confirmation, type the password or provide confirmation.

Refer to “Diagnosing problems” on page 113 and run a diagnostic test of the USB connector.

Chapter 10. Getting support

There is more to owning a ThinkPad Notebook than having a powerful, portable computer. This chapter provides information about getting help and support from Lenovo.

This chapter contains the following topics:

- “Before you contact Lenovo” on page 133
- “Getting help and service” on page 134
- “Purchasing additional services” on page 136

Before you contact Lenovo

Often, you can solve your computer problems by referring to the information in the explanations of error codes, running the diagnostic programs, or by consulting the ThinkPad Web site.

Registering your computer

To register your ThinkPad products with Lenovo, go to: <http://www.lenovo.com/register>. This can help authorities return your computer to you if it is lost or stolen. Registering your computer also enables Lenovo to notify you about possible technical information and upgrades.

For more information about registering your computer, refer to “Registering your computer” on page 25.

Downloading system updates

Downloading updated software might resolve problems you experience with your computer.

To download updated software, go to the following Web site and follow the instructions on the screen: <http://www.lenovo.com/ThinkPadDrivers>.

Recording information

Before you talk to a Lenovo representative, record the following important information about your computer.

Recording problem symptoms and details

Collect the answers to the questions below before you call for help. Then, you will be able to get help as quickly as possible.

- What is the problem? Is it continuous or intermittent?
- Is there an error message? What is the error code, if any?
- What operating system are you using? Which version?
- Which software applications were running at the time of the problem?
- Can the problem be reproduced? If so, how?

Recording system information

The serial number label is on the bottom of your computer. Record the machine type and the serial number.

- What is the name of your Lenovo product?
- What is the machine type?
- What is the serial number?

Getting help and service

If you need help, service, technical assistance, or just want more information about Lenovo products, you will find a wide variety of sources available from Lenovo to assist you. This section contains information about where to go for additional information about Lenovo and our products, what to do if you experience a problem with your computer, and whom to call for service should it be necessary.

Information about your computer and preinstalled software, if any, is available in the documentation that comes with your computer. That documentation includes printed books, online books, readme files, and help files. In addition, information about Lenovo products is available on the World Wide Web.

Microsoft Service Packs are the latest software source for Windows product updates. They are available through Web download (connection charges may apply) or through disc. For more specific information and links, go to: <http://www.microsoft.com>. Lenovo offers technical assistance with installation of, or questions related to, Service Packs for your Lenovo-preloaded Microsoft Windows product. For information, contact the Customer Support Center.

Using diagnostic programs

Many computer problems can be solved without outside assistance. If you experience a problem with your computer, the first place to start is the troubleshooting information of your computer documentation. If you suspect a software problem, see the documentation, including readme files and help information system, that comes with the operating system or application program.

ThinkPad notebook computers come with a set of diagnostic programs that you can use to help you identify hardware problems. See “Diagnosing problems” on page 113 for instructions on using the diagnostic programs.

The Troubleshooting information or the diagnostic programs might tell you that you need additional or updated device drivers or other software. Lenovo maintains pages on the World Wide Web where you can get the latest technical information and download device drivers and updates.

Lenovo Support Web site

Technical support information is available on the Lenovo Support Web site at:
<http://www.lenovo.com/support>

This portal is updated with the latest information about the following subjects:

Download Drivers & Software

Download drivers, flash the BIOS, and update your software.

Diagnose & Fix

Use self-diagnostic tools to diagnose the problem yourself, search community boards, or work with our Virtual Agent to answer questions.

Product & Service Warranty

Check your warranty status and upgrade your warranty.

Product & Parts Detail

Find part numbers for replacement parts, learn how to replace parts, and view other parts information related to your product.

User Guides & Manuals

Read or download the documentation related to your product.

KnowledgeBase & FAQ

Search the community knowledge base for your computer to share and discover information with other users.

Calling Lenovo

If you have tried to correct the problem yourself and still need help, during the warranty period, you can get help and information by telephone through the Customer Support Center. The following services are available during the warranty period:

- Problem determination - Trained personnel are available to assist you with determining if you have a hardware problem and deciding what action is necessary to fix the problem.
- Lenovo hardware repair - If the problem is determined to be caused by Lenovo hardware under warranty, trained service personnel are available to provide the applicable level of service.
- Engineering change management - Occasionally, there might be changes that are required after a product has been sold. Lenovo or your reseller, if authorized by Lenovo, will make selected Engineering Changes (ECs) available that apply to your hardware available.

The following items are not covered:

- Replacement or use of parts not manufactured for or by Lenovo or nonwarranted parts

Note: All warranted parts contain a 7-character identification in the format FRU XXXXXXXX.

- Identification of software problem sources
- Configuration of UEFI BIOS as part of an installation or upgrade
- Changes, modifications, or upgrades to device drivers
- Installation and maintenance of network operating systems (NOS)
- Installation and maintenance of application programs

For the terms and conditions of the Lenovo Limited Warranty that applies to your Lenovo hardware product, see “Warranty information” in the *Safety and Warranty Guide* that comes with your computer.

If possible, be near your computer when you make your call in case the technical assistance representative needs to help you resolve a computer problem. Ensure that you have downloaded the most current drivers and system updates, run diagnostics, and recorded information before you call. When calling for technical assistance, have the following information available:

- Machine Type and Model
- Serial numbers of your computer, monitor, and other components, or your proof of purchase
- Description of the problem
- Exact wording of any error messages
- Hardware and software configuration information for your system

Telephone numbers

For a list of the Lenovo Support phone numbers for your country or region, go to <http://www.lenovo.com/support/phone> or refer to the *Safety and Warranty Guide* that comes with your computer.

Note: Phone numbers are subject to change without notice. The latest phone numbers are available at <http://www.lenovo.com/support/phone>. If the number for your country or region is not provided, contact your Lenovo reseller or Lenovo marketing representative.

Finding ThinkPad options

If you want to expand the capabilities of your computer, Lenovo has a number of hardware accessories and upgrades to meet your needs. Options include memory module, storage, network cards, and port replicators, batteries, power adapters, printers, scanners, keyboards, mice, and more.

You can shop at Lenovo 24 hours a day, 7 days a week directly over the World Wide Web. All you need is an Internet connection and a credit card.

To shop at Lenovo, go to:
<http://www.lenovo.com/accessories/services/index.html>

Purchasing additional services

During and after the warranty period, you can purchase additional services, such as support for Lenovo and non-Lenovo hardware, operating systems, and application programs; network setup and services; upgraded or extended hardware repair services; and custom installation services. Service availability and service name might vary by country.

For more information about these services, go to:
<http://www.lenovo.com/accessories/services/index.html>

Appendix A. Regulatory information

Wireless related information

Wireless interoperability

Wireless LAN PCI Express Mini Card is designed to be interoperable with any wireless LAN product that is based on Direct Sequence Spread Spectrum (DSSS), Complementary Code Keying (CCK), and/or Orthogonal Frequency Division Multiplexing (OFDM) radio technology, and is compliant to:

- The 802.11b/g Standard, 802.11a/b/g or 802.11n on Wireless LANs, as defined and approved by the Institute of Electrical and Electronics Engineers.
- The Wireless Fidelity (WiFi) certification as defined by the Wi-Fi Alliance.

Bluetooth device is designed to be interoperable with any Bluetooth product that is compliant to Bluetooth Specification 2.1+EDR as defined by the Bluetooth SIG. The following profiles are supported by Bluetooth device:

- Generic Access
- Service Discovery
- Serial Port
- Dial-up Networking
- LAN Access using PPP
- Personal Area Network
- Generic Object Exchange
- Generic Object Push
- File Transfer
- Synchronization
- Audio Gateway
- Headset
- Printer
- Human Interface Devices (Keyboard/Mouse)
- Basic Image
- Handsfree
- AV
- Phone Book Access Profile (PBAP)
- VDP-Sync Profile

Usage environment and your health

Integrated wireless cards emit radio frequency electromagnetic energy like other radio devices. However, the level of energy emitted is far much less than the electromagnetic energy emitted by wireless devices like for example mobile phones.

Due to the fact that integrated wireless cards operate within the guidelines found in radio frequency safety standards and recommendations, Lenovo believes they are safe for use by consumers. These standards and recommendations reflect the consensus of the scientific community and result from deliberations of panels and committees of scientists who continually review and interpret the extensive research literature.

In some situation or environment, the use of integrated wireless cards may be restricted by the proprietor of the building or responsible representatives of the organization. These situations and areas may for example include:

- Using the integrated wireless cards on board of airplanes, in hospitals or near petrol stations, blasting areas (with electro-explosive devices), medical implants or body-worn electronic medical devices, such as pace makers.
- In any other environment where the risk of interference to other devices or services is perceived or identified as harmful.

If you are uncertain of the policy that applies on the use of wireless devices in a specific organization (such as an airport or a hospital), you are encouraged to ask for authorization to use integrated wireless cards prior to turning on the computer.

Location of the UltraConnect wireless antennas

ThinkPad notebook computers feature an integrated diversity antenna system built into the display for optimal reception, enabling wireless communication wherever you are.

Antenna location

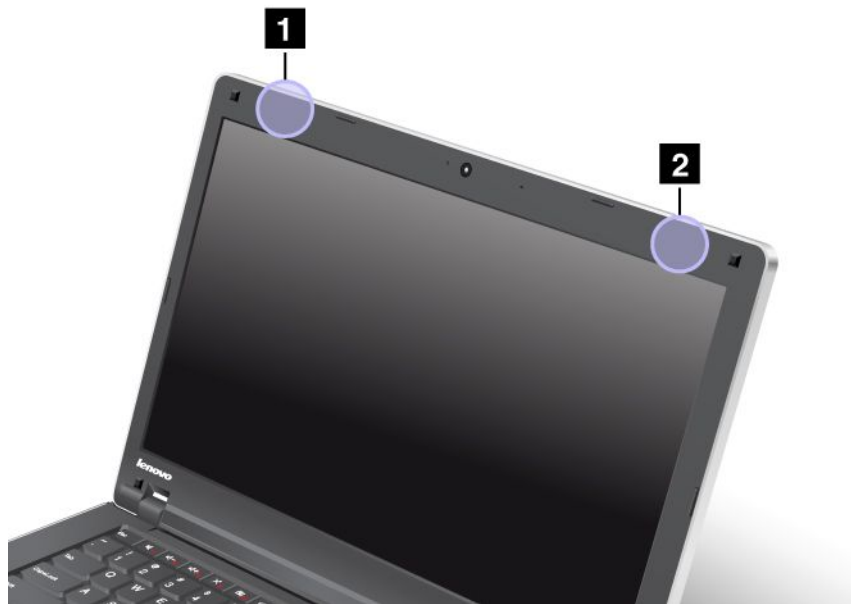

1 Wireless LAN antenna (auxiliary)

The auxiliary antenna connected to the wireless LAN feature is located at the top left corner of the computer display.

2 Wireless LAN antenna (main)

The main antenna connected to the wireless LAN feature is located at the top right corner of the computer display.

Locating wireless regulatory notices

For more information about the wireless regulatory notices, refer to the *Regulatory Notice* shipped with your computer.

If your computer is shipped without the *Regulatory Notice*, you can find it on the Web site at:
<http://www.lenovo.com/ThinkPadUserGuides>

Export classification notice

This product is subject to the United States Export Administration Regulations (EAR) and has an Export Classification Control Number (ECCN) of 4A994.b. It can be re-exported except to any of the embargoed countries in the EAR E1 country list.

Electronic emission notices

The following information refers to the ThinkPad Edge E425 and E525 machine types 1198 and 1200.

Federal Communications Commission Declaration of Conformity

This equipment has been tested and found to comply with the limits for a Class B digital device, pursuant to Part 15 of the FCC Rules. These limits are designed to provide reasonable protection against harmful interference in a residential installation. This equipment generates, uses, and can radiate radio frequency energy and, if not installed and used in accordance with the instructions, may cause harmful interference to radio communications. However, there is no guarantee that interference will not occur in a particular installation. If this equipment does cause harmful interference to radio or television reception, which can be determined by turning the equipment off and on, the user is encouraged to try to correct the interference by one or more of the following measures:

- Reorient or relocate the receiving antenna.
- Increase the separation between the equipment and receiver.
- Connect the equipment into an outlet on a circuit different from that to which the receiver is connected.
- Consult an authorized dealer or service representative for help.

Lenovo is not responsible for any radio or television interference caused by using other than specified or recommended cables and connectors or by unauthorized changes or modifications to this equipment. Unauthorized changes or modifications could void the user's authority to operate the equipment.

This device complies with Part 15 of the FCC Rules. Operation is subject to the following two conditions: (1) this device may not cause harmful interference, and (2) this device must accept any interference received, including interference that may cause undesired operation.

Responsible Party:
Lenovo (United States) Incorporated
1009 Think Place - Building One
Morrisville, NC 27560
Phone Number: 919-294-5900



Industry Canada Class B emission compliance statement

This Class B digital apparatus complies with Canadian ICES-003.

Cet appareil numérique de la classe B est conforme à la norme NMB-003 du Canada.

European Union - Compliance to the Electromagnetic Compatibility Directive

This product is in conformity with the protection requirements of EU Council Directive 2004/108/EC on the approximation of the laws of the Member States relating to electromagnetic compatibility. Lenovo cannot accept responsibility for any failure to satisfy the protection requirements resulting from a nonrecommended modification of the product, including the installation of option cards from other manufacturers.

This product has been tested and found to comply with the limits for Class B Information Technology Equipment according to European Standard EN 55022. The limits for Class B equipment were derived for typical residential environments to provide reasonable protection against interference with licensed communication devices.



German Class B compliance statement

Deutschsprachiger EU Hinweis:

Hinweis für Geräte der Klasse B EU-Richtlinie zur Elektromagnetischen Verträglichkeit

Dieses Produkt entspricht den Schutzanforderungen der EU-Richtlinie 2004/108/EG (früher 89/336/EWG) zur Angleichung der Rechtsvorschriften über die elektromagnetische Verträglichkeit in den EU-Mitgliedsstaaten und hält die Grenzwerte der EN 55022 Klasse B ein.

Um dieses sicherzustellen, sind die Geräte wie in den Handbüchern beschrieben zu installieren und zu betreiben. Des Weiteren dürfen auch nur von der Lenovo empfohlene Kabel angeschlossen werden. Lenovo übernimmt keine Verantwortung für die Einhaltung der Schutzanforderungen, wenn das Produkt ohne Zustimmung der Lenovo verändert bzw. wenn Erweiterungskomponenten von Fremdherstellern ohne Empfehlung der Lenovo gesteckt/eingebaut werden.

Deutschland:

Einhaltung des Gesetzes über die elektromagnetische Verträglichkeit von Betriebsmitteln

Dieses Produkt entspricht dem „Gesetz über die elektromagnetische Verträglichkeit von Betriebsmitteln“ EMVG (früher „Gesetz über die elektromagnetische Verträglichkeit von Geräten“). Dies ist die Umsetzung der EU-Richtlinie 2004/108/EG (früher 89/336/EWG) in der Bundesrepublik Deutschland.

Zulassungsbescheinigung laut dem Deutschen Gesetz über die elektromagnetische Verträglichkeit von Betriebsmitteln, EMVG vom 20. Juli 2007 (früher Gesetz über die elektromagnetische Verträglichkeit von Geräten), bzw. der EMV EG Richtlinie 2004/108/EC (früher 89/336/EWG), für Geräte der Klasse B.

Dieses Gerät ist berechtigt, in Übereinstimmung mit dem Deutschen EMVG das EG-Konformitätszeichen - CE - zu führen. Verantwortlich für die Konformitätserklärung nach Paragraf 5 des EMVG ist die Lenovo (Deutschland) GmbH, Gropiusplatz 10, D-70563 Stuttgart.

Informationen in Hinsicht EMVG Paragraf 4 Abs. (1) 4:

Das Gerät erfüllt die Schutzanforderungen nach EN 55024 und EN 55022 Klasse B.

Korea Class B compliance statement

B급 기기 (가정용 방송통신기자재)
이 기기는 가정용(B급) 전자파적합기기로서 주로 가정에서 사용하는 것을 목적으로 하며, 모든 지역에서 사용할 수 있습니다.

Japan VCCI Class B compliance statement

この装置は、クラスB情報技術装置です。この装置は、家庭環境で使用することを目的としていますが、この装置がラジオやテレビジョン受信機に近接して使用されると、受信障害を引き起こすことがあります。
取扱説明書に従って正しい取り扱いをして下さい。 VCCI-B

Japan compliance statement for products which connect to the power mains with rated current less than or equal to 20 A per phase

日本の定格電流が 20A/相 以下の機器に対する高調波電流規制
高調波電流規格 JIS C 61000-3-2 適合品

Lenovo product service information for Taiwan

台湾 Lenovo 産品服務資訊如下：
荷蘭商聯想股份有限公司台灣分公司
台北市信義區信義路五段七號十九樓之一
服務電話：0800-000-702

Additional regulatory information

For additional regulatory information, refer to the *Regulatory Notice* shipped with your computer.

If your computer is shipped without the *Regulatory Notice*, you can find it on the Web site at:
<http://www.lenovo.com/ThinkPadUserGuides>.

Appendix B. WEEE and recycling statements

Lenovo encourages owners of information technology equipment to responsibly recycle their equipment when it is no longer needed. Lenovo offers a variety of programs and services to assist equipment owners in recycling their IT products. Information on product recycling offerings can be found on Lenovo's Internet site at: <http://www.lenovo.com/lenovo/environment/recycling>.

EU WEEE statements

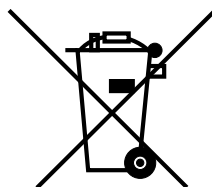

EU Only

The Waste Electrical and Electronic Equipment (WEEE) mark applies only to countries within the European Union (EU) and Norway. Appliances are labeled in accordance with European Directive 2002/96/EC concerning waste electrical and electronic equipment (WEEE). The Directive determines the framework for the return and recycling of used appliances as applicable throughout the European Union. This label is applied to various products to indicate that the product is not to be thrown away, but rather reclaimed upon end of life per this Directive.

Users of electrical and electronic equipment (EEE) with the WEEE marking per Annex IV of the WEEE Directive must not dispose of end of life EEE as unsorted municipal waste, but use the collection framework available to them for the return, recycle, recovery of WEEE and minimize any potential effects of EEE on the environment and human health due to the presence of hazardous substances. For additional WEEE information go to:

<http://www.lenovo.com/lenovo/environment>

China WEEE statement

《废弃电器电子产品回收处理管理条例》提示性说明

联想鼓励拥有联想品牌产品的用户当不再需要此类产品时，遵守国家废弃电器电子产品回收处理相关法律法规，将其交给当地具有国家认可的回收处理资质的厂商进行回收处理。更多回收服务信息，请点击进入<http://support.lenovo.com.cn/activity/551.htm>

Japan recycling statements

Collecting and recycling a disused Lenovo computer or monitor

If you are a company employee and need to dispose of a Lenovo computer or monitor that is the property of the company, you must do so in accordance with the Law for Promotion of Effective Utilization of Resources. Computers and monitors are categorized as industrial waste and should be properly disposed of by an industrial waste disposal contractor certified by a local government. In accordance with the Law for Promotion of Effective Utilization of Resources, Lenovo Japan provides, through its PC Collecting and

Recycling Services, for the collecting, reuse, and recycling of disused computers and monitors. For details, visit the Lenovo Web site at: http://www.lenovo.com/services_warranty/jp/ja/recycle/pcrecycle/.

Pursuant to the Law for Promotion of Effective Utilization of Resources, the collecting and recycling of home-used computers and monitors by the manufacturer was begun on October 1, 2003. This service is provided free of charge for home-used computers sold after October 1, 2003. For details, visit the Lenovo Web site at: http://www.lenovo.com/services_warranty/jp/ja/recycle/personal/.

Disposing of a Lenovo computer components

Some Lenovo computer products sold in Japan may have components that contain heavy metals or other environmental sensitive substances. To properly dispose of disused components, such as a printed circuit board or drive, use the methods described above for collecting and recycling a disused computer or monitor.

Disposing of disused lithium batteries from Lenovo computers

A button-shaped lithium battery is installed on the system board of your Lenovo computer to provide power to the computer clock while the computer is off or disconnected from the main power source. If you want to replace it with a new one, contact your place of purchase or ask for a repair service provided by Lenovo. If you have replaced it by yourself and want to dispose of the disused lithium battery, insulate it with vinyl tape, contact your place of purchase, and follow their instructions. If you use a Lenovo computer at home and need to dispose of a lithium battery, you must comply with local ordinances and regulations.

Disposing of a disused battery pack from Lenovo notebook computers

Your Lenovo notebook computer has a lithium ion battery pack or a nickel metal hydride battery pack. If you are a company employee who uses a Lenovo notebook computer and need to dispose of a battery pack, contact the proper person in Lenovo sales, service, or marketing, and follow that person's instructions. You also can refer to the instructions at: <http://www.lenovo.com/jp/ja/ambiente/recycle/battery/>. If you use a Lenovo notebook computer at home and need to dispose of a battery pack, you must comply with local ordinances and regulations. You also can refer to the instructions at: <http://www.lenovo.com/jp/ja/ambiente/recycle/battery/>.

Recycling information for Brazil

Declarações de Reciclagem no Brasil

Descarte de um Produto Lenovo Fora de Uso

Equipamentos elétricos e eletrônicos não devem ser descartados em lixo comum, mas enviados à pontos de coleta, autorizados pelo fabricante do produto para que sejam encaminhados e processados por empresas especializadas no manuseio de resíduos industriais, devidamente certificadas pelos órgãos ambientais, de acordo com a legislação local.

A Lenovo possui um canal específico para auxiliá-lo no descarte desses produtos. Caso você possua um produto Lenovo em situação de descarte, ligue para o nosso SAC ou encaminhe um e-mail para: reciclar@lenovo.com, informando o modelo, número de série e cidade, a fim de enviarmos as instruções para o correto descarte do seu produto Lenovo.

Battery recycling information for Taiwan



廢電池請回收

Battery recycling information for the United States and Canada



US & Canada Only

Battery recycling information for the European Union

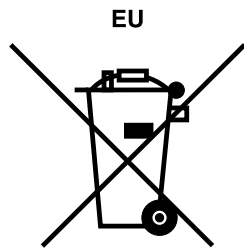

Notice: This mark applies only to countries within the European Union (EU).

Batteries or packaging for batteries are labeled in accordance with European Directive 2006/66/EC concerning batteries and accumulators and waste batteries and accumulators. The Directive determines the framework for the return and recycling of used batteries and accumulators as applicable throughout the European Union. This label is applied to various batteries to indicate that the battery is not to be thrown away, but rather reclaimed upon end of life per this Directive.

In accordance with the European Directive 2006/66/EC, batteries and accumulators are labeled to indicate that they are to be collected separately and recycled at end of life. The label on the battery may also include a chemical symbol for the metal concerned in the battery (Pb for lead, Hg for mercury, and Cd for cadmium). Users of batteries and accumulators must not dispose of batteries and accumulators as unsorted municipal waste, but use the collection framework available to customers for the return, recycling, and treatment of batteries and accumulators. Customer participation is important to minimize any potential effects of batteries and accumulators on the environment and human health due to the potential presence of hazardous substances. For proper collection and treatment, go to:
<http://www.lenovo.com/lenovo/environment>

Appendix C. Notices

Lenovo may not offer the products, services, or features discussed in this document in all countries. Consult your local Lenovo representative for information on the products and services currently available in your area. Any reference to a Lenovo product, program, or service is not intended to state or imply that only that Lenovo product, program, or service may be used. Any functionally equivalent product, program, or service that does not infringe any Lenovo intellectual property right may be used instead. However, it is the user's responsibility to evaluate and verify the operation of any other product, program, or service.

Lenovo may have patents or pending patent applications covering subject matter described in this document. The furnishing of this document does not give you any license to these patents. You can send license inquiries, in writing, to:

*Lenovo (United States), Inc.
1009 Think Place - Building One
Morrisville, NC 27560
U.S.A.
Attention: Lenovo Director of Licensing*

LENOVO PROVIDES THIS PUBLICATION "AS IS" WITHOUT WARRANTY OF ANY KIND, EITHER EXPRESS OR IMPLIED, INCLUDING, BUT NOT LIMITED TO, THE IMPLIED WARRANTIES OF NON-INFRINGEMENT, MERCHANTABILITY OR FITNESS FOR A PARTICULAR PURPOSE. Some jurisdictions do not allow disclaimer of express or implied warranties in certain transactions, therefore, this statement may not apply to you.

This information could include technical inaccuracies or typographical errors. Changes are periodically made to the information herein; these changes will be incorporated in new editions of the publication. Lenovo may make improvements and/or changes in the product(s) and/or the program(s) described in this publication at any time without notice.

The products described in this document are not intended for use in implantation or other life support applications where malfunction may result in injury or death to persons. The information contained in this document does not affect or change Lenovo product specifications or warranties. Nothing in this document shall operate as an express or implied license or indemnity under the intellectual property rights of Lenovo or third parties. All information contained in this document was obtained in specific environments and is presented as an illustration. The result obtained in other operating environments may vary.

Lenovo may use or distribute any of the information you supply in any way it believes appropriate without incurring any obligation to you.

Any references in this publication to non-Lenovo Web sites are provided for convenience only and do not in any manner serve as an endorsement of those Web sites. The materials at those Web sites are not part of the materials for this Lenovo product, and use of those Web sites is at your own risk.

Any performance data contained herein was determined in a controlled environment. Therefore, the result obtained in other operating environments may vary significantly. Some measurements may have been made on development-level systems and there is no guarantee that these measurements will be the same on generally available systems. Furthermore, some measurements may have been estimated through extrapolation. Actual results may vary. Users of this document should verify the applicable data for their specific environment.

Trademarks

The following terms are trademarks of Lenovo in the United States, other countries, or both:

- Lenovo
- Access Connections
- Active Protection System
- Rescue and Recovery
- ThinkPad
- ThinkVantage
- TrackPoint
- UltraConnect
- UltraNav

Intel is a trademark of Intel Corporation in the U.S. and/or other countries.

Microsoft, Bing, BitLocker, and Windows are trademarks of the Microsoft group of companies.

AMD and AMD-V are trademarks or registered trademarks of Advanced Micro Devices, Inc.

BlackBerry®, RIM®, Research In Motion®, SureType® and related trademarks, names and logos are the property of Research In Motion Limited and are registered and/or used in the U.S. and countries around the world. Used under license from Research In Motion Limited.

Other company, product, and service names may be trademarks or service marks of others.

ThinkPad®

Part Number:

(1P) P/N:



Free Manuals Download Website

<http://myh66.com>

<http://usermanuals.us>

<http://www.somanuals.com>

<http://www.4manuals.cc>

<http://www.manual-lib.com>

<http://www.404manual.com>

<http://www.luxmanual.com>

<http://aubethermostatmanual.com>

Golf course search by state

<http://golfingnear.com>

Email search by domain

<http://emailbydomain.com>

Auto manuals search

<http://auto.somanuals.com>

TV manuals search

<http://tv.somanuals.com>