



OWNER'S MANUAL

LED TV*

* LG LED TV applies LCD screen with LED backlights.

Please read this manual carefully before operating your TV and retain it for future reference.

22LY340C	42LY340C	42LY540S
29LY340C	47LY340C	47LY540S
32LY340C	55LY340C	55LY540S
39LY340C	60LY340C	65LY540S
	65LY340C	



* M F L 6 8 0 8 0 3 6 2 *

www.lgsolutions.com

P/NO : MFL68080362 (1405-REV02)

IMPORTANT SAFETY INSTRUCTIONS

Always comply with the following precautions to avoid dangerous situations and ensure peak performance of your product.



TO REDUCE THE RISK OF ELECTRIC SHOCK DO NOT REMOVE COVER (OR BACK). NO USER SERVICEABLE PARTS INSIDE. REFER TO QUALIFIED SERVICE PERSONNEL.

⚡ The lightning flash with arrowhead symbol, within an equilateral triangle, is intended to alert the user to the presence of uninsulated dangerous voltage within the product's enclosure that may be of sufficient magnitude to constitute a risk of electric shock to persons.

! The exclamation point within an equilateral triangle is intended to alert the user to the presence of important operating and maintenance (servicing) instructions in the literature accompanying the appliance.

WARNING/CAUTION

- TO REDUCE THE RISK OF FIRE AND ELECTRIC SHOCK, DO NOT EXPOSE THIS PRODUCT TO RAIN OR MOISTURE.

! WARNING

If you ignore the warning message, you may be seriously injured or there is a possibility of accident or death.

! CAUTION

If you ignore the caution message, you may be slightly injured or the product may be damaged.

! NOTE

The note helps you understand and use the product safely. Please read the note carefully before using the product.

WARNING: This product contains chemicals known to the State of California to cause cancer and birth defects or other reproductive harm. *Wash hands after handling.*

Read these instructions.
Keep these instructions.
Follow all instructions.
Heed all warnings.



- Do not allow the television to become wet.



- Clean only with a dry cloth.



- Do not block any ventilation openings. Install in accordance with the manufacturer's instructions.



- Do not install near any heat sources such as radiators, heat registers, stoves, or other apparatus (including amplifiers) that produce heat.



- Do not defeat the safety purpose of the polarized or grounding-type plug. A polarized plug has two blades with one wider than the other. A grounding type plug has two blades and a third grounding prong. The wide blade or the third prong are provided for your safety. If the provided plug does not fit into your outlet, consult an electrician for replacement of the obsolete outlet (Can differ by country).



- Do not press strongly upon the panel with a hand or a sharp object such as a nail, pencil or pen, or make a scratch on it.



- Protect the power cord from being walked on or pinched particularly at plugs, convenience receptacles, and the point where they exit from the apparatus.



- Only use attachments/accessories specified by the manufacturer.



- Use only with a cart, stand, tripod, bracket, or table specified by the manufacturer, or sold with the apparatus. When a cart is used, use caution when moving the cart/apparatus combination to avoid injury from tip-over.



- Unplug this apparatus during lightning storms or when unused for long periods of time.



- Refer all servicing to qualified service personnel. Servicing is required when the apparatus has been damaged in any way, such as power-supply cord or plug is damaged, liquid has been spilled or objects have fallen into the apparatus, the apparatus has been exposed to rain or moisture, does not operate normally, or has been dropped.



- Do not stick metal objects or any other conductive material into the power cord. Do not touch the end of the power cord while it is plugged in.
- Keep the packing anti-moisture material or vinyl packing out of the reach of children. Anti-moisture material is harmful if swallowed. If swallowed by mistake, induce vomiting and go to the nearest hospital. Additionally, vinyl packing can cause suffocation. Keep it out of the reach of children.

- **CAUTION** concerning the Power Cord (Can differ by country):
It is recommended that appliances be placed upon a dedicated circuit; that is, a single outlet circuit which powers only that appliance and has no additional outlets or branch circuits. Check the specification page of this owner's manual to be certain. Do not connect too many appliances to the same AC power outlet as this could result in fire or electric shock. Do not overload wall outlets. Overloaded wall outlets, loose or damaged wall outlets, extension cords, frayed power cords, or damaged or cracked wire insulation are dangerous. Any of these conditions could result in electric shock or fire. Periodically examine the cord of your appliance, and if its appearance indicates damage or deterioration, unplug it, discontinue use of the appliance, and have the cord replaced with an exact replacement part by an authorized service. Protect the power cord from physical or mechanical abuse, such as being twisted, kinked, pinched, closed in a door, or walked upon. Pay particular attention to plugs, wall outlets, and the point where the cord exits the appliance. Do not move the TV with the power cord plugged in. Do not use a damaged or loose power cord. Be sure do grasp the plug when unplugging the power cord. Do not pull on the power cord to unplug the TV.



- **Warning** - To reduce the risk of fire or electrical shock, do not expose this product to rain, moisture or other liquids. Do not touch the TV with wet hands. Do not install this product near flammable objects such as gasoline or candles, or expose the TV to direct air conditioning.



- Do not expose to dripping or splashing and do not place objects filled with liquids, such as vases, cups, etc. on or over the apparatus (e.g. on shelves above the unit).



• **Grounding**

(Except for devices which are not grounded.) Ensure that you connect the earth ground wire to prevent possible electric shock (i.e. a TV with a three-prong grounded AC plug must be connected to a three-prong grounded AC outlet). If grounding methods are not possible, have a qualified electrician install a separate circuit breaker. Do not try to ground the unit by connecting it to telephone wires, lightning rods, or gas pipes.

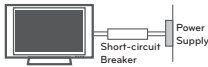

- As long as this unit is connected to the AC wall outlet, it is not disconnected from the AC power source even if the unit is turned off.
- Do not attempt to modify this product in any way without written authorization from LG Electronics. Unauthorized modification could void the user's authority to operate this product.

• **Outdoor Antenna Grounding**

(Can differ by country):

If an outdoor antenna is installed, follow the precautions below. An outdoor antenna system should not be located in the vicinity of overhead power lines or other electric light or power circuits, or where it can come in contact with such power lines or circuits as death or serious injury can occur. Be sure the antenna system is grounded so as to provide some protection against voltage surges and built-up static charges. Section 810 of the National Electrical Code (NEC) in the U.S.A. provides information with respect to proper grounding of the mast and supporting structure, grounding of the lead-in wire to an antenna discharge unit, size of grounding conductors, location of antenna discharge unit, connection to grounding electrodes and requirements for the grounding electrode.

Antenna grounding according to the National Electrical Code, ANSI/NFPA 70

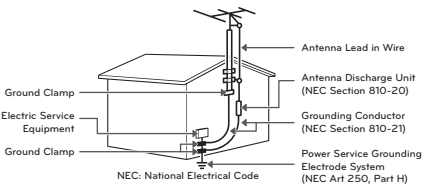

• **Cleaning**

When cleaning, unplug the power cord and wipe gently with a soft cloth to prevent scratching. Do not spray water or other liquids directly on the TV as electric shock may occur. Do not clean with chemicals such as alcohol, thinners, or benzine.

• **Moving**

Make sure the product is turned off, unplugged, and all cables have been removed. It may take 2 or more people to carry larger TVs. Do not press or put stress on the front panel of the TV.

• **Ventilation**

Install your TV where there is proper ventilation. Do not install in a confined space such as a bookcase. Do not cover the product with cloth or other materials while plugged. Do not install in excessively dusty places.

- If you smell smoke or other odors coming from the TV, unplug the power cord and contact an authorized service center.
- Keep the product away from direct sunlight.
- Never touch this apparatus or antenna during a lightning storm.
- When mounting a TV on the wall, make sure not to install the TV by hanging the power and signal cables on the back of the TV.
- Do not allow an impact shock, any objects to fall into the product, and do not drop anything onto the screen.
- **DISCONNECTING DEVICE FROM THE MAIN POWER**
Mains plug is the disconnecting device. The plug must remain readily operable.
- Store the accessories (battery, etc.) in a safe location out of the reach of children.
- This apparatus uses batteries. In your community there might be regulations that require you to dispose of these batteries properly due to environmental considerations. Please contact your local authorities for disposal or recycling information.
- Do not dispose of batteries in a fire.
- Do not short circuit, disassemble, or allow the batteries to overheat.

- **Dot Defect**

The panel is a high technology product with resolution of two million to six million pixels. In a very few cases, you could see fine dots on the screen while you're viewing the TV. Those dots are deactivated pixels and do not affect the performance and reliability of the TV.

- **Generated Sound**

Cracking noise: A cracking noise that occurs when watching or turning off the TV is generated by plastic thermal contraction due to temperature and humidity. This noise is common for products where thermal deformation is required. **Electrical circuit humming/panel buzzing:** A low level noise is generated from a high-speed switching circuit, which supplies a large amount of current to operate a product. It varies depending upon the product. This generated sound does not affect the performance and reliability of the product.

- Do not install this product on a wall if it could be exposed to oil or oil mist. This may damage the product and cause it to fall.
- Take care not to touch the ventilation openings. When watching the TV for a long period, the ventilation openings may become hot. This does not affect the performance of the product or cause defects in the product.
- If the TV feels cold to the touch, there may be a small flicker when it is turned on. This is normal; there is nothing wrong with TV. Some minute dot defects may be visible on the screen, appearing as tiny red, green, or blue spots. However, they have no adverse effect on the TV's performance. Avoid touching the LCD screen or holding your finger(s) against it for long periods of time. Doing so may produce some temporary distortion effects on the screen.

Preventing image burn or burn-in on your TV screen

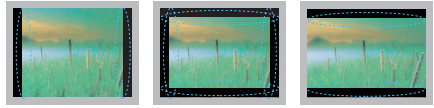

- If a fixed image displays on the TV screen for a long period of time, it will be imprinted and become a permanent disfigurement on the screen. This is image burn or burn-in and not covered by the warranty.
- If the aspect ratio of the TV is set to 4:3 for a long period of time, image burn may occur on the letterboxed area of the screen.
- Avoid displaying a fixed image on the TV screen for a long period of time to prevent image burn.

FCC NOTICE

This equipment has been tested and found to comply with the limits for a Class B digital device, pursuant to Part 15 of the FCC Rules. These limits are designed to provide reasonable protection against harmful interference in a residential installation. This equipment generates, uses and can radiate radio frequency energy and, if not installed and used in accordance with the instructions, may cause harmful interference to radio communications. However, there is no guarantee that interference will not occur in a particular installation. If this equipment does cause harmful interference to radio or television reception, which can be determined by turning the equipment off and on, the user is encouraged to try to correct the interference by one or more of the following measures:

- Reorient or relocate the receiving antenna.
- Increase the separation between the equipment and the receiver.
- Connect the equipment to an outlet on a circuit different from that to which the receiver is connected.
- Consult the dealer or an experienced radio/TV technician for help.

This device complies with part 15 of the FCC Rules. Operation is subject to the following two conditions: (1) this device may not cause harmful interference and (2) this device must accept any interference received, including interference that may cause undesired operation of the device. Any changes or modifications in construction of this device which are not expressly approved by the party responsible for compliance could void the user's authority to operate the equipment.

NOTE TO CABLE/TV INSTALLER

This reminder is provided to call the CATV system installer's attention to Article 820-40 of the National Electric Code (U.S.A.). The code provides guidelines for proper grounding and, in particular, specifies that the cable ground shall be connected to the grounding system of the building, as close to the point of the cable entry as practical.

LG RECYCLING POLICY

LG Electronics offers a customized e-waste take-back and recycling service that meets local needs and requirements in the countries where e-waste regulations are in place, and also provides product and packaging take-back and recycling service voluntarily in some countries. LG Electronics evaluates products' recyclability at the design step using LG's recyclability evaluation tool, with the goal of improving recyclability where practicable. Through these activities, LG seeks to contribute to conserving natural resources and protecting the environment.

For more information about the LG Recycling Policy, please visit our global site at <http://www.lg.com/global/sustainability/environment/take-back-recycling>.

LICENSES

Supported licenses may differ by model. For more information about licenses, visit www.lg.com.



Manufactured under license from Dolby Laboratories.
"Dolby" and the double-D symbol are trademarks of Dolby Laboratories.



The terms HDMI and HDMI High-Definition Multimedia Interface, and the HDMI logo are trademarks or registered trademarks of HDMI Licensing LLC in the United States and other countries.



ABOUT DIVX VIDEO: DivX® is a digital video format created by DivX, LLC, a subsidiary of Rovi Corporation. This is an official DivX Certified® device that has passed rigorous testing to verify that it plays DivX video. Visit divx.com for more information and software tools to convert your files into DivX videos.

ABOUT DIVX VIDEO-ON-DEMAND: This DivX Certified® device must be registered in order to play purchased DivX Video-on-Demand (VOD) movies. To obtain your registration code, locate the DivX VOD section in your device setup menu. Go to vod.divx.com for more information on how to complete your registration.

DivX Certified® to play DivX® video up to HD 1080p, including premium content.

DivX®, DivX Certified® and associated logos are trademarks of Rovi Corporation or its subsidiaries and are used under license.

Covered by one or more of the following U.S. patents:
7,295,673; 7,460,668; 7,515,710; 7,519,274

OPEN SOURCE SOFTWARE NOTICE

To obtain the source code under GPL, LGPL, MPL and other open source licenses, that is contained in this product, please visit <http://opensource.lge.com>. In addition to the source code, all referred license terms, warranty disclaimers and copyright notices are available for download.

LG Electronics will also provide open source code to you on CD-ROM for a charge covering the cost of performing such distribution (such as the cost of media, shipping and handling) upon email request to opensource@lge.com. This offer is valid for three (3) years from the date on which you purchased the product.

NOTE

- Image shown may differ from your TV.
- Your TV's OSD (On Screen Display) may differ slightly from that shown in this manual.
- The available menus and options may differ from the input source or product model that you are using.
- New features may be added to this TV in the future.

TABLE OF CONTENTS

2 IMPORTANT SAFETY INSTRUCTIONS

7 LICENSES

7 OPEN SOURCE SOFTWARE NOTICE

8 TABLE OF CONTENTS

9 ASSEMBLING AND PREPARING

- 9 Unpacking
- 11 Parts and Buttons
- 12 - Using the Joystick Button
- 14 Lifting and Moving the TV
- 14 Setting up the TV
- 14 - Attaching the Stand
- 16 - Mounting on a Table
- 17 - Mounting on a Wall

19 MAKING CONNECTIONS

- 19 Connecting to an Antenna or Cable
- 20 Other Connections

22 REMOTE CONTROL

23 MAINTENANCE

- 23 Cleaning your TV
- 23 - Screen, Frame, Cabinet, and Stand
- 23 - Power Cord

24 TROUBLESHOOTING

25 SPECIFICATIONS

29 IR CODES

30 EXTERNAL CONTROL DEVICE SETUP

- 30 RS-232C Setup
- 30 Type of Connector;
D-Sub 9-Pin Male
- 31 RS-232C Configurations
- 32 Communication Parameters
- 32 Command Reference List
- 33 Transmission / Receiving Protocol

ASSEMBLING AND PREPARING

Unpacking

Check your product box for the following items. If there are any missing accessories, contact the local dealer where you purchased your product. The illustrations in this manual may differ from the actual product and item.

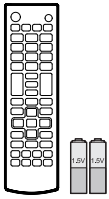

**Remote Control,
Batteries (AAA)**

(For 65LY340C, 65LY540S)



Owner's Manual

(For 22LY340C)

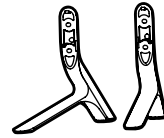

Stand Base

(For 29LY340C)



Stand Base

(For
32/39/42/47/55/60/65LY340C,
42/47/55/65LY540S)

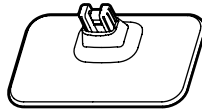

Stand Base

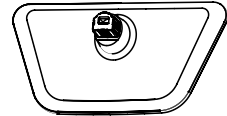

Stand Base

(For 42LY340C, 42LY540S)

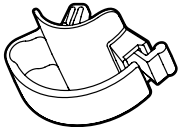

Stand Holder
2 EA



Cable Holder
1 EA
(Depending upon model)



Wall Mount Spacers
2 EA

(For 32LY340C)



Stand Screws

4 EA, M4 x L20

(For 29LY340C)

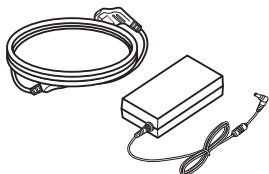

Power Cord, AC/DC Adapter

(Depending upon model)

(For 39/42/47/55/60/65LY340C, 42/47/55/65LY540S)



Stand Screws

4 EA, M4 x L14

(For 22LY340C)

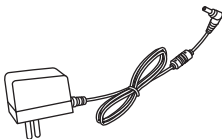

AC/DC Adapter

(Depending upon model)

(For 32/39/42/47/55/60/65LY340C, 42/47/55/65LY540S)



Power Cord

CAUTION

- Do not use any unapproved items to ensure the safety and product's lifespan.
- Any damages or injuries by using unapproved items are not covered by the warranty.
- Some models appear to have a thin film on the screen. It is actually part of the screen; do not remove it.

NOTE

- The items supplied with your product may vary depending upon the model.
- Product specifications or contents of this manual may be changed without prior notice due to upgrade of product functions.
- For an optimal connection, HDMI cables and USB devices should have bezels less than 10 mm (0.39 inches) thick and 18 mm (0.7 inches) width.
- Use an extension cable that supports USB 2.0 if the USB cable or USB memory stick does not fit into your TV's USB port.

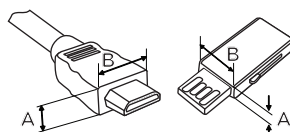

*A ≤ 10 mm (0.39 inches)
*B ≤ 18 mm (0.7 inches)

Parts and Buttons

(For 22/32/39/42/47/55/60/65LY340C, 42/47/55/65LY540S)

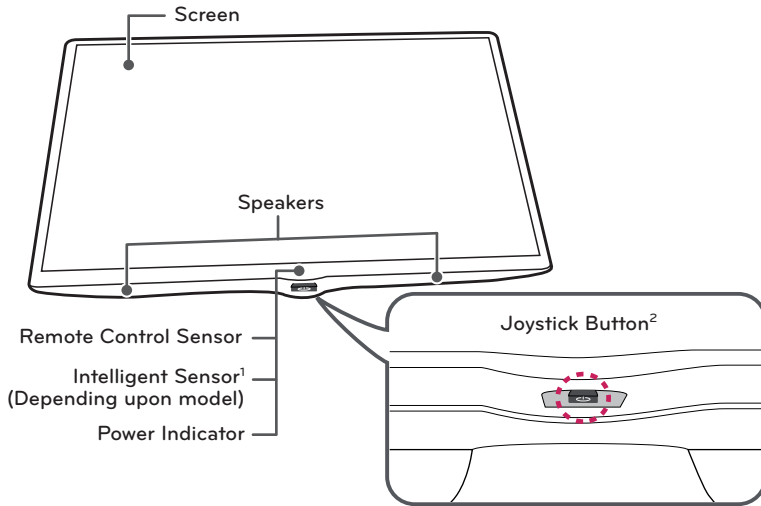

1. Intelligent sensor - Adjusts the image quality and brightness based on the surrounding environment.
2. Joystick Button is located below the screen of TV.



! NOTE

- You can set the power indicator light to on or off by selecting **OPTION** in the main menus. (Depending upon model)

Using the Joystick Button

You can simply operate the TV functions, pressing or moving the joystick button up, down, left or right

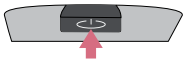
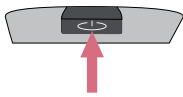
Basic functions

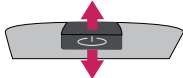
	Power On	When the TV is turned off, place your finger on the joystick button and press it once and release it.
	Power Off	When the TV is turned on, place your finger on the joystick button and press it once for a few seconds and release it. (However, if the Menu button is on the screen, pressing and holding the joystick button will let you exit the Menu.)
	Volume Control	If you place your finger over the joystick button and move it left or right, you can adjust the volume level you want.
	Channels Control	If you place your finger over the joystick button and move it up or down, you can scrolls through the saved channels you want.





! NOTE

- With your finger over the joystick button, move it up, down, left or right, be careful not to press the joystick button. If you press the joystick button first, you can not adjust the volume level and/or scroll through saved channels.

Adjusting the menu

When the TV is turned on, press the joystick button one time.

You can adjust the Menu items (⏻, ⚙️, 📺, ✖️) moving the joystick button up, down, left or right.

		TV Off	Turn the power off.
		Settings	Accesses the main menu.
		Input List	Changes the input source.
		Close	Clears on-screen displays and returns to TV viewing.

(For 29LY340C)

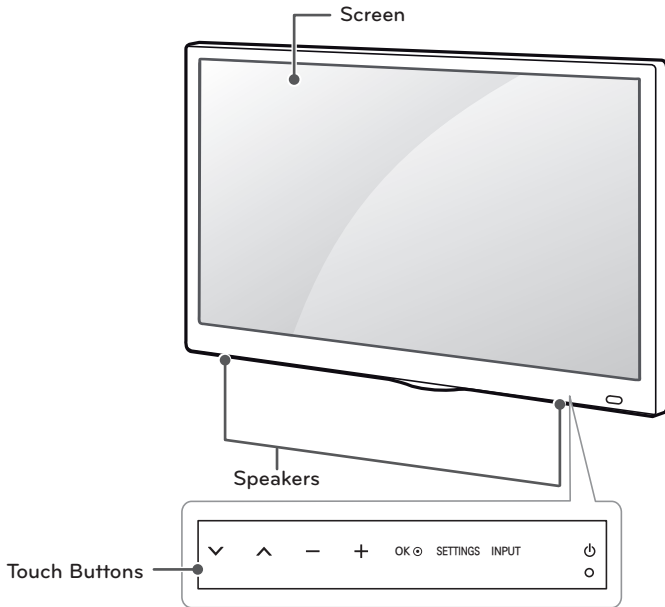

Touch Button	Description
▼ / ▲	Scrolls through the saved channels.
— / +	Adjusts the volume level.
OK ⊙	Selects the highlighted menu option or confirms an input.
SETTINGS	Accesses the main menus, or saves your input and exits the menus.
INPUT	Changes the input source.
⏻	Turns the power on or off.

NOTE

- All of the buttons are touch sensitive and can be operated through simply touching with your finger.
- You can set the power indicator light to on or off by selecting **OPTION** in the main menu. (Depending upon model)

Lifting and Moving the TV

When moving or lifting the TV, read the following to prevent the TV from being scratched or damaged and for safe transportation regardless of its type and size.

CAUTION

- Avoid touching or applying pressure to the screen at all times, as this may result in damage to the screen.
- Do not place the product on the floor with its front facing down without padding. Failure to do so may result in damage to the screen.

- It is recommended to move the TV in the box or packing material that the TV originally came in.
- Before moving or lifting the TV, disconnect the power cord and all cables.

- When holding the TV, the screen should face away from you to avoid damage.



- Hold the top and bottom of the TV frame firmly. Make sure not to hold the transparent part, speaker, or speaker grill area.

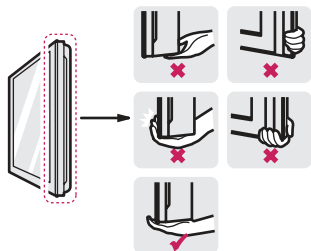

- Use at least two people to move a large TV.
- When transporting the TV by hand, hold the TV as shown in the following illustration.
- When transporting the TV, do not expose the TV to jolts or excessive vibration.
- When transporting the TV, keep the TV upright; never turn the TV on its side or tilt towards the left or right.

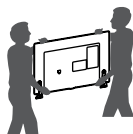

CAUTION

- When handling the TV, be careful not to damage the protruding joystick button. (Depending upon model)



Setting up the TV

Attaching the Stand

CAUTION

- When attaching the stand to the TV set, place the screen facing down on a cushioned table or flat surface to protect the screen from scratches.

(For 22LY340C)

1

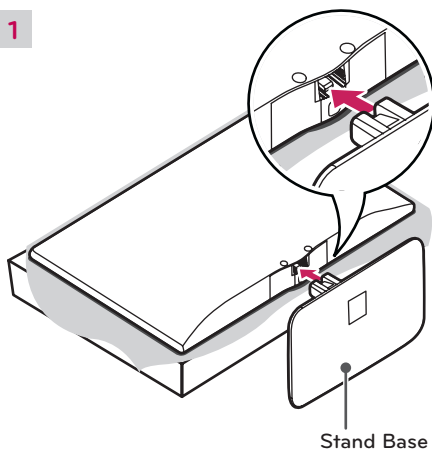

Stand Base

2

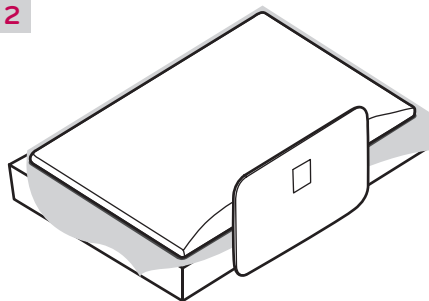

(For 29LY340C)

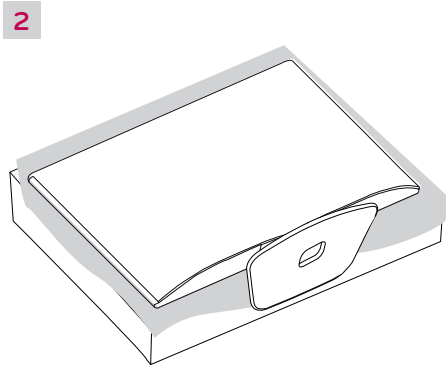
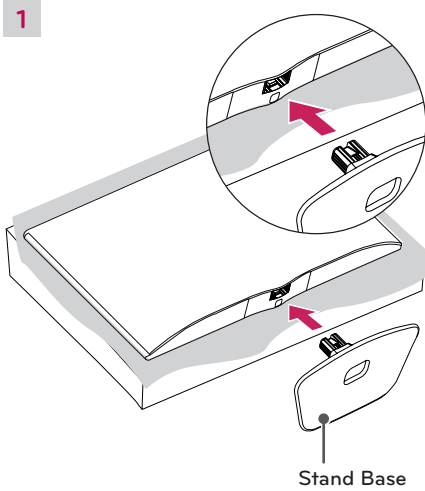

(For 32/39/42/47/55/60/65LY340C,
42/47/55/65LY540S)

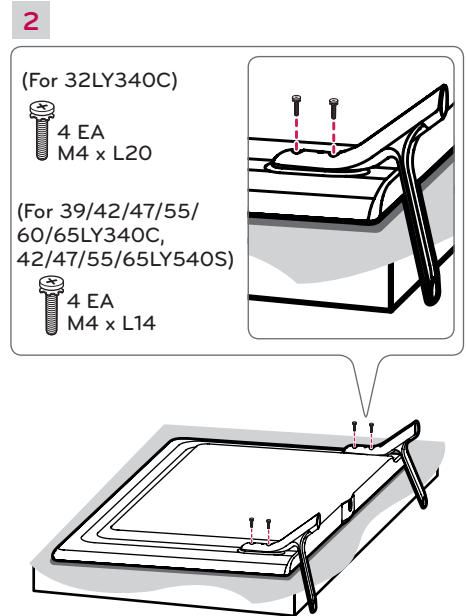
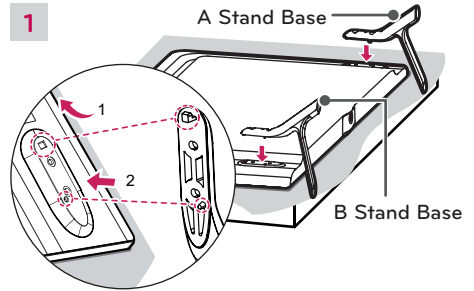

Mounting on a Table

(For 32/39/42/47/55/60/65LY340C,
42/47/55/65LY540S)

- 1 Lift and tilt the TV into its upright position on a table.
 - Leave a 10 cm (4 inches) (minimum) space from the wall for proper ventilation.

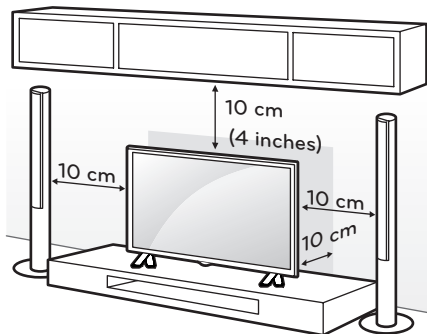

- 2 Connect the power cord to a wall outlet.



CAUTION

- Do not place the TV near or on sources of heat, as this may result in fire or other damage.

(For 22/29LY340C)

- 1 Lift and tilt the TV into its upright position on a table.
 - Leave a 10 cm (4 inches) (minimum) space from the wall for proper ventilation.

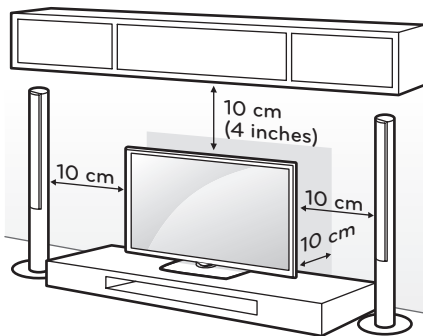

- 2 Connect the AC/DC adapter and power cord to a wall outlet.

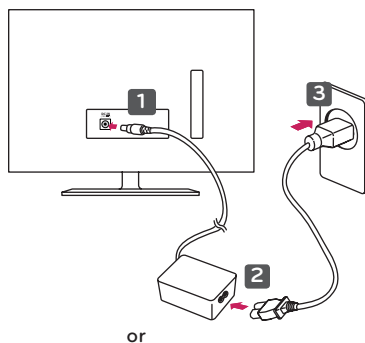

or

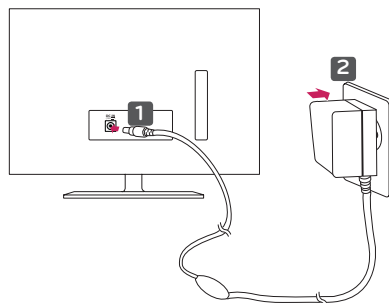

CAUTION

- Do not place the TV near or on sources of heat, as this may result in fire or other damage.

Securing the TV to a wall (optional)

(Depending upon model)

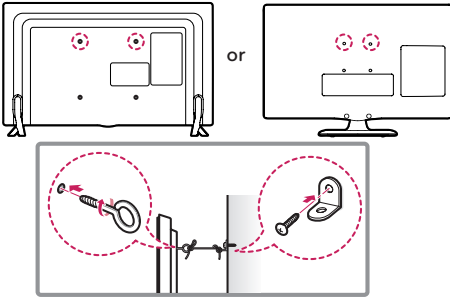

- 1 Insert and tighten the eye-bolts, or TV brackets and bolts on the back of the TV.
- If there are bolts inserted at the eye-bolts position, remove the bolts first.
- 2 Mount the wall brackets with the bolts to the wall.
Match the location of the wall bracket and the eye-bolts on the rear of the TV.
- 3 Connect the eye-bolts and wall brackets tightly with a sturdy rope or cable.
Make sure to keep the rope parallel to the flat surface.

CAUTION

- Make sure that children do not climb on or hang on the TV.

NOTE

- Use a platform or cabinet that is strong and large enough to support the TV securely.
- Brackets, bolts, and ropes, are optional. You can obtain additional accessories from your local dealer.

Mounting on a Wall

An optional wall mount can be used with your LG Television. Consult with your local dealer for a wall mount that supports the VESA standard used by your TV model. Carefully attach the wall mount bracket at the rear of the TV. Install the wall mount bracket on a solid wall perpendicular to the floor. If you are attaching the TV to other building materials, please contact qualified personnel to install the wall mount. Detailed instructions will be included with the wall mount. We recommend that you use an LG brand wall mount. When you do not use LG's wall mount bracket, please use a wall mount bracket where the device is adequately secured to the wall with enough space to allow connectivity to external devices.

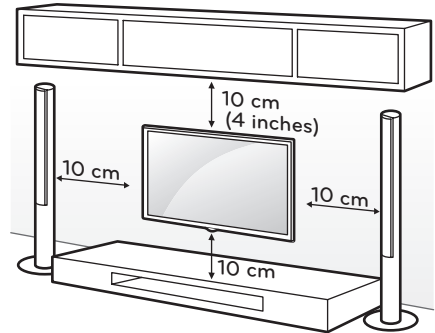

Make sure to use screws and wall mounts that meet the VESA standard. Standard dimensions for the wall mount kits are described in the following table.

Model	22LY340C	29LY340C
VESA (A x B)	75 x 75	100 x 100
		
Standard screw	M4 x L10	M4 x L10
Number of screws	4	4
Wall mount bracket (optional)	LSW140	LSW140

Model	32/39LY340C	42/47/55LY340C 42/47/55LY540S
VESA (A x B)	200 x 200	400 x 400
		
Standard screw	M6	M6
Number of screws	4	4
Wall mount bracket (optional)	LSW240B MSW240	LSW440B MSW240

Model	60/65LY340C 65LY540S
VESA (A x B)	400 x 400
	
Standard screw	M6
Number of screws	4
Wall mount bracket (optional)	LSW440B

CAUTION

- Disconnect the power before moving or installing the TV. Otherwise electric shock may occur.
- If you install the TV on a ceiling or slanted wall, it may fall and result in severe injury. Use an authorized LG wall mount and contact the local dealer or qualified personnel. When using a third-party wall mount, it is not covered by the warranty.
- Do not over tighten the screws as this may cause damage to the TV and void your warranty.
- Use the screws and wall mounts that meet the VESA standard. Any damages or injuries by misuse or using an improper accessory are not covered by the warranty.
- Screw length from outer surface of back cover should be under 8 mm (0.3 inches). (For 22/29LY340C)

Wall Mount Pad

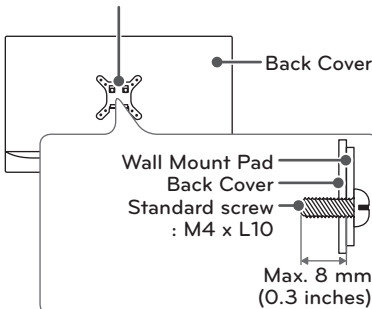

NOTE

- Use the screws that are listed in the VESA standard screw specifications.
- The wall mount kit includes an installation manual and necessary parts.
- The wall mount bracket is optional. You can obtain additional accessories from your local dealer.
- The length of screws may differ depending upon the wall mount. Make sure to use the proper length.
- For more information, refer to the manual supplied with the wall mount.
- When attaching a wall mounting bracket to the TV, insert the wall mount inner spacers into the TV wall mount holes to adjust the vertical angle of the TV. (For 42LY340C, 42LY540S)

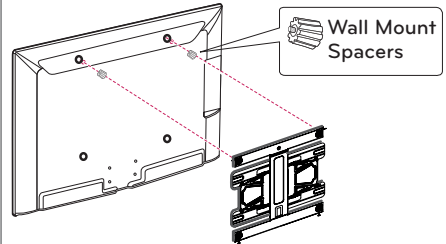

MAKING CONNECTIONS

- Image shown may differ from your TV.

You can connect various external devices to the TV. Supported external devices are: HD receivers, DVD players, VCRs, audio systems, USB storage devices, PC, gaming devices, and other external devices. For more information on external device's connection, refer to the manual provided with each device.

NOTE

- If you record a TV program on a DVD recorder or VCR, make sure to connect the TV signal input cable to the TV through a DVD recorder or VCR. For more information about recording, refer to the manual provided with the connected device.
- The external device connections shown may differ slightly from illustrations in this manual.
- Connect external devices to the TV regardless about the order of the TV port.
- If you connect a gaming device to the TV, use the cable supplied with the gaming device.
- Refer to the external equipment's manual for operating instructions.
- Using a DVI to HDMI cable may cause compatibility issues.

Connecting to an Antenna or Cable

Connect an antenna, cable, or cable box to watch TV. The illustrations may differ from the actual items and an RF cable is optional.

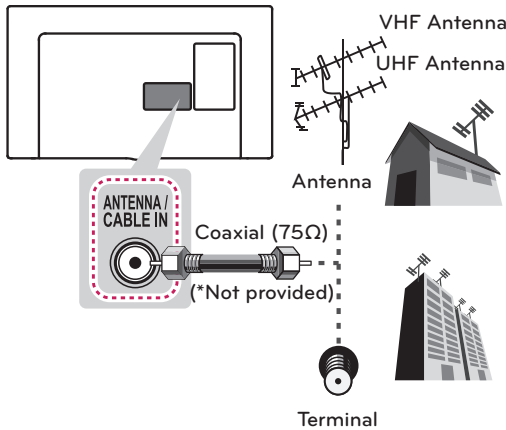

CAUTION

- Make sure not to bend the copper wire of the RF cable.

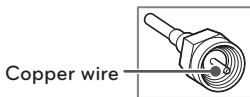

- Complete all connections between devices, and then connect the power cord to the power outlet to prevent damage to your TV.

NOTE

- Use a signal splitter to use 2 TVs or more.
- DTV Audio Supported Codec: MPEG, Dolby Digital

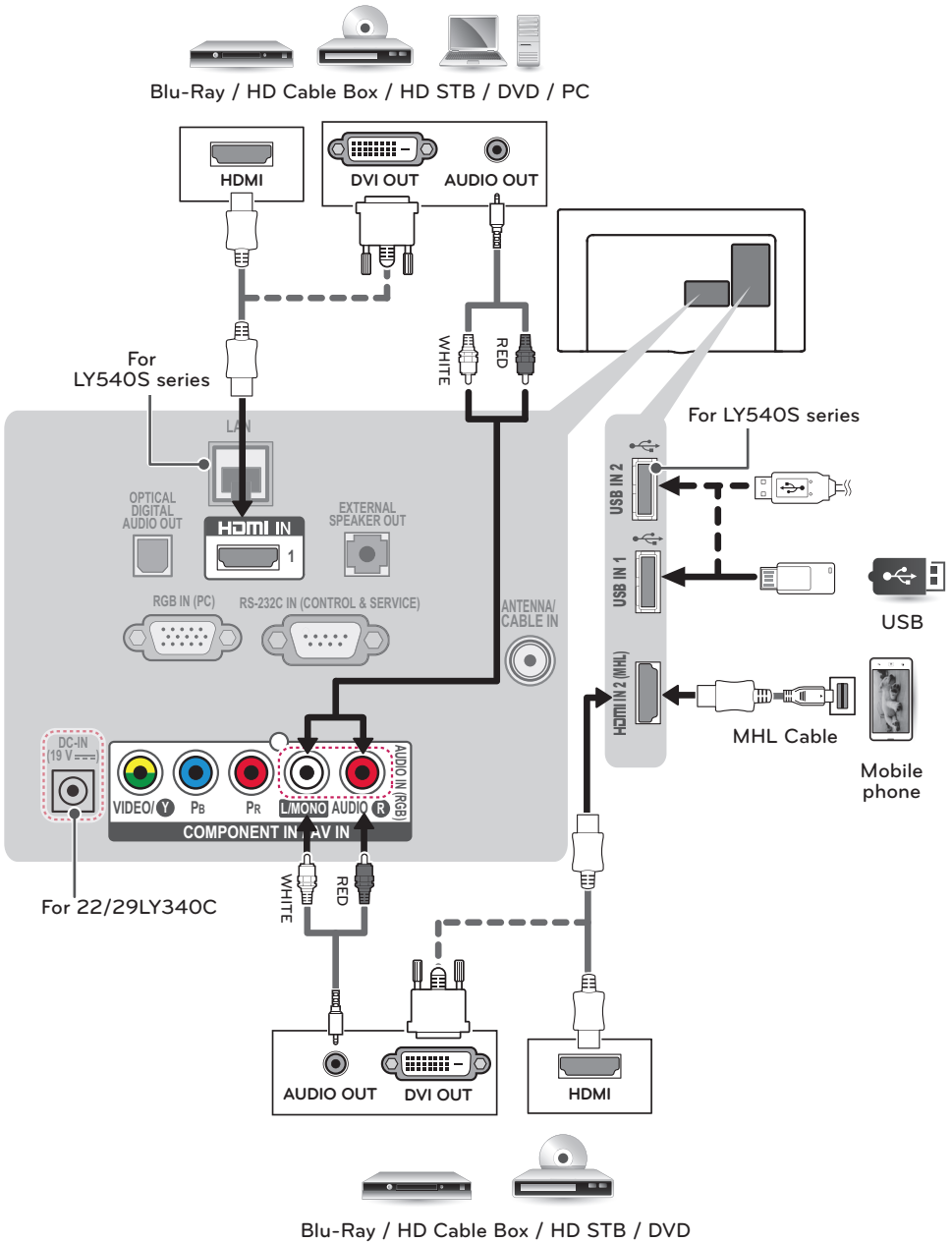

REMOTE CONTROL

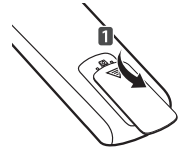

The descriptions in this manual are based on the buttons on the remote control. Please read this manual carefully and use the TV correctly. To install batteries, open the battery cover, replace batteries (1.5 V AAA) matching the ⊕ and ⊖ ends to the label inside the compartment, and close the battery cover. Failure to match the correct polarities of the battery may cause the battery to burst or leak, resulting in fire, personal injury, or ambient pollution. To remove the batteries, perform the installation actions in reverse.

CAUTION

- Do not mix old and new batteries, as this may damage the remote control.

This remote uses infrared light. When in use, it should be pointed in the direction of the TV's remote sensor.

ENGLISH

<p>⏻ (POWER) Turns the TV on or off.</p> <p>TV Returns to the last TV channel.</p> <p>CAPTION Activates or deactivates the subtitles.</p> <p>AV MODE Selects an AV mode.</p> <p>📐 RATIO Resizes an image.</p> <p>📺 INPUT Changes the input source.</p>
<p>Number button Enters numbers.</p> <p>- (Dash) Inserts a dash between numbers such as 2-1 and 2-2.</p> <p>LIST Accesses the saved channel list.</p> <p>FLASHBK Alternates between the two last channels selected.</p>
<p>+ VOL - Adjusts the volume level.</p> <p>FAV Accesses your favorite channel list.</p> <p>AUDIO Digital signal: Changes the audio language. Analog signal: Changes the MTS sound.</p> <p>MUTE 🔇 Mutes all sounds.</p> <p>^ CH v Scrolls through the saved channels.</p> <p>^ PAGE v Moves to the previous or next screen.</p>
<p>PICTURE Changes the image mode.</p> <p>INFO ⓘ Shows information on the current program.</p> <p>SOUND Changes the sound mode.</p> <p>SETTINGS Accesses the main menu.</p> <p>Q.MENU Accesses the quick menu.</p> <p>Navigation buttons (up/down/left/right) Scrolls through menus or options.</p> <p>OK Ⓞ Selects menus or options and confirms your input.</p> <p>↩ BACK Returns to the previous screen.</p> <p>EXIT Clears all on-screen displays and returns to TV viewing.</p>
<p>* Not functional</p> <p>SLEEP Sets the length of time until the TV to turns off.</p> <p>Control buttons (■, ▶, , ◀, ▶▶) Controls the MY MEDIA menus and the SIMPLINK compatible devices (USB, SIMPLINK).</p> <p>⋯ ⋮ ⋭ ⋮⋮ These access special functions in some menus.</p>

MAINTENANCE

Cleaning your TV

Clean your TV regularly to keep it at peak performance and to extend the product's lifespan.



CAUTION

- Before cleaning, turn the power off and disconnect the power cord and all other cables.
- When the TV is left unattended or unused for a long time, disconnect the power cord from the wall outlet to prevent possible damage from lightning or power surges.

Screen, Frame, Cabinet, and Stand

To remove dust or light dirt, wipe the surface with a dry, clean, and soft cloth.

To remove major dirt, wipe the surface with a soft cloth dampened in clean water or a diluted mild detergent. Then wipe immediately with a dry cloth.



CAUTION

- Do not push, rub, or hit the surface with your fingernail or a sharp object, as this may result in scratches on the screen and image distortions.
- Do not use any chemicals, such as waxes, benzene, alcohol, thinners, insecticides, air fresheners, or lubricants, as these may damage the screen's finish and cause discoloration.
- Do not spray liquid onto the surface. If water enters the TV, it may result in fire, electric shock, or malfunction.

Power Cord

Remove the accumulated dust or dirt on the power cord regularly.

TROUBLESHOOTING

The software may be updated for improvement in performance. The customer is responsible to ensure the compatibility of their equipment with any LG Electronics software. If needed, please consult with LG Electronics and update new software versions according to the guidance provided by LG Electronics.

Problem	Solution
Cannot control the TV with the remote control.	<ul style="list-style-type: none"> • Check if anything such as tape has been placed over the receiver. • Check if there is any obstacle between the product and the remote control. • Replace the batteries with new fresh ones.
No image display and no sound is produced.	<ul style="list-style-type: none"> • Check if the product is turned on. • Check if the power cord is connected to a wall outlet. • Check if there is a problem in the wall outlet by connecting other products.
The TV turns off suddenly.	<ul style="list-style-type: none"> • Check the power control settings. The power supply may be interrupted. • Check if the auto off feature is activated in the Time settings.
When connecting to the PC, 'No signal' or 'Invalid Format' is displayed.	<ul style="list-style-type: none"> • Turn the TV off/on using the remote control. • Reconnect the RGB/HDMI/DVI cable. • Restart the PC with the TV on.

SPECIFICATIONS

Product specifications may be changed without prior notice due to upgrade of product functions.

Television System		ATSC, NTSC-M, 64 & 256 QAM
Program Coverage		VHF 2-13, UHF 14-69, DTV 2-69, CATV 1-135, CADTV 1-135
External Antenna Impedance		75 Ω
Environment condition	Operating Temperature	0 °C to 40 °C (32 °F to 104 °F)
	Operating Humidity	Less than 80 %
	Storage Temperature	-20 °C to 60 °C (-4 °F to 140 °F)
	Storage Humidity	Less than 85 %

MODELS		22LY340C (22LY340C-UA)	29LY340C (29LY340C-UA)
Dimensions (W x H x D)	With stand	507.6 x 355.9 x 135.8 (mm)	668.6 x 457.0 x 182.1 (mm)
		19.9 x 14.0 x 5.3 (inches)	26.3 x 17.9 x 7.1 (inches)
	Without stand	507.6 x 315.7 x 53.1 (mm)	668.6 x 410.5 x 81.9 (mm)
		19.9 x 12.4 x 2.0 (inches)	26.3 x 16.1 x 3.2 (inches)
Weight	With stand	3.1 kg (6.8 lbs)	5.6 kg (12.3 lbs)
	Without stand	2.9 kg (6.3 lbs)	5.2 kg (11.4 lbs)
Power requirement		19 V --- 1.6 A	19 V --- 2.2 A
AC/DC Adapter		Manufacturer: Lien Chang Model: LCAP16B-A	Manufacturer: Lien Chang Model: LACP35
		Manufacturer: LG Innotek Model: PSAB-L205C	Manufacturer: APD Model: DA-48F19
		In: AC 100 - 240 V ~ 50/60 Hz	
		Out: 19 V --- 2.1 A	Out: 19 V --- 2.53 A

MODELS		32LY340C (32LY340C-UA)	39LY340C (39LY340C-UA)
Dimensions (W x H x D)	With stand	732 x 481 x 207 (mm)	885 x 567 x 218 (mm)
		28.8 x 18.9 x 8.1 (inches)	34.8 x 22.3 x 8.5 (inches)
	Without stand	732 x 431 x 55.5 (mm)	885 x 524 x 55.5 (mm)
		28.8 x 16.9 x 2.1 (inches)	34.8 x 20.6 x 2.1 (inches)
Weight	With stand	6.2 kg (13.6 lbs)	8.3 kg (18.2 lbs)
	Without stand	6.0 kg (13.2 lbs)	8 kg (17.6 lbs)
Current Value / Power Consumption		1.1 A / 65 W	0.9 A / 90 W
Power requirement		AC 100 - 240 V ~ 50 / 60 Hz	

MODELS		42LY340C (42LY340C-UA)	42LY540S (42LY540S-UA)
Dimensions (W x H x D)	With stand	961 x 612 x 218 (mm)	
		37.8 x 24.0 x 8.5 (inches)	
	Without stand	961 x 567 x 55.5 (mm)	
		37.8 x 22.3 x 2.1 (inches)	
Weight	With stand	9.5 kg (20.9 lbs)	
	Without stand	9.2 kg (20.2 lbs)	
Current Value / Power Consumption		1.0 A / 100 W	
Power requirement		AC 100 - 240 V ~ 50 / 60 Hz	

MODELS		47LY340C (47LY340C-UA)	47LY540S (47LY540S-UA)
Dimensions (W x H x D)	With stand	1,073 x 676 x 247 (mm)	
		42.2 x 26.6 x 9.7 (inches)	
	Without stand	1,073 x 629 x 55.8 (mm)	
		42.2 x 24.7 x 2.1 (inches)	
Weight	With stand	12.7 kg (27.9 lbs)	
	Without stand	12.3 kg (27.1 lbs)	
Current Value / Power Consumption		1.1 A / 110 W	
Power requirement		AC 100 - 240 V ~ 50 / 60 Hz	

MODELS		55LY340C (55LY340C-UA)	55LY540S (55LY540S-UA)
Dimensions (W x H x D)	With stand	1,243 x 772 x 247 (mm)	
		48.9 x 30.3 x 9.7 (inches)	
	Without stand	1,243 x 725 x 56.8 (mm)	
		48.9 x 28.5 x 2.2 (inches)	
Weight	With stand	17.7 kg (39.0 lbs)	
	Without stand	17.3 kg (38.1 lbs)	
Current Value / Power Consumption		1.3 A / 130 W	
Power requirement		AC 100 - 240 V ~ 50 / 60 Hz	

MODELS		60LY340C (60LY340C-UA)
Dimensions (W x H x D)	With stand	1,373 x 851 x 283 (mm)
		54.0 x 33.5 x 11.1 (inches)
	Without stand	1,373 x 801 x 58.8 (mm)
		54.0 x 31.5 x 2.3 (inches)
Weight	With stand	23.5 kg (51.8 lbs)
	Without stand	23.0 kg (50.7 lbs)
Current Value / Power Consumption		1.3 A / 130 W
Power requirement		AC 100 - 240 V ~ 50 / 60 Hz

MODELS		65LY340C (65LY340C-UA)	65LY540S (65LY540S-UA)
Dimensions (W x H x D)	With stand	1,462 x 898 x 314 (mm)	
		57.5 x 35.3 x 12.3 (inches)	
	Without stand	1,462 x 850 x 59.2 (mm)	
		57.5 x 33.4 x 2.3 (inches)	
Weight	With stand	30.5 kg (67.2 lbs)	
	Without stand	29.0 kg (63.9 lbs)	
Current Value / Power Consumption		1.9 A / 190 W	
Power requirement		AC 100 - 240 V ~ 50 / 60 Hz	

RGB (PC), HDMI (PC) supported mode

(HDMI IN 2 does not support PC mode.)

Resolution	Horizontal Frequency (kHz)	Vertical Frequency (Hz)
640 x 350	31.468	70.09
720 x 400	31.469	70.08
640 x 480	31.469	59.94
800 x 600	37.879	60.31
1024 x 768	48.363	60.00
1152 x 864	54.348	60.053
1360 x 768	47.712	60.015
1280 x 1024 (FHD only)	63.981	60.02
1920 x 1080 (FHD only)	67.50	60.00

For 39/42/47/55/60/65LY340C,
42/47/55/65LY540S**HDMI (DTV) supported mode**

Resolution	Horizontal Frequency (kHz)	Vertical Frequency (Hz)
720 x 480p	31.47	59.94
	31.50	60.00
1280 x 720p	44.96	59.94
	45.00	60.00
1920 x 1080i	33.72	59.94
	33.75	60.00
1920 x 1080p	26.97	23.976
	27.00	24.00
	33.71	29.97
	33.75	30.00
	67.432	59.94
	67.50	60.00

Component port connecting information

















Component ports on the TV	Y	P _B	P _R
Video output ports on DVD player	Y	P _B	P _R
	Y	B-Y	R-Y
	Y	Cb	Cr
	Y	Pb	Pr

Component supported mode

Resolution	Horizontal Frequency (kHz)	Vertical Frequency (Hz)
720 x 480i	15.73	59.94
	15.73	60.00
720 x 480p	31.47	59.94
	31.50	60.00
1280 x 720p	44.96	59.94
	45.00	60.00
1920 x 1080i	33.72	59.94
	33.75	60.00
1920 x 1080p	26.97	23.976
	27.00	24.00
	33.71	29.97
	33.75	30.00
	67.432	59.94
	67.50	60.00

IR CODES

(Depending upon model)

Code (Hexa)	Function	Note	Code (Hexa)	Function	Note
08	 (POWER)	Remote control Button (Power On/Off)	8F		Remote control Button
30	AV MODE	Remote control Button	79	RATIO 	Remote control Button
0B	INPUT 	Remote control Button	4D	PICTURE	Remote control Button
0F	TV	Remote control Button	52	SOUND	Remote control Button
10-19	Number Key 0-9	Remote control Button	0E	SLEEP	Remote control Button
4C	- (DASH) / LIST	Remote control Button	39	CAPTION	Remote control Button
1A	FLASHBK	Remote control Button	0A	AUDIO	Remote control Button
02	VOL 	Remote control Button			
03	VOL 	Remote control Button			
1E	FAV	Remote control Button			
09	MUTE 	Remote control Button			
00	CH, PAGE 	Remote control Button			
01	CH, PAGE 	Remote control Button			
43	SETTINGS	Remote control Button			
45	Q.MENU	Remote control Button			
28		Remote control Button			
AA	INFO 	Remote control Button			
5B	EXIT 	Remote control Button			
44	OK 	Remote control Button			
40	^	Remote control Button			
41	v	Remote control Button			
07	<	Remote control Button			
06	>	Remote control Button			
72		Remote control Button			
71		Remote control Button			
63		Remote control Button			
61		Remote control Button			
B1	■	Remote control Button			
B0	▶	Remote control Button			
BA		Remote control Button			
8E	▶▶	Remote control Button			

EXTERNAL CONTROL DEVICE SETUP

RS-232C Setup

Connect the RS-232C (serial port) input jack to an external control device (such as a computer or an A/V control system) to control the product's functions externally.

Connect the serial port of the control device to the RS-232C jack on the product back panel.

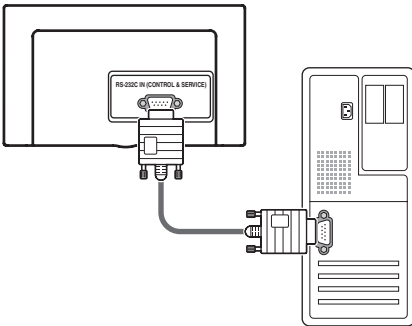

ENGLISH

NOTE

- RS-232C on this unit is intended to be used with third party RS-232C control hardware and software. The instructions below are provided to help with programming software or to test functionality using telenet software. RS-232C connection cables are not supplied with the product.

Type of Connector; D-Sub 9-Pin Male

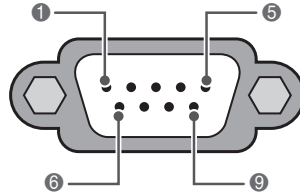

RS-232C IN
(CONTROL & SERVICE)

No.	Pin name
1	No connection
2	RXD (Receive data)
3	TXD (Transmit data)
4	DTR (DTE side ready)
5	GND
6	DSR (DCE side ready)
7	RTS (Ready to send)
8	CTS (Clear to send)
9	No Connection

RS-232C Configurations

7-Wire Configuration
(Serial female-female NULL modem cable)

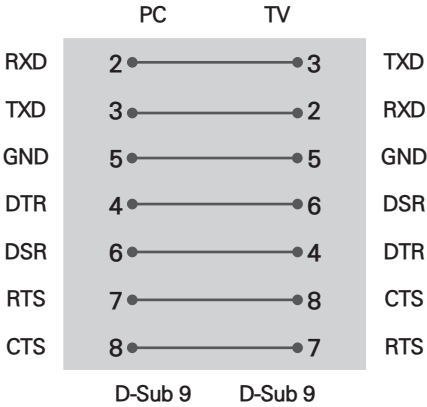

3-Wire Configurations(Not standard)

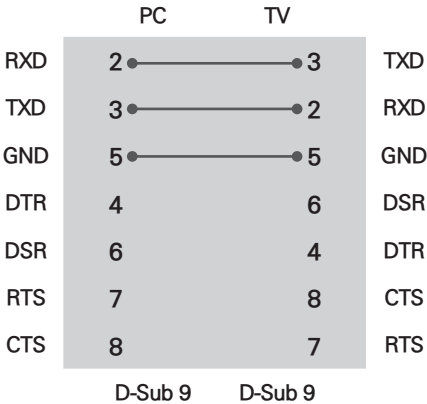

Set ID

Set ID number; "Real Data Mapping"

- 1 Press **SETTINGS** to access the main menus.
- 2 Press the Navigation buttons to scroll to **Option** and press **OK**.
- 3 Press the Navigation buttons to scroll to **Set ID** and press **OK**.
- 4 Scroll left or right to select a set ID number and select **CLOSE**. The adjustment range is 1-99.
- 5 When you are finished, press **EXIT**.

```
*Real data mapping
0 : Step 0
  :
A : Step 10 (SET ID 10)
  :
F : Step 15 (SET ID 15)
10 : Step 16 (SET ID 16)
  :
63 : Step 99 (SET ID 99)
64 : Step 100
```

Communication Parameters

- Baud rate: 9600 bps (UART)
- Data length: 8 bits
- Parity : None
- Stop bit: 1 bit
- Communication code: ASCII code
- Use a null modem cable.

Command Reference List

	COMMAND1	COMMAND2	DATA (Hexadecimal)		COMMAND1	COMMAND2	DATA (Hexadecimal)
01. Power	k	a	00 - 01	14. Balance	k	t	00 - 64
02. Input Select	x	b	(See p. 34)	15. 3D (For 3D TV)	x	t	(See p. 35)
03. Aspect Ratio	k	c	(See p. 34)	16. Color Temperature	x	u	00 - 64
04. Screen Mute	k	d	00 - 01	17. Extended 3D (For 3D TV)	x	v	(See p. 36)
05. Volume Mute	k	e	00 - 01	18. Auto Configuration	j	u	(See p. 36)
06. Volume Control	k	f	00 - 64	20. Channel Add/Del	m	b	00 - 01
07. Contrast	k	g	00 - 64	21. Key	m	c	(See p. 37)
08. Brightness	k	h	00 - 64	22. Backlight	m	g	00 - 64
09. Color	k	i	00 - 64	23. Equalize	j	v	(See p. 37)
10. Tint	k	j	00 - 64				
11. Sharpness	k	k	00 - 32				
12. OSD Select	k	l	00 - 01				
13. Remote Control Lock Mode	k	m	00 - 01				

	COMMAND1	COMMAND2	DATA00 (Hexadecimal)	DATA01 (Hexadecimal)	DATA02 (Hexadecimal)	DATA03 (Hexadecimal)	DATA04 (Hexadecimal)	DATA05 (Hexadecimal)
19. Channel Tuning	m	a	physical program high	major program low	major low	minor high	minor low	attribute

Transmission / Receiving Protocol

Transmission

[Command1][Command2][Set ID][Data][Cr]

[Command 1] : First command to control the set.(j, k, m or x)

[Command 2] : Second command to control the set.

[Set ID] : You can adjust the set ID to choose desired set ID number in Option menu. Adjustment range is 1~ 99. When selecting Set ID 0, every connected the set is controlled. Set ID is indicated as decimal (1~ 99) on menu and as Hexa decimal (0x0~ 0x63) on transmission /receiving protocol.

[DATA] : To transmit the command data.

Transmit the FF data to read status of command.

[Cr] : Carriage Return

ASCII code 0x0D

[] : ASCII code space (0x20)

* In this model, set will not send the status during the standby mode.

OK Acknowledgement

[Command2][Set ID][OK][Data][x]

The set transmits ACK (acknowledgement) based on this format when receiving normal data. At this time, if the data is data read mode, it indicates present status data. If the data is data write mode, it returns the data of the PC computer.

* In this model, set will not send the status during the standby mode.

* Data Format

[Command 2] : Use as command.

[Set ID] : Use the small character, if set ID is 10, it will send the 0, a.

[DATA] : Use the small character, if data is 0 x ab, it will send the a, b.

[OK]: Use the large character.

Error Acknowledgement

[Command2][Set ID][NG][Data][x]

The set transmits ACK (acknowledgement) based on this format when receiving abnormal data from non-viable functions or communication errors.

Data01: Illegal Code

Data02: Not supported function

Data03: Wait more time

* In this model, set will not send the status during the standby mode.

* Data Format

[Command 2] : Use as command.

[Set ID] : Use the small character, if set ID is 10, it will send the 0, a.

[DATA] : Use the small character, if data is 0 x ab, it will send the a, b.

[NG] : Use the large character

01. Power (Command: k a)

To control Power On/Off of the set.

Transmission [k][a][] [Set ID][] [Data][Cr]

Data 00: Power Off Data 01: Power On

Acknowledgement [a][] [Set ID][] [OK/NG][Data][x]

* In a like manner, if other functions transmit 'FF' data based on this format, Acknowledgement data feedback presents status about each function.

* Note: In this model, set will send the Acknowledge after power on processing completion.

There might be a time delay between command and acknowledge.

02. Input Select (Command: x b)

To select input source for set.

Transmission [x][b][] [Set ID][] [Data][Cr]

Data 00: DTV (Antenna)

Data 01: DTV (Cable)

Data 10: Analog (Antenna)

Data 11: Analog (Cable)

Data 20: AV or AV1 Data 21: AV2

Data 40: Component or Component1

Data 41: Component2

Data 60: RGB-PC Data 90: HDMI1

Data 91: HDMI2 Data 92: HDMI3

Acknowledgement [b][] [Set ID][] [OK/NG][Data][x]

* Use the feature depending upon your model.

03. Aspect Ratio (Command: k c)

To adjust the screen format.

Transmission [k][c][] [Set ID][] [Data][Cr]

Data 01: 4:3 Data: 09: Just scan

Data 02: 16:9 Data: 10: Cinema Zoom 1

Data 04: Zoom

Data 06: Set by program

Data 1F: Cinema Zoom16

Acknowledgement [c][] [Set ID][] [OK/NG][Data][x]

04. Screen Mute (Command: k d)

To select screen mute on/off.

Transmission [k][d][] [Set ID][] [Data][Cr]

Data 00: Screen mute off (Picture on), Video-out Mute off

Data 01: Screen mute on (Picture off)

Data 10: Video-out Mute on

Acknowledgement [d][] [Set ID][] [OK/NG][Data][x]

*In case of Video-out Mute on only, TV will display On Screen Display (OSD). But, in case of screen mute on, TV will not display On Screen Display (OSD).

05. Volume Mute (Command: k e)

To control volume mute on/off.

You can also adjust mute using the MUTE button on remote control.

Transmission [k][e][] [Set ID][] [Data][Cr]

Data 00: Volume mute on (Volume off)

Data 01: Volume mute off (Volume on)

Acknowledgement [e][] [Set ID][] [OK/NG][Data][x]

06. Volume Control (Command: k f)

To adjust volume.

You can also adjust volume with the volume buttons on remote control.

Transmission [k][f][] [Set ID][] [Data][Cr]

Data Min: 00 ~ Max: 64 (*transmit by Hexadecimal code)

*Refer to Real data mapping.

Acknowledgement [f][] [Set ID][] [OK/NG][Data][x]

07. Contrast (Command: k g)

To adjust screen contrast.

You can also adjust contrast in the PICTURE menu.

Transmission [k][g][] [Set ID][] [Data][Cr]

Data Min: 00 ~ Max: 64 (*transmit by Hexadecimal code)

*Refer to Real data mapping.

Acknowledgement [g][] [Set ID][] [OK/NG][Data][x]

08. Brightness (Command: k h)

To adjust screen brightness.

You can also adjust brightness in the PICTURE menu.

Transmission [k][h][][Set ID][][Data][Cr]

Data Min: 00 ~ Max: 64 (*transmit by Hexadecimal code)

*Refer to Real data mapping.

Acknowledgement [h][][Set ID][][OK/NG][Data][x]

09. Color (Command: k i)

To adjust screen color.

You can also adjust color in the PICTURE menu.

Transmission [k][i][][Set ID][][Data][Cr]

Data Min: 00 ~ Max: 64 (*transmit by Hexadecimal code)

*Refer to Real data mapping.

Acknowledgement [i][][Set ID][][OK/NG][Data][x]

10. Tint (Command: k j)

To adjust screen tint.

You can also adjust tint in the PICTURE menu.

Transmission [k][j][][Set ID][][Data][Cr]

Data Red: 00 ~ Green: 64 (*transmit by Hexadecimal code)

*Refer to Real data mapping.

Acknowledgement [j][][Set ID][][OK/NG][Data][x]

11. Sharpness (Command: k k)

To adjust screen sharpness.

You can also adjust sharpness in the PICTURE menu.

Transmission [k][k][][Set ID][][Data][Cr]

Data Min: 00 ~ Max: 32 (*transmit by Hexadecimal code)

*Refer to Real data mapping.

Acknowledgement [k][][Set ID][][OK/NG][Data][x]

12. OSD Select (Command: k l)

To select OSD (On Screen Display) on/off.

Transmission [k][l][][Set ID][][Data][Cr]

Data 00: OSD off Data 01: OSD on

Acknowledgement [l][][Set ID][][OK/NG][Data][x]

13. Remote Control Lock Mode (Command: k m)

To lock the remote control and the front panel controls on the set.

Transmission [k][m][][Set ID][][Data][Cr]

Data 00: Lock off Data 01: Lock on

Acknowledgement [m][][Set ID][][OK/NG][Data][x]

If you're not using the remote control and front panel

controls on the Monitor set, use this mode. When main power is on/off, remote control lock is released.

If Key Lock is on in the standby mode, TV will not turn on by POWER button of remote control and on the TV.

14. Balance (Command: k t)

To adjust balance.

You can also adjust balance in the AUDIO menu.

Transmission [k][t][][Set ID][][Data][Cr]

Data Min: 00 ~ Max: 64 (*transmit by Hexadecimal code)

*Refer to Real data mapping.

Acknowledgement [t][][Set ID][][OK/NG][Data][x]

15. 3D (Command: x t) (For 3D TV)

To change 3D mode for TV.

Transmission [x][t][][Set ID][][Data01]

[][Data02][][Data03][][Data04][Cr]

Data01

00: 3D On 01: 3D Off

02: 3D to 2D 03: 2D to 3D

Data02

00: Top and Bottom 01: Side by Side

02: Check Board 03: Frame Sequential

Data03

- 00: Right to Left
- 01: Left to Right

Data04

- 3D Depth: Min : 00 ~ Max : 14
- (*transmit by Hexadecimal code)

*If data01 is 00(3D On), data04 has no meaning.

*If data01 is 01(3D Off) or 02(3D to 2D), data02, data03 and data04 have no meaning.

*If data01 is 03(2D to 3D), data02 has no meaning.

Data 01	Data 02	Data 03	Data 04
00	o	o	x
01	x	x	x
02	x	x	x
03	x	o	o

x : Don't care

Acknowledgement [t][][OK][Data01][Data02][Data03][Data04][x][t][][NG][Data01][x]

16. Color Temperature (Command: x u)

To adjust color temperature.

You can also adjust color temperature in the PICTURE menu.

Transmission [x][u][][Set ID][][Data][Cr]

Data Min: 00 ~ Max: 64 (*transmit by Hexadecimal code)

*Refer to Real data mapping.

Acknowledgement [u][][Set ID][][OK/NG][Data][x]

17. Extended 3D (Command: x v) (For 3D TV)

To change 3D option for TV.

Transmission [x][v][][Set ID][][Data01][][Data02][Cr]

Data01: 3D option

- 00: 3D Picture Correction
- 01: 3D Depth (2D to 3D Only)
- 02: 3D Viewpoint
- 03: 3D Picture Size

04: 3D Picture Balance

05: 3D Optimization

Data02: It has own range for each 3D option determined by Data01.

1) When Data01 is 00

00: Right to Left 01: Left to Right

2) When Data01 is 01, 02

Data Min: 00 ~ Max: 14 (*transmit by Hexadecimal code)

3) When Data01 is 03

00: Just Scan 01: 16:9

4) When Data01 is 04

00: Off 01: On

5) When Data01 is 05

Data Min: 00 ~ Max: 02 (*transmit by Hexadecimal code)

Acknowledgement [v][][OK][Data01][Data02][x][v][][NG][Data01][x]

* Use the feature depending upon your model.

18. Auto Configuration (Command: j u)

To adjust picture position and minimize image shaking automatically. Auto configuration only works in RGB-PC mode.

Transmission [j][u][][Set ID][][Data][Cr]

Data 01: To set

Acknowledgement [u][][Set ID][][OK/NG][Data][x]

19. Channel Tuning (Command: m a)

To tune channel to following physical/major/minor number.

Transmission [m][a][][Set ID][][Data00][][Data01]

[][Data02][][Data03][][Data04][][Data05][Cr]

Digital channels have a Physical, Major, and Minor channel number. The Physical number is the actual digital channel number, the Major is the number that the channel should be mapped to, and the Minor is the sub-channel. Since the ATSC tuner automatically maps the channel to the Major number, the Physical number is not required when sending a command.

Data 00: Physical Channel Number

NTSC air: 02~45, NTSC cable: 01, 0E~7D

ATSC air: 01~45, ATSC cable: 01~87

Data 01 & 02: Major Channel Number

Data 01: High byte Data 02: Low byte

Two bytes are available for the Major and Minor, normally only the second byte is used.

Data 03 & 04: Minor Channel Number

Not needed for NTSC.

The table above lists the binary code which must be converted to Hexadecimal before sending. For example:

The binary code to tune the sub source to an NTSC cable channel is 1000 0001, which translates to 81 in Hex.

Data 05: Attribute

* 7th bit : For which source do you want to change the channel.

* 6th bit: Use a two part or one part channel. Most cases just use 0 since it's ignored when using NTSC.

* 5th bit: Use 0 with NTSC since it can only use the physical channel number. Normally use 1 for ATSC since most times it doesn't matter what the physical number is.

* 4th bit: Set to 0.

* 3-0 bits: Choose signal type.

* Tune Command Examples:

1. Tune to the analog (NTSC) cable channel 35.

Data 00 = Physical of 35 = 23

Data 01 & 02 = No Major = 00 00

Data 03 & 04 = No Minor = 00 00

Data 05 = 0000 0001 in binary = 01

Total = ma 00 23 00 00 00 00 01

2. Tune to the digital (ATSC) local channel 30-3.

Data 00 = Don't know Physical = 00

Data 01 & 02 = Major is 30 = 00 1E

Data 03 & 04 = Minor is 3 = 00 03

Data 05 = 0010 0010 in binary = 22

Total = ma 00 00 00 1E 00 03 22

* Use the feature depending upon your model.

20. Channel Add/Del (Command: m b)

To add and delete the channels.

Transmission [m][b][][Set ID][][Data][Cr]

Data 00: Channel Delete Data 01: Channel Add

Acknowledgement [b][][Set ID][][OK/NG][Data][x]

21. Key (Command: m c)

To send IR remote key code.

Transmission [m][c][][Set ID][][Data][Cr]

Data Key Code - See p. 29

Acknowledgement [c][][Set ID][][OK/NG][Data][x]

When TV is in the standby mode, TV will turn on by POWER button of remote control only.

22. Backlight (Command: m g)

To adjust screen backlight.

Transmission [m][g][][Set ID][][Data][Cr]

Data Min:00 ~ Max:64 (*transmit by Hexadecimal code)

*Refer to Real data mapping.

Acknowledgement [g][][Set ID][][OK/NG][Data][x]

23. Equalize (Command: j v)

To adjust equalize.

Transmission [j][v][][Set ID][][Data][Cr]

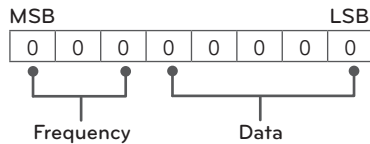

7	6	5	Frequency	4	3	2	1	0	Step
0	0	0	1st Band	0	0	0	0	0	0(decimal)
0	0	1	2nd Band	0	0	0	0	1	1(decimal)
0	1	0	3rd Band
0	1	1	4th Band	1	0	0	1	1	19(decimal)
1	0	0	5th Band	1	0	1	0	0	20(decimal)

Acknowledgement [v][][Set ID][][OK/NG][Data][x]

Example) To specify the value of the 5th band (10 kHz) as +5:

To specify the value of the 5th band as +5, 100 in binary, which falls in 7th, 6th and 5th bit, is necessary. To calculate the value, take 0, with the minimum value of -10, as a base. Then the value for +5 is 15 that equals 01111 in binary. To consolidate these values and send it as a command, first, put the two binary digits together: 10001111. This equals 8F in hexadecimal. Enter **ju 00 8F** to use as a command.

* Table List (Channel Tuning)

7	Main/Sub Picture	6	Two/One Part Channel	5	Using Physical Channel	4 Reserved	3	2	1	0	Step
0	Main	0	Two	0	Use	x	0	0	0	0	NTSC Air
1	Sub	1	One	1	No Use	x	0	0	0	1	NTSC Cable
						x	0	0	1	0	ATSC Air
						x	0	0	1	1	ATSC Cable_std
						x	0	1	0	0	ATSC Cable_hrc
						x	0	1	0	1	ATSC Cable_irc
						x	0	1	1	0	ATSC cable_auto
						x	0	1	1	1	Reserved
						x	x	x	x	x	...
						x	1	1	1	1	Reserved

CHILD SAFETY:

PROPER TELEVISION PLACEMENT MATTERS



THE CONSUMER ELECTRONICS INDUSTRY CARES

- Manufacturers, retailers and the rest of the consumer electronics industry are committed to making home entertainment safe and enjoyable.
- As you enjoy your television, please note that all televisions – new and old- must be supported on proper stands or installed according to the manufacturer’s recommendations. Televisions that are inappropriately situated on dressers, bookcases, shelves, desks, speakers, chests, carts, etc., may fall over, resulting in injury.



TUNE IN TO SAFETY

- **ALWAYS** follow the manufacturer’s recommendations for the safe installation of your television.
- **ALWAYS** read and follow all instructions for proper use of your television.
- **NEVER** allow children to climb on or play on the television or the furniture on which the television is placed.
- **NEVER** place the television on furniture that can easily be used as steps, such as a chest of drawers.
- **ALWAYS** install the television where it cannot be pushed, pulled over or knocked down.
- **ALWAYS** route cords and cables connected to the television so that they cannot be tripped over, pulled or grabbed.



WALL OR CEILING MOUNT YOUR TELEVISION

- **ALWAYS** contact your retailer about professional installation if you have any doubts about your ability to safely mount your television.
- **ALWAYS** use a mount that has been recommended by the television manufacturer and has a safety certification by an independent laboratory (such as UL, CSA, ETL).
- **ALWAYS** follow all instructions supplied by the television and mount manufacturers.
- **ALWAYS** make sure that the wall or ceiling where you are mounting the television is appropriate. Some mounts are not designed to be mounted to walls and ceilings with steel studs or cinder block construction. If you are unsure, contact a professional installer.
- Televisions can be heavy. A minimum of two people is required for a wall or ceiling mount installation.



MOVING AN OLDER TELEVISION TO A NEW PLACE IN YOUR HOME

- Many new television buyers move their older CRT televisions into a secondary room after the purchase of a flat-panel television. Special care should be made in the placement of older CRT televisions.
- **ALWAYS** place your older CRT television on furniture that is sturdy and appropriate for its size and weight.
- **NEVER** place your older CRT television on a dresser where children may be tempted to use the drawers to climb.
- **ALWAYS** make sure your older CRT television does not hang over the edge of your furniture.

CE.org/safety





Declaration of Conformity

Trade Name: LG
Model:
22/29/32/39/42/47/55/60/65LY340C-UA
42/47/55/65LY540S-UA
Responsible Party: LG Electronics Inc.
Address: 1000 Sylvan Ave.
Englewood Cliffs NJ 07632
U.S.A
TEL: 201-266-2534

LG Customer Information Center

For inquires or comments, visit www.lg.com or call;

1-888-865-3026 USA, Commercial User
1-888-542-2623 CANADA

The model and serial number of the TV are located on the back and on one side of the TV. Record them below should you ever need service.

MODEL _____

SERIAL _____



This product qualifies for ENERGY STAR in the factory default (Home Use) setting. Changing the factory default settings or enabling other features may increase power consumption that could exceed the limits necessary to qualify for ENERGY STAR. Refer to ENERGYSTAR.gov for more information on the ENERGY STAR program.

Free Manuals Download Website

<http://myh66.com>

<http://usermanuals.us>

<http://www.somanuals.com>

<http://www.4manuals.cc>

<http://www.manual-lib.com>

<http://www.404manual.com>

<http://www.luxmanual.com>

<http://aubethermostatmanual.com>

Golf course search by state

<http://golfingnear.com>

Email search by domain

<http://emailbydomain.com>

Auto manuals search

<http://auto.somanuals.com>

TV manuals search

<http://tv.somanuals.com>