



**22LG3DCH 26LG3DCH 32LG3DCH
22LG3DDH 26LG3DDH 32LG3DDH**

Hospital TVs

Commercial Mode Setup Guide

Note: Selected features shown within this guide may not be available on all models.

EXPERIENCED INSTALLER

Commercial Mode Setup
pages 14 – 15

Express Script
pages 16 – 17

Cloning Information
pages 30 – 35

For Customer Support/Service, please call:
1-888-865-3026

The latest product information and documentation is available online at:
www.LGolutions.com/products

MODEL and SERIAL NUMBER

The model and serial numbers of this TV are located on the back of the cabinet. For future reference, LG suggests that you record those numbers here:

Model No. _____ Serial No. _____



WARNING:

TO REDUCE THE RISK OF ELECTRIC SHOCK DO NOT REMOVE COVER (OR BACK). NO USER-SERVICEABLE PARTS INSIDE. REFER TO QUALIFIED SERVICE PERSONNEL.



The lightning flash with arrowhead symbol, within an equilateral triangle, is intended to alert the user to the presence of uninsulated “dangerous voltage” within the product’s enclosure that may be of sufficient magnitude to constitute a risk of electric shock to persons.



The exclamation point within an equilateral triangle is intended to alert the user to the presence of important operating and maintenance (servicing) instructions in the literature accompanying the appliance.

WARNING:

TO PREVENT FIRE OR SHOCK HAZARDS, DO NOT EXPOSE THIS PRODUCT TO RAIN OR MOISTURE.

POWER CORD POLARIZATION:

This product is equipped with a 3-wire grounding-type alternating current power plug. This plug will fit into the power outlet only one way. This is a safety feature. If you are unable to insert the plug fully into the outlet, contact your electrician to replace your obsolete outlet. Do not defeat the safety purpose of the 3-wire grounding-type plug.

NOTE TO CABLE/TV INSTALLER:

This reminder is provided to call the cable TV system installer’s attention to Article 820-40 of the National Electric Code (U.S.A.). The code provides guidelines for proper grounding and, in particular, specifies that the cable ground shall be connected to the grounding system of the building, as close to the point of the cable entry as practical.

REGULATORY INFORMATION:

This equipment has been tested and found to comply with the limits for a Class B digital device, pursuant to Part 15 of the FCC Rules. These limits are designed to provide reasonable protection against harmful interference when the equipment is operated in a residential installation. This equipment generates, uses and can radiate radio frequency energy and, if not installed and used in accordance with the instruction manual, may cause harmful interference to radio communications. However, there is no guarantee that interference will not occur in a particular installation. If this equipment does cause harmful interference to radio or television reception, which can be determined by turning the equipment off and on, the user is encouraged to try to correct the interference by one or more of the following measures:

- Reorient or relocate the receiving antenna.
- Increase the separation between the equipment and receiver.
- Connect the equipment to an outlet on a circuit different from that to which the receiver is connected.
- Consult the dealer or an experienced radio/TV technician for help.

CAUTION:

Do not attempt to modify this product in any way without written authorization from LG Electronics U.S.A., Inc. Unauthorized modification could void the user’s authority to operate this product.

COMPLIANCE:

The responsible party for this product’s compliance is: LG Electronics U.S.A., Inc.
1000 Sylvan Avenue, Englewood Cliffs, NJ 07632, USA • Phone: 1-201-816-2000

Marketed and Distributed in the United States by LG Electronics U.S.A., Inc.
1000 Sylvan Avenue, Englewood Cliffs, NJ 07632

IMPORTANT SAFETY INSTRUCTIONS

1. Read these instructions.
 2. Keep these instructions.
 3. Heed all warnings.
 4. Follow all instructions.
 5. Do not use this apparatus near water.
 6. Clean only with dry cloth.
 7. Do not block any ventilation openings. Install in accordance with the manufacturer's instructions.
 8. Do not install near any heat sources, such as radiators, heat registers, stoves, or other apparatus (including amplifiers) that produce heat.
 9. Do not defeat the safety purpose of the polarized or grounding-type plug. A polarized plug has two blades with one wider than the other. A grounding-type plug has two blades and a third grounding prong. The wide blade or the third prong are provided for your safety. If the provided plug does not fit into your outlet, consult an electrician for replacement of the obsolete outlet.
 10. Protect the power cord from being walked on or pinched, particularly at plugs, convenience receptacles, and the point where it exits from the apparatus.
 11. Only use attachments/accessories specified by the manufacturer.
 12. Use only with the cart, stand, tripod, bracket, or table specified by the manufacturer or sold with the apparatus. When a cart is used, use caution when moving the cart/apparatus combination in order to avoid injury from tip-over.
- PORTABLE CART WARNING
13. Refer all servicing to qualified service personnel. Servicing is required when the apparatus has been damaged in any way, such as power-supply cord or plug is damaged, liquid has been spilled or objects have fallen into the apparatus, the apparatus has been exposed to rain or moisture, does not operate normally, or has been dropped.

14. Never touch this apparatus or antenna during a thunder or lightning storm.
15. When mounting a TV on the wall, make sure not to install the TV by the hanging power and signal cables on the back of the TV.
16. Do not allow an impact shock or any objects to fall into the product, and do not drop objects onto the screen.

17. Power Cord

Caution: It is recommended that appliances be placed upon a dedicated circuit; that is, a single outlet circuit which powers only that appliance and has no additional outlets or branch circuits. Check the specification page of the Owner's Manual to be certain.

Periodically examine the cord of your appliance, and if its appearance indicates damage or deterioration, unplug it, discontinue use of the appliance, and have the cord replaced with an exact replacement part by an authorized servicer. Protect the power cord from physical or mechanical abuse, such as twisting, kinking, or pinching or being closed in a door or walked upon. Pay particular attention to plugs, wall outlets, and the point where the cord exits the appliance.

Do not use a damaged or loose power cord. Be sure to grasp the plug when unplugging the power cord. Do not pull on the power cord to unplug the TV.

18. Overloading

Do not connect too many appliances to the same AC power outlet as this could result in fire or electric shock. Do not overload wall outlets. Overloaded wall outlets, loose or damaged wall outlets, extension cords, frayed power cords, or damaged or cracked wire insulation are dangerous. Any of these conditions could result in fire or electric shock.

19. Outdoor Use/Wet Location



Warning: To reduce the risk of fire or electrical shock, do not expose this product to rain, moisture or other liquids.

Do not touch the TV with wet hands. Do not install this product near flammable objects such as gasoline or candles or expose the TV to direct air conditioning.

Do not expose to dripping or splashing and do not place objects filled with liquids, such as vases, cups, etc., on or over the apparatus (e.g., on shelves above the unit).

(Continued on next page)

IMPORTANT SAFETY INSTRUCTIONS

(Continued from previous page)

20. Grounding

Ensure that you connect the earth ground wire to prevent possible electric shock (i.e., a TV with a three-prong grounded AC plug must be connected to a three-prong grounded AC outlet). If grounding methods are not possible, have a qualified electrician install a separate circuit breaker. Do not try to ground the unit by connecting it to telephone wires, lightning rods, or gas pipes.

21. Disconnect Device

The mains plug is the disconnecting device. The plug must remain readily operable.

As long as this unit is connected to the AC wall outlet, it is not disconnected from the AC power source even if you turn off this unit by SWITCH.

22. Outdoor Antenna Grounding

If an outside antenna or cable system is connected to the product, follow the precautions below.

An outdoor antenna system should not be located in the vicinity of overhead power lines or other electric light or power circuits or where it can come into contact with such power lines or circuits as death or serious injury can occur.

Be sure the antenna system is grounded so as to provide some protection against voltage surges and built-up static charges.

Article 810 of the National Electrical Code (NEC) in the U.S.A. provides information with respect to proper grounding of the mast and supporting structure, grounding of the lead-in wire to an antenna-discharge unit, size of grounding conductors, location of antenna-discharge unit, connection to grounding electrodes, and requirements for the grounding electrode.

Antenna Grounding According to NEC, ANSI/NFPA 70

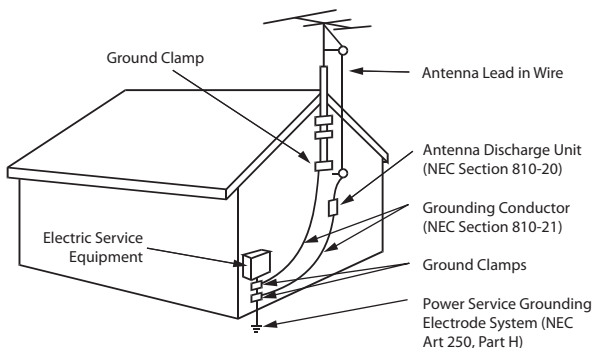

23. Cleaning

When cleaning, unplug the power cord and rub gently with a soft cloth to prevent scratching. Do not spray water or other liquids directly on the TV as electric shock may occur. Do not clean with chemicals such as alcohol, thinners or benzene.

24. Transporting Product

Make sure the product is turned Off and unplugged and that all cables have been removed. It may take two or more people to carry larger TVs. Do not press against or put stress on the front panel of the TV.

25. Ventilation

Install the TV where there is proper ventilation. Do not install in a confined space such as a bookcase. Do not cover the product with cloth or other materials (e.g., plastic) while it is plugged in. Do not install in excessively dusty places.

26. Do not touch the ventilation openings, as they may become hot while the TV is operating.

27. If you smell smoke or other odors coming from the TV or hear strange sounds, unplug the power cord, and contact an authorized service center.

28. Do not press strongly on the panel with a hand or sharp object (e.g., a nail, pencil, or pen) or make a scratch on it.

29. Keep the product away from direct sunlight.

30. For LCD TV

If the TV feels cold to the touch, there may be a small "flicker" when it is turned On. This is normal; there is nothing wrong with TV. Some minute dot defects may be visible on the screen, appearing as tiny red, green, or blue spots. However, they have no adverse effect on the monitor's performance. Avoid touching the LCD screen or holding your finger(s) against it for long periods of time. Doing so may produce some temporary distortion effects on the screen.

Table of Contents

Safety Warnings	2	Cloning Procedures	31–35
Important Safety Instructions	3–4	Learning / Teaching a Master TV Setup using a USB Memory Device	31
Table of Contents	5	Learning / Teaching a Master TV Setup using a TLL-1100A Clone Programmer	32–33
TV Overview / Setup Checklist	6	Learning / Teaching a Master TV Setup using an LT2002 Clone Programmer	34–35
VESA Standard TV Mounts	7	References	
Rear Connections Panel	8	Upgrading TV/PTC Software using a USB Memory Device	36
Side Connections Panel / RF Antenna & MPI Connections	9	Power Consumption Settings	37
MPI Card Slot	10	TV Camport Auto Sense Operation	38
Pillow Speaker Setup	11	TV Aux Input Configuration	39
Installer Overview	12	Troubleshooting	40–44
Installer Remote Control Typical Key Functions	13	General Troubleshooting	40
Commercial Mode Setup for Master TV	14–15	Troubleshooting Flow Chart	41
Express Script Installer Menu Wizard	16–17	Commercial Mode Check	42
Installer Menu	18–23	Clone Programmer Troubleshooting	43
TV Setup Menus Overview	24	Channel Banks Setup Troubleshooting	44
Adding Channel Icons / Custom Channel Labels (2-5-4 + MENU Mode)	25	Glossary of Terms	45
Channel Banks Overview	26	Document Revision History / Notes	46
Channel Banks Setup	27–28	Back Cover	47
Channel Banks Worksheet	29		
Cloning Overview / Clonable Menu Features	30		

Notes

- Installer Menu content is intended for use primarily by qualified TV electronics technicians.
- Refer to the Owner's Manual for additional information on TV features, specifications, maintenance, and safety instructions.
- For additional information, contact your LG representative.

For Customer Support/Service, please call:

1-888-865-3026

www.LGolutions.com

Note: Design and specifications subject to change without prior notice.

TV Overview / Setup Checklist

TV Overview

Using the Hospital TV, the patient has available the following entertainment options:

- Pillow speaker control of TV.
 - Auxiliary inputs on side connections panel, if enabled.
 - Analog and digital programming entertainment as provided by hospital: VHF, UHF, DTV, CATV, CADTV.
 - 16:9 aspect ratio.
 - SRS surround sound or infinite sound.
 - Digital captions.
 - Tier programming as available through Channel Banks setup, RF delivered programming content options for premium as well as basic entertainment packages.
 - Headphone(s) output jack.
-

Setup Checklist

Installation and Setup Checklist

- ___ Unpack TV and all accessories.
- ___ Install batteries in remote control.
- ___ Install TV on VESA mount or stand.
Note: It may be advisable to make all cable connections before installing on VESA mount or stand, as appropriate.

Hardware Connections

- ___ Install any additional hardware as appropriate to your institution, LAN, etc.

Cable Connections

- ___ Make all connections to rear jack panel and RF antenna on MPI/PPV card.

Commercial Mode Setup

- ___ Complete Commercial Mode Setup or Express Script (configure all relevant Installer Menu items as required of your institution and configure display features for the end user).

Software Installation

- ___ Install or configure any software, as applicable, for example, PPV, etc.

General Guidelines: Choosing a Location for Installing a VESA Standard Mount

To the right are some examples of VESA standard mounts. Since there are numerous types of stands and mounts available, only a few are shown here. Refer to the instructions provided with the TV stand that will be used to mount the TV. Be sure the style of stand selected is capable of supporting the weight of the TV and is appropriate for the application.

Wall Mounts

If the mount will be on a wall, a typical wooden stud behind the wall board would be the preferred choice for a location to attach the wall mount. The wall mount location chosen should be appropriate for drilling holes and have available the required power source as well as antenna/cable and any other equipment leads as necessary.

Pedestal Mounts and Stands

A sturdy surface on a desk or other similar flat table-like furniture would be the appropriate location for mounting a pedestal-style TV stand.

Most stands are designed so that the wiring is threaded through the stand itself or a loop-through style clamp so that the wiring is neatly bunched and not strung in such a way as to create a potential hazard to the user. (Some stands are portable and can be moved from one location to another.) Be sure all safety considerations are followed.

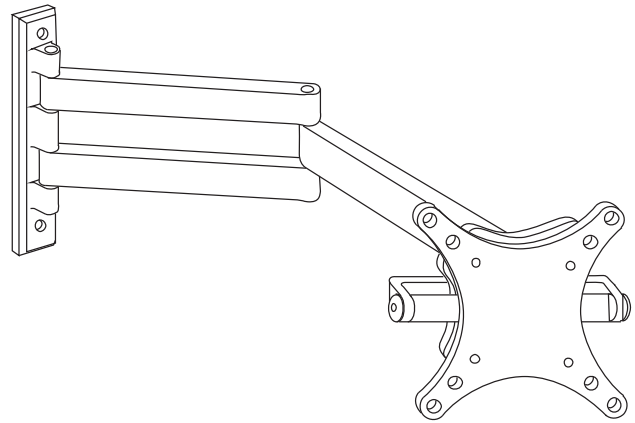

Typical Wall Stud Type Mount with Swivel Bracket

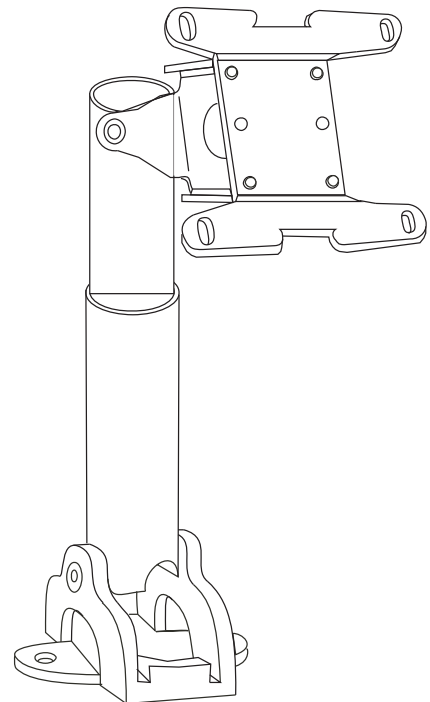

Typical Pedestal Type Mount with Swivel Bracket

Rear Connections Panel

26/32LG3DCH 26/32LG3DDH

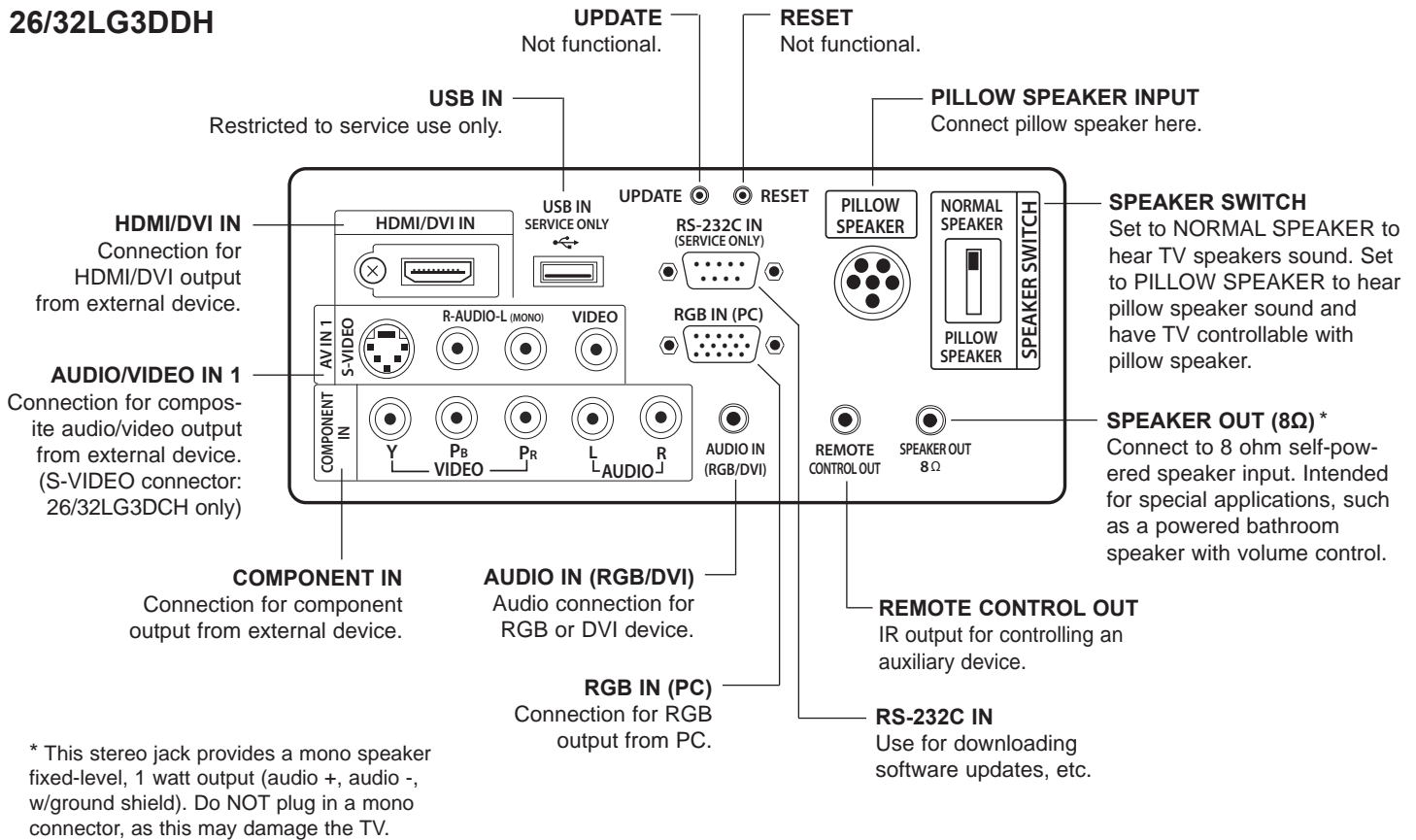

22LG3DCH 22LG3DDH

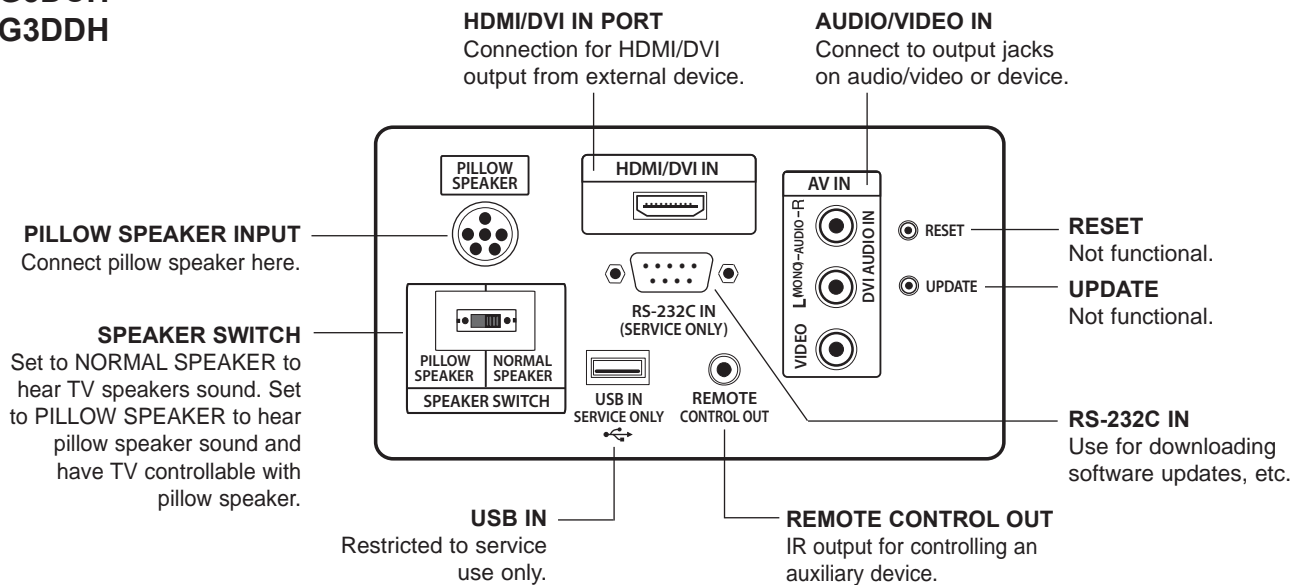

Side Connections Panel / RF Antenna & MPI Connections

Side Connections Panel

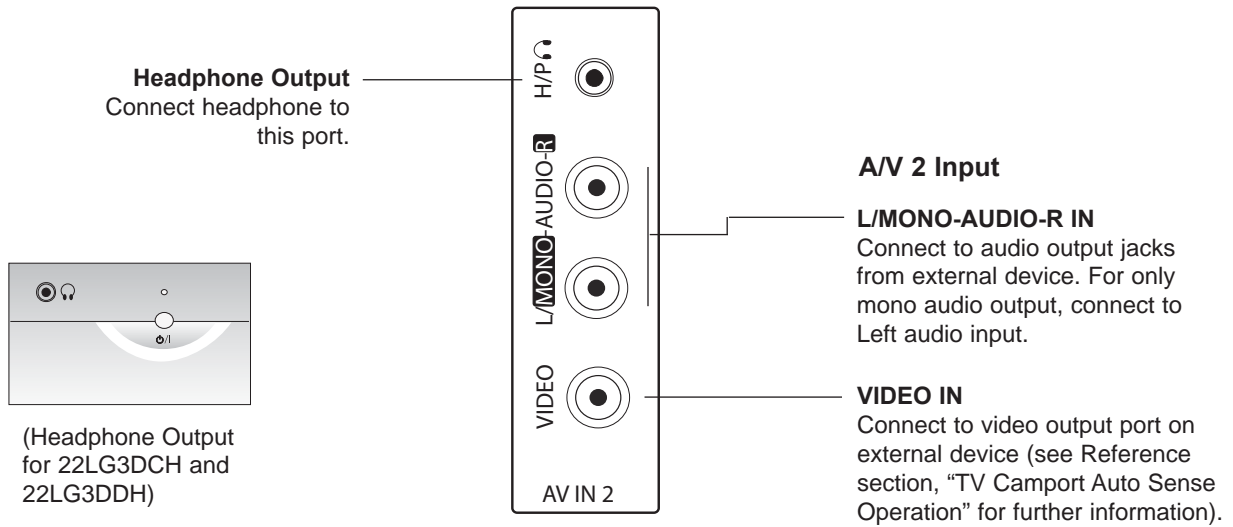

RF Antenna & MPI Connections

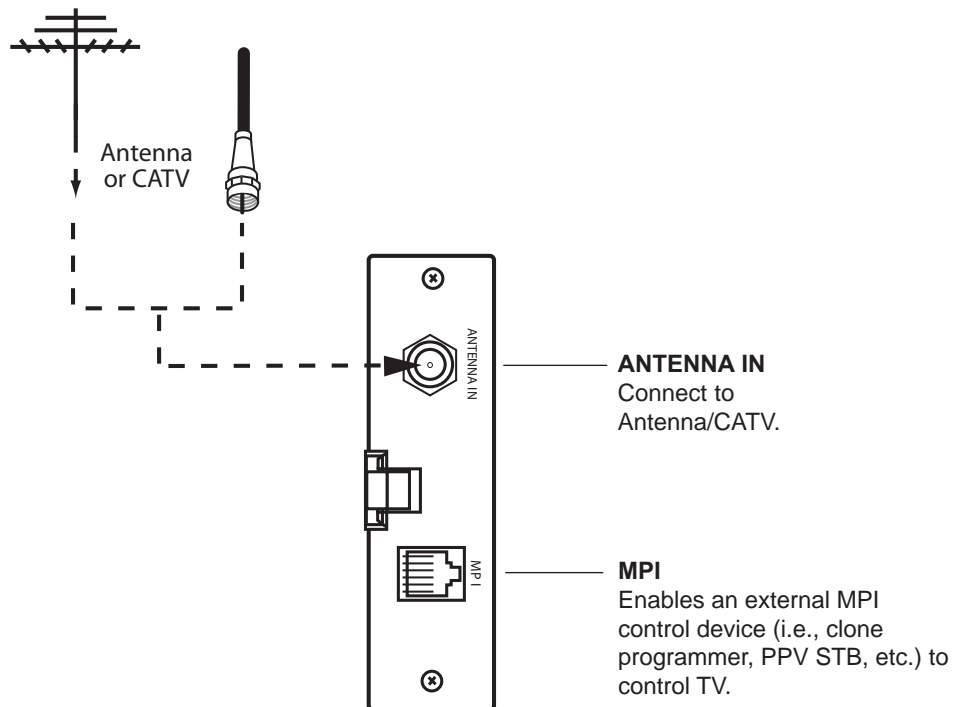

MPI Card Slot

The MPI card is equipped with an RF jack for antenna/cable signal source connection. The slot is also available for installing a PPV card.



Note: (LG3DDH TVs only) Turn the TV On. If the Express Script Installer Menu Wizard is present on the display (e.g., this is the first time the TV has been turned On), exit the Express Script before inserting the PPV card.

MPI Card Removal / PPV Card Installation

1. Remove the two MPI card retainer screws.
2. Pull out the current MPI card far enough so that the RF cable can be detached from the old card.
3. Detach the RF cable.
4. Place the new PPV card into the slot and slide it in far enough to reconnect the RF cable.
5. Reconnect the RF cable.
6. Insert the card all the way into the slot making sure it is fully seated into the back plane connector.
7. Replace the two card retainer screws.

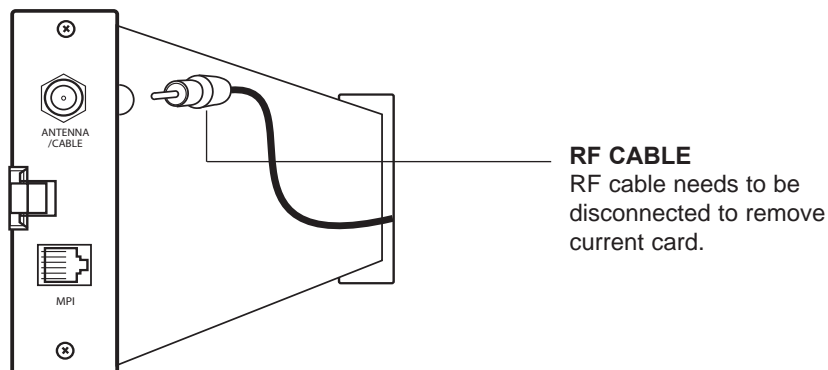

Pillow Speaker Setup

Set up pillow speaker after Commercial Mode Setup and Cloning procedures are complete.

Connect a Pillow Speaker to the LCD TV/Monitor

1. Connect the Pillow Speaker to the output jack on the back of the TV.
2. Either:
 - Slide the control switch to **PILLOW SPEAKER** on the rear panel of the TV to control TV and hear audio on pillow speaker.
 - For TV speakers sound with pillow speaker control, set the control switch to **NORMAL SPEAKER**.

Use a pillow speaker that is a UL recognized pendant control bearing the warning: "Risk of fire if used in oxygen enriched atmosphere. Keep pendant control away from oxygen equipment."

Controlling the TV with Serial Data

The TV is capable of being controlled by a single-wire, serial data signal. This is an LG patented technology and is being implemented by certain brands of "smart" pillow speakers.

Controlling the TV with Mechanical Switches

Pin 4 (common) is momentarily connected to pin 1, 3, or 6 via push-action switches to control Power On/Off and Channel Up/Down. These pins are at +13 volts DC (when measured from pin 4) with the switches open. Current draw is 8 mA when a switch is closed. (This operation is identical to previous models using the 5-wire interface, except that only +7 volts DC was supplied and current draw was only 2.5 mA.)

Pin No.	Description
1	External TV On/Off switch.
2	(Not used)
3	External Channel Up switch or Data in.
4	Common connection for control, data, and audio output. Impedance to earth ground is a 10-meg resistor in parallel with a 1100 pf capacitor.
5	Isolated audio output. Nominal 14 ohm source impedance with short circuit protection. Intended for a pillow speaker with a low-impedance pad-type volume control.
6	External Channel Down switch.

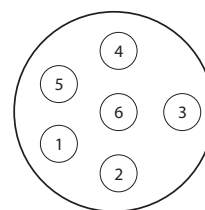
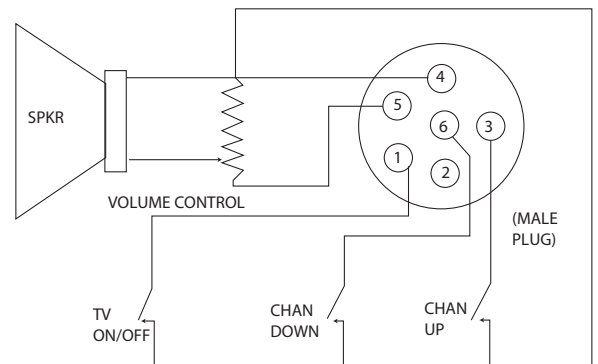
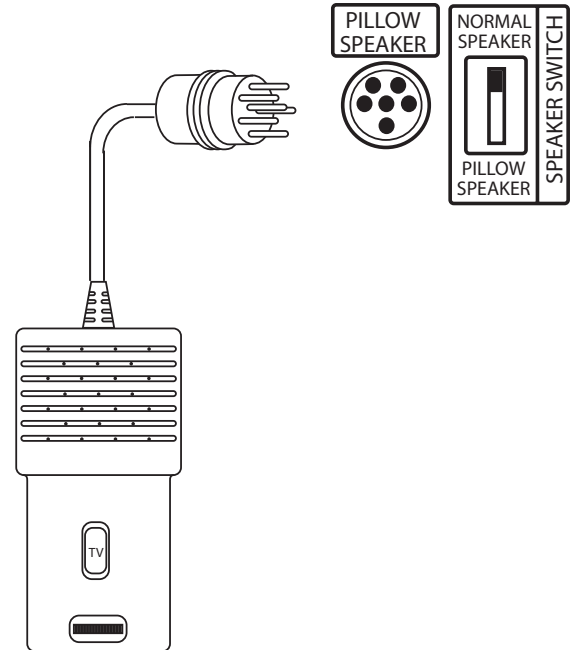

- 1 — TV ON/OFF
- 2 — OPEN
- 3 — CHAN UP/DATA IN
- 4 — COMMON
- 5 — AUDIO OUT
- 6 — CHAN DOWN

Installer Overview

This is the Commercial Mode Setup Guide only.

Installer Menu / Commercial Mode Setup

To set up a Master TV, you will need to know how to enter the TV Installer Menu and make changes to the default values as required. If necessary, familiarize yourself with the Installer Menu and how to make and save changes. Refer to page 18 for information on accessing the Installer Menu. Pages 18 to 23 describe Installer Menu items in detail.

Installer Remote

An LG Installer Remote similar to that shown to the right is required to set up and operate the TV. See next page for typical key functions.

Cloning

Cloning refers to the process of capturing a Master TV Setup and transferring it to a Target TV. The Master TV's clonable features need to be configured as part of the Commercial Mode Setup. This is a critical step. If the Master TV's clonable features—channel icons or labels, digital font options, etc.—are not set up correctly, the cloned TVs will all have problems. Pages 30 to 35 provide detailed information on cloning requirements and procedures.

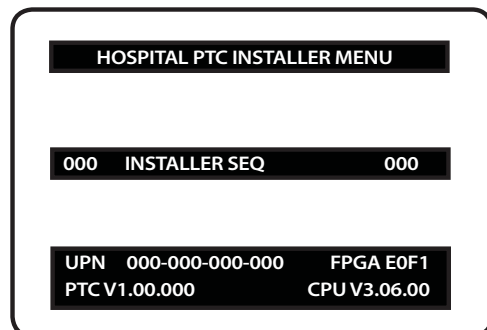

Typical Installer Menu

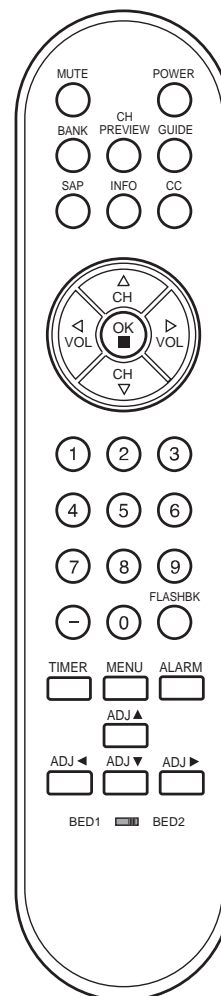

Installing Batteries in Installer Remote

- Remove the battery compartment cover on the back side of the remote by pressing the arrow tab forward and lifting.
- Install two high-quality alkaline 1.5V AAA batteries. Never mix old or used batteries with new ones. Install batteries matching correct polarity as shown (+ with + and - with -).
- Replace the battery compartment cover.

Installer Remote Control Typical Key Functions

To put the Installer Remote into TV operating mode, select TV with the MODE button.

The LG Installer Remote illustrated below and throughout this document shows typical remote control functions and is provided for reference only. This Installer Remote may vary from your Installer Remote.

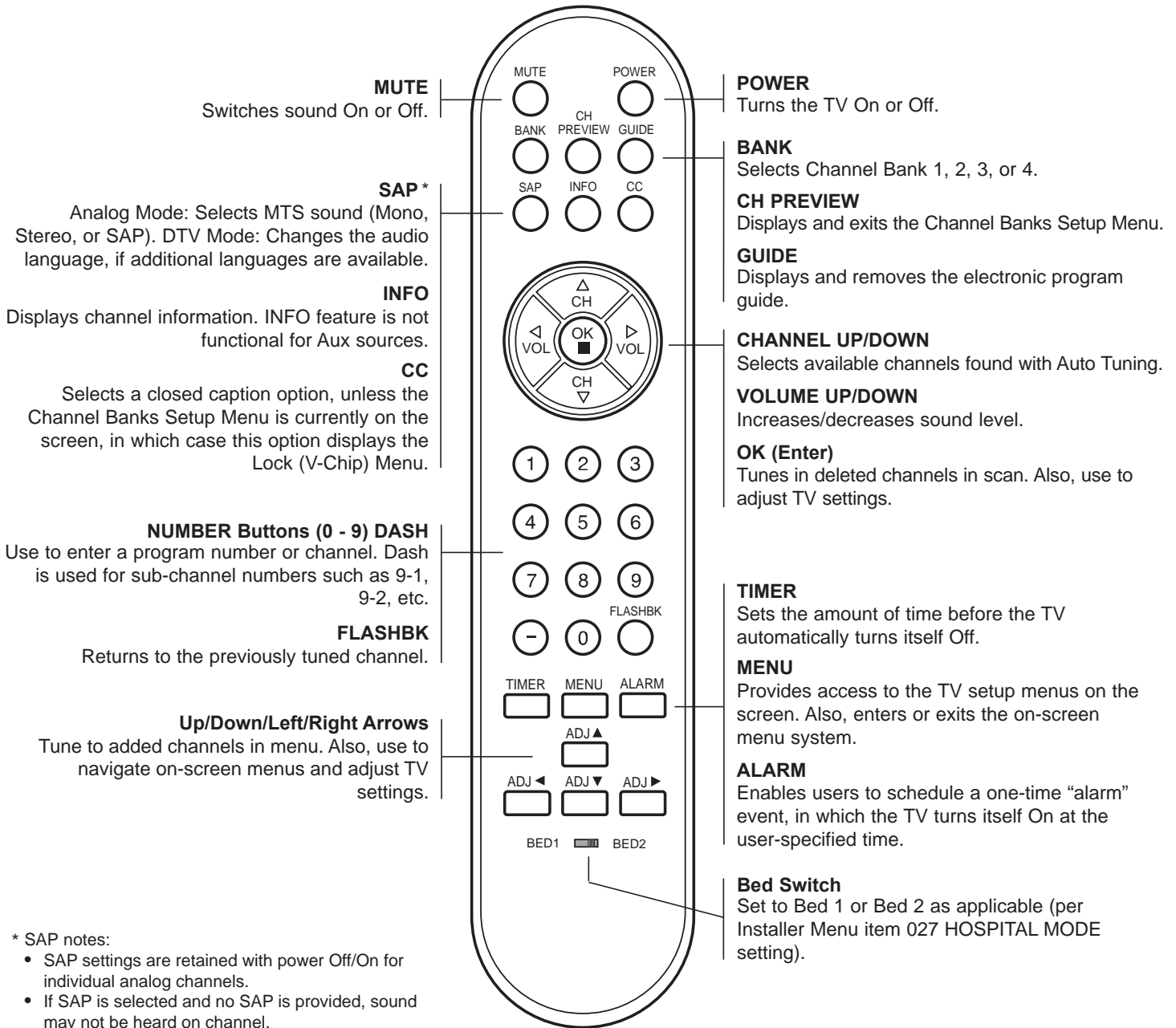

- * SAP notes:
- SAP settings are retained with power Off/On for individual analog channels.
 - If SAP is selected and no SAP is provided, sound may not be heard on channel.
 - Each analog channel may have its own SAP setting.
 - Digital channels will reset to default audio language with a power Off/On.

Commercial Mode Setup for Master TV

This section provides an overview of manual TV configuration. On LG3DDH TVs, these steps are automated in an Express Setup Script (see pages 16–17).

This section describes how to set up a Master TV.

Note: It is recommended that you disconnect all Aux inputs. Under certain conditions, Auto Tuning (Channel Search) is disabled if there is an Aux input active.

Note: If not disabled in the Installer Menu, Aux sources will appear in the channel scan between analog and digital channels after the TV setup is transferred to the internal TV controller (Protocol Translator Card [PTC]).

Note: If the Express Script Installer Menu Wizard is present on the display, exit the Express Script before beginning/continuing this procedure.

1. Set Installer Menu items.

- a) Use the Installer Remote to enter the TV Installer Menu: Press **MENU** repeatedly until the on-screen menu locks up, and then press **9-8-7-6 + OK (Enter)**. Refer to pages 18 to 23 for detailed information on Installer Menu items.
- b) Set Installer Menu item **117 FACT DEFAULT** to **001** and press **OK (Enter)** on the Installer Remote.

This clears all Installer Menu custom settings, channel labels/ icons, etc. and reloads the factory default settings. The value will change back to 0 after the PTC has been restored to factory default condition. This step ensures that the TV Channel Memory will be the active Channel List.

- c) Set Installer Menu item **003 BAND/AFC**, as appropriate, and press **OK (Enter)**.
 - Broadcast: Set to 000.
 - CATV: Set to 001 (default).
 - HRC: Set to 002.
 - IRC: Set to 003.
- d) Set any other Installer Menu items that affect your TV programming network to the required configuration. For example, enable/disable Aux sources, set a Start Channel, etc.
- e) After you have adjusted all required Installer Menu item settings, press **OK (Enter)** on the Installer Remote to exit the menu and save your changes.

2. Set up TV features.

On-screen setup menus control the features of the TV (see page 24). Press **MENU** on the Installer Remote to access the setup menus, and then set Channel, Picture, Audio, etc. options to the desired configurations. See also the Clonable Menu Features list on page 30.

Note: If desired, you can run Auto Tuning (see step 3) prior to completing this step.

3. Run Auto Tuning (Channel Search).

- a) Search for all available analog and digital channels: Go to the Channel Menu, select the **Auto Tuning** option, and follow the on-screen instructions.

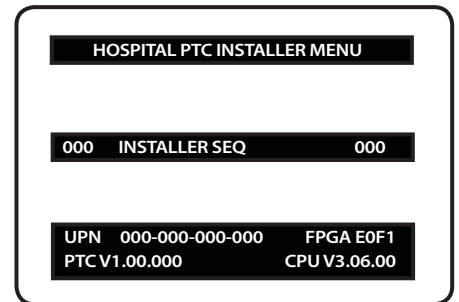

Typical TV Installer Menu

Note: The Installer Menu header will vary depending on the TV you are setting up.

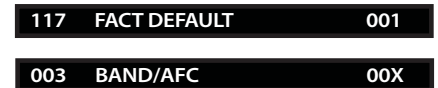

Adjust the settings for these Installer Menu items.

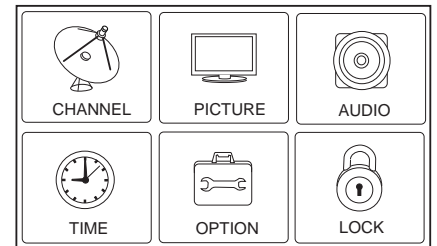

Set the TV features to the desired configuration for the end user.

(Continued on next page)

Commercial Mode Setup for Master TV (Cont.)

(Continued from previous page)

3. Run Auto Tuning (Channel Search). (continued)

- b) Use the **Channel Edit** option in the Channel Menu to edit the channel lineup, as necessary, to include free to guest channels only.
- Add/delete channels per your system requirements. Note that physical channel numbers are used to identify virtual channels. Also, channel numbers cannot be higher than 255.
 - Use the **Channel Label** option in the Channel Menu to add familiar channel trademarks/logos such as ABC, CBS, NBC, etc. to the Channel-Time on-screen display. Identifiable labels (logos) should enable the end user to readily know what common networks are available. (You can add the channel labels in this step, or you can add channel logos or labels for channels without icons in step 5.)

4. Transfer the TV Setup to the internal TV Controller (PTC): 2-5-5 + MENU Mode

After the TV channel lineup has been edited and channel label icons added, enter the Installer Menu. Once in the Installer Menu, press **2-5-5 + MENU** on the Installer Remote to initiate the transfer of the Master TV Setup to the PTC. Once the transfer is complete, the TV will exit the Installer Menu.

Note: The maximum number of active channels and Aux sources that can be transferred is 141. Total channels numbering more than 141 will result in erratic TV operation.

Note: Scan Mode is not functional until the TV setup is transferred.

5. Add Custom Channel and Aux Source Labels for Analog Channels: 2-5-4 + MENU Mode

Enter the Installer Menu, and press **2-5-4 + MENU** on the Installer Remote. Add/edit custom text labels to channel on-screen displays. Note that digital channels often have a broadcaster generated label (see 2-5-4 + MENU procedural information on page 25). When you are finished, press **MENU** to exit 2-5-4 + MENU Mode.

6. Verify the TV setup.

At this point, verify that the channel lineup, channel icons, and custom labels are correct. Make sure the TV features are set per your requirements.

7. Set up channel banks.

Set up channel banks, as desired (see pages 26 to 29).

Note: When you lock the channel lineup (see next step), the Channel Banks Setup Menu is no longer accessible via the Installer Remote. If you wish to set up channel banks at a later time, you will need to set Installer Menu item 028 CH. OVERRIDE to 001 to enable access to the Channel Banks Setup Menu.

8. (Recommended) Lock the channel lineup.

Enter the Installer Menu, and set item **028 CH. OVERRIDE** to **000** to lock the channel lineup and restrict access to the TV setup menus.* Press **OK (Enter)** to exit the Installer Menu and save your changes.

The Master TV Setup is now ready to be copied to a clone programmer (see cloning information in this document).

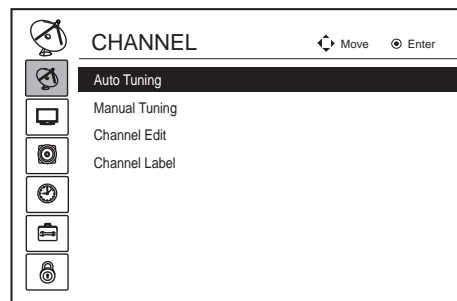

Run Auto Tuning, edit channels, and select familiar channel trademarks/logos using Channel Menu options.

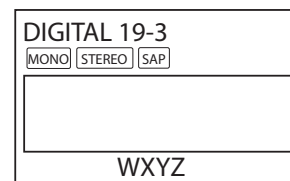

Custom Text Label "WXYZ" created in 2-5-4 + MENU (Add Channel Label) Mode.

028 CH. OVERRIDE 000

After verifying the TV Setup, set Installer Menu item 028 CH. OVERRIDE to 000.*

* This step prevents end users from accessing channel settings (i.e., the Channel Menu will be inaccessible/grayed out).

Express Script Installer Menu Wizard

(LG3DDH TVs only)

The Express Script Installer Menu Wizard enables users to set up essential items for viewing the TV the first time it is turned On. The Express Script Installer Menu Wizard can also be activated from the Installer Menu—set Installer Menu item **117 FACT DEFAULT** to **001** to reinitiate the Express Script (see the “Installer Menu” section of this document for further information).

Note: If you plan to perform the Commercial Mode Setup using the procedure on pages 14 to 15, via cloning, or via the FTG (Free-To-Guest) Configuration Application, be sure to exit the Express Script in order to avoid setup conflicts that may cause the TV to malfunction.

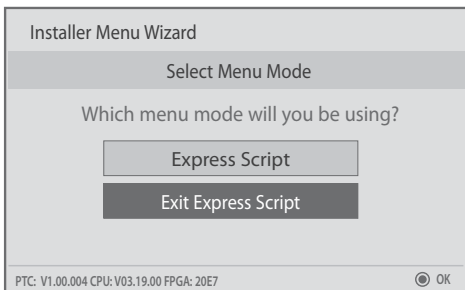

1. Upon launching, the Installer Menu Wizard prompts you to select a preferred Menu Mode. Use the Up/Down arrow keys on the Installer Remote to select/highlight **Express Script** in order to proceed with the Installer Menu Wizard. Then, press **OK (Enter)** on the Installer Remote.

The remaining steps of this procedure describe the Express Script Installer Menu Wizard. Use the Installer Remote to make selections and complete each step. You can select the Back button, where available, to check previous settings, as necessary.

Note: Select **Exit Express Script** and press **OK (Enter)** if you wish to exit the Installer Menu Wizard.

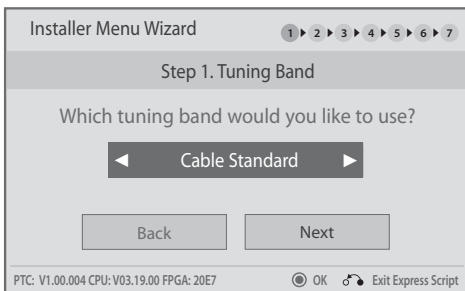

2. Use the Left/Right arrow keys to select the appropriate tuning band (Cable Standard [default], Cable HRC, Cable IRC, or Air). When you have made your selection, use the arrow keys to select **Next**, and then press **OK (Enter)**.

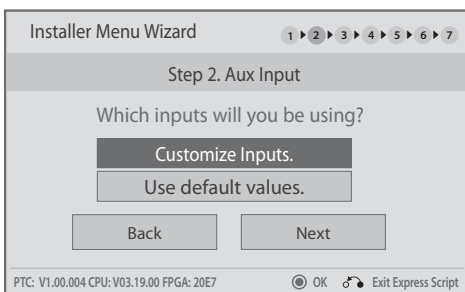

3. Use the Up/Down arrow keys to select the desired Aux input option. (Note: If you simply select **Next** and press **OK (Enter)** in this step, default values will be used.)

- To customize settings, select **Customize Inputs** and press **OK (Enter)**. Aux input options are displayed in a pop-up window. Use the arrow keys to select the input(s) you want to enable or disable. When you are finished, press **MENU** to close the pop-up window. Then, continue with step 4.
- To use default values, select **Use default values** and press **OK (Enter)**. Then, continue with step 4.

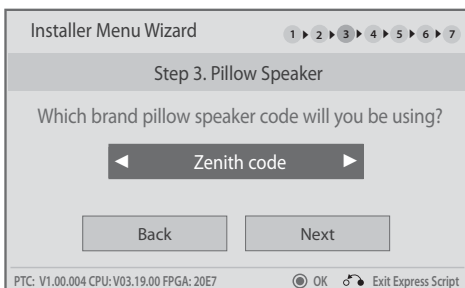

4. If using a Zenith pillow speaker code (default), you can simply select **Next** and press **OK (Enter)**.

Otherwise, select the pillow speaker code field, and use the Left/Right arrow keys to select the appropriate option. When you have made your selection, use the arrow keys to select **Next**, and then press **OK (Enter)**.

(Continued on next page)

Express Script Installer Menu Wizard (Cont.)

(LG3DDH TVs only)

(Continued from previous page)

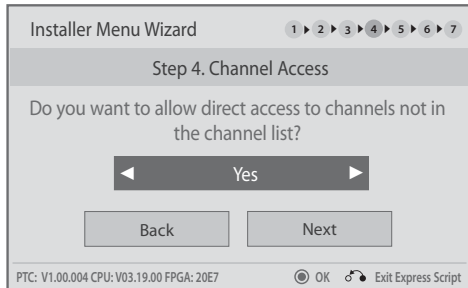

5. To allow channel access (default: Yes), you can simply select **Next** and press **OK (Enter)**.

To lock the channel lineup (after the Express Script is complete) and restrict access to the TV setup menus, select the channel access field, and use the Left/Right arrow keys to select "No." When you have made your selection, use the arrow keys to select **Next**, and then press **OK (Enter)**.

Note: It is recommended that you select the option to lock the channel lineup to prevent end users from accessing channel settings; i.e., the Channel Menu will be inaccessible/grayed out.

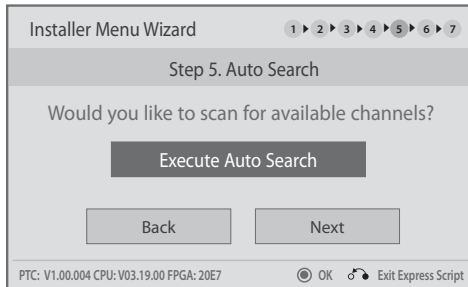

6. Select **Execute Auto Search** (Auto Tuning) and press **OK (Enter)** to start the channel scan (searches for all available analog and digital channels). The system will display progress of the channel scan in a pop-up window.

When the scan is complete, press any key on the Installer Remote to close the pop-up window. Use the arrow keys to select **Next**, and then press **OK (Enter)**.

Note: If you do not execute the Auto Search as described above, there will be no channels in the channel lineup (Channel Map).

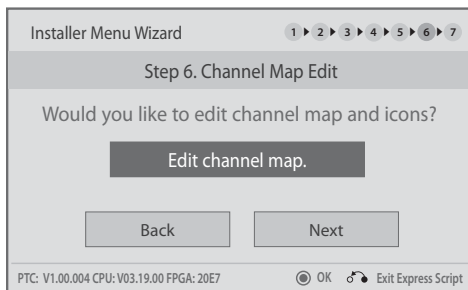

7. Press **OK (Enter)**, if desired, to edit the Channel Map. Channel edit and label and also channel bank setup options will be displayed in a pop-up window. Use the arrow keys to navigate between fields and make any necessary edits.

When you are finished, press **MENU** to close the pop-up window. Use the arrow keys to select **Next**, and then press **OK (Enter)**.

Note: See pages 26 to 29 for further information on channel banks. If the channel lineup will be locked at the completion of the Express Script (see step 5 above) and you wish to set up channel banks at a later time, you will need to set Installer Menu item 028 CH. OVERRIDE to 001 to enable access to the Channel Banks Setup Menu.

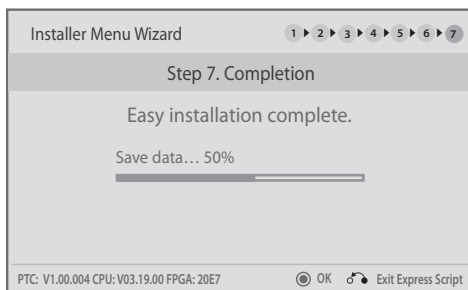

For the final step, the system will save your settings and transfer the setup to the internal TV controller (PTC) (similar to 2-5-5 + MENU Mode). When this step is complete, the system exits the Installer Menu Wizard.

Installer Menu

Use the Installer Menu to set up or change operational settings. See more detailed descriptions of the Installer Menu items on the pages that follow.

Accessing the Installer Menu

Make sure the TV is ON. Using an Installer Remote, press **MENU** repeatedly until the on-screen setup menus lock up, and then press **9-8-7-6 + OK (Enter)** to access the Installer Menu.

The Installer Menu opens with item 000 INSTALLER SEQ 000. Use the Up/Down arrow keys to sequence through the available menu items, or access an item directly by keying in the line number and then pressing **MENU**. For example, to access the SLEEP TIMER option, which is item 015, press 0-1-5 + MENU. To change a setting, use the Left/Right arrow keys, or enter a value directly. To save a setting, press **OK (Enter)**.

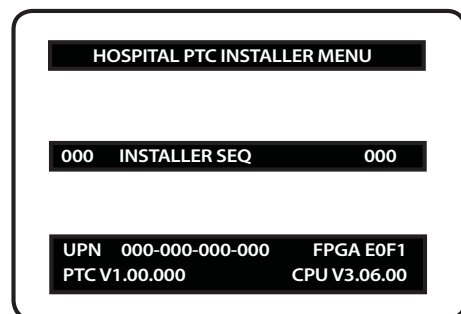

Typical TV Installer Menu

Using the Installer Menu

Items 000 ~ 117 are immediately accessible upon entering the Installer Menu. Refer to the table below for an overview of Installer Menu items, including item numbers, functions, ranges, and default values. Installer Menu items not relevant to these TV series are not present on the Installer Menu; therefore, some numbers are missing. For example, item 006 will not appear.

To exit the Installer Menu, press **OK (Enter)** again. Any changes you make will be stored in non-volatile memory.

Installer Menu Items 000 through 025

Menu Item	Function	Value Range	Default Value	Brief Description of Function and Comments
000	INSTALLER SEQ	0 ~ 3	0	Leave default set to 0.
001	POWER MANAGE	0 ~ 7	0	Sets number of hours of no activity before automatic shutoff.
002	AC ON	0 / 1	0	Set to 1 to enable Auto Turn On when AC power is applied.
003	BAND/AFC	0 ~ 3	1	Selects Tuning Band: 0=Broadcast, 1=CATV, 2=HRC, 3=IRC
004	STRT CHANNEL	0 ~ 127, 255	255	Channel tuned when TV is turned On. (Set to 255 to tune to channel tuned before TV turned Off.)
005	CHAN LOCK	0 / 1	0	If set to 1, cannot tune from current channel.
007	STRT VOLUME	0 ~ 63, 255	255	Volume level when TV is turned On. (Set to 255 to use volume level before TV turned Off.)
008	MIN VOLUME	0 ~ 63	0	Sets minimum allowable volume setting.
009	MAX VOLUME	0 ~ 63	63	Sets maximum allowable volume setting.
010	MUTE DISABLE	0 / 1	0	Set to 1 to disable Mute Function.
011	KEY DEFEAT	0 / 1	0	Set to 1 to disable menu navigation keys on display panel.
012	IR BANKS EN.	0 / 1	0	Set to 1 to enable TV to respond to IR code.
013	SCAN MODE	0 / 1	1	Typically used for hospitals: Enables On/Off in Channel Up/Down sequence.
014	STRT CH IN SM	0 / 1	0	Set to 1 to put TV On/Off below start channel number.
015	SLEEP TIMER	0 / 1	1	Set to 1 to enable Sleep Timer.
016	EN TIMER	0 / 1	0	Set to 1 to enable On/Off Timers.
017	ALARM	0 / 1	1	Set to 1 to enable Alarm.
020	FEATURE LEVEL	0 / 1	1	Zen 1. Leave default set to 1 (1 Zen 1).
021	V-CHIP	0 / 1	1	Set to 1 to enable V-Chip (Parental Control) functions.
022	MAX BLK HRS	0 ~ 99	12	Sets number of V-Chip blocking hours.
023	CAPTION LOCK	0 / 1	0	Set to 1 to retain caption setting before TV turned Off.
025	FUNCTION PRE.	0 ~ 1	1	Controls channel preview in PPV function.

Installer Menu Items 027 through 117

Menu Item	Function	Value Range	Default Value	Brief Description of Function and Comments
027	HOSPITAL MODE	0 ~ 2 (LG3DCH) 0~162,254 (LG3DDH)	2 (LG3DCH) 254 (LG3DDH)	For LG3DCH, set to 2 (default). For LG3DDH, set according to the pillow speaker power supply, audio source, and brand. See detailed instructions.
028	CH. OVERRIDE	0 / 1	1	If set to 0, limits direct access to favorite channels.
029	OLD OCV	0 / 1	0	Set to 1 to change MPI operation to OCV.
030	ACK MASK	0 / 1	0	If set to 1, changes MPI for some OCV boxes.
031	POLL RATE	20 ~ 169	94	Selects poll rate for MPI.
032	TIMING PULSE	186 ~ 227	207	Sets baud rate for MPI.
034	CAMPORT EN	0 / 1 *	1	Set to 1 to enable Video 2 input.
035	COMPPORT EN.	0 / 1	1	Set to 0 to disable HDMI 1. Set to 1 enable HDMI 1.
038	YPrPb EN.	0 / 1 *	1	Set to 1 to enable display panel Component Video 1 input jacks.
039	REAR AUX EN	0 / 1	1	Set to 1 to enable display panel Video 1 input jack.
040	AUTO CAMPORT	0 / 1 *	1	Set to 1 to automatically switch to Camport. If set to 1, STRT AUX SRCE cannot be set to 2.
046	STRT AUX SRCE	1 ~ 4, 6, 255 **	6	Sets the starting Aux source (if item 004 STRT CHANNEL is set to 0).
047	AUX STATUS	0 / 1	0	Set to 1 for MPI Aux source to be reported as a channel number instead of Channel 0.
053	DIS. CH-TIME	0 / 1	0	Set to 1 to disable Channel-Time display.
069	EN. CH-T COL.	0 / 1	1	Set to 1 to enable custom color for the Channel-Time display.
070	FOR. CH-TIME	0 ~ 7	2	Chooses custom foreground color for the Channel-Time display.
071	BCK. CH-TIME	0 ~ 7	2	Chooses custom background color for the Channel-Time display.
073	CH NOT AVBLE	0 / 1	0	If set to 1 and Channel Override is 0, "NOT AVAILABLE" message is displayed when directly accessing a channel not in the favorite Channel List.
075	REVERT CH	0 / 1	0	If set to 1 and loss of MPI communication occurs, TV tunes to Start Channel.
077	QUICK SHUTOFF	0 ~ 17	0	Allows TV timed power Off press and hold setup with pillow speaker channel button.
078	UPN MSB	0 ~ 255	0	User programmable number, most significant byte.
079	UPN MSB-1	0 ~ 255	0	User programmable number, most significant byte - 1.
080	UPN MSB-2	0 ~ 255	0	User programmable number, most significant byte - 2.
081	UPN LSB	0 ~ 255	0	User programmable number, least significant byte.
082	CHKSM ERROR	0 / 1	1	Enforces rigid MPI checksum.
083	HANDSHK TIME	0 ~ 5	5	Relaxes MPI timing to be compatible with PC-based Windows-controlled systems.
084	PERMANENT BLK	0 / 1	0	Removes block hours setting for Parental Control and makes block permanent.
087	REAR RGB EN.	0/2/18 (LG3DCH)* 0/1/17 (LG3DDH)*	2 (LG3DCH) 1 (LG3DDH)	Set to 0 to disable RGB1. Set to 2 (LG3DCH) / 1 (LG3DDH) to enable for RGB PC. Set to 18 (LG3DCH) / 17 (LG3DDH) for Auto detect configure.
088	EN NOISE MUTE	0 / 1	1	If set to 1, audio is muted if no signal is present.
090	KEY LOCK	0 / 1	0	If set to 1, keyboard is locked out, IR is still functional.
094	SAP MENU EN	0 / 1	1	Set to 0 to disable feature on Function Menu. Set to 1 to enable feature on Function Menu.
096	DEF. ASP. RATIO	0 ~ 4	2	Sets default aspect ratio at power up. See detailed descriptions and item 106.
099	BACK LIGHTING	1 ~ 100, 101 ~ 200	200 (LG3DCH) 100 (LG3DDH)	Sets the level of the TV picture back lighting. Settings above 101 control dynamic back lighting and disable power savings mode.
102	ATSC BAND	0 ~ 4	4	Selects ATSC band.
103	ATSC TUNE MODE	0 / 1	1	Set to 1 (default) for Physical Channel scan. Set to 0 for Virtual Channel scan.
104	START MINOR CH	0 ~ 255	0	Selects Minor Start Channel. Set to 0 for NTSC.
106	ASP RATIO LOCK	0 / 1	0	To retain set aspect ratio on power cycle, set to 1. Set to 0 for default ratio on power cycle.
116	VIDEO MUTE EN	0 / 1	0	Set to 0 for Normal. Set to 1 for Blank.
117	FACT DEFAULT	0 / 1	0	Set to 0 for Normal. Set to 1 to load presets for all Installer Menu settings.

* Not applicable for 22LG3DCH/22LG3DDH. ** 1, 3, 255 for 22LG3DCH/22LG3DDH

Installer Menu (Cont.)

Detailed Descriptions of Installer Menu Items

000 - INSTALLER SEQUENCE

Specifies entry sequence to the Installer Menu.

0 = 9876	1 = 4321
2 = 1478	3 = 3698

001 - POWER MANAGE (Power Management)

Determines hours of no activity before automatic shutoff. The Power Management function is for saving energy. If set to 0, Power Manage is Off. Settings range from 0 ~ 7, with 1 ~ 7 representing the hours that the unit will remain ON, unless there has been activity from either the control panel or remote control.

002 - AC ON (AC Power Switchable)

If set to 1, this allows the TV to turn ON when AC power is applied. Pressing the ON button is not necessary. This is desirable if the TV is plugged into a cable box or a power outlet controlled by a wall switch. Use the Left/Right arrow keys to choose 0 or 1, where 0 is the default (OFF), and 1 is ON.

Note: If set to 1 (ON), the TV does not respond to On/Off commands from either the remote or the display control panel, and the SLEEP TIMER is also nonfunctional.

003 - BAND/AFC (Band/Automatic Frequency Control)

There are four possible settings for this option:

0 = Broadcast	1 = CATV (default)
2 = HRC	3 = IRC

If some channels were not found by Auto Tuning (Channel Search), select the appropriate Band setting here, and add the channels using the Channel Edit option in the Channel Menu.

004 - STRT CHANNEL (Start Channel)

If active, this function allows you to determine the initial channel number when the TV is turned ON. This feature is useful for an in-house information channel, since the TV would always select that channel when it is turned ON. Setting this to 255 causes the last channel viewed when the TV was turned OFF, to be the tuned to channel when the TV is turned ON again.

Note: For a digital Start Channel, always remember to set item 104 to the Minor Start Channel number.

255 = Last channel	1 ~ 125 = Major Ch. #	0 = Aux
126 = Map to Channel 3	127 = Map to Channel 4	

005 - CHAN LOCK (Channel Lock)

Channel Lock is ideal if the system must always be on the same channel. Changing channels with the Channel Up/Down or keypad numbers is impossible. Channel Lock is inactive if set to 0 (default).

Generally, this feature is used in connection with STRT CHANNEL (Installer Menu item 004) where the Start Channel may, for example, be set to 3 or 4. If the Start Channel is 3, then the TV will remain locked on channel 3.

NOTE: For items 007, 008, and 009

For legacy reasons, the scale used is 0 - 63. The PTC software will translate this to the 0 - 100 scale used by the TV.

To translate a TV volume level to the Installer Menu value, use the following formula:

$$\text{Installer Value} = \frac{\text{TV Value} \times 63}{100}$$

Enter only the whole number (disregard fractions).

007 - STRT VOLUME (Start Volume)

This function allows the Installer to determine the initial volume level setting when the TV is turned ON. This feature is useful for an in-house information channel, since the TV would always select that volume level when it is turned ON. The range of values are 0 - 63, 255. If 255 is selected, the current volume level will be retained in memory when the TV is turned OFF; at turn ON, the volume level will be automatically set at the previous or last level.

008 - MIN VOLUME (Minimum Volume)

This function determines the minimum volume level allowable with the Volume (VOL) Up/Down control. In this way, for example, someone cannot set the volume too low to hear. The value range is from 0 to 6. Use the Left/Right arrow keys to change values. The factory default is 0, which provides the full range of volume control, if item 009 MAX VOLUME is also set to 63. It may be best to set the same value on every TV.

Note: The minimum volume level cannot have a value setting higher than the maximum volume level (described below).

009 - MAX VOLUME (Maximum Volume)

This function determines the maximum volume level allowable with the Volume (VOL) Up/Down controls. In this way, for example, someone cannot set the volume level high enough to disturb others. The value range is 0 to 63, with 63 as the default, which gives the user the full range of volume control, if item 008 MIN VOLUME is also set at 0. Use the Left/Right arrow keys to change values. It may be best to set the same value on every TV.

Note: The maximum volume level cannot have a value setting lower than the minimum volume level (described above).

010 - MUTE DISABLE

Enables or disables sound mute function. If set to 1, sound cannot be muted. If set to 0, sound can be muted.

011 - KEY DEFEAT (Keyboard Defeat)

If set to 1, KEY DEFEAT prevents the end user from accessing the on-screen menus with the display front panel—MENU, OK/ENTER, and menu navigation keys do not function. If set to 0, those keys do function.

Note: Users can always access the menus by pressing MENU on the remote.

012 - IR BANKS EN (IR Banks Enable)

For direct access to a particular channel bank. When enabled, you can access a channel bank by inputting the IR code for the bank.

013 - SCAN MODE (Functional after 2-5-5 + MENU setup transfer)

Allows variation in turning the TV On/Off with Channel Up/Down. You may opt for TV channels only or TV channels + Off/On. If set to 0, Channel Up/Down keys change channels only. If set to 1, channel DOWN below the lowest channel or Channel UP above the highest channel to turn the TV Off.

014 - STRT CH IN SM (Start Channel in Scan Mode)

If set to 1, installs TV On/Off event below the start channel at TV turn On. If set to 1, the user can select channels with either Channel Up/Down or by direct keypad entry. If set to 0, only those channels that are entered for scanning can be selected.

015 - SLEEP TIMER

If set to 1, the Sleep Timer feature may be used. If set to 0, the Sleep Timer is not available.

016 - EN TIMER (Enable On/Off Timers) *

If set to 1, the Timer function is available to the end user and enabled continuously. Set to 0 to disable On/Off Timers.

Note: Clock must be set in order to use timers.

017 - ALARM *

Gives the installer the option of making the Alarm function available to the end user. If set to 1, the Alarm function is available to the end user. Set to 0 to disable the Alarm function.

Note: Clock must be set before the Alarm function will work.

020 - FEATURE LEVEL

Leave item 20 FEATURE LEVEL set to 1 (default). Default set to ZEN 1 for Zenith IR codes remote control operation. Set O, P LBL for Zenith Private Label IR remote control operation.

Warning: Do not set to "0" or remote will not control TV.

021 - V-CHIP (Parental Control) *

Set to 1 to activate V-Chip (Parental Control) and have it available to the end user to filter and control or otherwise restrict programming content that can appear. Set to 0 to turn the V-Chip feature Off (not available to user); no programming restrictions can be set.

022 - MAX BLK HRS (Maximum Block Hours) *

Sets hours from 0 to 99 for the maximum V-Chip (Parental Control) block hours. Default setting is for 12 blocking hours.

023 - CAPTION LOCK

If set to 0, captions are OFF when the TV is turned ON. Set to 1 to use the caption setting configured before the TV was turned Off when the TV is turned ON.

* Only affects Function Menu if enabled by some PPV providers.

025 - FUNCTION PRE (Function Preview)

Set to 0 to suppress CHANNEL PREVIEW from the Function Menu with some Pay-Per-View systems.

027 - HOSPITAL MODE

With this setting two things are affected: Channel Banks 1, 2, and 3 are accessible, while Channel Bank 4 can be made inactive by removing all the channels from Channel Bank 4. Then, if Channel Bank 4 is selected when the TV is turned On, the TV screen will show "Inactive TV." The Channel Bank 4 setup allows the hospital to present TV viewing options to the patient. The patient can select programming options available in Channel Banks 1, 2, or 3. Channel Banks are available in all Hospital Modes (1, 2, etc.).

The IR code that will control the TV depends on the Installer Menu item 020 FEATURE LEVEL setting.

For LG3DCH TVs

It is recommended that you leave this item set to 2 (default), which favors most hospitals.

Hosp. Mode = 0 Hospital Mode disabled.

Hosp. Mode = 1 Zenith Private Label IR Code (Bed 1)

Hosp. Mode = 2 Zenith Consumer IR Code (Bed 2)

For LG3DDH TVs

Set according to the pillow speaker supply voltage and audio source (see table below). Note the following regarding pillow speaker voltage: +12 v identifies a Zenith pillow speaker, +5 v identifies a Phillips pillow speaker, and -5 v identifies an RCA pillow speaker.

Note: The default setting (254) is not selectable in the Installer Menu. If you ever need to restore the default setting, you must set item 117 FACT DEFAULT to 1 to reload the factory default settings. See item 117 description for further information.

Item 27 Value	Hospital Mode	Pillow Speaker Voltage	Audio Source (Switch = Pillow)
000	Disabled	+12 v	Pillow Only
001	Enabled, Zenith Private Label	+12 v	Pillow Only
002	Enabled, Zenith Consumer	+12 v	Pillow Only
017	Enabled, Zenith Private Label	+5 v	Pillow Only
018	Enabled, Zenith Consumer	+5 v	Pillow Only
033	Enabled, Zenith Private Label	-5 v	Pillow Only
034	Enabled, Zenith Consumer	-5 v	Pillow Only
065	Enabled, Zenith Private Label	+12 v	Main Only
066	Enabled, Zenith Consumer	+12 v	Main Only
081	Enabled, Zenith Private Label	+5 v	Main Only
082	Enabled, Zenith Consumer	+5 v	Main Only
097	Enabled, Zenith Private Label	-5 v	Main Only
098	Enabled, Zenith Consumer	-5 v	Main Only
129	Enabled, Zenith Private Label	+12 v	Pillow & Main
130	Enabled, Zenith Consumer	+12 v	Pillow & Main
145	Enabled, Zenith Private Label	+5 v	Pillow & Main
146	Enabled, Zenith Consumer	+5 v	Pillow & Main
161	Enabled, Zenith Private Label	-5 v	Pillow & Main
162	Enabled, Zenith Consumer	-5 v	Pillow & Main
254	Enabled, Zenith Consumer	0 v	Main Only

Installer Menu (Cont.)

028 - CH. OVERRIDE (Channel Override)

If set to 1, the user can select channels with either Channel Up/Down or by direct keypad entry. If set to 0, only those channels that are active in the TV's memory can be selected.

029 - OLD OCV (On Command Video™)

Set to 1 for operation with systems from On Command Corporation.

030 - ACK MASK

MPI Communication Parameter. Leave at default setting unless changed by Pay-Per-View provider. When set to 1, changes MPI for some OCV boxes.

031 - POLL RATE

MPI Communication Parameter. Selects Poll Rate for MPI. Leave at default setting unless changed by Pay-Per-View provider. Step size of 16 ms.

032 - TIMING PULSE

MPI Communication Parameter. Leave at default setting unless changed by Pay-Per-View provider. Sets baud rate. Step size of 4.3 uS.

034 - CAMPORT EN. (Camera Port Enable)

Set to 1 to enable Video 2 input on display panel. If set to 0, Video 2 input on display panel is not functional.

Note: (26/32LG3DCH only) S-Video overrides Video.

035 - COMPPORT EN. (Computer Port Enable)

Enable/disable TV display panel HDMI 1 input jack. Set to 0 to disable HDMI1. Set to 1 to enable HDMI1.

038 - YPrPb EN. (Rear Component Video Enable)

Set to 1 to enable display panel rear Component Video input jacks. Set to 0 to disable display panel rear Component Video input jacks.

039 - REAR AUX EN. (Rear Aux Enable)

Set to 1 to enable display panel rear Aux (Video 1) input. Set to 0 to disable display panel rear Aux (Video 1) input.

Note: (26/32LG3DCH only) S-Video overrides Video.

040 - AUTO CAMPORT

Set to 1 to automatically switch to Camport when equipment is connected to front Video input. Set to 0 to disable front Video automatic source selection.

Note: If set to 1, STRT AUX SRCE cannot be set at 2.

046 - STRT AUX SRCE (Start Aux Source)

Sets the starting AUX source. When turned On, the TV will tune to starting Aux source if item 004 STRT CHANNEL is set to 0.

1 = Video 1 4 = RGB 255 = Last Aux
2 = Video 2 6 = Component
3 = HDMI 1

If item 040 AUTO CAMPORT is set to 1:

1 = Video 1 4 = RGB
3 = HDMI 1 6 = Component

Note: Above is applicable only if all Aux sources are enabled.

047 - AUX STATUS

Set to 1 for MPI Aux source to be reported as a channel number instead of channel 0. Set to 0 to disable Aux identification change. Controls MPI status channel response for Aux inputs.

053 - DIS. CH-TIME (Disable Channel-Time)

Set to 1 to disable the Channel-Time display; Channel-Time display will not appear. Set to 0 to enable the Channel-Time display.

069 - EN. CH-T COL. (Enable Channel-Time Custom Color)

Set to 1 to enable custom color for the Channel-Time display. Set to 0 to disable custom color for the Channel-Time display.

070 - FOR. CH-TIME (Channel-Time Display Foreground Color)

Set according to Color Chart:

0 = Black 3 = Cyan 6 = Yellow
1 = Blue 4 = Red 7 = White
2 = Green 5 = Violet

Notes: Applies only to "Channel Not Available" message if item 073 is set to 1, enabled. If foreground color and background color are the same, the menu background will be transparent.

071 - BCK. CH-TIME (Channel-Time Display Background Color)

Set according to Color Chart:

0 = Black 3 = Cyan 6 = Yellow
1 = Blue 4 = Red 7 = White
2 = Green 5 = Violet

Notes: Applies only to "Channel Not Available" message if item 073 is set to 1, enabled. If foreground color and background color are the same, the menu background will be transparent.

073 - CH NOT AVBLE (Channel Not Available)

If set to 1 and item 028 CH. OVERRIDE is set to 0, a "NOT AVAILABLE" message is displayed when directly accessing a channel not in the channel scan list available in memory.

075 - REVERT CH (Revert to Start Channel)

If set to 1 and loss of MPI communication occurs, TV automatically tunes to the specified Start Channel.

077 - QUICK SHUTOFF

Allows TV power Off event to be controlled by the remote control, TV front panel and Pillow Speaker Channel Up/Down buttons. End user would push and hold channel button down for time required to have TV turn Off. Setting 0 = disabled. Value Range 0 - 17, each number represents 1/2 second. For example, if set to 4, TV would turn Off if end user held any channel button down for two seconds.

078 - UPN MSB (UPN Most Significant Byte)

User programmable number, most significant byte readable by MPI command. Not linked to serial number.

079 - UPN MSB-1 (UPN Most Significant Byte-1)

User programmable number, most significant byte-1 readable by MPI command. Not linked to serial number.

080 - UPN MSB-2 (UPN Most Significant Byte-2)

User programmable number, most significant byte-2 readable by MPI command. Not linked to serial number.

081 - UPN LSB (UPN Least Significant Byte)

User programmable number, least significant byte readable by MPI command. Not linked to serial number.

082 - CHKSM ERROR (Checksum Error)

Enforces rigid MPI checksum validation. Set to 1 for validation. Set to 0 to disable (does not check checksum on MPI async port). SPI is always checked.

083 - HANDSHK TIME (Handshake Time)

Adds an additional delay to the handshake time which is 64 msec, thus relaxing MPI timing requirements to be compatible with PC-based Windows controlled systems. Range is 0 - 5. (Timeout = 25.5MS + [25.5 MS* Handshake time].)

084 - PERMANENT BLK (Permanent Block)

Allows Lock (Parental Control) blocking schemes to be permanent by disabling the blocking hours function. Set to 1 to install Parental Control restrictions permanently. Set to 0 for user-specified hours control of blocking schemes.

087 - REAR RGB EN. (Rear RGB Enable)

Controls access to rear RGB input on TV. Set to 0 to disable RGB input. Set to 2 (LG3DCH) / 1 (LG3DDH) to enable for RGB PC input. Set to 18 (LG3DCH) / 17 (LG3DDH) to initiate a one-time automatic configuration after an AC power cycle; otherwise, automatic adjustment will be performed each time the RGB input is accessed.

088 - EN NOISE MUTE (Enable Noise Mute)

If set to 1, audio mutes if no signal is present.

090 - KEY LOCK

If set to 1, front keyboard Channel, Volume, and Captions buttons are disabled, Power button remains enabled. If set to 0, the Channel, Volume, Captions, and Power buttons are all enabled.

094 - SAP MENU EN (2nd Audio Program)

Set to 1 to enable SAP feature on Function menu, if Function Menu is available. Set to 0 to disable SAP feature on Function Menu, if Function Menu is available.

096 - DEF. ASP. RATIO (Default Aspect Ratio)

Selects default aspect ratio at power up.

- Set to 0 for Set By System.
- Set to 1 for 4:3.
- Set to 2 for 16:9 (Factory Default).
- Set to 3 for Just Scan. (LG3DDH only)
- Set to 4 for Zoom. (Zoom 1 for LG3DCH)
- Set to 5 for Zoom 2. (LG3DCH only)

Note: Only applies if item 106 ASP RATIO LOCK is disabled, set to 0.

099 - BACK LIGHTING

Sets the TV screen brightness at power up.

LG3DCH: Default setting is 100. LG3DDH: Default setting is 200.

- 1 - 100 Static Back Lighting
(1 = Dimmest picture, 100 = Brightest picture)
- 101 - 200 Dynamic Back Lighting
(101 = Dimmest picture, 200 = Brightest picture)

If settings are above 200, the TV automatically controls back lighting depending upon the picture level of the current program.

102 - ATSC BAND

Sets up TV to receive different types of incoming signals:

0 = Broadcast, 1 = CATV, 2 = HRC, 3 = IRC, 4 = Same as NTSC.

103 - ATSC TUNE MODE

Sets ATSC tuning mode: Default set to 1 for Physical Channel scan. Set to 0 for Virtual Channel scan.

104 - START MINOR CHANNEL

Sets Minor Start Channel number at power up. 0 = NTSC. If not 0, number selected is the digital channel's Minor Start Channel number.

106 - ASP RATIO LOCK (Aspect Ratio Lock)

Set to 1 to retain previous aspect ratio with power off. Set to 0 to retain default aspect ratio with power off. See item 096 DEF. ASP. RATIO above.

116 - VIDEO MUTE EN (Video Mute Enable)

Set to 0 for Normal. Set to 1 for Blank.

117 - FACT DEFAULT (Factory Default)

Set to 0 for normal. Set to 1 to load presets of all Installer Menu item settings. Setting this item to 1 will also reinitiate the Express Script Installer Menu Wizard (see pages 16–17).



Warning: If set to 1, this will reload the factory defaults and clear the Channel List, including any assigned channel icons and custom channel labels.

TV Setup Menus Overview

On-screen setup menus control the features of the TV. Press **MENU** on the Installer Remote to access the TV setup menus, and set the TV features to the desired configuration for the end user.

Note that your TV's OSD (On-screen Display) may differ from that shown in this manual.

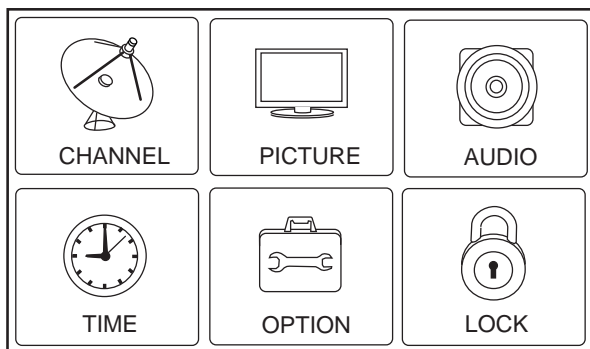

Audio Menu Notes:

- 22/26/32LG3DCH: Auto Volume is disabled if the Pillow Speaker switch is set to "Pillow Speaker" and "TV Speaker" is not selected as an audio source.
- 22/26/32LG3DDH: Audio Menu is disabled if the Pillow Speaker switch is set to "Pillow Speaker" and "TV Speaker" is not selected as an audio source.

Lock Menu Notes:

- 22/26/32LG3DCH: Enter 7-7-7 to access the Lock Menu if the Lock System is active and the password is not available.
- 22/26/32LG3DDH: Enter 0-3-2-5 to access the Lock Menu if the Lock System is active and the password is not available.

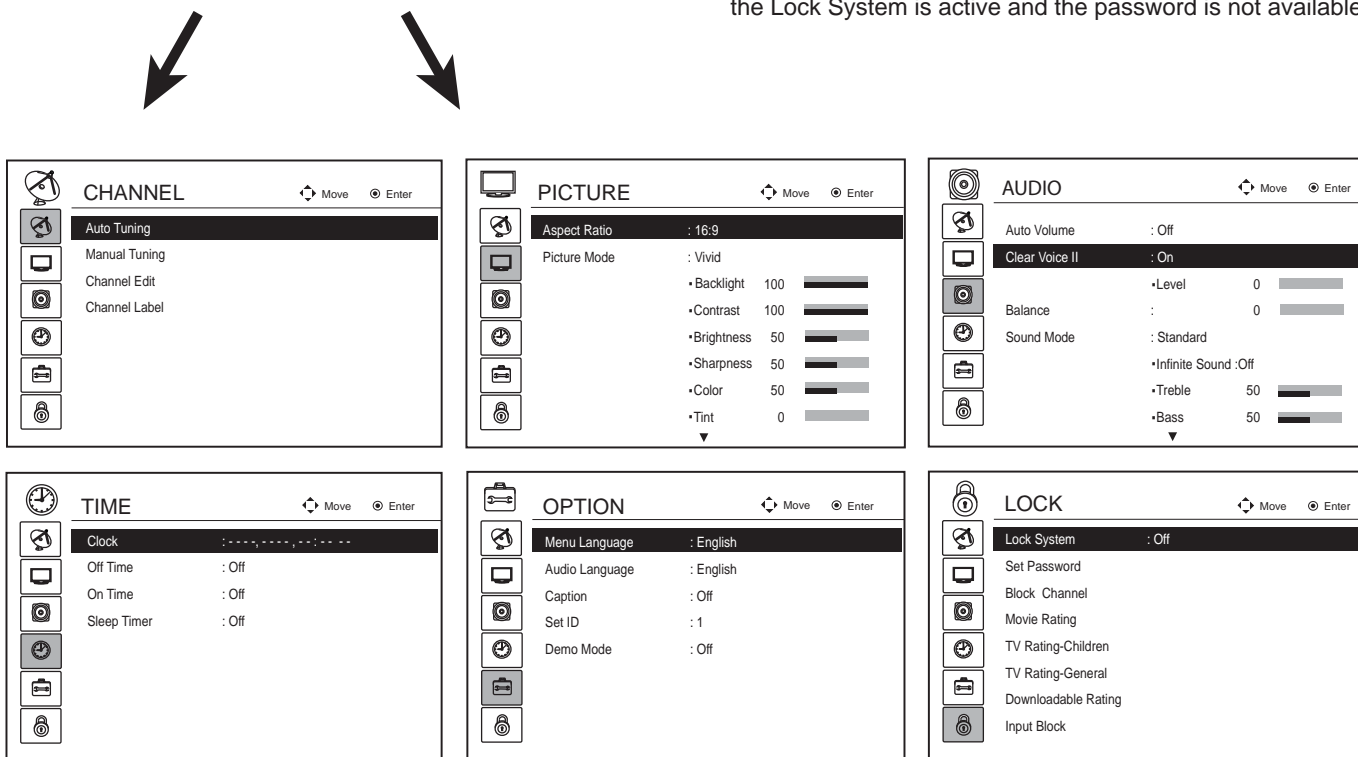

Refer to the Owner's Manual for further information on the TV setup menus.

Adding Channel Label Icons / Custom Channel Labels (2-5-4 + MENU Mode)

Editing/Adding Channel Icons and/or Labels

If there is no pre-assigned icon, you can make a custom channel label of up to seven (7) characters to help identify a channel or network. If desired, channel labels can also be added in addition to a pre-assigned icon. You may also add labels for the Aux input sources to clearly identify the devices that are connected to the Aux inputs.

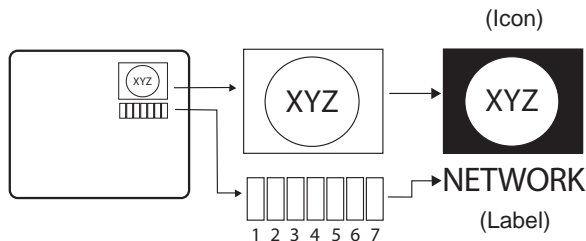

Editing and adding the labels can only be done if there are channels entered into the TV's Channel Map either during Commercial Mode Setup (see pages 14 to 15), by cloning, or by using some PPV providers' master remote controls. **Note:** A blank letter space is available between "Z" and "I".

To perform channel editing/labeling:

1. Enter the TV Installer Menu.
2. Press **2-5-4 + MENU** on the Installer Remote to enter the Channel Label Editing Mode.
3. Add channel icons and channel labels as described in the procedures below. (You can do this more than once.)
4. To exit the menu when you are done, press **MENU**.

Changing a Channel's Icon on the Master TV

1. Use Channel Up/Down to select the desired channel.
2. Use the Left/Right arrow keys to select the thin letter "I" on the Channel ID display.
3. Use the Up/Down arrow keys to select the icon with which you want to identify the channel. (If you know the icon number, enter the number, and press **OK (Enter)**.)
4. Proceed to change/add channel labels, or go to the next channel.

Changing/Adding Channel Labels on the Master TV

1. Use Channel Up/Down to select the desired channel.
2. Press the Left or Right arrow repeatedly until the numbers 1 to 7 appear on the display. The number shows the position of the character that can be changed. Number 1 is the first character, number 2 the second character, etc.
3. Use the Up/Down arrow keys to select the desired character.
4. Proceed to the next number position, or use Channel Up/Down to go to the next channel.

Changing Source Labels on the Master TV

1. Press **INPUT** to select the desired Aux input source: A/V 1, A/V 2, HDMI Component, RGB, etc.
2. Press the Left or Right arrow repeatedly until the numbers 0 to 9 appear on the display. The number shows the position of the character that can be changed.
3. Use the Up/Down arrow keys to select the desired character.
4. Press **INPUT** for the next Aux source, or use Channel Up/Down to return to channels.

Installer Remote Control Key Functions for Master TV Channel Editing/Labeling Menu

- **Channel Up/Down:** Tunes to the next channel in scan.
- **Left/Right Arrows:** Select the item to change. If "I" is shown, the icon can be changed. If a number is shown, it indicates the position of the character that can be changed.
- **Up/Down Arrows:** Select the icon or the character to be displayed. Tip: Arrows can be held down for fast scrolling.
- **0 – 9:** Use to enter the index number of the icon, if known.
- **OK (Enter):** Changes the icon after the number has been entered.
- **INPUT:** Changes the Aux input label.
- **MENU:** Exits the editing process.

Channel Banks Overview

Channel Banks Note: Disable all Aux sources in the Installer Menu that will not be made available to the end user.

Channel banks enable institution administrators to control access to patient in-room TV programming. A channel bank can be enabled for a patient for a pre-determined fee. For Channel Banks 1, 2, and 3, the institution can create programming levels. Each level offers a custom channel lineup. The top tier generally contains the most programming (premium, etc.), 2nd tier = lesser programming, 3rd tier = basic programming, etc. If an Inactive TV display (described on the following page) has been created on Channel Bank 4, an “Inactive TV Call Attendant” message appears when the TV is turned On. An administrator can then activate Channel Bank 1, 2, or 3 depending on the programming tier selected by the patient. When the patient leaves the hospital, the administrator can then select Channel Bank 4 to reinstate the “Inactive TV” message.

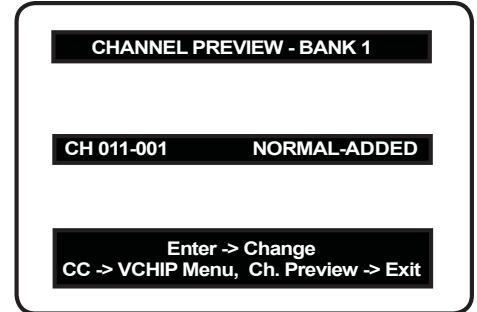

Channel Banks Setup Menu

Channels Available Charts

All channels found in the channel search are included in each of the channel banks. The default is for all channels to be active in Channel Banks 1, 2, 3, and 4. Create channel banks charts similar to the examples on the following pages. On the channel bank charts, show the status for each channel in all channel banks. This then becomes the patient entertainment programming offerings plan.

Setting Up Channel Banks

The LG Installer Remote is required to access the Channel Banks Setup Menu (see example above at right) and administer channel banks. Refer to “Channel Banks Setup” on the following pages for detailed information on using the Installer Remote to setup and administer channel banks.

Before you begin to set up channel banks, note the following:

- Complete either the Commercial Mode Setup procedure or run the Express Script Installer Menu Wizard (see pages 14 to 15 or pages 16 to 17, respectively). Channel banks can only be set up after the TV setup has been transferred to the internal TV controller (PTC).
- Installer Menu item 028 CH. OVERRIDE must be set to 001 to allow access for channel banks setup.

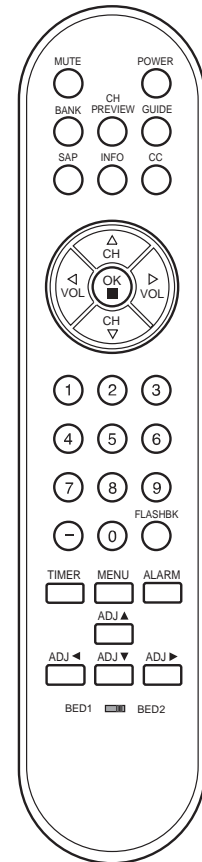

Use the Installer Remote to access the Channel Banks Setup Menu.

Note: The default setting for Aux sources is to be active in the Installer Menu. The Aux sources will appear between the highest analog and lowest digital channel number in the channel scan with Channel Up/Down. If the Aux sources will not be used, it is advisable to set them to 000 (Off) before running 2-5-5 + MENU (Commercial Mode Setup) or completing the Express Script Installer Menu Wizard. After running 2-5-5 + MENU/completing the Express Script, the only way to turn the Aux sources off so they will not appear in the channel scan, is to go to the Channel Banks Setup Menu and select NORMAL-DELETED. If performing the Commercial Mode Setup procedure, refer to Installer Menu items: 034, 035, 038, 039 and 087. If running the Express Script, customize the Aux inputs as appropriate in the Aux Input screen of the Installer Menu Wizard.

Select a channel bank using the **INPUT** or **BANK** button on your Installer Remote. After the desired bank is selected, press **CH PREVIEW** to display the Channel Banks Setup Menu.

Channel Status Options for Channel Banks

In the Channel Banks Setup Menu, use the Channel Up/Down arrows to go to a channel and the Left/Right arrows to select the channel status. See also sample channel status charts on the following page.

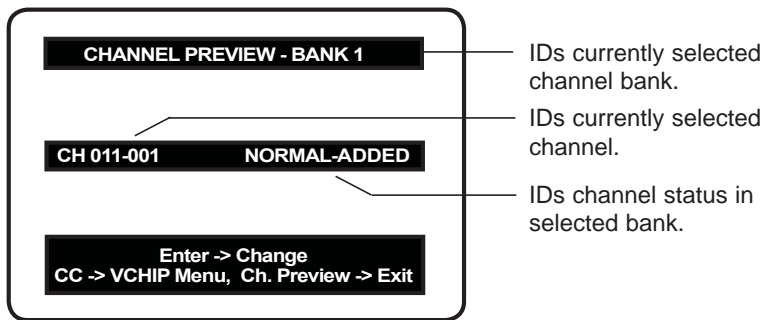

Channel Banks Setup Menu

Channel Status Options

- Normal-Added: Channel will appear in channel scan.
- Normal-Deleted: Channel will not appear in channel scan.
- Blank-Added: Channel will appear in all channel banks, video will be black, no picture.
- Blank-Deleted: Channel will be blanked in all channel banks.

Adding / Deleting / Blanking Channels

It is best to do ADD / DEL customizing before doing "BLANK." Auto Tuning (channel search) enters the same channel numbers in Channel Banks 1, 2, 3, and 4. Auto Tuning also removes any channels previously customized with ADD / DEL / BLANK. All channels found in the channel search will be included, and any channels previously found but not currently available will not be included. ADD and DEL (not BLANK) can be used independently for Channel Banks 1, 2, 3, and 4. (If a channel was not found in the channel search [and was not added during the Commercial Mode Setup/Express Script procedures], it can be added using the Manual Tuning option in the Channel Menu.)

Note: A channel blanked, is blanked in all channel banks.

Selecting Deleted Channels

To tune to a Normal-Deleted channel, either:

- Select a channel bank where the channel is added.
- Direct enter the channel number. Then, go to the bank where the channel is set as "Normal-Deleted," and reconfigure the channel status.

Note: Installer Menu item 028 CH. OVERRIDE must be set to 001 to allow access to the channel scan.

Channel allocations in tuning bands:

- Broadcast and Broadcast Digital: 2 - 69
- CABLE - CATV, HRC or ICC: 1 - 125

Inactive TV Setup

To create an inactive TV display on Channel Bank 4, select **Normal-Deleted** for each channel in Channel Bank 4. When the TV is powered On by the patient, the "Inactive TV Call Attendant" message will appear on the screen, and after a few moments the TV will turn itself Off. This will prompt the patient to arrange for an available programming package on Channel Bank 1, 2, or 3. Using the Installer Remote, the administrator can activate Channel Bank 1, 2, or 3 depending on the entertainment programming tier selected by the patient. When the patient leaves the hospital, the administrator can then select Channel Bank 4 to reinstate the "Inactive TV" message.

Channel Banks Setup (Cont.)

Use the channel banks to format the channel lineup programming package options for the end user.

Each channel bank is capable of storing broadcast digital and analog channels.

Example: Typical Channel Banks After Auto Tuning

BANK	Purpose	Channel Number																									
		1	2	3	4	5	6	7	8	9	10	11	12	13	14	15	16	17	18	19	20	21	22	23	24	25	
1				A			A		A		A					A	A	A	A	A	A	A		A	A	A	A
2				A			A		A		A					A	A	A	A	A	A	A		A	A	A	A
3				A			A		A		A					A	A	A	A	A	A	A		A	A	A	A
4				A			A		A		A					A	A	A	A	A	A	A		A	A	A	A

A = Active (channel was found during Auto Tuning)

Example: Typical Channel Banks After Auto Tuning and Customization with Add/Del/Blank Options

BANK	Purpose	Channel Number																									
		1	2	3	4	5	6	7	8	9	10	11	12	13	14	15	16	17	18	19	20	21	22	23	24	25	
1			BC	A			A		A		A					D	D	D	D	D	D	D		D	D	D	D
2			BC	A			A		A		A					A	D	A	D	A	A	A		D	D	D	D
3			BC	A			A		A		A					A	D	A	D	A	A	A		A	D	A	A
4			BC	A			A		A		A					A	A	A	A	A	A	A		A	A	A	A

A = Active (channel was found during Auto Tuning)

D = Delete (channel was deleted using the Add/Del channel option)

BC = Blanked Channel (channel was blanked using the Blank channel option)

Channel Banks Worksheet

Use this worksheet to plan your program packages. (Photocopy additional worksheets as needed.)

B A N K	Purpose	Channel Number																								
		1	2	3	4	5	6	7	8	9	10	11	12	13	14	15	16	17	18	19	20	21	22	23	24	25
1																										
2																										
3																										
4																										

B A N K	Purpose	Channel Number																													
		26	27	28	29	30	31	32	33	34	35	36	37	38	39	40	41	42	43	44	45	46	47	48	49	50					
1																															
2																															
3																															
4																															

B A N K	Purpose	Channel Number																													
		51	52	53	54	55	56	57	58	59	60	61	62	63	64	65	66	67	68	69	70	71	72	73	74	75					
1																															
2																															
3																															
4																															

B A N K	Purpose	Channel Number																													
		76	77	78	79	80	81	82	83	84	85	86	87	88	89	90	91	92	93	94	95	96	97	98	99	100					
1																															
2																															
3																															
4																															

B A N K	Purpose	Channel Number																													
		101	102	103	104	105	106	107	108	109	110	111	112	113	114	115	116	117	118	119	120	121	122	123	124	125					
1																															
2																															
3																															
4																															

Date _____ Installer _____ Page ____ of ____
 Location _____

Cloning Overview / Clonable Menu Features

IMPORTANT CLONING INFORMATION

There are three options for cloning a Master TV Setup:

- Using a USB memory device
- Using a TLL-1100A clone programmer
- Using a LT2002 clone programmer

Each option is described in further detail on the pages that follow. As you perform cloning procedures, be sure to complete each task as indicated. If a procedure or step is omitted or not performed completely, cloning may not work. At each step, pay attention to ensure the TV screen shows the proper message when cloning. If the message indicated does not appear, there is a problem with that step, and cloning may not be successful.



Warning: Copying a blank or incorrect memory into a TV will cause the TV to operate erratically or become inoperable.



Warning: Do not connect a clone programmer to a PPV card installed in the Master or Target TVs, as this will damage the clone programmer and the PPV card.

Before you begin cloning:

- Complete the Commercial Mode Setup procedure on pages 14 to 15.
- All equipment should be connected to power and turned ON.
- Learning and Teaching is only possible between identical model TVs.
- Both the Master and Target TVs must be in Pass-through Mode.
- If using a USB memory device, ensure the USB device has been formatted with FAT format.
- For both Master and Target TVs—If using a clone programmer, ensure the TV signal source is either an Aux or TV (RF) source. If a TV (RF) source, the TV must be tuned to an analog (not a digital) channel.
- LT2002 only—Make sure the batteries in the clone programmer are fresh. If batteries are removed, the clone programmer clock time (if set) will be lost (see page 35 for information on the clone programmer clock).
- Do not unplug the TV power cord or remove/disconnect the USB memory device/clone programmer while Learning or Teaching, as doing so may cause the TV to malfunction or harm the USB device/clone programmer, respectively.

Clonable Menu Features

Installer Menu

Installer Menu item settings

Channel

Auto Tuning (Channel Lineup)
Manual Tuning
Channel Edit
Channel Label

Picture

Aspect Ratio
Picture Mode

Audio

Auto Volume
Clear Voice
Sound Mode
Balance
TV Speaker

Option

Menu Language
Audio Language
Caption
Caption Mode
Digital Caption Options

Lock

Movie Rating
TV Rating – Children
TV Rating – General

Time

Auto Clock
Manual Clock
Off Time
On Time
Auto Off (Sleep Timer)

Notes:

- Some menu options vary between analog and digital channels and Aux sources.
- The end user only has access to features that are available on the pillow speaker or the user remote control if provided by the institution.

Learning / Teaching a Master TV Setup using a USB Memory Device

USB Cloning Notes

- Read the IMPORTANT CLONING INFORMATION on page 30 before beginning any cloning procedures.
- You may edit a filename as part of the Learning procedure; however, a file with edited contents will not be recognized.
- It is not possible to clone a Master TV's clock using a USB memory device. Either set a Target TV's clock manually or use the Auto Clock setting in the TV setup menus.

Learn Setup from Master TV

1. Ensure the Master TV is set up completely and in Pass-through Mode.
2. Plug the USB memory device into the USB IN port on the Master TV.
3. Press **MENU** to display the TV setup menus.
4. Use the arrow navigation keys to select/highlight the **Option** menu icon; then, press the number "7" key a total of seven times to display the USB Download Menu.
5. To gain access to the Learn From TV option in the USB Download Menu, key in the password used to enter the Installer Menu (Example: Press **9-8-7-6**).
6. Use the Up/Down arrow keys to select **Learn From TV**, and then press **OK (Enter)**.
7. To identify the profile from others, you can use the Up/Down arrow keys to change the last five digits of the filename. Press **OK (Enter)** when you are ready to initiate Learning.
Learning status will be shown on the progress bar. When the Learning process is complete, the USB Download menu will reappear on screen.
8. Remove the USB memory device from the Master TV.



Teach Master TV Setup to Target TV

1. Ensure the Target TV is in Pass-through Mode, and then plug the USB memory device with the Master TV Setup file into the Target TV USB IN port.
2. Press **MENU** to display the TV setup menus.
3. Use the arrow navigation keys to select/highlight the **Option** menu icon; then, press the number "7" key a total of seven times to display the USB Download Menu.
4. Use the Up/Down arrow keys to select **Teach To TV**, and then press **OK (Enter)**.
5. Use the Up/Down arrow keys to select/highlight the Master TV Setup you want to install and press **OK (Enter)**. Note: Filenames identify the TV and the TLL version (see figure at right).
Teaching status will be shown on the progress bar. When the Teaching process is complete, the USB Download menu will reappear on screen.
6. When Teaching is done, remove the USB memory device, turn OFF the TV, and unplug the TV power cord for 15 seconds.
7. Reconnect the TV power cord, and turn ON the TV. The Master TV Setup should be resident on the Target TV.

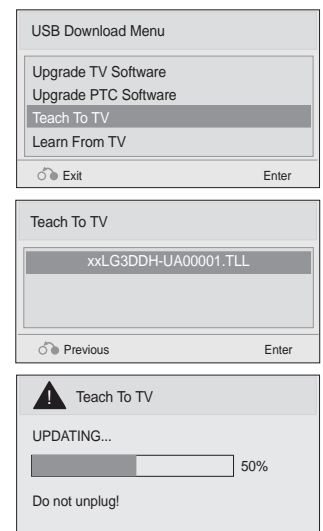

Cloning Procedures (Cont.)

Learning / Teaching a Master TV Setup using a TLL-1100A Clone Programmer

Warning: Do not connect a clone programmer to a PPV card installed in the Master or Target TVs, as this will damage the clone programmer and the PPV card.

Cloning is accomplished using the TV/clone programmer MPI ports for communication (see figure).

TLL-1100A Cloning Notes

- Read the IMPORTANT CLONING INFORMATION on page 30 before beginning any cloning procedures.
- Ensure the TLL-1100A is either fully charged or connected to AC power.
- Teaching and Learning is only possible between identical model TVs/STBs; however, the TLL-1100A clone programmer can store up to eight different Master TV Setups.

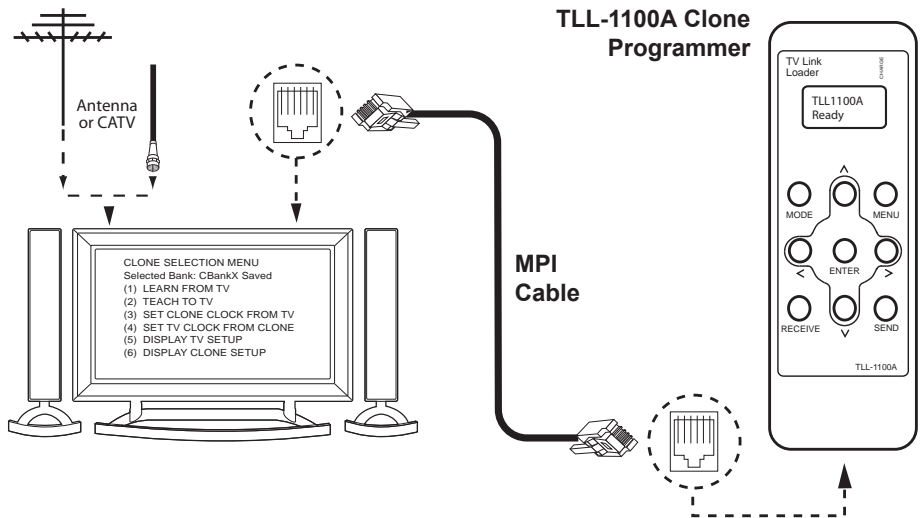

Learn Setup from Master TV

1. Ensure the Master TV is set up completely and in Pass-through Mode.
2. If an analog channel is not available, direct tune the TV to an Aux source, or select an Aux source, such as AV-1, from the Input Menu. Then, plug one end of the MPI cable into the TV MPI port.
3. Turn ON the TLL-1100A.
4. Use the **MODE** button on the TLL-1100A to select **Clone Mode**.
5. Use the Left/Right arrows on the TLL-1100A to select the Memory CBank (1 to 8) in which to store the Master TV Setup.
6. Plug the other end of the MPI cable into the MPI port on the bottom of the TLL-1100A. The Clone Selection Menu will display on the TV screen.
7. Press **1** on the Installer Remote to select **LEARN FROM TV** from the Clone Selection Menu. Then, press **OK (Enter)** to transfer the Master TV Setup into CBankX on the TLL-1100A.

Learning usually takes about 90 seconds. "LEARNING IN PROGRESS" will be displayed on the screen while the TLL-1100A copies the Master Setup. When the Learning process is complete, a "LEARNING COMPLETE" message will be displayed.

CLONE SELECTION MENU
Selected Bank: CBankX Saved
(1) LEARN FROM TV
(2) TEACH TO TV
(3) SET CLONE CLOCK FROM TV
(4) SET TV CLOCK FROM CLONE
(5) DISPLAY TV SETUP
(6) DISPLAY CLONE SETUP

CLONE CLOCK = XX:XX
TV CLOCK = XX:XX
THE CLONE IS VERSION VX.X.X
- To change menu items, press channel keys or digits.
- To execute item, press Enter.

Learning / Teaching a Master TV Setup using a TLL-1100A Clone Programmer (Cont.)

(Optional) Set the Clock

Set the time on a Master TV's clock. (If the time has already been copied from a TV into the TLL-1100A clone programmer, you can set the Master TV's clock by copying the time from the clone programmer.) The TLL-1100A can copy the current time to both a Master TV and to the clone's internal clock—accurate to within one minute.

Since the TLL-1100A's time cannot be set directly, the current time needs to be copied from an LG TV equipped with an enabled MPI port.

After the time is copied to the TLL-1100A clone programmer, the current time will be maintained and can then be transferred to another TV. (This can be a Master TV or another TV which has already had the features set up.)

CLONE SELECTION MENU
Selected Bank: CBankX Saved
(1) LEARN FROM TV
(2) TEACH TO TV
→ (3) SET CLONE CLOCK FROM TV
→ (4) SET TV CLOCK FROM CLONE
(5) DISPLAY TV SETUP
(6) DISPLAY CLONE SETUP

CLONE CLOCK = XX:XX
TV CLOCK = XX:XX
THE CLONE IS VERSION VX.X.X
- To change menu items, press channel keys or digits.
- To execute item, press Enter.

Teach Master TV Setup to Target TV

1. When Learning is complete, disconnect the MPI cable from the Master TV.
2. Ensure the Target TV is in Pass-through Mode and the TV is tuned/set to an analog channel or Aux source, and then connect the MPI cable to the MPI port on the Target TV. The Clone Selection Menu will display on the TV screen.
3. Ensure the correct Memory CBank(X) is selected on the TLL-1100A.
4. Press **2** on the Installer Remote to select **TEACH TO TV** from the Clone Selection Menu. Then, press **OK (Enter)** to transfer the Master TV Setup to the Target TV.

Teaching usually takes 3 to 4 minutes. "TEACHING IN PROGRESS" will be displayed on the screen during Teaching. When the Teaching process is complete, a "TEACHING COMPLETE" message will be displayed.

5. When Teaching is done, disconnect the MPI cable from the Target TV, turn OFF the TV, and unplug the TV power cord for 15 seconds.
6. Reconnect the TV power cord, and turn ON the TV. The Master TV Setup should be resident on the Target TV.

CLONE SELECTION MENU
Selected Bank: CBankX Saved
(1) LEARN FROM TV
(2) TEACH TO TV
(3) SET CLONE CLOCK FROM TV
(4) SET TV CLOCK FROM CLONE
(5) DISPLAY TV SETUP
(6) DISPLAY CLONE SETUP

CLONE CLOCK = XX:XX
TV CLOCK = XX:XX
THE CLONE IS VERSION VX.X.X
- To change menu items, press channel keys or digits.
- To execute item, press Enter.

Cloning Procedures (Cont.)

Learning / Teaching a Master TV Setup using an LT2002 Clone Programmer

Warning: Do not connect a clone programmer to a PPV card installed in the Master or Target TVs, as this will damage the clone programmer and the PPV card.

Cloning is accomplished using the TV/clone programmer MPI ports for communication (see figure).

LT2002 Cloning Notes

- Read the IMPORTANT CLONING INFORMATION on page 30 before beginning any cloning procedures.
- A slow flashing green light indicates that there are communication problems between the TV and the LT2002 clone programmer. If this is the case, check for a damaged cable, poor contacts, or other connection troubles.
- If the status indicator is red, the LT2002 batteries are low and should be replaced. Install four (4) high-quality alkaline AA batteries.
- Teaching and Learning is only possible between identical model TVs/STBs; however, the LT2002 clone programmer can store up to three different Master TV Setups.

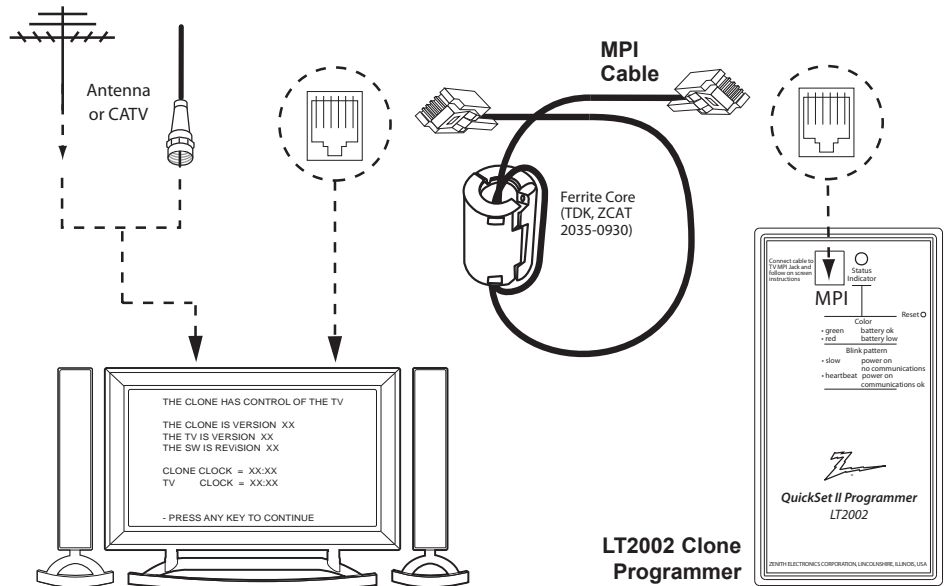

Learn Setup from Master TV

1. Ensure the Master TV is set up completely and in Pass-through Mode.
2. If an analog channel is not available, direct tune the TV to an Aux source, or select an Aux source, such as AV-1, from the Input Menu. Then, plug one end of the MPI cable into the TV MPI port.
3. If there is a good connection after the LT2002 is connected to the TV MPI port, "THE CLONE HAS CONTROL OF THE TV" message will appear on the TV screen. Press any key on the Installer Remote to access the LT2002 Clone Selection Menu.
4. Press **1** on the Installer Remote to select **LEARN FROM TV** from the Clone Selection Menu; then press **OK (Enter)** to proceed to the Memory Bank Selection Menu (see sample screen on next page).
5. Select the clone Memory Bank in which to store the Master Setup by pressing either Channel key repeatedly to choose Memory Bank 1, 2, or 3. Note: If you choose a Memory Bank that already has a Master device's setup programmed into it, that setup will be overwritten by the new Master TV Setup.

THE CLONE HAS CONTROL OF THE TV

```

THE CLONE IS VERSION XX
THE TV IS VERSION XX
THE SW IS REVISION XX

CLONE CLOCK = XX:XX
TV    CLOCK = XX:XX

- PRESS ANY KEY TO CONTINUE.
- DISCONNECT CLONE WHEN DONE.
    
```

CLONE SELECTION MENU

- (1) LEARN FROM TV
- (2) TEACH TO TV
- (3) SET CLONE CLOCK FROM TV
- (4) SET TV CLOCK FROM CLONE
- (5) DISPLAY TV SETUP
- (6) DISPLAY CLONE SETUP

- TO CHANGE MENU ITEMS, PRESS CHANNEL KEYS OR DIGITS.

- TO EXECUTE ITEM, PRESS ON/OFF, POWER, OR ENTER.

(Continued on next page)

Learning / Teaching a Master TV Setup using an LT2002 Clone Programmer (Cont.)

(Continued from previous page)

6. Once you select the clone Memory Bank, press **ENTER** on the Installer Remote. The Memory Bank you selected will be shown.
7. Press **POWER** to transfer the Master TV Setup into the selected Memory Bank on the LT2002.

Learning usually takes about 90 seconds. "LEARNING IN PROGRESS" will be displayed on the screen while the LT2002 copies the Master Setup. When the Learning process is complete, a "LEARNING COMPLETE" message will be displayed.

SAVE TV SETUP IN SELECTED CLONE MEMORY

- (1) MEMORY 1 VER XX REV XX
- (2) MEMORY 2 VER XX REV XX
- (3) MEMORY 3 VER XX REV XX
- (4) RETURN TO CLONE MENU

- TO CHANGE MENU ITEMS, PRESS CHANNEL KEYS OR DIGITS.
- TO EXECUTE ITEM, PRESS ON/OFF, POWER, OR ENTER.

(Optional) Set the Clock

Set the time on a Master TV's clock. (If the time has already been copied from a TV into the LT2002 clone programmer, you can set the Master TV's clock by copying the time from the clone programmer.) The LT2002 can copy the current time to both a Master TV and to the clone's internal clock—accurate to within one minute. (Another reason that the LT2002 should be equipped with fresh, high-quality alkaline batteries, is for it to keep the time as accurately as possible.)

Since the LT2002's time cannot be set directly, the current time needs to be copied from an LG TV equipped with an enabled MPI port.

After the time is copied to the LT2002 clone programmer, the current time will be maintained and can then be transferred to another TV. (This can be a Master TV or another TV which has already had the features set up.)

CLONE SELECTION MENU

- (1) LEARN FROM TV
- (2) TEACH TO TV
- (3) SET CLONE CLOCK FROM TV
- (4) SET TV CLOCK FROM CLONE
- (5) DISPLAY TV SETUP
- (6) DISPLAY CLONE SETUP

- TO CHANGE MENU ITEMS, PRESS CHANNEL KEYS OR DIGITS.
- TO EXECUTE ITEM, PRESS ON/OFF, POWER, OR ENTER.

Teach Master TV Setup to Target TV

1. When Learning is complete, disconnect the MPI cable from the Master TV.
2. Ensure the Target TV is in Pass-through Mode and the TV is tuned/set to an analog channel or Aux source, and then connect the MPI cable to the MPI port on the Target TV.
3. With "THE CLONE HAS CONTROL OF TV" message on display, press **2** on the Installer Remote to select **TEACH TO TV** from the LT2002 Clone Selection Menu. Then, press **OK (Enter)**.

4. Select the LT2002 Memory Bank in which the new setup is located. Then, press **POWER** to transfer the Master TV Setup to the Target TV.

Teaching usually takes 3 to 4 minutes. "TEACHING IN PROGRESS" will be displayed on the screen during Teaching. When the Teaching process is complete, a "TEACHING COMPLETE" message will be displayed.

5. When Teaching is done, press any key on the Installer Remote to return to the Clone Selection Menu. Then, press **OK (Enter)**.
6. Disconnect the MPI cable from the Target TV, turn OFF the TV, and unplug the TV power cord for 15 seconds.
7. Reconnect the TV power cord, and turn ON the TV. The Master TV Setup should be resident on the Target TV.

CLONE SELECTION MENU

- (1) LEARN FROM TV
- (2) TEACH TO TV
- (3) SET CLONE CLOCK FROM TV
- (4) SET TV CLOCK FROM CLONE
- (5) DISPLAY TV SETUP
- (6) DISPLAY CLONE SETUP

- TO CHANGE MENU ITEMS, PRESS CHANNEL KEYS OR DIGITS.
- TO EXECUTE ITEM, PRESS ON/OFF, POWER, OR ENTER.

COPY SELECTED CLONE MEMORY TO TV

- (1) MEMORY 1 VER XX REV XX
- (2) MEMORY 2 VER XX REV XX
- (3) MEMORY 3 VER XX REV XX
- (4) RETURN TO CLONE MENU

- TO CHANGE MENU ITEMS, PRESS CHANNEL KEYS OR DIGITS.
- TO EXECUTE ITEM, PRESS ON/OFF, POWER, OR ENTER.

Reference: Upgrading TV/PTC Software using a USB Memory Device

Checking the Software Versions

Note: This function is not accessible while the TV is in FTG or PPV Mode.

You can check the software versions of the TV by accessing the Installer Menu with the Installer Remote: Press **MENU** repeatedly until the on-screen setup menus lock up, and then, press **9-8-7-6 + OK (Enter)**. When you are finished, press **OK (Enter)** again to exit the Installer Menu.

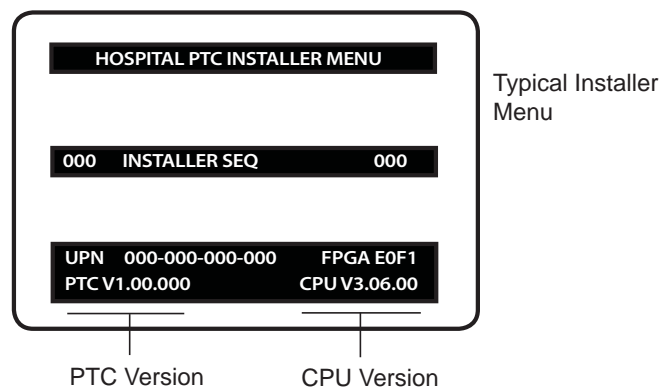

Upgrading TV/PTC Software

Before you begin, note that the software upgrade files must be stored in a folder named "LG_DTV" in the root directory of the USB memory device. Also, ensure the USB device has been formatted with FAT format.

Note for TV Software Upgrade only: If the TV detects a later version of software on the USB device, it will automatically display a dialog from which you can start the software upgrade immediately. Otherwise, you can close the dialog, and access the USB Download Menu as described below.

1. Turn the TV ON.
2. Plug the USB memory device into the USB IN port on the TV.
3. Press **MENU** on the Installer Remote to display the TV setup menus.
4. Use the arrow navigation keys to select/highlight either the **Option** (if the TV is in Pass-through Mode) or **Lock** (if TV is in FTG or LodgeNet PPV Mode) menu icon; then, press the number "7" key a total of seven times to display the USB Download Menu.
5. Use the Up/Down arrow keys to select **Upgrade TV Software** or **Upgrade PTC Software**, as applicable, and then press **OK (Enter)**.
6. Use the Up/Down arrow keys to select the upgrade to install. Then, press **OK (Enter)**.

The TV will show update completion progress in a new window. Do NOT remove the USB device until the software upgrade is complete. When a TV software upgrade is complete, the TV will reset itself with an automatic restart. When a PTC upgrade is complete, the TV will turn OFF.

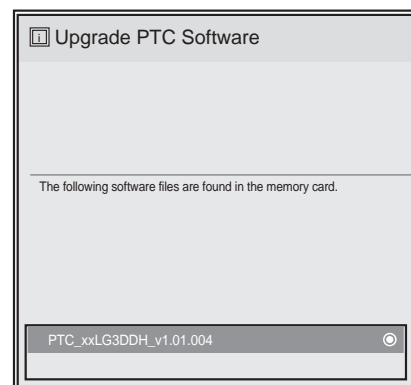
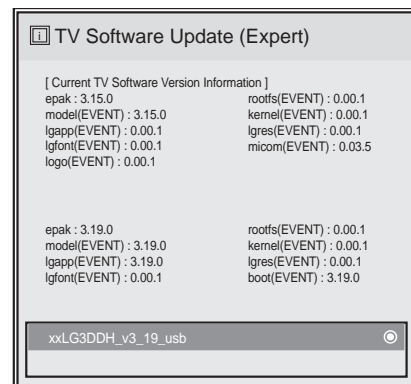
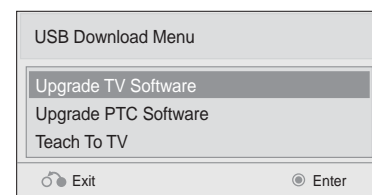

Reference: Power Consumption Settings

Installer Menu item 099 BACK LIGHTING set as shown below.
(LG3DCH: Default value is 200; LG3DDH: Default value is 100.)

	Item 099 Back Lighting (Static)	Picture Lumin. (cd/m ²)	Power Consumption (Watts)	Percent Savings		Item 099 Back Lighting (Dynamic)	Picture Lumin. (cd/m ²)	Power Consumption (Watts)	Percent Savings
22LG3DCH/ 22LG3DDH	100	239	46.5	0.0 %		200	168	38.0	0.0 %
	90	210	44.0	5.4 %		190	158	36.8	3.1 %
	80	195	41.9	9.9 %		180	143	27.8	26.8 %
	70	180	39.7	14.6 %		170	132	27.3	28.2 %
	60	161	37.5	19.4 %		160	119	26.8	29.5 %
	50	142	35.3	24.1 %		150	107	26.2	31.1 %
	40	123	33.0	29.0 %		140	92	25.8	32.1 %
	30	105	30.8	33.8 %		130	80	25	34.2 %
	20	83	28.0	39.8 %		120	66	24.3	36.1 %
	10	63	25.8	44.5 %		110	52	23.7	37.6 %
	1	45	23.5	49.5 %		101	42	23.2	38.9 %

	Item 099 Back Lighting (Static)	Picture Lumin. (cd/m ²)	Power Consumption (Watts)	Percent Savings		Item 099 Back Lighting (Dynamic)	Picture Lumin. (cd/m ²)	Power Consumption (Watts)	Percent Savings
26LG3DCH/ 26LG3DDH	100	430	78.6	0.0 %		200	220	50.0	0.0 %
	90	371	71.7	9.5 %		190	212	48.1	3.7 %
	80	331	65.4	16.7 %		180	203	46.2	7.7 %
	70	298	60.6	22.9 %		170	197	44.8	10.5 %
	60	262	56.1	28.6 %		160	189	43.0	14.0 %
	50	227	51.4	34.6 %		150	181	41.0	17.9 %
	40	194	47.0	40.3 %		140	174	39.5	20.9 %
	30	163	42.6	45.8 %		130	167	37.9	24.2 %
	20	127	38.0	51.6 %		120	161	36.6	26.7 %
	10	93	33.5	57.4 %		110	153	34.9	30.2 %
	1	68	30.0	61.8 %		101	149	34.0	32.1 %

	Item 099 Back Lighting (Static)	Picture Lumin. (cd/m ²)	Power Consumption (Watts)	Percent Savings		Item 099 Back Lighting (Dynamic)	Picture Lumin. (cd/m ²)	Power Consumption (Watts)	Percent Savings
32LG3DCH/ 32LG3DDH	100	452	106.0	0.0 %		200	227	59.0	0.0 %
	90	399	95.0	10.4 %		190	223	56.0	5.1 %
	80	326	82.0	22.6 %		180	208	53.5	9.3 %
	70	287	75.5	28.8 %		170	189	51.0	13.6 %
	60	260	69.0	34.9 %		160	173	49.5	16.1 %
	50	217	63.5	40.1 %		150	155	47.0	20.3 %
	40	188	58.0	45.3 %		140	138	45.0	23.7 %
	30	158	53.0	50.0 %		130	119	42.5	28.0 %
	20	128	47.5	55.2 %		120	99	40.5	31.4 %
	10	98	42.5	60.8 %		110	84	39.0	33.9 %
	1	75	37.0	52.9 %		101	68	37.0	37.3 %

Note: Values are results of controlled experiments under laboratory conditions.

Reference: TV Camport Auto Sense Operation

(26/32LG3DCH and 26/32LG3DDH TVs Only)

The Camport Auto Sense function is enabled when:
 1. Installer Menu item 34 CAMPORT EN is set to 1 AND
 2. Installer Menu item 40 AUTO CAMPORT is enabled (1).

Selectable: Can be accessed with INPUT key, direct access, etc.

Auto Sense: TV switches to this input when connector is inserted. The Camport (Side [AV IN 2] Video) has the highest priority and will override any commands including tuning to the Start Channel.

CAMPORT (Side Video) Functionality Control

Item 034 CAMPORT EN	Item 040 AUTO CAMPORT	Side (AV IN 2) Video Operation
0	0	Disabled
0	1	Disabled
1	0	Selectable
1	1	Auto Sense

Camport Operation (Stand-alone)

When Camport Auto Sense is enabled as above, the TV's source will switch to the Side (AV IN 2) Video Aux source whenever a plug is inserted into either of the AV IN 2 Video inputs (either Composite Video or S-Video).

When the plug is removed, the TV will switch back to the previous channel or input source that was being displayed before the plug was inserted. However, if any direct access to an RF channel or Aux channel is requested while the Camport is active, then, when the video plug is removed, the TV will switch to the last requested channel. Source changes using any Source keys (INPUT) are ignored. Channel Up/Down and Flashback commands are not direct access tuning commands, and they are also ignored.

Previous State Before Inserting CAMPORT	Operation While CAMPORT is Active	State Upon Removal of CAMPORT
Aux or RF Channel	None	Previous Aux or RF Channel
Aux or RF Channel	Direct Access	Last Requested Aux or RF Channel
Aux or RF Channel	Ch Up/Down, Flashback, and Input Keys	Previous Aux or RF Channel

Camport Operation (PPV)

The operation will be similar to that of the Stand-alone Mode. However, when the Channel Map is maintained external to the PTC (i.e., PPV), Channel Up/Down or Flashback keys are sent as Direct Access tuning commands to the PTC/TV.

Previous State Before Inserting CAMPORT	Operation While CAMPORT is Active	State Upon Removal of CAMPORT
Aux or RF Channel	None	Previous Aux or RF Channel
Aux or RF Channel	Direct Access	Last Requested Aux or RF Channel
Aux or RF Channel	Ch Up/Down, Flashback, and Input Keys	Last Requested Aux or RF Channel

Reference: TV Aux Input Configuration

DIRECT ACCESS Tuning		TV		ENABLE				MPI DATA			START AUX SOURCE ASSIGNMENT
				Installer Menu		MPI DATA STATUS TYPE 0x41 SOURCES ENABLED (R/W)		DATA STATUS TYPE 0xD2 CURRENT AV SOURCE (R)		DATA STATUS TYPE 0x0D AUX SOURCE (R)	
OLD_OCV = 0	OLD_OCV = 1	Source Input	Source Mode	Number	Labeling	Value	Labeling	Value	Labeling		
130 *	90	Video2 (Side)	CV/ SVIDEO	34	CAMPOR_T_EN	0x01	Video Front (Campor)	0	Video Front (Campor)	0 (VIDEO)	2
131	91	Video1 (Rear)	CV/ SVIDEO	39	REAR_AUX_EN	0x02	Rear Video (Aux)	1	Rear Video (Aux)	0 (VIDEO)	1
133	93	HDMI1/ DVI	DTV/PC	35	COMPPOR_T_EN = 1	0x08	Front Computer	3	Front Computer	0 (VIDEO)	3
134 *	94	RGB	PC	87	REAR_RGB_EN = 2	0x10	SVGA Rear Computer	4	SVGA Rear Computer	2 (COMPUTER)	4
136 *	96	Component		38	YPrPb EN	0x40	Y/UV Component	6	Rear Y/PrPb Component Video	0 (VIDEO)	6

* Not applicable for 22LG3DCH and 22LG3DDH.

Troubleshooting

General Troubleshooting (Some Quick and Easy Tips for Resolving Problems)

Symptom	Possible Cause(s)	Possible Solution(s)
Software Problems		
Cannot direct enter channel number or "No Signal" appears.	Channel not included in channel lineup in TV controller (PTC).	After 2-5-5 + MENU (Commercial Mode Setup) or Express Script, only channels included in PTC will appear. If channel is available, it can be added to channel lineup. If it is not available, the "No Signal" message appears on the TV screen.
No channels present after setup.	Auto Tuning (channel search) not run.	Refer to Commercial Mode Setup or Express Script procedure, as appropriate. Auto Tuning must be run in order for the channel lineup to be populated. Note for Express Script: You must select "Execute Auto Search" in the Auto Search screen to run the search (see page 17). To reinitiate the Express Script, set Installer Menu item 117 FACT DEFAULT to 001.

Power

No power.	See troubleshooting flow chart on following page.
-----------	---

Display Panel Picture

No picture.	Display panel is turned off.	<ul style="list-style-type: none"> Turn TV ON. Power failure?
	Antenna/cable not connected.	Connect antenna/cable signal to TV.
	Connections incorrect.	Check connections on TV.
	MPI not connected.	If applicable, connect MPI cable to MPI device.
	Encrypted program.	Try another channel.
Wrong tuning band.	Adjust Installer Menu settings.	

Erratic Operation

Installer Menu setup.	Wrong Installer Menu settings.	Adjust Installer Menu settings as required.
-----------------------	--------------------------------	---

Installer Remote

Remote doesn't work.	Remote not in TV Mode.	Use MODE key to select "TV"; puts remote into TV Mode.
	Not aimed at IR remote sensor.	Point remote at TV's IR receiver on TV.
	Remote too far from IR sensor.	Move remote closer to TV's IR receiver or darken room.
	MPI not connected.	If applicable, connect MPI cable to MPI device.
	IR path to TV's receiver obstructed.	Remove obstructions.
	Weak batteries.	Replace batteries.
	Wrong battery polarity.	Check that "+" and "-" match in battery compartment.
	Too much light in room.	Dim room light.
	Bed Switch set to wrong bed.	Set Bed Switch or update Installer Menu, as necessary.
Wrong Installer Remote.	Requires compatible Installer Remote. Contact your LG dealer.	

Picture Reception

Normal picture, poor or no sound.	Audio muted.	Press MUTE or use Volume Up key to increase sound level.
	Broadcast problem.	Try a different channel.
	Pillow Speaker Switch setting.	Check Pillow Speaker Switch setting. If set to Normal, sound will be heard on TV speakers. If set to Pillow, sound will be heard on pillow speaker.

Note: For other problems not caused by the TV, refer to the other devices' operating guide(s).

Troubleshooting (Cont.)

Troubleshooting Flow Chart

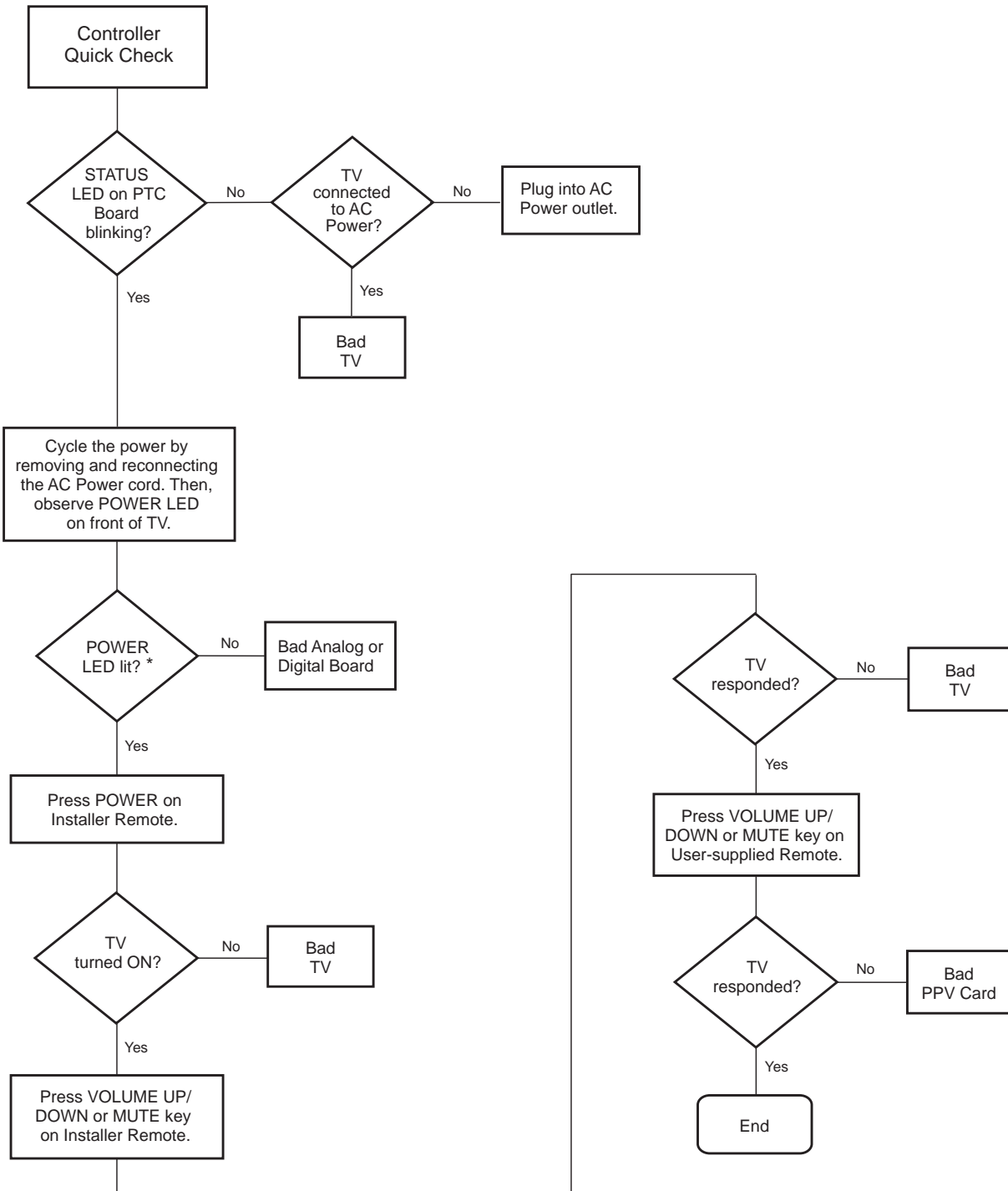

* LG3DDH TVs only: If Installer Menu item 027 HOSPITAL MODE is set to 254 (default), the POWER LED will not remain lit. Continue to the next step.

Troubleshooting (Cont.)

Commercial Mode Check

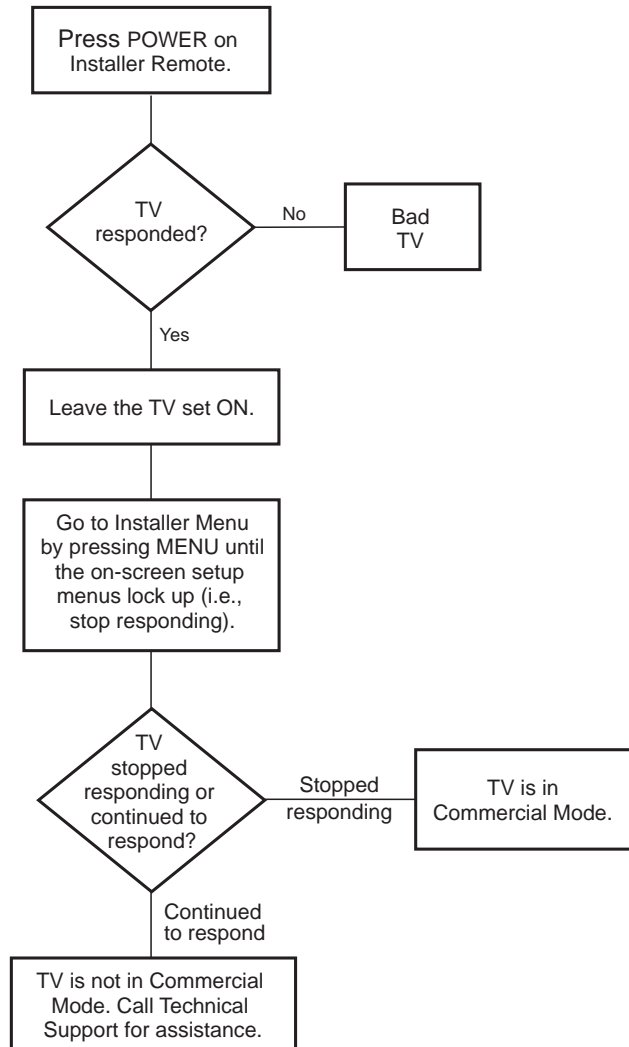

Clone Programmer Troubleshooting



Warning: Do not connect a clone programmer to a PPV card installed in the Master or Target TVs, as this will damage the clone programmer and the PPV card.

Reset Clone Programmer After Static Shock

After replacing exhausted batteries (LT2002 only), or if the clone programmer behaves strangely after a static shock:

- TLL-1100A: Turn the TLL-1100A OFF and then ON.
- LT2002: Use a paper clip or similar instrument inserted through the small hole marked RESET to activate the internal reset switch and restore normal operation.

After a reset, check the real-time clock setting. It may be necessary to reset the clone programmer clock from a TV containing the correct time.

Notes

- The TLL-1100A and LT2002 clone programmers are designed to be used with TVs containing the 221-01006 and later processors. Use with earlier TVs may give unpredictable results. Processors used before the 221-01006-04 have a limited screen display capability; they cannot display entire screens as shown in the setup instructions accompanying the clone programmer. Use the printed menu illustrations in the documentation as an aid to making your programming choices.
- Both Master and Target TVs must be in Pass-through Mode for cloning purposes. See also IMPORTANT CLONING INFORMATION on page 30.

Symptom	Possible Cause(s)	Possible Solution(s)
Clone Programmer		
Clone copies setup in less than 30 seconds.	Not enough time to copy entire TV setup.	TLL-1100A: Turn the TLL-1100A Off and then ON. LT2002: Press RESET on clone programmer. Then redo Learn/Teach. (Learning usually takes about 90 seconds; Teaching usually takes 3 to 4 minutes.)
Remote does not operate clone programmer.	Wrong Installer Remote.	Only use an LG Installer Remote to operate clone programmer with TV.
Clone menu does not display on TV screen, TLL-1100A shows error message, or LT2002 LED does not blink.	MPI cord not connected.	Connect MPI cord properly, and ensure good connection.
	TV not turned ON.	TV must be powered ON for clone programmer to work.
	(LT2002 only) Weak batteries.	Install four (4) fresh AA high-quality alkaline batteries.
	(TLL-1100A only) No charge.	Ensure the TLL-1100A is fully charged or connected to AC power.
Clone menu hard to read.	Weak signal.	Connect TV to a reliable analog channel signal source.
No time set.	Time not available.	Set time on a TV, and copy time to clone programmer.
Clone not working.	Clone programmer problem.	<ul style="list-style-type: none"> • Try a different clone programmer. • Reset the clone programmer.
Clone scans channels more than once.	Clone should only scan channels once.	Ensure TV is set up correctly, and try cloning again.

Master and Target TVs

Cloning did not work.	Procedure interrupted.	Wait until procedure complete message is displayed.
	Different TV models.	Cloning is only possible with identical model TVs.
	Step(s) omitted or not performed.	Refer to the applicable cloning procedure(s), and make sure all tasks were performed.
(LT2002 only) Clone time disappeared.	Batteries were removed.	Batteries must remain installed to retain time settings.
New setup not present.	Target TV not reset.	Disconnect Target TV from AC power for fifteen (15) seconds.

- After cloning operations are complete, unplug the TLL-1100A/LT2002 from the TV.
- If the TV does not display a picture (blank screen) after a few seconds, just change channels.

Troubleshooting (Cont.)

Channel Banks Setup Troubleshooting

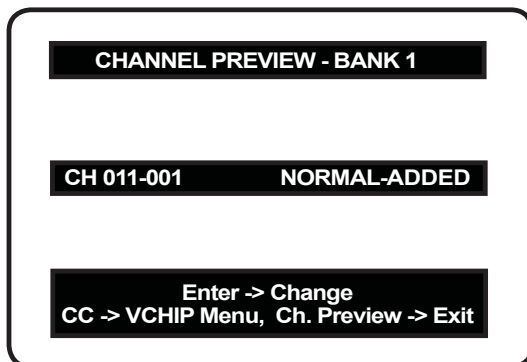

Channel Banks Setup Menu

Symptom	Cause	Solution
Cannot change channel status in menu.	Installer Menu item 028 CH. OVERRIDE is set to 000 and/or Channel Access was denied in Express Script.	Set CH. OVERRIDE to 001 to allow access for channel status change.
Channel Banks Setup Menu does not appear.	2-5-5 + MENU procedure/Express Script was not performed/completed.	The Channel Banks Setup Menu will not be available until the TV setup is transferred to the PTC. Also, set Installer Menu item 028 CH. OVERRIDE to 001 to allow access for channel status changes.
Channel is blanked in all channel banks.	Blanking a channel in one channel bank will make it blank in all channel banks.	
Cannot tune in deleted channel on Channel Banks Setup Menu.		Select a channel bank where the deleted channel number is set to "Normal-Added." Direct enter the deleted channel number. Change to the bank in which you want to activate the channel. Select "Normal-Added" on the Channel Banks Setup Menu.
"Inactive TV" message appears and then TV turns Off.	TV is set up to display "Inactive TV" message if all channels are "Normal-Deleted" from Channel Bank 4.	Select another channel bank (1, 2, or 3) to return TV to normal operation.
Channel found in scan does not tune in with Channel Up/Down.	Channel was deleted in currently selected channel bank.	If banks were set up, premium channels may only be available on another channel bank. Select the channel bank where the channel is set to "Normal-Added." Or, direct enter channel number; then go to Channel Banks Setup Menu and select "Normal-Added."
When BANK on Installer Remote is pressed, TV shows Aux Sources Selection Menu.	Installer Menu item 027 HOSPITAL MODE is set to 0.	Set back to default "2" (LG3DCH) or to appropriate setting (LG3DDH) for channel banks to appear with BANK or INPUT key presses.

A list of definitions for some of the words found in this guide

75 OHM RF CABLE

The wire that comes from an off-air antenna or cable service provider. The end looks like a hex-shaped nut with a wire through the middle. It screws onto the Antenna/Cable threaded jack on the back of the TV.

300 TO 75 OHM ADAPTER

A small device that connects a 2-wire 300 ohm antenna to a 75 ohm RF jack. It is usually about an inch long with two screws on one end and a round opening with a wire extending out the other end.

A/V CABLES

Audio/Video cables. Three cables bunched together—right audio (red), left audio (white), and video (yellow). A/V cables are used for stereo playback of videocassettes and for higher quality picture and sound from other A/V devices.

A/V DEVICE

Any device that produces video or sound (VCR, DVD, cable box, or television).

AMPLIFIER

An electronic device that amplifies sound from a television, CD player, VCR, DVD player, or other Audio/Video device.

ANALOG TELEVISION

Standard television broadcasting format in 4:3 picture aspect ratio.

ANTENNA

The physical receiver of television signals sent over the air. A large metal piece of equipment does not always have to be visible to be using an antenna.

CABLE

Cable service box. Refers to the descrambler box cable subscribers use to receive cable programming signals.

CATV

Programming provided by a cable service.

COMPONENT VIDEO

Uses three wires for transporting three-color video signals. The end result is usually better video quality.

COMPOSITE VIDEO

Typical video jack, uses one wire for transporting three-color video signals.

DELETE

Lets you remove channels from the list that the end user can scroll through using Channel Up/Down.

DIGITAL TELEVISION

High-resolution, cinema-quality television signals transmitted digitally.

DVI

Digital Video Interface. Accommodates analog and digital interfaces with a single connector.

HDMI

High-definition multi-media interface.

HDSTB

High-definition set-top box. Refers to a tuner device that receives high-definition television signals, which have higher resolution than ordinary analog TV signals.

HDTV

High-definition television. Refers to television signals that have higher resolution than ordinary analog TV signals.

INPUT

Refers to the input jack that receives a signal from a TV, VCR, DVD player or other Audio/Video device.

JACK

An input or output connector on the back of a TV, VCR, DVD player, or other Audio/Video device.

MONO SOUND

Mono (monaural) sound is one channel of sound. On more than one speaker, all the speakers play the same audio.

OUTPUT

Refers to the output jack that sends a signal out of a VCR, DVD player, or other Audio/Video device.

PHYSICAL CHANNEL NUMBER

The actual channel number. Analog channels use the Physical Channel number, while digital channels can use a Virtual Channel number.

RGB (RED, GREEN, BLUE)

Connection input or output port available for producing a video image using three separate colors: Red, Green, and Blue.

RS-232

Serial communication port through which the display panel is controlled.

2ND AUDIO PROGRAMMING/SAP

Second Audio Programming (SAP) is another, separate audio channel available with some programming. Choosing SAP often refers to listening to audio in another language, such as Spanish or French.

SIGNAL

Picture and sound traveling through a cable, or over the air, to the TV.

STEREO SOUND

Stereo (Stereophonic) sound refers to audio that is divided into right and left sides.

TUNER

Device that picks up the broadcast signal and turns it into picture and sound.

VIRTUAL CHANNEL NUMBER

A re-mapped channel number. Analog channels use the Physical Channel number; however, digital channels use a Virtual (or false) Channel number.

XDS

Extended Data Service. Additional program information included on the signal provided at the discretion of the broadcaster.

Note: Refer to www.atsc.org for further information.

Document Revision History

Date	Description
May 2008	Revision A: New Document
June 2008	Revision B: Installer Menu updates
July 2008	Revision C: Channel Banks and Installer Menu updates
June 2010	Revision D: Introduction of LG3DDH and Installer Menu updates
July 2010	Revision E: Express Script, pillow speaker, and Installer Menu (HOSPITAL MODE) updates
December 2010	Revision F: Installer Menu (HOSPITAL MODE), Master TV Setup, cloning, software upgrade updates
January 2011	Revision G: LG3DDH jack panel, Express Script, Installer Remote, channel bank updates

Product documentation is available online at: www.LGolutions.com/products. From the Products page, select **TVs, Systems & Solutions**, then **LCD TVs**, then the applicable TV. Click the **Literature & Downloads** tab at the bottom of the TV page, and select the required document(s) from the Downloads list.

Notes



For Customer Support/Service, please call:

1-888-865-3026

www.LGsolutions.com

Marketed and Distributed in the United States by LG Electronics U.S.A., Inc.
1000 Sylvan Avenue, Englewood Cliffs, NJ 07632

Free Manuals Download Website

<http://myh66.com>

<http://usermanuals.us>

<http://www.somanuals.com>

<http://www.4manuals.cc>

<http://www.manual-lib.com>

<http://www.404manual.com>

<http://www.luxmanual.com>

<http://aubethermostatmanual.com>

Golf course search by state

<http://golfingnear.com>

Email search by domain

<http://emailbydomain.com>

Auto manuals search

<http://auto.somanuals.com>

TV manuals search

<http://tv.somanuals.com>