



Color television OWNER'S MANUAL

**MODELS: 30FZ1DC
32FZ1DC-UB**



Please read this manual carefully and completely before operating your TV.

Retain this manual for future reference.

Record model number and serial number of the TV in the spaces provided below.

See the label attached on the back cover and relate this information to your dealer if you require service.

Model Number :

Serial Number :



WARNING/CAUTION
RISK OF ELECTRIC SHOCK
DO NOT OPEN



WARNING/CAUTION:

TO REDUCE THE RISK OF ELECTRIC SHOCK DO NOT REMOVE COVER (OR BACK). NO USER SERVICEABLE PARTS INSIDE. REFER TO QUALIFIED SERVICE PERSONNEL.



The lightning flash with arrowhead symbol, within an equilateral triangle, is intended to alert the user to the presence of uninsulated "dangerous voltage" within the product's enclosure that may be of sufficient magnitude to constitute a risk of electric shock to persons.



The exclamation point within an equilateral triangle is intended to alert the user to the presence of important operating and maintenance (servicing) instructions in the literature accompanying the appliance.

WARNING/CAUTION:

TO PREVENT FIRE OR SHOCK HAZARDS, DO NOT EXPOSE THIS PRODUCT TO RAIN OR MOISTURE.

POWER CORD POLARIZATION:

CAUTION: TO PREVENT ELECTRIC SHOCK, MATCH WIDE BLADE OF PLUG TO WIDE SLOT, FULLY INSERT.

ATTENTION: POUR ÉVITER LES CHOCS ÉLECTRIQUES, INTRODUIRE LA LAME LA PLUS LARGE DE LA FICHE DANS LA BORNE CORRESPONDANTE DE LA PRISE ET POUSSER JUSQU'AU FOND.

NOTE TO CABLE/TV INSTALLER:

This reminder is provided to call the CATV system installer's attention to Article 820-40 of the National Electric Code (U.S.A.). The code provides guidelines for proper grounding and, in particular, specifies that the cable ground shall be connected to the grounding system of the building, as close to the point of the cable entry as practical.

REGULATORY INFORMATION:

This equipment has been tested and found to comply with the limits for a Class B digital device, pursuant to Part 15 of the FCC Rules. These limits are designed to provide reasonable protection against harmful interference when the equipment is operated in a residential installation. This equipment generates, uses and can radiate radio frequency energy and, if not installed and used in accordance with the instruction manual, may cause harmful interference to radio communications. However, there is no guarantee that interference will not occur in a particular installation. If this equipment does cause harmful interference to radio or television reception, which can be determined by turning the equipment off and on, the user is encouraged to try to correct the interference by one or more of the following measures:

- Reorient or relocate the receiving antenna.
- Increase the separation between the equipment and receiver.
- Connect the equipment into an outlet on a circuit different from that to which the receiver is connected.
- Consult the dealer or an experienced radio/TV technician for help.

Any changes or modifications not expressly approved by the party responsible for compliance could void the user's authority to operate the equipment.

CAUTION:

Do not attempt to modify this product in any way without written authorization from Zenith Electronics Corporation. Unauthorized modification could void the user's authority to operate this product.

COMPLIANCE:

The responsible party for this product's compliance is:
LG Electronics U.S.A., Inc
1000 Sylvan Avenue, Englewood Cliffs, NJ 07632
1-800-243-0000
<http://www.lgusa.com>

IMPORTANT SAFETY INSTRUCTIONS

IMPORTANT SAFETY INSTRUCTIONS

Important safety instructions shall be provided with each apparatus. This information shall be given in a separate booklet or sheet, or be located before any operating instructions in an instruction for installation for use and supplied with the apparatus.

This information shall be given in a language acceptable to the country where the apparatus is intended to be used.

The important safety instructions shall be entitled "Important Safety Instructions". The following safety instructions shall be included where applicable, and, when used, shall be verbatim as follows. Additional safety information may be included by adding statements after the end of the following safety instruction list. At the manufacturer's option, a picture or drawing that illustrates the intent of a specific safety instruction may be placed immediately adjacent to that safety instruction :

- 1. Read these instructions.**
- 2. Keep these instructions.**
- 3. Heed all warnings.**
- 4. Follow all instructions.**
- 5. Do not use this apparatus near water.**
- 6. Clean only with dry cloth.**
- 7. Do not block any ventilation openings. Install in accordance with the manufacturer's instructions.**
- 8. Do not install near any heat sources such as radiators, heat registers, stoves, or other apparatus (including amplifiers) that produce heat.**
- 9. Do not defeat the safety purpose of the polarized or grounding-type plug. A polarized plug has two blades with one wider than the other. A grounding type plug has two blades and a third grounding prong. The wide blade or the third prong are provided for your safety. If the provided plug does not fit into your outlet, consult an electrician for replacement of the obsolete outlet.**
- 10. Protect the power cord from being walked on or pinched particularly at plugs, convenience receptacles, and the point where they exit from the apparatus.**
- 11. Only use attachments/accessories specified by the manufacturer.**
- 12. Use only with the cart, stand, tripod, bracket, or table specified by the manufacturer, or sold with the apparatus. When a cart is used, use caution when moving the cart/apparatus combination to avoid injury from tip-over.**



PORTABLE CART WARNING

(Continued on next page)

IMPORTANT SAFETY INSTRUCTIONS

13. Unplug this apparatus during lightning storms or when unused for long periods of time.

14. Refer all servicing to qualified service personnel. Servicing is required when the apparatus has been damaged in any way, such as power-supply cord or plug is damaged, liquid has been spilled or objects have fallen into the apparatus, the apparatus has exposed to rain or moisture, does not operate normally, or has been dropped.

15. CAUTION concerning the Power Cord :

Most appliances recommend they be placed upon a dedicated circuit; that is, a single outlet circuit which powers only that appliance and has no additional outlets or branch circuits. Check the specification page of this owner's manual to be certain.

Do not overload wall outlets. Overloaded wall outlets, loose or damaged wall outlets, extension cords, frayed power cords, or damaged or cracked wire insulation are dangerous. Any of these conditions could result in electric shock or fire. Periodically examine the cord of your appliance, and if its appearance indicates damage or deterioration, unplug it, discontinue use of the appliance, and have the cord replaced with an exact replacement part by an authorized servicer.

Protect the power cord from physical or mechanical abuse, such as being twisted, kinked, pinched, closed in a door, or walked upon. Pay particular attention to plugs, wall outlets, and the point where the cord exits the appliance.

16. Outdoor Use Marking :

WARNING - To Reduce The Risk Of Fire Or Electric Shock, Do Not Expose This Appliance To Rain Or Moisture.

17. Wet Location Marking :

Apparatus shall not be exposed to dripping or splashing and no objects filled with liquids, such as vases, shall be placed on the apparatus.

Table of Contents

Safety Warnings	2	EZ SoundRite	27
Important Safety Instructions	3-4	Stereo/SAP Broadcasts Setup	28
Step 1. Hook Up TV		EZ Sound	28
Front Panel Controls	6	Manual Sound Control	29
Rear Connections Panel	7	TV Speaker on/off Setup	29
Front Connections Panel (FRONT VIDEO)	8	Front Surround	30
ANT/Cable Service Hookup	9	TIME Menu	
Cable Box Connections	10	Auto Clock Setup	31
VCR Connections	11	Manual Clock Setup	32
DVD Player	12	TV Turn Off Time Setup	33
Set-top Box Hookup	13	TV Turn On Time Setup	34
Digital Audio Output	14	Sleep Timer Setup	35
HDMI	15	Auto off	36
Remote Control Functions in TV Mode	16-17	OPTION Menu	
Turning the TV on	18	Aspect Ratio Control	37
On-Screen Displays	18	Captions	38
Step 2. Customize your TV's Features		Caption/Text	39
SETUP Menu		Caption Option Menu	40
EZ Scan (Channel Search)	19	On-Screen Menu Languages	41
Channel Edit	20	Velocity Modulation	42
DTV Signal	21	Tilt	42
Degaussing the screen	21	Cinema 3:2 Mode Setup	43
Channel Label Setup	22	EZ Demo	44
Input Source Selection	23	LOCK Menu	
VIDEO Menu		Parental Lock Setup	45-46
EZ Picture	24	Step 3. Miscellaneous	
Manual Video Control	25	Programming the Remote	47
Color Temperature	26	Programming Codes	48-50
XD	26	Maintenance	51-52
Video Preset	26	Troubleshooting	53-54
AUDIO Menu		Glossary	55-56
Audio Language	27	Product Specifications	57
		Warranty	60

Front Panel Controls

- Here shown may be somewhat different from your TV.

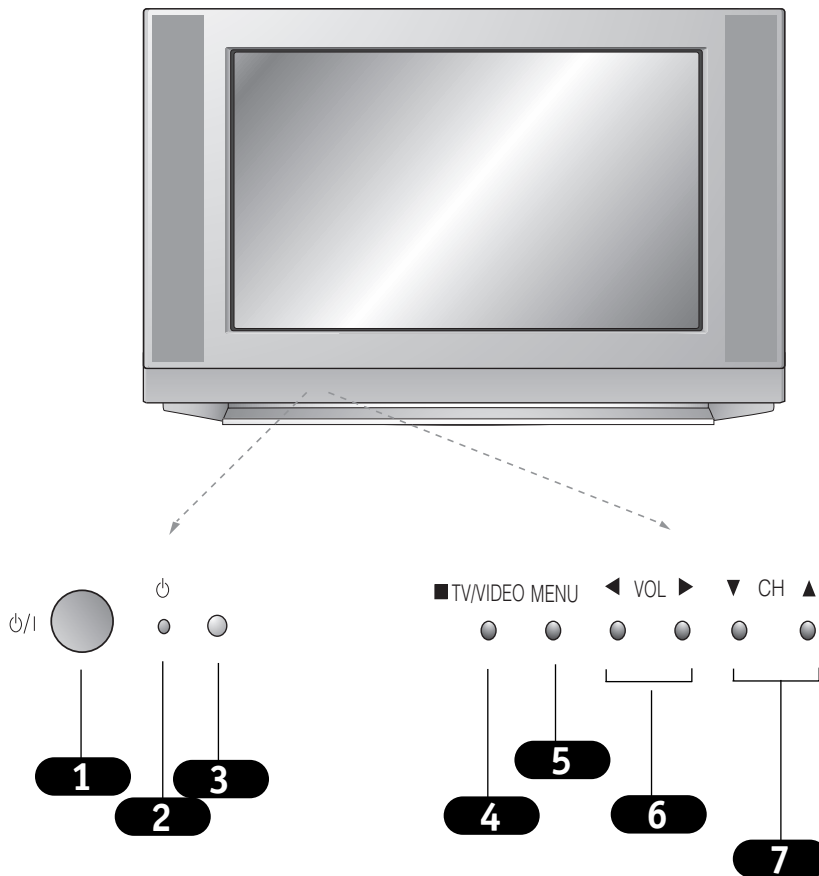

- 1** power
- 2** Standby indicator (Illuminates brightly when the TV is in standby mode. Dims when the TV is switched on.)
- 3** Remote control sensor
- 4** ■ TV/VIDEO
- 5** menu
- 6** vol left/ right
Volume(▶) button increases the sound level and volume(◀) button decreases the sound level.
- 7** ch (Channel) up / down



These buttons work just as they do on your remote control.

Rear Connections Panel

- Connecting external equipment to your TV.
- Here shown may be somewhat different from your TV.

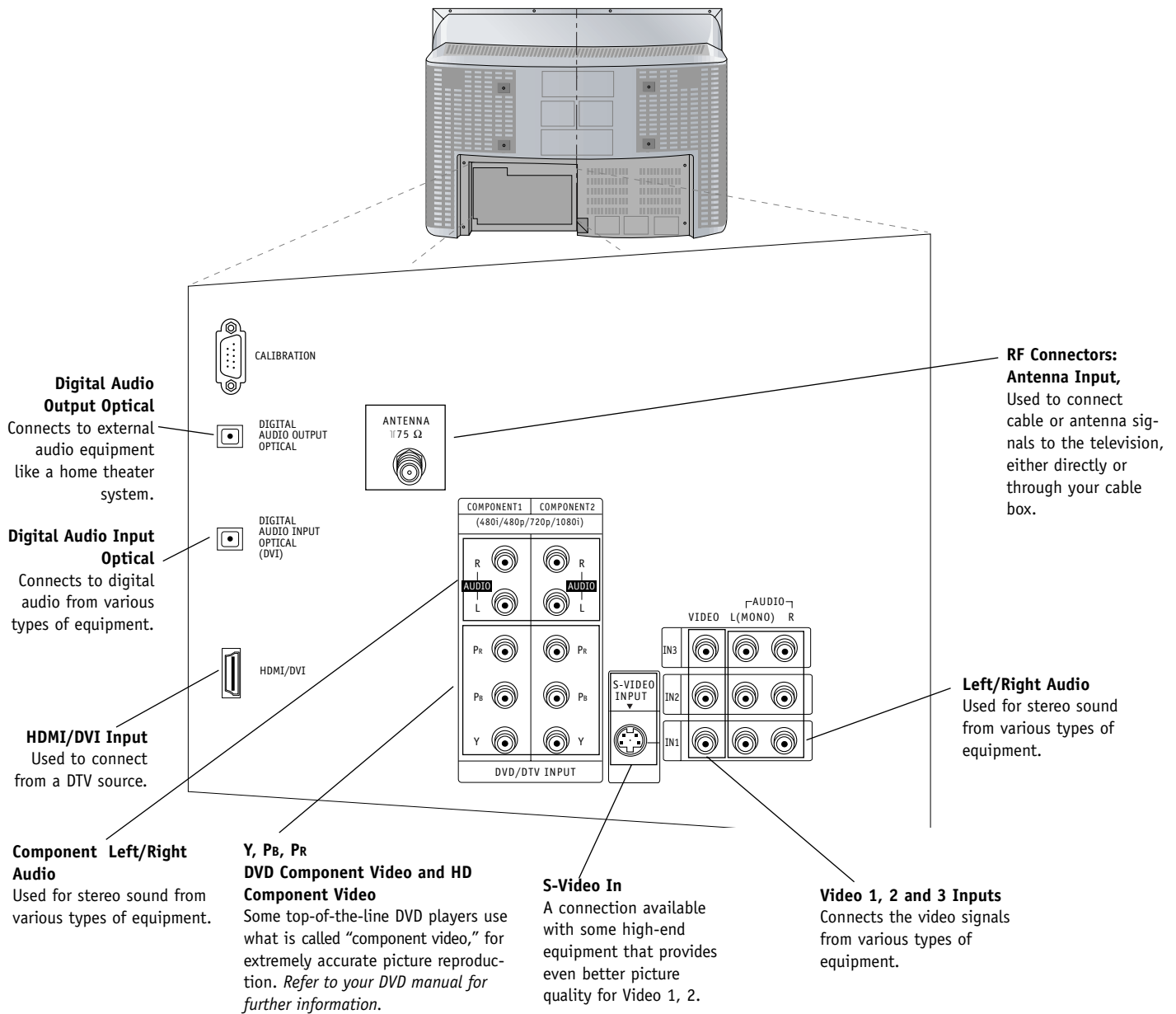

Mini glossary

- JACK** A connection on the back of a TV, VCR, or any other A/V device. This includes the RF jack and the Audio/Video jacks that are color-coded.
- SIGNAL** Picture and sound traveling through cable, or over the air, to your television screen.

Front Connections Panel

There are four jacks on the lower-right front front of your TV that make connecting Audio/Video devices like video games and camcorders very simple.

The jacks are like those found on the back jack connection panel. This means that most equipment that connects to those types of jacks on the rear jackpack, may be connected to the Front connection panel (Front Video).

To use the Front jacks as the signal source, select them using Main input menu as described on page 23. They will be named "Front Video" in the Main input menu.



When you select Front video or Front S-Video, the Front Audio inputs are automatically selected as well.



Do not connect to both Video and S-Video at the same time. Connect either Video or S-Video only.

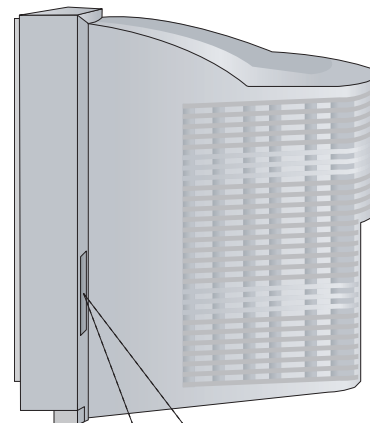

Front A/V Panel



S-Video

A connection available on some very high-end equipment that provides better picture quality than video input.

Video in

Connects the video signals from any piece of equipment.

Left/Right Audio

Used for stereo sound from various types of equipment.

Mini glossary

A/V CABLES Audio/Video cables. Three cable connector—Right audio (red), Left audio (white), and Video (yellow). A/V cables are used for stereo playback of videocassettes and for higher quality picture and sound from other A/V devices.

A/V DEVICE Any device that produces video (picture) and/or audio (sound) (VCR, DVD, cable box, or television).

Antenna / Cable Service Hookup

1 Connect an antenna and/or cable service to your TV as shown.

2 Turn to page 19 to do a channel search with EZ Scan.



If you receive your RF signal through an antenna that is several years old and connects with two small prongs, you will need to purchase a 300 to 75 ohm adapter. It should be available from your local electronics dealer.



We recommend using a 75 ohm cable for your antenna connection in order to prevent interference.

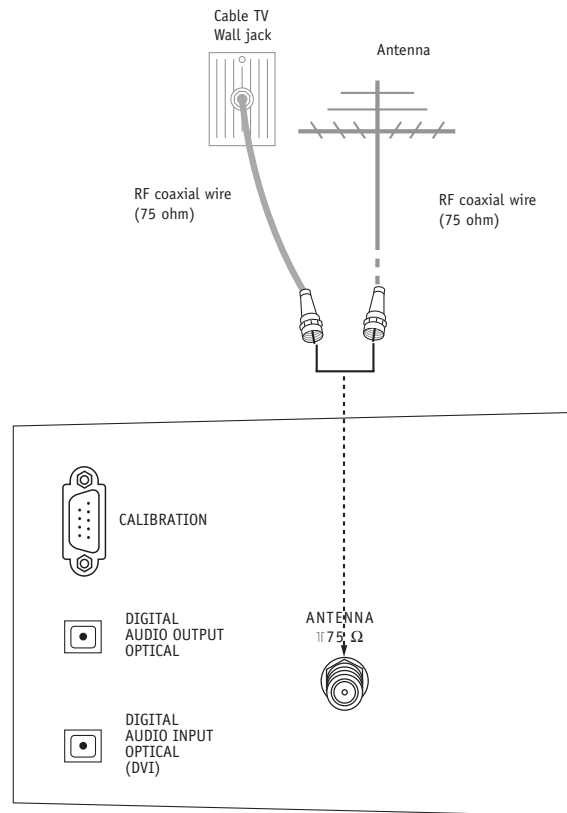

Mini glossary

TV	OVER-THE-AIR SIGNALS	DTV	DIGITAL OVER-THE-AIR SIGNALS
CATV	CABLE SIGNALS	CADTV	DIGITAL CABLE SIGNALS

Combined signals

TV/CATV/DTV	Over-the-air, cable, and digital over-the-air signals
TV/CATV/CADTV	Over-the-air, cable, and digital cable signals

CAUTION : If you are not sure of the type of signal(s) you are receiving, let EZ Scan complete all the channel signal-type searches. The TV will let you know when the analog, cable, and digital channel scans are complete.

For best signal reception, it is recommended to have your Antenna professionally adjusted.

Cable Box Connections

1

Locate the output jack on the back of your cable box. Connect this to the Cable jack on the back of your TV.

Or find the composite video and audio jacks on the back of your cable box, and connect them following the instructions provided with your equipment. This can be combined with any other equipment you may want to hook up.

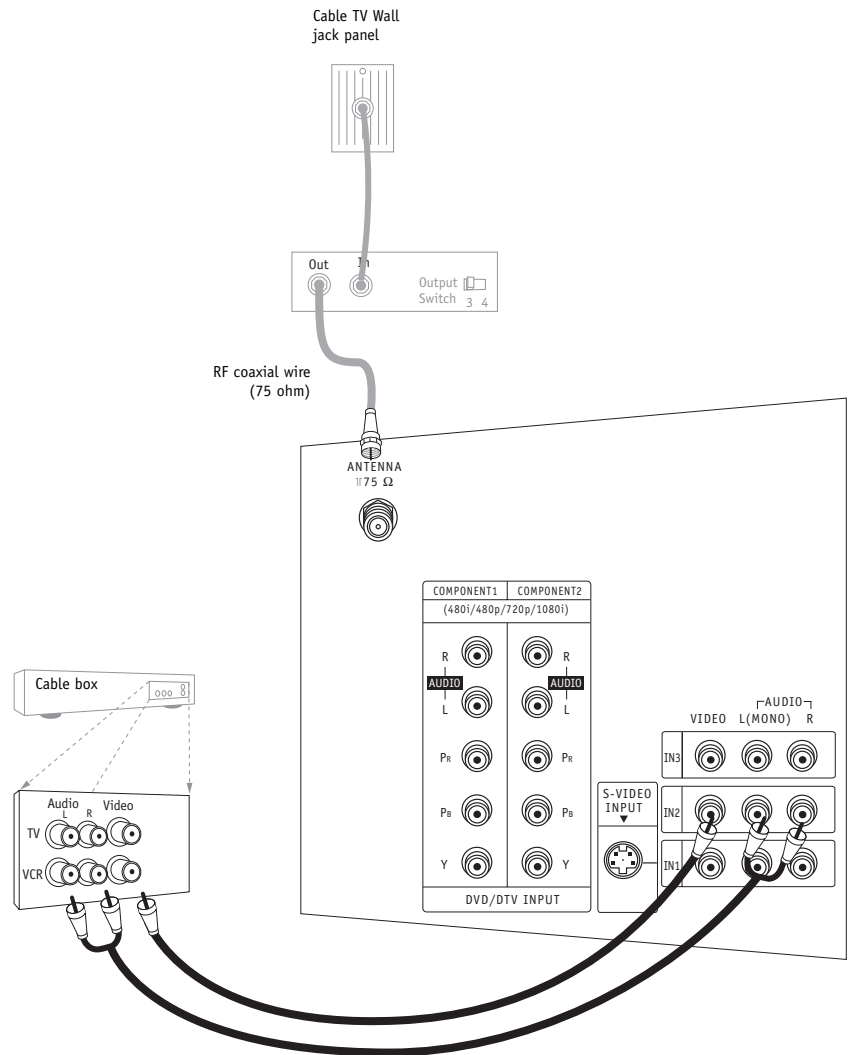

If you're using a cable box, leave the TV on channel 3 or 4 and use your cable box to change channels.

VCR Connections

1

Locate the Cable jack on the back of your TV. Connect this to out jack on the back of your VCR.

Or find the composite video and audio jacks on the back of your VCR, and connect them following the instructions provided with your equipment.

You may connect either the composite video or the S-Video cables to your TV. (Do not connect BOTH the composite and the S-Video cables. In the event that you connect both composite and the S-Video cables, only the S-Video will work.)

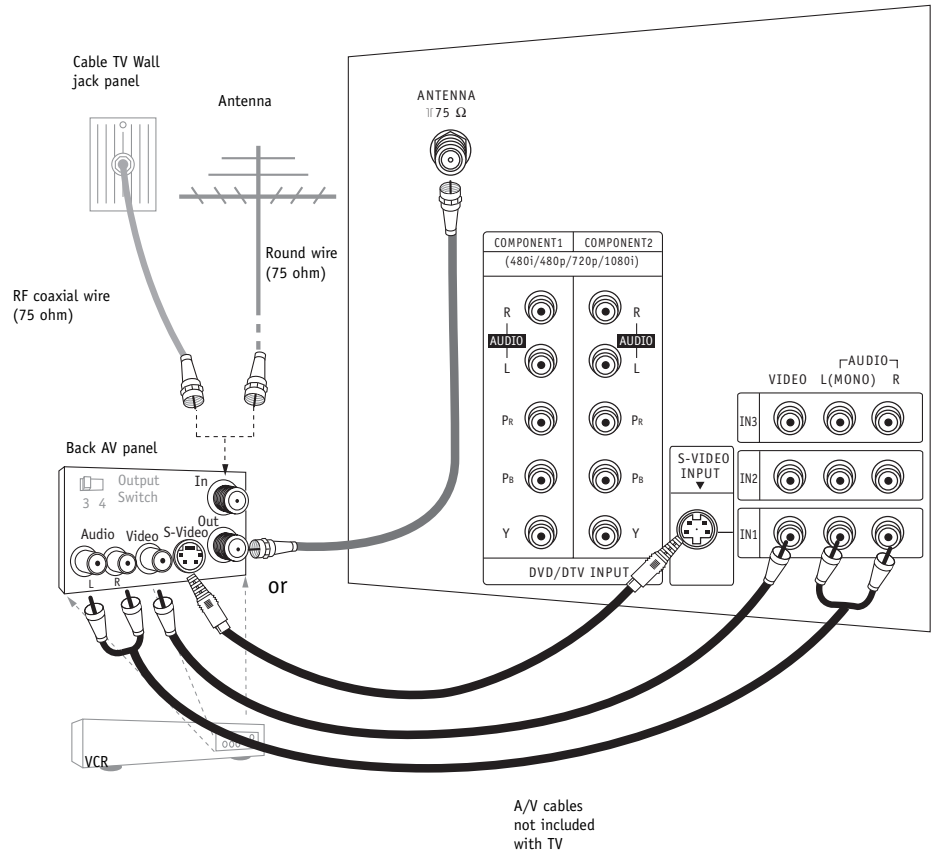

To hear stereo sound from cable or your VCR, you will need to connect A/V cables as well as the wire that runs from the VCR to your TV.



If you want to receive your signals on Channel 3 or 4, locate the Out to TV jack on your VCR. Connect a cable from the Out to TV jack to the Antenna jack on the back of your TV.

DVD Player

1

Find the component or S-Video jacks for video connections, depending on your DVD connectors. Then make the corresponding audio connections. See the diagram for either set up.

2

You may connect either the composite video or the S-Video cables to your TV. Do not connect both the composite and the S-Video.

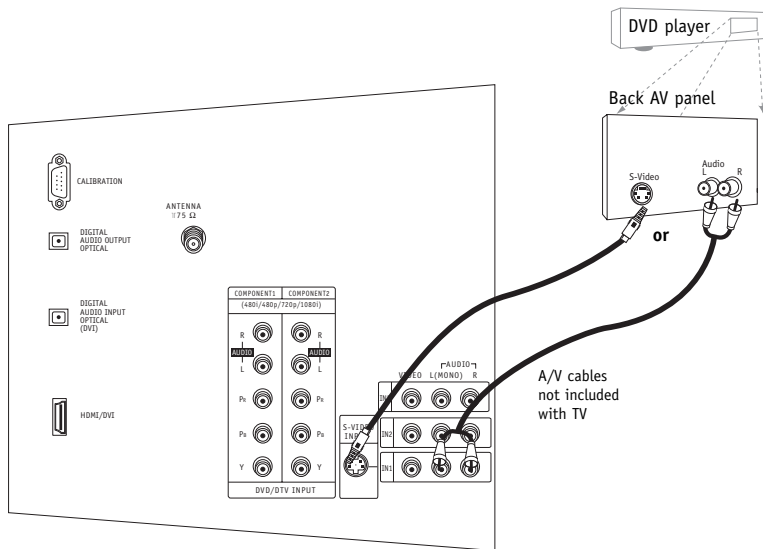
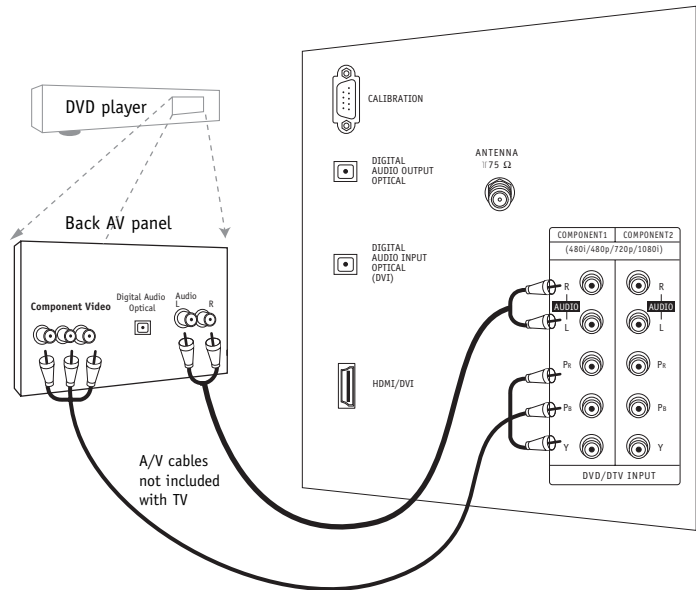

Some high-end DVD players use a picture reproduction system called "component video." If your DVD player has component output, use the connectors marked "Component 1 or 2" on the jack panel. Please refer to your DVD manual for proper installation.

• **Component Input ports**

You can get better picture quality if you connect a DVD player using the component input ports as shown below.

Component input jacks on the TV	Y	P _B	P _R
Video output jacks of DVD player	Y	P _b	P _r
	Y	B-Y	R-Y
	Y	Cb	Cr
	Y	P _B	P _R

Mini glossary

COMPONENT VIDEO Some video equipment uses three separate lines (Y, P_B, P_R) to more precisely reproduce images. Your manual will explain how this relates to your equipment.

Set-top box Hookup

1

Find the audio and Y, Pb, Pr jacks or HDMI/DVI output port on the back of your set-top box and connect them following the instructions provided with your equipment.

2

Connect these cables to your TV as shown.

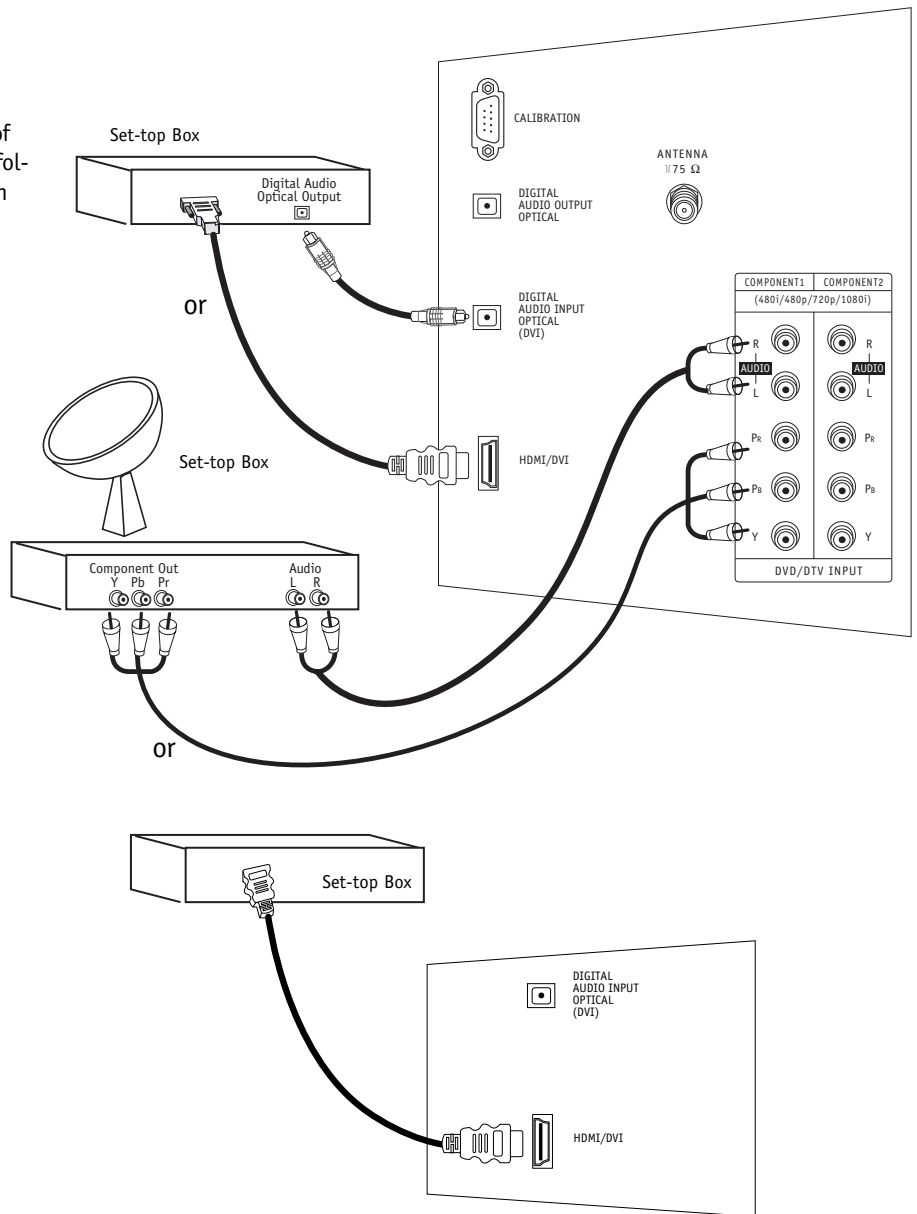

The DTV shows the sharpest picture in 720p/1080i mode.

HDMI/DVI

1920x1080i
1280x720p
720x480p

Component 1 (or 2) Input

Y	Pb	Pr
1920X1080i		
1280X720p		
720X480p		
720X480i		

Digital Audio Output

Send the TV's audio out to external audio equipment (stereo system) via the Digital Audio Output Optical port.

1 Connect one end of an optical cable to the TV Digital Audio Optical Output port.

2 Connect the other end of the optical cable to the digital audio optical input on the audio equipment.

See the external audio equipment instruction manual for operation.



Caution: Do not look into the optical output port. Looking at the laser beam may damage your vision.

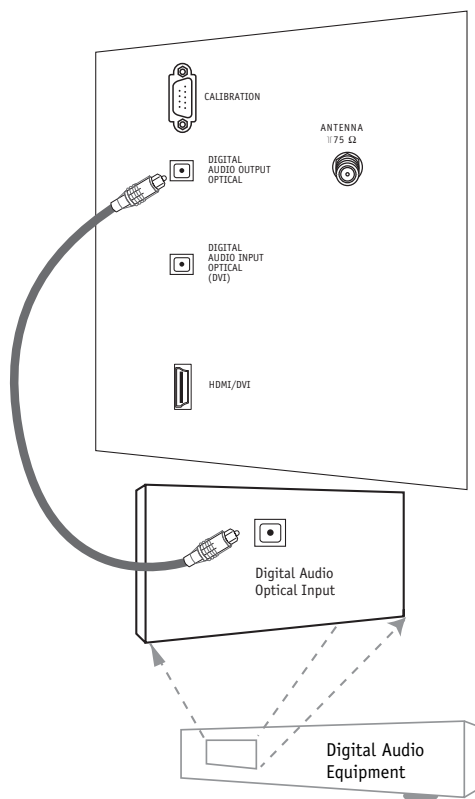



- HDMI™, the HDMI logo and High-Definition Multimedia Interface are trademarks or registered trademarks of HDMI Licensing LLC."
- This DTV can receive the High-Definition Multimedia Interface(HDMI) or Input of Digital Visual Interface(DVI).
- This DTV supports HDCP(High-bandwidth Digital Contents Protection) Protocol for DTV(480p, 720p, 1080i) modes.
- When you Connect with HDMI Source Devices (DVD Player or Set Top Box) supporting Auto HDMI function, automatically, support Plug & Play and then set the HDMI Source Devices(1920 x 1080i). After reading in HDMI Source Devices using Display Data Channel(DDC) Protocol, EDID stored in DTV is used. If HDMI Source Devices not supported Auto HDMI/DVI is been, the Resolution is setted, manually.
- To get the best picture quality, adjust the DVD Player or Set Top Box output resolution to 1920 x 1080i.
- When Source Devices have DVI Output Connector, you must connect audio with separated cable. (Refer to <How to connect>)
- The HDMI is not supported in 480i source.

How to connect

1. When Source Devices(DVD Player or Set Top Box) support HDMI.

- If Source Devices have HDMI Output Connector, Source Devices connect to DTV with HDMI Cable .(not supplied with the product).
- If Source Devices support Auto HDMI, automatically, Source Devices divert output resolution in 1920 x 1080i. But if not, resolution divert Manually Setting for reference Manual of Source Devices.
- To get the best picture quality, adjust the DVD Player or Set Top Box output resolution to 1920 x 1080i.
- Because HDMI sends Digital Video and Audio with one cable, need not especial Audio Cable for using HDMI Cable.

2. When Source Devices(DVD Player or Set Top Box) supports DVI.

- If Source Devices have DVI Output Connector, Source Devices connect to DTV with HDMI to DVI Cable (not supplied with the product).
- If Source Devices support Auto DVI, automatically, Source Devices divert output resolution in 1920 x 1080i. But if not, resolution divert Manually Setting for reference Manual of Source Devices.
- To get the best picture quality, adjust the DVD Player or Set Top Box output resolution to 1920 x 1080i.
- In this case, Audio use other cable. When Source Devices have Fiber Optic Digital Audio Output Connector, Digital Audio DVI Input(DVI) of DTV connect to Fiber Optic Digital Audio Cable (not supplied with the product) or when Source Devices have Analog Audio Output Connector, RGB/DVI Audio Input of DTV connect to Audio Cable (not supplied with the product). And then you can listen to normal Audio.

Reference

Cable sample



HDMI Cable (not supplied with the product)



HDMI to DVI Cable (not supplied with the product)

How to use

1. Connect the HDMI Source Devices (DVD Player or Set Top Box) and the TV set.
2. Turn on the display by pressing the ON/OFF button on the TV set and HDMI Source Devices remote control.
3. Check the image on your TV set. There may be noise associated with the resolution, vertical pattern, contrast or brightness in HDMI Source Devices. If noise is present, change the HDMI Source Devices to another resolution, change the refresh rate or adjust the brightness and contrast on the menu until the picture is clear.

Remote Control Functions in TV Mode

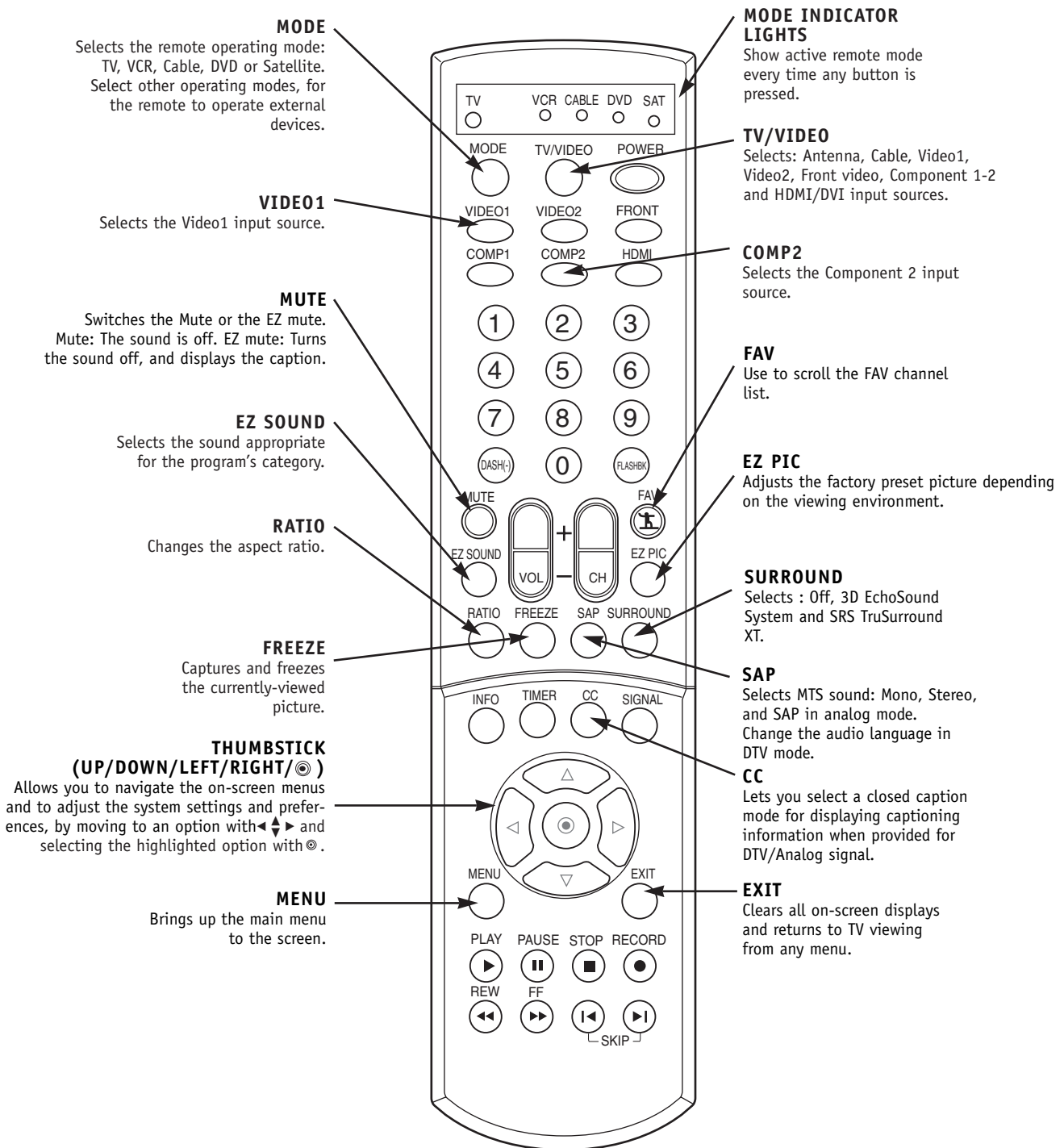

Remote Control Functions in TV Mode

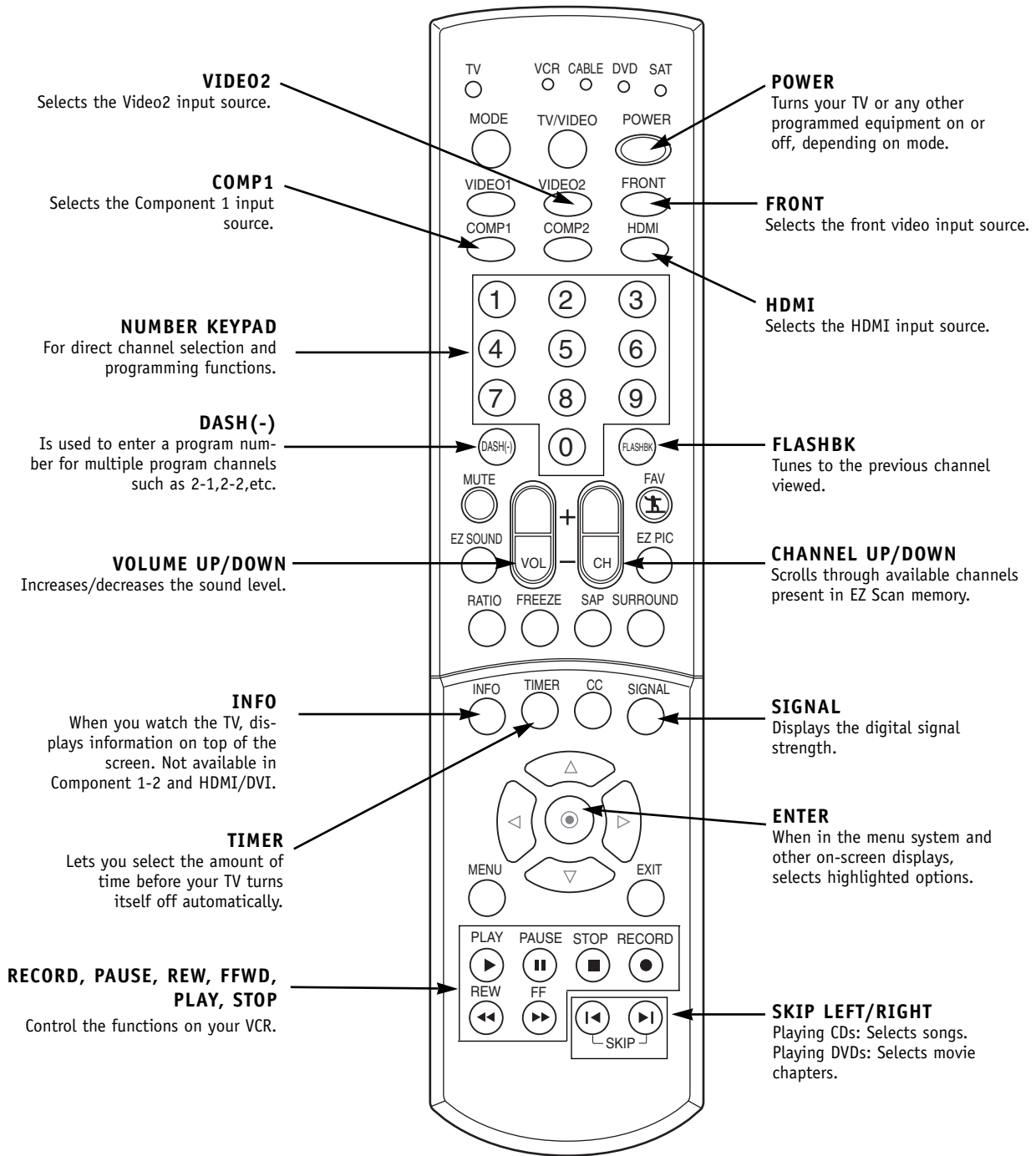

Turning the TV On

- 1** First, connect antenna cable and power cord correctly. At this moment, the TV switches to standby mode.
In standby mode to turn TV on, press the POWER, CH +/-, TV/VIDEO, FRONT or number buttons on the remote control or TV/VIDEO or CH ▲/▼ on the TV.
- 2** Select the viewing source by using TV/VIDEO, COMP, FRONT or HDMI button on the remote control.
This TV is programmed to remember which mode it was last set to, even if you turn the TV off.
Note: See page 19 if you have not auto programmed the TV to receive channels in your local broadcast area.
- 3** When finished using the TV, press the POWER button on the remote control. The TV reverts to standby mode.



If you will be away on vacation, disconnect the power plug from the wall power outlet.

On-Screen Displays

This page describes your on-screen display and information banner options.

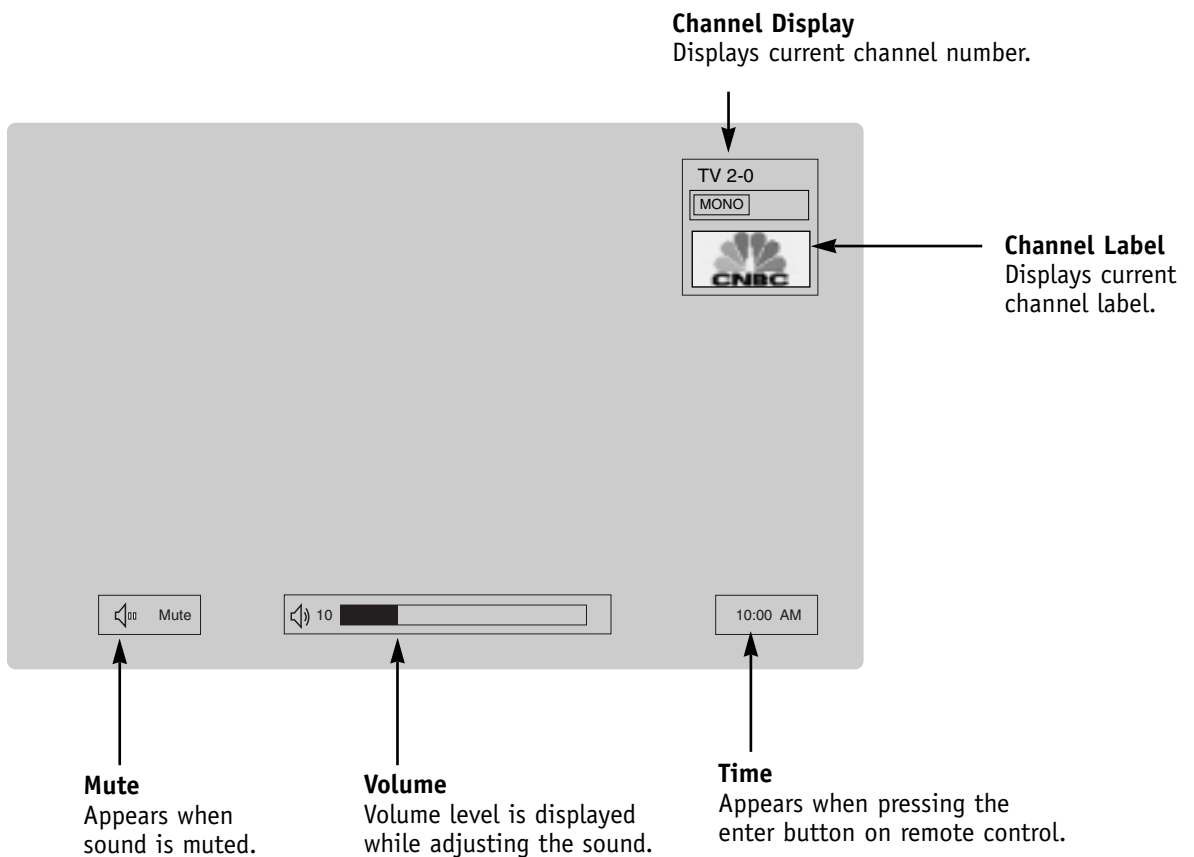

EZ Scan (Channel Search)

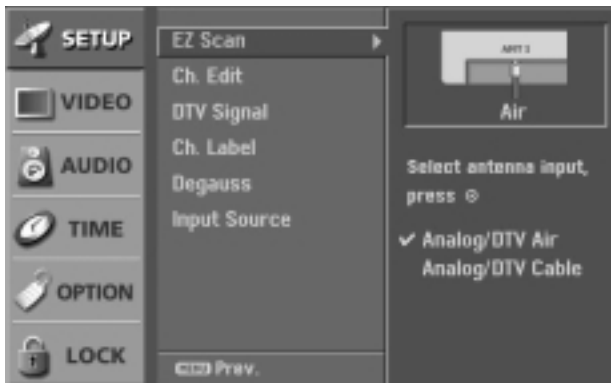

Automatically finds all channels available through antenna or cable inputs, and stores them in memory on the channel list.

- Use pages 9-14 to connect external equipment to your TV. If you have done so, plug in your TV to a standard 120V, 60Hz power outlet.

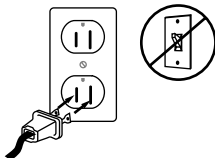

- If you have done so, remove the back of the remote and install in two AA batteries. Make sure batteries are properly installed (check the +/- symbols).

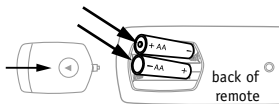

- With the remote control in hand, press the POWER button to turn your TV on.

- Press the MENU button on the remote control, then use the UP/DOWN arrow button to select the SETUP menu.

- Press the RIGHT arrow button to access the SETUP menu.

- Press ENTER button to begin the channel search. Note: Allow EZ Scan to complete the channel search cycle for Air (TV->CATV->DTV), Cable (TV->CATV->CADTV) etc.

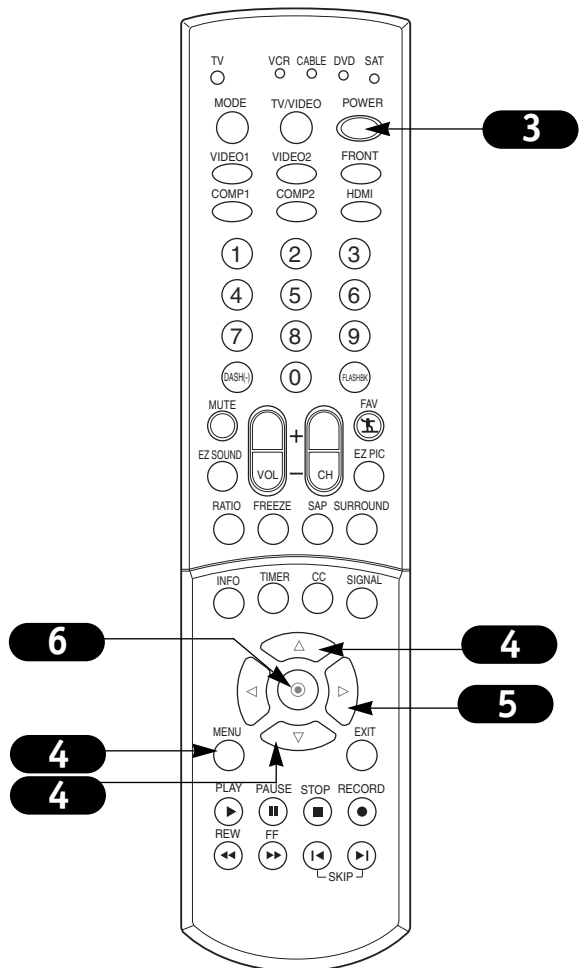

Run EZ Scan again after any Antenna/Cable connection changes.

Channel Edit

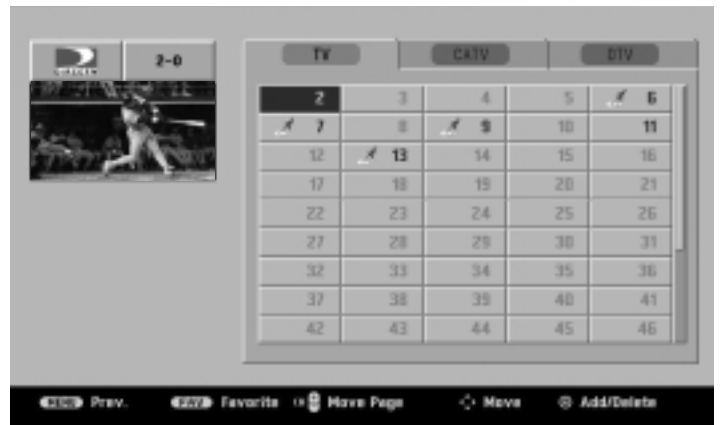
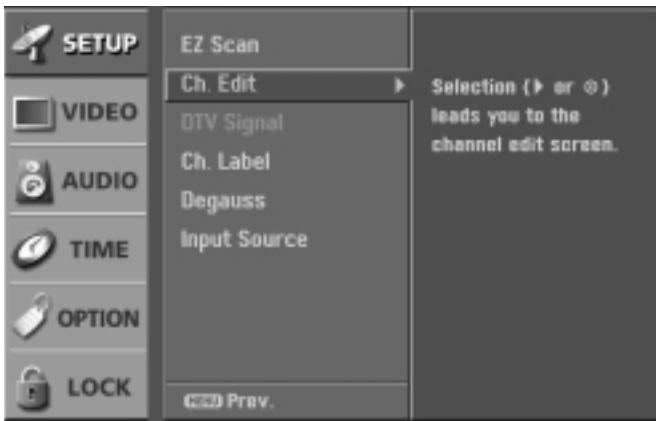

Create two different types of channel lists in memory: "Custom list" and "Favorite channel list" from the default channel list made in the EZ scan menu.

A custom list can be created by toggling each channel on or off with the Ⓞ (Enter) key. Once a channel is highlighted, you will be able to see whether the channel is currently added or deleted by referring to the small window at the top-left corner of the screen. You can create your own favorite channel list with up to 20 channels.

Use the FAV button on the remote control when a channel is highlighted, to add or delete the channel in the favorite channel list.

- 1** Press the MENU button on the remote control, then use the UP/DOWN arrow button to select the SETUP menu.
- 2** Press the RIGHT arrow button to access the SETUP menu.
- 3** Use the UP/DOWN arrow button to select Ch.Edit and then press the RIGHT arrow button.
- 4** You will now see a screen filled with channel numbers and a preview picture. Use the UP/DOWN and LEFT/RIGHT arrow button to select a channel, then use the Ⓞ button to add or delete it. Press FAV to add the channel to the Fav List.
- 5** Press EXIT button to return to TV viewing or press MENU button to return to the previous menu.



CATV is available for 1-135 channel.

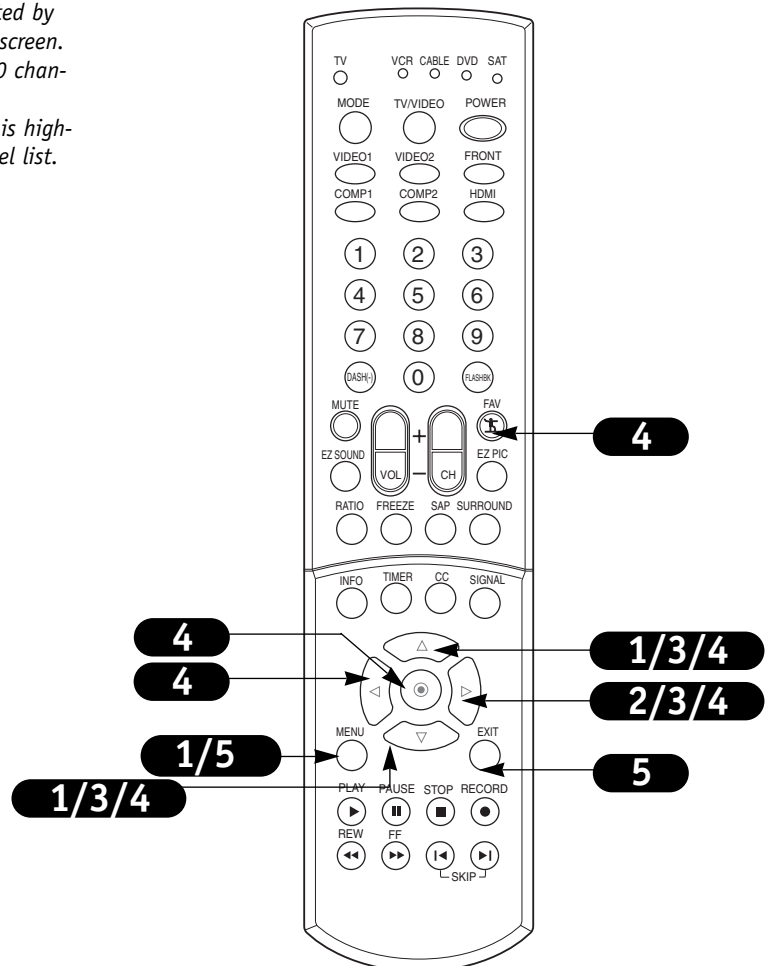

DTV Signal

Lets you know how strong your DTV signal is and whether you need to adjust your antenna or digital cable input. The higher the signal strength, the less likely you are to experience degradation.

Using the SIGNAL button

- 1 Press the SIGNAL button on the remote control.
- 2 View the on-screen signal strength monitor to see the quality of the signal being received.
- 3 Press exit button to return to TV viewing.

Using the menu

- 1 Press the MENU button on the remote control, then use the UP/DOWN arrow button to select the SETUP menu.
- 2 Press the RIGHT arrow button to access the SETUP menu.
- 3 Use the UP/DOWN arrow to select the DTV Signal. Current signal strength is shown on menu.
- 4 Press EXIT button to return to TV viewing.

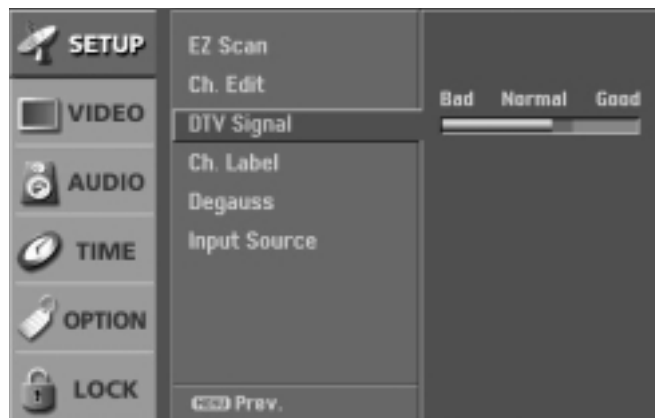

NOT all areas or programs are currently available with Digital DTV signals. Select the DTV in Input Source on the menu, to check the DTV signal.

Degaussing the Screen

The magnetic field of the earth may affect the color purity of the picture and other magnetic influences nearby may also have an affect on color purity. Even the installation direction of the TV set may affect color purity. Stripes may appear on the screen or the color may not be equal in the corners. You can restore color quality by operating the Degauss.

- 1 Press the MENU button on the remote control, then use the UP/DOWN arrow button to select the SETUP menu.
- 2 Press the RIGHT arrow button to access the SETUP menu.
- 3 Use the UP/DOWN arrow button to select Degauss, then press the RIGHT arrow button to perform the Degauss function.
- 4 Press EXIT button to return to TV viewing or press MENU button to return to the previous menu.

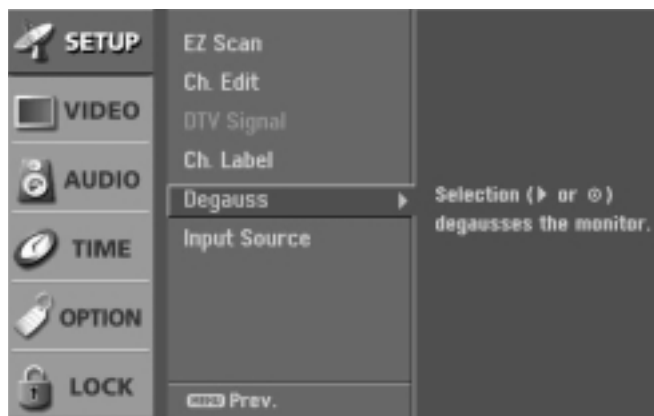

If you are unable to correct problem by degaussing, try again after about 4 minutes.

Channel Label Setup

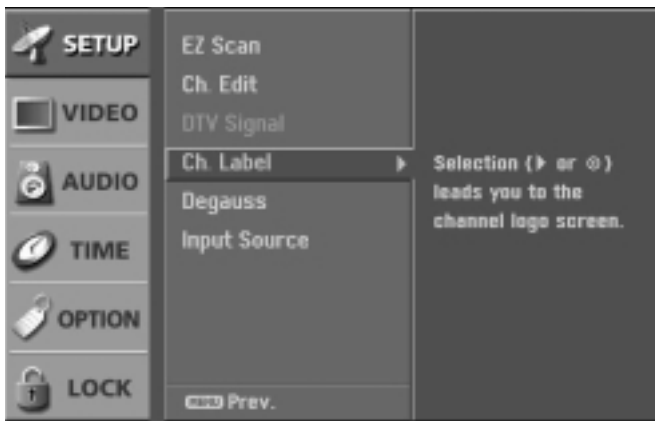

Choose preset labels for your channels.

Use Channel +/- on your remote control in the Ch Label menu to select a channel for labeling, and choose a suitable label for your channel by pressing Ⓞ to set the label to the selected channel.

- 1** Press the MENU button on the remote control, then use the UP/DOWN arrow button to select the SETUP menu.
- 2** Press the RIGHT arrow button to access the SETUP menu.
- 3** Use the UP/DOWN arrow button to select ch.Label and then press the RIGHT arrow button.
- 4** You will now see a screen filled with Labels and a preview screen. Use channel +/- button on your remote control to select the a channel to Label.
- 5** Use the UP/DOWN and LEFT/RIGHT arrows to select the appropriate label for the channel and press Ⓞ to set the Label to the selected channel.
- 6** Repeat 4 and 5 steps until all channels are Labeled.
- 7** Press EXIT button to return to TV viewing or press MENU button to return to the previous menu.



The TV displays a short name for a DTV channel even if you didn't preset a label for the channel.

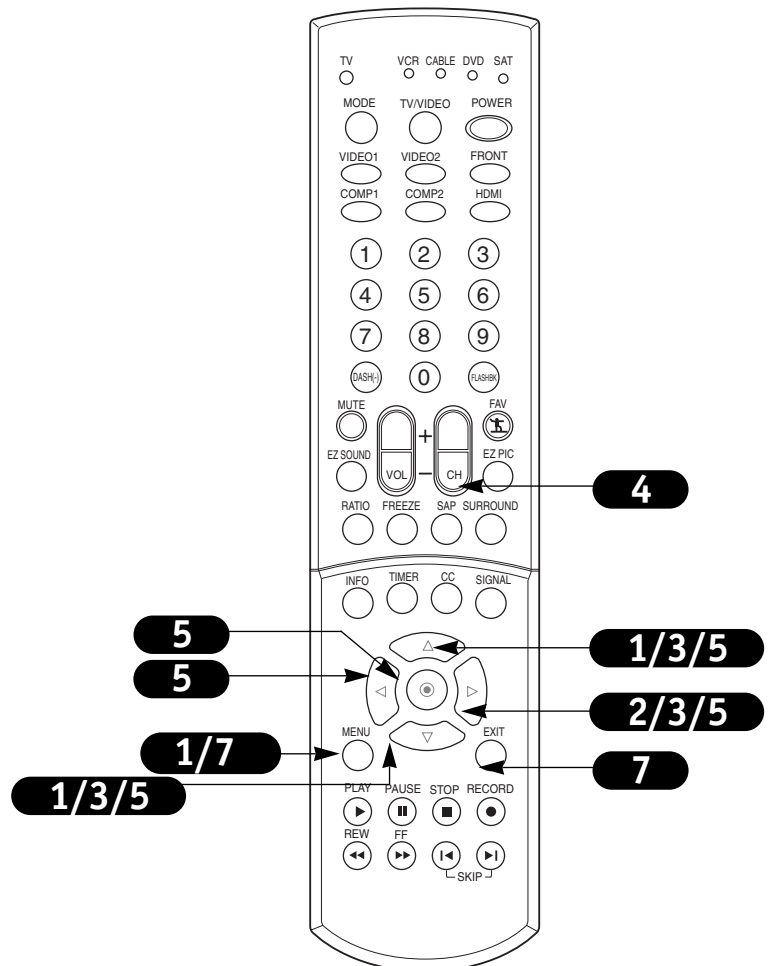

Input Source Selection

Note: Changes the picture source for the screen so you can watch your on-air TV, cable TV, VCR, DVD, or any other devices that are connected to your TV.

Using the TV/VIDEO, FRONT, COMP1-2 and HDMI button

1

Use the TV/VIDEO, FRONT, COMP1-2, and HDMI button to select the input source.

Each time you press TV/VIDEO button, you toggle between Antenna, Cable, Video1, Video 2, Video3, Front Video, Component1, Component 2, and HDMI/DVI.

Using the menu

1

Press the MENU button on the remote control, then use the UP/DOWN arrow button to select the SETUP menu.

2

Press the RIGHT arrow button to access the Setup menu.

3

Use the UP/DOWN arrow to select the Input Source option.

4

Press the RIGHT arrow to access the Input Source menu, then use the UP/DOWN arrow button to select the source. Your Main picture source options are : Antenna, Cable, Video1, Video2, Video3, Front video, Component1, Component2, and HDMI/DVI.

5

Press EXIT button to return to TV viewing or press MENU button to return to the previous menu.

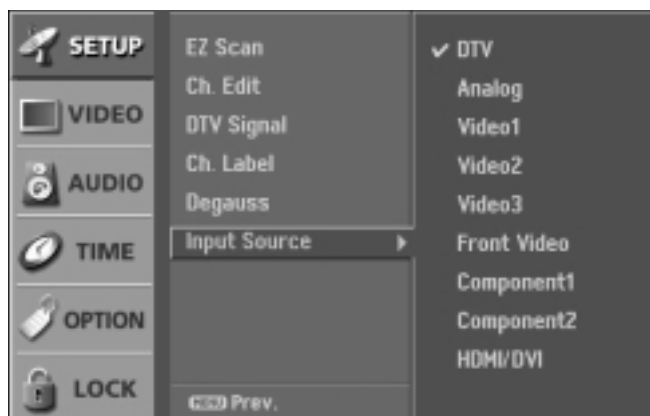

VIDEO Menu

Each video menu adjustment doesn't effect other input sources. Readjust Video menu for each input source.

EZ Picture

This function adjusts the TV to the best picture appearance. Select the preset value in the EZ Picture menu based on the program category.

Normal, Digital Preset, Night Time, Movie, Weak Signal, Video Game, and Sports are preset for good picture quality at the factory and cannot be changed.

When adjusting video options (Contrast, Brightness, Color, Sharpness, and Tint) manually, EZ Picture automatically changes to 'Off'.

Using the EZ PIC button

- 1 Use the EZ PIC button to select EZ Picture option.

Each press of the EZ PIC button change the EZ Picture option: Off, Normal, Digital Preset, Night Time, Movie, Weak Signal, Video Game, and Sports.

- 2 Press EXIT to save and return to TV viewing.

Using the menu

- 1 Press the MENU button on the remote control, then use the UP/DOWN arrow button to select the VIDEO menu.

- 2 Press the RIGHT arrow button to access the VIDEO menu.

- 3 Use the UP/DOWN arrows to select the EZ Picture option.

- 4 Press the RIGHT arrow to access the EZ Picture menu, then use the UP/DOWN arrow button to select the options: Off, Normal, Digital Preset, Night Time, Movie, Weak Signal, Video Game, and Sports.

- **Off:** Allows you to adjust the picture the way you want.
- **Normal:** Resets all the options to their preset values.
- Other options adjust the picture to the source's image.

- 5 Press EXIT button to return to TV viewing or press MENU button to return to the previous menu.

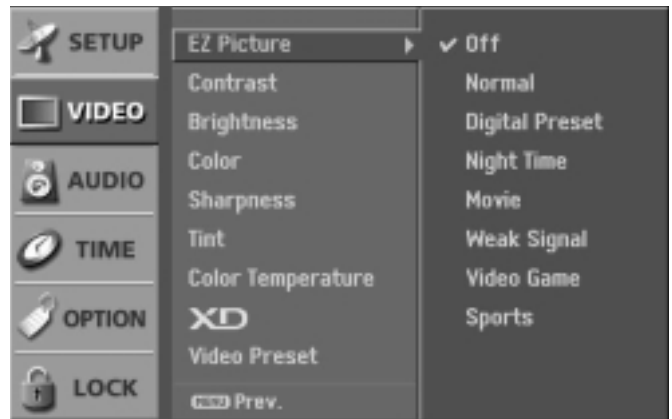

Choose the Normal option to reset the EZ picture options to their factory preset values, or use your own settings with Off.

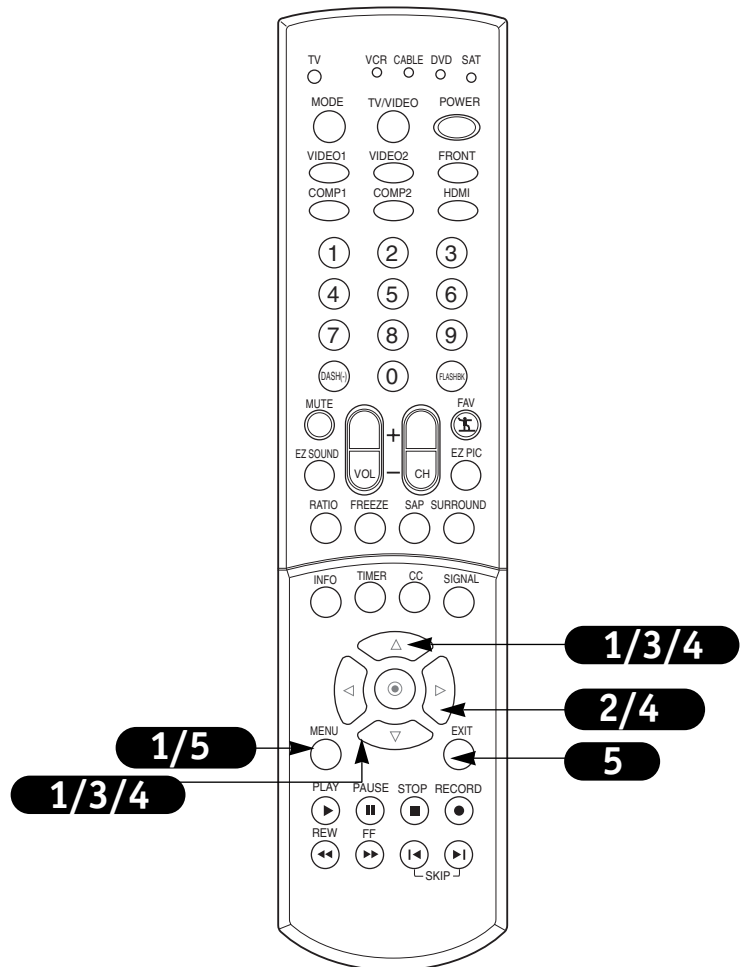

VIDEO Menu

Manual Video Control

Adjust the picture appearance to suit your preference and viewing situations.

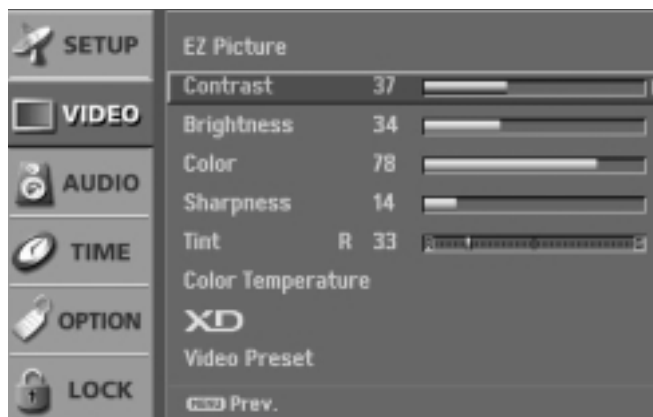

You can manually adjust the levels of picture quality settings, such as Contrast, Brightness, Sharpness, etc.

- 1** Press the MENU button on the remote control, then use the UP/DOWN arrow button to select the VIDEO menu.
- 2** Press the RIGHT arrow button to access the VIDEO menu.
- 3** Use the UP/DOWN arrow button to select one of the following options: Contrast, Brightness, Color, Sharpness, or Tint, then press the RIGHT arrow button.

- **Contrast:** Adjusts the difference between the light and dark levels of the picture.
- **Brightness:** Adjusts the white or light level of the overall picture.
- **Color:** Adjusts the intensity of all colors.
- **Sharpness:** Adjusts the level of crispness in the edges between the light and dark areas of the picture. The lower the level, the softer the image.
- **Tint:** Adjusts the balance between the red and green levels.

4 Use the LEFT/RIGHT arrow button to adjust the option to your preference. Use the UP/DOWN arrow button to select another option.

5 Press EXIT button to return to TV viewing or press MENU button to return to the previous menu.

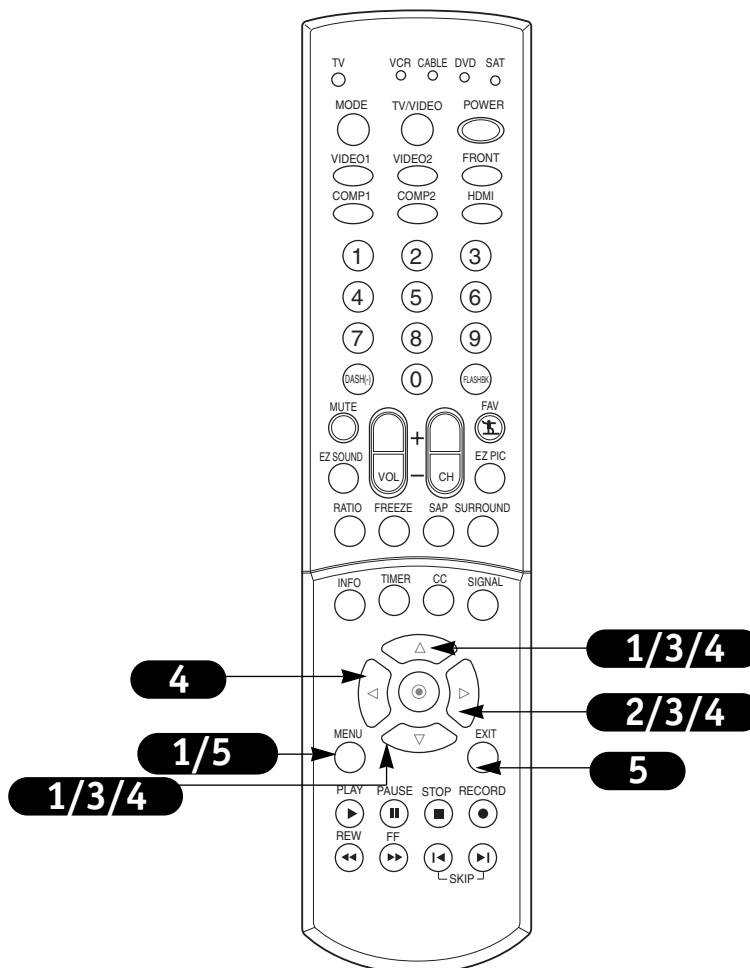

VIDEO Menu

Color Temperature

Lets you choose one of three automatic color adjustments. Set this to warm for hotter colors such as red, or set to cool for less intense colors with more blue.

- 1 Press the MENU button on the remote control, then use the UP/DOWN arrow button to select the VIDEO menu.
- 2 Press the RIGHT arrow button to access the VIDEO menu.
- 3 Use the UP/DOWN arrow button to select Color Temperature, and then press the RIGHT arrow button.
- 4 Use the UP/DOWN arrow button to select Warm, Medium, or Cool.
- 5 Press EXIT button to return to TV viewing or press MENU button to return to the previous menu.

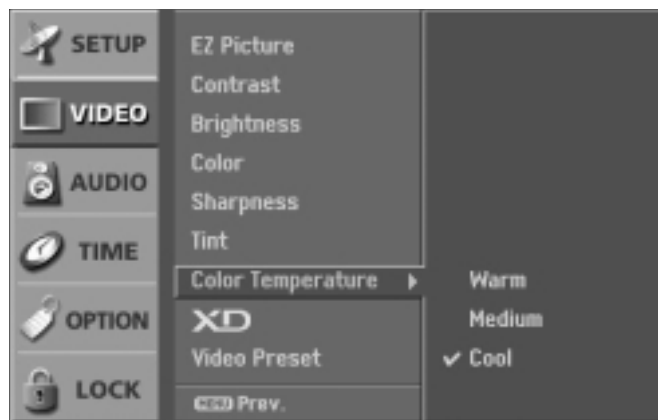

XD

- XD is LG Electronic's unique picture improving technology to display a real HD source through an advanced digital signal processing algorithm.
- When selecting EZ PIC options (Normal, Digital Preset, Night Time, Movie, Weak Signal, Video Game, and Sports), XD is automatically change to On.

- 1 Press the MENU button on the remote control, then use the UP/DOWN arrow button to select the VIDEO menu.
- 2 Press the RIGHT arrow button to access the VIDEO menu.
- 3 Use the UP/DOWN arrow button to select XD, and then press the RIGHT arrow button.
- 4 Use the UP/DOWN arrow button to select Off or On.
- 5 Press EXIT button to return to TV viewing or press MENU button to return to the previous menu.

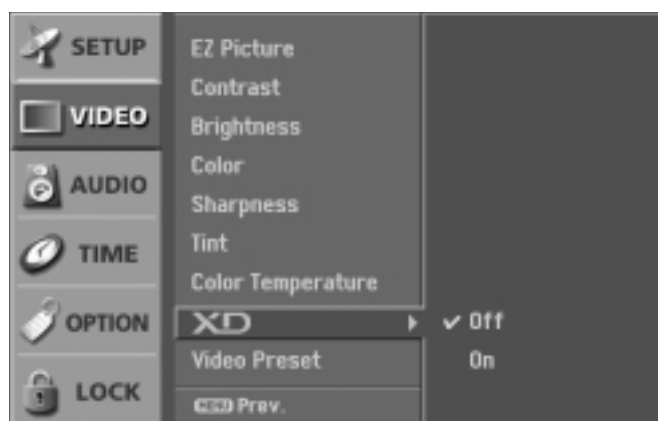

Video Preset

This is the function to quickly reset every Video menu option to their factory preset values.

- 1 Press the MENU button on the remote control, then use the UP/DOWN arrow button to select the VIDEO menu.
- 2 Press the RIGHT arrow button to access the VIDEO menu.
- 3 Use the UP/DOWN arrow button to select Video Preset.
- 4 Use the RIGHT arrow button to preset the video configuration.

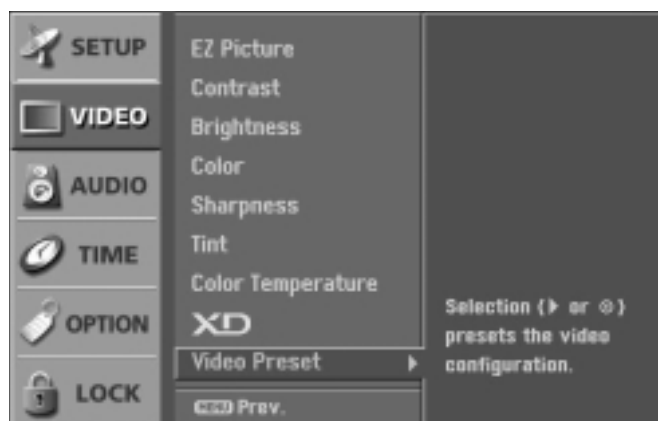

AUDIO Menu

Audio Language

Other languages may be available only if a digital signal is being sent by the broadcasting station.

- 1 Press the MENU button on the remote control, then use the UP/DOWN arrow button to select the AUDIO menu.
- 2 Press the RIGHT arrow button to access the AUDIO menu.
- 3 Use the UP/DOWN arrow button to select Audio Language, then press the RIGHT arrow button.
- 4 Use the UP/DOWN arrow button to select the language you wish.
- 5 Press EXIT button to return to TV viewing or press MENU button to return to the previous menu.



EZ SoundRite

Scans for changes in sound level during commercials, then adjusts the sound to match the current audio level. This will make sure that the volume level will be consistent whether you are watching a commercial or a regular TV program.

- 1 Press the MENU button on the remote control, then use the UP/DOWN arrow button to select the AUDIO menu.
- 2 Press the RIGHT arrow button to access the AUDIO menu.
- 3 Use the UP/DOWN arrow button to select EZ SoundRite, then press the RIGHT arrow button.
- 4 Use the UP/DOWN arrow button to select On or Off.
- 5 Press EXIT button to return to TV viewing or press MENU button to return to the previous menu.



AUDIO Menu

Stereo/SAP Broadcasts Setup

This TV can receive MTS stereo programs and any SAP (Secondary Audio Program) that accompanies the stereo program; if the station transmits an additional sound signal as well as the original one.

- 1 Use the SAP button to select your desired MTS mode in analog signal. Each time you press the SAP button, MONO, STEREO, or SAP appear in turn.
- 2 Press EXIT to save and return to TV viewing.



Stereo or SAP can be received only when the TV station transmits those signals even though you have selected STEREO or SAP.



Mono sound is automatically received if the broadcast is only in Mono; even though STEREO or SAP has been selected.



Select MONO if you want to listen to the mono sound in remote fringe areas during stereo/SAP broadcasting.

EZ Sound

Using the EZ SOUND button

- 1 Use the EZ SOUND button to select EZ Sound option.
Each press of the EZ SOUND button change the EZ Sound option: Off, Normal, Stadium, News, Music and Theater.
- 2 Press EXIT button to save and return to TV viewing.

Using the menu

- 1 Press the MENU button on the remote control, then use the UP/DOWN arrow button to select the AUDIO menu.
- 2 Press the RIGHT arrow button to access the AUDIO menu.
- 3 Use the UP/DOWN arrow to select the EZ Sound option.
- 4 Press the RIGHT arrow to access the EZ Sound menu, then use the UP/DOWN arrow button to select the options: Off, Normal, Stadium, News, Music and Theater.
 - **Off:** Allows you to adjust the sound the way you want.
 - **Normal:** Resets all the options to their preset values.
 - Other options adjust the TV's audio output to the source's sound.
- 5 Press EXIT button to return to TV viewing or press MENU button to return to the previous menu.

This function lets you enjoy the best sound without any special adjustment because the TV automatically selects the appropriate sound option based on the program content. Normal, Stadium, News, Music and Theater are preset for good sound quality at the factory and cannot be changed. When adjusting audio options (treble, bass and Front Surround) manually, EZ Sound automatically changes to Off.

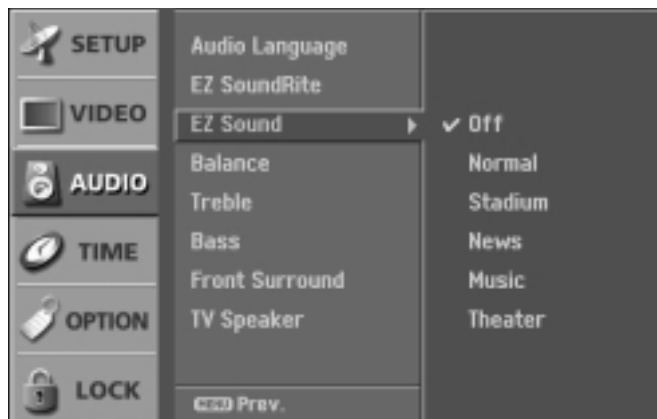

Choose the NORMAL option in EZ Sound to quickly reset the Audio Menu options to their original preset values, or use your own settings with Off.

AUDIO Menu

Manual Sound Control

Adjust the sound to suit your taste and room situations.

- 1 Press the MENU button on the remote control, then use the UP/DOWN arrow button to select the AUDIO menu.
- 2 Press the RIGHT arrow button to access the AUDIO menu.
- 3 Use the UP/DOWN arrow button to select one of the following options: Balance, Treble, or Bass, then press the Right arrow button.
 - **Balance:** Lets you adjust the left to right balance of the TV speakers.
 - **Treble:** Increases or decreases the higher frequency sounds from the TV speakers.
 - **Bass:** Increases or decreases the lower frequency sounds from the TV speakers.
- 4 Use the LEFT/RIGHT arrow button to adjust the option to your preference. Use the UP/DOWN arrow to select another option.
- 5 Press EXIT button to return to TV viewing or press MENU button to return to the previous menu.

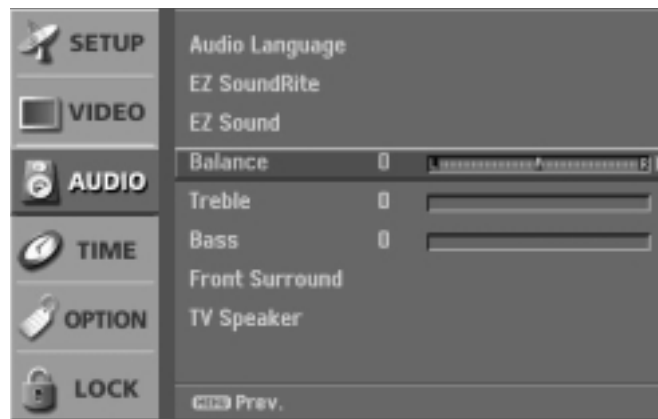

TV Speaker On/Off Setup

Turns the TV Speaker option On or Off.

- 1 Press the MENU button on the remote control, then use the UP/DOWN arrow button to select the AUDIO menu.
- 2 Press the RIGHT arrow button to access the AUDIO menu.
- 3 Use the UP/DOWN arrow button to select TV Speaker, then press the RIGHT arrow button.
- 4 Use the UP/DOWN arrow button to select On or Off.
- 5 Press EXIT button to return to TV viewing or press MENU button to return to the previous menu.

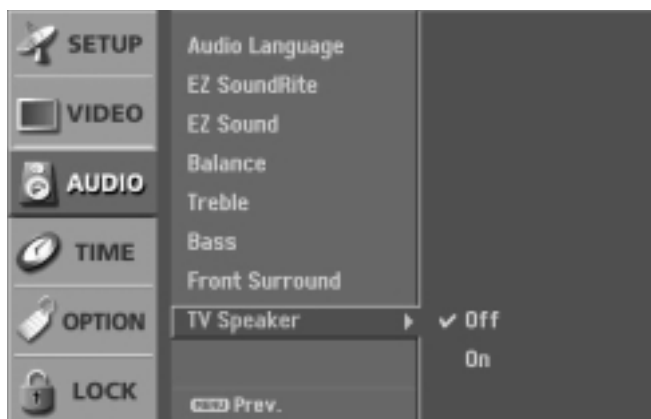

AUDIO Menu



is a trademark of SRS Labs, Inc.

TruSurround XT technology is incorporated under license from SRS Labs, Inc.

Manufactured under license from Dolby Laboratories. "Dolby" and the double-D symbol are trademarks of Dolby Laboratories.

Front Surround

Using the SURROUND button

1

Use the SURROUND button to select Front Surround option.

Each press of the SURROUND button change the Front Surround option: Off, 3D EchoSound System or SRS (Sound Retrieval System) TruSurround XT.

2

Press EXIT to save and return to TV viewing.

Using the menu

1

Press the MENU button on the remote control, then use the UP/DOWN arrow button to select the AUDIO menu.

2

Press the RIGHT arrow button to access the AUDIO menu.

3

Use the UP/DOWN arrow button to select Front Surround, then press the RIGHT arrow button.

4

Use the UP/DOWN arrow button to select Off, 3D EchoSound System or SRS (Sound Retrieval System) TruSurround XT.

5

Press EXIT button to return to TV viewing or press MENU button to return to the previous menu.

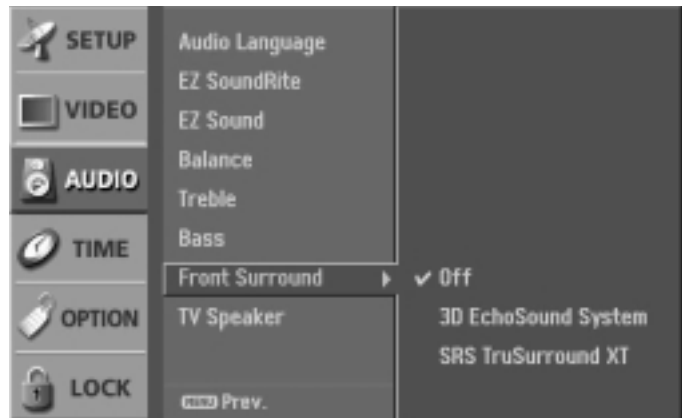

Mini glossary

SRS TruSurround XT

Takes advantage of any multi-channel format without needing to add extra speakers or equipment. Dialog clarity, bass enrichment and the addition of stereo audio enhancement that produces an immersive sound experience from standard stereo material.

3D EchoSound System

Creates a stunning simulated stereo effects from any mono sound and a realistic three-dimensional sound with a very wide and deep sound stage into stereo sound.

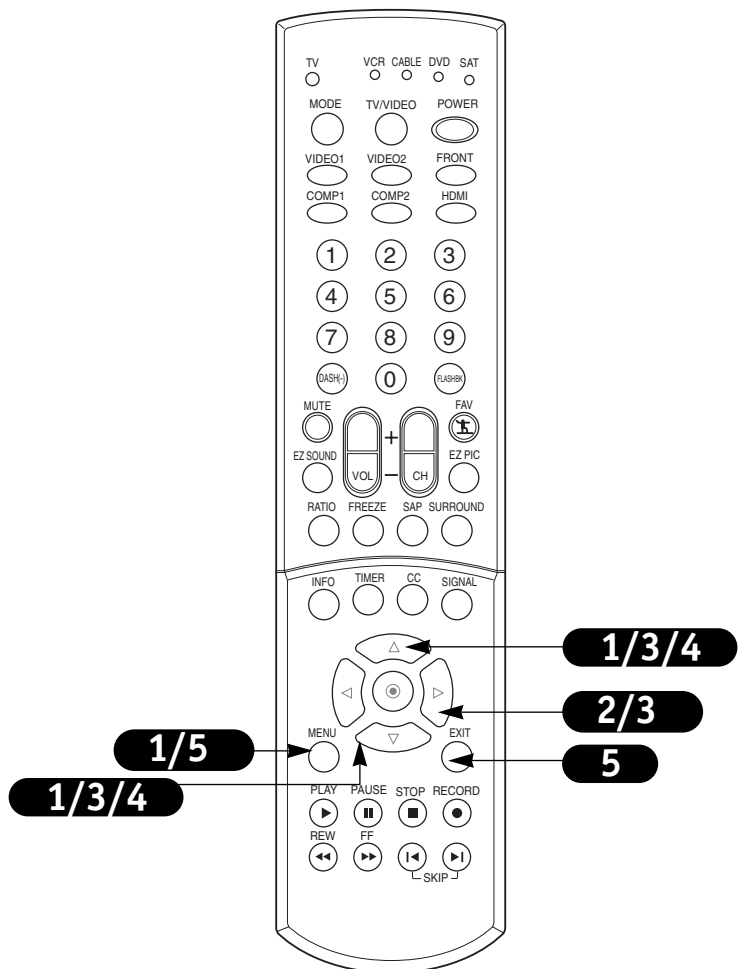

Auto Clock Setup

Sets the time automatically through the digital channel signal.

The digital channel signal includes information for the current time provided by the broadcasting station.

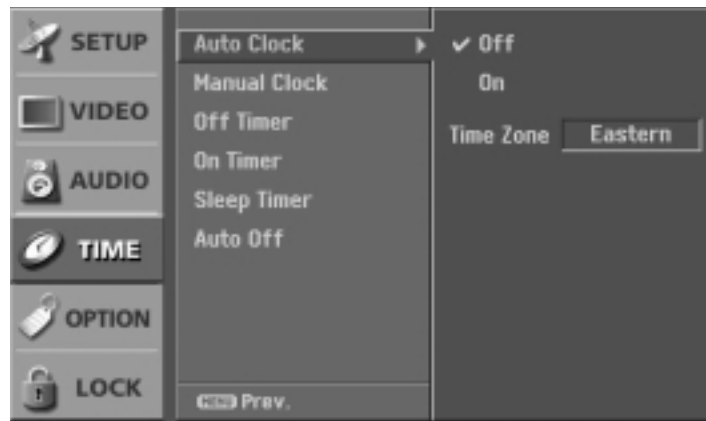

1 Press the MENU button on the remote control, then use the UP/DOWN arrow button to select the TIME menu option.

2 Press the RIGHT arrow button to go to the TIME menu.

3 Use the UP/DOWN arrow button to choose Auto Clock, then press the RIGHT arrow button.

4 Use the UP/DOWN arrow button to choose On, then use the RIGHT arrow button to select Time Zone.

5 Use the UP/DOWN arrow button to adjust Time Zone.

- Select the time zone for your viewing area. Your options are: Eastern, Central, Mountain, Pacific, Alaska, Hawaii.

6 Press EXIT button to return to TV viewing or press MENU button to return to the previous menu.



Set the clock manually again if the current time is incorrect with auto clock function.

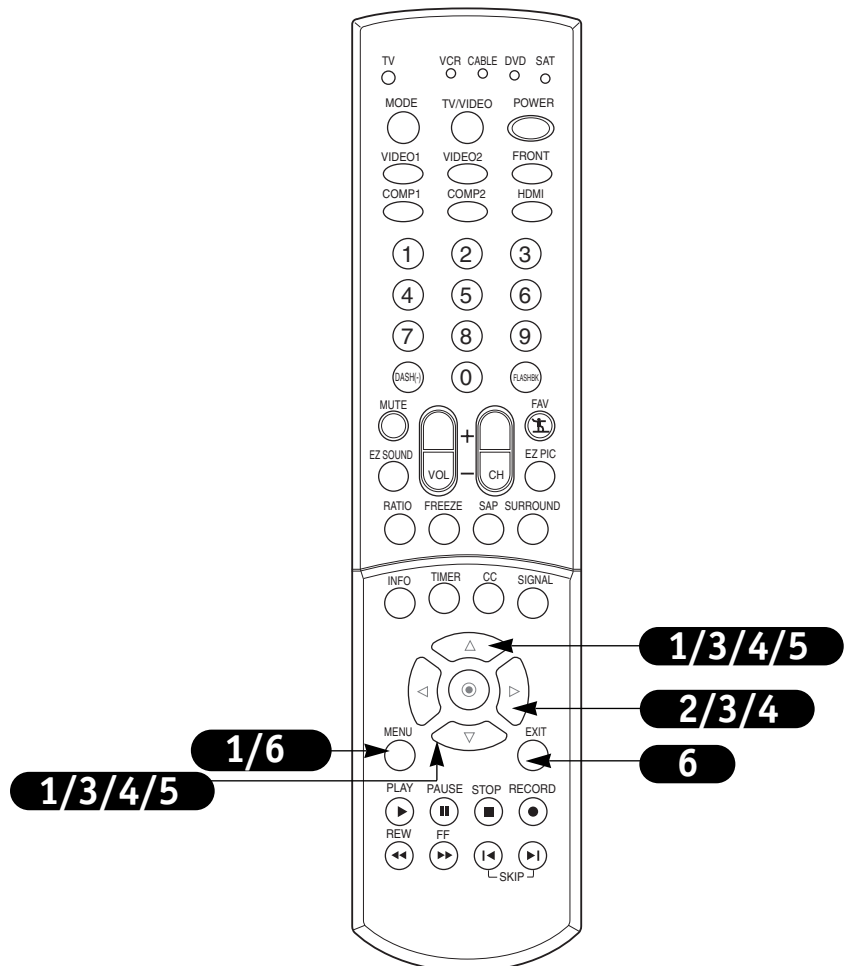

Manual Clock Setup

If current time setting is erased by a power failure or if TV is unplugged, reset the clock.

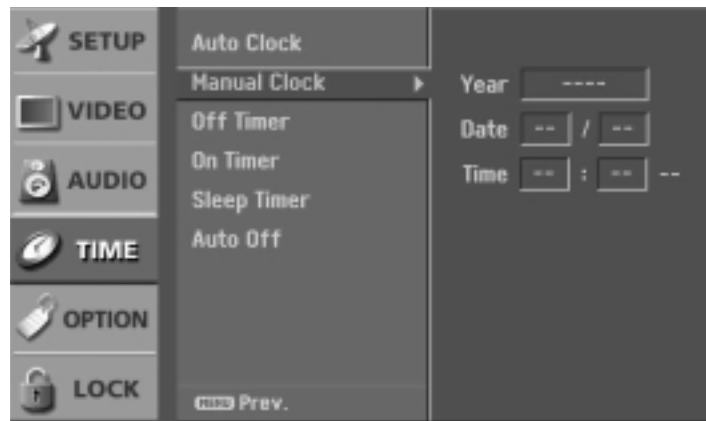

- 1** Press the MENU button on the remote control, then use the UP/DOWN arrow button to select the TIME menu option.
- 2** Press the RIGHT arrow button to activate the Time menu.
- 3** Use the UP/DOWN arrow button to choose Manual Clock, then press the RIGHT arrow button.
- 4** Use the LEFT/RIGHT arrow button to select either the year, date or time option. Once selected, use the UP/DOWN arrow button to set the year, date or time option.
- 5** Press EXIT button to return to TV viewing or press MENU button to return to the previous menu.

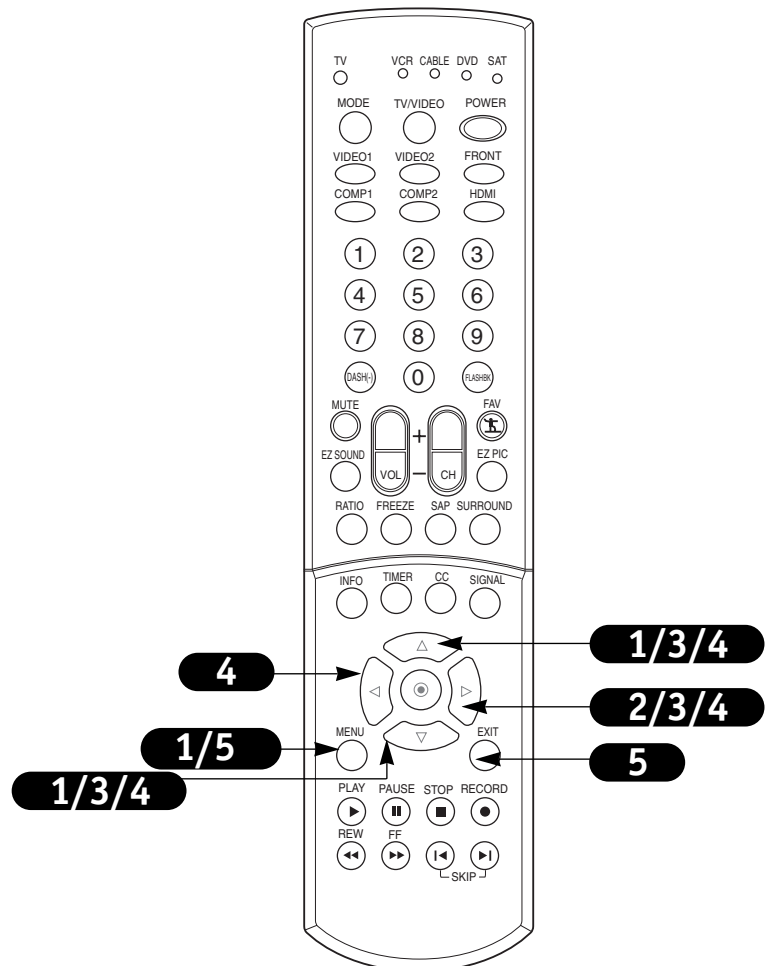

TV Turn Off Time Setup

Lets you set an automatic daily turn off time for your TV.

Off Timer function overrides On Timer function if they are both set to the same time.

You must set the current time on the clock before using on/off timers.

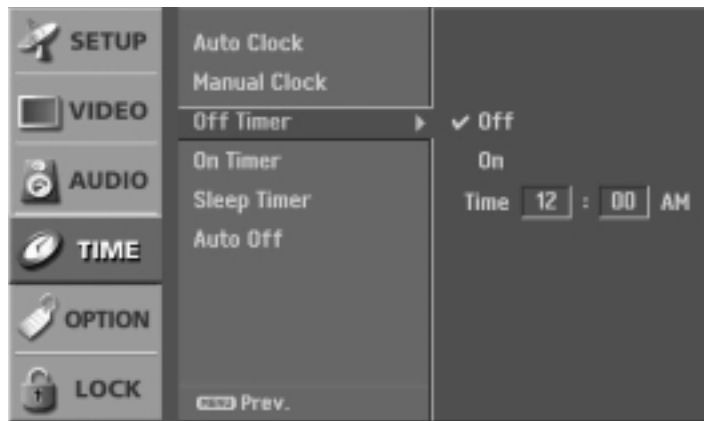

- 1** Press the MENU button on the remote control, then use the UP/DOWN arrow button to select the TIME menu.
- 2** Press the RIGHT arrow button to go to the TIME menu.
- 3** Use the UP/DOWN arrow button to choose Off Timer, then press the RIGHT.
- 4** Use the UP/DOWN arrow button to choose On, then press the RIGHT arrow button.
- 5** Use the LEFT/RIGHT arrow button to select the hour or minutes options, then use the UP/DOWN arrow button to set the hours or minutes.
- 6** Press EXIT button to return to TV viewing or press MENU button to return to the previous menu.



To cancel Off Timer function, use the UP/DOWN arrow button to select Off in step 4.

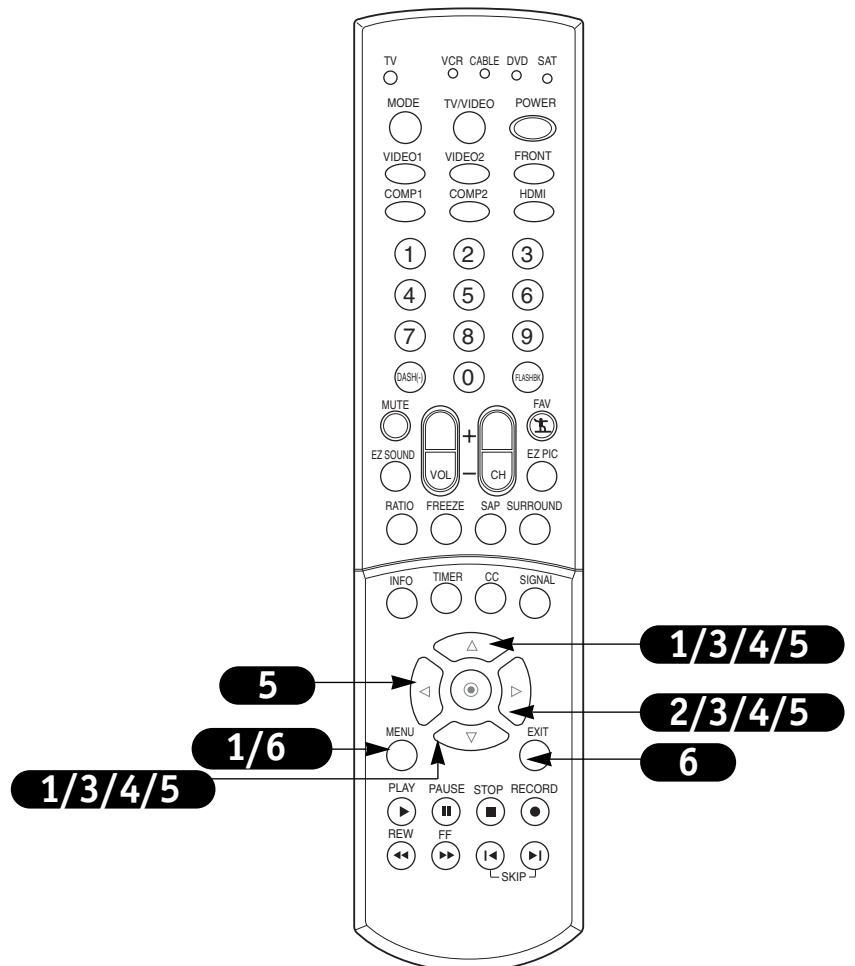

TV Turn On Time Setup

Lets you set an automatic daily turn on time for your TV.

Off timer function overrides on timer function if they are both set to the same time.

Unless a button is pressed within two hours after the TV is turned on by the On Timer function, the TV will automatically turn off.

TV must be in standby mode for the On Timer to work.

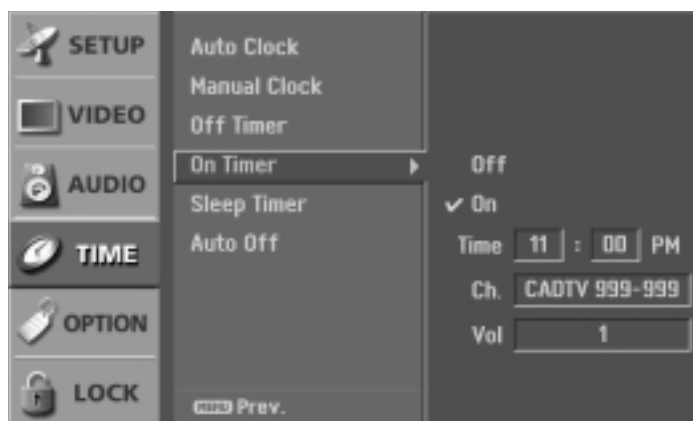

- 1** Press the MENU button on the remote control, then use the UP/DOWN arrow button to select the TIME menu.
- 2** Press the RIGHT arrow button to activate the TIME menu.
- 3** Use the UP/DOWN arrow button to choose On Timer, then press the RIGHT arrow button.
- 4** Use the UP/DOWN arrow to choose On, then press the RIGHT arrow button.
- 5** Use the LEFT/RIGHT arrow button to select either Time, Channel, or Volume. Once selected, use the UP/DOWN arrow button to set either the Time, Channel, or Volume options.
- 6** Press EXIT button to return to TV viewing or press MENU button to return to the previous menu.



To cancel On Timer function, use the UP/DOWN arrow button to select Off in step 4.

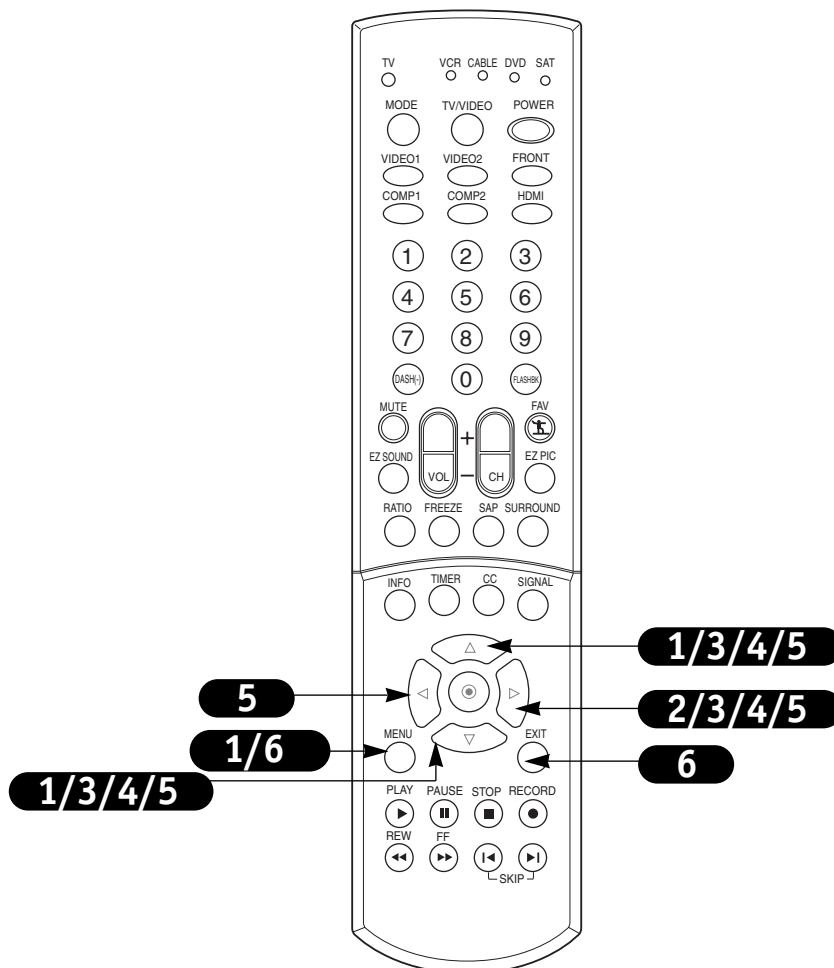

Sleep Timer Setup

Lets you select the amount of time if you want your TV to turns itself off, automatically.

Using the TIMER button

- 1 Press the TIMER button on the remote control repeatedly to select the number of minutes.

First the Off option will appear on the screen, followed in sequence 10, 20, 30, 60, 90, 120, 180, and 240. The timer begins to count down from the number of minutes selected.

- 2 Press EXIT button to save and return to TV viewing

Using the menu

- 1 Press the MENU button on the remote control, then use the UP/DOWN arrow button to select the TIME menu.
- 2 Press the RIGHT arrow button to go to the Time menu.
- 3 Use the UP/DOWN arrow button to choose Sleep Timer then press the RIGHT arrow button.
- 4 Use the UP/DOWN arrow to choose a pre-set turn off time.
- 5 Press EXIT button to return to TV viewing or press MENU button to return to the previous menu.



When the sleep time you want is displayed on the screen, don't press the timer button again.



To check the remaining sleep time, press the TIMER button once.



To change sleep time setting, press the TIMER button repeatedly to select time setting you want.



If you turn the TV off after setting the sleep timer, the setting will be erased.

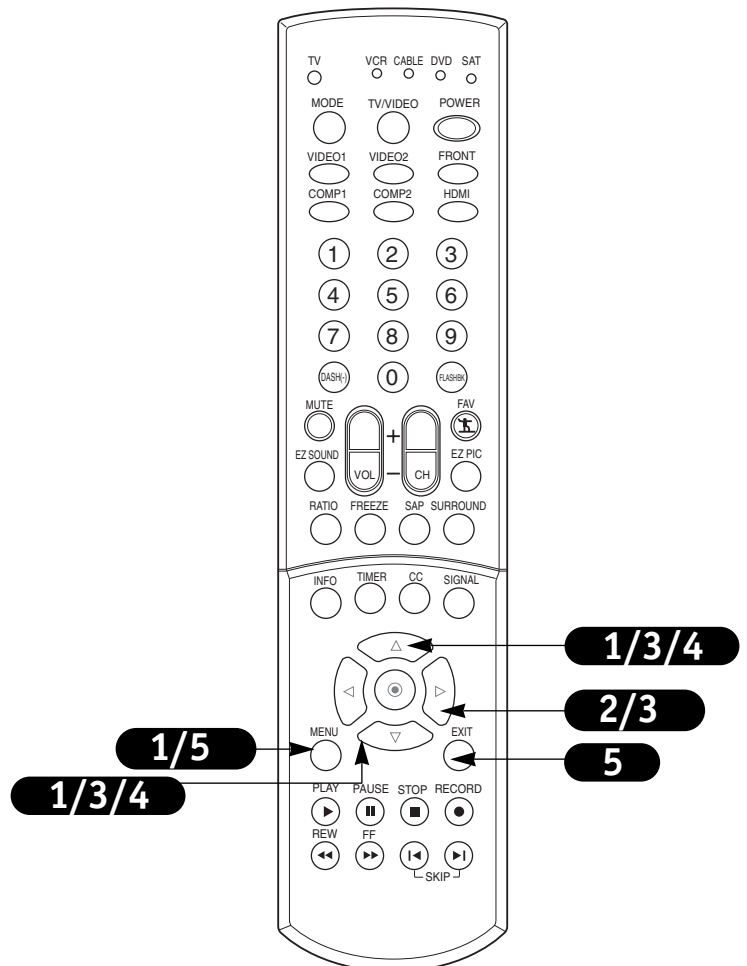
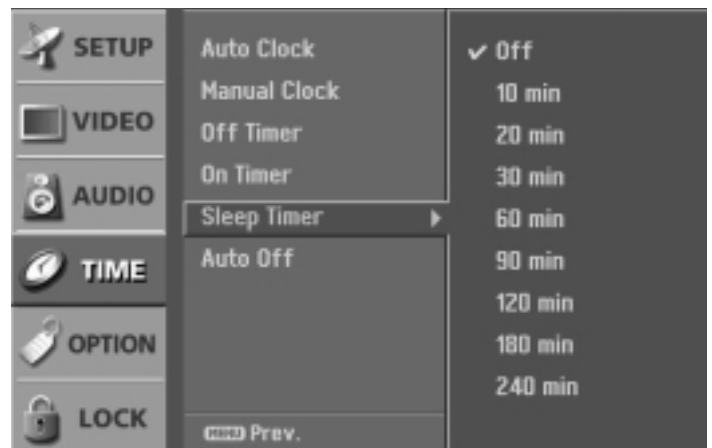

Auto Off

If there is no input signal, the TV can be set up to switch to standby mode automatically after 10 minutes.

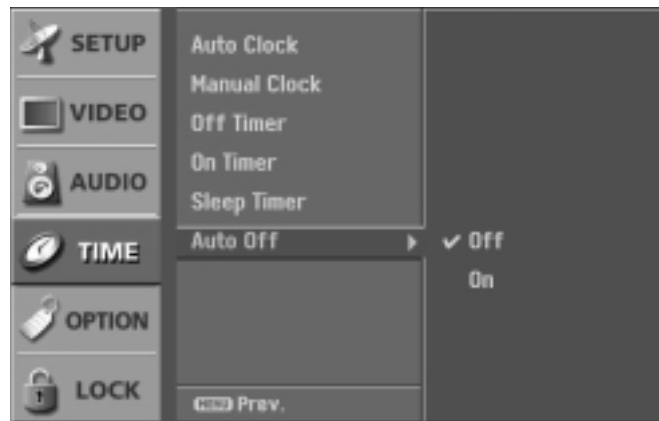

- 1** Press the MENU button on the remote control, then use the UP/DOWN arrow button to select the TIME menu.
- 2** Press the RIGHT arrow button to go to the TIME menu.
- 3** Use the UP/DOWN arrow button to choose Auto Off then press the RIGHT arrow.
- 4** Use the UP/DOWN arrows to choose On or Off.
- 5** Press EXIT button to return to TV viewing or press MENU button to return to the previous menu.

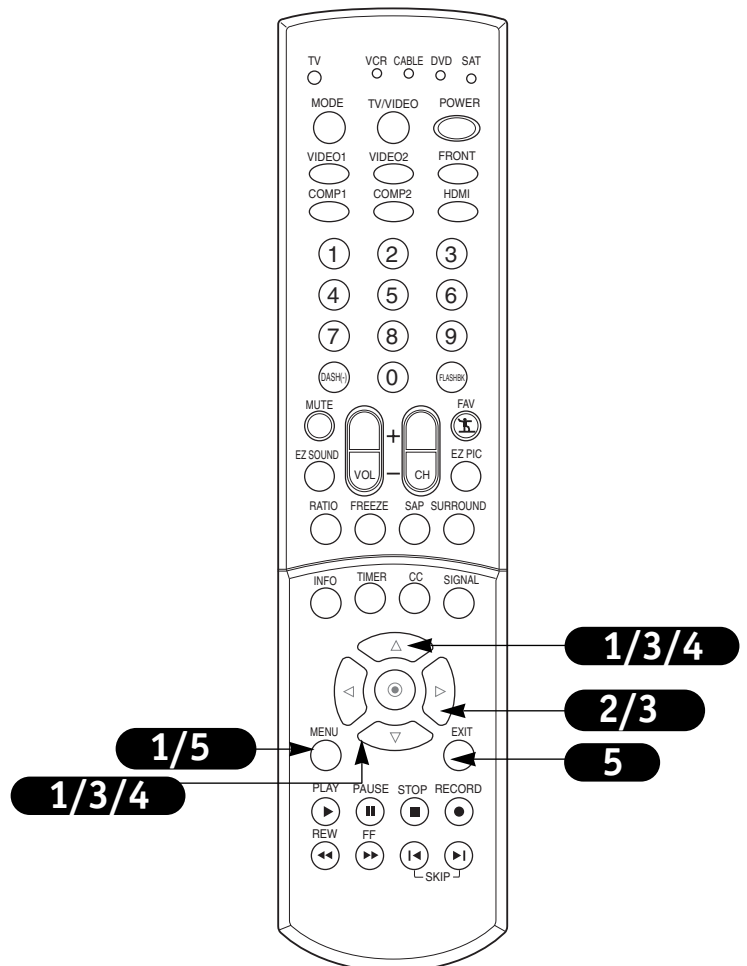

Aspect Ratio Control

Lets you choose the way that an analog picture with a 4:3 aspect ratio is displayed on your TV with a 16:9 ratio. When you receive an analog picture with a 4:3 aspect ratio on your 16:9 TV, you need to specify how the picture is to be displayed according to your preference.

Using the RATIO button

1 Use the RATIO button to select the desired picture format.

Each press of the RATIO button changes the picture format. Your options are: Set By Program, 4:3, 16:9, Horizon, Zoom1, Zoom2, and Cinema Zoom.

2 Press EXIT to save and return to TV viewing.

Using the menu

1 Press the MENU button on the remote control, then use the UP/DOWN arrow button to select the OPTION menu.

2 Press the RIGHT arrow button to go to the OPTION menu.

3 Use the UP/DOWN arrow to choose the Aspect Ratio option, then press the RIGHT arrow button.

4 Use the UP/DOWN arrow button to select the desired picture format.

- Use the UP/DOWN arrow button to adjust the enlarge proportion of Cinema Zoom. The adjustment of range is 1~16.

5 Press EXIT button to return to TV viewing or press MENU button to return to the previous menu.



When you receive a picture with a 16:9 aspect ratio, you can't specify horizon aspect ratio.

If you select a horizon during receiving a 4:3 aspect ratio, 16:9 aspect ratio is worked as set by program.

Mini glossary

Set By Program	Select the proper picture proportion to match the source's image. (4:3 → 4:3, 16:9 → 16:9)
4:3	Choose when you want to view a picture with an original 4:3 aspect ratio, with black bars appearing at both the left and right sides.
16:9	Choose when you want to adjust the picture horizontally, in a linear proportion to fill the entire screen.
Horizon	Choose when you want to adjust the picture in a non-linear proportion, that is, more enlarged at both sides, to create a spectacular view.
Zoom1	Choose when you want to view the picture without any alteration. However, the top and bottom portions of the picture will be cropped.
Zoom2	Choose when you want the picture to be altered, both vertically extended and vertically cropped. The picture taking a halfway trade off between alteration and screen coverage.
Cinema Zoom	Choose when you want to enlarge the picture in correct proportion. When enlarging or reducing the picture, the image may become distorted.

Captions

Select a caption mode for displaying captioning information when provided on the program.

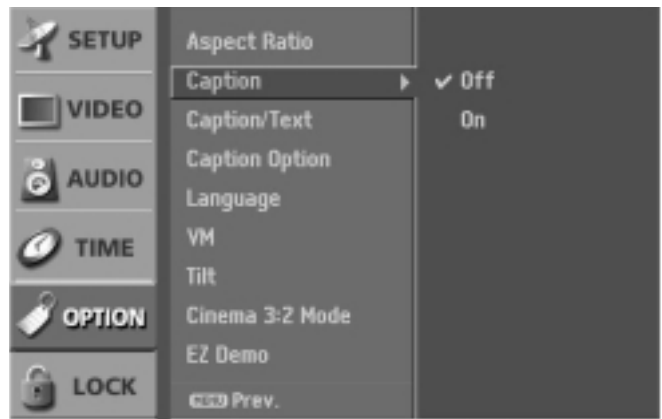

This TV is programmed to remember the caption mode it was last set to, when you turn the POWER off.

- 1** Press the MENU button on the remote control, then use the UP/DOWN arrow button to select the OPTION menu.
- 2** Press the RIGHT arrow button to activate the OPTION menu.
- 3** Use the UP/DOWN arrow button to choose Caption, then press the Right arrow button.
- 4** Use the UP/DOWN arrow to choose On or Off.
- 5** Press EXIT button to return to TV viewing or press MENU button to return to the previous menu.

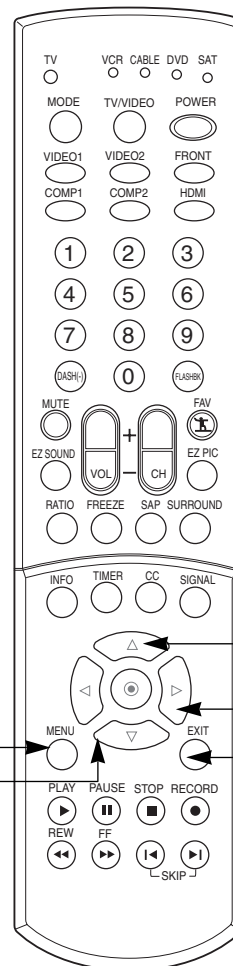

1/3/4
2/3
5

Mini glossary

CAPTIONS The term for the words that scroll across the bottom of the TV screen; usually the audio portion of the program provided for the hearing impaired.

TEXT The term for the words that appear in a large black frame and almost cover the entire screen; usually messages provided by the broadcaster.

Captions/Text

Analog caption displays information at any position on the screen usually the program's dialog. Text displays information, usually at the bottom position and is used for a data service, generally not program related.

Caption/Text, if provided by the broadcaster, would be available for both digital and analog channels on the Antenna/Cable source.

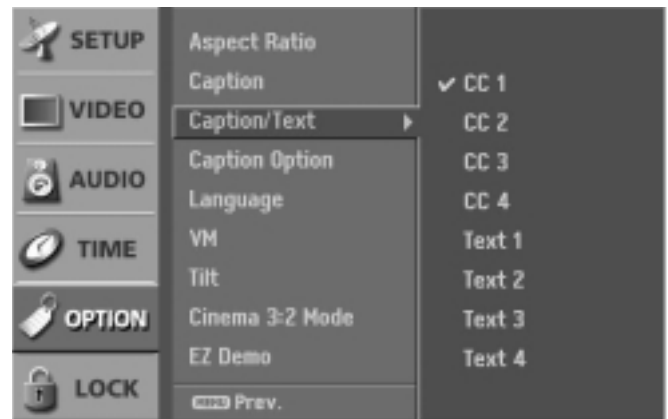

Using the CC button

1 Use the CC button to select caption.

Each press of the CC button changes the caption option; Off, CC1, CC 2, CC 3, CC 4, Text 1, Text 2, Text 3, or Text 4.

2 Press EXIT to save and return to TV viewing.

Using the menu

1 Press the MENU button on the remote control, then use the UP/DOWN arrow button to select the OPTION menu.

2 Press the RIGHT arrow button to activate the OPTION menu.

3 Use the UP/DOWN arrow button to choose Caption/Text, then press the Right arrow button.

4 Use the UP/DOWN arrow button to make your caption selection. Your choices are: CC1, CC 2, CC 3, CC 4, Text 1, Text 2, Text 3, or Text 4.

5 Press EXIT button to return to TV viewing or press MENU button to return to the previous menu.

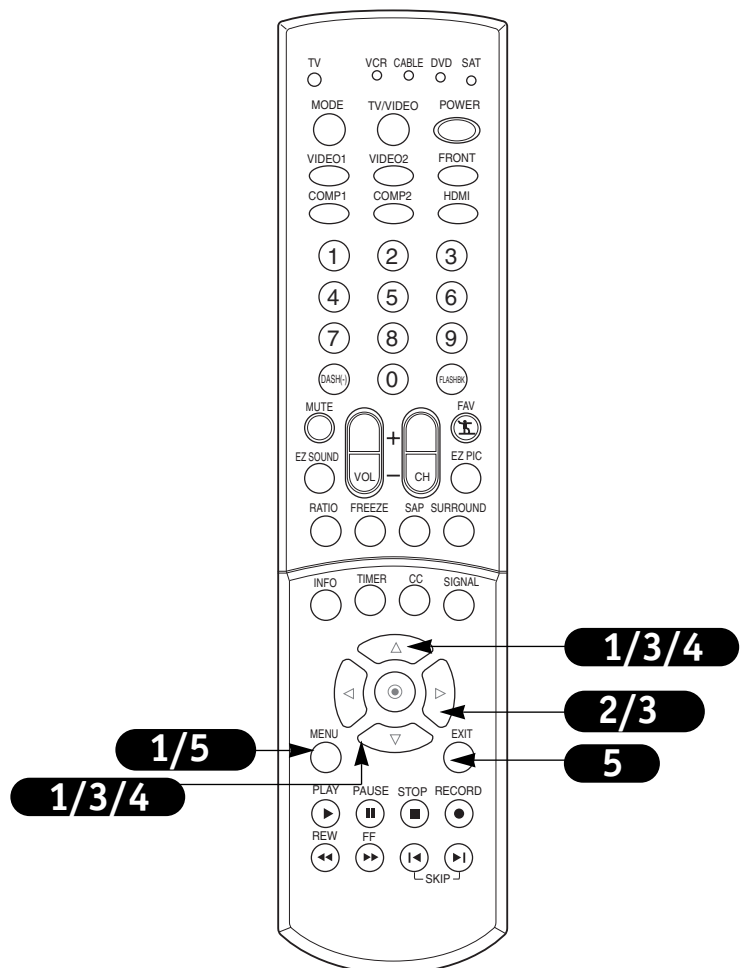

Caption Option Menu

Customize the DTV/CADTV captions that will appear on your screen.

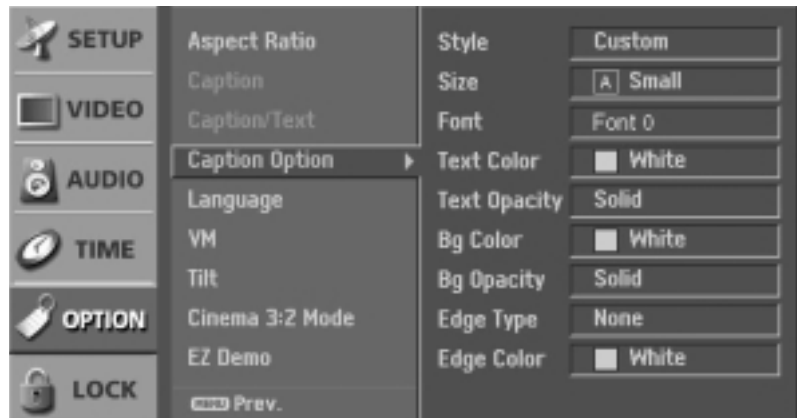

1

Press the MENU button on the remote control, then use the UP/DOWN arrow button to select the OPTION menu.

2

Press the RIGHT arrow button to access the OPTION menu.

3

Use the UP/DOWN arrow to select the Caption Option, then press the RIGHT arrow button.

4

Use the LEFT/RIGHT arrow button to select Custom.

5

Use UP/DOWN arrow button to customize the Style, Font, etc., to your preference. Your Caption options are:

- **Size:** Set the size the words will appear in.
- **Font:** Select a typeface for the words.
- **Text Color:** Choose a color for the text.
- **Text Opacity:** Specify the opacity for the text color.
- **Bg (Background) Color:** Select a background color.
- **Bg (Background) Opacity:** Select the opacity for the background color.
- **Edge Type:** Select an edge type.
- **Edge Color:** Select a color for the edges.

6

Press EXIT button to return to TV viewing or press MENU button to return to the previous menu.



A preview icon is provided at the bottom of the screen, use it to see the caption language.

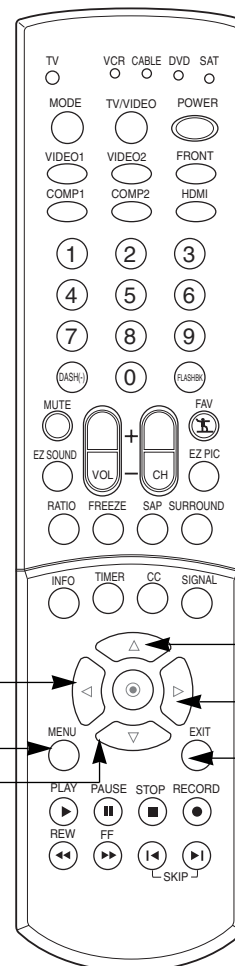

On-Screen Menu Languages

Select your preferred language for the menus: English, Español (Spanish), or Français (French).

- 1** Press the MENU button on the remote control, then use the UP/DOWN arrow button to select the OPTION menu.
- 2** Press the RIGHT arrow button to go to the OPTION menu.
- 3** Use the UP/DOWN arrow to choose the Language, then press the RIGHT arrow button.
- 4** Use the UP/DOWN arrow button to select the language you want the on screen menus to appear in.
- 5** Press EXIT button to return to TV viewing or press MENU button to return to the previous menu.

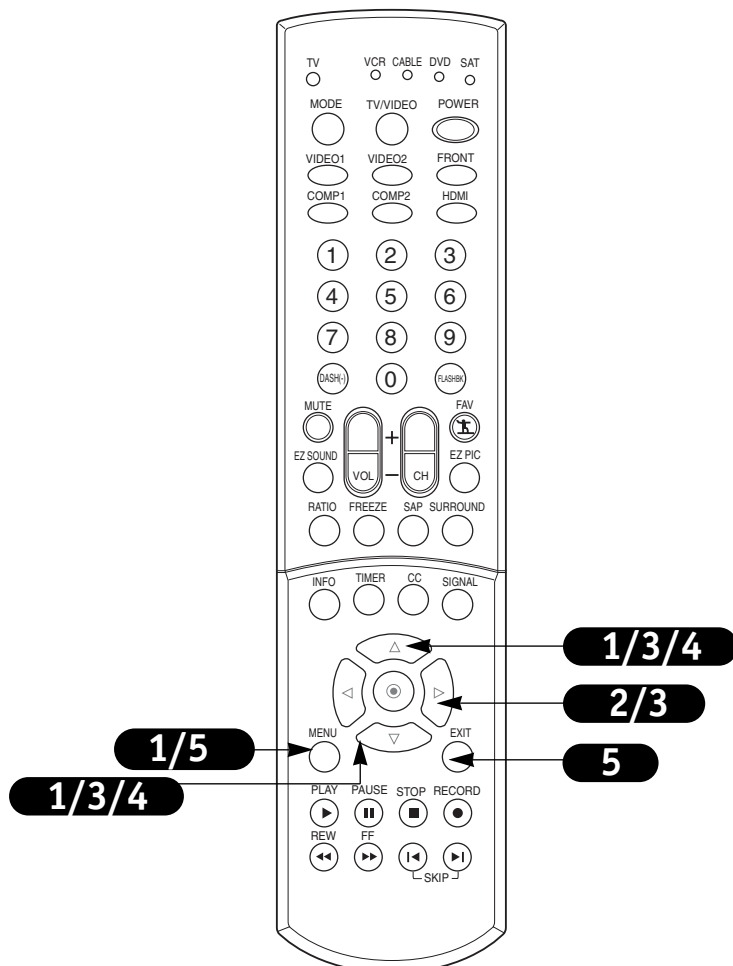
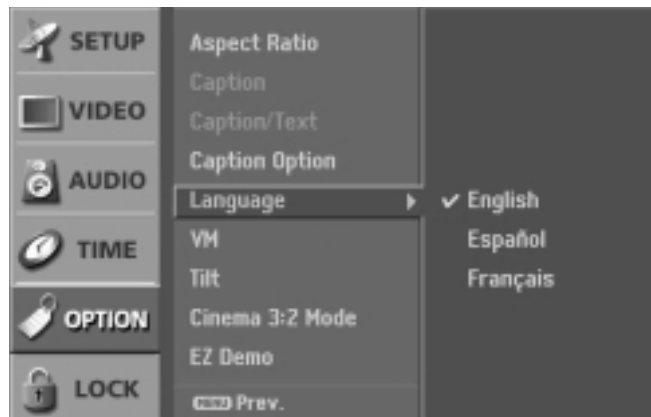

Velocity Modulation

Use this function to improve the outline distinction of the picture's edges.

If you select VM 'Off', the TV will automatically return the pictures' edge appearance to factory settings.

- 1 Press the MENU button on the remote control, then use the UP/DOWN arrow button to select the OPTION menu.
- 2 Press the RIGHT arrow button to access the OPTION menu.
- 3 Use the UP/DOWN arrow button to select VM, and then press the RIGHT arrow button.
- 4 Use the UP/DOWN arrow button to select Off, Low, or High.
- 5 Press EXIT button to return to TV viewing or press MENU button to return to the previous menu.

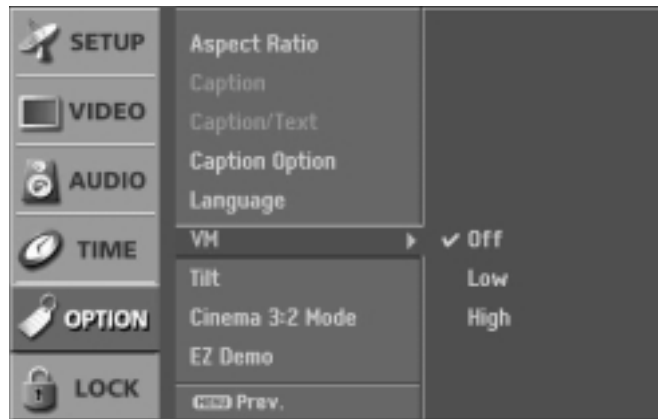

Tilt

The picture on the TV screen may be tilted to the left or right if the set is moved to a different place or direction. Picture Tilt should be used to correct any tilt.

- 1 Press the MENU button on the remote control, then use the UP/DOWN arrow button to select the OPTION menu.
- 2 Press the RIGHT arrow button to access the Option menu.
- 3 Use the UP/DOWN arrow button to select Tilt, then, use the LEFT/RIGHT arrow button to adjust and correct any Tilt.
- 4 Press EXIT button to return to TV viewing or press MENU button to return to the previous menu.



Cinema 3:2 Mode Setup

Most movies are 24 frames/sec, but TV signal is 30 frames/sec. This option lets the TV do 3:2 pull-down operation for you to watch movies at the best motion appearance.

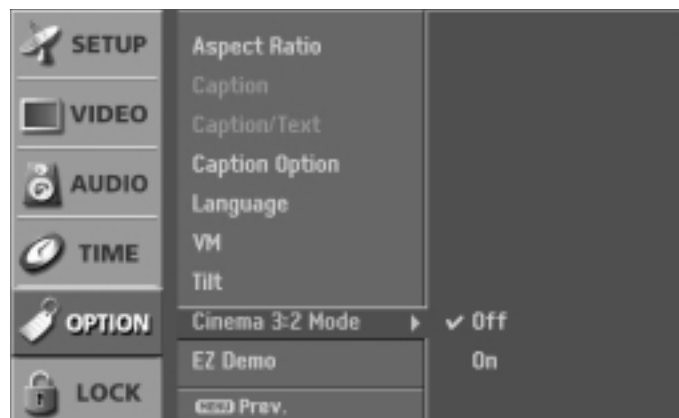

- 1** Press the MENU button on the remote control, then use the UP/DOWN arrow button to select the OPTION menu.
- 2** Press the RIGHT arrow button to access the OPTION menu.
- 3** Use the UP/DOWN arrow to choose Cinema 3:2 Mode, then press the Right arrow button.
- 4** Use the UP/DOWN arrow to choose On or Off.
- 5** Press EXIT button to return to TV viewing or press MENU button to return to the previous menu.

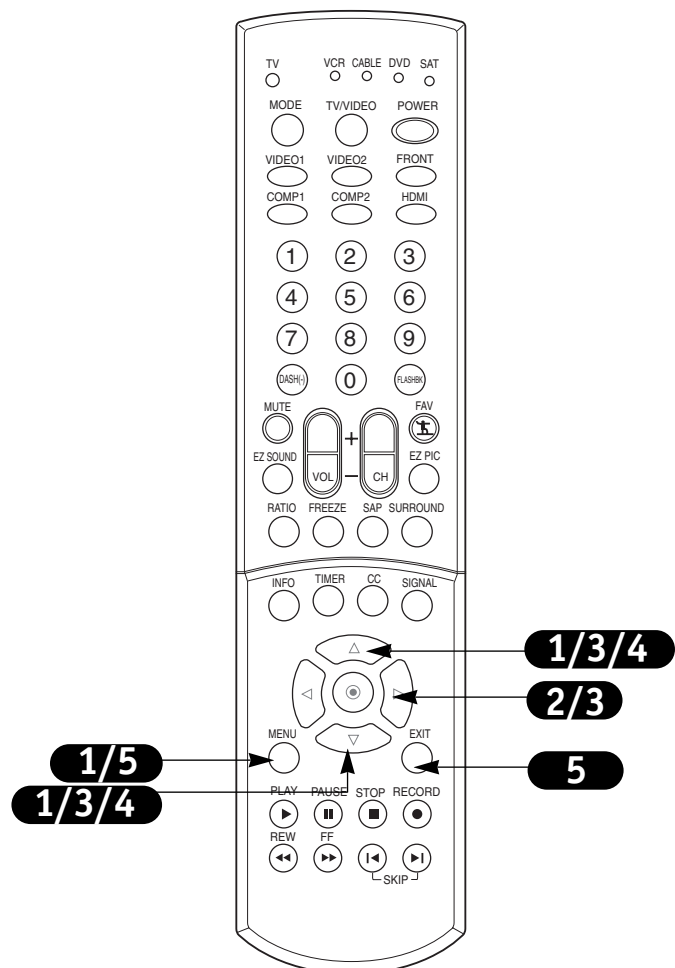

EZ Demo

Shows you how to navigate the TV's on-screen menus.

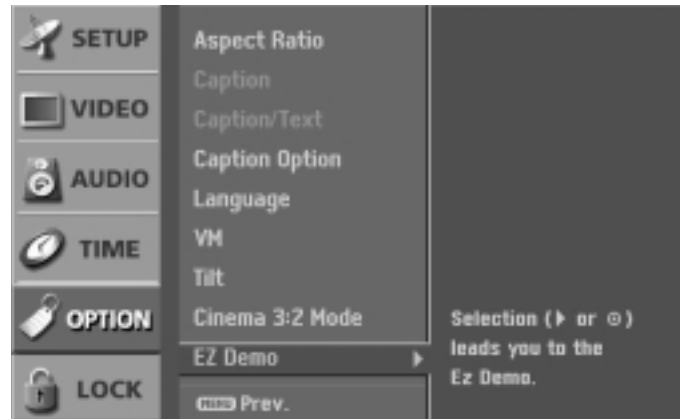

- 1** Press the MENU button on the remote control, then use the UP/DOWN arrow button to select the OPTION menu.
- 2** Press the RIGHT arrow button to access the OPTION menu.
- 3** Use the UP/DOWN arrow button to select EZ Demo, then press the RIGHT arrow button.
- 4** Press EXIT button on the remote to stop EZ Demo.

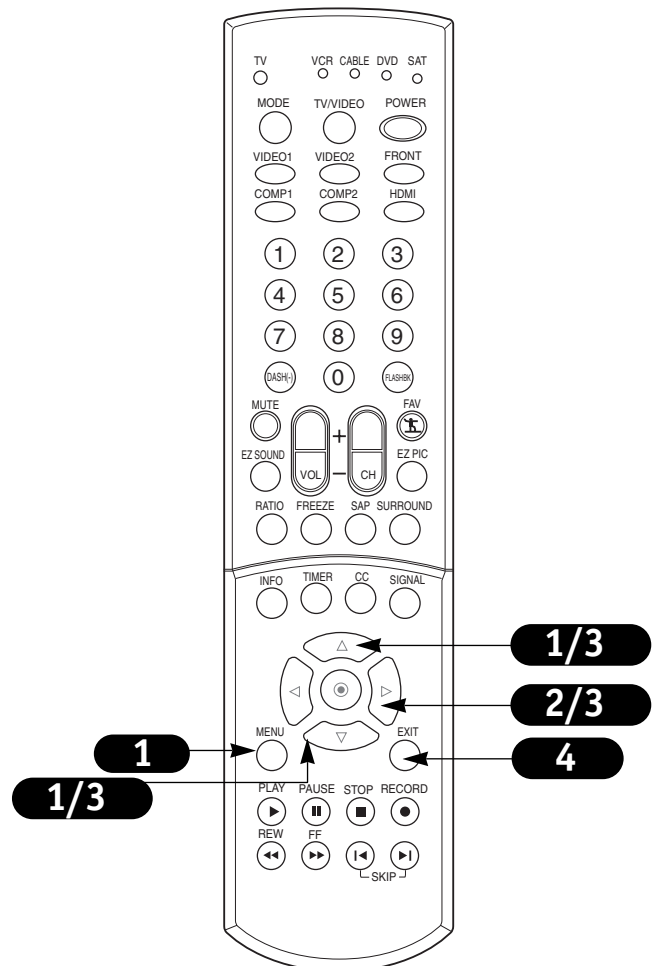

Parental Lock Setup

Lets you set up blocking schemes to block specific channels, ratings, and viewing sources.

A password is required to gain access to this menu if the Lock System is activated.

If the lock is already set, enter the password as requested. The TV is set up with the initial password '0', '0', '0', '0'.

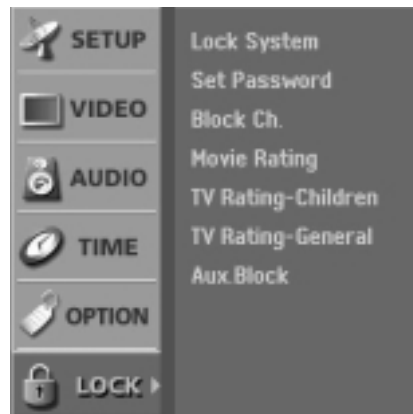

1 Press the MENU button on the remote control, then use the UP/DOWN arrow button to select the LOCK Menu option.

2 Press the RIGHT arrow button to activate the LOCK Menu.

3 Use the UP/DOWN arrow to choose from the following Lock Menu options. Once the options are selected, change the settings to your preferences.

- **Lock System:** Activates or disables the blocking scheme you set up previously.
- **Set Password:** Change the password by inputting a new password twice.
- **Block Ch.:** Blocks any channels that you do not want to watch or that you do not want your children to watch.
- **Movie Rating (MPAA):** Blocks movies according to the movie ratings limits specified, so children cannot view certain movies. You can set the ratings limit by blocking out all the movies with the ratings above a specified level. Keep in mind that the movie ratings limit only applies to movies shown on TV, not TV programs, such as soap operas.
- **TV Rating-Children:** Keeps children from watching certain TV programs among only the programs intended for children, according to the ratings limit. The children rating does not apply to other TV programs. Unless you block certain TV programs intended for mature audiences in the TV Rating - sub menu, your children can view those programs.
- **TV Rating-General:** Blocks certain TV programs that you and your family do not want to view, based on the ratings.
- **Aux. Block:** Enables you to select a source for blocking among the source devices you have hooked up.

4 Press EXIT button to return to TV viewing or press MENU button to return to the previous menu.

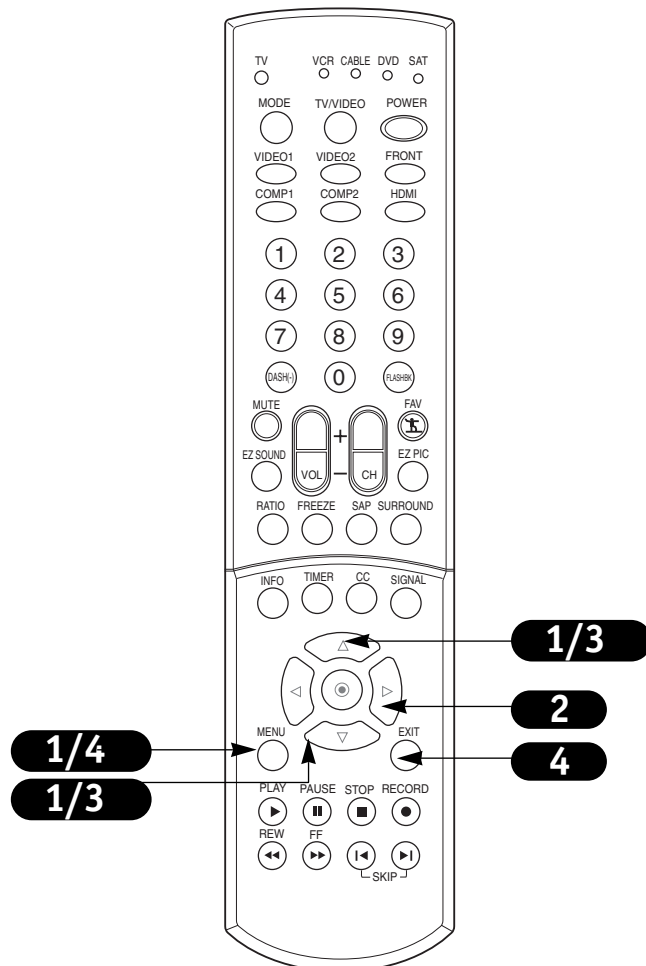

Parental Lock Setup (Continued)

Parental Lock Rating Descriptions



TV-Y (All Children): Program is appropriate for all children.

TV-Y7 (Children 7 years and Older): Program is designed for children age 7 and above.

TV-G (General audience): Most parents would find this program suitable for all ages.

TV-PG (Parental guidance suggested): Program contains material that parents may find unsuitable for younger children.

TV-14 (Parents strongly cautioned): Program contains some material that many parents would find unsuitable for children under 14 years of age.

TV-MA (Mature audience only): Program is specifically designed to be viewed by adults and therefore may be unsuitable for children under 17.

G (General audiences): All ages can view these programs.

PG (Parental guidance suggested): Some program content may not be suitable for children.

PG-13 (Parents strongly cautioned): Some program content may not be appropriate for children under 13.

R (Restricted): Children under 17 requires parent or adult guardian to be present.

NC-17: No one 17 and under admitted.

X: For Adult only.

Blocking Off: Permits all programs.

Programming the Remote

The remote control for your HD receiver is a multi-brand or universal remote control. It can be programmed to operate most remote-controllable devices of other manufacturers.

Note that the remote control may not control all models of other brands.

- 1** Test your remote control.
To find out whether your remote control can operate the component without programming, turn on the component such as a VCR and press the corresponding mode button (VCR) on the remote control, while pointing at the component. Test the **POWER** and **CH +/-** buttons to see if the component responds properly. If not, the remote requires programming to operate the device.
- 2** Turn on the component to be programmed, then press the corresponding mode button on the remote control.
- 3** Press the **POWER** and **MUTE** buttons simultaneously, the remote control is ready to be programmed for the code.
- 4** There are two ways to find the right code for the component.
 - A. If you press the **CH +/-** buttons repeatedly, the codes will change one at-a-time. Press the **POWER** button after each code change. If the right code is found, the device will turn off.
 - B. Enter a code number using the number buttons on the remote. Programming code numbers for the corresponding component can be found on the following pages. Again, if the code is correct, the device will turn off.
- 5** Press the **EXIT** button to store the code.
- 6** Test the remote control functions to see if the component responds properly. If not, repeat from step 2.

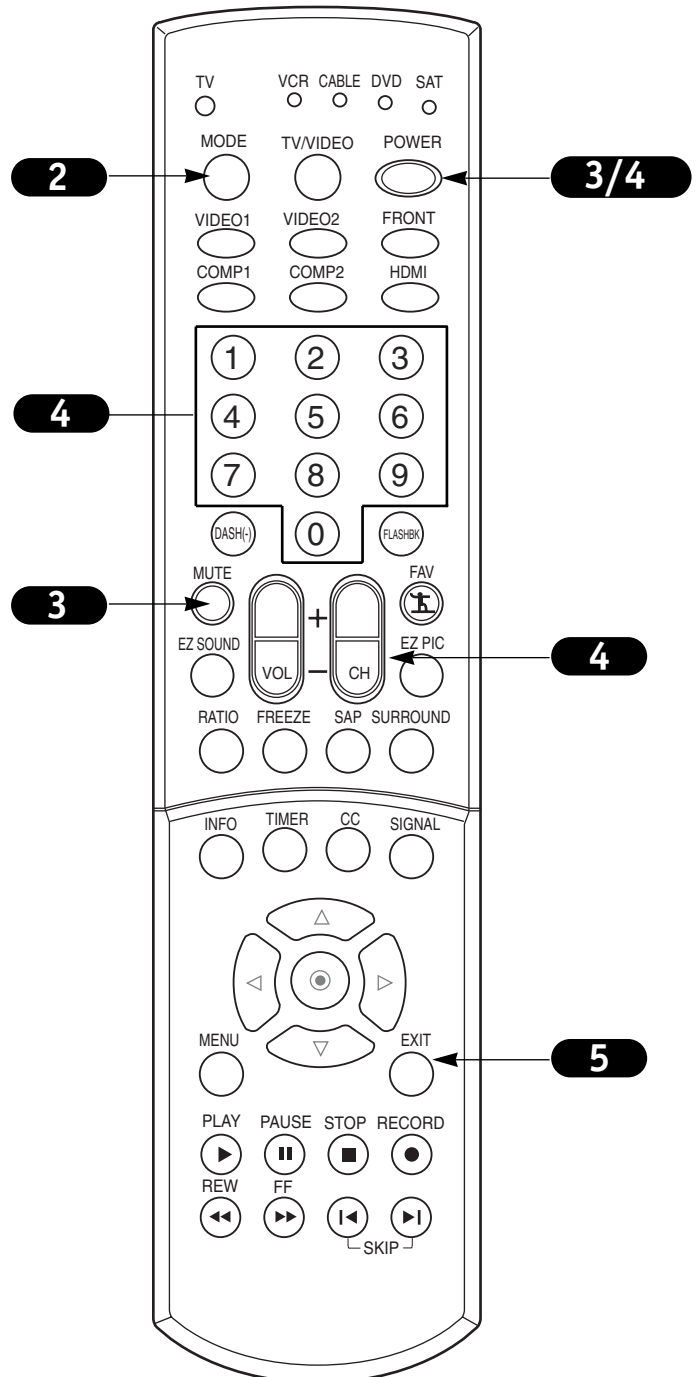

Programming Codes

VCRs

Brand	Codes	Brand	Codes	Brand	Codes	Brands	Codes
AIWA	034		055 060 130		034 040 041	TOTEVISION	040 101
AKAI	016 043 046		150 152		062 063 107	UNITECH	040
	124 125 146	KENWOOD	014 034 039		109 140 144	VECTOR RESEARCH	012
AMPRO	072		043 047 048		145 147	VICTOR	048
ANAM	031 033 103	LG	255	REALISTIC	003 008 010	VIDEO CONCEPTS	012 034 046
AUDIO DYNAMICS	012 023 039	LLOYD	034		014 031 033	VIDEOSONIC	040
	043	LXI	003 009 013		034 040 053	WARDS	003 013 017
BROKSONIC	035 037 129		014 017 034		054 101		024 031 033
CANON	028 031 033		101 106	RICO	058		034 040 053
CAPEHART	108	MAGIN	040	RUNCO	148		054 131
CRAIG	003 040 135	MAGNAVOX	031 033 034	SALORA	014	YAMAHA	012 034 039
CURTIS MATHES	031 033 041		041 067 068	SAMSUNG	032 040 102		043
DAEWOO	005 007 010	MARANTZ	012 031 033		104 105 107	ZENITH	001 034 048
	064 065 108		067 069		109 112 113		056 058 072
	110 111 112	MARTA	101		115 120 122		080 101
	116 117 119	MATSUI	027 030		125		
DAYTRON	108	MEI	031 033	SANSUI	022 043 048		
DBX	012 023 039	MEMOREX	003 010 014		135		
	043		031 033 034	SANYO	003 007 010		
DYNATECH	034 053		053 072 101		014 102 134		
ELECTROHOME	059		102 134 139	SCOTT	017 037 112		
EMERSON	006 017 025	MGA	045 046 059		129 131		
	027 029 031	MINOLTA	013 020	SEARS	003 008 009		
	034 035 036	MITSUBISHI	013 020 045		010 013 014		
	037 046 101		046 049 051		017 020 031		
	129 131 138		059 061 151		042 073 081		
	153	MTC	034 040		101		
FISHER	003 008 009	MULTITECH	024 034	SHARP	031 054 149		
	010	NEC	012 023 039	SHINTOM	024		
FUNAI	034		043 048	SONY	003 009 031		
GE	031 033 063	NORDMENDE	043		052 056 057		
	072 107 109	OPTONICA	053 054		058 076 077		
	144 147	PANASONIC	066 070 074		078 149		
GO VIDEO	132 136		083 133 140	SOUNDESIGN	034		
GOLDSTAR	012 013 020		145	STS	013		
	101 106 114	PENTAX	013 020 031	SYLVANIA	031 033 034		
	123		033 063		059 067		
HARMAN KARDON	012 045	PHILCO	031 034 067	SYMPHONIC	034		
HITACHI	004 018 026	PHILIPS	031 033 034	TANDY	010 034		
	034 043 063		054 067 071	TATUNG	039 043		
	137 150		101	TEAC	034 039 043		
INSTANTREPLAY	031 033	PILOT	101	TECHNICS	031 033 070		
JCL	031 033	PIONEER	013 021 048	TEKNIKA	019 031 033		
JCPENNY	012 013 015	PORTLAND	108		034 101		
	033 040 066	PULSAR	072	THOMAS	034		
	101	QUARTZ	011 014	TMK	006		
JENSEN	043	QUASAR	033 066 075	TOSHIBA	008 013 042		
JVC	012 031 033		145		047 059 082		
	043 048 050	RCA	013 020 033		112 131		

Programming Codes

SAT

Brand	Codes	Brand	Codes	Brand	Codes	Brand	Codes
ALPHASTAR DSR	123		027 133 134	PERSONAL CABLE	117	VIEWSTAR	115
AMPLICA	050	GENERAL INSTRUMENT	003 004 016	PHILIPS	071	WINEGARD	128 146
BIRDVIEW	051 126 129		029 031 059	PICO	105	ZENITH	001 081 082
BSR	053		101	PRESIDENT	019 102		083 084 091
CAPETRONICS	053	HITACHI	139 140	PRIMESTAR	030 110 111		120
CHANNEL MASTER	013 014 015	HOUSTON TRACKER	033 037 039	PROSAT	072		
	018 036 055		051 057 104	RCA	066 106		
CHAPARRAL	008 009 012	HUGHES	068	REALISTIC	043 074		
	077	HYTEK	053	SAMSUNG	123		
CITOH	054	JANIEL	060 147	SATELLITE SERVICE CO	028 035 047		
CURTIS MATHES	050 145	JERROLD	061		057 085		
DRAKE	005 006 007	KATHREIN	108	SCIENTIFIC ATLANTA	032 138		
	010 011 052	LEGEND	057	SONY	103		
	112 116 141	LG	255	STARCAST	041		
DX ANTENNA	024 046 056	LUTRON	132	SUPER GUIDE	020 124 125		
	076	LUXOR	062 144	TEECOM	023 026 075		
ECHOSTAR	038 040 057	MACOM	010 059 063		087 088 090		
	058 093 094		064 065		107 130 137		
	095 096 097	MEMOREX	057	TOSHIBA	002 127		
	098 099 100	NEXTWAVE	028 124 125	UNIDEN	016 025 042		
	122	NORSAT	069 070		043 044 045		
ELECTRO HOME	089	PACE SKY SATELLITE	143		048 049 078		
EUROPLUS	114	PANASONIC	060 142		079 080 086		
FUJITSU	017 021 022	PANSAT	121		101 135 136		

DVD

Brand	Codes	Brand	Codes	Brand	Codes	Brand	Codes
APEX DIGITAL	022		025	PHILIPS	013	THOMPSON	005 006
DENON	020 014	MAGNAVOX	013	PIONEER	004 026	TOSHIBA	019 008
GE	005 006	MARANTZ	024	PROCEED	021	YAMAHA	009 018
GOLDSTAR	010 016 025	MITSUBISHI	002	PROSCAN	005 006	ZENITH	010 016 025
HARMAN KARDON	027	NAD	023	RCA	005 006		
JVC	012	ONKYO	008 017	SAMSUNG	011 015		
LG	001 010 016	PANASONIC	003 009	SONY	007		

Programming Codes

CATV

Brand	Codes	Brand	Codes	Brand	Codes	Brand	Codes
ABC	003 004 039		008 009 010	REGAL	049 050		032 035
	042 046 052		052 069 074	REGENCY	057	VIEWSTAR	012 015 018
	053	LG	255	REMBRANT	025		086 087 088
ANTRONIK	014	M-NET	037	RK	091		089
ARCHER	005 007 014	MACOM	033	SAMSUNG	030 068	ZENITH	001 060 093
	024	MAGNAVOX	010 012 064	SCIENTIFIC ATLANTA	003 011 041		
CABLE STAR	026		079		042 043 045		
CENTURION	092	MEMOREX	001		046		
CENTURY	007	MOVIE TIME	028 032	SHERITECH	022		
CITIZEN	007	NSC	015 028 038	SIGNAL	030		
COLOUR VOICE	065 090		071 073	SIGNATURE	052		
COMBANO	080 081	OAK	016 031 037	SL MARX	030		
COMTRONICS	019 030		053	SPRUCER	047 078		
DIAMOND	023	PANASONIC	044 047	STARCOM	002 004 008		
EAGLE	020 030 040	PARAGON	001		009		
EASTERN	057 062 066	PHILIPS	006 012 013	STARGATE	008 030		
ELECTRICORD	032		020 065 085	SYLVANIA	067		
GE	072		090	TADIRAN	030		
GEMINI	008 022 025	PIONEER	034 051 052	TANDY	017		
	054		063 076	TEXSCAN	029 067		
GI	052 074	POST NEWS WEEK	016	TOCOM	039 040 056		
GOLDEN CHANNEL	030	PRUCER	059	TOSHIBA	001		
HAMLIN	049 050 055	PTS	011 048 071	UNIKA	007 014 024		
HITACHI	052 055		072 073 074	UNITED CABLE	004 053		
HOSPITALITY	070 077	PULSAR	001	UNIVERSAL	005 007 014		
JERROLD	002 003 004	RCA	047		024 026 027		

Early malfunctions can be prevented. Careful and regular cleaning can extend the amount of time you will have your new TV. Be sure to turn the power off and pull out the power cord before you begin any cleaning.

SCREEN CLEANING

1. Here's a great way to keep the dust off your screen for a while. Wet a soft cloth in a mixture of lukewarm water and a little fabric softener or dish washing detergent. Wring the cloth until it's almost dry, and then use it to wipe the screen.
2. Make sure the excess water is off the screen, and then let it air-dry before you turn on your TV.

CABINET CLEANING

1. Use a soft cloth with a mild soap solution to wipe the cabinet.
2. Rinse the cloth and wipe the cabinet again.
3. Let the cabinet air-dry before turning the TV on.

EXTENDED ABSENCE



If you expect to leave your TV dormant for a long time (such as a vacation), unplug the power cord from the wall power outlet to protect against possible damage from lightning or power surges. If you use an off-air antenna, you may also want to disconnect it from the back of your TV before leaving.

PICTURE INTERFERENCE

Even though you may be getting cable, the signal may be weak, which means the quality of your picture may suffer due to other factors. If there are problems with the image on your TV, consult the Troubleshooting guide on the following pages. You may also want to contact your cable service provider to determine if the problem is from the cable service.

VIDEO GAMES AND OTHER FIXED-PATTERN DISPLAYS

If you use your TV to play video games or for other uses that involve single, fixed images, such as a photo-CD player, you should avoid setting the Brightness level too high. If static images, like network identification icons or patterns, are left on the screen for a long time period, they may leave a permanent impression on the TV screen. You can reduce the chance of this happening by limiting the amount of time you use the fixed-image display, and by reducing the contrast and brightness levels.



If you unplug your TV, you may have to reset the clock using the Time menu described earlier.

Troubleshooting

Some quick and easy tips for fixing problems yourself.

SYMPTOM	POSSIBLE SOLUTIONS
Snowy picture and unclear sound.	<ul style="list-style-type: none">• Check your antenna connection or location.• Check your cable input.• Check to see if the TV/VCR button on your VCR has the TV selected.
Multiple images or 'ghost shadows.'	<ul style="list-style-type: none">• Check your antenna direction and/or location.• Check your cable input.• Make sure the cable from your antenna to your TV is properly connected.
Interference: Sharp lines across the screen and unclear sound.	<p><i>The following may cause image problems or distortion: Electrical appliances, powerful lights, cars, trucks; computers or portable phones; medical equipment</i></p> <ul style="list-style-type: none">• If possible increase the distance between your TV and the offending appliance, or shut one of them off.
Normal picture but no sound.	<ul style="list-style-type: none">• Check volume levels.• Make sure the TV is not Muted.• Try another channel. The problem may be with the broadcast, not your TV.• Are the Audio cables installed properly?• Are the wires for external speakers (if you have external speakers) installed properly?• Make sure your speakers are turned on in the Audio menu.• If your audio mode is set to SAP, the program may not have SAP.
No picture and unclear sound.	<ul style="list-style-type: none">• Are you in TV or cable tuning mode, and should be in the other?• Make sure output channels on all A/V equipment are on the same channel (3 or 4).• Check that all connections are tight.
No picture or sound.	<ul style="list-style-type: none">• Is the AC power plugged in?• Check that your AC power cord outlet works. (Test it by plugging in something else or try another power outlet.)• Make sure your brightness and audio controls are set properly.• Try another channel. The problem may be with the broadcast.
No color, but the sound is okay.	<ul style="list-style-type: none">• Check the color settings in the Video menu.• Try another channel. The problem may be with the broadcast.
Picture has a big black box on it, but the sound is okay.	<ul style="list-style-type: none">• The analog caption option may be in Text mode. Select CC 1, in the analog caption menu.
Picture has two horizontal black bars, one on top and one on bottom.	<ul style="list-style-type: none">• Select correct Aspect Ratio in Option menu
Missing Secret Lock Code	<ul style="list-style-type: none">• If you forgot your password, when the display asks you to enter the secret code, press '7', '7', '7', '7' on the remote control.

Troubleshooting (Continued)

SYMPTOM	POSSIBLE SOLUTIONS
Remote control doesn't work.	<ul style="list-style-type: none">• Make sure the batteries are fresh and installed properly.
Menu options can't be changed or selected.	<ul style="list-style-type: none">• Try unplugging your TV for a few minutes, then plug it back in.
No picture or sound when any non-cable source is selected.	<ul style="list-style-type: none">• Check to see if the source equipment has been turned on.• Make sure that the connections are secure on the back of your TV and on the source equipment.
Weak or no Stereo Sound when using a stereo VCR.	<ul style="list-style-type: none">• Check to see if all the connections are secure.• Look in the Audio mode menu to see if all the settings are correct.• If you are using channel 3 or 4 to view your VCR, stereo sound will not be available.
Time is incorrect.	<ul style="list-style-type: none">• Make sure the time was set initially. Probably power was lost.• Reset clock manually.

Glossary

A list of definitions for some of the words found in this guide.

75 OHM RF CABLE	The round cable that comes from an off-air antenna or cable service provider. Each end looks like a hex shaped nut with a wire sticking through the middle, and it screws onto the threaded jack on the back of your TV.
A/V CABLES	Audio/Video cables. Three cables - Right audio (red), Left audio (white), and Video (yellow). A/V cables are used for stereo playback of videocassettes and for higher quality picture and sound from other A/V devices.
A/V DEVICE	Any device that produces video or sound (VCR, DVD, cable box, or television).
ADD	This function lets you add new channels to the channel list in memory that you'll scroll through when using your remote.
AMPLIFIER	An external device that amplifies sound from a television, CD player, VCR, DVD or other A/V device.
ANALOG TV	Traditional method of representing a television signal as a replica (analog) of the original picture and sound.
ANTENNA	The physical receiver of television signals sent over the air. A large metal piece of equipment does not always have to be visible for your home to be using an antenna.
ASPECT RATIO	The ratio of the horizontal dimension to the vertical dimension of a picture. Standard television in the U.S. today is generally transmitted and displayed in a 4:3 aspect ratio. High-Definition television will normally be formatted in a wider aspect ratio, assumed to be 16:9.
CAPTIONS	A form of subtitling that writes out the dialog for your program on the screen.
DELETE	This function lets you remove channels that you don't watch from the channel list in memory.
DIGITAL TV (DTV)	A new method of representing a television signal as a series of binary numbers (1s and 0s). This method allows the signal to be manipulated to eliminate redundancy and dramatically increase picture and sound quality.
DOLBY DIGITAL	Dolby Digital Cinema Sound is made possible by a new digital coding technique called Dolby AC-3. Dolby AC-3 produces high-quality, 5.1 channel surround sound which is six discrete separate channels for a full range of sound. Each channel can carry a different signal simultaneously (front center, front left, front right, surround left, surround right and subwoofer).

Glossary (Continued)

A list of definitions for some of the words found in this guide.

FAVORITE CHANNELS	This function created a customized list of your favorite channels. You can access this group of channels with the FAV button on the remote by pressing FAV repeatedly.
INPUT	Refers to the jack that receives a signal into the TV, VCR or other A/V device.
JACK	A connection on the back of a TV, VCR, or any other A/V device. This includes the RF jacks and the Audio/Video jacks that are color-coded.
MODE	The mode determines the type of device (TV, VCR, Cable, etc.) that the remote is controlling; remote operating mode.
MONO SOUND	Mono (monaural) sound is one channel of sound. On more than one speaker, all the speakers play the same audio.
OUTPUT	Refers to the jack that sends a signal out of a VCR, DVD, or other A/V device.
SECOND AUDIO PROGRAMMING/SAP	Second Audio Programming (SAP) is another, separate, audio channel available with some programming. Choosing SAP often refers to listening to audio in another language, such as Spanish or French.
SIGNAL	Picture and sound traveling through cable, or over the air, to your television screen.
SOURCE	The term for the equipment that provides audio and video information to your TV. Antenna, VCR, DVD players, and Cable Boxes are examples of sources.
STEREO SOUND	Stereo (stereophonic) sound refers to audio that's divided into right and left sides.
TUNER	Any device that picks up broadcast signals and turns them into picture and sound.

Product Specifications

Model	32FZ1DC-UB
Horizontal Size (inches)	35.86
Height (inches)	23.66
Thickness (inches)	21.73
Weight (pounds)	132.3
Power requirement	AC 120V~ 60Hz
Television system	American TV Standard, NTSC-M, Integrated ATSC tuner, 64 & 256 QAM
Television Channel	VHF: 2 - 13 UHF: 14 - 69 CATV: 1 - 135 CADTV: 1 - 135 DTV: 2 - 69
Power consumption (W)	210W
Antenna	75 ohm external terminal for VHF/UHF
Audio Output (W)	7W x 2
Supplied accessories	Remote control, batteries 2 size AA (Alkaline battery)
Screen Aspect Ratio	16 : 9
External input ports	Video/Audio input (4 set) S-Video input (2) Component input (2 set) HDMI/DVI input (1) Digital audio optical input (DVI)(1) Digital audio optical output (1) Calibration port (1) Cable/Antenna port



Design and specifications are subject to change without prior notice.



LG COLOR TELEVISION LIMITED WARRANTY – USA

Your LG Color Television will be repaired or replaced, at LG's option, if it proves to be defective in material or workmanship under normal use, during the warranty period ("Warranty Period") listed below, effective from the date ("Date of Purchase") of original consumer purchase of the product. This warranty is good only to the original purchaser of the product and effective only when used in the U.S., including Alaska, Hawaii, and U.S. Territories.

THIS WARRANTY IS IN LIEU OF ANY OTHER WARRANTY, EXPRESS OR IMPLIED, INCLUDING WITHOUT LIMITATION, ANY WARRANTY OF MERCHANTABILITY OR FITNESS FOR A PARTICULAR PURPOSE. TO THE EXTENT ANY IMPLIED WARRANTY IS REQUIRED BY LAW, IT IS LIMITED IN DURATION TO THE EXPRESS WARRANTY PERIOD ABOVE. NEITHER THE MANUFACTURER NOR ITS U.S. DISTRIBUTOR SHALL BE LIABLE FOR ANY INCIDENTAL, CONSEQUENTIAL, INDIRECT, SPECIAL, OR PUNITIVE DAMAGES OF ANY NATURE, INCLUDING WITHOUT LIMITATION, LOST PROFITS, LOST OR CORRUPTED PROGRAMMING OR DATA, OR ANY OTHER DAMAGE WHETHER BASED IN CONTRACT, TORT, OR OTHERWISE. Some states do not allow the exclusion or limitation of incidental or consequential damages or limitations on how long an implied warranty lasts, so the above exclusion or limitation may not apply to you. This warranty gives you specific legal rights and you may also have other rights that vary from state to state.

<p>WARRANTY PERIOD:</p> <p>LABOR: 90 Days from the Date of Purchase.</p> <p>PARTS: One Year from the Date of Purchase.</p> <p>CRT: 2 years from the Date of Purchase.</p> <p>Replacement Units and Repair Parts may be new or factory remanufactured.</p> <p>Replacement Units and Repair Parts are warranted for the remaining portion of the original unit's warranty period.</p>	<p>HOW SERVICE IS HANDLED:</p> <p>In-Home Service : Please retain dealer's dated bill of sale or delivery ticket as evidence of the Date of Purchase for proof of warranty, and submit a copy of the bill of sale to the service person at the time warranty service is provided.</p> <p>Please call 1-800-243-0000 to locate your nearest LG Authorized Service Center.</p> <p>Visit our website at: http://www.lgservice.com</p>
---	--

DAMAGES OF ANY NATURE, INCLUDING WITHOUT LIMITATION, LOST PROFITS, LOST OR CORRUPTED PROGRAMMING OR DATA, OR ANY OTHER DAMAGE WHETHER BASED IN CONTRACT, TORT, OR OTHERWISE. Some states do not allow the exclusion or limitation of incidental or consequential damages or limitations on how long an implied warranty lasts, so the above exclusion or limitation may not apply to you. This warranty gives you specific legal rights and you may also have other rights that vary from state to state.

THIS LIMITED WARRANTY DOES NOT APPLY TO:

<ul style="list-style-type: none"> ● damage caused in shipping or transit ● service required as a result of improper installation, including incorrect or insufficient AC supply (please consult the owner's manual for power supply requirements). ● installation or repair of antenna systems, cable converters, cable company supplied equipment, or other components in a video system ● set-up or adjustment on consumer controls, or damage caused by improper adjustments ● damage caused by other system components ● any unit that has been modified or incorporated into any other product 	<ul style="list-style-type: none"> ● replacement of batteries on the remote control. ● damage (including cosmetic damage), failure, loss or personal injury due to misuse, abuse, negligence, improper maintenance or storage, or to acts of nature or other causes beyond our control. (Causes beyond our control include but are not limited to lightning strike, power surges, power outages and water damage.) ● repair or replacement of warranted parts by other than an LG authorized service centers. ● units purchased or serviced outside of the U.S.A. ● product where the original factory serial numbers have been removed, defaced or changed in any way. ● product sold and labeled as "as is, where is" or similar disclaimer.
--	--

The cost of repair or replacement under these excluded circumstances shall be borne by the consumer.

CUSTOMER INTERACTIVE CENTER NUMBERS

<p>To obtain Customer Assistance, Product Information, or Dealer or Authorized Service Center location:</p>	<p>Call 1-800-243-0000 (24 hours a day, 365 days a year) and choose the appropriate prompt from the menu; or visit our website at http://www.lgservice.com.</p>
--	--

BEFORE CALLING FOR SERVICE:

- Please check your Operating Guide – you may avoid a service call.
- Please have your product model number, serial number, and the date of purchase or original installation available.
- Parts and service in accordance with the LG warranty is our responsibility and will be provided without charge. Other service requirements will be at the owner's expense. If you have problems in obtaining satisfactory warranty service, write or call the LG Customer Interactive Center.

TO CONTACT LG ELECTRONICS BY MAIL:

LG Customer Interactive Center
 P. O. Box 240007
 201 James Record Road
 Huntsville, Alabama 35824
 ATTN: CIC

P/N : 3828VA0395FⒶ

Free Manuals Download Website

<http://myh66.com>

<http://usermanuals.us>

<http://www.somanuals.com>

<http://www.4manuals.cc>

<http://www.manual-lib.com>

<http://www.404manual.com>

<http://www.luxmanual.com>

<http://aubethermostatmanual.com>

Golf course search by state

<http://golfingnear.com>

Email search by domain

<http://emailbydomain.com>

Auto manuals search

<http://auto.somanuals.com>

TV manuals search

<http://tv.somanuals.com>