



26LG3DCH-UA 32LG3DCH-UA

## Hospital TVs

---

# Commercial Mode Setup Guide

Note: All features shown within this guide  
may not be available on all models.

### Experienced Installer

**Commercial Mode Setup**  
page 7

**Cloning Information**  
pages 29 / 30 / 31-32-33

For Customer Support/Service, please call:

**1-888-865-3026**

www.lgcommercial.com

**RECORD Model and SERIAL NUMBER**

The model and serial number of this TV is located on the back of the cabinet. For future reference, we suggest that you record those numbers here:

Model No. \_\_\_\_\_ Serial No. \_\_\_\_\_



**WARNING:** TO REDUCE THE RISK OF ELECTRIC SHOCK DO NOT REMOVE COVER (OR BACK). NO USER SERVICEABLE PARTS INSIDE. REFER TO QUALIFIED SERVICE PERSONNEL



The lightning flash with arrowhead symbol, within an equilateral triangle, is intended to alert the user to the presence of uninsulated "dangerous voltage" within the product's enclosure that may be of sufficient magnitude to constitute a risk of electric shock to persons.



The exclamation point within an equilateral triangle is intended to alert the user to the presence of important operating and maintenance (servicing) instructions in the literature accompanying the appliance

**WARNING:**

TO PREVENT FIRE OR SHOCK HAZARDS, DO NOT EXPOSE THIS PRODUCT TO RAIN OR MOISTURE.

**POWER CORD POLARIZATION:**

This product is equipped with a 3-wire grounding-type alternating current line plug. This plug will fit into the power outlet only one way. This is a safety feature. If you are unable to insert the plug fully into the outlet, contact your electrician to replace your obsolete outlet. Do not defeat the safety purpose of the three-wire ground type plug.

**NOTE TO CABLE/TV INSTALLER:**

This reminder is provided to call the cable TV system installer's attention to Article 820-40 of the National Electric Code (U.S.A.). The code provides guidelines for proper grounding and, in particular, specifies that the cable ground shall be connected to the grounding system of the building, as close to the point of the cable entry as practical.

**REGULATORY INFORMATION:**

This equipment has been tested and found to comply with the limits for a Class B digital device, pursuant to Part 15 of the FCC Rules. These limits are designed to provide reasonable protection against harmful interference when the equipment is operated in a residential installation. This equipment generates, uses and can radiate radio frequency energy and, if not installed and used in accordance with the instruction manual, may cause harmful interference to radio communications. However, there is no guarantee that interference will not occur in a particular installation. If this equipment does cause harmful interference to radio or television reception, which can be determined by turning the equipment off and on, the user is encouraged to try to correct the interference by one or more of the following measures:

- Reorient or relocate the receiving antenna.
- Increase the separation between the equipment and receiver.
- Connect the equipment into an outlet on a circuit different from that to which the receiver is connected.
- Consult the dealer or an experienced radio/TV technician for help.

**CAUTION:**

Do not attempt to modify this product in any way without written authorization from LG Electronics U.S.A., Inc. Unauthorized modification could void the user's authority to operate this product.

**COMPLIANCE:**

The responsible party for this product's compliance is: LG Electronics U.S.A., Inc.  
1000 Sylvan Avenue, Englewood Cliffs, NJ 07632, USA • Phone: 1-201-816-2000.

Marketed and Distributed in the United States by LG Electronics U.S.A., Inc.  
2000 Millbrook Drive, Lincolnshire, IL 60069

# IMPORTANT SAFETY INSTRUCTIONS

---

## SAFETY INSTRUCTIONS

### Important safeguards for you and your new product

This product has been manufactured and tested with safety in mind. However, improper use can result in potential electrical shock or fire hazards. To avoid defeating the safeguards that have been built into the new product, please read and observe the following safety points when installing and using the new product, and save them for future reference.

Observing the simple precautions discussed in this installation and operating guide can help get many years of enjoyment and safe operation that are built into the new product.

This product complies with all applicable U.S. Federal safety requirements, and those of the Canadian Standards Association

### 1. Read Instructions

All the safety and operating instructions should be read before the product is operated.

### 2. Follow Instructions

All operating and use instructions should be followed.

### 3. Retain Instructions

The safety and operating instructions should be retained for future reference.

### 4. Heed Warnings

All warnings on the product and in the operating instructions should be adhered to.

### 5. Cleaning

Unplug this product from the wall outlet before cleaning. Do not use liquid cleaners or aerosol cleaners. Use a damp cloth for cleaning.

### 6. Water and Moisture

Do not use this product near water for example, near a bath tub, wash bowl, kitchen sink, or laundry tub, in a wet basement, or near a swimming pool.

### 7. Accessories, Carts, and Stands

Do not place this product on a slippery or tilted surface, or on an unstable cart, stand, tripod, bracket, or table. The product may slide or fall, causing serious injury to a child or adult, and serious damage to the product. Use only with a cart, stand, tripod, bracket, or table recommended by the manufacturer, or sold with the product. Any mounting of the product should follow the manufacturer's instructions, and should use a mounting accessory recommended by the manufacturer.



PORTABLE CART WARNING

### 8. Transporting Product

A product and cart combination should be moved with care. Quick stops, excessive force, and uneven surfaces may cause the product and cart combination to overturn.

### 9. Attachments

Do not use attachments not recommended by the product manufacturer as they may cause hazards.

### 10. Ventilation

Slots and openings in the cabinet are provided for ventilation and to ensure reliable operation of the product and to protect it from overheating, and these openings must not be blocked or covered. The openings should never be blocked by placing the product on a bed, sofa, rug, or other similar surface. This product should not be placed in a built-in installation such as a bookcase or rack unless proper ventilation is provided or the manufacturer's instructions have been adhered to.

### 11. Power Sources

This product should be operated only from the type of power source indicated on the marking label. If you are not sure of the type of power supply to your home, consult your product dealer or local power company. For products intended to operate from battery power, or other sources, refer to the operating instructions.

### 12. Power Cord Polarization (Some models)

This product is equipped with a three-wire grounding type alternating-current power plug. This plug will fit into the power outlet only one way. This is a safety feature. If you are unable to insert the plug fully into the outlet, contact your electrician to replace your obsolete outlet. Do not defeat the safety purpose of the three-wire ground-type plug.

### 13. Power Cord Protection

Power-supply cords should be routed so that they are not likely to be walked on or pinched by items placed upon or against them, paying particular attention to cords at plugs, convenience receptacles, and the point where they exit from the product.

# IMPORTANT SAFETY INSTRUCTIONS

(Continued from previous page)

## 14. Outdoor Antenna Grounding

If an outside antenna or cable system is connected to the product, be sure the antenna or cable system is grounded so as to provide some protection against voltage surges and built-up static charges. Article 810 of the National Electrical Code (U.S.A.), ANSI/ NFPA 70 provides information with regard to proper grounding of the mast and supporting structure, grounding of the lead-in wire to an antenna discharge unit, size of grounding conductors, location of antenna-discharge unit, connection to grounding electrodes, and requirements for the grounding electrode.

### Example of Grounding According to National Electrical Code Instructions

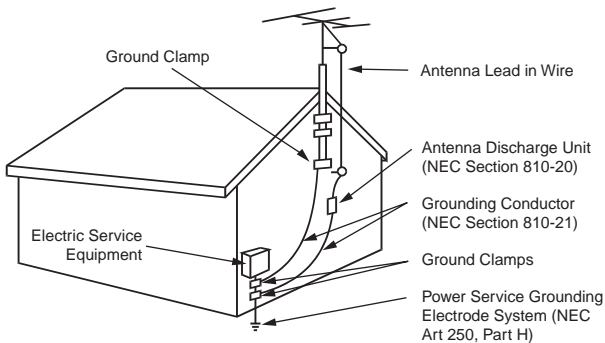

NEC - National Electrical Code

## 15. Lightning

For added protection for this product (receiver) during a lightning storm, or when it is left unattended and unused for long periods of time, unplug it from the wall outlet and disconnect the antenna or cable system. This will prevent damage to the product due to lightning and power-line surges.

## 16. Power Lines

An outside antenna system should not be located in the vicinity of overhead power lines or other electric light or power circuits, or where it can fall into such power lines or circuits. When installing an outside antenna system, extreme care should be taken to keep from touching such power lines or circuits as contact with them might be fatal.

## 17. Overloading

Do not overload wall outlets and extension cords as this can result in a risk of fire or electric shock.

## 18. Object and Liquid Entry

Never push objects of any kind into this product through openings as they may touch dangerous voltage points or

short-out parts that could result in a fire or electric shock. Never spill liquid of any kind on the product.

## 19. Servicing

Do not attempt to service this product yourself as opening or removing covers may expose you to dangerous voltage or other hazards. Refer all servicing to qualified service personnel.

## 20. Damage Requiring Service

Unplug this product from the wall outlet and refer servicing to qualified service personnel under the following conditions:

- If the power-supply cord or plug is damaged.
- If liquid has been spilled, or objects have fallen into the product.
- If the product has been exposed to rain or water.
- If the product does not operate normally by following the operating instructions. Adjust only those controls that are covered by the operating instructions as an improper adjustment of other controls may result in damage and will often require extensive work by a qualified technician to restore the product to its normal operation.
- If the product has been dropped or the cabinet has been damaged.
- If the product exhibits a distinct change in performance.

## 21. Replacement Parts

When replacement parts are required, be sure the service technician has used replacement parts specified by the manufacturer or have the same characteristics as the original part. Unauthorized substitutions may result in fire, electric shock, or other hazards.

## 22. Safety Check

Upon completion of any service or repairs to this product, ask the service technician to perform safety checks to determine that the product is in proper operating condition.

## 23. Wall or Ceiling Mounting

The product should be mounted to a wall or ceiling only as recommended by the manufacturer. The product may slide or fall, causing serious injury to a child or adult, and serious damage to the product.

## 24. Heat

The product should be situated away from heat sources such as radiators, heat registers, stoves, or other products (including amplifiers) that produce heat.

Use this page as a reference to find pages or sections to go to and set up the TV features.  
Go to page 7 to begin the Commercial Mode Master TV setup.

1. Connect TV to RF signal and Auxiliary sources.
2. Customize TV features and set up other operational controls in the Installer's menu.
3. Copy the Master TV setup into the clone programmer.
4. Transfer the Master TV setup from the clone programmer to identical TVs.

Warnings . . . . .	2	Channel Banks Setup . . . . .	24 - 25 - 26 - 27
Important Safety Instructions . . . . .	3 - 4	USB Software Upgrades . . . . .	28
Table of Contents . . . . .	5	USB Learn / Teach . . . . .	29
<b>Setup Checklist . . . . .</b>	<b>6</b>	TLL-1100A Cloning Instructions . . . . .	30
<b>Commercial Mode Setup . . . . .</b>	<b>7</b>	LT2002 Cloning Instructions . . . . .	31 - 32 - 33
Installer Overview . . . . .	8	Installer Menus . . . . .	34 - 35 - 36 - 37 - 38 - 39
TV Overview . . . . .	9		
Typical Installer's Remote Control . . . . .	10	<b>References</b>	
Remote Key Functions . . . . .	11	Detailed Instructions For Making A Master TV . . . . .	40
Rear Connections Panel . . . . .	12	Editing Channel Icons/Adding Ch Labels 2-5-4 + Menu Mode	41
A/V Input 2 Side Connections Panel/RF Antenna Connection	13	Clonable Menu Features Chart . . . . .	42
MPI Card Slot / PPV Card Installation . . . . .	14	Checking Software Version . . . . .	42
Vesa Standard TV Mounts . . . . .	15	USB Cloning Troubleshooting . . . . .	43
Pillow Speaker Connections . . . . .	16	TV Camport Auto Sense Operation . . . . .	44
Features Setup Menus Overview . . . . .	17	TV Aux Input Configuration / <b>Power Savings Setup</b> . . . . .	45
Channel Menu . . . . .	18	Troubleshooting . . . . .	46
Picture Menu . . . . .	19	Cloning Troubleshooting . . . . .	47
Audio Menu . . . . .	20	Channel Banks Setup Troubleshooting . . . . .	48
Time Menu . . . . .	21	Troubleshooting Flow Chart . . . . .	49
Option Menu . . . . .	22	Commercial Mode Check . . . . .	50
Lock Menu . . . . .	23	Glossary of Terms . . . . .	51
		Back Cover . . . . .	52

Marketed and Distributed in the United States by LG Electronics U.S.A., Inc.  
1000 Sylvan Avenue  
Englewood Cliffs, NJ 07632

For Customer Support/Service please call:

**1-888-865-3026**

[www.lgcommercial.com](http://www.lgcommercial.com)

# Setup Checklist

---

## Installation and Setup Checklist

- Unpack TV and all accessories.
- Install batteries in remote control.
- Make all connections to signal and Aux sources that will be available.
- Install TV on Vesa Mount or Stand

Note: It may be advisable to make all hardware connections before installing on Vesa mount or stand, as appropriate.

## Hardware Connections

- Install any additional hardware as appropriate to your institution.

## Hardware Connections

- Make all connections to rear Jack Pack.

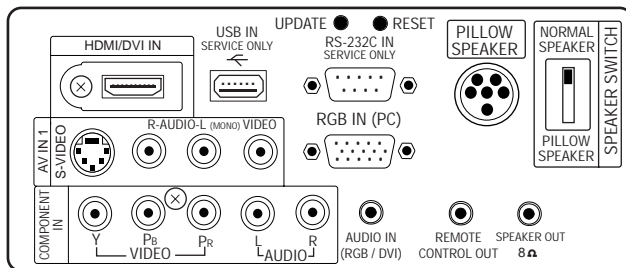

## Installer Menu Items Setup

- Configure all relevant Installer menu items as required of your institution.

## Notes

- If not disabled in Installer menu, Aux sources will appear in channel scan between analog and digital channels after 2-5-5+Menu is performed.
- Scan mode is not functional until 2-5-5+Menu is performed
- Not all TV menu/submenu options are clonable.

## TV Menus Configuration

Configure TV features for the end user.

- Channel (Auto Tuning Channel Search)
- Picture
- Audio
- Option
- Time
- Lock
- Choose on screen menu language. (English is the default language.)

## Commercial Mode Setup

- Commercial Mode Setup, see next page.

## Channel Banks Setup

- Configure Channel Banks if applicable.

## Software Installation

- Install or configure any software as applicable; PPV etc.

## Additional Features Setup

See page 5, Table of Contents.

- Select viewing source on TV.

- Maximum channels and Aux sources that can reside in the TV controller is 140 channels.
- Channel Banks can be set up after 2-5-5+Menu mode is performed. (Requires remote w/Ch Preview button.)
- The TV controller will not store channel numbers if the numbers are higher than 255.

This page provides an overview of the TV configuration. See the pages referenced for more specific, detailed instructions at each step; how to access and use the Installer menu etc.

**Note 1:** Disconnect all Aux inputs. Under certain conditions, Auto Tuning (Channel search) is disabled if there is an Aux input active.

## Overview: Commercial Mode Setup Procedure

### 1. Set Installer Menu Items

(Enter TV Installer Menu, see Installer menus for detailed instructions.)

- a. Set Installer menu item **117 FACT DEFAULT**, to **001** and press **ENTER** on Installer remote. (This clears all installer menu custom settings, channel labels / icons etc. and reloads the factory default settings.)
- b. Set Item **003 BAND/AFC**.
  - **Broadcast:** set to **000**.      - **HRC:** set to **002**
  - **CATV:** set to **001**.          - **IRC:** set to **003**
- c. Set item **028 CH OVERRIDE** to **001**. This allows access to Auto Tuning, Manual Tuning and Channel Edit submenus in the Channel Menu.
- d. Set other particular installer items that affect your TV programming network. Enable/Disable Aux sources etc. See Installer menu pages.  
Note: Disable all Aux sources that will not be active.
- e. After all required installer menu item settings have been adjusted, press **ENTER** on the remote to remove Installer Menu.

### 2. Set Up TV Features (See TV Menus section)

Channel, Picture, Sound, Lock, Time, Option (Digital Captions etc).  
See TV Clonable Options page.

### 3. Run Auto Tuning (Channel Search)

(Search for all available channels.) Go to the Channel menu and access the Auto Tuning option, follow onscreen instructions.

- a. Edit Channel Scan. In the Channel Menu, access Channel Edit.
  - Add/Delete channels per your system requirements.  
Note: Physical channel numbers are used to identify Virtual channels.
  - Add familiar Channel Trademarks/Logos like ABC, CBS, NBC etc. to the Channel-Time onscreen display. In the Setup menu, select the Channel Label option. Add identifiable labels for the end user to readily know what common networks are available.

### 4. Transfer TV Setup to Internal TV Controller: 2-5-5 + Menu Mode

After the TV channel scan has been edited and channel label icons added, enter the Installer menu. Once in the Installer menu, press 2-5-5 and MENU on the remote. This transfers the TV setup to the internal controller box.

Note: The maximum number of channels including Aux sources that can be transferred to the TV controller is 140.

### 5. Add Custom Channel Labels for analog channels: 2-5-4 + Menu Mode

Enter Installer menu, press 2-5-4 and Menu. Add your own custom labels to channel onscreen displays. Note: Digital Channels often have a broadcaster generated label. When done to exit mode, press **MENU**.

### 6. Verify TV Setup

At this point, verify that the channel lineup, channel icons and custom labels are correct. Make sure the TV features are set per your requirements. Set Installer menu item **028 Ch Override** to **000** to lock the channel scan. After the preceding has been completed, the Master TV setup is ready to be copied to a Clone Programmer, see Clone programmer pages.

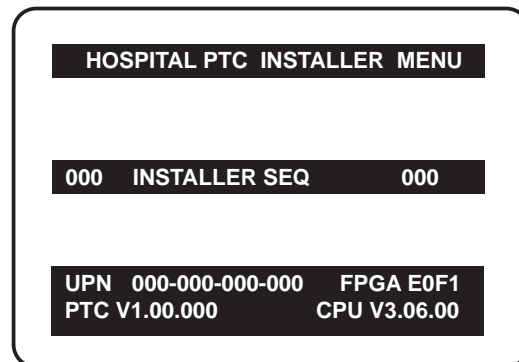

Typical TV Installer Menu

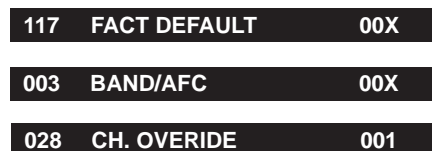

Review the settings for these Installer Menu Items

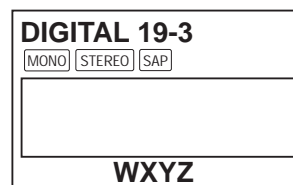

Custom Channel Label 'WXYZ' created in 2-5-4 + Menu (Add Channel Label) Mode



After Master TV setup has been completed, set Installer menu item 028 Ch Override to 000.

# Typical Connections Panel

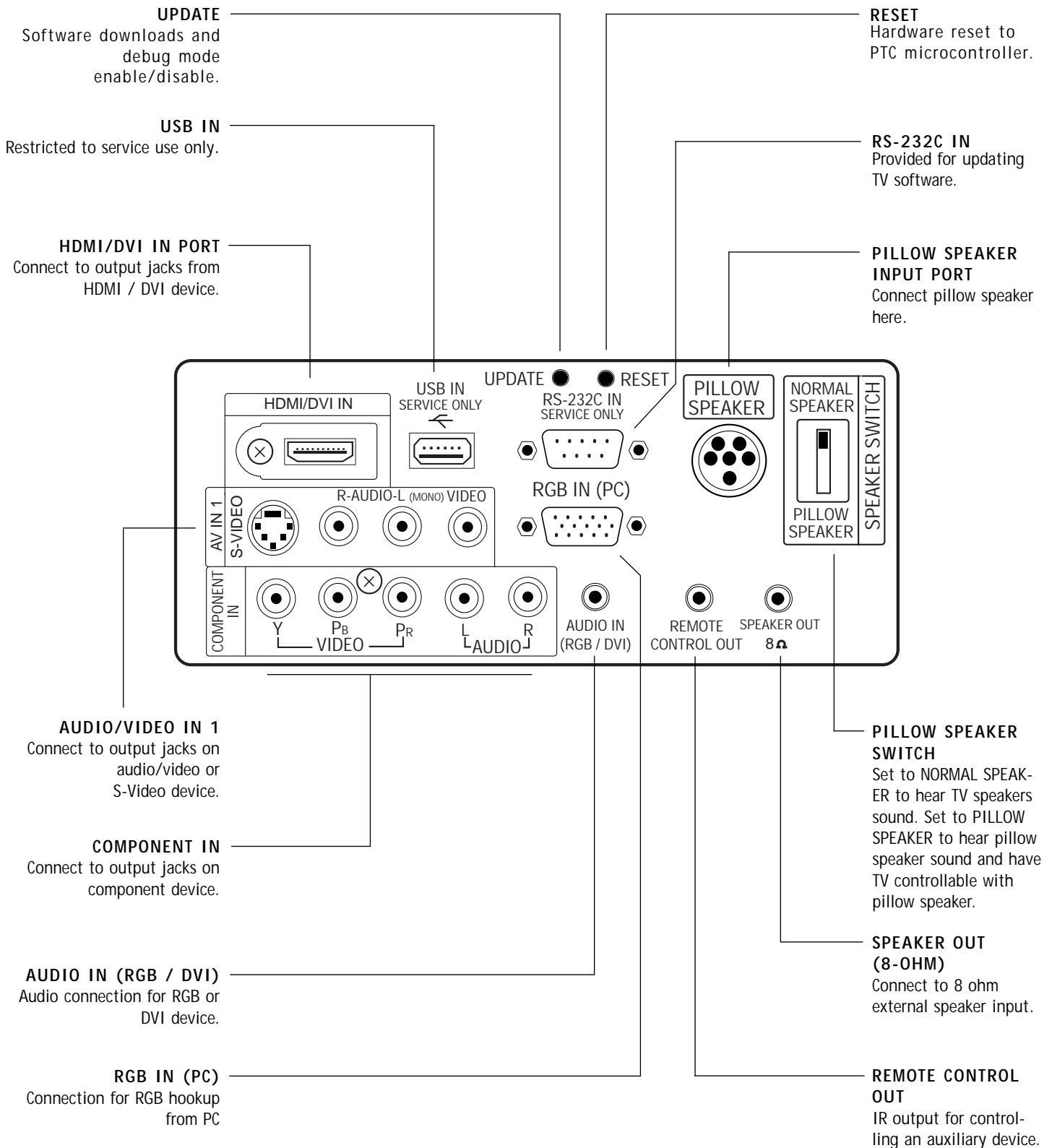



# A/V Input 2: Side Connections Panel / RF Antenna Connection

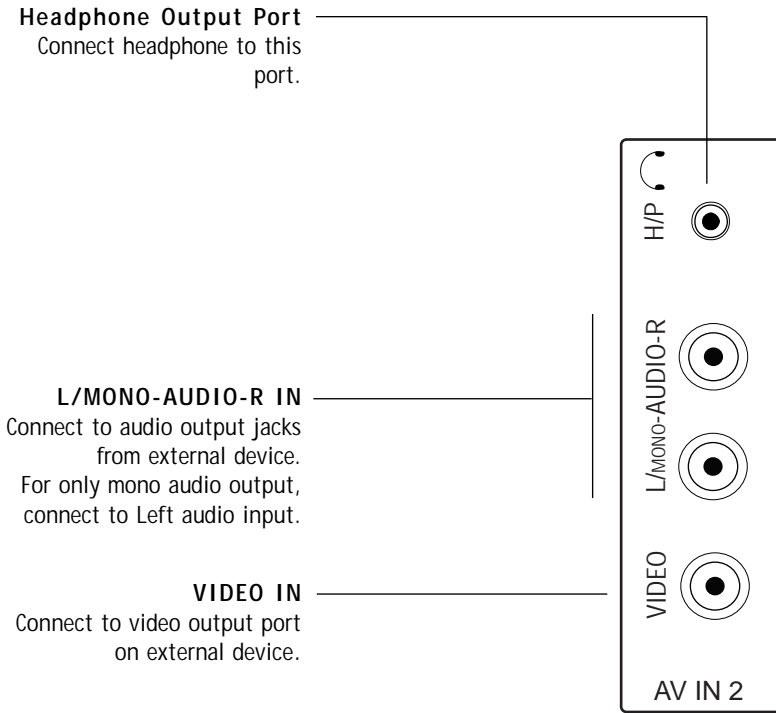

## RF Antenna Connection

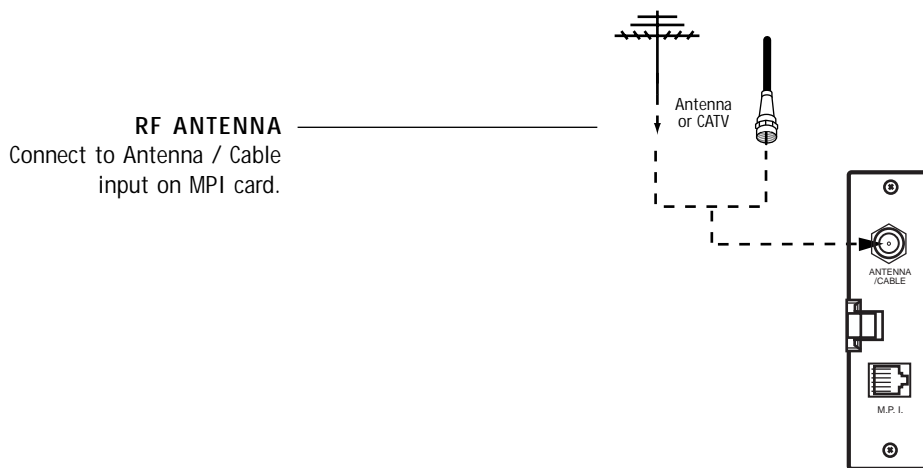

## MPI Card Slot

---

*The MPI card is equipped with an RF jack for antenna/cable signal source connection.  
The slot is also available for installing a PPV (Pay-Per-View) card.*

### MPI Card Removal / PPV Card Installation

1. Remove the two MPI card retainer screws.
2. Pull out current MPI card far enough so that the RF cable can be detached from the old card.
2. Detach RF cable.
3. Place new PPV card into slot and slide it in far enough to reconnect RF cable.
4. Reconnect RF cable.
5. Insert card all the way into the slot making sure it is fully seated into back plane connector.
6. Replace the two card retainer screws.

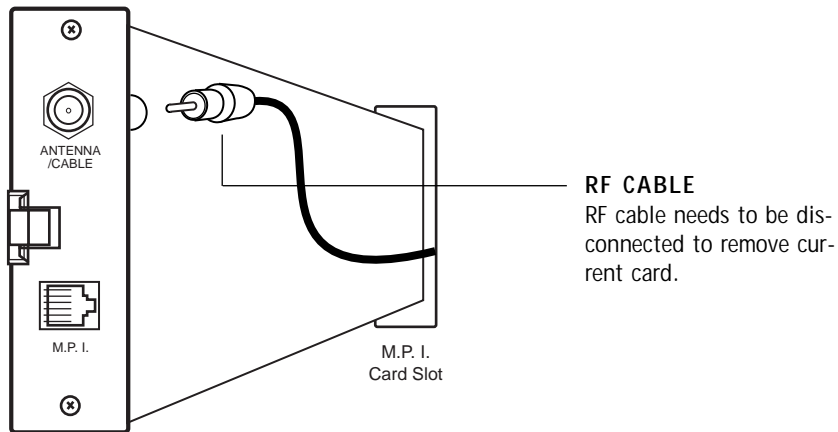

## General Guidelines: Choosing a Location for installing a VESA Standard Mount

To the right are some examples of VESA standard mounts. Since there are numerous types of stands and mounts available, only a few are shown here. Refer to the instructions provided with the TV stand that will be used to mount the TV. Be sure the style of stand selected is capable of supporting the weight of the TV and is appropriate for the application.

### Wall Mounts

If the mount will be on a wall, a typical wooden stud behind the wall board would be the preferred choice for a location to attach the wall mount. The wall mount location chosen should be appropriate for drilling holes and have available the required power source as well as antenna/cable and any other equipment leads as necessary.

### Pedestal Mounts and Stands

A sturdy surface on a desk or other similar flat table-like furniture would be the appropriate location for mounting a pedestal-style TV stand.

Most stands are designed so that the wiring is threaded through the stand itself or a loop-through style clamp so that the wiring is neatly bunched and not strung in such a way as to create a potential hazard to the user.

(Some stands are portable and can be moved from one location to another.) Be sure all safety considerations are followed.

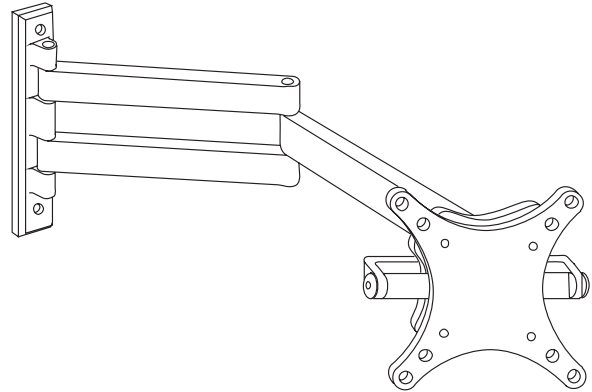

Typical Wall Stud Type Mount with Swivel Bracket

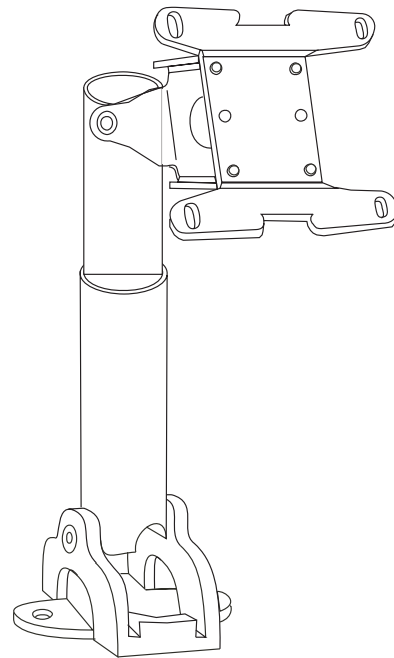

Typical Pedestal Type Mount with Swivel Bracket

# Installer Overview

## Operating Installer Menu

To set up the controls for the TV you will need to know how to enter the TV Installer menu and make changes to the default values. If necessary, familiarize yourself with the TV Installer menu and how to make and save changes to the items in the menu.

## LG Installer Remote

You will need an **LG Installer remote** control similar to the one shown to the right. The installer remote must have a "Source" button or its equivalent. The remote shown for reference in this manual has "INPUT" -- this button serves the purpose of a Source button.

The TV's clonable features need to be set up. This is a critical step. If the Master TV display panel's clonable features like added channel icons or channel labels are not done correctly, then the cloned TVs will all have problems. Refer to the TV menus for other TV features: Picture, Audio, Option, Closed captions, Lock (V-Chip), etc.

## TLL-1100A Clone Programmer

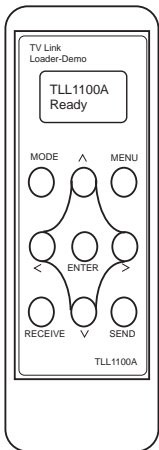

The TLL-1100A is a very simple cloner to use. It can be set up to clone a master TV setup and transfer it into a target TV. Cloning is possible using MPI protocol. Be sure the Master TV is set up completely. Cloning is only possible when the signal source is an Analog channel, not a digital channel. Refer to TLL-1100A instruction manual supplied with the cloner.

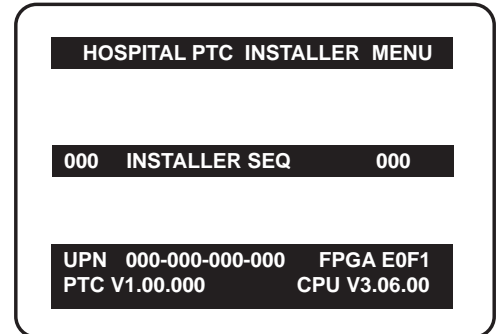

Typical Installer Menu

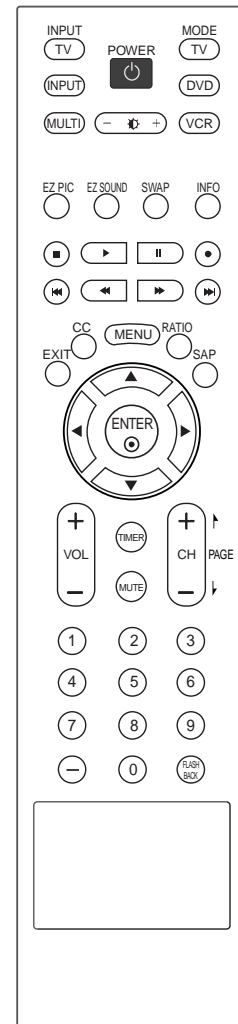

### Notes

- See the Installer's menus to set up the operational features of the TV. The Installer's section content is intended to be used primarily by qualified TV electronics technicians.
- Reference is made to installer remote controls used for menu operation within the manual. The remote information is provided for reference only. The typical installer remote control shown for reference in this manual may be different than the actual remote control used to configure the TV.
- For any additional information, contact your LG representative.

Note: Design and specifications are subject to change without prior notice.

Using the 32LG3DCH-UA Hospital TV, the patient has available the following entertainment options.

- Pillow Speaker control of TV.
- Auxiliary inputs on side connections panel, if enabled.
- Analog and Digital programming entertainment as provided by hospital:  
VHF, UHF, DTV, CATV, CADTV.
- 32 Inch screen size.
- 16:9 Aspect Ratio.
- SRS Surround Sound
- Digital Captions
- Tier programming as available through Channel Banks setup, RF delivered programming content options for premium as well as basic entertainment packages.
- Side headphone(s) output jack.

# Typical Installer Multi-Brand Remote Control

---

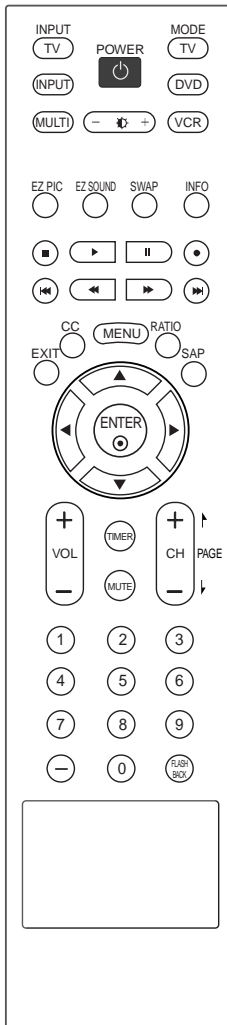

## LG Multi-brand Remote Control

Use the *MODE* button to select TV and put installer remote into TV operating mode.

*Notes:* This remote is not supplied with the TV. This typical LG multi-brand remote control is shown for reference.

See next page for typical key functions in TV operating mode.

Follow the instructions provided in the *Installer menu* section to configure the TV's features.

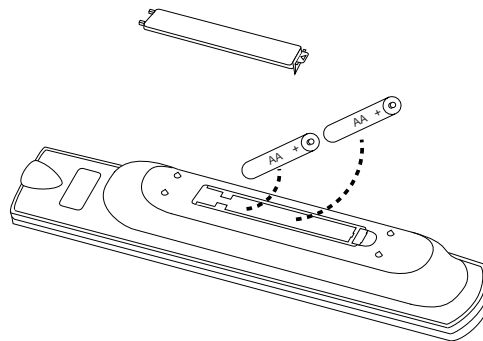

### Installing Batteries in Installer Remote Control

- Remove the battery compartment cover on the back side by pressing the arrow tab forward and lifting. Install batteries matching correct polarity as shown (+ with + and - with -).
- Install two high-quality alkaline 1.5V AA batteries. Never mix old or used batteries with new ones. Replace cover.

# Installer Remote Control Typical Key Functions

*Remote Control Key Functions. To put remote into TV operating mode, select TV with the MODE key.*

**Notes:** This remote is not supplied with the TV. This typical LG multi-brand remote control is shown for reference. Follow the instructions provided in the Installer menu section to access the Installer menu.

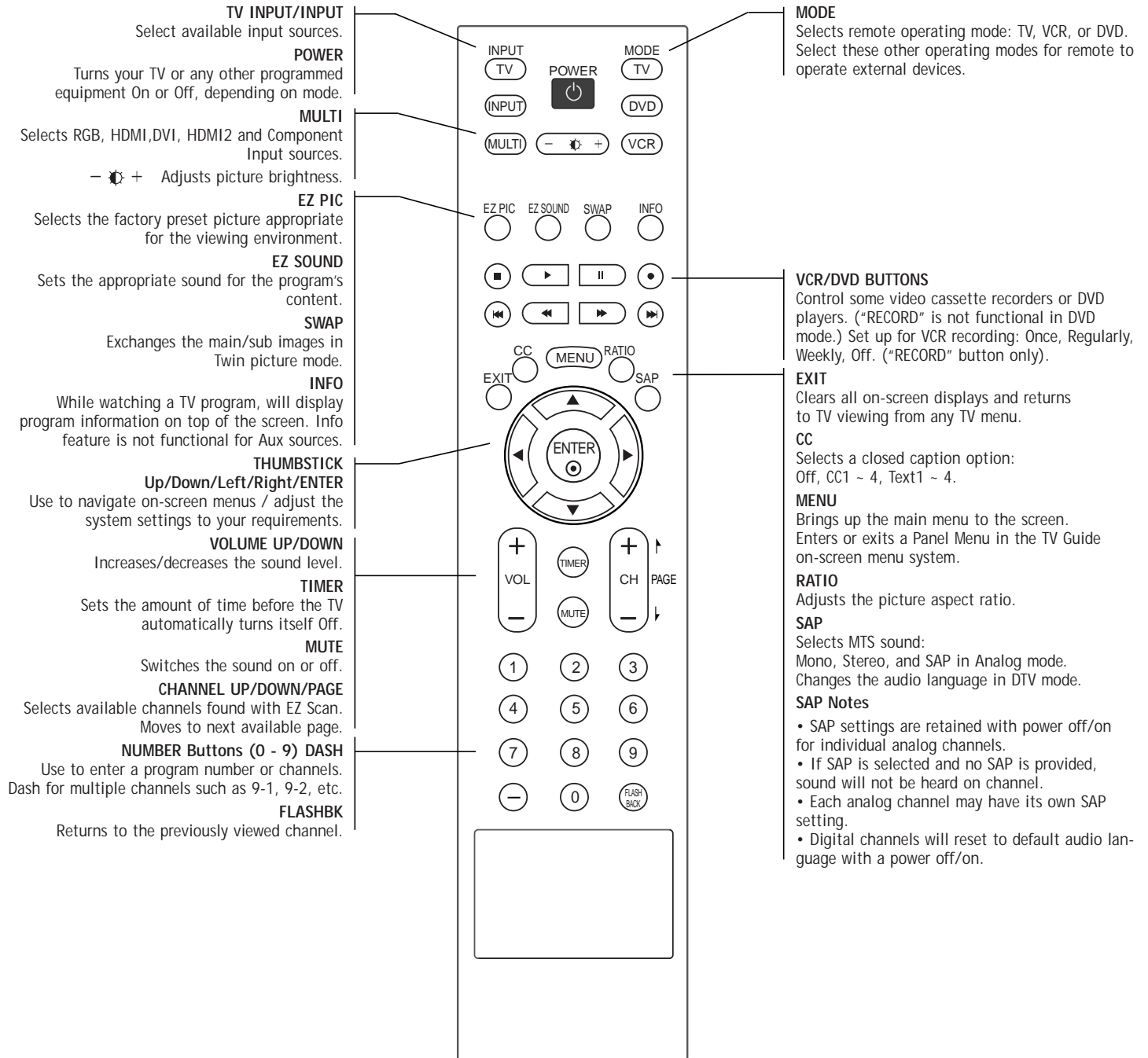

# Pillow Speaker Connections

Set up Pillow Speaker after commercial mode setup and cloning procedures are complete

## Pillow Speaker Setup

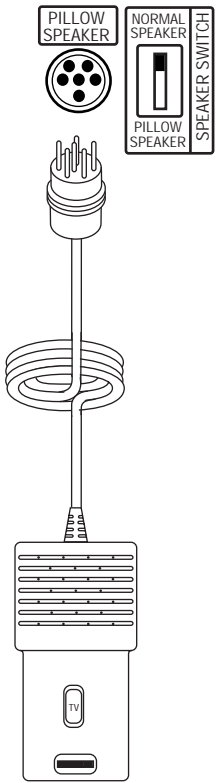

### Pillow Speaker used in your system?

- Connect pillow speaker and slide control switch to 'Pillow Speaker' to control TV and hear audio on pillow speaker.
- For TV speakers sound with pillow speaker control, set switch to 'Normal Speaker' on connections panel.

### Controlling the TV with Mechanical Switches

Pin 4 (common) is momentarily connected to pin 1, 3, or 6 via push-action switches to control power On/Off and Channel Up/Down. These pins are at +13 volts DC (when measured from pin 4) with the switches open. Current draw is 8 mA when a switch is closed. (This operation is identical to previous models using the 5-Wire Interface except that only +7 volts DC was supplied and current draw was only 2.5 mA.)

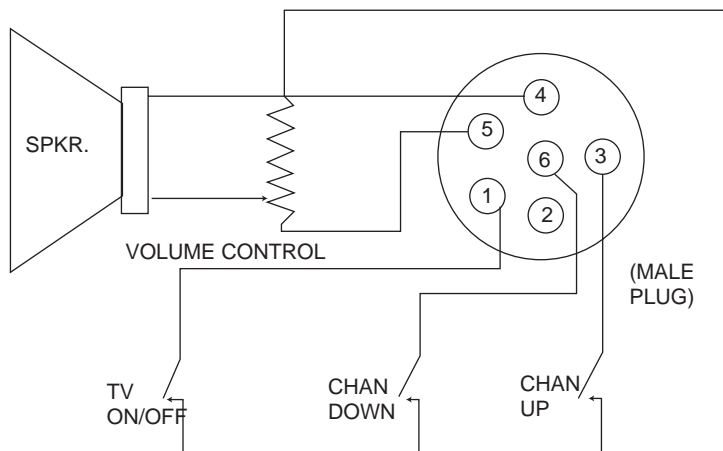

## Pillow Speaker Control

### Pillow Speaker Interface

This connector furnishes three control lines and an audio output. A patient-pendant remote control, or entertainment audio and nurse call system may be connected here. All lines are isolated from the AC power line and earth ground. (Opto-isolators isolate the control lines, and a transformer isolates the audio. There are no relays or inductive components in the control lines.)

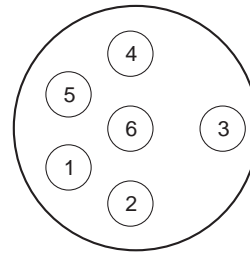

- 1 | ————— TV ON/OFF
- 2 | ————— OPEN
- 3 | ————— CHAN UP/DATA IN
- 4 | ————— COMMON
- 5 | ————— AUDIO OUT
- 6 | ————— CHAN DOWN

Pin No.	Purpose
1	External TV On/Off switch.
2	(Not used.)
3	External Channel Up switch or Data in.
4	Common connection for control, data, and audio output. Impedance to earth ground is a 10-meg resistor in parallel with a 1100 pf capacitor.
5	Isolated audio output. Nominal 14-ohm source impedance with short circuit protection. Intended for a pillow speaker with a low-impedance pad-type volume control.
6	External Channel Down switch.



The onscreen menus allow the Installer to set up the basic TV features

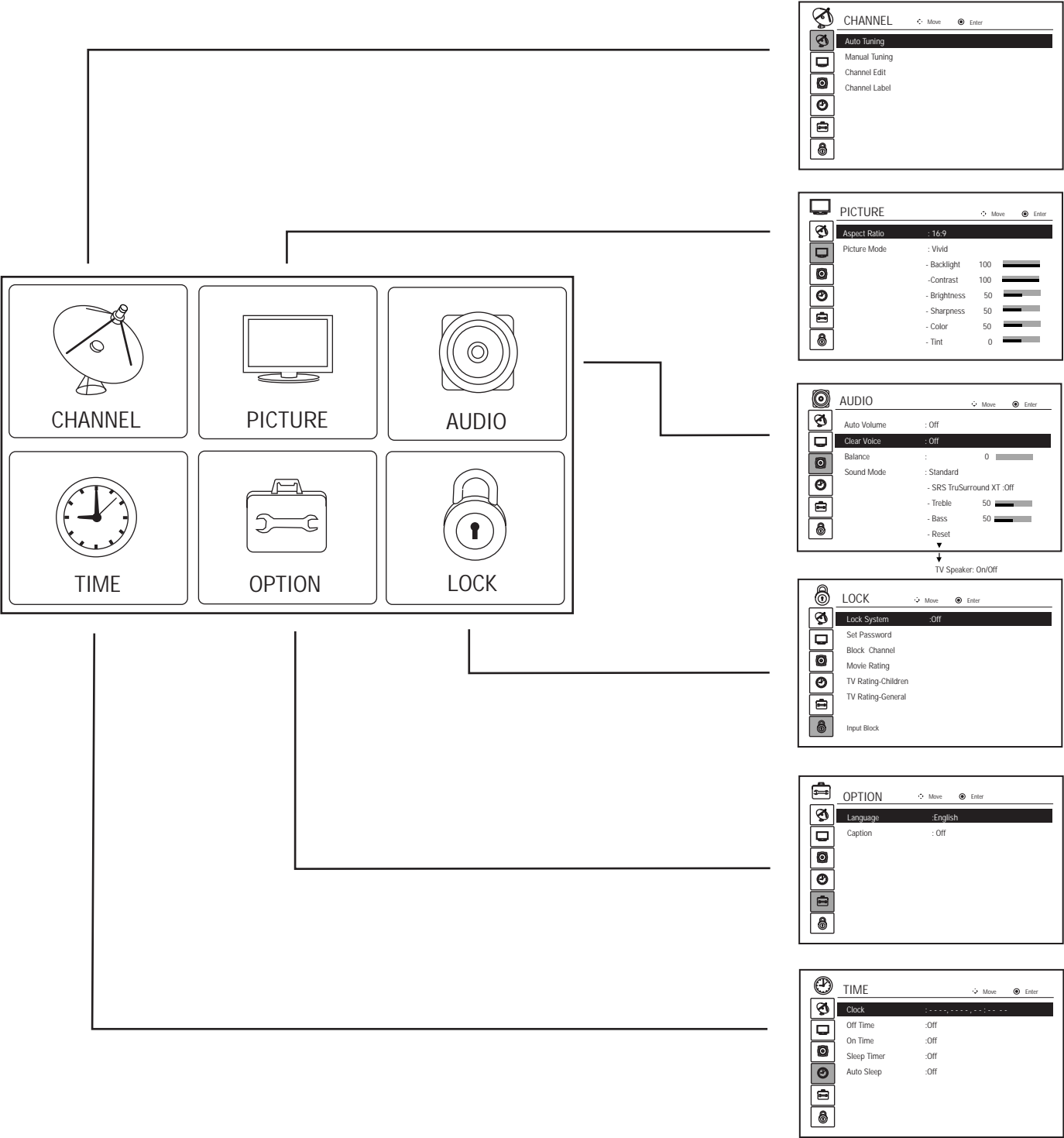

# Channel Menu

The Channel menu contains the channel search and channel scanning setup options

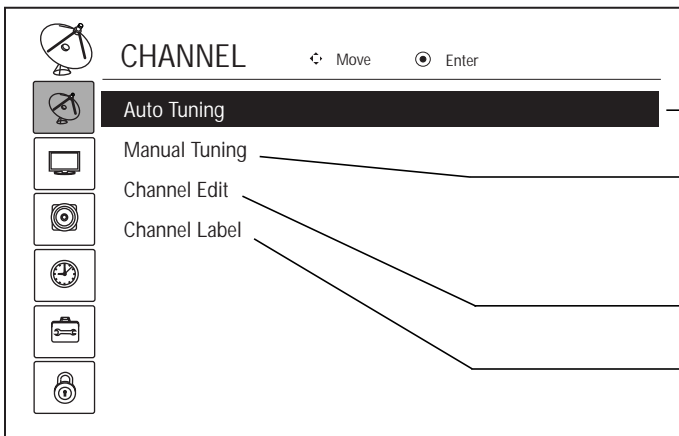
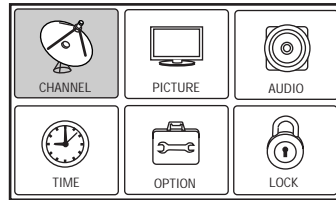

## Purpose

- Searches for analog and digital channels.
- Gives the Installer the option to manually add channels to channels list in TV memory.
- Shows signal strength for selected channel.
- Allows Installer to add/delete channels in channel memory.
- Adds an identifying logo to channel time OSD.

## Channel Menu Navigation

### Typical Menu Operation

#### Auto Tuning (Channel Search)

1. Press Menu on the Installer remote.
2. Select the Channel Menu Option and press Enter.
3. Go to the Auto Tuning option with the Up/Down/Left/Right arrow keys.
4. Press Enter.
5. Press Enter again to start the channel search.
6. Press Menu to remove Channel menu from screen.

The Picture menu settings control the appearance on the TV picture

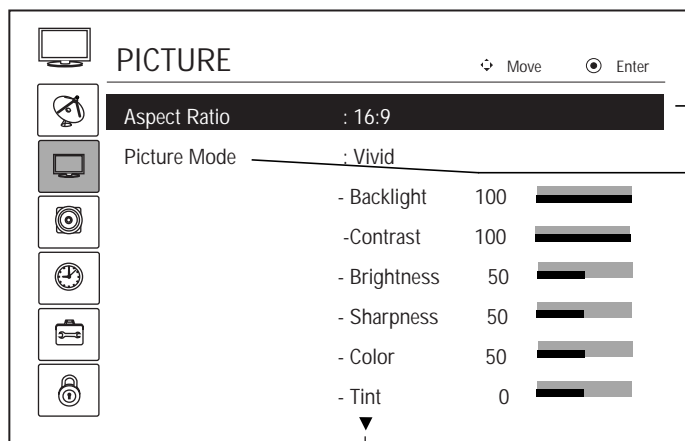
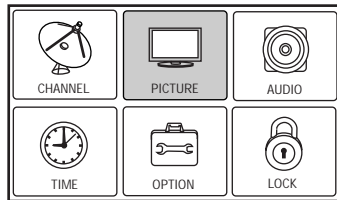

## Purpose

Sets the picture proportion.

Selects factory preset picture options.  
Also allows the Installer to specify custom picture setups.

Note: There are additional menu options accessible with the down arrow.

## Picture Menu Navigation

### Typical Menu Operation

#### Picture Mode

1. Press Menu on the Installer remote.
2. Select the Picture Menu Option and press Enter.
3. Go to the Picture Mode option with the Up/Down/Left/Right arrow keys.
4. Press Enter.
5. Use the Up/Down/Left/Right arrow keys to select Picture Mode. Choose from preset or make custom picture appearance settings.
6. Press Menu to remove Picture menu from screen.

# Audio Menu

The Audio menu configures the TV sound options

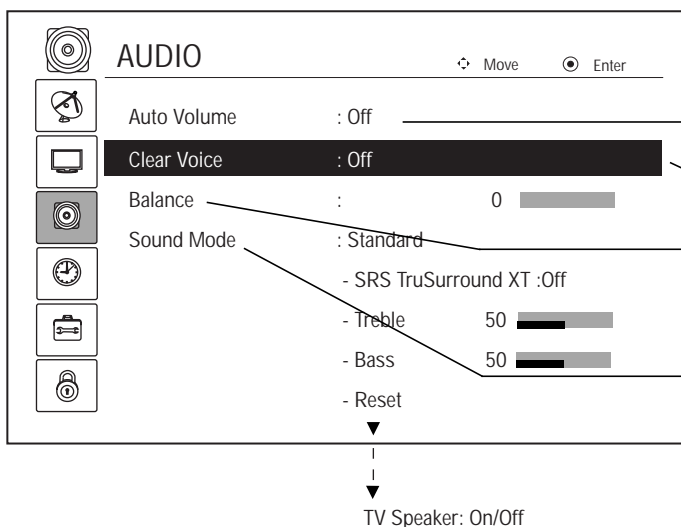
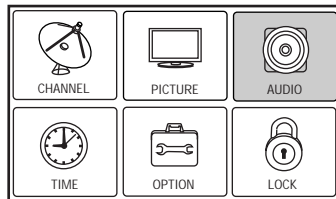

## Purpose

Enables and disables the Auto Volume option.\*

Enables and disables the Clear Voice option.

Gives the Installer the option to set the sound output more to the Left or to the Right speaker.

Selects preset optimum audio output based on program content. The Installer can also make custom sound settings.

Note: There are additional menu options accessible with the down arrow.

## Audio Menu Navigation

### Typical Menu Operation

#### Sound Mode

1. Press Menu on the Installer remote.
2. Select the Audio Menu Option and press Enter.
3. Go to the Sound Mode option with the Up/Down/Left/Right arrow keys.
4. Press Enter.
5. Select from the preset sound output options or make custom sound settings.
6. Press Menu to remove Audio menu from screen.

\* Note: Auto Volume is disabled if the Pillow Speaker switch is set to 'Pillow' Speaker'.

The onscreen menus control the basic TV features

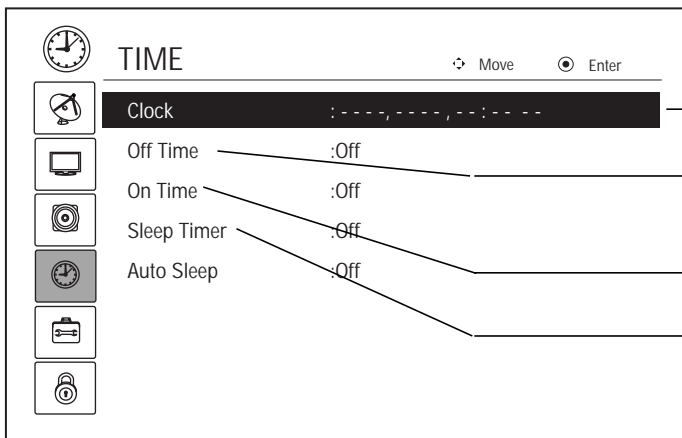
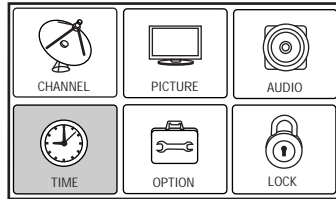

**Purpose**

- Set the internal clock on the TV automatically or manually.
- Sets a time the TV will automatically turn Off each day.
- Sets a time the TV will automatically turn On each day.
- Sets a time the TV will turn itself Off, once.

**Time Menu Navigation**

Typical Menu Operation

**Sleep Timer**

1. Press Menu on the Installer remote.
2. Select the Time Menu Option and press Enter.
3. Go to the Sleep Timer option with the Up/Down/Left/Right arrow keys.
4. Press Enter.
5. Select a Sleep Timer TV turn Off time.
6. Press Menu to remove Time menu from screen.

# Option Menu

The Option menu can be used to configure digital captions for the end user

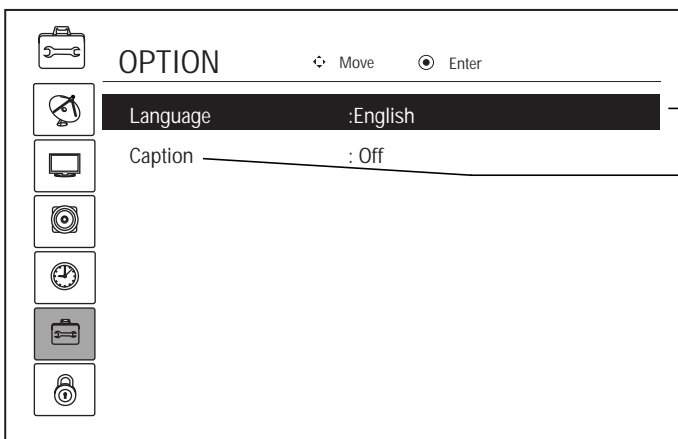
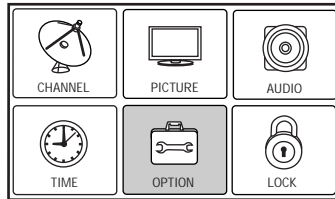

## Purpose

Selects English, Spanish or French.

Enters the captions setup menu.

Allows the Installer to specify which analog or digital captions will appear.

The Installer can customize the appearance of the digital captions.

## Option Menu Navigation

Typical Menu Operation

### Caption

Turns captions On/Off and enters submenus

1. Press Menu on the Installer remote.
2. Select the Option Menu and press Enter.
3. Go to the Captions option with the Up/Down/Left/Right arrow keys.
4. Press Enter.
5. Set up Caption menu and Digital Captions submenus options.
6. Press Menu to remove Option menu from screen.

The Lock menu can be used to set up V-Chip (Parental Control)

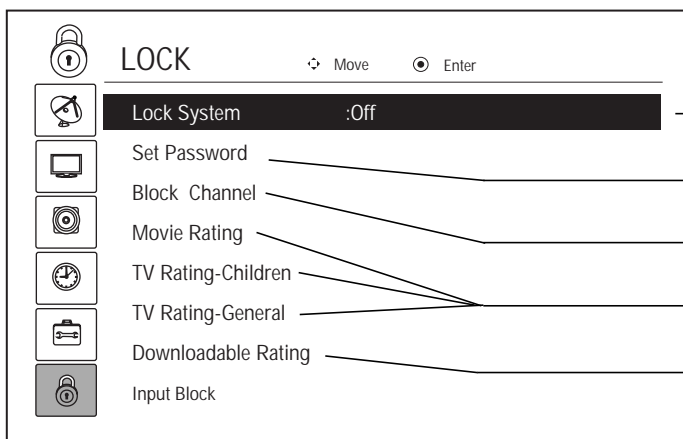
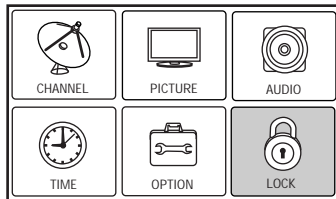

### Purpose

- Enables and disables the parental lock.
- Sets the V-Chip password.
- Allows the Installer to block individual channels.
- The remaining Lock menu options set up individual V-Chip controls for programming that can appear.
- If provided on program, additional blocks can be set to restrict programming that can appear.

## Lock Menu Navigation

### Typical Menu Operation

#### Lock System

1. Press Menu on the Installer remote.
2. Select the Lock Menu Option and press Enter.
3. Go to the Lock System option with the Up/Down/Left/Right arrow keys.
4. Press Enter.
5. Set the Lock system to be enabled or disabled. Set up V-Chip blocks for the available Parental Control options.
6. Press Menu to remove Lock menu from screen.  
Note: Installer can enter 7-7-7-7 to access Lock menu if it is active and password is not available.

# Channel Banks Overview

Channel Banks Note: Disable all Aux sources in the Installer menu that will not be made available to the end user.

## Channel Banks Overview

Purpose of Channel Banks: Allows the institution administrator to control access to patient in-room TV programming. A channel bank can be enabled for a patient for a pre-determined fee. For Banks 1-2 and 3, the institution can create programming levels. Each level would offer a custom channel line-up. Top tier would be the most programming (premium etc.), 2nd tier=lesser programming, 3rd tier=basic programming etc. Channel Bank 4 would display the 'Inactive TV Call Attendant' message when the TV is turned on. The administrator could activate Banks 1-2 or 3 depending on the programming tier selected by the patient. When the patient leaves the hospital, the administrator can then select Bank 4 to reinstate the Inactive TV message.

## Channels Available Charts

All channels found in the channel search are included in all channel banks. Default is for all channels to be active in channel banks 1-2-3 and 4. Create channel banks charts similar to the examples on the following pages. Show on the channel bank chart, the status for each channel in all channel banks. This then becomes the patient entertainment programming offerings plan.

## Channel Banks Setup

Operating the Channel Banks menu.

Note: Channel banks can only be set up after the 2-5-5+Menu procedure has been completed. See remote key functions for channel banks menu on the following page.

## Channel Status Options Available for Channel Banks

In the Ch Preview-Channel Banks menu, use the channel up-down arrows to go to a channel and the Left-Right arrows to select the channel status. See channel status chart.

## Inactive TV Setup

Go to Channel Bank 4. Select 'Normal Delete' for all channels. When the TV is powered on by the patient, the 'Inactive TV Call Attendant' message will appear on the screen and after a few moments the TV will turn itself off. With the Installer remote, the administrator can activate Banks 1, 2 or 3 depending on the entertainment programming tier selected by the patient. When the patient leaves the hospital, the administrator can then select Bank 4 to reinstate the 'Inactive TV' message.

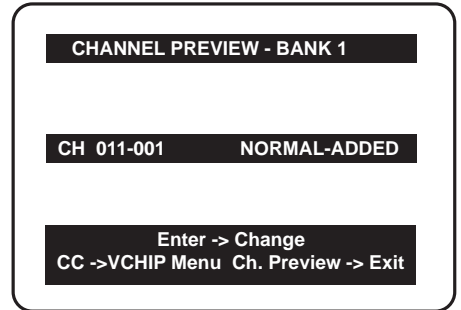

Channel Bank Setup Menu

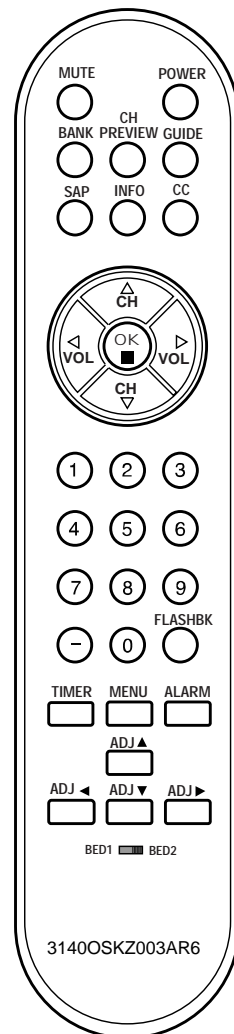

Use to access Ch Preview Menu

Note: Default setting for Aux sources is to be active in the Installer menu. The Aux sources will appear between the highest Analog and lowest Digital channel number in the channel scan with Channel Up/Down. If the Aux sources will not be used, it is advisable to set them to 000 (Off) before doing 2-5-5 + Menu. After doing 2-5-5 + Menu, the only way to turn the Aux sources off so they will not appear in the channel scan, is to go to the Channel Bank menus and select 'Normal Delete'. Refer to Installer menu items: 34, 35, 38, 39 and 87.



# Channel Banks Setup Installer Remote Control Key Functions

## Channel Banks Setup Remote Control Key Functions

After doing 2-5-5 + Menu, select a channel bank with the input/source or Banks button. After desired bank is selected, press Ch Preview to display the Channel Banks editing menu.

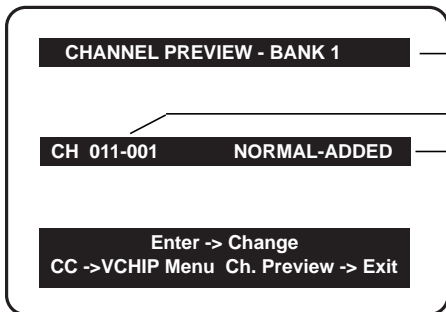

Channel Bank Setup Menu

Shows currently selected Channel Bank.

Shows currently selected Channel.

Shows channel status in selected bank.

**In Channel Banks menu, use the Left-Right arrows to select:**

Normal-Added Channel will appear in channel scan.

Normal-Deleted Channel will not appear in channel scan.

Blank-Added Channel will appear in all channel banks, video will be black, no picture.

Blank-Deleted Channel will be blanked in all channel banks.

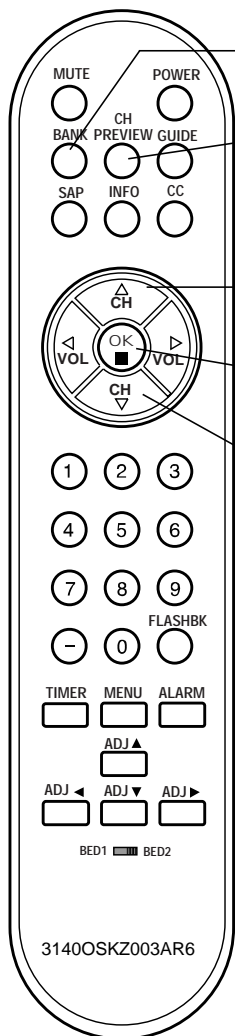

Typical Installer Remote Control

**Bank**

Selects channel banks 1-2-3-4.

**Ch Preview**

Selects channel banks setup menu.  
Exits menu.

**Channel Up**

Selects next higher channel number.

**OK (Enter)**

Tunes in deleted channels in scan.

**Channel Down**

Selects next lower channel number.

**Up/Down Left/Right ADJ Arrows**

**Up-Down** Tune to added channels in menu.

**Left-Right** Choose menu options.

Note: Pressing CC Displays V-Chip menu.

# Channel Banks Setup

Use the Channel Banks to format the channel lineup programming package options for the end user

Each channel bank is capable of storing broadcast digital and analog channels

Figure 1. Typical channel banks after running Auto Tuning

BANK	Purpose	Channel Number																								
		1	2	3	4	5	6	7	8	9	10	11	12	13	14	15	16	17	18	19	20	21	22	23	24	25
1				A		A		A		A					A	A	A	A	A	A	A		A	A	A	A
2				A		A		A		A					A	A	A	A	A	A	A		A	A	A	A
3				A		A		A		A					A	A	A	A	A	A	A		A	A	A	A
4				A		A		A		A					A	A	A	A	A	A	A		A	A	A	A

A = Active - - Channel was found during AUTO TUNING

Figure 2. Typical channel banks after running Auto Tuning, and customizing with Add/Del/Blank

BANK	Purpose	Channel Number																								
		1	2	3	4	5	6	7	8	9	10	11	12	13	14	15	16	17	18	19	20	21	22	23	24	25
1	Basic	BC	A			A		A		A					D	D	D	D	D	D	D		D	D	D	D
2	Extend	BC	A			A		A		A					A	D	A	D	A	A	A		D	D	D	D
3	All CTV	BC	A			A		A		A					A	D	A	D	A	A	A		A	D	A	A
4	Other	BC	A			A		A		A					A	A	A	A	A	A	A		A	A	A	A

A = Active Channel was found during AUTO TUNING  
 D = Delete Channel was deleted using Add/Del option.  
 BC = Blanked Channel Channel was blanked using BLANK channel option (ADD/DEL/BLNK).

## Adding / Deleting / Blanking Channels

It is best to do ADD / DEL customizing before doing "BLANK." Auto Tuning (channel search) enters the same channel numbers in channel banks 1, 2, 3 and 4. Auto Tuning removes any channels previously customized with ADD / DEL / BLANK. The channels found in the channel search on your antenna / cable will be included, and any channels previously found but not currently available will not be included. ADD and DEL (not BLANK) can be used independently for channel banks 1, 2, 3 and 4. (If a channel is not found in the channel search, it can be added see the Channel Menu Manual Tuning option.)

**Notes:** A channel blanked, is blanked in all channel banks.

## Selecting Deleted Channels

To tune to a Normal Delete channel: Select a Channel Bank where the channel is added. Or, direct enter the channel number then go to the bank where the channel is set as 'Normal

Delete' and reconfigure the channel status.

Note: Ch Override must be set to 001 to allow access to the channel scan.

Channel allocations in tuning bands:

- Broadcast and Broadcast Digital: 2 - 69
- CABLE - CATV, HRC or ICC: 1 - 125

## Inactive TV Setup for Channel Bank 4

To create an inactive TV display on Channel Bank 4, select Normal Delete for every channel in Bank 4. When Bank 4 is selected with the bank button on installer remote, the Inactive TV, call attendant will be shown on the TV screen. The TV will turn itself off afterward. This will prompt the patient to arrange for an available programming package on Banks 1, 2 or 3.

# Reference: Channel Banks Worksheet

Use the Channel Banks worksheet provided below to plan your program packages. Photocopy additional worksheet as needed.

PLAN YOUR CHANNEL BANKS BY FILLING IN THESE CHARTS (or use photocopies)

B A N K	Purpose	Channel Number																								
		1	2	3	4	5	6	7	8	9	10	11	12	13	14	15	16	17	18	19	20	21	22	23	24	25
1																										
2																										
3																										
4																										

B A N K	Purpose	Channel Number																												
		26	27	28	29	30	31	32	33	34	35	36	37	38	39	40	41	42	43	44	45	46	47	48	49	50				
1																														
2																														
3																														
4																														

B A N K	Purpose	Channel Number																													
		51	52	53	54	55	56	57	58	59	60	61	62	63	64	65	66	67	68	69	70	71	72	73	74	75					
1																															
2																															
3																															
4																															

B A N K	Purpose	Channel Number																													
		76	77	78	79	80	81	82	83	84	85	86	87	88	89	90	91	92	93	94	95	96	97	98	99	100					
1																															
2																															
3																															
4																															

B A N K	Purpose	Channel Number																								
		101	102	103	104	105	106	107	108	109	110	111	112	113	114	115	116	117	118	119	120	121	122	123	124	125
1																										
2																										
3																										
4																										

Date \_\_\_\_\_ Installer \_\_\_\_\_ Page \_\_\_\_ of \_\_\_\_  
 Location \_\_\_\_\_

# Upgrading TV Software with USB Memory Card

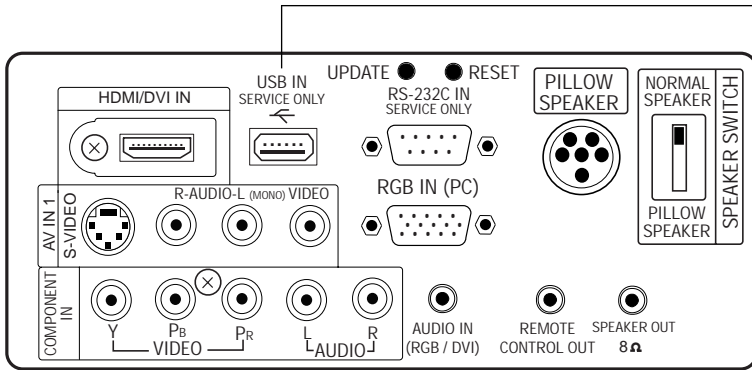

TV Rear Connections Panel

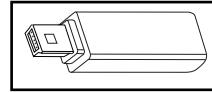

## On USB Memory Card

Assure that memory card has been formatted with FAT format.

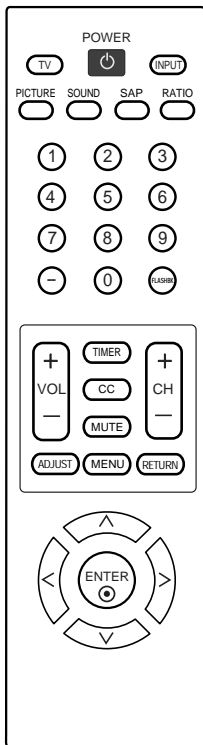

Use Installer Remote to Operate Menus

## Upgrading TV Software

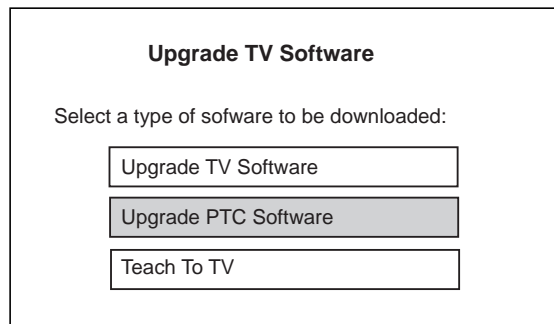

1. Plug USB Memory Card into USB In port on TV.
2. Menu should appear, if not press the Menu key.
3. Use Up/Down arrow keys to navigate through the upgrades. Select the upgrade that you want to install by highlighting it and pressing the

## Teach To TV

The following software files are found in the memory card.  
Select the file you want to download to this TV.  
Or, Press EXIT to cancel the upgrade.

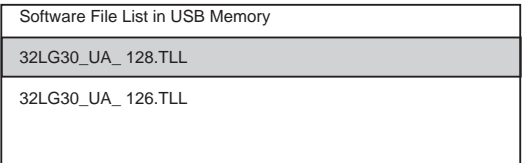

4. Copying progress will be shown. When upgrading is complete, the TV will turn Off.

## Optional: Edit/Change File Name

If necessary, the file name can be edited or changed.

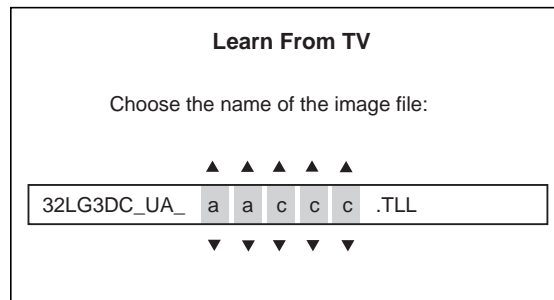

## Notes

- Do not remove TV power cord or USB memory card while Learning, doing so might harm your USB memory card.
- Do not remove TV power cord or USB memory card while Teaching, doing so may cause the TV to malfunction.
- You are allowed to edit the file name, however, a file with edited contents will not be recognized.
- Since clock data is copied into USB memory card as numeric data, the time difference between teaching and learning is not automatically adjusted. Either set the clock manually, or use Auto Clock set on TV main menu.

# Master TV Profile Setup Learning/Teaching with USB Memory Card

---

## On Master TV, Create Profile and Learn

1. Set up all Master TV features on the menus and do a Channel Search. Add Channel and Aux Labels etc. Tune in an analog channel.
2. Plug USB memory card into the USB In port on Master TV.
3. Press Menu key to open Main menu. Highlight the Option icon.
4. Press the Left arrow key once, the Option icon on left side of menu will be highlighted.
5. Press number key '7' a total of 7 times.
6. Key in password\* used to enter Installer Menu.
7. Using Up/Down arrow key, highlight "Learn Current Profile", then press Enter.
8. To identify the profile from others, you can change the last 5 digits. Key in a custom file name, then press the Enter key.
9. The Learning status will be shown on progress bar. As soon as learning the current profile is complete, a message will appear on screen indicating the learning process is done.
10. Remove the USB memory card.

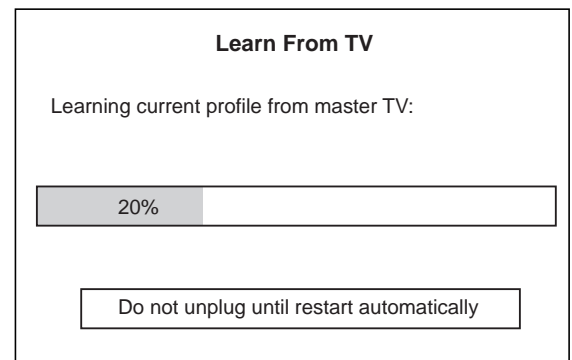
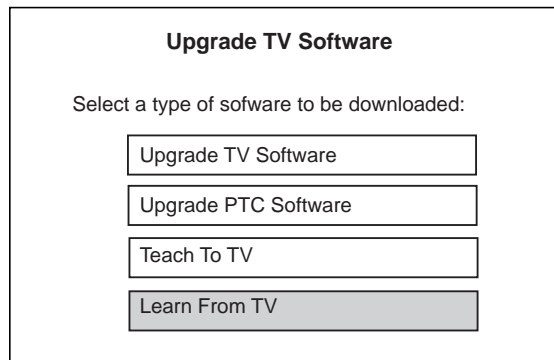

\* See Installer Menu pages.

## On Target TV, Teach Master TV Profile

1. Plug USB memory card with Master TV Profile setup into Target TV USB In port.
2. Press Menu key to open Main menu and then highlight the Option Menu icon.
3. Press the Left arrow key once, this will highlight the Option icon on left side of menu.
4. Press number key '7', a total of 7 times.
5. Using the Up/Down arrow key, select 'Teach New Profile', then press Enter key.
6. Use Up/Down arrow keys to navigate through profiles. Select the profile that you want to install by highlighting it and pressing the Enter key.
7. Teaching progress will be shown on the progress bar. As soon as teaching is done, a message will appear indicating that the teaching process has been completed.

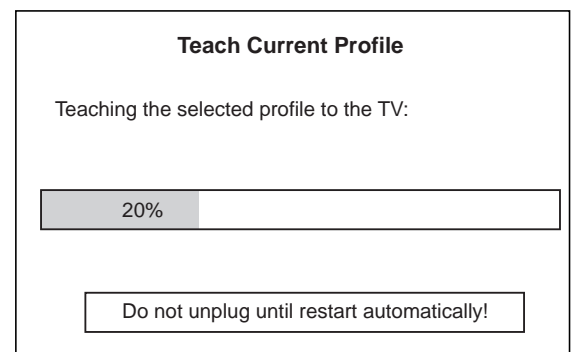

# TLL-1100A Clone Connections / Learning and Teaching Setups

## Connections for the TLL-1100A Clone Programmer to Learn the Master TV Setup

### On Master TV

Set up all Master TV features on the menus and do a Channel Search. Add Channel and Aux labels etc. Tune in an analog channel. Insert MPI cable into TV MPI port.

### On TLL-1100A

1. Turn On the TLL-1100A.
2. Use the Mode button to select Clone Mode.
3. Use the Left/Right arrow to select the CBank (1 - 8) to store the master TV setup in.
4. Plug the other end of the MPI cable into the MPI port on the bottom of the TLL.
5. With the Installer remote control, select item 1 on TLL menu.
6. Press Enter, to transfer the Master TV setup into CBankX on the TLL. The TLL will copy the master TV setup.
7. When learning is done, disconnect MPI cable from Master TV.

### On Target TV

1. Connect MPI cable from the TLL to the MPI port on the Target TV. Assure that the correct CBank(X) is selected on TLL.
2. With the Installer remote control, select item 2 to Teach the target TV the master TV setup.
3. Press Enter to begin teaching.
4. When Teaching is done, disconnect MPI cable and power the TV Off. Unplug TV power cord.
5. Reconnect TV power cord. Power the TV On and the master TV setup should be resident on the target TV.

### M.P.I. Learning Setup

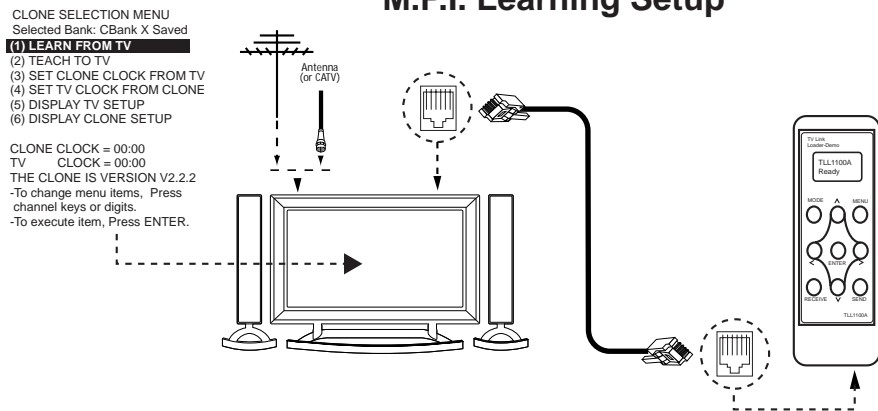

### M.P.I. Teaching Setup

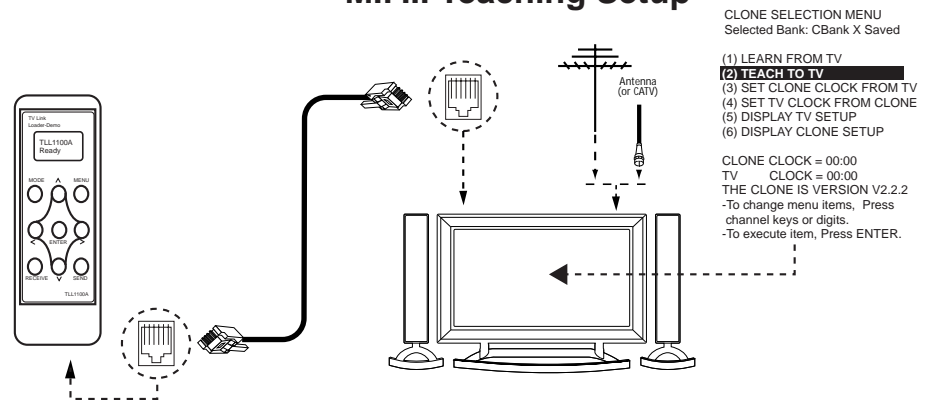

**Warning:** Do not use the TLL-1100A while any PPV card is installed or clone programmer device will be damaged.

**Notes:** It is assumed that the TV is connected to a signal source, the TV source selected is Antenna (RF) In, the signal is from an Analog channel, not a digital channel, all equipment is connected to power and turned on and the TLL-1100A Cloner main menu is displayed on the TV screen, see above.

## Connections for the LT2002 Clone Programmer to Learn the TV Master TV Setup

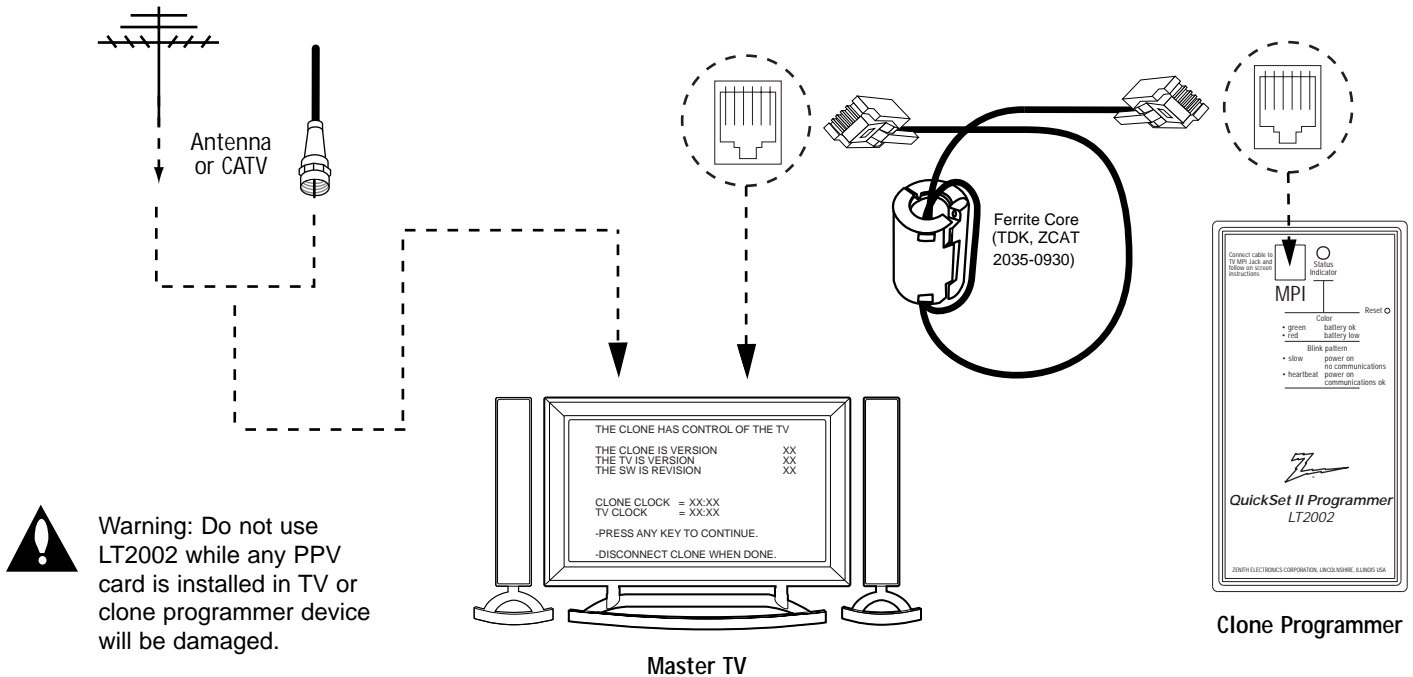

Notes: It is assumed that the TV is connected to a signal source, the source selected is Antenna (RF) In, the signal is from an Analog channel, not a digital channel, all equipment is connected to power and turned on and the LT2002 Clone Programmer main menu (THE CLONE HAS CONTROL OF THE TV) menu is displayed on the TV screen, see above and next page.

### Before you begin cloning...

- The Master TV should be connected to a good, stable signal from an over-the-air antenna or cable service Analog channel and connected to power. (See above.)
- Teaching and Learning is only possible between identical model TV/STBs. (However, the LT2002 Clone programmer can store up to 3 different 'master' setups.)

**WARNING:** Copying a blank or incorrect memory into a TV, STB or other device will cause the TV, STB or other device to operate erratically or become inoperable.

- Use an Installer's remote to operate Learning and Teaching menus.
- Make sure that the batteries in the Clone programmer are fresh.

- If batteries are removed, the Clone Clock time will be lost.
- Decide if you want to set the time from the Clone programmer or copy the time to the Clone programmer; from a compatible TV which has had the clock set to the current time.
- Setting the time and transferring it to the Clone or other device is a separate procedure.
- Follow the connection diagram above to connect the Clone to a Master TV display panel. After learning is complete, to another identical TV display panel to "teach" it the master TV setup.
- See the Clone Troubleshooting section to resolve problems.

**Turn to the next page to continue Cloning Setup.**

# Cloning Learning Setup

## Learning the Master TV Setup

### Instructions for the Clone Programmer to Learn the Master TV Setup

#### Use MPI Cable to Connect LT2002 Clone Programmer to Master TV MPI Port

If there is a good connection, "THE CLONE HAS CONTROL OF TV" message will appear. Press any key on the Installer remote.

#### Learn Setup from Master TV

Press 1 to select the "LEARN FROM TV" option, then press ON/OFF, POWER, or ENTER to go to the Memory Bank Selection Menu. Pick the Memory "Bank" you want to store the master TV's setup in by pressing either Channel key repeatedly to choose Memory 1, 2 or 3. (If you choose a Memory "Bank" that has a master device's setup programmed into it, that setup will be overwritten by the new master TV's setup.) Once the Clone memory bank is selected, press ON/OFF, POWER, or ENTER. The Clone memory bank you have selected will be shown. Press ON/OFF or POWER to begin copying the master TV's setup.

#### Set the Clock (Optional)

Set the time on a Master TV's Clock. (If the time has already been copied from a TV into the Clone programmer, you can set a master TV's clock by copying the time from the Clone programmer.) The Clone Programmer can copy the current time to both a master TV and to the Clone's internal clock; accurate to within one minute. (Another reason that the Clone programmer should be equipped with fresh, high-quality alkaline batteries, is for it to keep the time as accurately as possible.)

Since the Clone Programmer's time cannot be set directly, the current time needs to be copied from a Zenith/LG TV equipped with M.P.I. input capability.

After the time is copied to the Clone programmer, the current time can then be transferred to another TV. (This can be a master TV, or another TV which has already had the features set up.)

THE CLONE HAS CONTROL OF THE TV

THE CLONE IS VERSION           XX  
THE TV IS VERSION            XX  
THE SW IS REVISION           XX

CLONE CLOCK=                XX:XX  
TV    CLOCK=                XX:XX

-PRESS ANY KEY TO CONTINUE.

-DISCONNECT CLONE WHEN DONE.

This menu should appear by itself after the LT2002 is connected to the TV MPI port.

CLONE SELECTION MENU

- (1) LEARN FROM TV
- (2) TEACH TO TV
- (3) SET CLONE CLOCK FROM TV
- (4) SET TV CLOCK FROM CLONE
- (5) DISPLAY TV SETUP
- (6) DISPLAY CLONE SETUP

-TO CHANGE MENU ITEMS, PRESS CHANNEL KEYS OR DIGITS.

-TO EXECUTE ITEM, PRESS ON/OFF, POWER, OR ENTER

This menu should appear after any key is pressed on the Installer remote.

#### LT2002 Clone Programmer Communication Problems

- A slow flashing green light indicates there are communication problems between the TV and the LT2002 clone programmer. If this is the case, check for a damaged cable, poor contacts, or other connection troubles.
- If the status indicator is red, the programmer batteries are low and should be replaced. Install 4 high-quality alkaline AA batteries.



## Teaching the Master Setup to Another TV

Connections for the LT2002 to Teach another TV the Master Setup

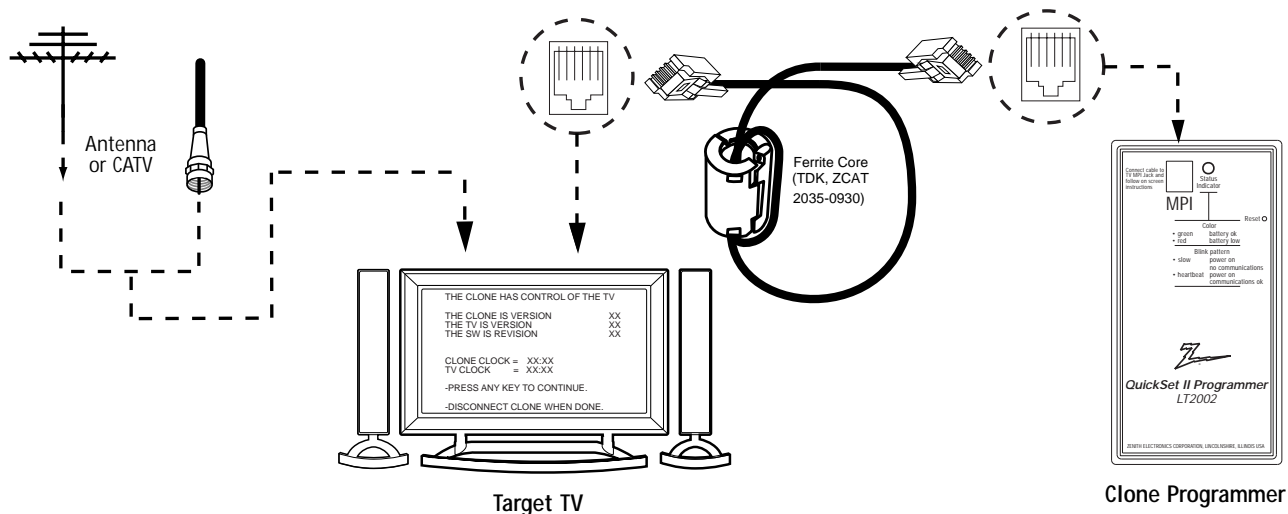

### Teach Master TV's Setup to the target TV

After learning is complete, remove the M.P.I. cable from the master TV and connect it to the target TV that you want to copy the master TV's setup into. With "THE CLONE HAS CONTROL OF TV" message displayed, press 2 or use either Channel key to go to the "TEACH TO TV" option, press ON/OFF, POWER, or ENTER. Select the LT2002 memory that the new setup is in. Press On/Off to transfer the new setup and other information to the new TV. Teaching usually takes 2-3 minutes. After the "TEACHING COMPLETE" message is displayed, press any key to return to the Clone menu, then press ON/OFF, POWER, or ENTER. If finished, detach M.P.I. cable from the target, newly-cloned TV.

### Disconnect TV Power for 15 Seconds

Unplug the AC power cord of the newly-cloned TV from the power outlet for about 15 seconds to activate the newly-copied setup.

CLONE SELECTION MENU

- (1) LEARN FROM TV
- (2) TEACH TO TV
- (3) SET CLONE CLOCK FROM TV
- (4) SET TV CLOCK FROM CLONE
- (5) DISPLAY TV SETUP
- (6) DISPLAY CLONE SETUP

-TO CHANGE MENU ITEMS, PRESS CHANNEL KEYS OR DIGITS.  
-TO EXECUTE ITEM, PRESS ON/OFF, POWER, OR ENTER

This menu should appear after any key is pressed on the Installer remote.

TEACHING IN PROGRESS,

PLEASE WAIT

This display will appear during Teaching function.

TEACHING COMPLETE

This display will appear after Teaching is complete.

# Installer Menu

Use the Installer's Menu to set up or change operational settings.  
See more detailed descriptions of the Installer menu items on the following pages...

## Accessing the Installer's Menu

Make sure TV is on. Installer's menu items can be accessed by using an installer's remote control. Just press MENU repeatedly until the TV seems to stop responding, then press 9, 8, 7, 6, and ENTER to access the Installer's menu. To remove the Installer's menu, press ENTER again. *Any changes you make will be stored in nonvolatile memory. (The menu also disappears automatically.)*

The Installer's menu opens with item 000 INSTALLER SEQ 000. Use the Up/Down arrow keys to sequence through the available menu items. Or, access an item directly by keying in the line number, then pressing MENU. For example, to access the Sleep Timer option which is item 015, press 0-1-5, then MENU. To change a setting, use the Left/Right arrow keys. Or, enter a value directly.

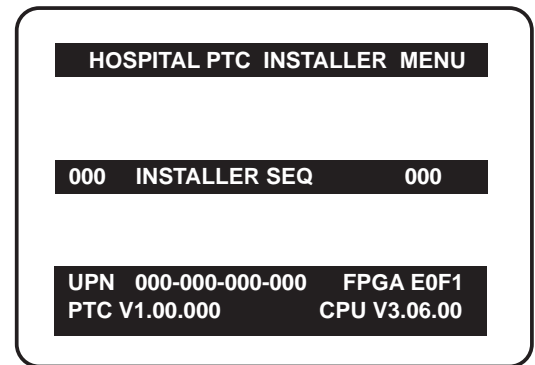

Typical Installer Menu

## Using the Installer's Menu

Items 000 ~ 118 are immediately accessible only upon entering the Installer's Menu. Their numbers, descriptions, ranges, factory default settings, and a place for listing any changes made on-site are given below and on the following pages.

## Installer Menu Items 000 through 30

Menu Item	Function	Value Range	Default Value	Brief Description of Function and Comments
000	INSTALLER SEQ	0 ~ 3	0	Leave default set to 0.
001	POWER MANAGE	0 ~ 7	0	Sets number of hours of no activity before auto shut Off.
002	AC ON	0 / 1	0	Set to 1 to enable auto turn On at power up.
003	BAND/AFC	0 ~ 3	1	Selects Tuning Band: 0=Broadcast, 1=CATV, 2=HRC, 3=IRC
004	STRT CHANNEL	0 ~ 127, 255	255	Channel at turn-on (Set to 255 to tune in last channel before power Off).
005	CHAN LOCK	0 / 1	0	If set to 1, cannot tune from current channel.
007	STRT VOLUME	0 ~ 63, 255	255	Sets Volume level at TV turn-on (Set 255 to retain last volume level).
008	MIN VOLUME	0 ~ 63	0	Sets minimum allowable volume setting.
009	MAX VOLUME	0 ~ 63	63	Sets maximum allowable volume setting.
010	MUTE DISABLE	0 / 1	0	Set to 1 to disable mute function.
011	KEY DEFEAT	0 / 1	1	Set to 1 to disable menu navigation keys on TV.
012	IR BANKS EN.	0 / 1	0	Set to 1: enables TV to respond to IR code
013	SCAN MODE	0 / 1	1	Typically used for Hospitals: puts On-Off in Ch Up/Down sequence.
014	STRT CH IN SM	0 / 1	0	Set to 1 to put TV on/off below start channel number.
015	SLEEP TIMER	0 / 1	1	Set to 1 to enable Sleep Timer.
016	EN TIMER	0 / 1	1	Set to 1 to enable On/Off Timers.
017	ALARM	0 / 1	1	Set to 1 to enable Alarm.
020	FEATURE LEVEL	0 / 1	1	Zen 1 Leave default set 1 (1 Zen 1)
021	V-CHIP	0 / 1	1	Set to 1 to enable V-Chip functions.
022	MAX BLK HRS	0 ~ 99	12	Sets the number of V-Chip (Parental Control) blocking hours.
023	CAPTION LOCK	0 / 1	0	Set to 1 to retain caption setting at power Off.
025	FUNCTION PRE.	0 ~ 3	1	Controls channel preview in Pay-Per-View function
027	HOSPITAL MODE	0 ~ 2	2	Leave default set to 2.
028	CH. OVERRIDE	0 / 1	1	If set to 0, limits direct access to favorite channels.
029	OLD OCV	0 / 1	0	Set to 1 to change M.P.I. operation to OCV.

## Installer Menu Items 031 through 118

Menu Item	Function	Value Range	Default Value	Brief Description of Function and Comments
030	ACK MASK	0 / 1	0	If set to 1, changes M.P.I. for some OCV boxes.
031	POLL RATE	20 ~ 169	94	Selects poll rate for M.P.I.
032	TIMING PULSE	186 ~ 227	207	Sets baud rate for M.P.I.
034	CAMPORT EN	0 / 1	1	Set to 1 to enable Video 2 input.
035	COMPPORT EN.	0 / 2	1	Set to 0 to disable HDMI 1. Set to 1 for DTV, set to 2 for PC.
038	YPrPb EN.	0 / 1	1	Set to 1 to enable display panel Component Video 1 input jacks.
039	REAR AUX EN	0 / 1	1	Set to 1 to enable display panel Video 1 input jack.
040	AUTO CAMPORT	0 / 1	1	Set to 1 to automatically switch to Camport. If set to 1, STRT AUX SRCE cannot be set to 2.
046	STRT AUX SRCE	0 ~ 6	6	Sets the starting AUX source.
047	AUX STATUS	0 / 1	0	Set to 1 for M.P.I. AUX source to be reported as a channel number instead of Channel 0.
053	DIS. CH-TIME M.	0 / 1	0	Set to 1 to disable Channel-Time display.
069	EN. CH-T COL.	0 / 1	1	Set to 1 to enable custom color for the Channel-Time display.
070	FOR. CH-TIME	0 ~ 7	2	Chooses custom foreground color for the Channel-Time display.
071	BCK. CH-TIME	0 ~ 7	2	Chooses custom background color for the Channel-Time display.
073	CH NOT AVBLE	0 / 1	0	If set to 1 and channel override is 0, "NOT AVAILABLE" message is displayed when directly accessing a channel not in the favorite channel list.
075	REVERT CH	0 / 1	0	If set to 1 and loss of M.P.I. communication occurs, TV tunes to Start Channel.
077	QUICK SHUTOFF	0 ~ 17	0	Allows TV timed power off press and hold setup with pillow speaker channel button.
078	UPN MSB	0 ~ 255	255	User programmable number, most significant byte.
079	UPN MSB-1	0 ~ 255	255	User programmable number, most significant byte - 1.
080	UPN MSB-2	0 ~ 255	255	User programmable number, most significant byte - 2.
081	UPN LSB	0 ~ 255	255	User programmable number, least significant byte.
082	CHKSM ERROR	0 / 1	0	Enforces rigid M.P.I. checksum.
083	HANDSHK TIME	0 ~ 5	5	Relaxes M.P.I. timing to be compatible with PC based Windows-controlled systems.
084	PERMANENT BLK	0 / 1	0	Removes block hours setting for Parental Control and makes block permanent.
087	REAR RGB EN.	0, 2, 18	2	Set to 0 to disable RGB1. Set to 2 to enable for RGB PC. Set to 18 for Auto detect configure.
088	EN NOISE MUTE	0 / 1	1	If set to 1, mutes audio if no signal is present.
090	KEY LOCK	0 / 1	0	Set to 1 to disable front keyboard. Set to 1 to enable front keyboard functionality.
094	SAP MENU EN	0 / 1	1	Set to 0 to disable feature on Function menu. Set to 1 to enable feature on Function menu.
096	DEF. ASP. RATIO	0, 2, 4, 5	2	Sets default aspect ratio at power up. See detailed descriptions and item 106.
099	BACK LIGHTING	1 ~ 100 101 ~ 200	200	Sets the brilliance of the TV picture backlighting. Settings above 100 control dynamic back lighting and disable power saving mode..
102	ATSC BAND	0 ~ 4	4	Selects ATSC band.
103	ATSC TUNE MODE	0 / 1	1	Default 01 for physical channel scan. Set to 0 for Virtual Channel scan.
104	START MINOR CH	0 ~ 255	0	Selects Minor start channel. Set 0 for NTSC. Not 0, sets Minor channel number.
106	ASP RATIO LOCK	0 / 1	0	To retain set aspect ratio on power cycle, set to 1. Set to 0 for default ratio on power cycle.
116	VIDEO MUTE EN	0 / 1	0	Set to 0 for normal, set to 1 for Blank.
117	FACT DEFAULT	0 / 1	0	0=Normal. 1=Loads presets of all above settings.
118	POWER SAVING	0 / 1	1	Set to 0 to disable power saving mode.

# Installer Menu

## Detailed Descriptions of Installer Menu Items

### 000 - INSTALLER SEQUENCE

Specifies entry sequence to the Installer Menu.

0 = 9876	1 = 4321
2 = 1478	3 = 3698

### 001 - POWER MANAGE (Power Management)

Determines hours of no activity before automatic shutoff. The POWER MANAGE function is for saving energy. If set to 0, Power Manage is Off. Settings range from 0 ~ 7, with 1 ~ 7 representing the hours that the unit will remain On, unless there has been activity from either the control panel or remote control.

### 002 - AC ON (AC Power Switchable)

If set to 1, allows the TV to turn On just by applying AC power. Pressing the On button is not necessary. This is desirable if the TV is plugged into a cable box or a power outlet controlled by a wall switch. Use ADJ Left/Right arrow to choose 0 or 1 where 0 is the default is Off, and 1 is On.

**NOTE:** If set to 1 (On), the TV does not respond to On/Off commands from either the remote or the display control panel, and the SLEEP TIMER is also nonfunctional.

### 003 - BAND/AFC (Band/Automatic Frequency Control)

There are 4 possible settings for this option:

0 = Broadcast	1 = CATV
2 = HRC	3 = IRC

If some channels were not found by Auto Tuning (Channel Search), select the appropriate Band setting here and add the channels using the Channel Edit option in the Channel Menu.

### 004 - STRT CHANNEL (Start Channel)

If active, this function allows you to determine the initial channel number when the TV is turned On. This feature is useful for an in-house information channel, since the TV would always select that channel when it is turned On. Setting this to 255 causes the last channel viewed when the TV was turned Off, to be the tuned to channel when the TV is turned On again. Note: For a digital Start Channel, always remember to set item 104 to the Minor Start Channel number.

255 = Last channel	1 ~ 125 = Ch X	0 = Aux
126 Map to Channel 3.	127 Map to Channel 4.	

### 005 - CHAN LOCK (Channel Lock)

CHAN LOCK is ideal if the system must always be on the same channel. Changing channels with Channel Up/Down or keypad numbers is impossible. Channel Lock is inactive if set to 0 (default).

Generally, this feature is used in connection with START CHANNEL (Installer item 004) where the start channel may, for example, be set to 3 or 4. If the start channel is 3, then the TV will remain locked on Channel 3.

### **NOTE: For Items 007, 008 and 009**

For legacy reasons, the scale used is 0 - 63. The PTC software will translate this to the 0 - 100 scale used by the TV.

To translate a TV volume level to the installer menu value, use the following formula:

$$\text{Installer Value} = \frac{\text{TV Value} \times 63}{100}$$

Enter only the whole number (disregard fractions).

### 007 - STRT VOLUME (Start Volume)

This function allows the Installer to determine the initial volume level setting when the TV is turned On. This feature is useful for an in-house information channel, since the TV would always select that volume level when it is turned On. The range of values are 0 - 63, 255. If 255 is selected, the current volume level will be retained in memory when the TV is turned Off; at turn On, the volume level will be automatically set at the previous or last level.

### 008 - MIN VOLUME (Minimum Volume)

This function determines the minimum volume level allowable with the VOLUME (VOL) Up/Down control. In this way, for example, someone cannot set the volume too low to hear. The value range is from 0 to 63 — change values with ADJ Left/Right arrow. The factory default is 0, which provides the full range of volume control, if item 009 MAX VOLUME is also set to 63. It may be best to set the same value on every TV.

**NOTE:** The minimum volume level cannot have a value setting higher than the MAX VOLUME level (described below).

### 009 - MAX VOLUME (Maximum Volume)

This function determines the maximum volume level allowable with the VOLUME (VOL) Up/Down controls. In this way, for example, someone can not set the volume level high enough to disturb others. The value range is 0 to 63, with 63 as the default, which gives the user the full range of volume control, if item 008 MIN VOLUME is also set at 0. Change values with ADJ Left/Right arrow keys. It may be best to set the same value on every TV.

**NOTE:** The maximum volume level cannot have a value setting lower than the MIN VOLUME level (described previously).

### 010 - MUTE DISABLE

Enables or disables sound mute function. If set to 1, sound cannot be muted. If set to 0, sound can be muted.

## 011 - KEY DEFEAT (Keyboard Defeat)

If set to 1, key defeat prevents the end user from accessing the on-screen menus with the TV front panel—MENU, SELECT, and Left / Right arrow keys do not function. If set to 0, those keys do function. **NOTE:** The menus can always be accessed by pressing MENU on the remote.

## 012 - IR BANKS EN (IR Banks Enable)

For direct access to a particular Channel Bank. When enabled, installer can access a channel bank by inputting the IR code for the bank.

## 013 - SCAN MODE (Functional after 2-5-5+Menu setup transfer)

Allows variation in setting the TV On/Off with Channel UP/DOWN. You may opt for TV channels only; TV channels + Off/ON; with these settings for Scan Mode:

SCAN MODE Characteristics

0	Channel up/down keys change channels only.
1	Channel down below the lowest channel (or channel up higher than the highest) and TV turns off.

## 014 - STRT CH IN SM

(Start Channel in Scan Mode) If set to 1, installs TV On/Off event below the start channel at TV turn On. If set to 1, the user can select channels with either Channel Up/Down or by direct keypad entry. If set to 0, only those channels that are entered for scanning can be selected.

## 015 - SLEEP TIMER

If set to 1, the SLEEP TIMER feature may be used. If set to 0, the Sleep Timer is not available.

## 016 - EN TIMER (Enable On/Off Timers)

If set to 1, Timer function is available to end user and enabled continuously. Set to 0 to disable On/Off Timers. (Clock must be set in order to use Timers.)

## 017 - ALARM \*



Gives the installer the option of making the Alarm function available to the end user. If set to 1, Alarm function is available to end user. Set to 0 to disable the Alarm function.

**NOTE:** Clock must be set before the Alarm function will work.

## 020 - FEATURE LEVEL

**Installer should leave item 20 FEATURE LEVEL set to 1 (default).**

Default set to ZEN 1 for Zenith IR codes remote control operation. Set 0, P LBL for Zenith Private Label IR remote control operation. Warning: Do not set to "0" or remote will not control TV.

## 021 - V-CHIP (Parental Control)

Set to 1 to activate V-Chip (Parental Control); have it available to end user to filter and control or otherwise restrict programming content that can appear. Set to 0 to turn V-Chip feature Off, not available to end user; no programming restrictions can be set.

\* Only affects Function Menu if enabled by some PPV providers.

## 022 - MAX BLK HRS (Maximum Block Hours)

Sets hours from 0 to 99 for the maximum V-Chip (Parental Control) block hours. Default setting is for 12 blocking hours.

## 023 - CAPTION LOCK

Set to 1 to restore previous caption On/Off state after turn Off. If set to 0, captions are always Off at turn On.

## 025 - FUNCTION PRE (Function Preview)

Set to 0 to suppress CHANNEL PREVIEW from the FUNCTION menu with some Pay-Per-View systems.

## 027 - HOSPITAL MODE

The default is 2 (which favors most hospitals). With this setting two things are affected: Channel Banks 1, 2 and 3 are accessible, while Bank 4 can be made inactive by removing all the channels from Channel Bank 4. Then, if Channel Bank 4 is selected when the TV is turned on, the TV screen will show "Inactive TV". The Channel Bank 4 setup allows the hospital to present TV viewing options to the patient. The patient can select programming options available in either Bank 1, 2 or 3. Channel Banks are available in all hospital modes 1 and 2.

- The IR code that will control the TV depends on Item 20-I Feature Level setting.

Hosp. Mode = 0 Hospital Mode disabled.

Hosp. Mode = 1 Zenith P.L. IR Code (Bed 1)

Hosp. Mode = 2 Zenith IR Code (Bed 2)

## 028 - CH. OVERRIDE (Channel Override)

If set to 1, the user can select channels with either Channel Up/Down or by direct number keypad entry. If set to 0, only those channels that are active in the TV's memory can be selected.

## 029 - OLD OCV (On Command Video™)

Set to 1 for operation with systems from On Command Corporation.

## 030 - ACK MASK

M.P.I. Communication Parameter. Leave at default setting unless changed by Pay-Per-View provider. When set to 1, changes M.P.I. for some OCV boxes.

## 031 - POLL RATE

M.P.I. Communication Parameter. Selects Poll Rate for M.P.I. Leave at default setting unless changed by Pay-Per-View provider. Step size of 16 ms.

## 032 - TIMING PULSE

M.P.I. Communication Parameter. Leave at default setting unless changed by Pay-Per-View provider. Sets baud rate. Step size of 4.3 uS.

## 034 - CAMPORT EN. (Camera Port Enable)

Set to 1 to enable Video 2 input on display panel. If set to 0, Video 2 input on display panel is not functional.

**NOTE:** S-Video overrides Video jack.

# Installer Menu

---

## Detailed Descriptions of Installer Menu Items

### 035 - COMPPORT EN. (HDMI 1 Port Enable)

Enable/disables TV display panel HDMI 1 input jack.  
Set to 0 to disable, set to 1 to enable.

### 038 - YPrPb EN. (Rear Component Video Enable)

Set to 1 to enable display panel rear Component Video input jacks.  
Set to 0 to disable display panel rear Component Video input jacks.

### 039 - REAR AUX EN. (Rear Aux Enable)

Set to 1 to enable display panel rear AUX (Video 1) input.  
Set to 0 to disable display panel rear AUX (Video 1) input.  
Note: S-Video overrides Video.

### 040 - AUTO CAMPORT

Set to 1 to automatically switch to camport when equipment is connected to front Video input.  
Set to 0 to disable front Video automatic source selection.  
If set to 1, STRT AUX SRCE cannot be set at 2.

### 046 - STRT AUX SRCE (Start Aux Source)

Sets the starting AUX source. At power up, TV will tune to starting Aux source if item 004 Start Channel is set to 0.

1 = Video 1	4 = RGB	255 = Last Aux
2 = Video 2	3 = HDMI 1	6 = Component

If item 040 Auto Campport is set to 1:

1 = Video 1	3 = HDMI 1	6 = Component
4 = RGB		

Note: Above is applicable only if all Aux sources are enabled.

### 047 - AUX STATUS

Set to 1 for M.P.I. AUX source to be reported as a channel number instead of channel 0. Set to 0 to disable AUX identification change.  
Controls M.P.I. status channel response for AUX inputs.

### 053 - DIS. CH-TIME (Disable Channel-Time)

Set to 1 to disable the Channel-Time display, Channel-Time display will not appear. Set to 0 to enable the Channel-Time display.

### 069 - EN. CH-T COL. (Enable Text Custom Color)

Set to 1 to enable custom color for the Channel-Time display.  
Set to 0 to disable custom color for the Channel-Time display.

### 070 - FOR. CH-TIME (Text Display Foreground Color)

Set according to Color Chart.

0 = Black	3 = Cyan	6 = Yellow
1 = Blue	4 = Red	7 = White
2 = Green	5 = Violet	

**Notes:** Applies only to 'Channel Not Available' message if item 073 is set to 1, enabled. If foreground color and background color are the same, background will be transparent.

### 071 - BCK. CH-TIME (Text Display Background Color)

Set according to Color Chart.

0 = Black	3 = Cyan	6 = Yellow
1 = Blue	4 = Red	7 = White
2 = Green	5 = Violet	

**Notes:** Applies only to 'Channel Not Available' message if item 073 is set to 1, enabled. If foreground color and background color are the same, background will be transparent.

### 073 - CH NOT AVBLE (Channel Not Available)

If set to 1 and item 028 CHANNEL OVERRIDE is set to 0, "NOT AVAILABLE" message is displayed when directly accessing a channel not in the channel scan list available in memory.

### 075 - REVERT CH (Revert to Start Channel)

If set to 1 and loss of M.P.I. communication occurs, TV automatically tunes to the specified Start Channel.

### 077 - QUICK SHUTOFF

Allows TV power Off event to be controlled by the Remote Control, TV Front Panel and Pillow Speaker Channel Up/Down buttons. End user would push and hold channel button down for time required to have TV turn Off. Setting 0 = disabled. Value Range 0 - 17, each number represents 1/2 second. For example, if set to 4, TV would turn Off if end user held any channel button down for 2 seconds.

### 078 - UPN MSB (UPN Most Significant Byte)

User programmable number, most significant byte readable by M.P.I. command. Note: Not linked to serial number.

### 079 - UPN MSB-1 (UPN Most Significant Byte-1)

User programmable number, most significant byte-1 readable by M.P.I. command. Not linked to serial number.

### 080 - UPN MSB-2 (UPN Most Significant Byte-2)

User programmable number, most significant byte-2 readable by M.P.I. command. Not linked to serial number.

### 081 - UPN LSB (UPN Least Significant Byte)

User programmable number, least significant byte readable by M.P.I. command. Not linked to serial number.

### 082 - CHKSM ERROR (Checksum Error)

Enforces rigid M.P.I. checksum validation.

Set to 1 for validation.

Set to 0 to disable (does not check checksum on M.P.I. async port). SPI is always checked.

### 083 - HANDSHK TIME (Handshake Time)

Adds an additional delay to the handshake time which is 64 msec,

thus relaxing M.P.I. timing requirements to be compatible with PC based Windows controlled systems, range is 0 - 5.  
(Timeout = 25.5MS + [25.5 MS\* Handshake time]).

### 084 - PERMANENT BLK (Permanent Block)

Allows Lock (Parental Control) blocking schemes to be permanent by disabling the blocking hours function.

Set to 1 to install Parental Control restrictions permanently.  
Set to 0 for user-specified hours control of blocking schemes.

### 087 - REAR RGB EN. (Rear RGB Enable)

Controls access to rear RGB input on TV.

Set to 0 to disable RGB input.

Set to 2 to enable for RGB PC input and automatically configure its input format every time TV is turned On.

Set to 18 to enable RGB PC input and to configure the input format one time only with AC power cord removal and reinsertion.

### 088 - EN NOISE MUTE (Enable Noise Mute)

If set to 1, audio mutes if no signal is present.

### 090 - KEY LOCK

If set to 1, front keyboard buttons Channel, Volume and Captions are disabled, Power button remains enabled. If set to 0, front keyboard Channel, Volume, Captions and Power buttons are all enabled.

### 094 - SAP MENU EN (2nd Audio Program)

Set to 1 to enable SAP feature on Function menu, if Function menu is available.

Set to 0 to disable SAP feature on Function menu, if Function menu is available.

### 096 - DEF. ASP. RATIO (Default Aspect Ratio)

Selects default aspect ratio at power up, see settings below.

**Note:** Only applies if item 106 Aspect Ratio Lock is disabled, set to 0.

Set to 0 "Set By System".
Set to 1 for 4:3.
Set to 2 for 16:9 (Factory Default).
Set to 4 for Zoom 1
Set to 5 for Zoom 2

### 099 - BACK LIGHTING

Sets the TV screen brightness at power up, see settings below.

Default setting is 100.

#### 1 - 100 Static Backlighting.

(1 = Dimmest picture, 100 = Brightest picture.)

#### 101 - 200 Dynamic Backlighting.

(101 = Dimmest picture, 200 = Brightest picture.) If settings are above 200, the TV automatically controls backlighting depending upon the picture level of the current program.

### 102 - ATSC BAND

Sets up TV to receive different types of incoming signals:

0=Broadcast, 1=CATV, 2=HRC, 3=IRC, 4=Same as NTSC.

### 103 - ATSC TUNE MODE

Sets ATSC tuning mode: Default set to 1 for Physical channel scan.

Set to 0 for Virtual Channel scan.

### 104 - START MINOR CHANNEL

Sets XX-XX digital minor sub start channel at power up: 0=NTSC. If not 0, number selected is the digital minor start channel number.

### 106 - ASP RATIO LOCK (Aspect Ratio Lock)

Set to 1 to retain previous aspect ratio with power Off.

Set to 0 to retain default aspect ratio with power Off. See item 96

Default Aspect Ratio above.

### 116 - VIDEO MUTE EN (Video Mute Enable)

Set to 0 for normal.

Set to 1 for blank.

### 117 - FACT DEFAULT (Factory Default)

Set to 0 for normal.

Set to 1 and press Enter to load presets for all of the Installer menu item settings.



**WARNING:** Setting this to 1 and pressing Enter will reload the factory defaults and clear the channel list including erasing any assigned Channel Icons and custom channel Labels.

### 118 - POWER SAVING

Default is set to 1, power saving mode is enabled.

Set to 0 to disable power saving mode.

- Power Saving is only active when TV is in standby mode.

- Power Saving is not available in normal power on mode.

**If Power Saving is enabled and TV is in Standby mode with External card installed:** TV can supply 12V (9.6 Watts) to External card and Standby power consumption will be small.

**If Power Saving is disabled and TV is in Standby mode with External card installed:** TV can supply 12V (12 Watts) to External card and Standby power consumption will be normal.

## Reference: Detailed Information For Making A Master TV

---

### IMPORTANT INSTALLER SETUP INFORMATION! PLEASE READ THE FOLLOWING...



To set up a master TV you will need to know how to enter the TV Installer menu and make changes to the default values as required. If necessary, familiarize yourself with the TV Installer menu and how to make and save changes in the menu, before attempting to clone the TV Master setup.

You will also need an **LG Installer remote control** similar to the one shown in the front of this manual. The installer remote must have a "Source" button or its equivalent. The remote shown in this manual has a "INPUT" button -- this button serves the purpose of a Source button.

Finally, the TV's clonable features need to be set up. This is a critical step. If the Master TV display panel's clonable features

like adding channel icons or channel labels, digital font closed caption options etc., are not correctly added, then the cloned TVs will all have problems.

As the cloning procedure is being performed, specific steps need to be done at the indicated times to create a correct master TV setup and cloned target TVs. Be sure to do each task as indicated. If a procedure or step is left out or not performed completely, cloning may not work. At each step, pay attention to assure the TV screen shows the proper message when cloning. If the message indicated does not appear, there is a problem with that step and cloning may not be successful. Cloning is only possible when the signal source is an Analog channel, not a digital channel.

---

## Making a Master TV

### Detailed Instructions

The following describes the procedure for preparing a Master TV for cloning and the procedure for adding Channel Icons and/or Labels.

**Note 1:** Disconnect all Aux inputs. Under certain conditions, Auto Tuning is disabled if there is an Aux input active.

**Note 2:** Under certain conditions, changes to the input mode of the RGB input will not take effect until the power is cycled (TV is turned Off and On). To avoid confusion, disconnect RGB input before entering the Installer menu.

1. Enter the TV installer menu.
  - a. Reset the internal controller to factory default by accessing installer menu item 117 FACT DEFAULT, set it to 1 and press "ENTER". The value will change back to 0 after the TV's internal controller has been restored to factory default condition. This step will ensure that the TV channel memory will be the active channel list. Check the Status LED inside the TV. If it is blinking rapidly, the TV channel map is in use.
  - b. Within the Installer menu, set the Installer menu items to the configuration required of your institution.
  - c. It is important to set the tuning band at this time, set Installer menu item 03 BAND/AFC. Default is 001 CATV.
  - d. Set Installer menu item 28 – CH OVERRIDE to 001 to allow access to Auto Tuning and Channel Edit options in the Channel Menu. Exit the Installer menu.
2. Access the Master TV menus and set the clonable options on the menus to the desired configuration. Refer to the **Clonable Menu Features Chart** in this manual.

3. Run Auto Tuning to find analog and digital channels.
4. Enter the Channel Edit menu and edit the channel lineup to include the Free-To-Guest Channels only.
5. Assign ICONs to the channels using the Channel Label Menu.  
**Note:** You can add Channel ICONs typically network logos like ABC, NBC, PBS etc. in this step. Or, in Step 7, add Channel ICONs or labels for channels without Icons.
6. Transfer the TV setup: Enter the TV installer menu. Press '2', '5', '5', 'MENU' to start the transfer of the TV's setup to the TV internal controller. Once the transfer is complete, the system will exit the Installer menu. Check the Status LED inside the TV. It should be blinking slowly (1 blink per second). Note: The maximum number of active channels and Aux sources that can be transferred is 140. Total channels numbering more than 140 will result in erratic TV operation.
7. Edit/Add Channel ICONs and Channel Labels as needed. Enter Installer menu. With menu displayed, press 2-5-4 + MENU. See the following page for detailed instructions:
  - **Editing/Adding Channel ICON and Labels on Master TV**
  - **Changing a Channel's ICON on Master TV**
  - **Changing/Adding Channel Labels on Master TV**
  - **Changing Source Labels on Master TV**
8. Verify Master TV setup and feature configuration:
  - Did you add Channel ICONs?
  - Did you add Channel Labels?
  - Did you add Source Labels?
  - Did you adjust all TV menu options as required?After verifying master setup, enter the TV Installer menu and set Installer menu item 28 CH OVERRIDE to 000. Press ENTER to remove and exit the Installer menu.



## Reference: Procedures for adding Channel Label Icons/Custom Channel Labels (2-5-4 + MENU Mode)

### Adding Channel Icons and Labels in the 2-5-4 + Menu Mode

#### Editing/Adding Channel ICONs and/or Labels

If there is no pre-assigned ICON, you can make a custom channel label of up to 7 characters to help in identifying the channel or network. At your option, channel labels can also be added in addition to a pre-assigned ICON. You may also add labels for the Aux input sources to clearly identify the devices that are connected to the Aux inputs.

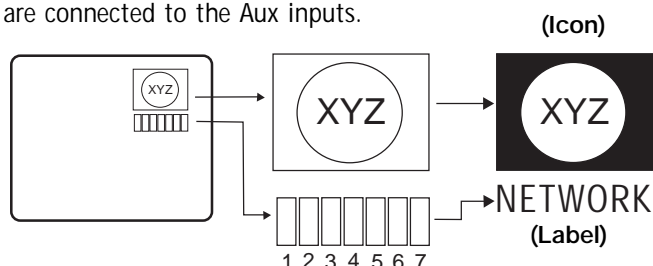

Editing and adding the labels can only be done if there are channels entered into the TV's channel map either by using the method described in item 6 (page 38), by cloning or by the use of the master remote control from the PPV provider.

Note: A blank letter space is available between 'Z' and '!'.

#### To Do Channel Editing/Labeling, proceed as follows

1. Enter TV Installer menu.
2. Once the installer menu appears, press '2', '5', '4', 'MENU'. This enters the channel label editing mode. Add your channel icons and channel labels in this menu, see below. (You can do this more than once.)
3. To exit the menu when done press "MENU".

#### Changing a Channel's ICON on Master TV

1. With Channel Up/Down, select the channel you want to change the Icon for.
2. With the Right or Left ADJ arrow, select the letter 'I' on the channel ID display.
3. With the Up or Down arrow, select the desired ICON you want to appear to identify the channel. (If you know the ICON number, enter the number followed by Enter / Select.)
4. Proceed with Changing/Adding Labels or go to the next channel.

#### Changing/Adding Channel Labels on Master TV

1. Channel Up/Down to select the desired channel.
2. Press the Right or Left ADJ arrow repeatedly until the numbers 1 to 7 show up. The number shows the position of the character that can be changed. Number 1 is the first character, number 2 the second character and so on.
3. With the Up or Down arrow, select the desired character.
4. Proceed to the next number position or use Channel Up/Down to go to the next channel.

#### Changing Source Labels on Master TV

1. Press "INPUT" to select the desired Aux input source; Video 1, Component, S-Video etc.
2. Use the Up or Down arrows to select the desired character for space 0.
3. Press the Right or Left arrow repeatedly to select number spaces 0 to 9. The number shows the position of the character that can be changed.
4. Press "INPUT" for the next Aux source or proceed with Changing Icon or Changing/Adding Labels.

### Installer Remote Control Key Functions for Master TV Channel Editing/Labeling Menu

- **CHANNEL Up/Down** - Tunes in the next channel in scan.
- **Left/Right Arrows** - Select the item to change. If "I" is shown, the ICON can be changed. If a number is shown, it indicates the position of the character that can be changed.
- **Up/Down Arrows** - Select the ICON or the character to be displayed.
- **0 - 9** - Use to enter the index number of the ICON, if known.
- **ENTER/SELECT** - Changes the ICON after the number has been entered.
- **INPUT** - Changes the Aux input label. ("Source" on the remote shown in this manual is INPUT.)
- **MENU** - Exits the editing process.

## Reference: Clonable Menu Features

---

Clonable Menu Features		
<b>Menu /Sub Menu Features</b>		
<b>Channel Menu</b> Auto Tuning Manual Tuning Channel Edit Channel Label	<b>Option Menu</b> Language Captions  <b>Picture Menu</b> Picture Mode	<b>Audio Menu</b> Auto Volume Clear Voice  <b>Installer Menu</b> Item Settings  Note: Some menu options will revert to their default settings after cloning.

Note: End user only has access to features that are available on End user pillow speaker, or remote control if provided by the institution.

## Reference: Checking Software Version

---

### Procedure for Checking Software Version

The software version of the TV may be checked by accessing the INSTALLER MENU. To do this, press the MENU button repeatedly until the menu display ceases to respond to MENU key presses. Then, press "9", "8", "7", "6", "ENTER/SELECT". Press Enter again to remove Installer menu.

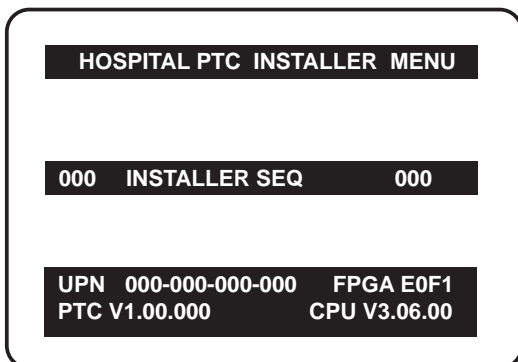

Typical Installer Menu

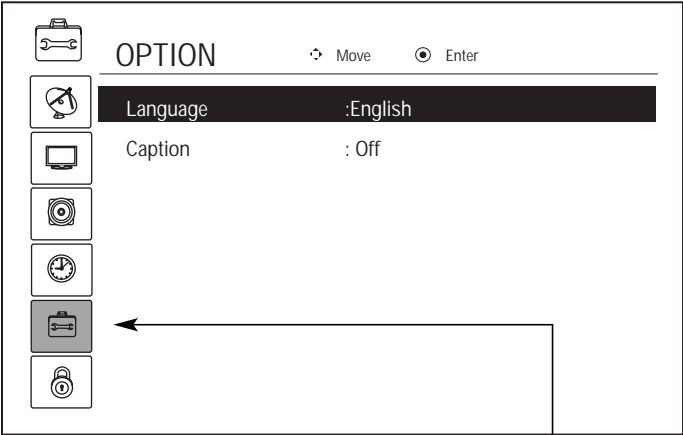
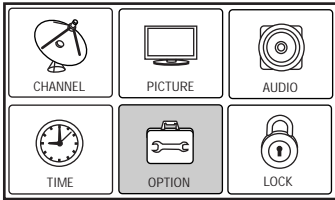

**If Upgrade Menu Does Not Appear**

- 1. Go to the Option Menu.
- 2. Highlight the Option Icon on the left side of menu.
- 3. Press the number 7 key 7 times (7-7-7-7-7-7-7) then press ENTER.
- 4. Upgrade Menu should appear.

# TV Camport Auto Sense Operation

The CAMPORT Auto Sense function is enabled when:

1. Installer Menu Item 34, CAMPORT EN is set to 1 AND
2. Installer Menu Item 40, AUTO CAMPORT is enabled (1).

Selectable= Can be accessed with INPUT key, direct access, etc.  
 Auto Sense= Switches to this input when connector is inserted.  
 The camport (Front Video) has the highest priority and will override any commands including tuning to the Start Channel.

**CAMPORT (Front Video) Functionality Control**

Item 34 CAMPORT EN	Item 40 AUTO CAMPORT	Front Video Operation
0	0	Disabled
0	1	Disabled
1	0	Selectable
1	1	Auto Sense

## CAMPORT Operation (Stand-Alone)

When Camport Auto Sense is enabled as above, the TV's source will switch to the front video whenever a plug is inserted into any of the front panel video inputs (either composite Video or S-Video).

When the plug is removed, the TV will switch back to the previous channel or input source that the TV was using before the plug was inserted. However, if any direct access to an RF channel or Aux channel is requested while the camport is active, then, when the camport plug is removed, the TV will switch to the last requested channel. Source changes using any Source Keys (INPUT) are ignored. Channel Up, Channel Down and Flashback Commands are not direct access tuning commands and they are also ignored.

Previous State Before Inserting CAMPORT	Operation While CAMPORT Is Active	State Upon Removal Of CAMPORT
Aux or RF Channel	None	Previous Aux or RF Channel
Aux or RF Channel	Direct Access	Last Requested RF or Aux Channel
Aux or RF Channel	Ch Up/Down, Flashback and TV/AV Keys	Previous Aux or RF Channel

## CAMPORT Operation (PPV)

The operation will be similar to that of the Stand-Alone mode. However, the PPV providers may send different commands to the TV for the same user commands. For instance, some providers will always send a direct tune command when it receives a channel up/down or a flashback command while other PPV providers will just send a key command.

Previous State Before Inserting CAMPORT	Operation While CAMPORT Is Active	State Upon Removal Of CAMPORT
Aux or RF Channel	None	Previous Aux or RF Channel
Aux or RF Channel	Direct Access	Last Requested RF or Aux Channel
Aux or RF Channel	Ch Up/Down, Flashback and TV/AV Keys	Last Requested Channel if PPV translates it to direct access tuning command. Otherwise, goes to Previous Aux or RF Channel

# TV Aux Input Configuration

DIRECT ACCESS Tuning		TV		ENABLE				MPI DATA			START AUX SOURCE ASSIGNMENT
				Installer Menu		MPI DATA STATUS TYPE 0x41 SOURCES ENABLED (R/W)		DATA STATUS TYPE 0xD2 CURRENT AV SOURCE (R)		DATA STATUS TYPE 0X0D AUX SOURCE (R)	
OLD_OCV =0	OLD_OCV=1	Source Input	Source Mode	Number	Labeling	Value	Labeling	Value	Labeling		
130	90	Video2 (Side)	CV/SVIDEO	34	CAMPORT_EN	0x01	Video Front (Camport)	0	Video Front (Camport)	0 (VIDE0)	2
131	91	Video1 (Rear)	CV/SVIDEO	39	REAR_AUX_EN	0x02	Rear Video (Aux)	1	Rear Video (Aux)	0 (VIDE0)	1
133	93	HDMI1/DVI	DTV	35	COMPPORT EN = 1	0x08	Front Computer	3	Front Computer	0 (VIDE0)	3
			PC	35	COMPPORT EN = 2	0x08	Front Computer	3	Front Computer	2 (COMPUTER)	3
134	94	RGB	DTV	87	REAR RGB EN = 1	0x10	SVGA Rear Computer	4	SVGA Rear Computer	0 (VIDE0)	4
			PC	87	REAR RGB EN = 2	0x10	SVGA Rear Computer	4	SVGA Rear Computer	2 (COMPUTER)	4
136	96	Component		38	YPrPb EN	0x40	Y/UV Component	6	Rear Y/PrPb Component video	0 (VIDE0)	6

## Power Savings Setup

Installer Item 118 Power Saving: set to 001, enabled (Default).

Installer Item 099 Backlighting: value set as shown below. (Default value is 200)

Item 099 Backlighting (Static)	Picture Lumin.	Power Consumption (Watts)	Power Savings Rating	Item 099 Backlighting (Dynamic)	Picture Lumin.	Power Consumption (Watts)	Power Savings Rating
100	217	122	0 %	200	130	86	30 %
90	202	114	7 %	190	123	83	32 %
80	188	109	11 %	180	117	80	34 %
70	172	102	17 %	170	109	76	38 %
60	157	95	22 %	160	101	74	39 %
50	128	89	27 %	150	94	70	43 %
40	124	82	33 %	140	86	67	45 %
30	109	75	39 %	130	79	64	48 %
20	95	69	43 %	120	72	61	50 %
10	78	62	49 %	110	63	58	52 %
1	64	56	54 %	101	57	56	54 %

Note: Values are results of controlled experiments under laboratory conditions.

# Troubleshooting

*Some quick and easy tips to resolving problems*

---

Symptoms	Possible Cause(s)	Possible Solution(s)
----------	-------------------	----------------------

---

## Power

No Power.	See troubleshooting flow chart.	
-----------	---------------------------------	--

---

## TV Picture

No Picture.	<ul style="list-style-type: none"><li>• Display panel is turned off.</li><li>• Antenna/Cable not connected.</li><li>• Connections incorrect.</li><li>• M.P.I. not connected.</li><li>• Encrypted program.</li><li>• Wrong tuning band.</li></ul>	<ul style="list-style-type: none"><li>-Turn TV on.</li><li>-Power failure?</li><li>-Connect Antenna/Cable signal to TV.</li><li>-Check connections on TV.</li><li>-If applicable, connect M.P.I. cable to M.P.I. device.</li><li>-Try another channel.</li><li>-Adjust Installer menu settings.</li></ul>
-------------	--	---

---

## Erratic Operation

Installer menu setup.	<ul style="list-style-type: none"><li>• Wrong Installer menu settings.</li></ul>	<ul style="list-style-type: none"><li>-Adjust Installer menu settings as required.</li></ul>
-----------------------	--	--

---

## Remote Control

Remote doesn't work.	<ul style="list-style-type: none"><li>• Remote not in TV mode.</li><li>• Not aimed at IR remote sensor.</li><li>• Remote too far from IR sensor.</li><li>• IR path to TV's receiver obstructed.</li><li>• Weak batteries.</li><li>• Wrong battery polarity.</li><li>• Too much light in room.</li><li>• Wrong Installer remote control.</li></ul>	<ul style="list-style-type: none"><li>-Use Mode key to select TV; puts remote into TV mode.</li><li>-Point remote at TV's IR receiver on TV.</li><li>-Move remote closer to TV's IR receiver or darken room.</li><li>-Remove obstructions.</li><li>-Replace batteries.</li><li>-Check that "+" and "-" match in battery compartment.</li><li>-Dim room light.</li><li>-Requires compatible Installer remote, contact your LG dealer.</li></ul>
----------------------	---	--

---

## Picture / Sound

Normal picture, poor or no sound.	<ul style="list-style-type: none"><li>• Audio muted.</li><li>• Broadcast problem.</li><li>• Pillow Speaker Switch setting.</li></ul>	<ul style="list-style-type: none"><li>-Press MUTE or use Volume Up key to increase sound level.</li><li>-Try a different channel.</li><li>-Check pillow speaker switch setting. If set to Normal, sound will be heard on TV speakers. If set to Pillow, sound will be heard on pillow speaker.</li></ul>
-----------------------------------	--	--

---

## Software Problems

Cannot direct enter channel number or "No Signal" appears.	Channel not included in channel scan in TV controller.	After 2-5-5 + MENU, only channels included in TV controller will appear. If channel is available it can be added to channel scan. If it is not available, the 'No Signal' message appears on the TV screen.
--	--	---

---

Note: For other problems not caused by the TV, refer to other devices' operating guides.



Warning: Do not use LT2002 while any PPV card is installed in TV or clone programmer will be damaged.

## Note

The LT2002 programmer is designed to be used with TVs containing the 221-01006 and later processors. Use with earlier TV sets may give unpredictable results. Processors used before the 221-01006-04 have a limited screen display capability. They cannot display entire screens as shown in the quick setup instructions accompanying the LT2002 clone programmer. Use the printed menu illustrations on the quick setup sheet supplied with the Clone as an aid to making your programming choices. (Although the menus are not all displayed, the clone functions all operate normally.)

## Reset Clone After Static Shock

After replacing exhausted batteries, or if the programmer behaves strangely after a static shock, use a paper clip or similar instrument inserted through the small hole marked "RESET" to activate the internal reset switch and restore normal operation. After a reset, check the real-time clock setting. It may be necessary to reset the Clone Programmer clock from a TV containing the correct time.

## Clone Programmer Troubleshooting

Problem	Possible Cause(s)	Possible Solution(s)
<b>Clone Programmer</b>		
Clone copies Setup in less than 30 seconds	<ul style="list-style-type: none"> <li>• Not enough time to copy entire TV setup.</li> </ul>	<ul style="list-style-type: none"> <li>- Press Reset on clone programmer, redo teach/learn. (Teach/Learn should take a minimum of 1 minute.)</li> </ul>
Remote does not operate clone.	<ul style="list-style-type: none"> <li>• Wrong Installer remote.</li> </ul>	<ul style="list-style-type: none"> <li>- Only use an LG Installer remote to operate clone programmer with TV.</li> </ul>
LED does not blink.	<ul style="list-style-type: none"> <li>• M.P.I. cord not connected.</li> <li>• TV not turned on.</li> <li>• Weak batteries.</li> </ul>	<ul style="list-style-type: none"> <li>- Connect M.P.I. cord properly, assure good connection.</li> <li>- TV must be powered On for clone to work.</li> <li>- Install 4 fresh AA high-quality alkaline batteries.</li> </ul>
Clone menu hard to read.	<ul style="list-style-type: none"> <li>• Weak signal.</li> </ul>	<ul style="list-style-type: none"> <li>- Connect TV to a reliable Analog channel signal source.</li> </ul>
No time set.	<ul style="list-style-type: none"> <li>• Time not available.</li> </ul>	<ul style="list-style-type: none"> <li>- Set time on a TV, copy time to Clone Programmer.</li> </ul>
Clone not working.	<ul style="list-style-type: none"> <li>• Clone programmer problem.</li> </ul>	<ul style="list-style-type: none"> <li>- Try a different LT2002 Clone programmer.</li> <li>- Reset Clone Programmer.</li> </ul>
Clone Scans Channels more than once.	<ul style="list-style-type: none"> <li>• Clone should only scan channels once.</li> </ul>	<ul style="list-style-type: none"> <li>- Retry cloning again.</li> </ul>

## Master and Other TVs

Cloning did not work.	<ul style="list-style-type: none"> <li>• Procedure interrupted.</li> <li>• Different TV models.</li> <li>• Step(s) omitted or not performed.</li> </ul>	<ul style="list-style-type: none"> <li>- Wait until procedure complete message is displayed.</li> <li>- Cloning is only possible with identical model TVs.</li> <li>- Reread pages 7-8-9 to be sure all tasks were performed.</li> </ul>
Clone time disappeared.	<ul style="list-style-type: none"> <li>• Batteries were removed.</li> </ul>	<ul style="list-style-type: none"> <li>- Batteries must remain installed to retain time settings.</li> </ul>
New Setup not present.	<ul style="list-style-type: none"> <li>• TV not reset.</li> </ul>	<ul style="list-style-type: none"> <li>- Disconnect newly-cloned unit from power for 5 seconds.</li> </ul>

- After cloning operations are complete, just unplug the LT2002 from the TV.
- If the TV does not display a picture on the TV (blank screen) after a few seconds, just change channels.

# Channel Banks Setup Troubleshooting

---

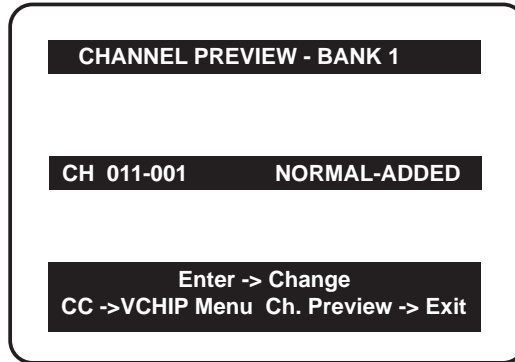

**Channel Banks Setup Menu**

## Problem

Cannot change channel status in menu.

Channel Preview menu does not appear.

Channel is blanked in all channel banks.

Cannot tune in deleted channel on Ch Preview menu.

'Inactive TV' message appears and then TV turns off.

Channel found in scan does not tune in with Channel Up/Down.

If 'Bank' on Installer remote is pressed, TV shows Aux sources selection menu.

## Solution

Installer menu item 028 Ch Override is set to 000. Set Ch Override to 001 to allow access for channel status change.

2-5-5+ Menu procedure was not performed. Channel Banks setup menu will not be available until 2-5-5+ Menu procedure is done. And, item 028 Ch Override is set to 001 to allow access for channel status changes.

Blanking a channel in one channel bank will make it blank in all channel banks.

Select a channel bank where the deleted channel number is set to 'Normal Added'. Direct enter the deleted channel number. Change to the bank you want to activate the channel in. Select 'Normal Added' on the Ch Preview Channel Banks menu.

TV is set up to display 'Inactive TV' message if all channels are 'Normal Delete' from Channel Bank 4. Select another channel bank (Bank 1, 2 or 3) which will return TV to normal operation.

Channel was deleted in currently selected channel bank. If banks were set up, premium channels may only be available on another channel bank. Select the channel bank where the channel is set to 'Normal Added'. Or, direct enter channel number then go to banks menu and select 'Normal Added'.

Item 027 Hospital Mode in Installer menu is set to 0. Set back to default '2' for Channel Banks to appear with Bank or Source key presses.



# Troubleshooting Flow Chart

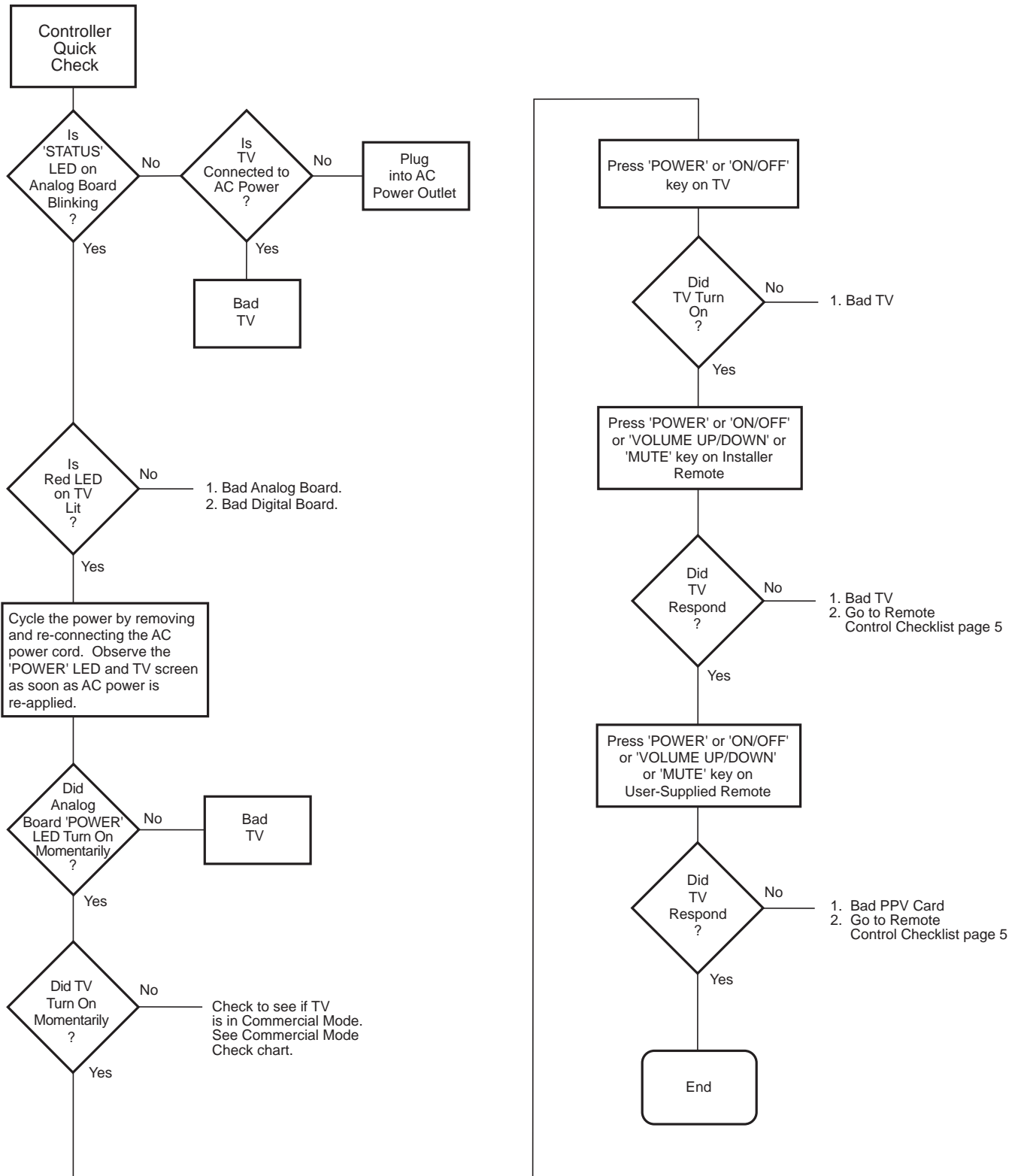

# Commercial Mode Check

---

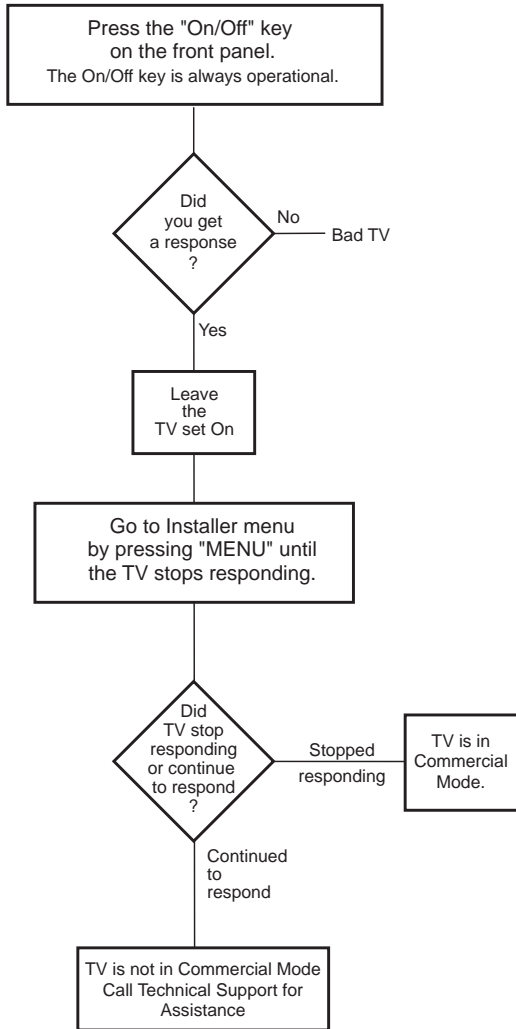

*A list of definitions for some of the words found in this guide*

## **75 OHM RF CABLE**

The wire that comes from an off-air antenna or cable service provider. The end looks like a hex-shaped nut with a wire sticking through the middle. It screws onto the Antenna/Cable threaded jack on the back of the TV.

## **300 TO 75 OHM ADAPTER**

A small device that connects a two-wire 300 ohm antenna to a 75 ohm RF jack. They are usually about an inch long with two screws on one end and a round opening with a wire sticking out on the other end.

## **ANALOG TELEVISION**

Standard television broadcasting format in 4:3 picture aspect ratio.

## **A/V CABLES**

Audio/Video cables. Three cables bunched together—right audio (red), left audio (white), and video (yellow). A/V cables are used for stereo playback of videocassettes and for higher quality picture and sound from other A/V devices.

## **A/V DEVICE**

Any device that produces video or sound (VCR, DVD, cable box, or television).

## **AMPLIFIER**

An electronic device that amplifies sound from a television, CD player, VCR, DVD, or other Audio/Video device.

## **ANTENNA**

The physical receiver of television signals sent over the air. A large metal piece of equipment does not always have to be visible to be using an antenna.

## **CABLE**

Cable service box. Refers to the descrambler box cable subscribers use to receive cable programming signals.

## **CATV**

Programming provided by a cable service.

## **DIGITAL TELEVISION**

High-resolution, cinema-quality television signals transmitted digitally.

## **DVI**

Digital Video Interface  
Accommodates analog and digital interfaces with a single connector.

## **COMPOSITE VIDEO**

Typical video jack, uses one wire for transporting three-color video signals.

## **COMPONENT VIDEO**

Uses three wires for transporting three-color video signals. The end result is usually better video quality.

## **DELETED**

Lets you remove channels from the list that the end user can scroll through using CH (Channel) Up/Down.

## **HDMI**

High-definition multi-media interface.

## **HDTV**

High-definition television. Refers to television signals that have higher resolution than ordinary analog TV signals.

## **HDSTB**

High-definition set top box. Refers to a tuner device that receives high-definition television signals which have higher resolution than ordinary analog TV signals.

## **INPUT**

Refers to the input jack that receives a signal from a TV, VCR, DVD Player or other Audio/Video device.

## **JACK**

An input or output connector on the back of a TV, VCR, DVD Player or other Audio/Video device.

## **MONO SOUND**

Mono (monaural) sound is one channel of sound. On more than one speaker, all the speakers play the same audio.

## **OUTPUT**

Refers to the output jack that sends a signal out of a VCR, DVD, or other A/V device.

## **PHYSICAL CHANNEL NUMBER**

See Note 1.

## **RGB (Red, Green, Blue)**

Connection input or output port available for producing a video image using three separate colors: Red, Green, and Blue.

## **RS-232**

Serial communication port through which the display panel is controlled.

## **2ND AUDIO PROGRAMMING/SAP**

Second Audio Programming (SAP) is another, separate audio channel available with some programming. Choosing SAP often refers to listening to audio in another language, such as Spanish or French.

## **SIGNAL**

Picture and sound traveling through a cable, or over the air, to the TV.

## **STEREO SOUND**

Stereo (Stereophonic) sound refers to audio that's divided into right and left sides.

## **TUNER**

Device that picks up the broadcast signal and turns it into picture and sound.

## **VIRTUAL CHANNEL NUMBER**

See Note 1.

## **XDS**

Extended Data Service: Additional program information included on the signal provided at the discretion of the broadcaster.

---

## **Note 1**

Refer to [www.atsc.org](http://www.atsc.org) for further information.



---

For Customer Support/Service Please call:

**1-888-865-3026**

[www.lgcommercial.com](http://www.lgcommercial.com)

Marketed and Distributed in the United States by LG Electronics U.S.A., Inc.  
1000 Sylvan Avenue  
Englewood Cliffs, NJ 07632

© Copyright 2008, LG Electronics U.S.A., Inc.

206-4096  
Issue-C

## Free Manuals Download Website

<http://myh66.com>

<http://usermanuals.us>

<http://www.somanuals.com>

<http://www.4manuals.cc>

<http://www.manual-lib.com>

<http://www.404manual.com>

<http://www.luxmanual.com>

<http://aubethermostatmanual.com>

Golf course search by state

<http://golfingnear.com>

Email search by domain

<http://emailbydomain.com>

Auto manuals search

<http://auto.somanuals.com>

TV manuals search

<http://tv.somanuals.com>