



**26LD320H 32LD320H 37LD320H 42LD320H  
32LD325H 37LD325H  
26LD340H 32LD340H 37LD340H 42LD340H  
26LD345H 32LD345H 37LD345H 42LD345H**

**Lodging Guest Interactive Pro:Centric™ TVs**

---

## **Commercial Mode Setup Guide**

Note: Selected features shown in this guide may not be available on all models.

### **EXPERIENCED INSTALLER**

Master TV Setup  
pages 11–14

Cloning Information  
pages 23–29

FTG Mode of Operation  
pages 30–40

For Customer Support/Service, please call:  
**1-888-865-3026**

The latest product information and documentation is available online at:  
**www.LGolutions.com/products**

MODEL and SERIAL NUMBER

The model and serial numbers of this TV are located on the back of the cabinet. For future reference, LG suggests that you record those numbers here:

Model No. \_\_\_\_\_ Serial No. \_\_\_\_\_



**WARNING:**

TO REDUCE THE RISK OF ELECTRIC SHOCK DO NOT REMOVE COVER (OR BACK). NO USER-SERVICEABLE PARTS INSIDE. REFER TO QUALIFIED SERVICE PERSONNEL.



The lightning flash with arrowhead symbol, within an equilateral triangle, is intended to alert the user to the presence of uninsulated “dangerous voltage” within the product’s enclosure that may be of sufficient magnitude to constitute a risk of electric shock to persons.



The exclamation point within an equilateral triangle is intended to alert the user to the presence of important operating and maintenance (servicing) instructions in the literature accompanying the appliance.

**WARNING:**

TO PREVENT FIRE OR SHOCK HAZARDS, DO NOT EXPOSE THIS PRODUCT TO RAIN OR MOISTURE.

**POWER CORD POLARIZATION:**

This product is equipped with a 3-wire grounding-type alternating current power plug. This plug will fit into the power outlet only one way. This is a safety feature. If you are unable to insert the plug fully into the outlet, contact your electrician to replace your obsolete outlet. Do not defeat the safety purpose of the 3-wire grounding-type plug.

**NOTE TO CABLE/TV INSTALLER:**

This reminder is provided to call the cable TV system installer’s attention to Article 820-40 of the National Electric Code (U.S.A.). The code provides guidelines for proper grounding and, in particular, specifies that the cable ground shall be connected to the grounding system of the building, as close to the point of the cable entry as practical.

**REGULATORY INFORMATION:**

This equipment has been tested and found to comply with the limits for a Class B digital device, pursuant to Part 15 of the FCC Rules. These limits are designed to provide reasonable protection against harmful interference when the equipment is operated in a residential installation. This equipment generates, uses and can radiate radio frequency energy and, if not installed and used in accordance with the instruction manual, may cause harmful interference to radio communications. However, there is no guarantee that interference will not occur in a particular installation. If this equipment does cause harmful interference to radio or television reception, which can be determined by turning the equipment off and on, the user is encouraged to try to correct the interference by one or more of the following measures:

- Reorient or relocate the receiving antenna.
- Increase the separation between the equipment and receiver.
- Connect the equipment to an outlet on a circuit different from that to which the receiver is connected.
- Consult the dealer or an experienced radio/TV technician for help.

**CAUTION:**

Do not attempt to modify this product in any way without written authorization from LG Electronics U.S.A., Inc. Unauthorized modification could void the user’s authority to operate this product.

**COMPLIANCE:**

The responsible party for this product’s compliance is: LG Electronics U.S.A., Inc.  
1000 Sylvan Avenue, Englewood Cliffs, NJ 07632, USA • Phone: 1-201-816-2000

Marketed and Distributed in the United States by LG Electronics U.S.A., Inc.  
1000 Sylvan Avenue, Englewood Cliffs, NJ 07632

# IMPORTANT SAFETY INSTRUCTIONS

1. Read these instructions.
2. Keep these instructions.
3. Heed all warnings.
4. Follow all instructions.
5. Do not use this apparatus near water.
6. Clean only with dry cloth.
7. Do not block any ventilation openings. Install in accordance with the manufacturer's instructions.
8. Do not install near any heat sources, such as radiators, heat registers, stoves, or other apparatus (including amplifiers) that produce heat.
9. Do not defeat the safety purpose of the polarized or grounding-type plug. A polarized plug has two blades with one wider than the other. A grounding-type plug has two blades and a third grounding prong. The wide blade or the third prong are provided for your safety. If the provided plug does not fit into your outlet, consult an electrician for replacement of the obsolete outlet.
10. Protect the power cord from being walked on or pinched, particularly at plugs, convenience receptacles, and the point where it exits from the apparatus.
11. Only use attachments/accessories specified by the manufacturer.
12. Use only with the cart, stand, tripod, bracket, or table specified by the manufacturer or sold with the apparatus. When a cart is used, use caution when moving the cart/apparatus combination in order to avoid injury from tip-over.



PORTABLE CART WARNING

13. Refer all servicing to qualified service personnel. Servicing is required when the apparatus has been damaged in any way, such as power-supply cord or plug is damaged, liquid has been spilled or objects have fallen into the apparatus, the apparatus has been exposed to rain or moisture, does not operate normally, or has been dropped.
14. Never touch this apparatus or antenna during a thunder or lightning storm.
15. When mounting a TV on the wall, make sure not to install the TV by the hanging power and signal cables on the back of the TV.
16. Do not allow an impact shock or any objects to fall into the product, and do not drop objects onto the screen.

## 17. Power Cord

**Caution: It is recommended that appliances be placed upon a dedicated circuit; that is, a single outlet circuit which powers only that appliance and has no additional outlets or branch circuits. Check the specification page in the Owner's Manual to be certain.**

Periodically examine the cord of your appliance, and if its appearance indicates damage or deterioration, unplug it, discontinue use of the appliance, and have the cord replaced with an exact replacement part by an authorized servicer. Protect the power cord from physical or mechanical abuse, such as twisting, kinking, or pinching or being closed in a door or walked upon. Pay particular attention to plugs, wall outlets, and the point where the cord exits the appliance.

Do not use a damaged or loose power cord. Be sure to grasp the plug when unplugging the power cord. Do not pull on the power cord to unplug the TV.

## 18. Overloading

Do not connect too many appliances to the same AC power outlet as this could result in fire or electric shock. Do not overload wall outlets. Overloaded wall outlets, loose or damaged wall outlets, extension cords, frayed power cords, or damaged or cracked wire insulation are dangerous. Any of these conditions could result in fire or electric shock.

## 19. Outdoor Use/Wet Location



**Warning: To reduce the risk of fire or electrical shock, do not expose this product to rain, moisture or other liquids.**

Do not touch the TV with wet hands. Do not install this product near flammable objects such as gasoline or candles or expose the TV to direct air conditioning.

Do not expose to dripping or splashing and do not place objects filled with liquids, such as vases, cups, etc., on or over the apparatus (e.g., on shelves above the unit).

## 20. Grounding

Ensure that you connect the earth ground wire to prevent possible electric shock (i.e., a TV with a three-prong grounded AC plug must be connected to a three-prong grounded AC outlet). If grounding methods are not possible, have a qualified electrician install a separate circuit breaker. Do not try to ground the unit by connecting it to telephone wires, lightning rods, or gas pipes.

## 21. Disconnect Device

The mains plug is the disconnecting device. The plug must remain readily operable.

As long as this unit is connected to the AC wall outlet, it is not disconnected from the AC power source even if you turn off this unit by SWITCH.

(Continued on next page)

# IMPORTANT SAFETY INSTRUCTIONS

(Continued from previous page)

## 22. Outdoor Antenna Grounding

If an outside antenna or cable system is connected to the product, follow the precautions below.

An outdoor antenna system should not be located in the vicinity of overhead power lines or other electric light or power circuits or where it can come into contact with such power lines or circuits as death or serious injury can occur.

Be sure the antenna system is grounded so as to provide some protection against voltage surges and built-up static charges.

Article 810 of the National Electrical Code (NEC) in the U.S.A. provides information with respect to proper grounding of the mast and supporting structure, grounding of the lead-in wire to an antenna-discharge unit, size of grounding conductors, location of antenna-discharge unit, connection to grounding electrodes, and requirements for the grounding electrode.

### Antenna Grounding According to NEC, ANSI/NFPA 70

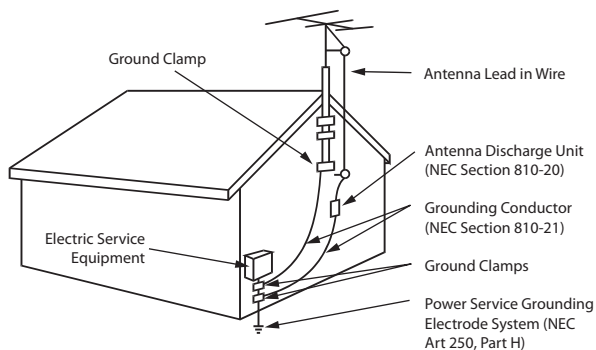

## 23. Cleaning

When cleaning, unplug the power cord and wipe gently with a soft cloth to prevent scratching. Do not spray water or other liquids directly on the TV as electric shock may occur. Do not clean with chemicals such as alcohol, thinners or benzene.

## 24. Transporting Product

Make sure the TV is turned Off and unplugged and that all cables have been removed. It may take two or more people to carry larger TVs. Do not press against or put stress on the front panel of the TV during transport.

## 25. Ventilation

Install the TV where there is proper ventilation. Do not install in a confined space such as a bookcase. Do not cover the TV with cloth or other materials (e.g., plastic) while it is plugged in. Do not install in excessively dusty places.

26. Do not touch the ventilation openings, as they may become hot while the TV is operating.
27. If you smell smoke or other odors coming from the TV or hear strange sounds, unplug the power cord, and contact an authorized service center.
28. Do not press against the front panel of the TV with your hand or a sharp object (e.g., a nail, pencil, or pen) or make a scratch on it.
29. Keep the product away from direct sunlight.

## 30. Dot Defect

The LCD panel is a high technology product with resolution of two million to six million pixels. In a very few cases, you could see fine dots on the screen while you are viewing the TV. Those dots are deactivated pixels and do not affect the performance and reliability of the TV.

## 31. Generated Sound

“Cracking”: A cracking noise that occurs while the TV is On or when it is turned Off is generated by plastic thermal contraction due to temperature and humidity. This noise is common for products where thermal deformation is required.

Electrical circuit humming/panel buzzing: A low level noise is generated from a high-speed switching circuit, which supplies a large amount of current to operate a product. It varies depending on the product. This generated sound does not affect the performance and reliability of the product.

## 32. For LCD TV

If the TV feels cold to the touch, there may be a small “flicker” when it is turned On. This is normal; there is nothing wrong with TV. Some minute dot defects may be visible on the screen, appearing as tiny red, green, or blue spots. However, they have no adverse effect on the TV’s performance. Avoid touching the LCD screen or holding your finger(s) against it for long periods of time. Doing so may produce some temporary distortion effects on the screen.

# Table of Contents

Safety Warnings . . . . .	2	<b>FTG Mode via CPU</b> . . . . .	32–35
Important Safety Instructions . . . . .	3–4	Creating an FMA Configuration File using the FTG Device Configuration Application . . . . .	32
Table of Contents . . . . .	5	Teaching FMA Configuration to a TV . . . . .	33
Commercial Mode Overview . . . . .	6–7	Learning an FMA Configuration File from a TV . . . . .	34
Setup Checklist . . . . .	6	Optional Manual Configuration / TV Setup . . . . .	35
Pass-through Mode . . . . .	6	<b>FTG Mode via EBL</b> . . . . .	36
FTG Mode . . . . .	7	FTG Device Configuration Application Utilities	
Remote Management in FTG Mode . . . . .	7	Overview . . . . .	37–40
External MPI Control . . . . .	7	FTG Channel Map Configuration Utility . . . . .	37
Pro:Centric Operation . . . . .	8–9	FTG Channel Map Editor . . . . .	38
Pro:Centric TV Interactive Menu Features . . . . .	8	FTG Installer Menu Configuration Utility . . . . .	39
Pro:Centric Setup . . . . .	9	FMA Configuration Utility . . . . .	40
Installer Remote Control Typical Key Functions . . . . .	10	Remote Jack Pack / TV Connections & Setup . . . . .	41
<b>Master TV Setup</b> . . . . .	11–14	<b>References</b>	
Before You Begin . . . . .	11	Upgrading TV/PTC Software using a USB Memory Device . . . . .	42
Cloning Methods . . . . .	11	Downloading a Splash Screen using a USB Memory Device . . . . .	43
Clonable TV Setup Menu Features . . . . .	11	Power Consumption Settings . . . . .	44–45
Master TV Setup Procedure . . . . .	12	TV Camport Auto Sense Operation . . . . .	46
<b>Installer Menu</b> . . . . .	15–21	TV Aux Input Configuration . . . . .	47
Accessing the Installer Menu . . . . .	15	<i>b</i> -LAN Setup & Overview . . . . .	48
Using the Installer Menu . . . . .	15	RJP Model List and Input Auto-sensing Hierarchy . . . . .	49
Exiting the Installer Menu and Activating Updates . . . . .	15	Resetting Factory Defaults on the TV(s) . . . . .	50
Channel Icons / Custom Text Labels (2-5-4 + MENU Mode) . . . . .	22	LD320H/LD325H & LD340H/LD345H Rear Jack Panel . . . . .	51
<b>Cloning Overview</b> . . . . .	23	Side Connections Panel / RF Antenna & MPI Connections . . . . .	52
<b>USB Cloning Procedure</b> . . . . .	24–25	Troubleshooting . . . . .	53–56
Learning / Teaching a Master TV Setup using a USB Memory Device . . . . .	24	General Troubleshooting . . . . .	53
<b>Clone Programmer Cloning Procedures</b> . . . . .	26–29	Troubleshooting Flow Chart . . . . .	54
Learning / Teaching a Master TV Setup using a TLL-1100A Clone Programmer . . . . .	26	Commercial Mode Check / FTG Operating Troubleshooting . . . . .	55
Learning / Teaching a Master TV Setup using an LT2002 Clone Programmer . . . . .	28	Clone Programmer Troubleshooting . . . . .	56
<b>FTG Mode of Operation Overview</b> . . . . .	30–31	Glossary of Terms . . . . .	57
FTG Mode via CPU or EBL . . . . .	30	Document Revision History / Notes . . . . .	58
Determining the TV Operating Mode . . . . .	31	Back Cover . . . . .	59

## Notes

- Installer Menu content is intended for use primarily by qualified TV electronics technicians.
- Refer to the Owner's Manual for additional information on TV installation, features, specifications, maintenance, and safety instructions.
- Design and specifications subject to change without prior notice.

# Commercial Mode Overview

---

This document describes how to set up LD320H/LD325H and LD340H/LD345H Pro:Centric™ TVs for Commercial Mode operation. LG commercial TV functionality is based on “ownership” of the Channel Map; that is, the Channel Map resides in the TV’s CPU, Protocol Translator Card (PTC), or embedded b-LAN™ (EBL) module, or it resides externally from the TV (i.e., in a device from the solution provider).

Each of these TV models has an EBL module that can be configured either for Pass-through Mode (default) or Free-To-Guest (FTG) Mode. In addition, each of these TVs is capable of FTG Mode operation via the TV CPU when the EBL is in Pass-through Mode.

## Setup Checklist

**Note:** This document provides information specific to Commercial Mode operation. Refer to the Owner’s Manual for detailed information on TV installation and hardware and cable connections.

### Installation and Setup Checklist

- \_\_\_ Unpack TV and all accessories.
- \_\_\_ Install batteries in remote control.
- \_\_\_ Install TV on VESA mount or stand.

**Note:** It may be advisable to make all cable connections before installing on VESA mount or stand, as appropriate.

### Hardware Connections

- \_\_\_ Install any additional hardware as appropriate to your institution, LAN, etc.

### Cable Connections

- \_\_\_ Make all rear jack panel and MPI card slot connections, as appropriate.

### Commercial Mode Setup

- \_\_\_ Complete appropriate procedures as described in this document for Commercial Mode operation. See “Pass-through Mode” and “FTG Mode” sections below for further information.

## Pass-through Mode

This mode allows you to create a Master TV Setup for cloning purposes for TVs that are to remain in Pass-through Mode. This mode also allows external control via the TV’s GAME CONTROL/MPI port. Use the Installer Remote to configure Installer Menu items as required for TV operation and set up TV features (Channel, Picture, Audio, etc.). See “Master TV Setup” on pages 11 to 14 for detailed information.

### Installer Menu

To set up a Master TV for cloning purposes, you will need to know how to enter the commercial controller (PTC) Installer Menu and make changes to the default values as required. If necessary, familiarize yourself with the Installer Menu and how to make and save changes. Refer to pages 15 to 21 for information on accessing the Installer Menu in Pass-through Mode and for detailed descriptions of the Installer Menu items.

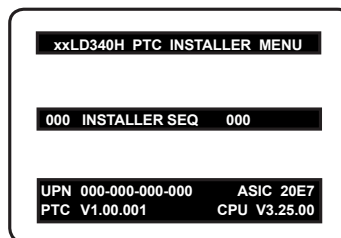

Typical Installer Menu

### TV Setup Menus

On-screen setup menus control the features of the TV. Use the Installer Remote to access the TV setup menus, and set the TV features to the desired configuration for the end user. Refer to the Owner’s Manual for detailed information on the TV setup menus.

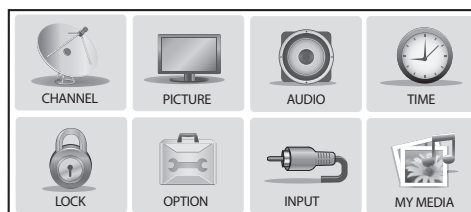

TV Setup Menus



## Cloning

Cloning refers to the process of capturing a Master TV Setup and transferring it to a Target TV (both TVs must be in Pass-through Mode). The Master TV's clonable setup menu options should be configured as part of the Master TV Setup. If there are features in the Master TV's setup—channel icons or labels, digital font options, etc.—that are not set or that are set incorrectly, those features also will not be set or will be set incorrectly in the Target TVs. Pages 23 to 29 provide detailed information on cloning requirements and procedures.

## FTG Mode

This mode enables Pro:Idiom<sup>®</sup> decryption and also allows logical channel mapping of physical channels to remove the need for dash tuning. TV operation in FTG Mode is based on which element of the TV owns the FTG Logical Channel Map—the CPU or the EBL. Understanding the application in which the TV will be used is vital in determining the owner.

As indicated above, FTG mode operation in the LD320H/LD325H and LD340H/LD345H models can be provided either by the TV CPU or EBL (see note below). These are two separate and distinct FTG Modes of operation, each with its own unique advantages and requirements as described later in this document. When the TV CPU is configured with an FTG Channel Map, the CPU controls the operation of the TV, and when the EBL is configured with an FTG Channel Map, the EBL controls the operation of the TV.

Once it is determined whether the TV CPU or the EBL will own the FTG Channel Map, configuration can begin. Configuration of either requires the LG FTG Device Configuration Application. This application provides utilities that enable you to create/edit an FTG Channel Map and configure Installer Menu settings. See pages 30 to 40 for further information on FTG Mode operation and configuration.

**Note:** LD320H/LD325H TVs must have the following minimum software loads in order to support FTG Mode via CPU: CPU version 3.61 or later and PTC version 1.01.008 or later. If necessary, contact LG to obtain LD320H/LD325H CPU and PTC software files, and perform the software updates as described in Reference section, “Upgrading TV/PTC Software using a USB Memory Device.”

## Remote Management in FTG Mode

When the TV is configured for FTG Mode via CPU, remote management of the FTG Channel Map and FTG Installer Menu settings is provided by a Pro:Centric server. Refer to the **Pro:Centric™ Server Admin Client User Guide** for further information.

When the TV is configured for FTG Mode via EBL, the *b*-LAN module, which is internal to the TV, allows hotel/institution head end equipment (for example, an FMA-LG101) with *b*-LAN technology to communicate with the TV to provide remote management of the FTG Channel Map and FTG Installer Menu settings. See Reference section, “*b*-LAN Setup & Overview,” for further information.

## External MPI Control

To control the TV using an external MPI control device, you must use the TV's GAME CONTROL/MPI port for communication purposes. In these TVs, Installer Menu item 118 POWER SAVINGS controls the power circuitry for both the embedded *b*-LAN module and the GAME CONTROL/MPI port; therefore, to ensure that the GAME CONTROL/MPI port circuitry is powered, thus enabling MPI communication, Installer Menu item 118 POWER SAVINGS must be set appropriately. See Installer Menu item descriptions as well as reference section, “*b*-LAN Setup & Overview,” for further information.

# Pro:Centric Operation



## Pro:Centric TV Interactive Menu Features

**Important: Pro:Centric operation requires that Installer Menu items 098 PRO:CENTRIC and 119 DATA CHANNEL be set appropriately and that the TV be in PPV or FTG Mode.**

The interactive Pro:Centric TV enables guests—from the comfort of their hotel rooms—to view and select from a complete listing of hotel services and amenities. The Pro:Centric TV is connected to the hotel's billing computer, and service/amenities charges are billed at the time of order.

Interactive amenities may include:

- Hotel information, news, and events
- Directory services (tourist attractions, restaurants, etc.)
- Reservation services (business meetings, fitness, spa, etc.)
- Weather and traffic information
- Shopping services (delivery to guest room)
- Room service (menu ordering, memo service, morning wake up call, laundry, etc.)
- Ticketing and gaming services
- Check-out service (in the guest room)
- E-mail resources/account access

Use the Installer Remote to operate both interactive menus and regular TV features. Press **PORTAL** on the Installer Remote to access the interactive menus.

**Note:** Interactive menu options may vary, depending on Pro:Centric features enabled for the site. The following are default interactive menus.

### Channel Guide

Shows available TV networks and logical channels. When available, electronic program guide (EPG) data provides additional channel and program information.

### Information

Typically displays hotel information, for example, photos of guest rooms, dining rooms, business centers, facilities, etc., as well as information on local weather and attractions. Information may also include resources, such as local school programs, run in cooperation with the hotel.

### Help

Provides help for navigating the interactive menus.

### Watch TV

Removes the interactive menu from the screen and returns to the previously tuned TV channel.

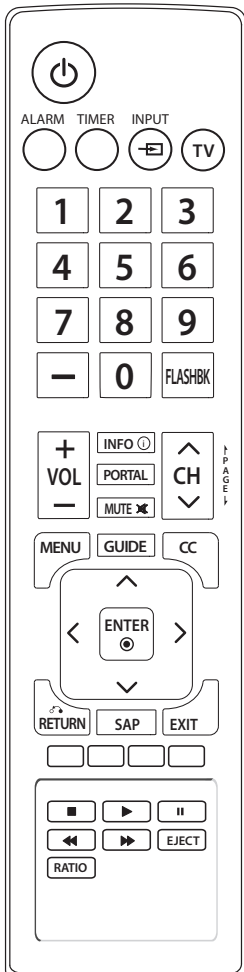



### Pro:Centric Setup

The Pro:Centric server provides the following functionality:

- Remote management/administration (TV E-Z Installation): The Pro:Centric server Admin Client provides remote management/administration facilities for downloading splash screens and software/firmware updates as well as facilities for downloading FTG Channel Map and FTG Installer Menu settings for TVs that are in FTG Mode via CPU (see also “Remote Management in FTG Mode” on page 7).

The Data Channel must be set appropriately in the Installer Menu (item 119 DATA CHANNEL) to enable Pro:Centric remote management/administration facilities.

- Pro:Centric application: The application comprises the Pro:Centric interactive menus/features described on the previous page. Pro:Centric application settings are managed via the Pro:Centric server Admin Client.

In addition to the Data Channel, the Pro:Centric Application Mode must be set appropriately in the Installer Menu (item 098 PRO:CENTRIC) to enable the Pro:Centric application.

Administration and management options for the Pro:Centric server are described in detail in the **Pro:Centric™ Server Admin Client User Guide**. This document describes only those settings that must be specified on the TVs.

# Installer Remote Control Typical Key Functions

The LG Installer Remote is supplied with and dedicated to operate the TV. The LG Installer Remote illustrated below and throughout this document shows typical remote control functions and is provided for reference only. This Installer Remote may vary from the Installer Remote supplied with the TV.

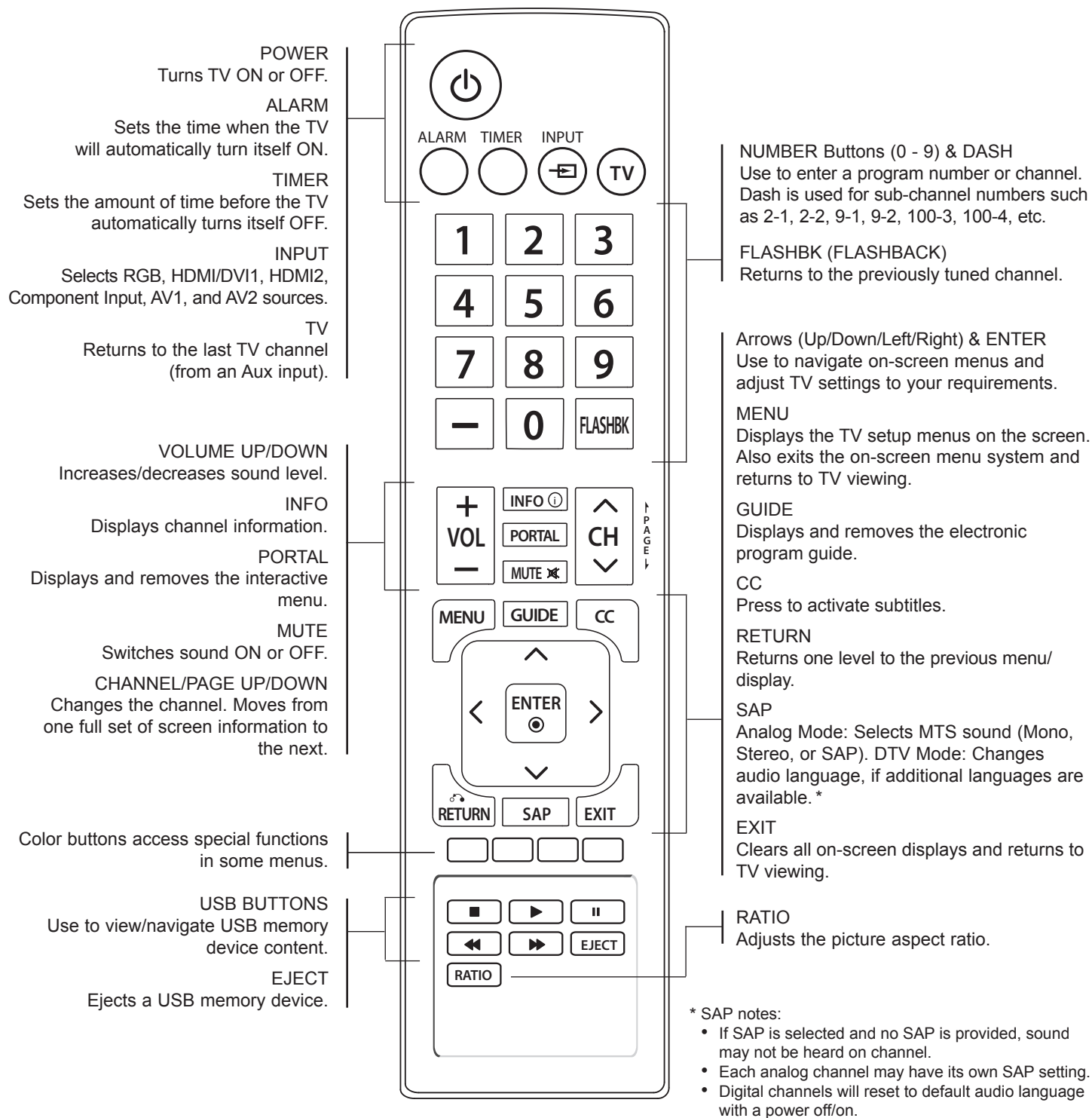

This section describes how to set up a Master TV for cloning purposes when the TV is in Pass-through Mode.

**Note:** Refer to FTG Mode information on pages 30 to 40 for details on entering FTG Mode and configuring/editing FTG Channel Map and FTG Installer Menu settings.

## Before You Begin

- Disconnect all Aux inputs if you intend to run Auto Tuning (Channel Search). Under certain conditions, Auto Tuning is disabled if there is an Aux input active.
- Determine which cloning tool—USB memory device or clone programmer—is appropriate for your application. See “Cloning Methods” below for further information.

## Cloning Methods

### Using a USB Memory Device / .tll File

The .tll file format clones the contents of the commercial controller (PTC) memory, including an auto-tuned/edited Channel Map, Installer Menu settings, and one TV source’s (analog, digital, or Aux) clonable setup menu settings. See “Clonable TV Setup Menu Features” list below.

### Using a Clone Programmer (TLL-1100A or LT2002)

Both the TLL-1100A and LT2002 clone the contents of the commercial controller (PTC) memory, including an auto-tuned/edited Channel Map, Installer Menu settings, and one TV source’s (analog or Aux) clonable setup menu settings. See “Clonable TV Setup Menu Features” list below.

## Clonable TV Setup Menu Features

<b>Channel</b> Auto Tuning (Channel Lineup) Manual Tuning Channel Edit Channel Label	<b>Audio</b> Auto Volume Clear Voice Sound Mode Balance TV Speaker	<b>Option</b> Menu Language Audio Language Caption
<b>Picture</b> Aspect Ratio Picture Mode	<b>Time</b> Auto Clock Auto Off (Sleep Timer)	<b>Lock</b> Movie Rating TV Rating – Children TV Rating – General

**Note:** Some menu options vary between analog and digital channels and Aux inputs.

# Master TV Setup (Cont.)

## Master TV Setup Procedure

### 1. Set Installer Menu items.

This step provides specific instruction only on the Installer Menu items that should be set on a Master TV. Refer to pages 15 to 21 for detailed information on all Installer Menu items.

- a) Make sure the TV is ON. Then, use the Installer Remote to enter the PTC Installer Menu: Press **MENU** repeatedly until the on-screen display of the TV setup menus no longer toggles, and then press **9-8-7-6 + ENTER**.
- b) Set Installer Menu item **117 FACT DEFAULT** to **001** and press **ENTER** on the Installer Remote.

This clears all Installer Menu custom settings, channel lineup, etc. and reloads the factory default settings. The value will change back to 0 after the PTC has been restored to factory default condition. This step ensures that the TV Channel Memory will be the active channel lineup.

- c) Set Installer Menu item **003 BAND/AFC**, as appropriate.
  - Broadcast: Set to 000.
  - CATV: Set to 001 (default).
  - HRC: Set to 002.
  - IRC: Set to 003.
- d) Set any other Installer Menu items that affect your TV programming network to the required configuration. For example, enable/disable Aux inputs, set a Start Channel, etc.
- e) After you have adjusted all required Installer Menu item settings, press **ENTER** once on the Installer Remote to save your changes; then, press **ENTER** again to exit the menu.

### 2. Set up TV features.

On-screen setup menus control the features of the TV. Press **MENU** on the Installer Remote to access the TV setup menus, and then set Channel, Picture, Audio, Lock, Time, etc. options to the desired configurations. See also the Clonable TV Setup Menu Features list on page 11.

**Note:** Remember that only one TV source's clonable setup menu settings will be cloned. Thus, for a clone programmer, the TV setup menu settings should be applicable to either an analog channel or Aux input, while for a USB memory device, the TV setup menu settings should be applicable to the analog or digital channel or Aux input to which the Target TV will be set during the Teaching process.

**Note:** If desired, you can run Auto Tuning (see step 3) prior to completing this step.

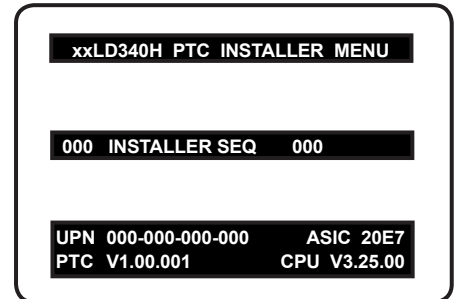

Typical Installer Menu

Note: The Installer Menu header will vary depending on the TV you are setting up.

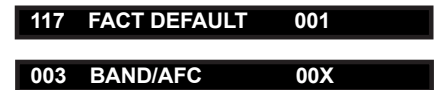

Adjust the settings for these Installer Menu items.

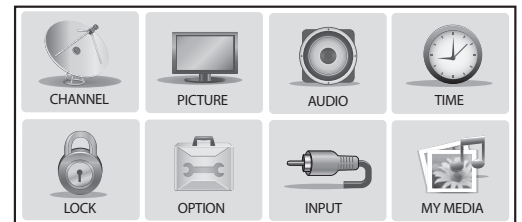

Use the TV setup menus to set the TV features to the desired configuration for the end user.

(Continued on next page)

(Continued from previous page)

### 3. Run Auto Tuning.

- a) To search for all available analog and digital channels, go to the Channel Menu, select the **Auto Tuning** option, and follow the on-screen instructions.
- b) Use the **Channel Edit** option in the Channel Menu to edit the channel lineup, as necessary, to include only free to guest (non-encrypted) channels.
  - Add/delete channels per your system requirements.
  - Use the **Channel Label** option in the Channel Menu to select the appropriate trademark/icon for each channel's Channel-Time on-screen display. Icons are available for familiar channels, such as ABC, CBS, NBC, etc. Identifiable labels (icons) should enable the end user to readily know what common networks are available.

**Note:** If Installer Menu item 103 ATSC TUNE MODE is set for Physical Channel tuning (default and recommended setting), channels with minor channel numbers higher than 255 will not transfer correctly in step 5. If item 103 is set for Virtual Channel tuning and either the major or minor channel numbers are higher than 255, the channel(s) will not transfer correctly in step 4.

**Note:** You can add the channel icons in this step or as described in step 6. Also in step 6, you can add custom text labels for channels without icons.

### 4. Transfer the TV setup menu settings to the commercial controller (PTC): 2-5-5 + MENU Mode

**Important: This step is essential for successful cloning. Without this step, the PTC will not contain any of the TV setup menu settings.**

- a) After the TV channel lineup has been edited and channel label icons added, tune to the channel (source) for which you wish to transfer TV setup menu settings.

**Note:** If you intend to use a clone programmer for cloning purposes, this must be either an analog channel or Aux input.
- b) Enter the Installer Menu, and press **2-5-5 + MENU** on the Installer Remote to initiate the transfer of the Master TV Setup to the PTC. The TV exits the Installer Menu and then tunes through the channels in the channel lineup during the transfer. When the transfer is complete, the TV tunes back to the channel that was tuned before the transfer began.

**Note:** The maximum number of channels that can be transferred is 141. An attempt to transfer more than 141 channels will result in erratic TV tuning operation.

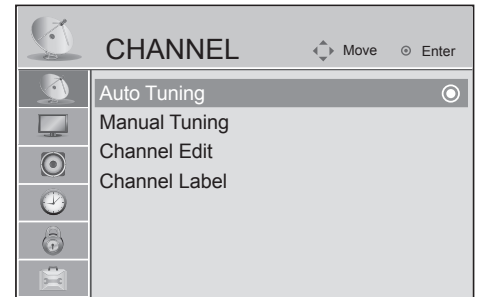

Use Channel Menu options to run Auto Tuning, edit channels, and select channel icons.

(Continued on next page)

# Master TV Setup (Cont.)

---

(Continued from previous page)

## 5. (Optional) Add Custom Channel and Aux Input Labels: 2-5-4 + MENU Mode

**Note:** 2-5-4 + MENU Mode enables you to add/edit channel icons and custom text labels in the PTC once the Master TV Setup has been transferred as described in the previous step.

Enter the Installer Menu, and press **2-5-4 + MENU** on the Installer Remote. Add/edit custom text labels and/or change icons for the Channel-Time on-screen displays (see 2-5-4 + MENU procedural information on page 22). Note that broadcast digital channels often already have a broadcaster generated label. When you are finished, press **MENU** to exit 2-5-4 + MENU Mode.

## 6. Verify the TV setup.

Verify that the channel lineup, channel icons, and custom text labels are correct. Also, make sure the TV features are set per your requirements.

## 7. Lock the channel lineup.

Enter the Installer Menu. Set item **028 CH. OVERRIDE** to **000** and press **ENTER** to lock the channel lineup and restrict access to the TV setup menus. Press **ENTER** again to save your changes and exit the Installer Menu.\*

The Master TV Setup is now ready to be copied to the predetermined cloning tool—a USB memory device or a clone programmer. See cloning procedures in this document.

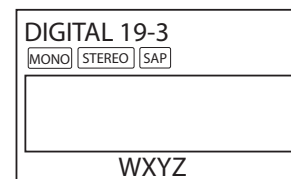

Custom text label “WXYZ” created in 2-5-4 + MENU Mode.

---

**028 CH. OVERRIDE 000**

After verifying the TV Setup, set Installer Menu item 028 CH. OVERRIDE to 000.\*

\* This step prevents end users from accessing channel settings (i.e., the Channel Menu will be inaccessible/grayed out).



Use the Installer Menu to set up or change operational settings. Refer to the table starting on the next page for brief descriptions of Installer Menu items. More detailed descriptions follow the table listing.

## Accessing the Installer Menu

1. Make sure the TV is ON.
2. Using an Installer Remote, press **MENU** repeatedly until the on-screen display of the TV setup menus (if the TV is in Pass-through Mode) or the Function Menu (if the TV is not in Pass-through Mode) no longer toggles, and then press **9-8-7-6 + ENTER** to access the Installer Menu.

The Installer Menu opens with item 000 INSTALLER SEQ 000.

**Note:** If the password is not entered or registered correctly, you will see the message "ENTER PASSWORD 0000" at the top of the screen instead of the Installer Menu header. Once you re-enter the correct password (i.e., press **9-8-7-6 + ENTER**), the Installer Menu will display.

**Note:** If the TV is in FTG Mode, the Installer Menu is accessible as read-only. Refer to pages 30 to 40 for information on FTG Mode configuration.

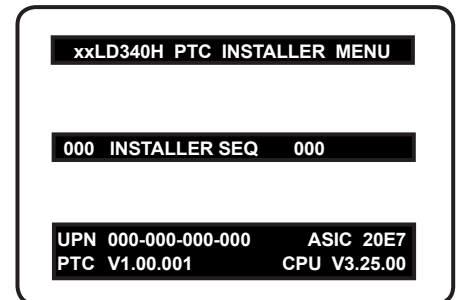

Typical Installer Menu

## Using the Installer Menu

Refer to the table on pages 16 and 17 for an overview of the available Installer Menu items, including their item numbers, functions, value ranges, and default values. Installer Menu items not relevant to this TV series are not present in the Installer Menu; therefore, some numbers are missing. For example, item 006 will not appear.

### Navigation within the Installer Menu

Use the Up/Down arrow keys on the Installer Remote to sequence through the available menu items, or access an item directly by keying in the line number and then pressing **MENU**. For example, to access the SLEEP TIMER option, which is item 015, press 0-1-5 + **MENU**.

### Changing Installer Menu Settings

To change an Installer Menu item value, use the Left/Right arrow keys on the Installer Remote, or enter a valid value directly. To save the new setting, press **ENTER**, or use the Up/Down arrow keys to navigate to a new Installer Menu item if you have additional items to edit. Note that invalid values will not be saved.

## Exiting the Installer Menu and Activating Updates

After you have adjusted all required Installer Menu item settings, press **ENTER** once on the Installer Remote to save your changes; then, press **ENTER** again to exit the Installer Menu. Any changes you make will be stored in non-volatile memory.

**Note:** Each time you exit the Installer Menu in Pass-through Mode, all V-Chip (Parental Control) settings in the TV are reset to their default values; that is, the Lock System, if previously enabled from the Lock setup menu (see the Owner's Manual for additional information), will now be disabled, and the individual Parental Control settings will be restored to default values.

# Installer Menu (Cont.)

## Installer Menu Items 000 through 071

Menu Item	Function	Value Range	Default Value	Brief Description of Function and Comments
000	INSTALLER SEQ	0 ~ 3	0	Leave default set to 0.
001	POWER MANAGE	0 ~ 7	0	Sets number of hours of no activity before automatic shutoff.
002	AC ON	0 / 1	0	Set to 1 to enable Auto Turn ON when AC power is applied.
003	BAND/AFC	0 ~ 3	1	Selects Tuning Band: 0=Broadcast, 1=CATV, 2=HRC, 3=IRC
004	STRT CHANNEL	0 ~ 127, 255	255	Channel tuned when TV is turned ON. (Set to 255 to tune to channel tuned before TV turned OFF.)
005	CHAN LOCK	0 / 1	0	If set to 1, cannot tune from current channel.
007	STRT VOLUME	0 ~ 63, 255	255	Volume level when TV is turned ON. (Set to 255 to use volume level before TV turned OFF.)
008	MIN VOLUME	0 ~ 63	0	Sets minimum allowable volume setting.
009	MAX VOLUME	0 ~ 63	63	Sets maximum allowable volume setting.
010	MUTE DISABLE	0 / 1	0	Set to 1 to disable Mute Function.
011	KEY DEFEAT	0 / 1	0	Set to 1 to disable menu navigation keys on display panel.
015	SLEEP TIMER	0 / 1	1	Set to 1 to enable Sleep Timer.
016	EN TIMER	0 / 1	0	Set to 1 to enable On/Off Timers.
017	ALARM	0 / 1	1	Set to 1 to enable Alarm.
020	FEATURE LEVEL	0 ~ 1, 16 ~ 24	1	Determines an additional IR code scheme to which the TV will respond.
021	V-CHIP	0 / 1	1	Set to 1 to enable V-Chip (Parental Control) functions.
022	MAX BLK HRS	0 ~ 99	12	Sets number of V-Chip blocking hours.
023	CAPTION LOCK	0 / 1	0	Set to 1 to retain caption setting set before TV turned OFF.
028	CH. OVERRIDE	0 / 1	1	If set to 0, limits direct access to favorite channels.
029	OLD OCV	0 / 1	0	Set to 1 to change MPI operation to OCV.
030	ACK MASK	0 / 1	0	If set to 1, enables ACK feature of MPI.
031	POLL RATE	20 ~ 169	94	Selects poll rate for MPI.
032	TIMING PULSE	186 ~ 227	207	Sets baud rate for MPI.
034	CAMPORT EN	0 / 1	1	Set to 1 to enable Video 2 input.
035	COMPPOINT EN.	0 / 1	1	Set to 0 to disable HDMI 1. Set to 1 enable HDMI 1.
038	YPrPb EN.	0 / 1	1	Set to 1 to enable display panel Component Video 1 input jacks.
039	REAR AUX EN	0 / 1	1	Set to 1 to enable display panel Video 1 input jack.
040	AUTO CAMPORT	0 / 1	1	Set to 1 to automatically switch to Camport. If set to 1, STRT AUX SRCE cannot be set to 2.
046	STRT AUX SRCE	1 ~ 6, 255	6	Sets the starting Aux source (if item 004 STRT CHANNEL is set to 0).
047	AUX STATUS	0 / 1	0	Set to 1 for MPI Aux source to be reported as a channel number instead of Channel 0.
053	DIS. CH-TIME	0 / 1	0	Set to 1 to disable Channel-Time display.
069	EN. CH-T COL.	0 / 1	1	Set to 1 to enable custom color for the Channel-Time display.
070	FOR. CH-TIME	0 ~ 7	2	Chooses custom foreground color for the Channel-Time display.
071	BCK. CH-TIME	0 ~ 7	2	Chooses custom background color for the Channel-Time display.

## Installer Menu Items 073 through 119

Menu Item	Function	Value Range	Default Value	Brief Description of Function and Comments
073	CH NOT AVBLE	0 / 1	0	If set to 1 and item 028 CH. OVERRIDE is set to 0, "NOT AVAILABLE" message is displayed if user direct tunes a channel that is not in the favorite channel list.
075	REVERT CH	0 / 1	0	If set to 1 and loss of MPI communication occurs, TV tunes to Start Channel.
078	UPN MSB	0 ~ 255	0	User programmable number, most significant byte.
079	UPN MSB-1	0 ~ 255	0	User programmable number, most significant byte - 1.
080	UPN MSB-2	0 ~ 255	0	User programmable number, most significant byte - 2.
081	UPN LSB	0 ~ 255	0	User programmable number, least significant byte.
082	CHKSM ERROR	0 / 1	1	Enforces rigid MPI checksum.
083	HANDSHK TIME	0 ~ 5	5	Relaxes MPI timing to be compatible with PC-based Windows-controlled systems.
084	PERMANENT BLK	0 / 1	0	Removes block hours setting for Parental Control and makes block permanent.
087	REAR RGB EN.	0/1/17	1	Dependent on item 093 RJP AVAILABLE setting. Set to 0 to disable RGB input. Set to 1 to enable RGB input. Set to 17 for Auto Configure.
088	EN NOISE MUTE	0 / 1	1	If set to 1, audio is muted if no signal is present.
090	KEY LOCK	0 / 1	0	If set to 1, keyboard is locked out, IR is still functional.
091	YPrPb2 EN	0 / 1	1	Set to 1 to enable HDMI 2 input.
093	RJP AVAILABLE	0, 1, 2, 5, 6	0	Set to 0 to disable. Set to 1, 2, 5, or 6 for HDMI or DVI Mode. (See detailed descriptions.)
094	SAP MENU EN	0 / 1	1	Set to 0 to disable feature on Function Menu. Set to 1 to enable feature on Function Menu.
096	DEF. ASP. RATIO	0 ~ 4	2	Sets default aspect ratio at power up. See detailed descriptions and item 106.
098	PRO:CENTRIC	0 ~ 2	0	Set to 0 to disable Pro:Centric operation. Set to 1 for Flash Mode. Set to 2 for GEM (Java Application) Mode.
099	BACK LIGHTING	1 ~ 100, 101 ~ 200, 255	100	Sets the level of the TV picture back lighting. (See detailed descriptions.)
102	ATSC BAND	0 ~ 4	4	Selects ATSC band.
103	ATSC TUNE MODE	0 / 1	1	Set to 1 (default) for Physical Channel scan. Set to 0 for Virtual Channel scan.
104	START MINOR CH	0 ~ 255	0	Selects Minor Start Channel. Set to 0 for NTSC.
106	ASP RATIO LOCK	0 / 1	0	To retain set aspect ratio on power cycle, set to 1. Set to 0 for default ratio on power cycle.
116	VIDEO MUTE EN	0 / 1	0	Set to 0 for Normal. Set to 1 for Blank.
117	FACT DEFAULT	0 / 1	0	Set to 0 for Normal. Set to 1 to load presets for all Installer Menu settings.
118	POWER SAVINGS	1 / 3	3	Set to 3 (default)—b-LAN module only powered when TV is turned ON), or set to 1 (b-LAN module is always powered). (See detailed descriptions.)
119	DATA CHANNEL	0 ~ 135	0	Set to 0 to disable. Set to the RF channel number of the Data Channel for Pro:Centric or TV E-Z Installation data. (See detailed descriptions.)



**Caution: Installer Menu settings may affect options available from the TV setup menus or the Function Menu.**

# Installer Menu (Cont.)

## Detailed Descriptions of Installer Menu Items

### 000 - INSTALLER SEQUENCE

Specifies entry sequence to the Installer Menu.

0 = 9876	1 = 4321
2 = 1478	3 = 3698

### 001 - POWER MANAGE (Power Management)

Determines hours of no activity before automatic shutoff. The Power Management function is for saving energy. If set to 0, Power Manage is Off. Settings range from 0 ~ 7, with 1 ~ 7 representing the hours that the unit will remain ON, unless there has been activity from either the control panel or remote control.

### 002 - AC ON (AC Power Switchable)

If set to 1, this allows the TV to turn ON when AC power is applied. Pressing the ON button is not necessary. This is desirable if the TV is plugged into a cable box or a power outlet controlled by a wall switch. Use the Left/Right arrow keys to choose 0 or 1, where 0 is the default (OFF), and 1 is ON.

**Note:** If set to 1 (ON), the TV does not respond to ON/OFF commands from either the remote or the display panel, and the SLEEP TIMER is also nonfunctional.

### 003 - BAND/AFC (Band/Automatic Frequency Control)

There are four possible settings for this option:

0 = Broadcast	1 = CATV (default)
2 = HRC	3 = IRC

If some channels were not found by Auto Tuning (Channel Search), select the appropriate Band setting here, and add the channels using the Channel Edit option in the Channel Menu.

### 004 - STRT CHANNEL (Start Channel)

If active, this function allows you to determine the initial Major Start Channel number when the TV is turned ON. This feature is useful for an in-house information channel, since the TV would always select that channel when it is turned ON. Setting this item to 255 causes the last channel viewed when the TV was turned OFF, to be the tuned to channel when the TV is turned ON again.

**Note:** For a digital Start Channel, always remember to set item 104 to the Minor Start Channel number.

255 = Last channel	1 ~ 125 = Major Ch. #	0 = Aux
126 = Map to Channel 3	127 = Map to Channel 4	

### 005 - CHAN LOCK (Channel Lock)

Channel Lock is ideal if the system must always be on the same channel. Changing channels with the Channel Up/Down or keypad numbers is impossible. Channel Lock is inactive if set to 0 (default). Generally, this feature is used in connection with item 004 STRT CHANNEL where the Start Channel may, for example, be set to 3 or 4. If the Start Channel is 3, then the TV will remain locked on channel 3.

**NOTE:** For items 007, 008, and 009

For legacy reasons, the scale used is 0–63. The PTC software will translate this to the 0–100 scale used by the TV.

To translate a TV volume level to the Installer Menu value, use the following formula:

$$\text{Installer Value} = \frac{\text{TV Value} \times 63}{100}$$

Enter only the whole number (disregard fractions).

### 007 - STRT VOLUME (Start Volume)

This function allows the Installer to determine the initial volume level setting when the TV is turned ON. This feature is useful for an in-house information channel, since the TV would always select that volume level when it is turned ON. The range of values are 0 - 63, 255. If 255 is selected, the current volume level will be retained in memory when the TV is turned OFF; at turn ON, the volume level will be automatically set at the previous or last level.

### 008 - MIN VOLUME (Minimum Volume)

This function determines the minimum volume level allowable with the Volume (VOL) Up/Down control. In this way, for example, someone cannot set the volume too low to hear. The value range is from 0 to 63. Use the Left/Right arrow keys to change values. The factory default is 0, which provides the full range of volume control, if item 009 MAX VOLUME is also set to 63. It may be best to set the same value on every TV.

**Note:** The minimum volume level cannot have a value setting higher than the maximum volume level (described below).

### 009 - MAX VOLUME (Maximum Volume)

This function determines the maximum volume level allowable with the Volume (VOL) Up/Down control. In this way, for example, someone cannot set the volume level high enough to disturb others. The value range is 0 to 63, with 63 as the default, which gives the user the full range of volume control, if item 008 MIN VOLUME is also set at 0. Use the Left/Right arrow keys to change values. It may be best to set the same value on every TV.

**Note:** The maximum volume level cannot have a value setting lower than the minimum volume level (described above).

### 010 - MUTE DISABLE

Enables or disables sound mute function. If set to 1, sound cannot be muted. If set to 0, sound can be muted.

### 011 - KEY DEFEAT (Keyboard Defeat)

If set to 1, KEY DEFEAT prevents the end user from accessing the on-screen menu(s) from the display panel—MENU, ENTER, and menu navigation keys do not function. If set to 0, those keys do function.

**Note:** Users can always access the menu(s) by pressing MENU on the remote.

## 015 - SLEEP TIMER

If set to 1, the Sleep Timer feature may be used. If set to 0, the Sleep Timer is not available.

## 016 - EN TIMER (Enable On/Off Timers)

If set to 1, the Timer function is available to the end user and enabled continuously. Set to 0 to disable On/Off timers.

**Note:** Clock must be set in order for timers to be used.

## 017 - ALARM

Gives the installer the option of making the Alarm function available to the end user. If set to 1, the Alarm function is available to the end user. Set to 0 to disable the Alarm function.

**Note:** Clock must be set before the Alarm function will work.

## 020 - FEATURE LEVEL

Determines an additional IR code scheme to which the TV will respond, allowing for the use of unique IR codes based on "bed number" in a multi-TV single room installation. First determine the IR mode; then select the bed number.

IR Mode	Bed #	Values
Legacy (Hospital)	1–2	0–1
Multi-code Remote	1–9	16–24

**Note:** For further information, see documentation for the accessory package that includes the multi-code remote.

## 021 - V-CHIP (Parental Control)

Set to 1 to activate V-Chip (Parental Control) and have it available to the end user to filter and control or otherwise restrict programming content that can appear. Set to 0 to turn the V-Chip feature Off (not available to user); no programming restrictions can be set.

## 022 - MAX BLK HRS (Maximum Block Hours)

Sets hours from 0 to 99 for the maximum V-Chip (Parental Control) block hours. Default setting is for 12 blocking hours.

## 023 - CAPTION LOCK

If set to 0, captions are OFF when the TV is turned ON. Set to 1 to use the caption setting configured before the TV was turned OFF when the TV is turned ON.

## 028 - CH. OVERRIDE (Channel Override)

If set to 1, the user can select channels with either Channel Up/Down or by direct keypad entry. If set to 0, only those channels that are active in the TV's memory can be selected.

## 029 - OLD OCV (On Command Video™)

Set to 1 for operation with systems from On Command Corporation.

## 030 - ACK MASK

MPI Communication Parameter. When set to 1, enables ACK feature of MPI.

## 031 - POLL RATE

MPI Communication Parameter. Selects poll rate for MPI. Step size of 16 ms. Changing from default may affect communication via MPI.

## 032 - TIMING PULSE

MPI Communication Parameter. Sets baud rate for MPI. Step size of 4.3 uS. Changing from default may affect communication via MPI.

## 034 - CAMPORT EN. (Camera Port Enable)

Set to 1 to enable Video 2 input on display panel. If set to 0, Video 2 input on display panel is not functional.

## 035 - COMPPORT EN. (Computer Port Enable)

Enable/disable TV display panel HDMI 1 input jack. Set to 0 to disable HDMI1. Set to 1 to enable HDMI1.

**Note:** This setting is ignored if item 093 RJP AVAILABLE is set to 1.

## 038 - YPrPb EN. (Rear Component Video Enable)

Set to 1 to enable display panel rear Component Video input jacks. Set to 0 to disable display panel rear Component Video input jacks.

## 039 - REAR AUX EN. (Rear Aux Enable)

Set to 1 to enable display panel rear Aux (Video 1) input. Set to 0 to disable display panel rear Aux (Video 1) input.

## 040 - AUTO CAMPORT

Set to 1 to automatically switch to Camport when equipment is connected to side Video input. Set to 0 to disable side Video automatic source selection. If set to 1, STRT AUX SRCE cannot be set to 2.

**Note:** If set to 1, item 093 RJP AVAILABLE is automatically set to 0.

## 046 - STRT AUX SRCE (Start Aux Source)

Sets the starting Aux source. When turned ON, the TV will tune to starting Aux source if item 004 STRT CHANNEL is set to 0.

If item 093 RJP AVAILABLE is set to 0 and item 040 AUTO CAMPORT is set to 0:

1 = Video 1	4 = RGB	255 = Last Aux
2 = Video 2	5 = HDMI 2	
3 = HDMI 1	6 = Component	

If item 093 RJP AVAILABLE is set to 1:

2 = Video 2	5 = HDMI 2	6 = Component
-------------	------------	---------------

If item 040 AUTO CAMPORT is set to 1:

1 = Video 1	4 = RGB	6 = Component
3 = HDMI 1	5 = HDMI 2	

## 047 - AUX STATUS

Set to 1 for MPI Aux source to be reported as a channel number instead of channel 0. Set to 0 to disable Aux identification change. Controls MPI status channel response for Aux inputs.



# Installer Menu (Cont.)

---

## **053 - DIS. CH-TIME (Disable Channel-Time)**

Set to 1 to disable the Channel-Time display; Channel-Time display will not appear. Set to 0 to enable the Channel-Time display.

## **069 - EN. CH-T COL. (Enable Channel-Time Custom Color)**

Set to 1 to enable custom color for the Channel-Time display. Set to 0 to disable custom color for the Channel-Time display.

## **070 - FOR. CH-TIME (Channel-Time Display Foreground Color)**

Set according to Color Chart:

0 = Black	3 = Cyan	6 = Yellow
1 = Blue	4 = Red	7 = White
2 = Green	5 = Violet	

**Note:** If foreground color and background color are the same, the menu background will be transparent.

**Note:** Applies only to "Channel Not Available" message if item 073 CH NOT AVBLE is set to 1 (enabled).

## **071 - BCK. CH-TIME (Channel-Time Display Background Color)**

See description for item 070 FOR. CH-TIME above. The color chart is the same for both items.

## **073 - CH NOT AVBLE (Channel Not Available)**

If set to 1 and item 028 CH. OVERRIDE is set to 0, a "NOT AVAILABLE" message is displayed when a user direct tunes a channel that is not in the channel scan list available in memory.

## **075 - REVERT CH (Revert to Start Channel)**

If set to 1 and loss of MPI communication occurs, TV automatically tunes to the specified Start Channel.

## **078 - UPN MSB (UPN Most Significant Byte)**

User programmable number, most significant byte readable by MPI command. Note: Not linked to serial number.

## **079 - UPN MSB-1 (UPN Most Significant Byte-1)**

User programmable number, most significant byte-1 readable by MPI command. Note: Not linked to serial number.

## **080 - UPN MSB-2 (UPN Most Significant Byte-2)**

User programmable number, most significant byte-2 readable by MPI command. Note: Not linked to serial number.

## **081 - UPN LSB (UPN Least Significant Byte)**

User programmable number, least significant byte readable by MPI command. Note: Not linked to serial number.

## **082 - CHKSM ERROR (Checksum Error)**

Enforces rigid MPI checksum validation. Set to 1 for validation. Set to 0 to disable (does not check checksum on MPI async port). SPI is always checked.

## **083 - HANDSHK TIME (Handshake Time)**

Adds an additional delay to the handshake time which is 64 msec, thus relaxing MPI timing requirements to be compatible with PC-based Windows controlled systems. Range is 0 - 5. (Timeout = 25.5MS + [25.5 MS\* Handshake time].)

## **084 - PERMANENT BLK (Permanent Block)**

Allows Lock (Parental Control) blocking schemes to be permanent by disabling the blocking hours function. Set to 1 to install Parental Control restrictions permanently. Set to 0 for user-specified hours control of blocking schemes.

## **087 - REAR RGB EN. (Rear RGB Enable)**

Controls access to rear RGB input on TV. Set to 0 to disable RGB input. Set to 1 to enable RGB input. Set to 17 to initiate a one-time automatic configuration after an AC power cycle; otherwise, automatic adjustment will be performed each time the RGB input is accessed.

## **088 - EN NOISE MUTE (Enable Noise Mute)**

If set to 1, audio mutes if no signal is present.

## **090 - KEY LOCK**

If set to 1, display panel Channel, Volume, and Caption buttons are disabled, Power button remains enabled. If set to 0, Channel, Volume, Caption, and Power buttons are all enabled.

## **091 - YPrPb2 EN. (HDMI2 Enable)**

Set to 1 to enable display panel HDMI 2 input. Set to 0 to disable display panel HDMI 2 input.

## **093 - RJP AVAILABLE (Remote Jack Pack Available)**

- 0 = Remote jack pack is not available or disabled.
- 1 = Legacy Model RJP: HDMI Mode  
Enables RJP feature for use with full cable bundle models. In this mode, when an HDMI source is connected to the RJP, both digital video and audio are expected via the HDMI cable. If no digital audio is present, no audio will be heard.
- 2 = Legacy Model RJP: DVI Mode  
Enables RJP feature for use with full cable bundle models. In this mode, when an HDMI/DVI source is connected to the RJP, only digital video is expected via the HDMI cable. Analog audio is provided via a separate cable, from the source, connected to an RJP AUDIO IN. If no analog audio cable is connected, tuner audio will be heard.
- 5 = Scaler Model RJP: HDMI Mode  
Enables RJP feature for use with reduced cable bundle models. In this mode, when an HDMI source is connected to the RJP, both digital video and audio are expected via the HDMI cable. If no digital audio is present, no audio will be heard.



- **6 = Scaler Model RJP: DVI Mode**  
Enables RJP feature for use with reduced cable bundle models. In this mode, when an HDMI/DVI source is connected to the RJP, only digital video is expected via the HDMI cable. Analog audio is provided via separate cable, from the source, connected to an RJP AUDIO IN. If no analog audio cable is connected, tuner audio will be heard.

#### Notes:

See Reference section, "RJP Model List and Input Auto-sensing Hierarchy." If RJP AVAILABLE is set to 1, 2, 5, or 6, item 040 AUTO CAMPORT is automatically set to 0. Settings 1, 2, 5, and 6 allow the lodge staff to customize each TV's RJP setup based on customer requirements.

#### 094 - SAP MENU EN (2nd Audio Program)

Set to 1 to enable SAP feature on Function Menu, if Function Menu is available (i.e., TV is not in Pass-through Mode). Set to 0 to disable SAP feature on Function Menu, if Function Menu is available.

#### 096 - DEF. ASP. RATIO (Default Aspect Ratio)

Selects default aspect ratio at power up.

- Set to 0 for Set By System.
- Set to 1 for 4:3.
- Set to 2 for 16:9 (Factory Default).
- Set to 3 for Just Scan.
- Set to 4 for Zoom.

**Note:** Only applies if item 106 ASP RATIO LOCK is disabled, i.e., set to 0.

#### 098 - PRO:CENTRIC

Selects the Pro:Centric Application Mode. Set to 0 (default) to disable Pro:Centric operation. Set to 1 for Flash Mode. Set to 2 for GEM (Java Application) Mode.

#### 099 - BACK LIGHTING

Sets the TV screen brightness at power up. Default setting is 100.

- 1 - 100 Static Back Lighting  
(1 = Dimmest picture, 100 = Brightest picture)
- 101 - 200 Dynamic Back Lighting  
(101 = Dimmest picture, 200 = Brightest picture)

If set between 101 and 200, the TV automatically controls back lighting depending upon the picture level of the current program. If set to 255, back lighting is controlled via the Picture settings in the TV's setup menus.

#### 102 - ATSC BAND

Sets up TV to receive different types of incoming signals:  
0 = Broadcast, 1 = CATV, 2 = HRC, 3 = IRC, 4 = Same as NTSC.

#### 103 - ATSC TUNE MODE

Sets ATSC tuning mode. Default set to 1 for Physical Channel scan. Set to 0 for Virtual Channel scan.

#### 104 - START MINOR CHANNEL

Sets Minor Start Channel number at power up. 0 = NTSC. If not 0, number selected is the digital channel's Minor Start Channel number.

#### 106 - ASP RATIO LOCK (Aspect Ratio Lock)

Set to 1 to retain previous aspect ratio with power off. Set to 0 to retain default aspect ratio with power off. See item 096 DEF. ASP. RATIO above.

#### 116 - VIDEO MUTE EN (Video Mute Enable)

Set to 0 for Normal. Set to 1 for Blank.

#### 117 - FACT DEFAULT (Factory Default)

Set to 0 for normal. Set to 1 to load presets of all Installer Menu item settings.



**Caution: If set to 1, this will reload the factory defaults and clear the channel lineup, including any assigned channel icons and custom text labels.**

**Note:** See also Reference section, "Resetting Factory Defaults on the TV(s)," for further information.

#### 118 - POWER SAVINGS

Default set to 3—the power circuitry for both the embedded *b*-LAN module and the GAME CONTROL/MPI port is only powered when the TV is turned ON. When the TV is in Standby Mode, the MPI card slot is powered by the Standby power supply and both the embedded *b*-LAN and the GAME CONTROL/MPI port are not powered. When the TV is in Power On Mode, the MPI card slot is powered by the main 12V power supply and both the embedded *b*-LAN and GAME CONTROL/MPI port are powered.

Note that the TV must be turned ON in order to communicate with the embedded *b*-LAN module for configuration and control when POWER SAVINGS is set to 3. If set to 1, the *b*-LAN module is always powered.

Similarly, if MPI communication is required for external MPI control, POWER SAVINGS should be set to 1 so that the GAME CONTROL/MPI port circuitry is always powered.

**Note:** MPI cards with *b*-LAN technology—LMT7Z5, LMT7Z7, LMT7Z9—are NOT supported in TVs in which *b*-LAN technology is already integrated.

**Note:** See Reference section, "*b*-LAN Setup & Overview," for further information.

#### 119 - DATA CHANNEL

Set to 0 (default) to disable. Set to the RF channel number of the data channel for Pro:Centric or TV E-Z Installation (splash screen, configuration, or firmware) data.

**Note:** Pro:Centric updates are downloaded from the Pro:Centric server to the TV when the TV is turned OFF. Also, while Pro:Centric updates are in progress, it is not possible to turn the TV ON. The TV may take several minutes to load EPG data after the initial download of the Pro:Centric application. Subsequent updates generally will take less than one minute.

## Channel Icons / Custom Text Labels (2-5-4 + MENU Mode)

### Changing Channel Icons and/or Adding or Editing Custom Text Labels in the Channel-Time Display

If there is no pre-assigned icon for a channel, you can add a custom text label of up to seven (7) characters to help identify the channel or network. Also, if desired, a custom text label can be added to the Channel-Time display in addition to a pre-assigned icon. You may also add text labels for the Aux input sources to clearly identify the devices that are connected to the Aux inputs.

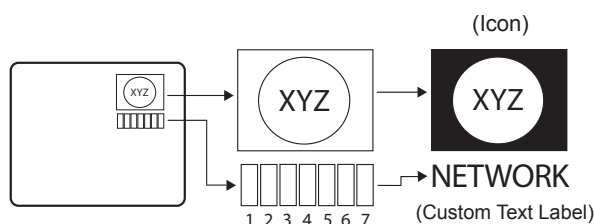

Changing icons and/or adding or editing custom text labels can only be done if there are channels that have been transferred to the TV's PTC either during Master TV Setup (see pages 11 to 14) or by cloning.

**Note:** A blank letter space is available between "Z" and "!".

#### To perform channel editing/labeling:

1. Enter the Installer Menu: Press **MENU** repeatedly until the on-screen display of the TV setup menus no longer toggles, and then press **9-8-7-6 + ENTER**.
2. Press **2-5-4 + MENU** on the Installer Remote to enter the Channel Label Editing Menu.
3. Change channel icons and/or add or edit custom text labels as described in the procedures below. (You can do this more than once.)
4. To exit the menu when you are done, press **MENU**.

### Changing a Channel's Icon on the Master TV

1. Use Channel Up/Down to select the desired channel.
2. Use the Left/Right arrow keys to select the thin letter "I" on the Channel-Time display.
3. Use the Up/Down arrow keys to select the icon with which you want to identify the channel. (If you know the icon number, enter the number, and press **ENTER**.)
4. Proceed to add/edit custom text labels, or go to the next channel.

### Adding/Editing Channel Labels on the Master TV

1. Use Channel Up/Down to select the desired channel.
2. Press the Left or Right arrow repeatedly until the numbers 1 to 7 appear on the display. The number shows the position of the character that can be changed. Number 1 is the first character, number 2 the second character, etc.
3. Use the Up/Down arrow keys to select the desired character.
4. Proceed to the next number position, or go to the next channel.

### Adding/Editing Source Labels on the Master TV

1. Press **INPUT** to select the desired Aux input source: AV1, AV2, RGB, Component, HDMI, or HDMI2.
2. Press the Left or Right arrow repeatedly until the numbers 0 to 9 appear on the display. The number shows the position of the character that can be changed.
3. Use the Up/Down arrow keys to select the desired character.
4. Press **INPUT** for the next Aux input, or use Channel Up/Down to return to channels.

### Installer Remote Control Key Functions for Master TV Channel Label Editing Menu

- **Channel Up/Down:** Tunes to the next channel in scan.
- **Left/Right Arrows:** Select the item to change. If "I" is shown, the icon can be changed. If a number is shown, it indicates the position of the character that can be changed.
- **Up/Down Arrows:** Select the icon or the character to be displayed. Tip: Arrows can be held down for fast scrolling.
- **0 – 9:** Use to enter the index number of the icon, if known.
- **ENTER:** Changes the icon after the icon number has been entered.
- **INPUT:** Changes the Aux input label.
- **MENU:** Exits the editing process.

## IMPORTANT CLONING INFORMATION

There are three different procedures for cloning a Master TV Setup, each with its own advantages and limitations (see also “Cloning Methods” on page 11):

- Using a USB memory device
- Using a TLL-1100A clone programmer
- Using a LT2002 clone programmer

Each cloning method is described in further detail on the pages that follow. As you perform cloning procedures, be sure to complete each task as indicated. If a procedure or step is omitted or not performed completely, cloning may not work. At each step, pay attention to ensure the TV screen shows the proper message when cloning. If the message indicated does not appear, there is a problem with that step, and cloning may not be successful.



**Caution: Copying a blank or incorrect memory into a TV from a clone programmer will cause the TV to operate erratically or become inoperable.**



**Caution: Do not connect a clone programmer to a PPV card installed in the Master or Target TVs. Also, if the TV is in LodgeNet PPV Mode (check with the site administrator if you are not certain), do not connect a clone programmer to the GAME CONTROL/MPI port. Either of these actions will damage the clone programmer and, if applicable, the PPV card.**

### Before you begin cloning:

- Complete the Master TV Setup procedure (see pages 11 to 14).
- All equipment should be connected to power and turned ON.
- Both the Master and Target TVs must be in Pass-through Mode.
- Learning and Teaching is only possible between identical model TVs.
- If using a USB memory device, ensure the USB device has been formatted with FAT format.
- For both Master and Target TVs—If using a clone programmer, ensure the TV is tuned to either an Aux input or an analog (not a digital) channel.
- LT2002 only—Make sure the batteries in the clone programmer are fresh. If batteries are removed, the clone programmer clock time (if set) will be lost (see page 29 for information on the clone programmer clock).



**Caution: Do not unplug the TV power cord or remove/disconnect the USB memory device/clone programmer while Learning or Teaching, as doing so may cause the TV to malfunction or harm the USB device/clone programmer, respectively.**

# USB Cloning Procedure

## Learning / Teaching a Master TV Setup using a USB Memory Device

---

### USB Cloning Notes

- Read the IMPORTANT CLONING INFORMATION on page 23 before beginning any cloning procedures.
- You may edit a filename as part of the Learning procedure; however, a file with edited contents will not be recognized.
- It is not possible to clone a Master TV's clock using a USB memory device. Either set a Target TV's clock manually, or use the Auto Clock setting in the TV setup menus.

### Learn Setup from Master TV

1. Ensure the Master TV is set up completely and in Pass-through Mode.
2. Plug the USB memory device into the USB IN port on the Master TV.
3. Press **MENU** on the Installer Remote to display the TV setup menus. Use the arrow navigation keys to select/highlight the **Option** menu icon, and then press the number "7" key a total of seven times to display the USB Download Menu.
4. To gain access to the "Learn From TV" option in the USB Download Menu, key in the password used to enter the Installer Menu (Example: Press **9-8-7-6**).
5. Use the Up/Down arrow keys to select **Learn From TV (TLL)**, and then press **ENTER**.
6. To differentiate this .tll file from others, you can use the Up/Down arrow keys to change the last five digits of the filename. Press **ENTER** when you are ready to initiate Learning.  
Learning status will be shown on the progress bar. When the Learning process is complete, the USB Download menu will reappear on screen.
7. When Learning is done, remove the USB memory device from the Master TV.

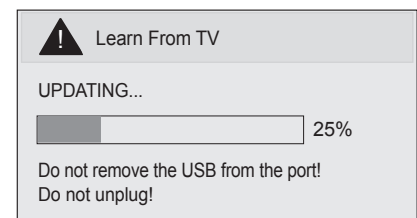
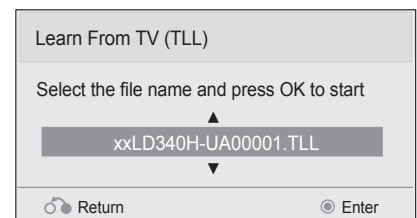
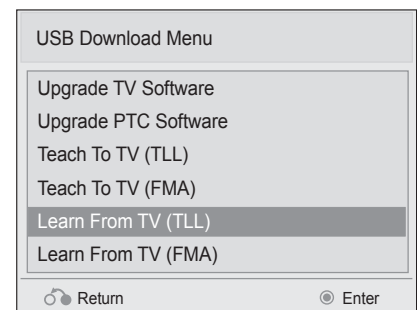

# USB Cloning Procedure (Cont.)

## Learning / Teaching a Master TV Setup using a USB Memory Device (Cont.)

### Teach Master TV Setup to Target TV

1. Ensure the Target TV is in Pass-through Mode, and then use the Installer Remote to enter the Target TV Installer Menu: Press **MENU** repeatedly until the on-screen display of the TV setup menus no longer toggles, and then press **9-8-7-6 + ENTER**.
2. Set Installer Menu item **117 FACT DEFAULT** to **001**, and press **ENTER**. When the value changes back to 0, press **ENTER** again to exit the Installer Menu.
3. Tune/set the TV to an analog or digital channel or Aux input, (ideally the same source tuned for 2-5-5 + MENU Mode during the Master TV Setup procedure).
4. Plug the USB memory device with the .tll file into the Target TV USB IN port.
5. Press **MENU** on the Installer Remote to display the TV setup menus. Use the arrow navigation keys to select/highlight the **Option** menu icon, and then press the number "7" key a total of seven times to display the USB Download Menu.
6. Use the Up/Down arrow keys to select **Teach To TV (TLL)**, and then press **ENTER**.
7. Use the Up/Down arrow keys to select the Master TV Setup you want to install, and then press **ENTER**. Note: Filenames identify the TV and the TLL version (see example at right).  
Teaching status will be shown on the progress bar. When the Teaching process is complete, the USB Download menu will reappear on screen.
8. When Teaching is done, remove the USB memory device from the Target TV, turn OFF the TV, and unplug the TV power cord for 15 seconds.
9. Reconnect the TV power cord, and turn ON the TV. The Master TV Setup should be resident on the Target TV.

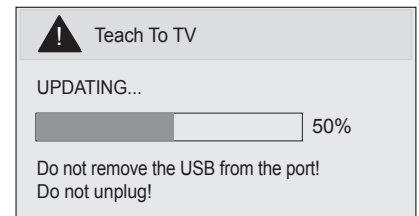
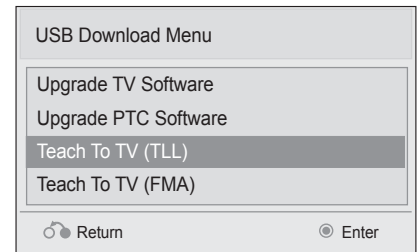

# Clone Programmer Cloning Procedures (Cont.)

## Learning / Teaching a Master TV Setup using a TLL-1100A Clone Programmer



**Caution:** Do not connect a clone programmer to a PPV card installed in the Master or Target TVs. Also, if the TV is in LodgeNet PPV Mode (check with the site administrator if you are not certain), do not connect a clone programmer to the GAME CONTROL/MPI port. Either of these actions will damage the clone programmer and, if applicable, the PPV card.

Cloning is accomplished using the TV/clone programmer MPI ports for communication (see figure).

### TLL-1100A Cloning Notes

- Read the IMPORTANT CLONING INFORMATION on page 23 before beginning any cloning procedures.
- Ensure the TLL-1100A is either fully charged or connected to AC power.
- Learning and Teaching is only possible between identical model TVs; however, the TLL-1100A can store up to eight different Master TV Setups.

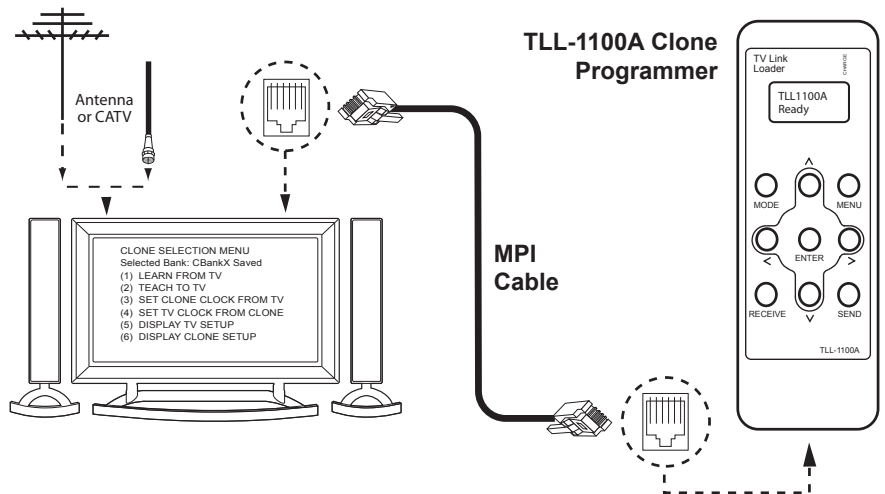

### Learn Setup from Master TV

1. Ensure the Master TV is set up completely and in Pass-through Mode.
2. Tune/set the TV to an analog channel or Aux input, and then, plug one end of the MPI cable into the TV MPI port.
3. Turn ON the TLL-1100A.
4. Use the **MODE** button on the TLL-1100A to select **Clone Mode**.
5. Use the Left/Right arrows on the TLL-1100A to select the Memory CBank (1 to 8) in which to store the Master TV Setup.
6. Plug the other end of the MPI cable into the MPI port on the bottom of the TLL-1100A. The Clone Selection Menu will display on the TV screen.
7. Press **1** on the Installer Remote to select **LEARN FROM TV** from the Clone Selection Menu. Then, press **ENTER** to transfer the Master TV Setup into CBankX on the TLL-1100A.

Learning usually takes about 90 seconds. "LEARNING IN PROGRESS" will be displayed on the screen while the TLL-1100A copies the Master Setup. When the Learning process is complete, a "LEARNING COMPLETE" message will be displayed.

8. When Learning is complete, disconnect the MPI cable from the Master TV.

CLONE SELECTION MENU  
Selected Bank: CBankX Saved  
(1) LEARN FROM TV  
(2) TEACH TO TV  
(3) SET CLONE CLOCK FROM TV  
(4) SET TV CLOCK FROM CLONE  
(5) DISPLAY TV SETUP  
(6) DISPLAY CLONE SETUP

CLONE CLOCK = XX:XX  
TV CLOCK = XX:XX  
THE CLONE IS VERSION VX.X.X  
- To change menu items, press channel keys or digits.  
- To execute item, press Enter.



# Clone Programmer Cloning Procedures (Cont.)

## Learning / Teaching a Master TV Setup using a TLL-1100A Clone Programmer (Cont.)

### (Optional) Set the Clock

Set the time on a Master TV's clock. (If the time has already been copied from a TV into the TLL-1100A clone programmer, you can set the Master TV's clock by copying the time from the clone programmer.) The TLL-1100A can copy the current time to both a Master TV and to the clone's internal clock—accurate to within one minute.

Since the TLL-1100A's time cannot be set directly, the current time needs to be copied from an LG TV equipped with an enabled MPI port.

After the time is copied to the TLL-1100A clone programmer, the current time will be maintained and can then be transferred to another TV. (This can be a Master TV or another TV which has already had the features set up.)

CLONE SELECTION MENU  
Selected Bank: CBankX Saved  
(1) LEARN FROM TV  
(2) TEACH TO TV  
→ (3) SET CLONE CLOCK FROM TV  
→ (4) SET TV CLOCK FROM CLONE  
(5) DISPLAY TV SETUP  
(6) DISPLAY CLONE SETUP

CLONE CLOCK = XX:XX  
TV CLOCK = XX:XX  
THE CLONE IS VERSION VX.X.X  
- To change menu items, press channel keys or digits.  
- To execute item, press Enter.

### Teach Master TV Setup to Target TV

1. Ensure the Target TV is in Pass-through Mode, and then use the Installer Remote to enter the Target TV Installer Menu: Press **MENU** repeatedly until the on-screen display of the TV setup menus no longer toggles, and then press **9-8-7-6 + ENTER**.
2. Set Installer Menu item **117 FACT DEFAULT** to **001**, and press **ENTER**. When the value changes back to 0, press **ENTER** again to exit the Installer Menu.
3. Tune/set the TV to an analog channel or Aux input (ideally the same source tuned for 2-5-5 + MENU Mode during the Master TV Setup procedure), and then connect the MPI cable to the MPI port on the Target TV. The Clone Selection Menu will display on the TV screen.
4. Ensure the correct Memory CBank(X) is selected on the TLL-1100A.
5. Press **2** on the Installer Remote to select **TEACH TO TV** from the Clone Selection Menu. Then, press **ENTER** to transfer the Master TV Setup to the Target TV.  
Teaching usually takes 3 to 4 minutes. "TEACHING IN PROGRESS" will be displayed on the screen during Teaching. When the Teaching process is complete, a "TEACHING COMPLETE" message will be displayed.
6. When Teaching is done, disconnect the MPI cable from the Target TV, turn OFF the TV, and unplug the TV power cord for 15 seconds.
7. Reconnect the TV power cord, and turn ON the TV. The Master TV Setup should be resident on the Target TV.

CLONE SELECTION MENU  
Selected Bank: CBankX Saved  
(1) LEARN FROM TV  
→ (2) TEACH TO TV  
(3) SET CLONE CLOCK FROM TV  
(4) SET TV CLOCK FROM CLONE  
(5) DISPLAY TV SETUP  
(6) DISPLAY CLONE SETUP

CLONE CLOCK = XX:XX  
TV CLOCK = XX:XX  
THE CLONE IS VERSION VX.X.X  
- To change menu items, press channel keys or digits.  
- To execute item, press Enter.

# Clone Programmer Cloning Procedures (Cont.)

## Learning / Teaching a Master TV Setup using an LT2002 Clone Programmer



**Caution:** Do not connect a clone programmer to a PPV card installed in the Master or Target TVs. Also, if the TV is in LodgeNet PPV Mode (check with the site administrator if you are not certain), do not connect a clone programmer to the GAME CONTROL/MPI port. Either of these actions will damage the clone programmer and, if applicable, the PPV card.

Cloning is accomplished using the TV/clone programmer MPI ports for communication (see figure).

### LT2002 Cloning Notes

- Read the IMPORTANT CLONING INFORMATION on page 23 before beginning any cloning procedures.
- A slow flashing green light indicates that there are communication problems between the TV and the LT2002. If this is the case, check for a damaged cable, poor contacts, or other connection troubles.
- If the status indicator is red, the LT2002 batteries are low and should be replaced. Install four (4) high-quality alkaline AA batteries.
- Learning and Teaching is only possible between identical model TVs; however, the LT2002 can store up to three different Master TV Setups.

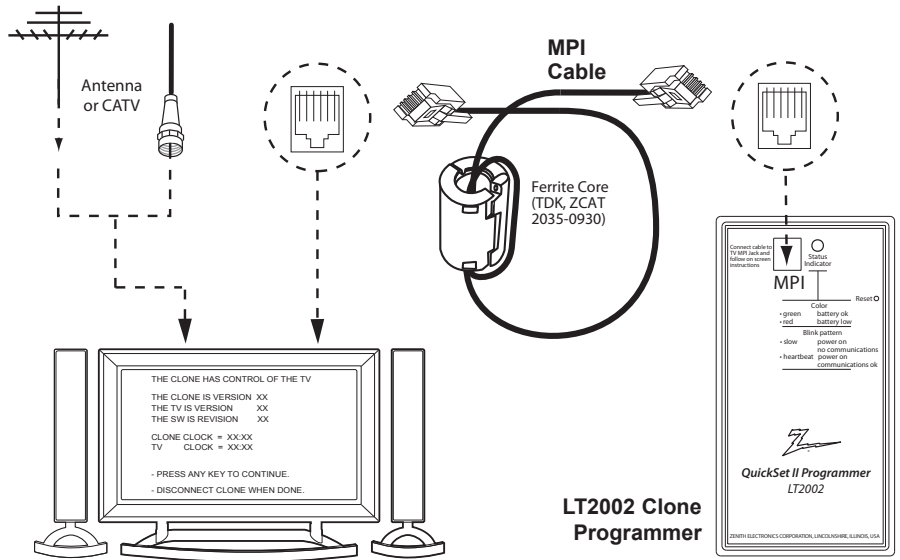

### Learn Setup from Master TV

1. Ensure the Master TV is set up completely and in Pass-through Mode.
2. Tune/set the TV to an analog channel or Aux input, and then plug one end of the MPI cable into the TV MPI port.
3. If there is a good connection after the LT2002 is connected to the TV MPI port, "THE CLONE HAS CONTROL OF THE TV" message will appear on the TV screen. Press any key on the Installer Remote to access the LT2002 Clone Selection Menu.
4. Press **1** on the Installer Remote to select **LEARN FROM TV** from the Clone Selection Menu; then press **ENTER** to proceed to the Memory Bank Selection Menu.
5. Press 1, 2, or 3 on the Installer Remote to select the clone Memory Bank in which to store the Master Setup. Then, press **ENTER**.
 

**Note:** If you choose a Memory Bank that already has a Master device's setup programmed into it, that setup will be overwritten by the new Master TV Setup.
6. Verify the Learning setup information on the next screen, and then press **POWER** to transfer the Master TV Setup into the selected Memory Bank on the LT2002.

CLONE SELECTION MENU

→ (1) LEARN FROM TV  
 (2) TEACH TO TV  
 (3) SET CLONE CLOCK FROM TV  
 (4) SET TV CLOCK FROM CLONE  
 (5) DISPLAY TV SETUP  
 (6) DISPLAY CLONE SETUP

- TO CHANGE MENU ITEMS, PRESS CHANNEL KEYS OR DIGITS.

- TO EXECUTE ITEM, PRESS ON/OFF, POWER, OR ENTER.

SAVE TV SETUP IN SELECTED CLONE MEMORY

→ (1) MEMORY 1 VER XX REV XX  
 (2) MEMORY 2 VER XX REV XX  
 (3) MEMORY 3 VER XX REV XX  
 (4) RETURN TO CLONE MENU

- TO CHANGE MENU ITEMS, PRESS CHANNEL KEYS OR DIGITS.

- TO EXECUTE ITEM, PRESS ON/OFF, POWER, OR ENTER.

(Continued on next page)

# Clone Programmer Cloning Procedures (Cont.)

## Learning / Teaching a Master TV Setup using an LT2002 Clone Programmer (Cont.)

(Continued from previous page)

Learning usually takes about 90 seconds. "LEARNING IN PROGRESS" will be displayed on the screen while the LT2002 copies the Master Setup. When the Learning process is complete, a "LEARNING COMPLETE" message will be displayed.

7. When Learning is complete, disconnect the MPI cable from the Master TV.

### (Optional) Set the Clock

Set the time on a Master TV's clock. (If the time has already been copied from a TV into the LT2002 clone programmer, you can set the Master TV's clock by copying the time from the clone programmer.) The LT2002 can copy the current time to both a Master TV and to the clone's internal clock—accurate to within one minute. (Another reason that the LT2002 should be equipped with fresh, high-quality alkaline batteries, is for it to keep the time as accurately as possible.)

Since the LT2002's time cannot be set directly, the current time needs to be copied from an LG TV equipped with an enabled MPI port.

After the time is copied to the LT2002 clone programmer, the current time will be maintained and can then be transferred to another TV. (This can be a Master TV or another TV which has already had the features set up.)

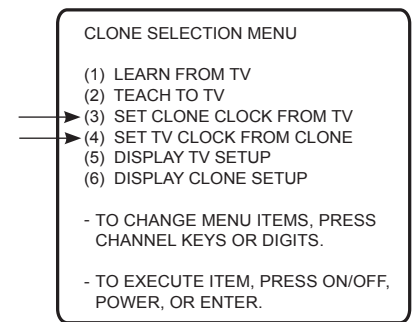

### Teach Master TV Setup to Target TV

1. Ensure the Target TV is in Pass-through Mode, and then use the Installer Remote to enter the Target TV Installer Menu: Press **MENU** repeatedly until the on-screen display of the TV setup menus no longer toggles, and then press **9-8-7-6 + ENTER**.
2. Set Installer Menu item **117 FACT DEFAULT** to **001**, and press **ENTER**. When the value changes back to 0, press **ENTER** again to exit the Installer Menu.
3. Tune/set the TV to an analog channel or Aux input (ideally the same source tuned for 2-5-5 + MENU Mode during the Master TV Setup procedure), and then connect the MPI cable to the MPI port on the Target TV.
4. With "THE CLONE HAS CONTROL OF TV" message on display, press **2** on the Installer Remote to select **TEACH TO TV** from the LT2002 Clone Selection Menu. Then, press **ENTER**.
5. Select the LT2002 Memory Bank in which the new Master TV Setup is located, and press **ENTER**.
6. Verify the Teaching setup information on the next screen, and then press **POWER** to transfer the Master TV Setup to the Target TV.  
Teaching usually takes 3 to 4 minutes. "TEACHING IN PROGRESS" will be displayed on-screen during Teaching. When the Teaching process is complete, a "TEACHING COMPLETE" message will be displayed.
7. When Teaching is done, disconnect the MPI cable from the Target TV, turn OFF the TV, and unplug the TV power cord for 15 seconds.
8. Reconnect the TV power cord, and turn ON the TV. The Master TV Setup should be resident on the Target TV.

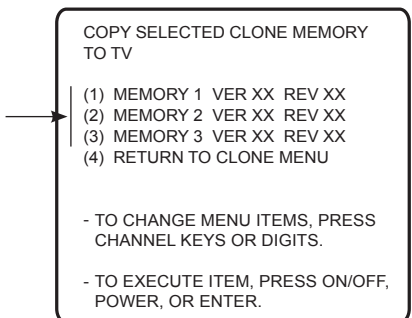
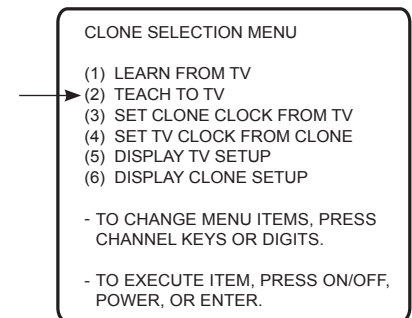

# FTG Mode of Operation Overview

---

## FTG Mode via CPU or EBL

FTG Mode enables Pro:Idiom decryption and also allows logical channel mapping of physical channels.

As indicated in the introduction to this document, there are two separate and distinct methods for configuring LD320H/LD325H and LD340H/LD345H TVs for FTG Mode of operation: one (new) method is to configure the TV CPU for FTG Mode operation, while the other is to configure the TV EBL for FTG Mode operation. FROM A LOCAL CONFIGURATION STANDPOINT, EACH OF THESE METHODS IS MUTUALLY EXCLUSIVE. IF THE CPU IS IN FTG MODE, THE EBL CANNOT BE SWITCHED TO FTG MODE. LIKEWISE, IF THE EBL IS IN FTG MODE, THE CPU CANNOT BE SWITCHED TO FTG MODE.

**Note:** LD320H/LD325H TVs must have the following minimum software loads in order to support FTG Mode via CPU: CPU version 3.61 or later and PTC version 1.01.008 or later. If necessary, contact LG to obtain LD320H/LD325H CPU and PTC software files, and perform the software updates as described in Reference section, “Upgrading TV/PTC Software using a USB Memory Device.” If a Pro:Centric server is installed in the institution head end, you will also have the option to remotely reconfigure LD320H/LD325H TVs that are currently in FTG Mode via EBL for FTG Mode via CPU. Refer to the **Pro:Centric™ Server Admin Client User Guide** for further information.

Both FTG Mode via CPU and FTG Mode via EBL provide the following features:

- Logical channels mapped to either RF delivered content.
- Digital RF channel minor (program) numbers up to 255.
- FTG Channel Map of up to 141 logical channels.
- Start Channel set for RF or Aux input delivered content.
- Pro:Centric data delivery over RF.

In addition, both FTG Mode via CPU and FTG Mode via EBL require LG FTG Device Configuration Application PC software to create an FMA Configuration (.fma) file. However, the configuration processes then diverge as follows:

---

### FTG Mode via CPU

In this mode, the CPU is the owner of the FTG Channel Map and must be configured with an FTG Channel Map and FTG Installer Menu settings using one of the following processes:

- Local: Configure an individual LD320H/LD325H or LD340H/LD345H TV via its USB port using an FMA Configuration (.fma) file on a USB memory device. The “Teach to TV (FMA)” process, along with associated procedures, is described on pages 32 to 35.
- Remote: Configure all LD320H/LD325H or LD340H/LD345H TVs at the site using a Pro:Centric server head end device (Example: PCS150R). Load an FMA Configuration (.fma) file on the Pro:Centric server using the TV E-Z Installation “Configuration” option in the Pro:Centric Server Admin Client. Refer to the **Pro:Centric™ Server Admin Client User Guide** for further information.

### FTG Mode via EBL

In this mode, the EBL is the owner of the FTG Channel Map and must be configured with an FTG Channel Map and FTG Installer Menu settings using one of the following processes:

- Local: Configure an individual LD320H/LD325H or LD340H/LD345H TV’s EBL via its TV-LINK CFG jack using a direct PC-to-TV connection and the FTG Device Configuration Application. The “Write” process for an FTG Channel Map and FTG Installer Menu settings is described on page 36.
- Remote: Configure all LD320H/LD325H or LD340H/LD345H TV EBLs at the site using a Free-To-Guest Management Appliance (FMA) head end device (Example: FMA-LG101). Refer to the **Free-To-Guest (FTG) Configuration Application** manual and/or the Installation & Setup manual for the FMA device for further information.

## FTG Mode of Operation Overview (Cont.)

While the TV is in FTG Mode:

- Users can still access the Installer Menu using an LG Installer Remote; however, all Installer Menu items will be read-only.
- Any FTG configuration changes must be made using the FTG Device Configuration Application. FTG Channel Map Configuration and FTG Installer Menu Configuration Utilities enable you to make changes, respectively, to the FTG Channel Map and FTG Installer Menu settings as necessary. Based on the initial method used to configure the TV for FTG Mode operation (via CPU or EBL), all subsequent changes must be transferred to either the TV or the EBL via a process that is in accordance or compatible with that method (see information on local configuration in this document or refer to documentation for the head end device/server for information on remote management).
- If it becomes necessary to reset the TV to Pass-through Mode, there are several options that will enable you to do so. Refer to Reference section, “Resetting Factory Defaults on the TV(s),” for further information.

Pages 37 to 40 provide overviews of the FTG Channel Map, FTG Installer Menu, and FMA Configuration Utilities that comprise the FTG Device Configuration Application. Refer to the **Free-To-Guest (FTG) Configuration Application** manual for further information on the FTG Device Configuration Application.

### Determining the TV Operating Mode

To determine the operating mode of the TV, press **MENU** on the Installer Remote. The menu display alternates based on the operating mode. See examples below.

If the end user Function Menu appears, typically the TV is in FTG Mode. If the TV setup menus appear, the TV is in Pass-through Mode.

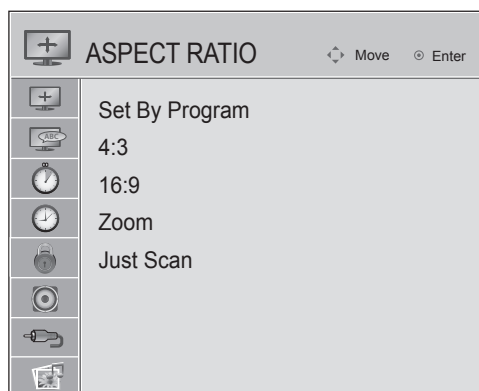

#### Function Menu

Indicates the TV (CPU or EBL) is not in Pass-through Mode. While the TV is in FTG Mode, Installer Menu settings can be accessed as read-only.

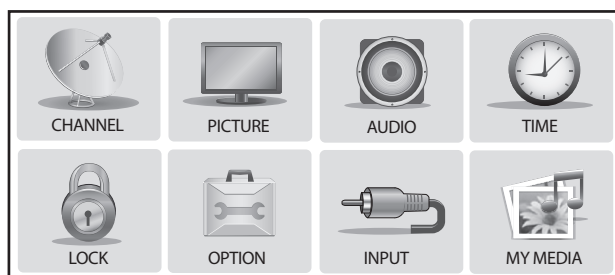

#### TV Setup Menus

Shows that the TV is in Pass-through Mode.

# FTG Mode via CPU

---

## Creating an FMA Configuration File using the FTG Device Configuration Application

This section describes how to create an FMA Configuration (.fma) file that can be saved to a USB memory device. In order to enable Pro:Idiom decryption, it is recommended that you create an FMA Configuration file using the FTG Device Configuration Application. However, if you do not know the RF channels at the site, there is an option to save (Learn) an FMA Configuration file from a TV (see “Learning an FMA Configuration File from a TV” on page 34).

The procedure below provides an overview of the steps required to create an FMA Configuration file. Refer to the **Free-To-Guest (FTG) Configuration Application** manual for further information. See also FTG Device Configuration Application sample screens on pages 37 to 40.

**Note:** FTG Device Configuration Application software is available online at: [www.LGcommercial.com/FTGsoftware](http://www.LGcommercial.com/FTGsoftware).

1. Install (if necessary) and launch the FTG Device Configuration Application (v5.0.0 or higher) on the PC that will be used to create the FMA Configuration file.
2. Either:
  - Open an existing FTG Configuration (.rml) file, if applicable, to use its FTG Channel Map and/or FTG Installer Menu settings. Otherwise, create a new FTG Channel Map using the FTG Channel Map Editor in the FTG Channel Map Configuration Utility. Then, continue with step 3.  
**Note:** Up to 141 logical channels can be defined in the FTG Channel Map.
  - To view and/or base a new FMA Configuration file on an existing LD320H/LD325H or LD340H/LD345H FMA Configuration file, click **Configure** in the FTG Device Configuration Application menu bar, and select **FMA** to access the FMA Configuration Utility. Then, click the **Open** button above the FMA Configuration List, and double-click the desired (.fma) file. A list of the file’s contents will be displayed in the FMA Configuration List window, and you can edit the FMA Configuration List as necessary to create a new file. Proceed to step 4 when you are ready to continue.
3. Click **Configure** in the FTG Device Configuration Application menu bar, and select **FMA** to access the FMA Configuration Utility.
4. To add an FTG Channel Map, click >> under FTG Channel Map to copy the current FTG Channel Map to the FMA Configuration List.  
**Note:** If you make any change(s) in the FTG Channel Map Configuration Utility to the current data to be included in the FMA Configuration List, you will need to recopy the FTG Channel Map to the FMA Configuration List.
5. (Optional) Load default Installer Menu settings for the TV:
  - Click the down arrow at the right of the Chassis field under Installer Menu Templates, and select the appropriate option (depending on the TV type) from the drop-down list of available models.
  - Click the **Load** button.
  - Use the FTG Installer Menu Configuration Utility to modify settings, if necessary. Then, return to the FMA Configuration Utility.
6. To add FTG Installer Menu settings, click >> under FTG Installer Menu Settings to copy the current settings to the FMA Configuration List.  
**Note:** If you make any change(s) in the FTG Installer Menu Configuration Utility to the current data to be included in the FMA Configuration List, you will need to recopy the FTG Installer Menu settings to the FMA Configuration List.

(Continued on next page)



(Continued from previous page)

7. Click the **Save** button above the FMA Configuration List to save its contents to an FMA Configuration (.fma) file on the PC's hard drive for later use (default folder path is C:\Program Files\Zenith\Widget\FMA).
8. Transfer the FMA Configuration file to a USB memory device, and proceed to "Teaching FMA Configuration to a TV" below to transfer the FMA Configuration file to an LD320H/LD325H or LD340H/LD345H TV.

## Teaching FMA Configuration to a TV

This procedure describes how to "Teach" an FMA Configuration file from a USB memory device to a TV. Ensure you have completed the procedure above to create the FMA Configuration file before proceeding with the steps below.

**Note:** If the TV EBL is already in FTG Mode, you cannot use this procedure to make changes to the FTG Channel Map and FTG Installer Menu settings. You must use a direct PC-to-TV connection as described on page 36 or an FMA head end device to reconfigure the EBL.

**Note:** If you wish to switch the TV from FTG Mode via EBL to FTG Mode via CPU, refer to Reference section, "Resetting Factory Defaults on the TV(s)," for further information before proceeding.

1. Plug the USB memory device that contains the FMA Configuration file into the Target LD320H/LD325H or LD340H/LD345H TV USB IN port.
2. Press **MENU** on the Installer Remote to display the TV setup menus (TV is in Pass-through Mode) or the Function Menu (TV is already in FTG Mode).
3. Use the arrow navigation keys to select/highlight either the **Option** menu icon from the TV setup menus or the **Lock** menu icon from the Function Menu. Then, press the number "7" key a total of seven times to display the USB Download Menu.
4. Use the Up/Down arrow keys to select **Teach To TV (FMA)**, and then press **ENTER**.
5. Use the Up/Down arrow keys to select the FMA Configuration file you want to install, and then press **ENTER**.  
The TV will show Teaching completion progress in a new window. Do NOT remove the USB device until Teaching is complete. When Teaching is complete, the TV will tune to the first logical channel in the FTG Channel Map.
6. When Teaching is done, remove the USB memory device. The FMA Configuration should be resident on the Target TV. Also, the Target TV CPU is now in FTG Mode (if it was previously in Pass-through Mode).

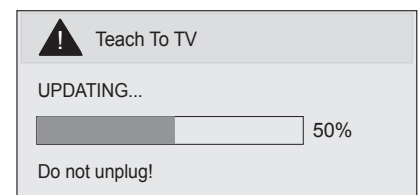
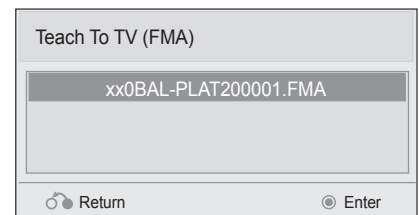
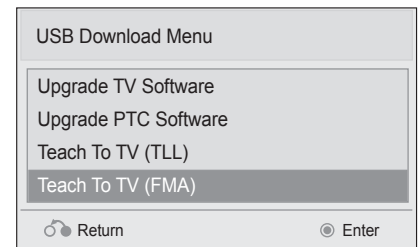

## FTG Mode via CPU (Cont.)

### Learning an FMA Configuration File from a TV

To ensure that Pro:Idiom decryption is enabled, it is recommended that you create an FMA Configuration file using the FTG Device Configuration Application as described on pages 32 to 33. However, if necessary, this option enables you to save (Learn) an FMA Configuration file from an LD320H/LD325H or LD340H/LD345H TV to a USB memory device.

**Note:** If the TV is NOT already in FTG Mode, you may need to perform some manual configuration on the TV before you start this procedure (see “Optional Manual Configuration / TV Setup” on following page).

1. Plug a USB memory device into the USB IN port on the TV.
2. Press **MENU** on the Installer Remote to display the TV setup menus (TV is in Pass-through Mode) or the Function Menu (TV is already in FTG Mode).
3. Use the arrow navigation keys to select/highlight either the **Option** menu icon from the TV setup menus or the **Lock** menu icon from the Function Menu. Then, press the number “7” key a total of seven times to display the USB Download Menu.
4. To gain access to the Learn From TV options in the USB Download Menu, key in the password used to enter the Installer Menu (Example: Press **9-8-7-6**).
5. Use the Up/Down arrow keys to select **Learn From TV (FMA)**, and then press **ENTER**.
6. To differentiate this .fma file from others, you can use the Up/Down arrow keys to change the last five digits of the filename. Press **ENTER** when you are ready to initiate Learning.  
The TV will show Learning completion progress in a new window. Do NOT remove the USB device until Learning is complete. When Learning is complete, the USB Download Menu will reappear on screen.
7. When you are finished, remove the USB memory device.

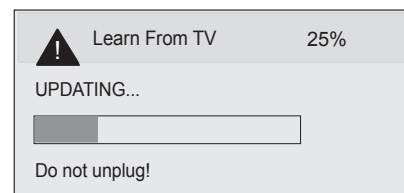
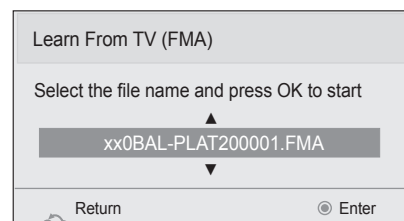
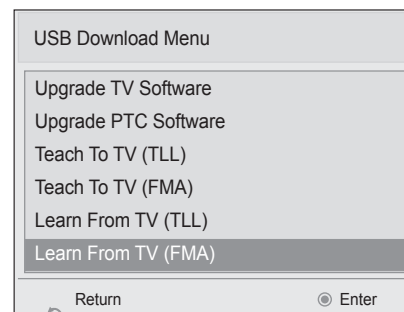

 **Note:** It is highly recommended that you open this FMA Configuration file in the FTG Device Configuration Application—BEFORE transferring (Teaching) the file to any TVs—to verify FTG Channel Map and FTG Installer Menu settings and enable Pro:Idiom decryption by marking Encrypted channels. This will also enable you to confirm and add channel attributes, labels, etc.

## Optional Manual Configuration / TV Setup

The manual configuration procedures below should only be performed if you do not know the RF channels at the site and need to “Learn” an FMA Configuration file from an LD320H/LD325H or LD340H/LD345H TV as described on the previous page. Ensure the TV is in Pass-through Mode before you begin.

### Set Installer Menu Items

These steps provide specific instruction only on the Installer Menu items that should be set on an LD320H/LD325H or LD340H/LD345H TV. Refer to pages 15 to 21 for detailed information on all Installer Menu items.

1. Make sure the TV is ON. Then, use the Installer Remote to enter the Installer Menu: Press **MENU** repeatedly until the on-screen display of the TV setup menus no longer toggles, and then press **9-8-7-6 + ENTER**.
2. Set Installer Menu item **117 FACT DEFAULT** to **001** and press **ENTER** on the Installer Remote.

This clears all Installer Menu custom settings, the channel lineup, etc. and reloads the factory default settings. The value will change back to 0 after the commercial controller (PTC) has been restored to factory default condition. This step ensures that the TV Channel Memory will be the active channel lineup.

3. Set Installer Menu item **003 BAND/AFC**, as appropriate.
  - Broadcast: Set to 000.                      • HRC: Set to 002.
  - CATV: Set to 001 (default).              • IRC: Set to 003.
4. Set any other Installer Menu items that affect your TV programming network to the required configuration. For example, enable/disable Aux inputs, set a Start Channel, etc.
5. After you have adjusted all required Installer Menu item settings, press **ENTER** once on the Installer Remote to save your changes; then, press **ENTER** again to exit the menu.

### Run Auto Tuning (Channel Search)

**Note:** In the FMA Configuration file, Logical Channel numbers will automatically be assigned in ascending order, starting with 0 (zero), to the Physical Channels from the TV Channel Map.

**Note:** Pro:Idiom decryption for encrypted channels will not be enabled unless you use the FTG Device Configuration Application to set channel attributes.

1. Search for all available analog and digital channels: Use the Installer Remote to go to the Channel Menu, select the **Auto Tuning** option, and follow the on-screen instructions.
2. Use the **Channel Edit** option in the Channel Menu to edit the channel lineup, as necessary, to include free to guest channels only. Add/delete channels per your system requirements.

Once you have completed these procedures, return to “Learning an FMA Configuration File from a TV” on the previous page to complete the Learn sequence.

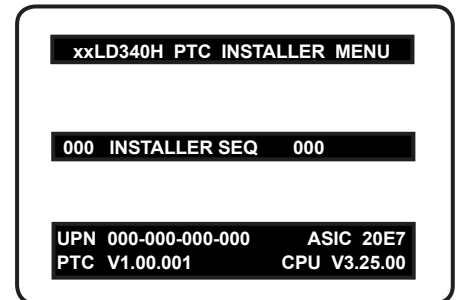

Typical Installer Menu

Note: The Installer Menu header will vary depending on the TV you are setting up.

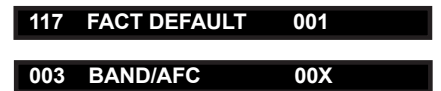

Adjust the settings for these Installer Menu items.

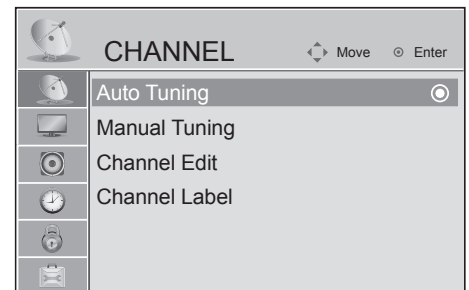

Use Channel Menu options to run Auto Tuning and edit the channel lineup, as necessary.

# FTG Mode via EBL

The following steps outline local FTG configuration of individual TV EBLs using a direct PC-to-TV connection. Refer to the **Free-To-Guest (FTG) Configuration Application** manual for further information. See also FTG Device Configuration Application sample screens on pages 37 to 40.

- Notes:**
- FTG Device Configuration Application software is available online at: [www.LGcommercial.com/FTGsoftware](http://www.LGcommercial.com/FTGsoftware).
  - If the TV CPU is already in FTG Mode, you cannot use this procedure to make changes to the FTG Channel Map and FTG Installer Menu settings. Instead, refer to and use the processes described on pages 32 and 33 to reconfigure the TV CPU.
  - If the preceding condition applies, but you wish to switch the TV to FTG Mode via EBL, refer to Reference section, "Resetting Factory Defaults on the TV(s)," for further information before proceeding.

1. Install (if necessary) and launch the FTG Device Configuration Application (v5.0.0 or higher) on the PC that will be used to configure the EBL.
2. Build an FTG Channel Map using the FTG Channel Map Editor in the FTG Channel Map Configuration Utility (or, if applicable, open an existing FTG Configuration [.rml] file).

**Note:** Up to 141 logical channels can be defined in the FTG Channel Map.

3. Connect the PC to the TV-LINK CFG jack on the TV's rear connections panel using a USB-to-TTL serial cable (TTL-232R-5V-AJ). If necessary, install the device driver on the PC.
4. Turn ON the TV.

**Note:** If Installer Menu item 118 POWER SAVINGS is set to 3 (default), the TV must be ON in order for steps 5 and 6 below to be successful.

5. "Write" the FTG Channel Map to the EBL (switches the EBL from Pass-through Mode to FTG Mode).
6. "Read" the current FTG Installer Menu settings from the EBL using the FTG Installer Menu Configuration Utility. If necessary to make changes to Installer Menu items, "Write" them back to the EBL in FTG Mode.

**Note:** After a "Write" of new data, the TV will briefly display a green text banner that shows the EBL firmware version and release date.

7. Save the FTG Channel Map and FTG Installer Menu settings to an FTG Configuration (.rml) file for future use.
8. Tune the TV to a Logical Channel in the FTG Channel Map.

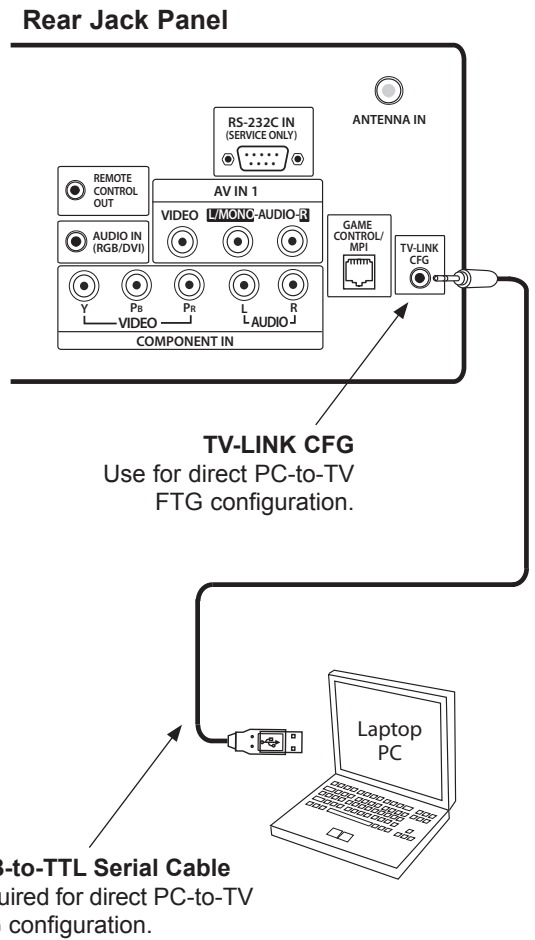

**USB-to-TTL Serial Cable**  
Required for direct PC-to-TV FTG configuration.

- Notes:**
- ANTENNA IN connector located on jack panel on 26LD320H, 26LD340H, and 26LD345H only.
  - Dual-purpose GAME CONTROL/MPI port on 26LD320H and LD340H/LD345H TVs only. On 32/37/42LD320H and 32/37LD325H TVs, the MPI port is located on the same plate as the RF Antenna jack.

# FTG Device Configuration Application Utilities Overview

## FTG Channel Map Configuration Utility

The FTG Channel Map Configuration Utility enables you to build a Channel Map with logical channel numbers.

**Note:** Write, Read, and Learn functions in the FTG Channel Map Configuration Utility are used for direct PC-to-TV FTG configuration of LD320H/LD325H and LD340H/LD345H TVs (FTG Mode via EBL). These functions are not applicable to the process of creating an FMA Configuration file to be saved to a USB memory device (FTG Mode via CPU).

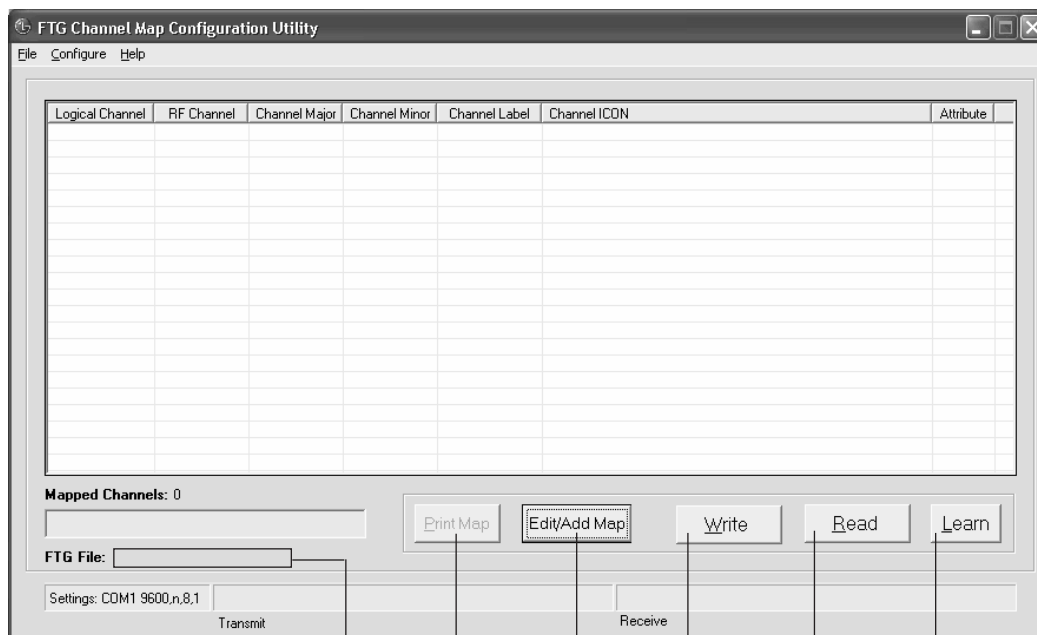

Filename of opened FTG Configuration (.rml) file.

### PRINT MAP

Click to display a printable FTG Channel Map Report. The report can also be exported as an HTML or Text file.

### EDIT/ADD MAP

Click to open the FTG Channel Map Editor to create or edit an FTG Channel Map (see next page).

### LEARN

Click to transfer the TV Channel Map from the PTC to the EBL and the FTG Device Configuration Application. (Requires that 2-5-5 + MENU was performed to transfer TV Channel Map to PTC.)\*

### READ

Click to transfer the FTG Channel Map from the EBL to the FTG Device Configuration Application.

### WRITE

Click to transfer the FTG Channel Map to the EBL. This will switch the EBL from Pass-through Mode to FTG Mode.

\* Logical Channel numbers will automatically be assigned in ascending order, starting with 0 (zero), to the Physical Channels from the TV Channel Map.

# FTG Device Configuration Application Utilities Overview (Cont.)

## FTG Channel Map Editor

The FTG Channel Map Editor shows a single Logical Channel's Data and the FTG Channel Map.

### LOGICAL CHANNEL MAPPING

Select a Logical Channel number, then assign it the RF, Major, and Minor channel numbers to complete the mapping.

### CUSTOM CHANNEL LABELS/ICONS

Enter custom labels and select icons by name on menu or by number.

### SET CHANNEL ATTRIBUTES

Check/select Encrypted, OSD, or Blank Video.

The screenshot shows the 'FTG Channel Map Editor' window. It features several input sections:
 

- Logical Channel:** A list of numbers from 0 to 9.
- RF Channel:** A list of numbers from 1 to 10.
- Channel:** Two sub-lists for 'Major' (1-9) and 'Minor' (0-8).
- Channel Label:** A text field with a '7 Character Limit' and a dropdown menu currently showing 'WBBM-TV'.
- Channel ICON:** A section with 'Enter Number' and 'Description' fields. The 'Description' field contains '14 - CBS'. There is also a 'Select by Name' dropdown.
- Attributes:** Three checkboxes: 'Encrypted' (unchecked), 'OSD' (checked), and 'Blank Video' (unchecked).
- Table:** A table with columns: Logical Channel, RF Channel, Channel Major, Channel Minor, Channel Label, Channel ICON, and Attribute. It lists 17 mapped channels.
- Buttons:** 'Update', 'Add', 'Delete', and 'Exit' buttons are located at the bottom.

Logical Channel	RF Channel	Channel Major	Channel Minor	Channel Label	Channel ICON	Attribute
2	2	2	0	WBBM-TV	14 - CBS	0
5	5	5	0	WMAQ-TV	15 - NBC	0
7	7	7	0	WLS-TV	13 - ABC	0
9	9	9	0	WGN-TV	89 - WGN	0
11	11	11	0	WTTW	17 - PBS	0
14	31	31	3	FOX	16 - FOX	0
15	19	19	3	WGN	89 - WGN	0
16	47	47	4	KIDS	133 - PBS Kids	0
17	27	27	3	THE U	174 - UPN	0
40	65	65	1	HBO-HD	12 - HBO	EO
41	66	66	1	ESPN-HD	2 - ESPN	EO
42	67	67	1	ESPN2HD	21 - ESPN2	EO
43	68	68	1	TNT-HD	4 - TNT	EO
44	69	69	1	HDNET	161 - HDNet	EO
52	74	74	1	STARZHD	33 - Starz	EO
53	75	75	1	HISTHD	58 - History	EO
54	76	76	1	MAX-HD	47 - Cinemax	EO

### UPDATE

After editing an existing Logical Channel's data, click to commit the changes in the FTG Channel Map.

### ADD

After defining a new Logical Channel, click to add channel to the FTG Channel Map.

### DELETE

Click to remove highlighted channel from FTG Channel Map.

### EXIT

Click to exit editor and return to FTG Channel Map Configuration Utility.



# FTG Device Configuration Application Utilities Overview (Cont.)

## FTG Installer Menu Configuration Utility

**Note:** Write, Read, Learn, and IR Remote Access functions in the FTG Installer Menu Configuration Utility are used for direct PC-to-TV FTG configuration of LD320H/LD325H and LD340H/LD345H TVs (FTG Mode via EBL). These functions are not applicable to the process of creating an FMA Configuration file to be saved to a USB memory device (FTG Mode via CPU).

### CONFIGURATION SETTINGS

Select tabs for categories of Installer Menu items to set up TV.

### HOSPITAL-GRADE TV ONLY

Set Hospital items on Installer Menu for hospital-grade TV models.

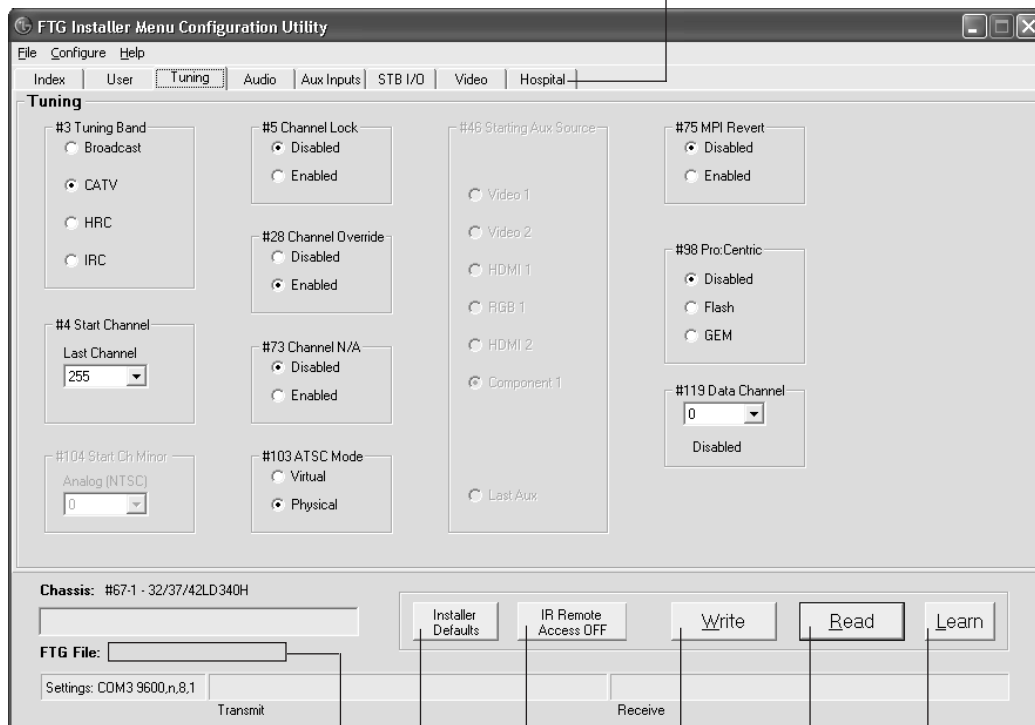

Filename of opened FTG Configuration (.rml) file.

### INSTALLER DEFAULTS

Click to reset FTG Installer Menu items shown in the FTG Device Configuration Application to defaults.

### IR REMOTE ACCESS

Toggle IR Remote Access to ON to obtain access to TV setup menus and Installer Menu.

### WRITE

Click to transfer the FTG Installer Menu settings to the EBL.

### LEARN

Click to transfer Installer Menu settings from the PTC to the EBL and FTG Device Configuration Application. \*

### READ

Click to transfer the Installer Menu settings in the EBL to the FTG Device Configuration Application.

\* Logical Channel numbers will automatically be assigned in ascending order, starting with 0 (zero), to the Physical Channels from the TV Channel Map.

# FTG Device Configuration Application Utilities Overview (Cont.)

## FMA Configuration Utility

**Note:** FMA Write, Read, Clock, Broadcast, Firmware, and IP Communication functions in the FMA Configuration Utility are used to configure *b*-LAN enabled equipment (Example: FMA-LG101) at the hotel/institution head end. These functions are not applicable to the process of creating an FMA Configuration file to be used with LD320H/LD325H and LD340H/LD345H TVs (FTG Mode via CPU).

**FMA CONFIGURATION LIST**  
(data to be saved or already saved in FMA Configuration file)

**NEW/OPEN/SAVE**  
FMA File options

Filename of opened FTG Configuration (.rml) file.

Copy FTG Channel Map to and from FMA Configuration List.

Copy FTG Installer Menu settings to and from FMA Configuration List.

Load default FTG Installer Menu for LD320H/LD325H or LD340H/LD345H.

The screenshot shows the 'FTG Management Appliance (FMA) Configuration Utility' window. It features a menu bar (File, Configure, Help) and several functional panels. The 'FTG File' panel includes a text input field for the filename and 'New', 'Open', and 'Save' buttons. The 'FTG Channel Map' panel has a list of '17 Mapped Channels' and bidirectional arrows. The 'FTG Installer Menu Settings' panel shows a dropdown for '#67-1 - 32/37/42LD340H (Items Default)' and bidirectional arrows. The 'Installer Menu Templates' panel includes a 'Chassis' dropdown and a 'Load' button. The 'FMA Configuration' panel contains 'FMA File' buttons, an 'FMA Configuration List' table with one entry '17 Mapped Channels IM (Items Default) 32/37/42LD340H', and 'Write' and 'Read' buttons. The 'FMA Clock' panel has 'Date & Time' settings with 'Auto' and 'DST' checkboxes. The 'FMA Broadcast' panel has an 'Adjust Rate' dropdown set to '60'. The 'FMA Firmware Version' panel has a 'Get FW' button. The 'FMA IP Communication' panel shows the 'Configuration Utility's IP Address' as '10.20.1.120' and an 'Important' note.



**Note:** The data referenced in the FMA Configuration List is only a snapshot of the current FTG Channel Map and FTG Installer Menu settings when copied to the list. If you make any change(s) to the current data to be included in the FMA Configuration List, you will need to recopy Channel Map and Installer Menu settings to the FMA Configuration List.

# Remote Jack Pack / TV Connections & Setup

## Remote Jack Pack Setup

RJP Available? If you will use a Remote Jack Pack (RJP) in your system, set Installer Menu item **093 RJP AVAILABLE** appropriately (for example, on a legacy model RJP: HDMI Mode, set RJP AVAILABLE to 001). See Installer Menu detailed descriptions for further information.

**093 RJP AVAILABLE 001**

## TV Connections



**Make these connections ONLY after Master TV Setup and TV cloning procedures are complete.**

Refer to the figure below, and connect the RJ-45 Control cable from the RJP cable bundle to the RJP INTERFACE port on the TV's jack panel. Then, connect HDMI, RGB, and Composite Video/Audio connectors, as applicable, for the cable bundle.

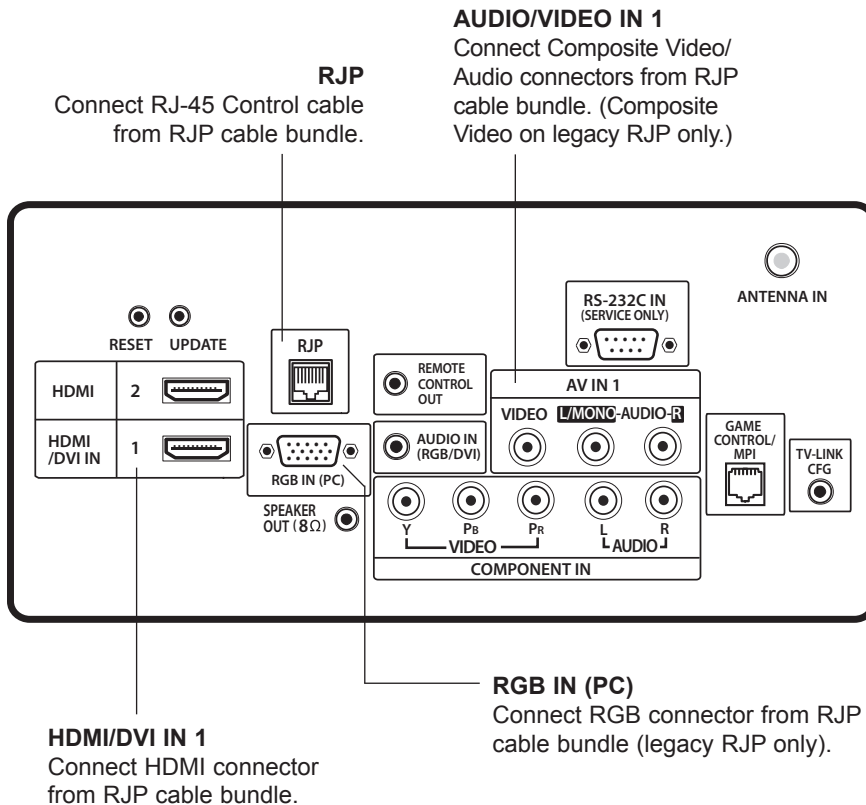

### Notes:

- ANTENNA IN connector located on jack panel on 26LD320H, 26LD340H, and 26LD345H only.
- Dual-purpose GAME CONTROL/MPI port on 26LD320H and LD340H/LD345H TVs only. On 32/37/42LD320H and 32/37LD325H TVs, the MPI port is located on the same plate as the RF Antenna jack.

# Reference: Upgrading TV/PTC Software using a USB Memory Device

## Checking the Software Versions

You can check the software versions of the TV by accessing the Installer Menu with the Installer Remote: Press **MENU** repeatedly until the on-screen menu display no longer toggles, and then press **9-8-7-6 + ENTER**.

When you are finished, press **ENTER** again to exit the Installer Menu.

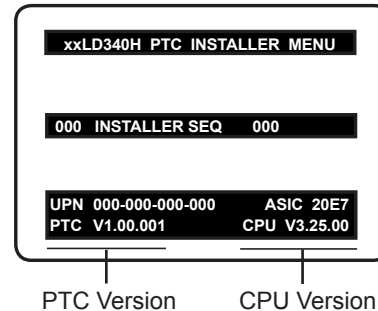

Typical Installer Menu

## Upgrading TV/PTC Software

Before you begin, note that the software upgrade files must be stored in a folder named "LG\_DTV" in the root directory of the USB memory device. Also, ensure the USB device has been formatted with FAT format.

**Note for TV Software Upgrade only:** If the TV detects a later version of software on the USB device, it will automatically display a dialog from which you can start the software upgrade immediately. Otherwise, you can close the dialog, and access the USB Download Menu as described below.

1. Turn the TV ON.
2. Plug the USB memory device into the USB IN port on the TV.
3. Press **MENU** on the Installer Remote to display the TV setup menus (TV is in Pass-through Mode) or the Function Menu (TV is not in Pass-through Mode).
4. Use the arrow navigation keys to select/highlight either the **Option** menu icon from the TV setup menus or the **Lock** menu icon from the Function Menu. Then, press the number "7" key a total of seven times to display the USB Download Menu.
5. Use the Up/Down arrow keys to select **Upgrade TV Software** or **Upgrade PTC Software**, as applicable, and press **ENTER**.
6. Select the appropriate option(s), depending on the type of upgrade:
  - TV Software Upgrade: (See screen samples at right.) Select **TV Software Update** from the first TV Software Update window. In the second TV Software Update window, select/highlight the update file to install and press **ENTER**.  
**Note:** Do not select Forced Update options unless you have been specifically instructed to do so or have previous experience with Expert Software Updates.
  - PTC Software Upgrade: In the PTC Software Update window, select/highlight the update file to install and press **ENTER**.  
**Note:** The PTC Software Update window is similar to the second TV Software Update window, though there are no Forced Update options. Current software version information is shown at the top and update files on the USB device are listed at the bottom of the window.

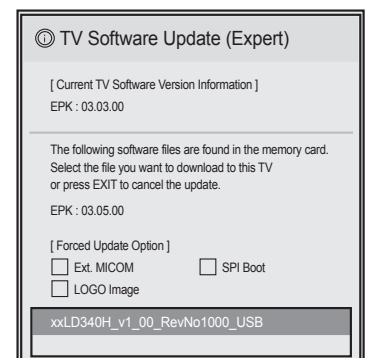
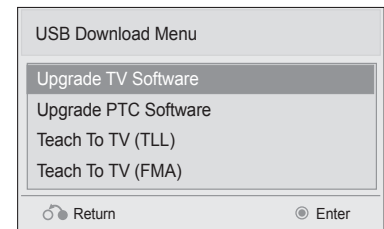

The TV will show update completion progress in a new window. Do NOT remove the USB device until the software upgrade is complete. When a TV software upgrade is complete, the TV will reset itself with an automatic restart. When a PTC upgrade is complete, the TV will turn OFF.

# Reference: Downloading a Splash Screen using a USB Memory Device

## Splash Screen Image File Guidelines

- The splash screen image must be a baseline (not progressive) JPEG.
- The image should be no larger than 1 MB.
- The ideal size for the image is 1366 x 768 pixels or under.
- The image file must be stored in a folder named “LG\_DTV” in the root directory of USB memory device.
- Ensure the USB device has been formatted with FAT format.

## Downloading a Splash Screen Image

1. Turn the TV ON.
2. Plug the USB memory device into the USB IN port on the TV.
3. Press **MENU** on the Installer Remote to display the TV setup menus (TV is in Pass-through Mode) or the Function Menu (TV is not in Pass-through Mode).
4. Use the arrow navigation keys to select/highlight either the **Option** menu icon from the TV setup menus or the **Lock** menu icon from the Function Menu. Then, press the number “7” key a total of seven times to display the USB Download Menu.
5. Use the Up/Down arrow keys to select **Upgrade TV Software**, and then press **ENTER**.
6. Select **LOGO Image Download** from the first TV Software Update window.
7. In the second TV Software Update window, use the Up/Down arrow keys to select the image file to download, and then press **ENTER**.

The TV will show download completion progress in a new window. Do NOT remove the USB device until the image download is complete. When the image download is complete, the TV will reset itself with an automatic restart. Upon the restart, you should see the new splash screen.

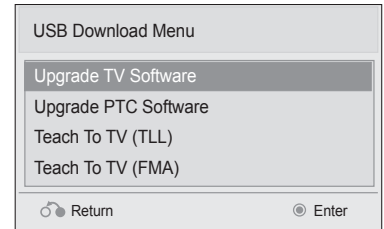

# Reference: Power Consumption Settings

## 26/32/37/42LD320H & 32/37LD325H

The following tables assume that Installer Menu item 118 POWER SAVINGS is set to 003 (default) and Installer Menu item 099 BACK LIGHTING is set as shown below (default value is 100).

Item 099 Back Lighting (Static)	26LD320H		32LD320H / 32LD325H		37LD320H / 37LD325H		42LD320H	
	Power Consumption (Watts)	Percent Savings	Power Consumption (Watts)	Percent Savings	Power Consumption (Watts)	Percent Savings	Power Consumption (Watts)	Percent Savings
100	56.82	0.00%	72.97	0.00%	88.92	0.00%	107.53	0.00%
90	51.98	8.52%	63.82	12.54%	84.19	5.32%	86.68	19.39%
80	47.09	17.13%	58.53	19.78%	77.84	12.46%	78.79	26.73%
70	42.06	25.97%	53.58	26.57%	72.19	18.81%	72.81	32.29%
60	39.71	30.12%	44.24	39.38%	66.28	25.46%	66.78	37.89%
50	37.36	34.25%	41.27	43.45%	60.90	31.51%	60.61	43.63%
40	36.31	36.10%	38.71	46.95%	56.58	36.37%	56.35	47.60%
30	35.12	38.19%	36.20	50.39%	52.35	41.13%	52.90	50.81%
20	32.59	42.64%	33.51	54.07%	47.75	46.30%	47.71	55.63%
10	30.23	46.80%	31.01	57.51%	43.68	50.88%	43.04	59.98%
1	27.95	50.82%	28.55	60.87%	39.62	55.44%	38.86	63.86%

Item 099 Back Lighting (Dynamic)	26LD320H		32LD320H / 32LD325H		37LD320H / 37LD325H		42LD320H	
	Power Consumption (Watts)	Percent Savings	Power Consumption (Watts)	Percent Savings	Power Consumption (Watts)	Percent Savings	Power Consumption (Watts)	Percent Savings
200	72.19	0.00%	75.45	0.00%	110.86	0.00%	125.41	0.00%
190	68.21	5.51%	69.23	8.25%	99.05	10.65%	111.41	11.16%
180	63.72	11.74%	65.26	13.51%	92.33	16.72%	103.30	17.63%
170	59.21	17.99%	60.72	19.53%	85.39	22.98%	95.29	24.02%
160	55.04	23.76%	56.29	25.40%	78.61	29.10%	87.64	30.11%
150	50.81	29.62%	51.82	31.33%	71.70	35.32%	79.71	36.44%
140	46.03	36.24%	46.62	38.21%	63.53	42.69%	70.73	43.60%
130	41.49	42.53%	41.67	44.78%	55.65	49.80%	61.80	50.72%
120	36.32	49.69%	36.14	52.10%	47.34	57.30%	51.86	58.65%
110	31.52	56.34%	31.11	58.76%	39.90	64.01%	42.90	65.79%
101	26.95	62.67%	26.41	65.00%	33.00	70.24%	34.52	72.47%

Note: Values are results of controlled experiments under laboratory conditions.



## Reference: Power Consumption Settings (Cont.)

### 26/32/37/42LD340H & 26/32/37/42LD345H

Item 099 Back Lighting (Static)	26LD340H / 26LD345H		32LD340H / 32LD345H		37LD340H / 37LD345H		42LD340H / 42LD345H	
	Power Consumption (Watts)	Percent Savings	Power Consumption (Watts)	Percent Savings	Power Consumption (Watts)	Percent Savings	Power Consumption (Watts)	Percent Savings
100	56.82	0.00%	72.97	0.00%	88.92	0.00%	107.53	0.00%
90	51.98	8.52%	63.82	12.54%	84.19	5.32%	86.68	19.39%
80	47.09	17.13%	58.53	19.78%	77.84	12.46%	78.79	26.73%
70	42.06	25.97%	53.58	26.57%	72.19	18.81%	72.81	32.29%
60	39.71	30.12%	44.24	39.38%	66.28	25.46%	66.78	37.89%
50	37.36	34.25%	41.27	43.45%	60.90	31.51%	60.61	43.63%
40	36.31	36.10%	38.71	46.95%	56.58	36.37%	56.35	47.60%
30	35.12	38.19%	36.20	50.39%	52.35	41.13%	52.90	50.81%
20	32.59	42.64%	33.51	54.07%	47.75	46.30%	47.71	55.63%
10	30.23	46.80%	31.01	57.51%	43.68	50.88%	43.04	59.98%
1	27.95	50.82%	28.55	60.87%	39.62	55.44%	38.86	63.86%

Item 099 Back Lighting (Dynamic)	26LD340H / 26LD345H		32LD340H / 32LD345H		37LD340H / 37LD345H		42LD340H / 42LD345H	
	Power Consumption (Watts)	Percent Savings	Power Consumption (Watts)	Percent Savings	Power Consumption (Watts)	Percent Savings	Power Consumption (Watts)	Percent Savings
200	72.19	0.00%	75.45	0.00%	110.86	0.00%	125.41	0.00%
190	68.21	5.51%	69.23	8.25%	99.05	10.65%	111.41	11.16%
180	63.72	11.74%	65.26	13.51%	92.33	16.72%	103.30	17.63%
170	59.21	17.99%	60.72	19.53%	85.39	22.98%	95.29	24.02%
160	55.04	23.76%	56.29	25.40%	78.61	29.10%	87.64	30.11%
150	50.81	29.62%	51.82	31.33%	71.70	35.32%	79.71	36.44%
140	46.03	36.24%	46.62	38.21%	63.53	42.69%	70.73	43.60%
130	41.49	42.53%	41.67	44.78%	55.65	49.80%	61.80	50.72%
120	36.32	49.69%	36.14	52.10%	47.34	57.30%	51.86	58.65%
110	31.52	56.34%	31.11	58.76%	39.90	64.01%	42.90	65.79%
101	26.95	62.67%	26.41	65.00%	33.00	70.24%	34.52	72.47%

Note: Values are results of controlled experiments under laboratory conditions.

## Reference: TV Camport Auto Sense Operation

The Camport Auto Sense function is enabled when:

1. Installer Menu item 034 CAMPORT EN is set to 1 AND
2. Installer Menu item 040 AUTO CAMPORT is enabled (1).

**Selectable:** Can be accessed with INPUT key, direct access, etc.

**Auto Sense:** TV switches to this input when connector is inserted. The Camport (Side [AV IN 2] Video) has the highest priority and will override any commands including tuning to the Start Channel.

### CAMPORT (Side Video) Functionality Control

Item 034 CAMPORT EN	Item 040 AUTO CAMPORT	Side (AV IN 2) Video Operation
0	0	Disabled
0	1	Disabled
1	0	Selectable
1	1	Auto Sense

### Camport Operation (Stand-alone)

When Camport Auto Sense is enabled as above, the TV will switch from its current source to the Side (AV IN 2) Video input whenever a plug is inserted into the AV IN 2 Video input.

When the video plug is removed, the TV will switch back to the previous source that was being displayed before the plug was inserted. However, if any direct access to an Aux channel or RF channel is requested while the Camport is active, then, when the video plug is removed, the TV will switch to the last requested channel. Source changes using any Source keys (INPUT) are ignored. Channel Up/Down and Flashback commands are not Direct Access tuning commands, and they are also ignored.

Previous State Before Inserting CAMPORT	Operation While CAMPORT is Active	State Upon Removal of CAMPORT
Aux or RF Channel	None	Previous Aux or RF Channel
Aux or RF Channel	Direct Access	Last Requested Aux or RF Channel
Aux or RF Channel	Ch Up/Down, Flashback, and Input Keys	Previous Aux or RF Channel

### Camport Operation (FTG or PPV)

The operation will be similar to that of the Pass-through Mode. However, when the Channel Map is maintained external to the PTC (i.e., FTG and PPV), Channel Up/Down or Flashback keys are sent as Direct Access tuning commands to the PTC/TV.

Previous State Before Inserting CAMPORT	Operation While CAMPORT is Active	State Upon Removal of CAMPORT
Aux or RF Channel	None	Previous Aux or RF Channel
Aux or RF Channel	Direct Access	Last Requested Aux or RF Channel
Aux or RF Channel	Ch Up/Down, Flashback, and Input Keys	Last Requested Aux or RF Channel

# Reference: TV Aux Input Configuration

DIRECT ACCESS Tuning		TV		ENABLE				MPI DATA			START AUX SOURCE ASSIGNMENT
				Installer Menu		MPI DATA STATUS TYPE 0x41 SOURCES ENABLED (R/W)		DATA STATUS TYPE 0xD2 CURRENT AV SOURCE (R)		DATA STATUS TYPE 0x0D AUX SOURCE (R)	
OLD_OCV = 0	OLD_OCV = 1	Source Input	Source Mode	Number	Labeling	Value	Labeling	Value	Labeling		
130	90	Video2 (Side)	CV	34	CAMPORT_EN	0x01	Video Front (Camport)	0	Video Front (Camport)	0 (VIDEO)	2
131	91	Video1 (Rear)	CV	39	REAR_AUX_EN	0x02	Rear Video (Aux)	1	Rear Video (Aux)	0 (VIDEO)	1
132	92	HDMI2	DTV/PC	91	YPrPb2 EN = 1	0x04	S-Video Rear	2	S-Video Rear	0 (VIDEO)	5
133	93	HDMI1/DVI	DTV/PC	35	COMPPORT_EN = 1	0x08	Front Computer	3	Front Computer	0 (VIDEO)	3
134	94	RGB	PC	87	REAR RGB EN = 2	0x10	SVGA Rear Computer	4	SVGA Rear Computer	2 (COMPUTER)	4
136	96	Component		38	YPrPb EN	0x40	Y/UV Component	6	Rear Y/PrPb Component Video	0 (VIDEO)	6

## Reference: *b*-LAN Setup & Overview

---

The *b*-LAN module is internal to the TV. It allows hotel/institution head end equipment with *b*-LAN technology to communicate, via the institution's RF distribution system, with the TV for configuration and control.

**Note:** MPI cards with *b*-LAN technology—LMT7Z5, LMT7Z7, LMT7Z9—are NOT supported in TVs in which *b*-LAN technology is already integrated.

Installer Menu item 118 POWER SAVINGS controls the power circuitry for both the embedded *b*-LAN module and the GAME CONTROL/MPI port (see note below). The default value is 003—the *b*-LAN module is only powered when the TV is turned ON. See chart below.

**Note:** 26LD320H and all LD340H/LD345H TVs have a dual-purpose GAME CONTROL/MPI port on the TV rear jack panel. On 32/37/42LD320H and 32/37LD325H TVs, the MPI port is located on the same plate as the RF Antenna jack.

POWER SAVINGS	TV Standby State	TV Power On State
	<i>b</i> -LAN & GAME CONTROL/MPI Port Power	<i>b</i> -LAN & GAME CONTROL/MPI Port Power
001	On	On
003 (default)	Off	On

A *b*-LAN enabled head end device, such as an LG FMA-LG101, broadcasts over the RF distribution system to communicate to multiple TVs. When the TV is first installed, it must be turned ON in order for its embedded *b*-LAN module to receive communication from the head end device. At this point, if it is desired for the *b*-LAN module to always be powered, including while the TV is in Standby, set Installer Menu item 118 POWER SAVINGS to 001.

Also, if MPI communication is required for external MPI control, set Installer Menu item 118 POWER SAVINGS to 001 so that the GAME CONTROL/MPI port circuitry is always powered.

# Reference: RJP Model List and Input Auto-sensing Hierarchy

---

## RJP Model List

<b>Legacy Models</b>	<b>Scaler Models</b>
RJP-101M	N/A
RJP-101ML	N/A
RJP-110F	RJP-210F
RJP-110FW	RJP-210FW
RJP-110W	RJP-210W
RJP-110WBR	RJP-210WBR
RJP-110S	RJP-210S
RJP-120G	RJP-220G
RJP-120T	RJP-220T
RJP-201B	RJP-301B
RJP-202B	RJP-302B

## RJP Input Auto-sensing Hierarchy

<b>Priority</b>	<b>Video</b>	<b>Audio</b>
1st (Highest)	Digital Video In	Audio In (3.5mm)
2nd	PC Video In	Audio In (L/R)
3rd	Video In	Digital Video In

# Reference: Resetting Factory Defaults on the TV(s)

---

This section describes how to reset factory defaults either on a single TV that is currently in Pass-through Mode or on multiple TVs that are currently in FTG Mode.

**Note:** If the TV(s) is/are currently in FTG Mode, restoring the factory defaults also resets the TV to Pass-through Mode.

## Installer Menu Item 117 FACT DEFAULT

If the TV is currently in Pass-through Mode, you can set Installer Menu item 117 FACT DEFAULT to 001 to reload the factory defaults and clear the channel lineup, including any assigned channel icons and custom text labels.

## Factory “IN-STOP”

If the TV is currently in FTG Mode, a predefined value for Installer Menu item 117 FACT DEFAULT enables access to initiate a factory “IN-STOP” process that will reset the TV to Pass-through Mode in addition to restoring all factory defaults. Contact technical support for the required value for Installer Menu item 117 and for additional information on performing the IN-STOP from the Installer Menu.

## Additional FTG Mode via CPU Options

There are two additional options for resetting Pass-through Mode/factory defaults on TVs that are in FTG Mode via the CPU. The first enables you to reset a single TV to Pass-through Mode, while the second enables you to reset multiple TVs to Pass-through Mode at one time.

- Using a USB memory device, “Teach” an FMA Configuration file that only contains a “0 Mapped Channels” FTG Channel Map to the TV. Refer to “Creating an FMA Configuration File using the FTG Device Configuration Application” and “Teaching FMA Configuration to a TV” on pages 32 and 33, respectively, for further information.
- If your system uses a Pro:Centric server for remote management/administration, use the Pro:Centric Admin Client to load an FMA Configuration file that only contains a “0 Mapped Channels” FTG Channel Map on the Pro:Centric server. Refer to the *Pro:Centric™ Server Admin Client User Guide* for further information.

## Additional FTG Mode via EBL Options

There are two additional options for resetting Pass-through Mode/factory defaults on TVs that are in FTG Mode via the EBL. The first enables you to reset a single TV to Pass-through Mode, while the second enables you to reset multiple TVs to Pass-through Mode at one time.



**Note:** While the IN-STOP process described above will clear both the PTC and the CPU, both options below only clear the PTC. Thus, the current Channel Map and TV setup menu settings will remain in the CPU after the reset is completed.

- Using a direct PC-to-TV connection, “Write” an unpopulated Channel Map—that is, a Channel Map with zero channels—to the TV. Refer to the “FTG Mode via EBL” procedure on page 36 and/or the *Free-To-Guest (FTG) Configuration Application* manual for further information.
- If your system uses an FMA for remote management/broadcast configuration, configure the FMA device with an FMA Configuration file that only contains a “0 Mapped Channels” FTG Channel Map to broadcast to the TV EBL(s). Refer to the *Free-To-Guest (FTG) Configuration Application* manual and/or the Installation & Setup manual for the FMA device for further information.

# Reference: LD320H/LD325H & LD340H/LD345H Rear Jack Panel

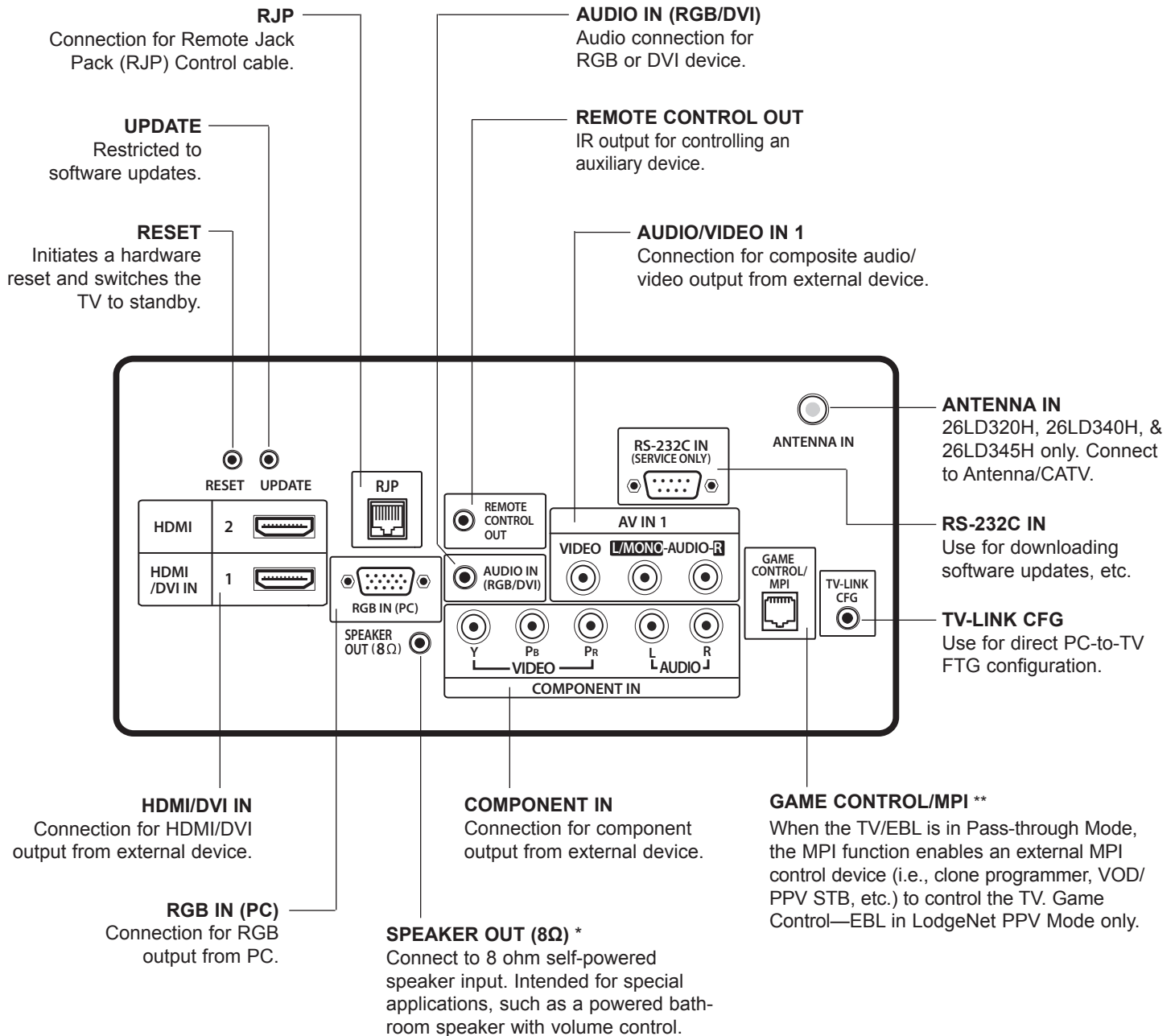

\* This stereo jack provides a mono speaker fixed-level, 1 watt output (audio +, audio -, w/ground shield). Do NOT plug in a mono connector, as this may damage the TV.

\*\* On 32/37/42LD320H and 32/37LD325H TVs, this is a GAME CONTROL port only. GAME CONTROL function as described above. On these TVs, the MPI port is located on the same plate as the RF Antenna jack (see next page).



# Reference: Side Connections Panel / RF Antenna & MPI Connections

## Side Connections Panel

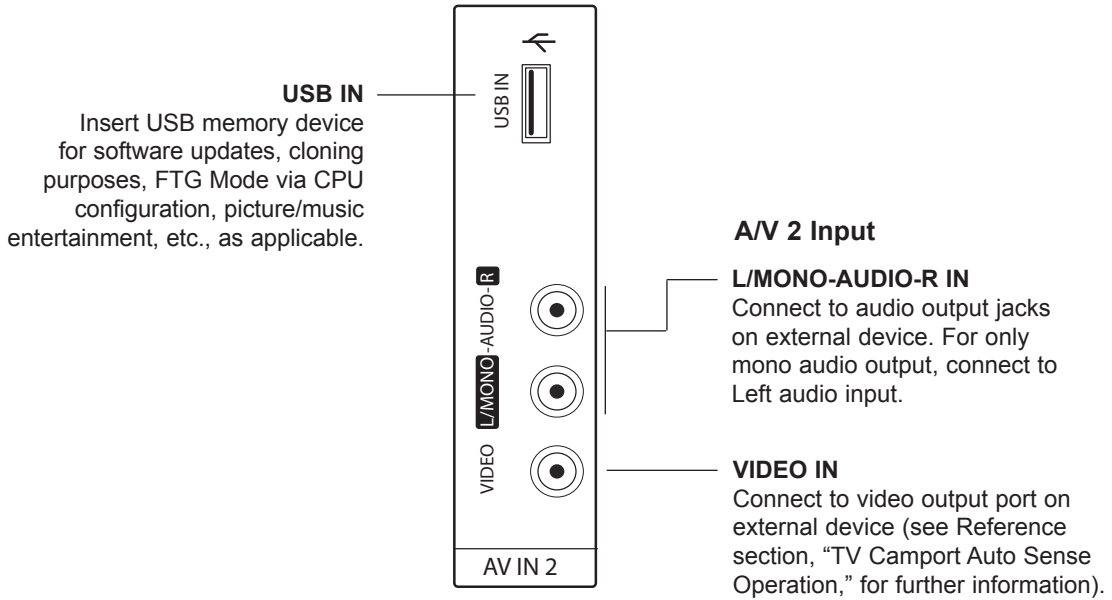

## RF Antenna & MPI Connections

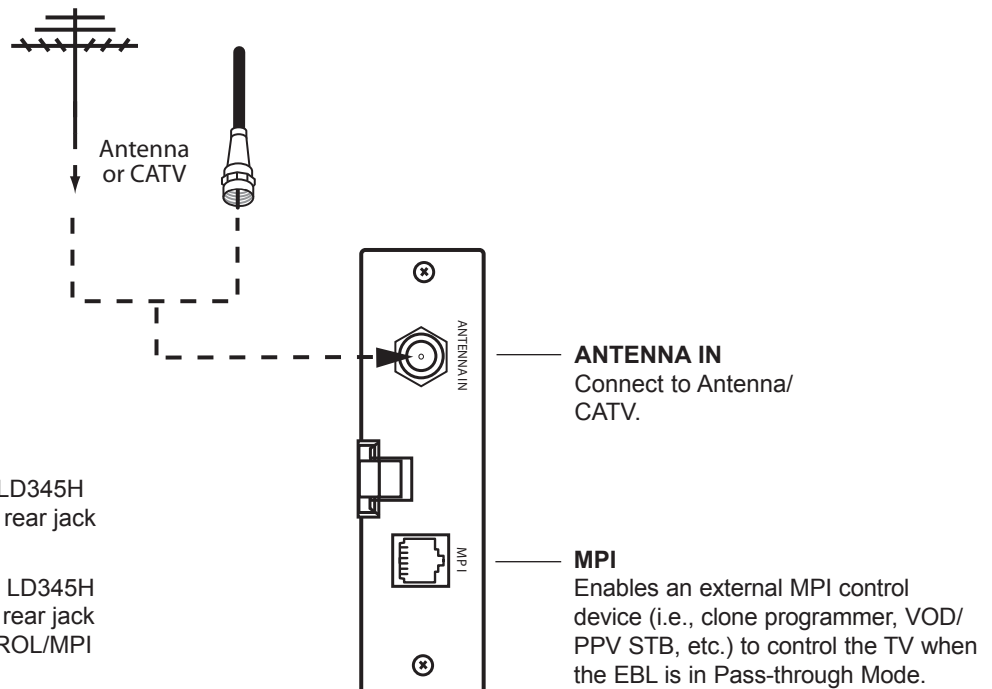

**Notes:**

- On 26LD320H, 26LD340H, and 26LD345H TVs, the RF Antenna jack is on the rear jack panel (see previous page).
- On 26LD320H and all LD340H and LD345H TVs, the MPI port is located on the rear jack panel (dual-purpose GAME CONTROL/MPI port).

### Some Quick and Easy Tips for Resolving Problems

Symptom	Possible Cause(s)	Possible Solution(s)
<b>Installation</b>		
Cannot direct enter channel number.	(TV in Pass-through Mode) Installer Menu item 028 CH. OVERRIDE is set to 0, i.e., disabled (recommended setting).	If Installer Menu item 028 CH. OVERRIDE is set to 0, only channels that are active in the TV's channel lineup can be selected. Set CH. OVERRIDE to 1 to allow access for direct keypad entry to all channels.
	(TV in FTG Mode) The channel entered is not part of the FTG Channel Map.	Channel access is restricted to channels included in the FTG Channel Map. If necessary, make changes to the FTG Channel Map using the FTG Device Configuration Application.

### Power

No power.	See troubleshooting flow chart on following page.
-----------	---

### Display Panel Picture

No picture.	Display panel is turned off.	<ul style="list-style-type: none"> <li>• Turn TV ON.</li> <li>• Power failure?</li> </ul>
	Antenna/cable not connected.	Connect antenna/cable signal to TV
	Connections incorrect.	Check connections on TV
	MPI not connected.	If applicable, connect MPI cable to MPI device.
	Encrypted program.	Try another channel.
	Wrong tuning band.	Adjust Installer Menu settings.

### Erratic Operation

Installer Menu setup.	Wrong Installer Menu settings.	Adjust Installer Menu settings as required.
-----------------------	--------------------------------	---

### Installer Remote

Remote doesn't work.	Remote not in TV Mode.	Use MODE key to select "TV"; puts remote into TV Mode.
	Not aimed at IR remote sensor.	Point remote at IR receiver on TV.
	Remote too far from IR sensor.	Move remote closer to IR receiver on TV or darken room.
	MPI not connected.	If applicable, connect MPI cable to MPI device.
	IR path to TV's receiver obstructed.	Remove obstructions.
	Weak batteries.	Replace batteries.
	Wrong battery polarity.	Check that "+" and "-" match in battery compartment.
	Too much light in room.	Dim room light.
Wrong Installer Remote.	Requires compatible Installer Remote. Contact your LG dealer.	

### Picture Reception

Normal picture, poor or no sound.	Audio muted.	Press MUTE or use Volume Up key to increase sound level.
	Broadcast problem.	Try a different channel.

**Note:** For other problems not caused by the TV, refer to the other devices' operating guide(s).

# Troubleshooting (Cont.)

## Troubleshooting Flow Chart

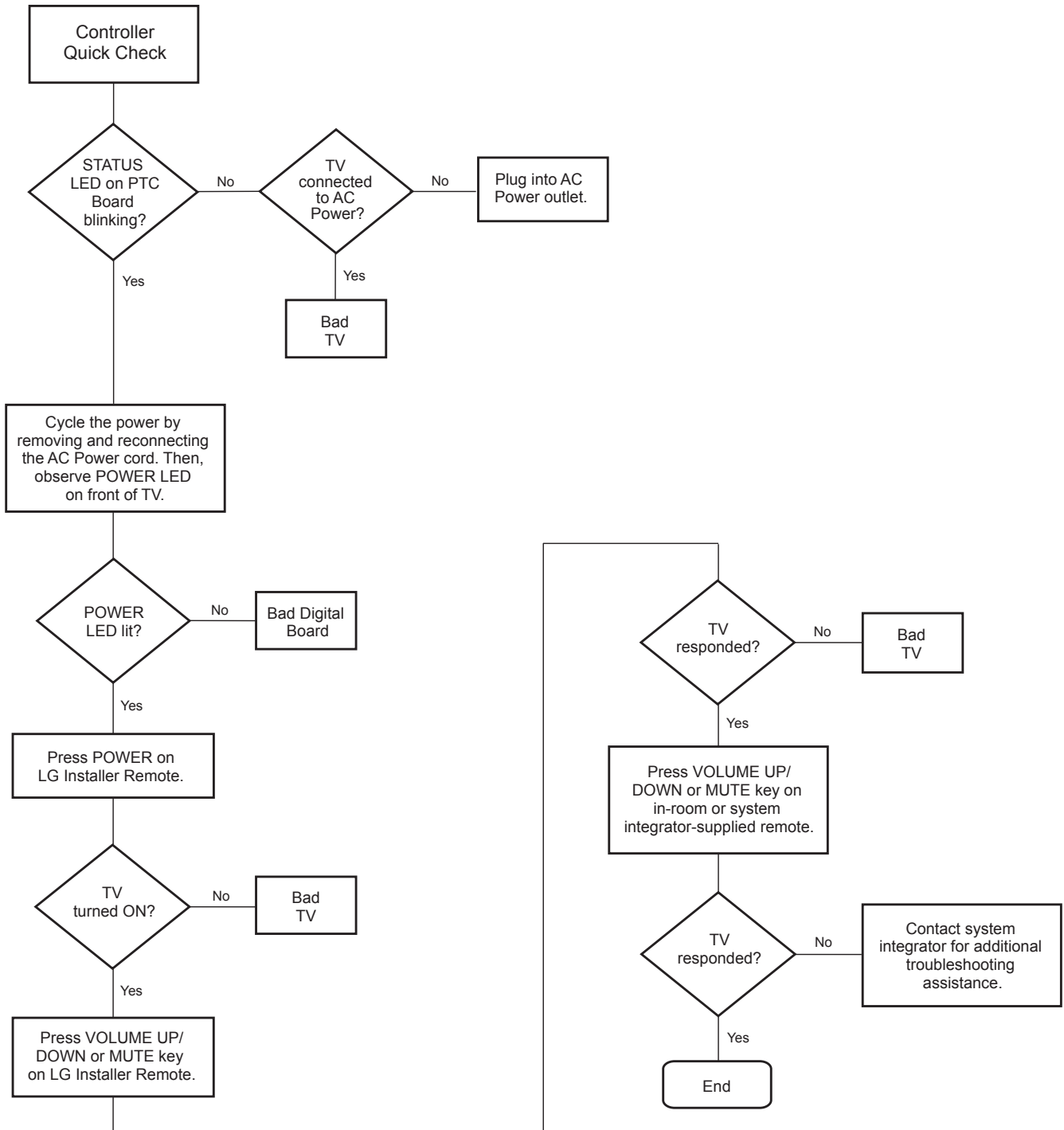

## Commercial Mode Check / FTG Operation Troubleshooting

### Commercial Mode Check

Use this flowchart to determine whether the TV is currently in Commercial Mode.

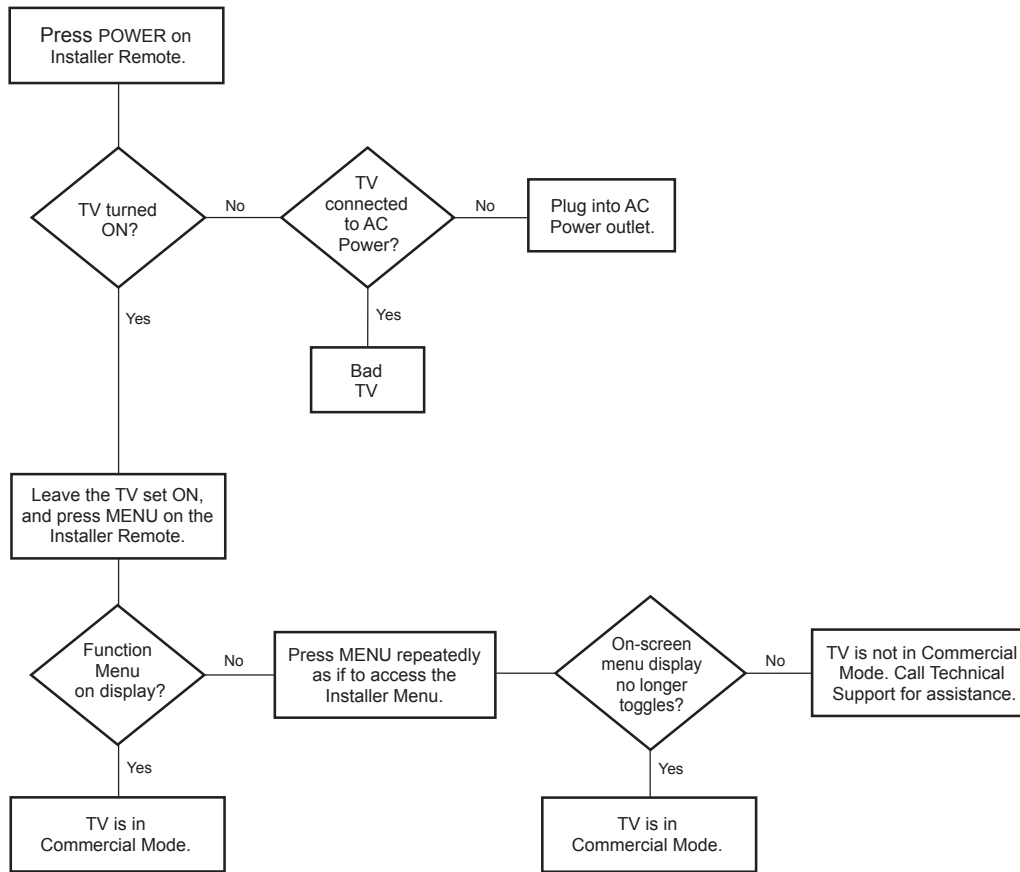

### FTG Operation Troubleshooting

The following table provides troubleshooting information for when the EBL is configured in the FTG Mode of operation.

Symptom	Possible Cause(s)	Solution(s)
Communication Error ("Communications Timeout")	Cable(s) not connected.	Check and connect communication cables.
	TV not powered.	Check/connect the TV power cord.
	TV not turned ON.	TV needs to be turned ON (default FTG Mode).
	Wrong COM (communication) port.	In the FTG Device Configuration Application, select the correct COM port for the cable being used.

# Troubleshooting (Cont.)

## Clone Programmer Troubleshooting



**Caution: Do not connect a clone programmer to a PPV card installed in the Master or Target TVs. Also, if the TV is in LodgeNet PPV Mode (check with the site administrator if you are not certain), do not connect a clone programmer to the GAME CONTROL/MPI port. Either of these actions will damage the clone programmer and, if applicable, the PPV card.**

### Reset Clone Programmer After Static Shock

After replacing exhausted batteries (LT2002 only), or if the clone programmer behaves strangely after a static shock:

- TLL-1100A: Turn the TLL-1100A OFF and then ON.
- LT2002: Use a paper clip or similar instrument inserted through the small hole marked RESET to activate the internal reset switch and restore normal operation.

After a reset, check the real-time clock setting. It may be necessary to set the clone programmer clock from a TV containing the correct time.

**Note:** Both the Master and Target TVs must be in Pass-through Mode for cloning purposes. See also IMPORTANT CLONING INFORMATION on page 23.

### Clone Programmer

Symptom	Possible Cause(s)	Possible Solution(s)
Clone copies setup in less than 30 seconds.	Not enough time to copy entire TV setup.	TLL-1100A: Turn the TLL-1100A OFF and then ON. LT2002: Press RESET on clone programmer. Then redo Learn/Teach. (Learning usually takes about 90 seconds; Teaching usually takes 3 to 4 minutes.)
Remote does not operate clone programmer.	Wrong Installer Remote.	Only use an LG Installer Remote to operate clone programmer with TV.
Clone menu does not display on TV screen, TLL-1100A shows error message, or LT2002 LED does not blink.	MPI cord not connected.	Connect MPI cord properly, and ensure good connection.
	TV not turned ON.	TV must be powered ON for clone programmer to work.
	(LT2002 only) Weak batteries.	Install four (4) fresh AA high-quality alkaline batteries.
	(TLL-1100A only) No charge.	Ensure the TLL-1100A is fully charged or connected to AC power.
Clone menu hard to read.	Weak signal.	Connect TV to a reliable analog channel signal source.
No time set.	Time not available.	Set time on a TV, and copy time to clone programmer.
Clone not working.	Clone programmer problem.	<ul style="list-style-type: none"> <li>• Try a different clone programmer.</li> <li>• Reset the clone programmer.</li> </ul>
Clone scans channels more than once.	Clone should only scan channels once.	Ensure TV is set up correctly, and try cloning again.

### Master and Target TVs

Symptom	Possible Cause(s)	Possible Solution(s)
Cloning did not work.	Procedure interrupted.	Wait until procedure complete message is displayed.
	Different TV models.	Cloning is only possible with identical model TVs.
	Step(s) omitted or not performed.	Refer to the applicable cloning procedure(s), and make sure all tasks were performed.
(LT2002 only) Clone time disappeared.	Batteries were removed.	Batteries must remain installed to retain time settings.
New setup not present.	Target TV not reset.	Disconnect Target TV from AC power for 15 seconds.

- After cloning operations are complete, unplug the TLL-1100A/LT2002 from the TV.
- If the TV does not display a picture (blank screen) after a few seconds, just change channels.

A list of definitions for some of the words found in this guide.

## **75 OHM RF CABLE**

The wire that comes from an off-air antenna or cable service provider. The end looks like a hex-shaped nut with a wire through the middle. It screws onto the Antenna/Cable threaded jack on the back of the TV.

## **300 TO 75 OHM ADAPTER**

A small device that connects a 2-wire 300 ohm antenna to a 75 ohm RF jack. It is usually about an inch long with two screws on one end and a round opening with a wire extending out the other end.

## **A/V CABLES**

Audio/Video cables. Three cables bunched together—right audio (red), left audio (white), and video (yellow). A/V cables are used for stereo playback of videocassettes and for higher quality picture and sound from other A/V devices.

## **A/V DEVICE**

Any device that produces video or sound (VCR, DVD, cable box, or television).

## **AMPLIFIER**

An electronic device that amplifies sound from a television, CD player, VCR, DVD player, or other Audio/Video device.

## **ANTENNA**

The physical receiver of television signals sent over the air. A large metal piece of equipment does not always have to be visible to be using an antenna.

## **b-LAN**

LodgeNet Interactive Corporation proprietary RF communication system used to configure/control TV via RF distribution system.

## **CABLE**

Cable service box. Refers to the descrambler box cable subscribers use to receive cable programming signals.

## **CATV**

Programming provided by a cable service.

## **COMPONENT VIDEO**

Uses three wires for transporting three-color video signals. The end result is usually better video quality.

## **COMPOSITE VIDEO**

Typical video jack, uses one wire for transporting three-color video signals.

## **DELETE**

Lets you remove channels from the list that the end user can scroll through using Channel Up/Down.

## **DIGITAL TELEVISION**

High-resolution, cinema-quality television signals transmitted digitally.

## **DVI**

Digital Video Interface. Accommodates analog and digital interfaces with a single connector.

## **HDMI**

High-definition multi-media interface.

## **HDSTB**

High-definition set top box. Refers to a tuner device that receives high-definition television signals which have higher resolution than ordinary analog TV signals.

## **HDTV**

High-definition television. Refers to television signals that have higher resolution than ordinary analog TV signals.

## **INPUT**

Refers to the input jack that receives a signal from a TV, VCR, DVD Player, or other Audio/Video device.

## **JACK**

An input or output connector on the back of a TV, VCR, DVD Player, or other Audio/Video device.

## **MONO SOUND**

Mono (monaural) sound is one channel of sound. On more than one speaker, all the speakers play the same audio.

## **OUTPUT**

Refers to the output jack that sends a signal out of a VCR, DVD, or other A/V device.

## **PHYSICAL CHANNEL NUMBER**

The actual channel number. Analog channels use the Physical Channel number and digital channels can use a Virtual Channel number.

## **RGB (RED, GREEN, BLUE)**

Connection input or output port available for producing a video image using three separate colors: Red, Green, and Blue.

## **RS-232**

Serial communication port through which firmware is downloaded.

## **2ND AUDIO PROGRAMMING/SAP**

Second Audio Programming (SAP) is another, separate audio channel available with some programming. Choosing SAP often refers to listening to audio in another language, such as Spanish or French.

## **SIGNAL**

Picture and sound traveling through a cable, or over the air, to the TV.

## **STEREO SOUND**

Stereo (Stereophonic) sound refers to audio that's divided into right and left sides.

## **TUNER**

Device that picks up the broadcast signal and turns it into picture and sound.

## **VIRTUAL CHANNEL NUMBER**

A re-mapped channel number. Analog channels use the Physical Channel number; however digital channels use a Virtual (or false) Channel number.

## **XDS**

Extended Data Service. Additional program information included on the signal provided at the discretion of the broadcaster.

Note: Refer to [www.atsc.org](http://www.atsc.org) for further information.

# Document Revision History / Notes

---

## Document Revision History

Date	Description
May 2011	Revision A: New document
November 2011	Revision B: LD320H/LD325H models added to document, also updates for external MPI control

Product documentation is available online at: [www.LGolutions.com/products](http://www.LGolutions.com/products). From the Products page, select **TVs, Systems & Solutions**, then **LCD TVs**, then the applicable TV. Click the **Literature & Downloads** tab at the bottom of the TV page, and select the required document(s) from the Downloads list.

---

## Notes





---

For Customer Support/Service, please call:

**1-888-865-3026**

[www.LGsolutions.com](http://www.LGsolutions.com)

Pro:Idiom is a registered trademark of Zenith Electronics LLC. Pro:Centric is a trademark of LG Electronics U.S.A., Inc. *b-LAN* is a trademark of LodgeNet Interactive Corporation. All other trademarks or registered trademarks are the property of their respective owners.

## Free Manuals Download Website

<http://myh66.com>

<http://usermanuals.us>

<http://www.somanuals.com>

<http://www.4manuals.cc>

<http://www.manual-lib.com>

<http://www.404manual.com>

<http://www.luxmanual.com>

<http://aubethermostatmanual.com>

Golf course search by state

<http://golfingnear.com>

Email search by domain

<http://emailbydomain.com>

Auto manuals search

<http://auto.somanuals.com>

TV manuals search

<http://tv.somanuals.com>