



GSM Phone

USER'S MANUAL

MODEL : LG - 600

Please read this manual carefully before operating your set. Retain it for future reference.

LG-600 has a polished style which provides users' a better feel and convenience.

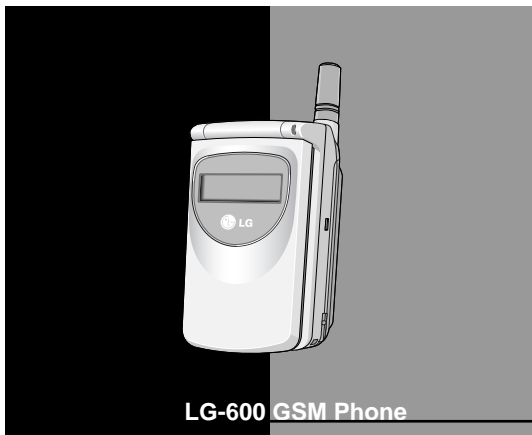

For Your Safety

All radio transmitters carry risks of interference with electronics in close proximity.



GSM Phones must be switched off at all times in an aircraft.



Do not activate near petrol stations, fuel depots, chemical plants or blasting operations.



Avoid use in hospitals : medical electronics, e.g. pacemakers and hearing aids can be affected.



Minor interference may affect TVs, radios, PCs, etc.



Do not hold the phone in your hand while driving.



Do not dismantle phone or battery.

Please note:



Use only specified batteries and chargers as others can damage the phone.



Unusable batteries should be disposed of in accordance with relevant legislation.



Only use ORIGINAL accessories to avoid damage to your phone.

Contents

Overview

Accessories	10
Part of the Phone	11
• Front of the Phone	11
• Rear of the Phone	12
Key Description	13
• Side of the Phone	14
• Alphanumeric Keys	15

Display Information

Display Information	16
• On-Screen Icons	16

Getting Started

Installation	18
• Installing the SIM Card	18
• Installing the Battery	19
• Charging the Battery	20
Powering On Sequence	21
Access Codes	22
• PIN1 code (4 to 8 digits)	22
• PIN2 code (4 to 8 digits)	22
• PUK1 code (4 to 8 digits)	22
• PUK2 code (4 to 8 digits)	22
• Security code (4 to 8 digits)	22
Write and Read Messages	23
• Write message	23
• Read message	23
eZi Text	24
• How to Use eZi Text	24

Call Functions

Making and Answering Calls	27
• Making Calls	27
• Answering Calls	28
Recent Numbers	29
• Dialed Number	29
• Received Number	29
• Missed Number	29

Accessing the Menu

Phonebook	30
• Search [Names 1]	30
• Search E-Mail [Names 2]	31
• Add Entry [Names 3]	31
• Add E-Mail [Names 4]	32
• Groups [Names 5]	33
• Speed Dials [Names 6]	35
• Delete all [Names 7]	35
• Memory [Names 8]	35
• Copy [Names 9]	36
• Service Dial Number [Names 10] (SIM dependent)	37
• Own Number [Names 11]	37
MMI Structure	38
Using the Menu	42
Menu Navigation by scrolling	42
Shortcuts into Menus	42
Messages [Menu 1]	43
• Write Message [Menu 1-1]	43
• Outbox [Menu 1-2]	44
• Inbox [Menu 1-3]	45

• Status Report [Menu 1-4]	46
• Call Voicemail [Menu 1-5]	46
• Cell Broadcast [Menu 1-6]	47
• Memory Status [Menu 1-7]	48
• Setting [Menu 1-8]	49
Call Option [Menu 2]	50
• Call Divert [Menu 2-1]	50
• Call Barring [Menu 2-2]	51
• Call Waiting [Menu 2-3]	52
• Sending Number [Menu 2-4]	53
• Closed User Group [Menu 2-5]	53
Call Charge [Menu 3] - (SIM dependent)	54
• Call Duration [Menu 3-1]	54
• Call Costs [Menu 3-2]	54
• Cost Settings [Menu 3-3]	55
Security [Menu 4]	56
• PIN Enable [Menu 4-1]	56
• Change Codes [Menu 4-2]	56
• Fixed Dial Number [Menu 4-3]	57
Setting [Menu 5]	58
• Network Selection [Menu 5-1]	58
• Phone Setting [Menu 5-2]	58
• Call Setting [Menu 5-3]	60
• Time Setting [Menu 5-4]	62
• Profiles [Menu 5-5]	63
Accessories [Menu 6]	65
• Scheduler [Menu 6-1]	65
• World Time [Menu 6-2]	67
• Calculator [Menu 6-3]	67
• Unit Convert [Menu 6-4]	67
• Game [Menu 6-5]	68
• PC Sync	68

Voice Dial [Menu 7]	69
• Training [Menu 7-1]	69
• Search [Menu 7-2]	69
• Setting [Menu 7-3]	70
• Delete all [Menu 7-4]	70
Internet [Menu 8]	71
• Home [Menu 8-1]	71
• Bookmarks [Menu 8-2]	71
• Profiles [Menu 8-3]	72
• Empty Cache [Menu 8-4]	72
In Internet Menu	73

Additional Functions

How to Send DTMF tones	74
• Wait Characters	74
• Interrogating your Answering Machine(example)	74
• During a Call	74
In-Call Options	75
How to Use Data and Fax Call	79
• Making a Data or Fax call	79
• Making a Voice & Fax call	80
Voice Memo	81
• Voice Memo	81
• Voice Memo Menu	81
Care and Maintenance	82
Technical Data	83
• General	83
• Dimensions	83
• Ambient Temperatures	83

Check to make sure that you have all the parts shown below.

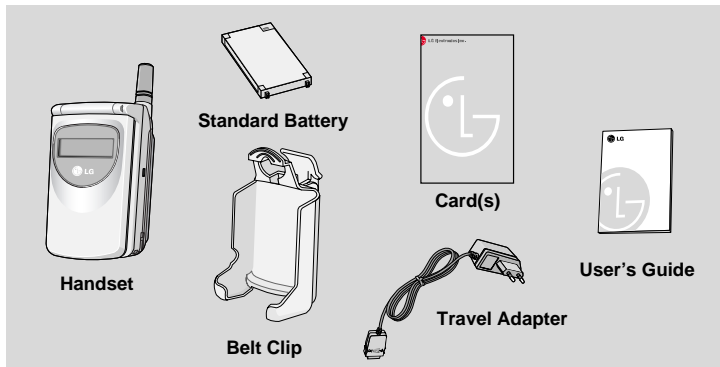

<Optional Accessories>

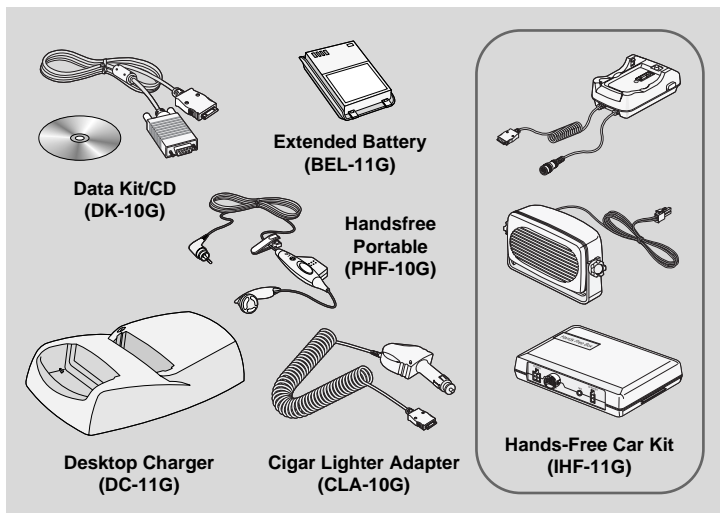

Front of the Phone

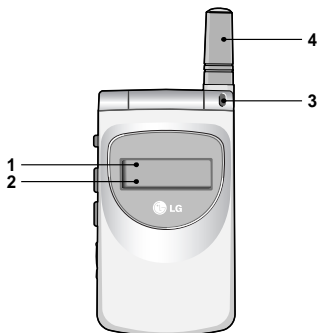

- 1 Front LCD Screen
- 2 Hard Icons
- 3 Call Indicator Light
- 4 Antenna

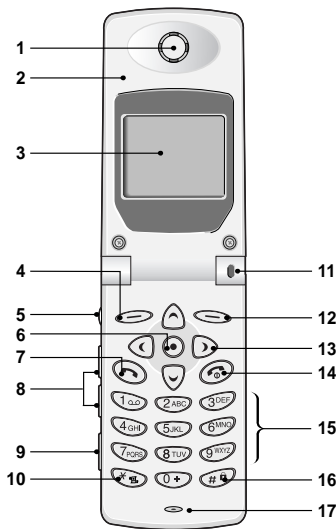

- 1 Earpiece
- 2 Active Folder
- 3 Display Screen
- 4 Soft Left Key
- 5 Record Key
- 6 Confirm Key
- 7 Send Key
- 8 Up/Down Side Key
- 9 Ear Microphone
- 10 Star Key
- 11 Call Indicator Light
- 12 Soft Right Key
- 13 Navigation Keys
- 14 END/PWR Key
- 15 Numeric Keys
- 16 Hash Key
- 17 Microphone

Rear of the Phone

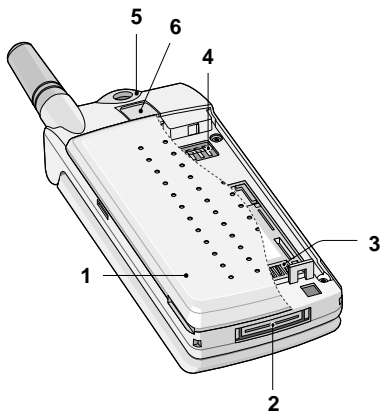















- 1 Battery Cover**
- 2 Cable Connector/
Battery Charging
Connector/
Hands-Free Car kit
Connector**

- 3 SIM Card Socket**
- 4 Battery Terminals**
- 5 Handstrap Hole**
- 6 Battery Lock**

The following shows key components of the phone.



Keypad Description

Key	Description
	<p>Soft Left Key / Soft Right Key</p> <p>Each of these keys performs the function indicated by the text on the display immediately above it.</p>
  Easy Key	<p>WAP Hotkey</p> <p>You can directly connect to WAP by pressing this key.</p> <p>Navigation Keys</p> <p>You can use these keys to scroll through names, phone numbers, menus or setting options. In a standby mode, if you press up/down navigation keys, you can see the "Dialed Number" "Received Number" and "Missed Number".</p>
	<p>Send Key</p> <p>You can dial a phone number and answer a call. If you press this key without entering a number, your phone shows the most recently dialed number.</p>
  	<p>Numeric Keys</p> <p>These keys are used mainly to dial in standby mode and enter numbers or characters in editing mode.</p> <p>When you press these keys for a long time.</p> <ul style="list-style-type: none"> Used to call your voice mail box by . Used to call for international call by . Used to call speed dials by  ~ .
	<p>Star Key</p> <p>Used to enter to vibration mode by pressing this key for a long time.</p>

Key	Description
	Hash Key Used to lock key by pressing this key for a long time.
	END/PWR Key Used to end or reject a call. This key is also used as Power Key. You can power on and off by pressing this key for a long time.











Side of the Phone

Keypad Description







Key	Description
	Record Key You can use voice memo by pressing this key for a long time.
	Reject Key You can reject an incoming call by pressing this key for a few seconds without opening the folder.
	Up/Down Side Key You can control the volume of key tone in standby mode with opened folder and also the listening volume during a call.

Alphanumeric Keys

The alphabet and numeric keypad mapping relation are listed as the following table.

Key	Description
	. ! ' ^ , - ? @ 1 _
	A B C 2 Ä Å Ã Ä Å Æ Ç a b c ä å â ã ä æ ç
	D E F 3 È É Ê Ë def è é ê ë
	G H I 4 Ì Í Î Ï Ĝ ħ i ĩ 4 Ì Í Î Ï Ĝ ħ i
	J K L 5 j k l
	M N O 6 Ñ Ò Ó Ô Õ Ö m n o ñ ò ó ô õ ö
	P Q R S 7 ß Š š p q r s š
	T U V 8 Ü Ú Ú Û ü v ü ù ú û
	W X Y Z 9 w x y z
	[Space Key] 0 Ø ø

Notice

- In case of symbol mode, after entering the character, the mode is automatically converted to Capital letter mode. And if you want to enter another symbol character, find it to use the navigation keys,  and  key, press  key or  key to save. Also you can use the next symbol page with , .





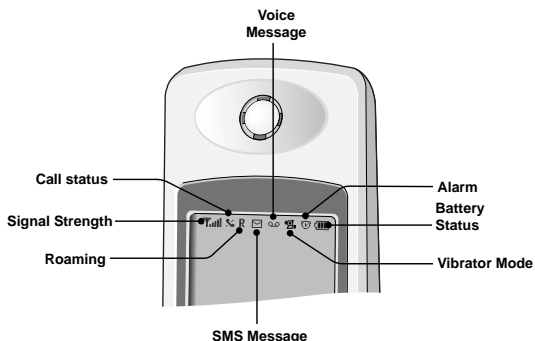



The screen displays several icons the following describe each of them you may see on the phone.

On-Screen Icons







Icon/Indicator	Description
	Tells you the strength of the network signal.
	You are in no service area. / Call is connected.
	Shows that you are using a roaming service.
	You have received a new text message.
	You have received a voice message, depending on your subscription.
	All audible signals are turned off.
	All tones are switched off.
	The alarm has been set and is on.
	Tells you the status of the battery.

Top Menu Icons

Icon	Description
	Messages
	Call Option
	Call Charge
	Security
	Setting
	Accessories
	Voice Dial
	Internet

Result Icons

Icon	Description
	Completed Message Displayed when menu navigation is completed.
	Information Message
	Save Message
	Warning Message Displayed with error or warning message.

1 Installing the SIM Card

Locate the SIM card socket in the back of the phone. Follow the steps below to install the SIM card.

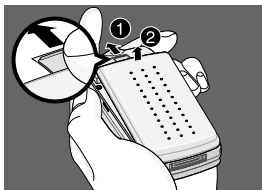

1. Unlock the battery cover **1** and lift it off **2**.

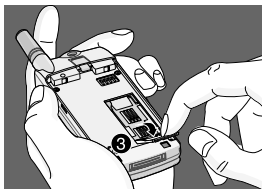

2. Flip the SIM holder **3**.

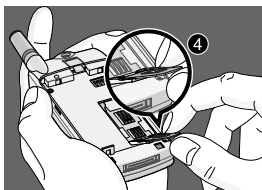

3. Slide the SIM card into the holder **4**.
 - Ensure the angled corner is positioned correctly and the contact is made.

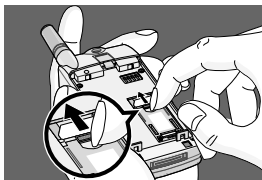

4. Close the SIM card holder, and move the holder lock lever up.

! Notice

- Before installing SIM card, please make sure that the phone is switched off and the battery is removed.
- The metal contact of the SIM card can be easily damaged by scratches. Pay special attention to the SIM card when you handle and install. Follow the instructions supplied with the SIM card.

2 Installing the Battery

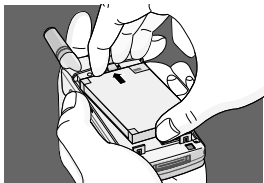

1. Place the top end of the battery on the phone. (See the picture left for purposes of illustration.)

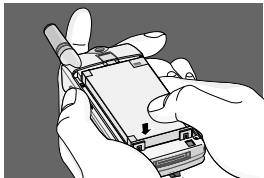

2. Push the battery in until you hear a "CLICK" sound.

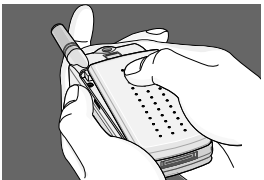

3. Close the battery cover.

3 Charging the Battery

To connect the travel adapter to the phone you must install the battery.



1. Insert one end of the travel adapter into the bottom of the phone.

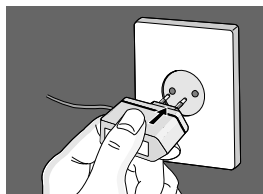

2. Connect the adapter to an AC wall outlet. Use only the included packing charger.



The usage times may be different depending on network service.

Battery Type	Charging Times	Usage Times	
		Standby	Talk
Standard	2 hours	150 hours	2 hours 30 min
Extended	3 hours	250 hours	4 hours

4 Disconnecting the Charger

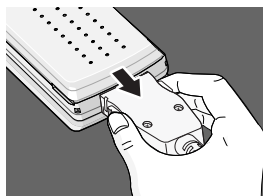

Disconnect the travel adapter from the phone by pressing its side buttons.

! Notice

- Remember to charge the new battery fully after changing it.
- Do not remove your battery or SIM card while charging.
- “Battery Charging” is displayed on the screen after connecting the travel adapter. Only if the battery is totally empty, Call Indicator Light will be on without displaying “Battery Charging”.
- The moving bars of battery icon will stop after charging completely.

! Note

- In case of the battery is not charged properly...
 1. After switching On/Off Power key, please try to recharge it.
 2. In case the battery is attached, please detach it from the phone. Then place it back to recharge it again.

Powering On Sequence

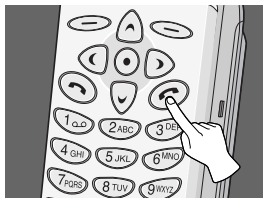

In order to get started with your phone, follow the steps.

1. Press and hold  button until you hear a tone from your phone to switch on.
2. If PIN code request of your SIM card is enabled, your phone asks you to enter PIN code. Enter the PIN code, then your phone connects to a GSM network and the network name appears on the display shortly.
3. And then your phone goes to standby mode. If the PIN code is disabled, your phone connects to the network without the request of entering PIN code.

You can use the access codes described in this section to avoid unauthorised use of your phone. PIN1 / PIN2 codes and Security code can be changed by using [Menu 4-2]. See the following section.

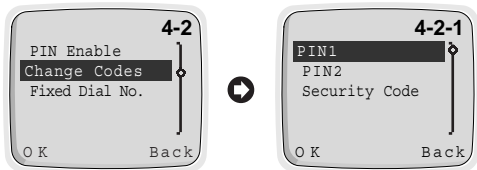

PIN1 code (4 to 8 digits)

The PIN (Personal Identification Number) code protects your SIM card against unauthorized use. The PIN code is usually supplied with the SIM card. When the PIN code request is enabled [Menu 4-1-1], the code is asked each time you try to change PIN code or enable/disable PIN code request, or your phone is switched on. If you change the PIN code, mark a note of it but keep separate from the phone.

PIN2 code (4 to 8 digits)

The PIN2 code, supplied with some SIM cards, is required to access some functions such as Advice of call charge, Fixed Dial number. These functions are only available if supported by your SIM card.

PUK1 code (4 to 8 digits)

The PUK(Personal Unblocking Key) code is required to change a blocked PIN code. The PUK code may be supplied with the SIM card. If not, contact your local service provider for the code. If you lose the code, also contact your service provider.

PUK2 code (4 to 8 digits)

The PUK2 code, supplied with some SIM cards, is required to change a blocked PIN2 code. If you lose the code, also contact your service provider.



Security code (4 to 8 digits)

The security code protects the unauthorized use of your phone. It is usually supplied with the phone. This code is required to delete all phonebook entries.

Write Message

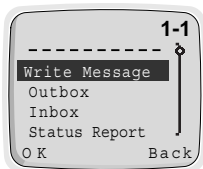







If you want to write the short message, you will follow the next procedure.





1. Press  [Menu].
2. Select **Messages** in main menu by pressing  [OK]. And then If you want to write a new message, select **Write Message** in the menu. If you want to modify the previous message, select **Outbox** in the menu, then you can edit the message by using eZi text editor or normal editor. If you want to write a reply message, select **Inbox** in the menu.

Read Message

If you want to read the previous stored short message received before, you will follow the next steps.

1. Press  [Menu].
2. Then you can see the top menu. And select **Messages** by pressing  [OK].
3. When **Messages** menu is displayed, scroll to **Inbox** by using  and  and press  [OK].
4. Once you enter this menu, you can see the last received messages. Scroll to the desired message by using ,  . And if you want to exit Inbox menu, press  [Back]. While reading message, press  [Opt] to access the available options. You can see the explanation of **Option** in [Menu 1-3].

If you want to read the short message just received, you will follow the next steps.

1. When received a short message,  will be displayed on the screen.
2. Press  [OK], then you can read the just received message.

How to Use eZi Text

The eZi Text allows the user to type easily and quickly. Simply pressing each key once for each character, you can get the words you want. Furthermore, the candidate is predicted along with other candidates that fit the letters typed thus far. So, you don't need to input entire characters to make the word.



■ How to change mode

This phone supports three kinds of edit mode : **eZi mode**, **Numeric mode** and **Letter mode**. To change mode just press  key, then you can select the one among three modes.

■ How to use in eZi mode



To input text in eZi mode, simply press each key once for each letter.

After inputting the character, you can see that the candidate is appeared in text box, which has a high priority. Also you can choose other candidates using  and .

E.g. If you want to enter “Meet at church after lunch”.

To type “Meet”, the user types the letters on the keys requiring only one key-hit per letter. The candidate “Meet” is predicted along with other candidates which fit the letters typed thus far. The user uses the select “Meet”.

The user continues inputting characters in a similar manner for the rest of the message. Each candidate only requires a couple of key hits to find the target word.

Now lets demonstrate the predictive power. The word “lunch” is 5 letters long. Text input only requires 4 key hits before the word is predicted.

If at any time the user wants to input some punctuation, they press only  key to input punctuation.

For example, if you want to enter “you”, then press **g** key once. You can see “we”. Next, press **6** key, then you can see “you” in the text box. If the word isn’t shown, press **8** key, or search the word with **<** and **>**.

After entering characters, select the candidate you want with **0+** key.

! Notice

- You can change a language with **#** key. And you can also change the capital form with **^** and **v**. For example : you → You → YOU → Y.O.U → y.o.u.

■ How to use in numeric mode

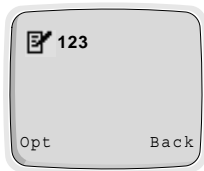

You can use this mode to input number, change another mode by ***#** key.

- Change the input mode to Numeric.
- Press the key you want to enter.

■ How to use in Letter mode

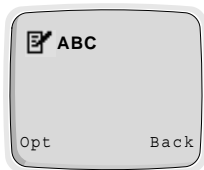

Capital Mode

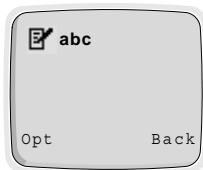



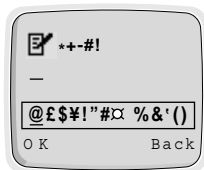

Small Mode



Symbol Mode

There are three sub modes in Letter mode: **Capital mode**, **Small mode**, and **Symbol mode**.

Key	Description
	changes another mode e.g. eZi mode → Numeric mode.
	changes Capital mode to Small mode or Small mode to Capital mode.
	enters Symbol mode by pressing this key for a long time.
 	moves next Symbol page in Symbol mode.





! Notice

- In case of Symbol mode, after entering the character, mode is automatically converted to CAP letter mode.



■ How to use user's dictionary

You can use user's dictionary in case of writing SMS. The eZi Text has user's dictionary. You can add a few words to user's dictionary and then the word has a high priority.





■ How to add word to user's dictionary

1. In the screen of eZi text mode press  [Opt] key.
2. Scroll to **Dictionary** menu, press  [OK] key.
3. Press  [Opt] key after entering word you want.
4. Scroll to **Add to UPD** menu, press  [OK] key.
5. If **Done** message is displayed in phone, it is added successfully to user's dictionary.
6. And you can check the word is added on **List Dictionary** menu.

■ How to erase word from user's dictionary

1. Scroll to **List Dictionary** menu.
2. Press  [OK] key after selecting word you want to delete.
3. In next screen, press  [Opt] key.
4. Press  [OK] key after selecting **Del from UPD**.
5. If **Done** message is displayed in phone, then it is deleted successfully from user's dictionary.

Making Calls

1. Key in phone number including the area code. To edit a number on the display, press  to move cursor to the left, and press  to move cursor to the right.
2. Press  to call the number.
3. Press  to end the call (or to cancel the call attempt).

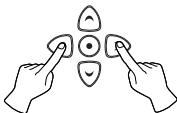



■ Voice Dial

1. If you select **Enable** in Setting [7-3], you can call by only voice.
2. When you open the flip, your phone display “Guide Message” and you will hear “Please say name”.
3. Then you must speak a programmed name which you want to call within 5 seconds.
4. Your phone will dial the number associated with that programmed name.







! Note

- You have to associate your voice to the desired no. in order to use this function. Refer to Menu 7 (Voice Dial Menu) for further information.



■ International Calls

1. Press and hold the  key for the international prefix. (+character replaces the international access code.)
2. Enter the country code, area code and phone number.
3. To call the number, press .

■ Making a Call using the Phonebook

1. In a standby mode, select **Names** by pressing  [Names] key.
2. When phonebook menu is displayed, you can select **Search** by pressing  [OK].
3. Key in the first letter of the name and press  [Search].
4. Use  and  key, reach the desired name.
5. Press  to dial.

■ Last Number Redial

1. Press  and then you will see the last dialed number.
2. Then press  one more if you want to dial to the number again.
3. If you want to dial the latest number by one key stroke, press and hold .

■ Calling your Voicemail Service

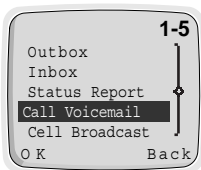

1. Press  until your phone goes to calling mode. Or you can call it by using [Menu 1-5]. If you want to use menu, see [Menu 1-5]. (Voicemail Services must be set up with your network operator.)



2. If the phone asks for the voicemail number, key it in and press  [OK]. You can obtain this number from your service provider. Also, you can edit this number later on.

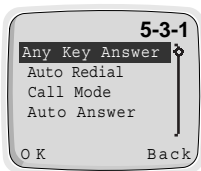

■ Making Call by Speed Dials

See the Section **Phonebook - Speed Dials**.

Answering Calls



1. The way to answer an incoming call is dependent on setting of [Menu 5-3-1].
2. If you select **On** in Any Key Answer [Menu 5-3-1], you can answer an incoming call by pressing any key except . If you select **Off**, you can do it by opening the folder. If folder is already opened, you can also answer the call by pressing .
3. Press  or close folder to end the call.

In a standby mode, when you press  or , these menu items below will be displayed. Dialed Number, Received Number and Missed Number can be saved in a Phonebook.

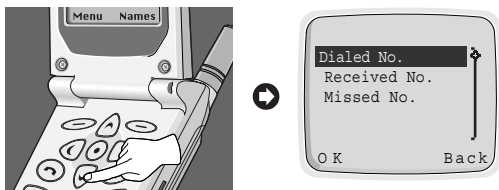

Dialed Number

Shows recently dialed phone numbers that were not answered. After locating a phone number, you can make a call or erase the phone number.

Received Number

Shows recently received phone numbers up to 10. After locating a phone number you can make a call(if the network provides the service) or erase the phone number.

Missed Number

Shows recently missed incoming phone numbers up to 10. Those numbers that were called but were not answered. After locating a phone number, you can make a call or erase the phone number.

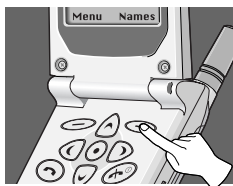

The phonebook has several menus from which you can choose. Press [Names] in a standby mode and then scroll to the desired item.

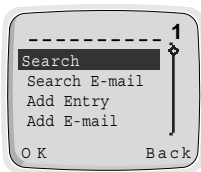

	Names	Description
1	Search	Allows you to search for a specific name.
2	Search E-Mail	Allows you to search for E-Mail address by name.
3	Add Entry	Allows you to add new names and numbers.
4	Add E-Mail	Allows you to add new names and E-mail address.
5	Groups	Allows you to show group list.
6	Speed Dials	Allows you to assign up to 8(2-9) one- touch dial allocations.
7	Delete all	Allows you to erase all the data in either your phonebook or the SIM card by selecting the memory.
8	Memory	Allows you to select the preferred memory of Phone/SIM card or to view the memory status.
9	Copy	Allows you to copy entries from your Phone memory to SIM card or from SIM card to Phone memory.
10	SDN	Allows you to show the Service Dial Number entries.
11	Own Number	Allows you to enter and show your own numbers

Search [Names 1]





(Calling from phonebook)





1. Open the phonebook first by pressing [Names] in a standby mode.
2. Select **Search** by pressing [OK] key.
3. Write the first letter or all character of required name and press [Search] then the name(s) will be displayed on the screen.

4. Scroll to highlight required name.
5. Press  [OK] to display the name and phone number.
6. If you want to call, press  .

Note

- In this menu, you can edit or delete the number you selected. If you do not enter the name and press  [Search], then all entries will be displayed. If you want to find the name “David”, you may enter “D” by using the digit keys then you will see names starting with “D”, and you choose “David” by scrolling up/down to the required name “David”. On the window displayed name and phone number, you can edit or delete them by pressing  [Opt].

Search E-Mail [Names 2]

1. Open the phonebook first by pressing  [Names] in a standby mode.
2. Scroll to highlight **Search E-Mail**, and press  [OK] to enter.
3. Write the first letter or all character of required name and press  [Search], then the name(s) will be displayed on the window.
4. Scroll to highlight the desired name.
5. Press  [OK] to display the E-mail address.





Note

- On the window displayed name and E-mail address, you can edit or delete the name and E-mail address by pressing  [Opt].

Add Entry [Names 3]

You can add name and phone number by using this function. After editing, you can save either to the SIM card or to the Phone memory.





Phone memory capacity is 500 entries of personal number, and SIM card memory capacity of personal number depends on the service provider. You can also save 20 characters of name in the Phone memory and the SIM card memory each. The number of characters is dependent on SIM feature.

1. Open the phonebook first by pressing  [Names] in a standby mode.
2. Scroll to highlight **Add Entry**, and press  [OK] to enter.
3. Input a name to add.
4. Press  [OK], then the window for inputting number will be displayed.
5. Edit phone number.
6. Press  [OK], then memory selection window will be displayed. In this window, you can store the phone number in, either the SIM card or the Phone.
7. If the memory is available, you can add the entry. However, if the memory is full, then error message will be displayed and the menu will move to the previous step.

Add E-Mail [Names 4]

You can add name and E-Mail address by using this function. After editing, you can save E-mail address only to the phone memory.

You can save up to 30 characters of E-mail name and 50 characters of E-mail address only in a Phone memory.





1. Open the phonebook first by pressing  [Names] in a standby mode.
2. Scroll to highlight **Add E-Mail**, and press  [OK] to enter.
3. Input the name using the keypad.
4. Press  [OK].
5. If Phone memory is available, then the message for inputting E-mail address will be displayed. However, if Phone memory is full, error message will be displayed. In order to add new entry, you need to delete old E-mail list first in Search E-mail menu.
6. Edit E-Mail Address.
7. Press  [OK] to save.

Groups [Names 5]

By choosing this function, you can manage Group list, such as Member list, Add, Delete, Rename.

If you use **Add** menu, you can save up to 20 members in each group.

You can save up to 10 groups only in the Phone memory.



1. Open the phone book first by pressing  [Names] in a standby mode.
2. Scroll to **Groups** item then press  [OK] to enter this menu.
3. Every Group list will be displayed.
4. If you want to Add Group, select <Empty> and press  [Add].
5. Select and input a Group name that you want.
6. After pressing  [Opt] for a selected group, submenus below will be displayed.

Notice

- Selecting this item does not mean that you can add new entry in the Groups. In order to add new entry in the Group, you need to choose Member list.





■ Member list:

This menu item has three submenus: Add New Entry, Add Being Entry and Delete Entry.

1. Select **Member list**, then press  [OK] to enter.
2. Then Member list will be displayed.
3. Select Member, and press  [Opt] to enter.
4. Then **Add New Entry**, **Add Being Entry** and **Delete Entry** will show up.
 - **Add New Entry** : You can add a new entry in the selected Group or phonebook.
 - **Add Being Entry** : You can add an existing entry by searching from phone book.
 - **Delete Entry** : You can delete a selected entry in a Group.

■ Delete:

You can delete Group in the Group list.





1. Scroll to highlight **Groups**, then press  [OK] to enter.
2. Scroll to highlight **Delete**, then press  [OK] to enter.
3. Then confirmation message will be displayed.
4. Press  [OK] to delete, or press  [Back] to cancel.

! Notice

- Even though you delete a Group in the Group list, the entries will remain in memory.



■ Rename:

You can change group name.

1. Scroll to highlight **Groups**, then press  [OK] to enter.
2. Scroll to highlight **Rename** item, then press  [OK] to enter.
3. Then Group Name editing window will be displayed.
4. Press  [OK] to rename, and press  [Back] to cancel.





Speed Dials [Names 6]

You can associate any of the keys  to  with a Name list entry to give you direct access, with a single long key press in a standby mode.



1. Open the phonebook first by pressing  [Names] in a standby mode.
2. Scroll to **Speed Dials**, then press  [OK] to enter this menu.
3. Then Speed Dials list will be displayed.
4. There are three submenus: **Add**, **Change** and **Delete**. If you want to add Speed Dials number, select **<Empty>** and press  [**Add**]. You can change the Speed Dials number allocation by entering **Change** and delete the allocated speed dials number by entering **Delete**.

Delete all [Names 7]

You can delete all stored numbers and names. This function may require Security code.



1. Open the phonebook first by pressing  [Names] in a standby mode.
2. Scroll to **Delete all**, then press  [OK] to enter this menu.
3. Then select the memory to erase: SIM card or Phone.
4. Warning message will be displayed to make sure your decision.
5. If you press  [OK] then you may be requested to enter Security Code '0000'.
6. Press  [OK] to erase, press  [Back] to cancel.

Memory [Names 8]

1. Open the phonebook first by pressing  [Names] in a standby mode.
2. Scroll to **Memory**, then press  [OK] to enter this menu.
3. Then menu items below will be displayed.
 - **Select** : This feature allows you to select the memory: SIM card or Phone.
 - **Show Status** : This feature allows you to check the total memories and how many memories are used in your phonebook.

Copy [Names 9]

You can copy entries from one memory to another. You can copy/move entries from SIM card memory to Phone memory once at a time or all at once. And you can copy/move entries from Phone memory to SIM card memory once at a time or all at once.

1. Open the phonebook first by pressing  [Names] in a standby mode.
2. Scroll to **Copy**, then press  [OK] to enter this menu.
3. Then submenus below will be displayed.

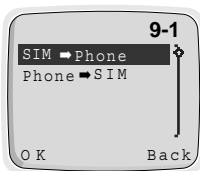

SIM → Phone : You can copy/move the entry from SIM Card to Phone memory.

Phone → SIM : You can copy/move the entry from Phone memory to SIM Card.

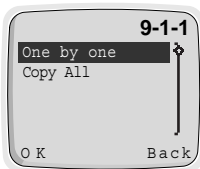

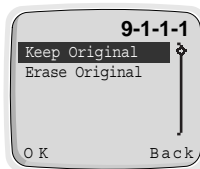

One by One : You can copy/move an entry once at a time.

Copy All : You can copy/move all entries at once.







Keep Original : Both original and located entries are kept in memories.

Erase Original : Original entry is erased whereas located entry remains in the memory.

4. Select the entry to copy/move in the phonebook.
5. Press  [OK] to copy/move, and press  [Back] to cancel.



Service Dial Number [Names 10] (SIM dependent)

Use this function to access a particular list of services provided by your network operator (if supported by the SIM card).

1. Open the phonebook first by pressing  [Names] in a standby mode.
2. Scroll to **SDN**, then press  [OK] to enter.
3. The names of the available services will be shown.
4. Use  and  to select a service.
5. Press  to call the service.

Own Number [Names 11]

If you input your phone number, Own Number will show up.

1. Open the phonebook first by pressing  [Names] in a standby mode.
2. Scroll to **Own Number**, then press  [OK] to enter this menu.
3. The names of the available own number will be shown, if you input your name and number.



1 Messages

- 1-1 Write Message
- 1-2 Outbox
- 1-3 Inbox
- 1-4 Status Report
- 1-5 Call Voicemail
- 1-6 Cell Broadcast
- 1-6-1 CB Option
 - 1-6-1-1 On
 - 1-6-1-2 Off
- 1-6-2 Read
- 1-6-3 Topics
 - 1-6-3-1 SIM
 - 1-6-3-1-1 Add
 - 1-6-3-1-2 Delete
 - 1-6-3-2 Phone
 - 1-6-3-2-1 Add
 - 1-6-3-2-2 Select
 - 1-6-3-2-3 Delete
- 1-6-4 Languages
- 1-7 Memory Status
- 1-8 Setting
 - 1-8-1 Status Report
 - 1-8-2 Message Type
 - 1-8-3 Expiry Period
 - 1-8-4 SMS Centre
 - 1-8-5 Voice Centre
 - 1-8-6 Alert



2 Call Option

- 2-1 Call Divert
 - 2-1-1 Voice Calls
 - 2-1-1-1 Divert All Voice Calls
 - 2-1-1-2 Divert if not Reachable
 - 2-1-1-3 Divert if Busy
 - 2-1-1-4 Divert if No Reply
 - 2-1-1-5 Cancel All
 - 2-1-2 All Data Call
 - 2-1-3 All Fax Call
 - 2-1-4 Cancel All
- 2-2 Call Barring
 - 2-2-1 All Outgoing Calls
 - 2-2-2 Outgoing International calls
 - 2-2-3 Outgoing International except Home
 - 2-2-4 All Incoming Calls
 - 2-2-5 Incoming Calls When Roaming
 - 2-2-6 Cancel All
 - 2-2-7 Password Change
- 2-3 Call Waiting
- 2-4 Sending Number
- 2-5 CUG



3 Call Charge

- 3-1 Call Duration
 - 3-1-1 Last Call
 - 3-1-2 All Calls
 - 3-1-3 Incoming Call
 - 3-1-4 Outgoing Call
 - 3-1-5 Reset
- 3-2 Call Costs
 - 3-2-1 Last Call
 - 3-2-2 All Calls
 - 3-2-3 Reset
- 3-3 Cost Settings
 - 3-3-1 Call Cost Limit
 - 3-3-2 Set Tariff
 - 3-3-3 Sum. After Call



4 Security

- 4-1 PIN Enable
- 4-2 Change Codes
 - 4-2-1 PIN1
 - 4-2-2 PIN2
 - 4-2-3 Security Code
- 4-3 Fixed Dial No.



5 Setting

- 5-1 Network Selection
 - 5-1-1 Automatic
 - 5-1-2 Manual
- 5-2 Phone Setting
 - 5-2-1 Alert
 - 5-2-2 Backlight
 - 5-2-3 Key Tone Volume
 - 5-2-4 Ring Volume
 - 5-2-5 LCD Contrast
 - 5-2-6 Ring Pattern
 - 5-2-7 Language
 - 5-2-8 Welcome Display
 - 5-2-9 Standby Display
- 5-3 Call Setting
 - 5-3-1 Any Key Answer
 - 5-3-2 Auto Redial
 - 5-3-3 Call Mode
 - 5-3-4 Auto Answer
- 5-4 Time Setting
 - 5-4-1 Clock
 - 5-4-1-1 Set Time

- 5-4-1-2 Set Time Format
- 5-4-2 Date
- 5-4-2-1 Set Date
- 5-4-2-2 Set Date Format
- 5-4-3 Alarm
- 5-4-3-1 Set Alarm
- 5-4-3-2 Cancel Alarm
- 5-4-3-3 Power Off Alarm
- 5-5 Profiles



6 Accessories

- 6-1 Scheduler
- 6-1-1 View day
- 6-1-1-1 Delete
- 6-1-1-2 Edit
- 6-1-1-3 Send Note
- 6-1-2 Make
- 6-1-2-1 Schedule
- 6-1-2-2 Call
- 6-1-2-3 Memo
- 6-1-2-4 Anniversary
- 6-1-3 Delete
- 6-1-3-1 Of Chosen Day
- 6-1-3-2 One by One
- 6-1-3-3 All At Once
- 6-1-4 View All
- 6-2 World Time
- 6-3 Calculator
- 6-4 Unit Convert
- 6-4-1 Length
- 6-4-2 Weight
- 6-4-3 Volumes
- 6-4-4 Surface
- 6-5 Game
- 6-5-1 Corsair
- 6-5-2 Crazy Race
- 6-5-3 Diamond King
- 6-5-4 Stone Axe
- 6-5-5 Black Jack





7 Voice Dial

- 7-1 Training
- 7-2 Search
 - 7-2-1 Voice Search
 - 7-2-1-1 Edit Voice
 - 7-2-1-2 Edit Number
 - 7-2-1-3 Delete
 - 7-2-2 Number Search
 - 7-2-2-1 Edit Voice
 - 7-2-2-2 Edit Number
 - 7-2-2-3 Delete
- 7-3 Setting
 - 7-3-1 Enable
 - 7-3-2 Disable
- 7-4 Delete all











8 Internet

- 8-1 Home
- 8-2 Bookmarks
 - 8-2-1 Go to
 - 8-2-2 Edit
 - 8-2-3 Erase
 - 8-2-4 Add Bookmark
- 8-3 Profiles
- 8-4 Empty cache

Your phone offers the functions which allow you to tailor the phone to your needs. These functions are arranged in menus and submenus. The menus and submenus can be accessed by scrolling  and  or by using appropriate shortcut.

Menu Navigation by scrolling

The Main menu gives you access to all the other menus.

1. Press  or  to reach the desired main menu (e.g. Security). Then press  [Menu] to enter the main menu; on the contrary, press  [Back] to get out of the menus.
2. If you want to enter the submenu, find the one you want by pressing  or . And press  [OK] to enter the submenu, press  [Back] to exit the submenu.

Shortcuts into Menus

When you know the menu numbers, you can use them to get into a menu quickly. In this book, the menu numbers are shown like this.

1. Press  [Menu].
2. Key in quickly the index number of the menu function you want to access.

For example, to set on the anykey function :

 : for **Entering the menu.**

 : for **Setting.**

 : for **Call Setting.**

 : for **Any Key Answer.**

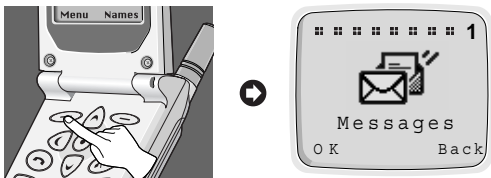

This menu in your phone includes functions related to text message, voice message, cell broadcast message, as well as setting for message.





Write Message [Menu 1-1]

With the **Write Message** menu, you can write and edit text message up to 160 characters. When you have finished writing your message, press  [Opt]. Then following menu will be displayed.

■ **Send : Sends the edited message.**

1. Once you enter this menu, your phone asks you to enter the number that you want to send it to.
2. After sending it, your phone asks whether you will store the edited message.
3. Press  [OK] if you want to store it in Outbox and press  [Back] if you don't want to.

■ **Store : Stores the message in Outbox.**

1. Your phone asks whether you will store the edited message or not.
2. Press  [OK] if you want to store it in Outbox and press  [Back] if you don't want to.

■ **Edit eZi Mode** : If you select this, you can write a message by eZi text input method.





■ **Edit LTR Mode** : If you select this, you can write a message in letter mode.



■ **Edit Num Mode** : If you select this, you can write a message in numeric mode.

- **Dictionary** : In this option, you can add or delete a word to user's dictionary.
 1. Press  [Opt] key after entering word you want, then you can see the following menu.
 - Add to UPD**
 - Del from UPD**
 2. Select **Add to UPD** if you want to add the word entered before in the user's dictionary of current selected eZi language. This word will be searched by the eZi when you edit in eZi mode.
 3. Select **Del from UPD**, if you want to delete word entered before in the user's dictionary or current selected eZi language.

The added word will be searched by the eZi when you edit in eZi mode.
- **List Dictionary** : If you select this, you can see additional words in user dictionary of current selected eZi language. Select a word which you want to edit or delete, and you can select to add or delete new edited word in the following the menu.

Outbox [Menu 1-2]

When you enter this menu, you can see the stored messages. Scroll to the desired message by using ,  and you can see upper or lower page using , . And if you want to exit Outbox menu, press  [Back].

If you want to edit the message, press  [Edit] and you can edit the message selected. When you have finished editing the message and press the  [Opt], you can show the next menu: **Send, Save, Delete, Delete all**.

■ **Send:**

You can send the selected message. The sequence is identical with Send option in Write message.

■ **Save:**



You can save the selected message. The sequence is identical with Save option in Write message.

■ Delete:







The message is deleted.

■ Delete all:

All messages in Outbox will be deleted. In this menu, your phone will ask you if you really want to delete all messages for safety. Then press

 [OK] to remove all messages, and press  [Back] if you don't want to.



Inbox [Menu 1-3]

When a text message is received, your phone shows  and stores it in the incoming message list. It shows the symbol until you read the message. Once you enter this menu, you can see the last received message. Scroll to the desired message by using ,  and see upper or lower page by using , . If you want to exit Inbox menu, press  [Back]. While reading message, press  [Opt] to access the available options.

■ Delete:

The message is deleted.

■ Reply:

You can reply to the sender by message. Once you enter in this menu, you can edit the message you want to send and press  [OK] to send it or press  [Back] to cancel it.

■ Forward:

You can forward the selected message to another phone number. In this menu, your phone asks you to enter the number and then sends it.



■ Return Call:

You can call back to the sender who sent the message. If you select this item, your phone will dial automatically.

■ Extract Number:

If the selected message has a phone number within “ ”, you can not only extract it but also store it in a phone book.







■ Delete all:

All messages in Inbox will be deleted. Your phone asks you if you really want to delete all messages for safety. Then press  [OK] to remove them, and press  [Back] if you don't want to.

Status Report [Menu 1-4]

You can receive a status report for sending message by setting it. When you receive a text message of status report, your phone stores it in the status report message lists.



If the memory for status report is full, the phone will delete the oldest status report automatically and store the latest status report.

Once you enter this menu, you can see the previous stored status report. Scroll to the desired message by using ,  and see upper or lower page by using , . And if you want to exit Status Report menu, press  [Back]. While reading message, press  [Opt] to access the available options.

■ Delete

The selected status report message is deleted.

■ Delete All



All messages in Status Report will be deleted. Your phone asks you if you really want to delete all messages for safety. Then press  [OK] to remove all messages, and press  [Back] if you don't want to.

Call Voicemail [Menu 1-5]

In this menu, you can listen to your voice messages. If your phone stores voice message centre address, it will call automatically, otherwise, it will ask to enter address.

Cell Broadcast [Menu 1-6]

Cell broadcast messages are text messages broadcasted by the network to groups of GSM phone users. They provide general information such as weather reports, traffic news, and stock market prices. Each type of information has an associated information type number. When you receive broadcast message, you can read it following sequence :





1. When you receive broadcast message, it is automatically displayed on the window. If the message is so long that cannot be displayed all in a window, you can read it by scrolling  and .
2. After reading the message, press  [OK] to return to the Idle mode.
3. Your phone will store it until a new message of the channel is reached.
4. If you want to read it again, see the [Menu 1-6-2](Read).

■ CB Option [Menu 1-6-1]

- **On [1-6-1-1]** : If you select this menu, your phone will receive Cell Broadcast messages.
- **Off [1-6-1-2]** : If you select this menu, your phone will not receive the Cell Broadcast messages anymore.

■ Read (Dependent on network and subscription) [Menu 1-6-2]

You can read the stored broadcast messages in this menu. In addition, your phone stores only the last message of each channel.

1. If you select this menu, your phone will display the message.
2. You can read it. If it is so long that cannot be displayed in a screen, scroll by pressing  and .
3. After reading, press  key to read next message, and press  [Exit] to exit this menu.



■ Topics (Dependent to network and subscription) [Menu 1-6-3]

SIM

If you select this menu, you can add or delete the CB message category in SIM memory. If you select the **Add** menu, you can enter the only category numbers which consists in a pair of number.

If you select **Delete** menu, you can see the list of CB message category and delete it by using  [Delete].

Phone

If you select this menu, you will add, select and delete the CB message category in Phone memory. If you select the **Add** menu, you will add the CB message category numbers with its nickname. If you select **Select** menu, you can see the list of CB message category numbers with its nickname and select them by using  [OK] to activate or deactivate them. If you select the **Delete** menu, you can see the list of CB message category numbers with its nickname and an delete them by using  [Delete].

■ Languages [Menu 1-6-4]

You can select languages in this menu. Then your phone will receive the cell broadcast messages written in the selected language.

1. In this menu, you can see several languages. (e.g.- English, French, ...)
2. Scroll to highlight the language you want, select on/off.
3. You can select more than one item through the procedure of 1~2.

Memory Status [Menu 1-7]

If the user selects this menu, the phone shows an used memory and total amount of memory. The total memory is sum of SIM and Phone memory.

Setting [Menu 1-8]

■ Status Report [Menu 1-8-1]

In this menu, you can set the message service to receive messages which will be sent. This report is represented whether the message is sent to destination successfully or not.

- **On** : If you select this menu, you will receive the status report of message.
- **Off** : If you select this menu, you will not receive the status report of message.

■ Message Type [Menu 1-8-2]

:Text, Voice, Fax, X.400, E-mail, ERMES

Usually, this menu choice should be set to “Text”. Your message service may, however, offer you the facility of converting your text message into alternative formats which are suitable for the equipment that will be received messages. Contact your service provider for the availability of this function.

■ Expiry Period [Menu 1-8-3]

This network service allows you to set how long your text messages will be stored at the message centre while attempts are made to deliver them to you: **1 hour, 6 hours, 12 hours, 1 day, 2 days, 1 Week, Max.**

■ SMS Centre [Menu 1-8-4]

In this menu, your phone asks for the address of your SMS centre. This is needed for sending text messages.

■ Voice Centre [Menu 1-8-5]

In this menu, your phone asks to enter the number for your voice message. This is needed for listening to your voice messages.

■ Alert [Menu 1-8-6]

The user can set how many times and how often the phone alerts the user to incoming messages.

Use the “Call Option” menu to access supplementary services provided by the GSM network.

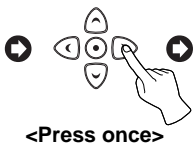
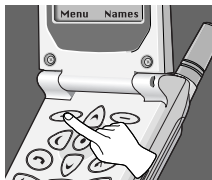

! Note

- The Call Divert, Call Barring, and Call Waiting menus each contains an option for displaying the current status of the service. This function makes a call to the network. This call may be charged to you. Check with your service provider.

Call Divert [Menu 2-1]

(network and subscription dependent)





The Call Divert service diverts incoming voice calls, fax calls, and/or data calls to another number.

1. Press [Menu] in a standby mode.
2. Press for direct access or use and to enter Call Option.
3. Select **Call Divert** menu and press [OK] to enter.
4. Select **Voice Calls**.





■ Voice Calls [Menu 2-1-1]

- **Divert All Voice Calls** : Divert calls unconditionally.
- **Divert if not Reachable** : Divert calls when the network cannot reach you.
- **Divert if Busy** : Divert calls when the phone is busy.
- **Divert if No Reply** : Divert calls which you do not answer.
- **Cancel All** : Only cancel voice call divert.





■ All Data Call [Menu 2-1-2] : Divert all data calls unconditionally.

1. Press  [Menu] in a standby mode.
2. Press  for direct access or use  and  to enter Call Option.
3. Select **Call Divert** menu and press  [OK] to enter.
4. Select **All Data Call**.

■ All Fax Call [Menu 2-1-3] : Divert all fax calls unconditionally.

1. Press  [Menu] in a standby mode.
2. Press  for direct access or use  and  to enter Call Option.
3. Select **Call Divert** menu and press  [OK] to enter.
4. Select **All Fax Call**.





■ Cancel All [Menu 2-1-4] : Cancel all voice, data and fax call divert.

1. Press  [Menu] in a standby mode.
2. Press  for direct access or use  and  to enter Call Option.
3. Select **Call Divert** menu and press  [OK] to enter.
4. Select **Cancel All**.

Call Barring [Menu 2-2]

(network and subscription dependent)





The Call barring service prevents your phone from making and/or receiving certain categories of calls. This function requires the call barring password obtained from your service provider.

1. Press  [Menu] in a standby mode.
2. Press  for direct access or use  and  to enter Call Option.
3. Scroll to highlight **Call Barring** menu and press  [OK] to enter.
 - **All Outgoing Calls** : The barring service of all outgoing calls.
 - **Outgoing International Calls** : The barring service of outgoing international calls
 - **Outgoing International except Home** : The barring service of all international outgoing calls,except to your home network.
 - **All Incoming Calls** : The barring service of all incoming calls.
 - **Incoming Calls When Roaming** : The barring service of all incoming calls when roaming.
 - **Cancel All** : Only cancels the barring service of voice call.
 - **Password Change** : Changes Call Barring password.

Call Waiting [Menu 2-3]

(network and subscription dependent)

Activate or deactivate the Call Waiting service. If this service is activated, the user can accept a waiting(incoming) call. If this service is deactivated, the user cannot accept a waiting(incoming) call and cannot recognize it.





1. Press  [Menu] in a standby mode.
2. Press  for direct access or use  and  to enter Call Option.
3. Scroll to highlight **Call Waiting** menu and press  [OK] to enter.

Sending Number [Menu 2-4]

(network and subscription dependent)

This menu is valid only when the user subscribes temporary mode.





If you Select **On**, you allow your phone number to be displayed to the other party. Also, you can change this mode On/Off you want.

1. Press  [Menu] in a standby mode.
2. Press  for direct access or use  and  to enter Call Option.
3. Scroll to highlight **Sending Number** and press  [OK] to enter.

Closed User Group [Menu 2-5]

(network dependent)

Use this function to restrict usage of the phone to calls with numbers that belong to certain user groups. When this function is used, every outgoing call is associated with a group index. If a group index is specified, it is used for all outgoing calls. If no group index is specified, the network will use the preferential index (a specific index that is stored in the network).

1. Press  [Menu] in a standby mode.
2. Press  for direct access or use  and  to enter Call Option.
3. Scroll to highlight **CUG** and press  [OK] to enter.

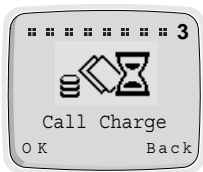
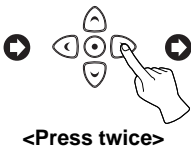
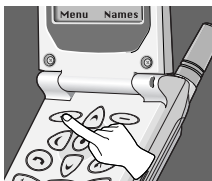

Call Duration [Menu 3-1]

This function allows you to view the duration of your Last Call, All Calls, Incoming Call and Outgoing Call in hours, minutes and seconds. You can also clear the call timers.

1. Press [Menu] in a standby mode.
2. Press for direct access or use and to enter Call Charge.
3. Select **Call Duration** and press [OK] to enter.
4. This menu has 5 submenus. You can choose the item that you want to see.

Call Costs [Menu 3-2]

This network service allows you to check the costs of your last call or all calls and clear the counters. To clear the counters you need the PIN2 code. The Costs are shown for each SIM card independently in terms of the unit set within [Menu 3-3-2].

Note

- The actual cost invoiced for calls by your service provider may vary depending upon network features, rounding-off for billing, taxes, etc.

1. Press [Menu] in a standby mode.
2. Press for direct access or use and to enter Call Charge.
3. Scroll to highlight **Call Costs** and press [OK] to enter.
4. This menu has 3 Submenus. Select the item that you want to.





Cost Settings [Menu 3-3]

(SIM dependent)

■ Call Cost Limit [Menu 3-3-1]





This network service allows you to limit the costs of your calls to a selected number of charging units. If you have selected **On**, you can set cost limit in terms of unit and use your phone to a selected number of charging units. If you have selected **Off**, you can use your phone without cost limitation. When all units have been used, no calls can be made except emergency calls.

To set a call cost limit, you need the PIN2 code.

1. Press  [Menu] in a standby mode.
2. Press  for direct access or use  and  to enter Call Charge.
3. Scroll to highlight **Cost Settings** and press  [OK] to enter.
4. Select **Call Cost Limit** to enter.



■ Set Tariff [Menu 3-3-2]

You can set currency name and unit price. Contact your service provider to set the chargeable unit prices. To select the currency or unit in this menu, you will need the PIN2 code.

1. Press  [Menu] in a standby mode.
2. Press  for direct access or use  and  to enter Call Charge.
3. Scroll to highlight **Cost Settings** and press  [OK] to enter.
4. Select **Set Tariff** to enter.

■ Sum. After Call [Menu 3-3-3]

You can check the duration and the cost of call during a call or after ending a call if you set **On**.

1. Press  [Menu] in a standby mode.
2. Press  for direct access or use to enter Call Charge.
3. Scroll to highlight **Cost Settings** and press OK to enter.
4. Select **Sum After Call**.

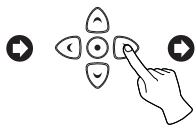
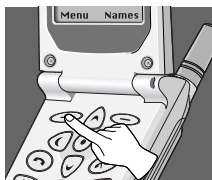



<Press three times>





PIN Enable [Menu 4-1]

Within this menu, you can set the phone to ask for the PIN code of your SIM card when the phone is switched on. To use this function, you will be requested to enter the PIN code.

1. Enter this menu by selecting **PIN Enable**. Then your phone requests to enter PIN code if PIN request is enabled.
2. Key in your PIN code.
3. Press  [OK] to verify entered PIN code, and press  [Back] to erase a character you entered.
4. Then following menu will be displayed.
 - **Enable** : Enable PIN code request.
 - **Disable** : Disable PIN code request.

Change Codes [Menu 4-2]

This menu provides you with the function of changing access codes : **PIN1**, **PIN2 code**, and **Security code '0000'**.

1. Enter this menu by selecting **Change Codes**.
2. And select **PIN1**, **PIN2**, or **Security Code**.
3. Input your original PIN codes and press  [OK].
4. Your phone asks you to enter the PIN1/PIN2 code or Security Code which would replace ones and press  [OK]. Then phone requests the new PIN codes or Security Code again.
5. If you key in correct original PIN1/PIN2 code or Security Code and make correct confirmation for new ones, they will be changed.

Fixed Dial Number [Menu 4-3]

You can restrict your outgoing calls to selected phone numbers, if this function is supported by your SIM card. These numbers are protected by your PIN2.

1. Enter this menu by selecting **Fixed Dial No.** Your phone will request the PIN2 code.
2. Key in your original PIN2 code and press  [OK]. If you key in PIN2 code is correct, following menu will be displayed.
 - **Enable** : Providing the function for you of restricting your outgoing calls to selected phone numbers, if it is supported by your SIM card.
 - **Disable** : No restriction on outgoing calls.
 - **Number** : Allows to add, to edit and to delete the Fixed Dial Number.

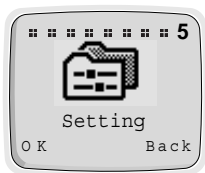
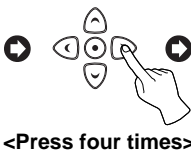

Network Selection [Menu 5-1]

You can select the network which you will be registered either automatically or manually.

■ Automatic [Menu 5-1-1]

The phone automatically selects network which is available in the area.



■ Manual [Menu 5-1-2]

The phone will find the list of available networks and show it to you. Then you can select the network which you want to use if this network has a roaming agreement with your home network operator.

Phone Setting [Menu 5-2]

■ Alert [Menu 5-2-1]

This setting defines how the phone will notify you about an incoming voice call: **Ring**, **Vibrate**, **Vibrate & Ring**, **Ring After Vibrate**, and **Silent**. Once you select this menu, the following is possible.

This phone shows the menu : Ring, Vibrate, Vibrate & Ring, Ring After Vibrate, Silent by pressing  and  and select one.

■ Backlight [Menu 5-2-2]

You can set how long you want the keypad and display to light up each time you press a key : **Off**, **Always Open Flip**, **20 seconds**, **10 seconds**, **5 seconds**.

■ Key Tone Volume [Menu 5-2-3]

You can set the volume level for the pressed key tone : **Level 1~5, and Off.**

■ Ring Volume [Menu 5-2-4]





You can set the volume level for the ringing tone : **Level 1~5, and Off.**

■ LCD Contrast [Menu 5-2-5]

You can set the color contrast of the characters on the LCD: Value 0~9.

■ Ring Pattern [Menu 5-2-6]

If you select this menu, you can select the various ring pattern and ring tone.

1. Enter this menu. Your phone will ask to select the ring tone and the ring pattern.
2. Your phone shows the list of ring pattern. Select one out of them by pressing  ,  . Also, you can change the ring tone by pressing  ,  .

■ Language [Menu 5-2-7]

This menu provides you with selection of the language in which the display texts will be shown. If the setting Automatic is selected, the language used is chosen based on the current SIM card. English will be used if the language on the SIM card is not found in the phone.

■ Welcome Display [Menu 5-2-8]

This menu allows you to set the text or animation which is shown briefly when the phone is switched on.

1. Scroll to highlight **Welcome Display**.
2. Then following menu will be displayed.
 - **Text** : Your own text can be displayed. If you select this item, your phone asks you to edit the message.
 - **Animation** : Animation will be displayed.

■ Standby Display [Menu 5-2-9]

This menu allows you to select the standby window display. You can select one out of **Zodiac (User Own, Monthly)**, **Digital Clock**, **Analog Clock**, **Normal**, and **Text**. In text mode, you can edit the text.

Call Setting [Menu 5-3]

■ Any Key Answer [Menu 5-3-1]

- **On** : If you select this, you can answer the phone either by opening the folder or pressing any keys except END/PWR key while folder is opened.
- **Off** : If you select this, you can answer the phone only by pressing .

■ Auto Redial [Menu 5-3-2]

- **On** : When this function is set on, your phone will make up to 10 attempts to connect the call after an unsuccessful call attempt.
- **Off** : When this function is set on, your phone will not make any attempts to connect the call after an unsuccessful call attempt.

■ Call Mode [Menu 5-3-3]

In this menu, you can use the phone and a connected PC to send and receive faxes, data, and voice. Once you enter this menu, the following options are displayed.

- **Single Mode :**
To use a data or a fax service, make sure that call mode is **Single mode**. In this mode, you can communicate voice, data or fax.
- **Voice and Fax :**
In this mode, you can transmit voice and also fax.
- **(SINGLE NUMBER) RX VOICE AND FAX**
- **(SINGLE NUMBER) RX FAX**
- **(SINGLE NUMBER) RX DATA**

In case of single numbering service, you can use these modes. If you select mode, you can receive data, fax or fax with voice each mode.

! Notice

- Single numbering service means that the number of fax or data service is identical with the number of voice service. And, these modes depend on network feature.

■ Auto Answer [Menu 5-3-4]

This function will be activated only when your phone is attached to the Handsfree kit or Portable Handsfree.

- **Off** : When the phone rings, you must actively answer it.
- **5 Seconds** : After 5 seconds, your phone will answer automatically.
- **10 Seconds** : After 10 seconds, your phone will answer automatically.

Time Setting [Menu 5-4]

■ Clock [Menu 5-4-1]

The phone has its own clock. In this menu you can set the time and select between the 12-hour or 24-hour time formats.

- **Set Time** : You can set time of your phone in this menu. After setting the time, press  [OK] to store it.
- **Set Time Format** : You can select time format between 12-hours or 24-hours.

■ Date [Menu 5-4-2]

- **Set Date** : You can set the date on your phone.(year, month, day) The way to edit the date is identical to "Clock"
- **Set Date Format** : You can set the date format in this menu: yyyy/mm/dd or dd/mm/yyyy or mm/dd/yyyy.

■ Alarm [Menu 5-4-3]

Your phone can be used as an alarm. The setting is made by the same method as used in time setting.

- **Set Alarm** : You can set alarm which your phone will raise according to Hour and Minute.
 1. Select Alarm.
 2. Set the time your phone will raise the alarm. The way to edit time is identical to “Clock”.
 3. Then your phone raises alarm every day until you will cancel in following “Cancel Alarm”.
- **Cancel Alarm** : You can cancel the alarm which was set.
 1. In this menu, you may select the alarm which you will cancel.
 2. Then your phone cancels alarm.
- **Power Off Alarm** : The alarm signal sounds at the time set, even if the phone is turned off.

Profiles [Menu 5-5]

In this Menu, You can select a group of settings to adjust a variety of environments. (e.g. When you are in outdoor, you can choose the outdoor profile, Etc) Environments are Normal, Silent, Outdoors, and User Own.

A group of settings are Alert, Key Tone Volume, Ring Volume.

■ Normal/Silent/Outdoors

- **Activate** You can adjust the profile as environments. Alert, Key Tone Volume, and Ring Volume are set simultaneously.
- **Change** You can change the value of settings. ; Alert, Key Tone Volume, Ring Volume.

■ User Own

- **Edit Name** You can edit Profile Name.
- **Activate** You can adjust the profile as your own environment.
- **Change** You can change the value of settings.

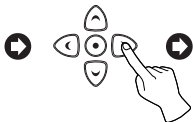
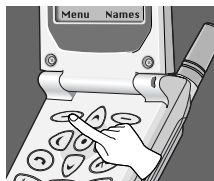

<Press five times>

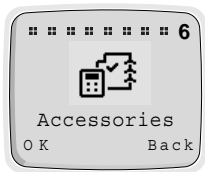

Scheduler [Menu 6-1]

When you enter this menu, a Calendar will be displayed. On top of the screen there are sections for date and icons. You can change the day, month and year by using navigation keys and numeric keys. A square cursor will highlight the selected day. An underscore on a particular date means there is an entry for that day. An alarm can be set to remind you of scheduled events.

! Note

- Your phone should be switched on to use this function.





■ View day

Shows notes set for the chosen day. Use \triangle , ∇ to browse through the note(s). If you set alarm for the note, alarm watch is displayed. Press \ominus [Opt] to delete, edit, send note you select.

- Delete** : allows you to delete the note.
- Edit** : allows you to edit the note.
- Send Note** : allows you to send the note as Short Message (SMS). For details see Messages [Menu 1].

■ Make

Allows you to write a note. You can choose the following types of note. You can edit a maximum of 40 characters, and make a maximum of 50 schedules.

- **Schedule** : Input the subject time and alarm time and the press  [OK].
- **Call** : Input the phone number(or recall it from the Phone Book), the time and alarm time and then press  [OK].
- **Memo** : Input the subject and alarm time and then press  [OK].
- **Anniversary** : Input the subject time and alarm time and then press  [OK]. You can select a title from the submenu **Birthday, Wedding, Memorial, Etc.**

■ Delete

Allows you to delete for the selected note(s).

- Of Chosen Day
- One by One
- All At Once

! Note

- On the selected date, the alarm will sound and the note will be displayed.

■ View All

Shows the notes that are set for all days. Use \triangleup and \triangledown to browse through the note(s). Pressing \ominus [opt] allows to access to the same menu as in 'View day'.

World Time [Menu 6-2]

This function shows the world map, cities and local time. The Current time is displayed according to time format(12/24 Hours). Press \triangleleft , \triangleright to change the time zone and \triangleup , \triangledown to browse city names. Press \ominus [Set] to set your phone time to the local time of the selected city.

Calculator [Menu 6-3]

This function supports basic mathematical calculations such as addition, subtraction, multiplication and division.

1. Input the numbers you want to calculate.
2. In order to select the function, use \triangleleft and \triangleright . The selected operator will be highlighted with square cursor. Press \otimes [Easy Key] to make sure your choice.
3. When you have finished the calculation, you can choose "=" operator or \ominus [Result] key to see the result.

Unit Convert [Menu 6-4]

1. Select the menu items that you want to convert.
Length, Weight, Volumes, Surface.
2. Put the numbers to convert by using \triangleleft and \triangleright and numeric keys.
3. And select the unit which is related to the current value.
4. Finally select the unit which you want to convert current value to.
5. Then required value and unit will be displayed.

Game [Menu 6-5]

The following games are programmed in the phone.

- Corsair
- Crazy Race
- Diamond King
- Stone Axe
- Black Jack





Note

The Control keys are different for each game.

But each game has screens to explain the main control key.

Other common control keys are below.

[Common Key Function]

-  [Soft 1 Key] : Pause Game
-  [Soft 2 Key] : Continue Game
-  [Send Key] : Start Game, Save Score
-  [Power Key] : Exit Game

PC Sync

PC Sync is a program for data exchange PC & Phone by data cable.

Therefore, if you want to use this function, you have to purchase accessory kit. About more detail for using guide refers to PC Sync help file on the PC Sync CD.

You can dial a number by speaking to your GSM Phone.

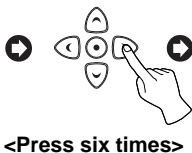

Training [Menu 7-1]

You can programme your phone to associate a voice tag with the number which will be entered. Once you select this menu, you should speak a word within 2 seconds, and the phone asks you to speak it again to ensure the accuracy of voice recognition. After voice recognition has finished, you can enter the associated number.

Search [Menu 7-2]

You can use this menu to edit, delete, and ensure what voice exists.



■ Voice Search [Menu 7-2-1]

You can find the number you want by voice.

The procedure is similar except the result. The result is another menu.

- **Edit voice** : You can change a voice tag. It is similar to training except putting the number.
- **Edit number** : You can change a number. It will show the number related with the voice tag. After editing it, press  [OK].
- **Delete** : You can delete the voice tag and number.

■ Number Search [Menu 7-2-2]

You can find the only numbers recorded by number. You don't have to type all numbers. It will show the numbers including part for to type in. You can hear the voice and see the number using  and . You can hear the voice positioned the number by pressing  on the side of the phone. The submenus are same to Voice Search submenu.

Setting [Menu 7-3]

- **Enable** : You can call by voice if you select this function.
- **Disable** : You cannot call by voice.

Delete all [Menu 7-4]

This menu provides you with the ability of deleting all voice dial numbers.

You can surf the Internet and get the latest information. This information is made available in a special format (WAP) adapted to the display options available in the phone. Accessing the Internet may be required registration with your Service Provider.

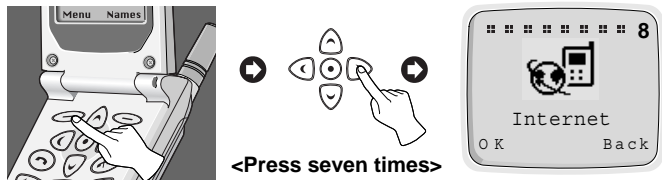

Home [Menu 8-1]

Return to homepage. The homepage may be the site which is defined in activated profile by your service provider.

To activate WAP, either press key for a few seconds in Standby mode or press [OK] button in Home menu [Menu 8-1].

Bookmarks [Menu 8-2]

When you enter this menu, your personal list of bookmarks will be displayed. Also, you can save bookmarks up to 9. Then press [OK] to access available option, or press [Back] to exit it.

- **Go to** : Move to selected bookmarks.
- **Edit** : Edit the address and title of selected bookmark.
- **Erase** : Erase selected bookmarks from the bookmark list.
- **Add Bookmark** : Edit the address and title of the site which you want to add your favourite bookmark list.

Profiles [Menu 8-3]

Display or enter your own profile settings for the internet connection. You can make up to 5 profiles and activate the required option. Scroll to desired profile and press  [OK] to access available options.

- **Activate** : Activate the selected profile.
- **Setting** : Set the profile details.
 - **Profile Name** : Edit the Profile Name.
 - **Dial-up Number** : Edit the data call number.
 - **Call type** : Select the call type.
 - **IP Address** : Edit the IP address of gateway which you want to connect to.
 - **IP Port** : Edit the IP port number of gateway which you want to connect to.
 - **Log-in name** : Edit the login name of the homepage defined in selected profile.
 - **Password** : Edit the password of the homepage defined in this profile.
 - **Homepage** : You can edit the address of site. This address will be connected when you select the menu Internet - Home or start Internet through .

Empty Cache [Menu 8-4]

Your phone will remove the contents of Cache memory.

■ Home

Refers to [Menu 8-1].

■ Bookmarks

Refers to [Menu 8-2].

■ Save as Bookmark

You can add the site which your phone is connecting to bookmark list in this menu.

■ Go to URL

Moves to the site you require. In this menu, you can edit the site address.

■ Show URL

In this menu, it will show you the URL of current connected page.

■ Reload

Reloads current connected page.

■ Empty Cache

Refers to [Menu 8-4].

■ Exit

Disconnects and exits WAP.

Some telephone services (such as telephone answering machine and pager) require your telephone to transmit DTMF tones (Dual Tone Multi-Frequency), also known as “touch tones”. These are used to communicate passwords, call back numbers, and so on.

Wait Characters

To obtain a wait character, press and hold . The display shows **P** for a wait. The phone always interprets the **P** as a wait character.

When you dial a number containing a wait character, your phone dials the first part (the phone number) and then waits for the call to be connected before sending the rest of the digits as DTMF tones.

Interrogating your Answering Machine (example)

For example: To hear all messages on your answering machine (password 5452) at phone number 12345678, you can call: 12345678P5452. The phone dials 12345678 and waits for the call to connect. When connected, the phone transmits 5452 (the password).

During a Call

When you need to send DTMF tone, just press the numbers, then DTMF tone will be sent.

The phone provides a number of control functions that you can use during a call. You cannot utilize all of these functions at all times. Most of the In-Call options are network services. By pressing  [Opt] during a call, the following In-Call options may be available:

■ Hold Call

(network dependent)

During a call, you can put an active call on hold.

1. During a call, press  [OK] to enter In-Call Option.
2. Select **Hold Call** to put an active call on hold.

■ Retrieve Call

(network dependent)

If you have a call already on hold, you can retrieve that call.

1. During a call, press  [OK] to enter In-Call Option.
2. Select **Retrieve Call** to retrieve a held call.

■ Swap Call

(network dependent)



When there are an active call and a held call, this menu places the active call on hold and the Held call on active. You may swap back and forth required.



1. During a call, press  [OK] to enter "In-Call Option".
2. Select **Swap Call** to swap an active call and a held call.

■ Conference Call

(network dependent)

This feature allows up to six persons to take part in a conference call (network dependent.).

1. While in a call, dial phone number and press . The first call is put on hold.
2. To join the first conference participant in the call, press  [Opt], choose conference call, select join and press  [OK].

3. To add a new participant to the call, repeat steps 1 and 2.
4. To drop a single participant from the call, press  [Opt], choose conference call, select private and press  [OK]. Select the participant that you want to drop and press .
5. To end the conference call, close the flip.

■ Disconnect

You can disconnect the call that is already on hold, currently active and all calls by scrolling up and down the menu items such as Active call, Hold call, and All calls.

- Active call
- Hold call
- All calls

■ Mute On

If this function is selected, the other party cannot hear you but you can hear the other party's voice. When the call is disconnected, the Mute Off will be activated automatically. Default Setting is Mute Off.

1. During a call, press  [Opt] to enter In-Call Option.
2. Select **Mute On** to mute your phone.

■ Mute Off

If this function is selected, the other party can hear you. Default Setting is Mute Off.

■ DTMF On

If this function is selected, you can send DTMF tones. Default Setting is DTMF ON. For details, see how to send DTMF.

1. During a call, press  [Opt] to enter In-Call Option.
2. Select **DTMF On** to send DTMF tones.

■ DTMF Off

If this function is selected, you cannot send DTMF tones. Default Setting is DTMF ON.





1. During a call, press  [Opt] to enter In-Call Option.
2. Select **DTMF Off** to prohibit from sending DTMF tones.

■ Scratch PAD

You can take a note(phone number) while a call is in a progress by using this function. After disconnecting the call, the phone number will be displayed on the screen and you can save it a phonebook and connect a call by pressing .

1. During a call, press  [Opt] to enter In-Call Option.
2. Select **Scratch PAD** to take a note(phone number).

■ Recording

When you need to record your call, press and hold  then your call will be recorded. To stop the recording, press ,  or just close the flip. To play back your recordings, see the <Voice Memo> section. For details, see <Voice Memo>. During a call, press and hold  on the right side of the phone.

■ Message

If you select this function, you can go to the message menu [Menu 1]. For details see <Message> [Menu 1].

1. During a call, press  [Opt] to enter In-Call Option.
2. Select **Message** to send message.

■ SIM SERVICE

Your service provider can offer special application through SIM card, such as homebanking, stock market, etc. If you are registered for one of these services, the service name will appear at the end of the Main Menu. With the SIM Services menu your phone is future-proof and will support additions to your service provider's service. For further information contact your service provider.

To be able to data or fax service, you need the communicate software such as a data or a fax program. Before using these functions, you need to connect your phone to a computer or make sure that your phone is in connection with a compatible device.

Making a Data or Fax call

To use a data or a fax service, make sure that call mode is “single mode” (Setting → Call Setting → Call Mode → Single Mode). In this mode, you can communicate voice, data or fax. If you set call mode to be “voice & fax mode” (Setting → Call Setting → Call Mode → Voice & Fax mode), you can transmit voice and fax without voice call release.

■ Sending a data or fax call

1. Connect your computer to the phone.
2. After starting the communicate software, make a call and transmit a data or fax.
3. After the data or fax transmission, you can end the call by just ending of the communicate software, pressing  or by closing the flip.

■ Receiving a data or fax call

1. Connect your computer to the phone.
2. After starting the communicate software, accept a call and receive a data or fax.
3. After the data or fax reception, you can end the call by just ending of the communicate software, pressing  or by closing the flip.



Making a Voice & Fax call

In this mode, you can transmit voice and also fax without voice call release.

Note

- This mode is network feature. If the network doesn't support this mode, you can't use a voice & fax call.

■ Sending voice and fax calls



1. Connect your computer to the phone.
2. Select **Voice and Fax mode**. **Voice and fax mode** allows you to switch from voice mode to fax mode during call.
3. If **Selected** message is displayed in phone, it is ready for transmission.
4. Key in or recall the desired phone number and press .
5. After the voice transmission, you can start a fax transmission.
6. After the fax transmission, you can end the call by just ending of fax software, pressing  or by closing the flip.

■ Receiving voice and fax calls





1. Connect your computer to the phone.
2. After the voice transmission, you can answer the fax call by starting the software program (if it does not answer automatically).

The voice memo features you to record up to 3 voice messages and each one is up to 30 seconds. This is useful when you don't have a pen and paper to hand for taking directions or a messages.

Voice Memo

1. To use this function, press  [Record Key] for a long time during a call or in a standby mode.
2. Recording is started and display will show the message **Recording** and the recording time.
3. If you want to finish recording, press  [Record Key] shortly.

Voice Memo Menu

The phone shows voice memo information which includes the recording time and date by pressing  [Record Key] for a short time. After you selected the memo by using  and  , press  [Opt], you can see this menu.

■ Play [Voice Memo Menu 1]

You can play the selected voice memo in this menu. Also, you can hear your voice memo through speaker on the rear of the phone.

■ Delete [Voice Memo Menu 2]

You can delete the selected voice memo.

■ Delete All [Voice Memo Menu 3]

Your phone will delete all recorded voice memos.

When using this unit, basic safety precautions as below should be always followed.

- Do not touch the adapter with wet hands.
- Do not disassemble this unit. (Take it to a qualified service technician when repair work is required.)
- Away from electrical appliance such as a TV, radio or personal computer.
- The unit should be situated from heat sources such as radiators or cookers.
- Do not drop.
- Do not subject this unit to mechanical vibration or shock.
- The coating of the phone may be damaged if covered with wrap or vinyl wrapper.
- Use dry cloth to clean the exterior of the unit. (Do not use solvent such as benzene, thinner or alcohol.)
- Do not subject this unit to excessive smoke or dust.

■ Caring for the Battery

- You do not need to completely discharge the battery before recharging. Unlike other battery systems, there is no memory effect that could compromise the battery's performance.
- Use only LG batteries and chargers. LG chargers are designed to maximize the battery life.
- Do not disassemble or short-circuit the battery pack.
- Keep the metal contacts of the battery pack clean.
- Replace the battery when it no longer provides acceptable performance. The battery pack may be recharged hundreds of times until it needs replacing.
- Recharge the battery if it has not been used for a long time to maximize usability.
- Do not expose the battery charger to direct sunlight or use it in high humidity, such as the bathroom.
- Do not leave the battery in hot or cold places, this may deteriorate the battery performance.

General

Product Name : LG-600

System : GSM 900/DCS 1800

SIM Card : Small plug-in card, 3V or 5V type

Dimensions

Size : 109.5 X 46 X 19.8 mm

Weight with Standard battery : 93.6g

Ambient Temperatures

Max : +55°C

Min : -10°C

Free Manuals Download Website

<http://myh66.com>

<http://usermanuals.us>

<http://www.somanuals.com>

<http://www.4manuals.cc>

<http://www.manual-lib.com>

<http://www.404manual.com>

<http://www.luxmanual.com>

<http://aubethermostatmanual.com>

Golf course search by state

<http://golfingnear.com>

Email search by domain

<http://emailbydomain.com>

Auto manuals search

<http://auto.somanuals.com>

TV manuals search

<http://tv.somanuals.com>