



ENGLISH

ESPAÑOL

FRANÇAIS

OWNER'S MANUAL DRYER

Please read this manual carefully before operating your dryer and retain it for future reference.

DLEX5101W
DLEX5101V

DLGX5102W
DLGX5102V

INTRODUCTION

IMPORTANT SAFETY INSTRUCTIONS

| | |
|---|---|
| What to Do if You Smell Gas | 3 |
| Basic Safety Precautions | 4 |
| California Safe Drinking Water And Toxic Enforcement Act..... | 4 |
| Grounding Instructions..... | 5 |
| Safety Instructions for Installation..... | 5 |
| Safety Instructions for Steam Functions..... | 6 |
| Safety Instructions for Connecting Electricity | 7 |

PARTS AND FEATURES

| | |
|--------------------------------|---|
| Special Features..... | 8 |
| Key Parts and Components | 9 |

INSTALLATION INSTRUCTIONS

| | |
|--|----|
| Installation Location Requirements..... | 10 |
| Clearances | 10 |
| Leveling the Dryer | 11 |
| Reversing the Door..... | 12 |
| Changing the Dryer Vent Location | 13 |
| Venting the Dryer..... | 14 |
| Connecting Gas Dryers | 16 |
| Connecting Electric Dryers..... | 18 |
| Special Requirements for Manufactured or Mobile Homes..... | 23 |
| Final Installation Check | 23 |
| Duct Condition Test..... | 24 |

HOW TO USE

| | |
|---|----|
| Control Panel Features | 25 |
| Operating The Dryer | 26 |
| Cycle Guide..... | 27 |
| Sorting Loads..... | 28 |
| Loading the Dryer | 28 |
| Check The Lint Filter Before Every Load | 28 |
| The Display..... | 29 |
| Cycle Setting Buttons..... | 30 |
| Cycle Option Buttons | 31 |
| Custom Program..... | 31 |
| Steam Functions..... | 32 |
| Steam Cycle Guide | 34 |

USER MAINTENANCE INSTRUCTIONS

| | |
|-----------------------|----|
| Regular Cleaning..... | 35 |
|-----------------------|----|

TROUBLESHOOTING

| | |
|---------------------------------|----|
| Before Calling for Service..... | 36 |
|---------------------------------|----|

SPECIFICATIONS

| | |
|--|----|
| Key Dimensions And Specifications..... | 38 |
|--|----|

| | |
|----------------|----|
| WARRANTY | 39 |
|----------------|----|

THANK YOU!

Congratulations on your purchase and welcome to the LG family. Your new LG Dryer combines the most advanced drying sensor technology with simple operation and high efficiency.

Follow the operating and care instructions in this manual and your dryer will provide many years of reliable service.



IMPORTANT SAFETY INSTRUCTIONS

READ ALL INSTRUCTIONS BEFORE USE

⚠️ WARNING For your safety, the information in this manual must be followed to minimize the risk of fire or explosion, electric shock, or to prevent property damage, personal injury, or loss of life.

Your Safety and the safety of others is very important.

We have provided many important safety messages in this manual and on your appliance. Always read and obey all safety messages.



This is the safety alert symbol.

This symbol alerts you to potential hazards that can kill or hurt you and others.

All safety messages will follow the safety alert symbol and either the word DANGER or WARNING.

These words mean:

⚠️ DANGER: You can be killed or seriously injured if you don't immediately follow instructions.

⚠️ WARNING: You can be killed or seriously injured if you don't follow instructions.

All safety messages will tell you what the potential hazard is, tell you how to reduce the chance of injury, and tell you what can happen if the instructions are not followed.

- Do not install a clothes dryer with flexible plastic venting materials. If flexible metal (foil type) duct is installed, it must be of a specific type identified by the appliance manufacturer as suitable for use with clothes dryers. Flexible venting materials are known to collapse, be easily crushed, and trap lint. These conditions will obstruct clothes dryer airflow and increase the risk of fire.
- Do not store or use gasoline or other flammable vapors and liquids in the vicinity of this appliance or any other appliances.
- Installation and service must be performed by a qualified installer, service agency, or the gas supplier.
- Install the clothes dryer according to the manufacturer's instructions and local codes.
- Save these instructions.

WHAT TO DO IF YOU SMELL GAS:

1. Do not try to light a match or cigarette, or turn on any gas or electrical appliance.
2. Do not touch any electrical switches. Do not use any phone in your building.
3. Clear the room, building, or area of all occupants.
4. Immediately call your gas supplier from a neighbor's phone. Follow the gas supplier's instructions carefully.
5. If you cannot reach your gas supplier, call the fire department.

IMPORTANT SAFETY INSTRUCTIONS

READ ALL INSTRUCTIONS BEFORE USE

⚠️ WARNING For your safety, the information in this manual must be followed to minimize the risk of fire or explosion, electric shock, or to prevent property damage, personal injury, or loss of life.

BASIC SAFETY PRECAUTIONS

⚠️ WARNING: To reduce the risk of fire, electric shock, or personal injury when using this appliance, follow basic precautions, including the following:

- Read all instructions before using the dryer.
- Before use, the dryer must be properly installed as described in this manual.
- Do not place items exposed to cooking oils in your dryer. Items contaminated with cooking oils may contribute to a chemical reaction that could cause a load to catch fire.
- Do not dry articles that have been previously cleaned in, washed in, soaked in, or spotted with gasoline, dry-cleaning solvents, or other flammable or explosive substances as they give off vapors that could ignite or explode.
- Do not reach into the dryer if the drum or any other part is moving.
- Do not repair or replace any part of the dryer or attempt any servicing unless specifically recommended in this Use and Care Guide or in published user-repair instructions that you understand and have the skills to carry out.
- Do not tamper with controls.
- Before the dryer is removed from service or discarded, remove the door to the drying compartment.
- Do not allow children to play on or in the dryer. Close supervision of children is necessary when the dryer is used near children.
- Do not use fabric softeners or products to eliminate static unless recommended by the manufacturer of the fabric softener or product.
- Do not use heat to dry articles containing foam rubber or similarly textured rubber-like materials.
- Keep area around the exhaust opening and adjacent surrounding areas free from the accumulation of lint, dust, and dirt.
- The interior of the dryer and exhaust vent should be cleaned periodically by qualified service personnel.
- Do not install or store the dryer where it will be exposed to the weather.
- Always check the inside of the dryer for foreign objects.
- Clean lint screen before or after each load.

CALIFORNIA SAFE DRINKING WATER AND TOXIC ENFORCEMENT ACT

This act requires the Governor of California to publish a list of substances known to the state to cause cancer, birth defects, or other reproductive harm and requires businesses to warn customers of potential exposure to such substances.

Gas appliances can cause minor exposure to four of these substances, namely benzene, carbon monoxide, formaldehyde, and soot, caused primarily by the incomplete combustion of natural gas or LP fuels.

Properly adjusted dryers will minimize incomplete combustion. Exposure to these substances can be minimized further by properly venting the dryer to the outdoors.

IMPORTANT SAFETY INSTRUCTIONS

READ ALL INSTRUCTIONS BEFORE USE

⚠️ WARNING For your safety, the information in this manual must be followed to minimize the risk of fire or explosion, electric shock, or to prevent property damage, personal injury, or loss of life.

GROUNDING INSTRUCTIONS

This appliance must be grounded. In the event of malfunction or breakdown, grounding will reduce the risk of electric shock by providing a path of least resistance for electric current. This appliance must be equipped with a cord having an equipment-grounding conductor and a grounding plug. The plug must be plugged into an appropriate outlet that is properly installed and grounded in accordance with all local codes and ordinances.

Do not modify the plug provided with the appliance. If it will not fit the outlet, have a proper outlet installed by a qualified electrician.

This appliance must be connected to a grounded metal, permanent wiring system or an equipment-grounding conductor must be run with the circuit conductors and connected to the equipment-grounding terminal or lead on the appliance.

Electrical shock can result if the dryer is not properly grounded.

⚠️ WARNING — Improper connection of the equipment-grounding conductor can result in a risk of electric shock. Check with a qualified electrician or service person if you are in doubt as to whether the appliance is properly grounded

SAFETY INSTRUCTIONS FOR INSTALLATION

⚠️ WARNING: To reduce the risk of fire, electric shock, or personal injury when using this appliance, follow basic precautions, including the following:

- **Properly ground dryer to conform with all governing codes and ordinances.** Follow details in the installation instructions. Electrical shock can result if the dryer is not properly grounded.
- **Before use, the dryer must be properly installed as described in this manual.** Electrical shock can result if the dryer is not properly grounded.
- **Install and store the dryer where it will not be exposed to temperatures below freezing or exposed to the weather.**
- **All repairs and servicing must be performed by an authorized servicer unless specifically recommended in this Owner's Guide. Use only authorized factory parts.** Failure to follow this warning can cause serious injury, fire, electrical shock, or death.
- **To reduce the risk of electric shock, do not install the dryer in humid spaces.** Failure to follow this warning can cause serious injury, fire, electrical shock, or death.
- **Connect to a properly rated, protected, and sized power circuit to avoid electrical overload.** Improper power circuit can melt, creating electrical shock and/or fire hazard.
- **Remove all packing items and dispose of all shipping materials properly.** Failure to do so can result in death, explosion, fire, or burns.
- **Place dryer at least 18 inches above the floor for a garage installation.** Failure to do so can result in death, explosion, fire, or burns.
- **Keep all packaging from children.** Packaging material can be dangerous for children. There is a risk of suffocation.
- **Do not install nearby heat item.** Such a stove, oven or heater. Failure to do so can cause malfunction, smoke, or fire.
- **Do not place candle and cigarettes on top of the product.** Failure to do so can cause them to melt, smoke, or catch fire.
- **Remove all protective vinyl film from the product.** Failure to do so can cause them to melt, smoke, or catch fire.

IMPORTANT SAFETY INSTRUCTIONS

READ ALL INSTRUCTIONS BEFORE USE

⚠WARNING For your safety, the information in this manual must be followed to minimize the risk of fire or explosion, electric shock, or to prevent property damage, personal injury, or loss of life.

SAFETY INSTRUCTIONS FOR INSTALLATION

Exhaust/Ducting:

- **Gas dryers MUST be exhausted to the outside.** Failure to follow these instructions can result in fire or death.
- **The dryer exhaust system must be exhausted to the outside of the dwelling. If the dryer is not exhausted outdoors, some fine lint and large amounts of moisture will be expelled into the laundry area.** An accumulation of lint in any area of the home can create a health and fire hazard.
- **Use only rigid metal or flexible metal 4-inch diameter ductwork inside the dryer cabinet or for exhausting to the outside. Use of plastic or other combustible ductwork can cause a fire.** Punctured ductwork can cause a fire if it collapses or becomes otherwise restricted in use or during installation.
- **Ductwork is not provided with the dryer, and you should obtain the necessary ductwork locally. The end cap should have hinged dampers to prevent backdraft when the dryer is not in use.** Failure to follow these instructions can result in fire or death.
- **The exhaust duct must be 4 inches (10.2 cm) in diameter with no obstructions. The exhaust duct should be kept as short as possible. Make sure to clean any old ducts before installing your new dryer.** Failure to follow these instructions can result in fire or death.
- **Rigid or semi - rigid metal ducting is recommended for use between the dryer and the wall. In special installations when it is impossible to make a connection with the above recommendations, a UL-listed flexible metal transition duct may be used between the dryer and wall connection only. The use of this ducting will affect drying time.** Failure to follow these instructions can result in fire or death.
- **DO NOT use sheet metal screws or other fasteners which extend into the duct that could catch lint and reduce the efficiency of the exhaust system.** Secure all joints with duct tape. For complete details, follow the Installation Instructions. Failure to follow these instructions can result in fire or death.

SAFETY INSTRUCTIONS FOR STEAM FUNCTIONS

⚠WARNING: To reduce the risk of fire, electric shock, or personal injury when using this appliance, follow basic precautions, including the following:

- **Do not open the dryer door during steam cycles.** Failure to follow these instructions can result in a burn hazard.
- **Do not dry articles that have been previously cleaned in, washed in, soaked in, or spotted with gasoline, dry-cleaning solvents, or other flammable or explosive substances as they give off vapors that could ignite or explode.** Failure to follow these instructions can result in fire or death.
- **Do not fill the steam feeder with gasoline, dry-cleaning solvents, or other flammable or explosive substances.** Failure to follow these instructions can result in fire or death.
- **Do not touch the steam nozzle in the drum during or after the steam cycle.** Failure to follow these instructions can result in a burn hazard.
- **Do not fill the steam feeder with hot water (over 86°F/30°C).** Failure to follow these instructions can result in a burn hazard.

IMPORTANT SAFETY INSTRUCTIONS

READ ALL INSTRUCTIONS BEFORE USE

⚠️ WARNING For your safety, the information in this manual must be followed to minimize the risk of fire or explosion, electric shock, or to prevent property damage, personal injury, or loss of life.

SAFETY INSTRUCTIONS FOR CONNECTING ELECTRICITY

⚠️ WARNING: To reduce the risk of fire, electric shock, or personal injury when using this appliance, follow basic precautions, including the following:

- **Do not, under any circumstances, cut or remove the ground prong from the power cord.** To prevent personal injury or damage to the dryer, the electrical power cord must be plugged into a properly grounded outlet.
- **For personal safety, this dryer must be properly grounded.** Failure to do so can result in electrical shock or injury.
- **Refer to the installation instructions in this manual for specific electrical requirements for your model.** Failure to follow these instructions can create an electrical shock hazard and/or a fire hazard.
- **This dryer must be plugged into a properly grounded outlet. Electrical shock can result if the dryer is not properly grounded. Have the wall outlet and circuit checked by a qualified electrician to make sure the outlet is properly grounded.** Failure to follow these instructions can create an electrical shock hazard and/or a fire hazard.
- **The dryer should always be plugged into its own individual electrical outlet which has a voltage rating that matches the rating plate.** This provides the best performance and also prevents overloading house wiring circuits which could cause a fire hazard from overheated wires.
- **Never unplug your dryer by pulling on the power cord. Always grip plug firmly and pull straight out from the outlet.** The power cord can be damaged, resulting in a risk of fire and electrical shock.
- **Repair or replace immediately all power cords that have become frayed or otherwise damaged. Do not use a cord that shows cracks or abrasion damage along its length or at either end.** The power cord can melt, creating electrical shock and/or fire hazard.
- **When installing or moving the dryer, be careful not to pinch, crush, or damage the power cord.** This will prevent injury and prevent damage to the dryer from fire and electrical shock.

SAVE THESE INSTRUCTIONS

PARTS AND FEATURES

SPECIAL FEATURES

A EASY-TO-USE CONTROL PANEL

Rotate the cycle selector knob to select the desired dry cycle. Add cycle options or adjust settings at the touch of a button.

B EASY-ACCESS REVERSIBLE DOOR

Wide-opening door provides easy access for loading and unloading. Door swing can be reversed to adjust for installation location.

C ULTRA-CAPACITY STAINLESS STEEL DRUM WITH DRUM LIGHT

The ultra-large stainless steel drum offers superior durability. The drum is equipped with a light that illuminates when the dryer door is open and turns off when the door is closed.

D STEAM FUNCTIONS

LG's steam technology allows you to inject fabrics with a swirling jet of hot steam to refresh clothes, reduce static, and make ironing easier. Simply select the STEAMFRESH™ cycle, or you can add a steam option to selected cycles.

E FLOW SENSE™ DUCT BLOCKAGE SENSING SYSTEM INDICATOR

The FLOW SENSE™ duct blockage sensing system detects and alerts you to blockages in the ductwork that reduce exhaust flow from the dryer. Clean exhaust systems increase efficiency and reduce drying times.

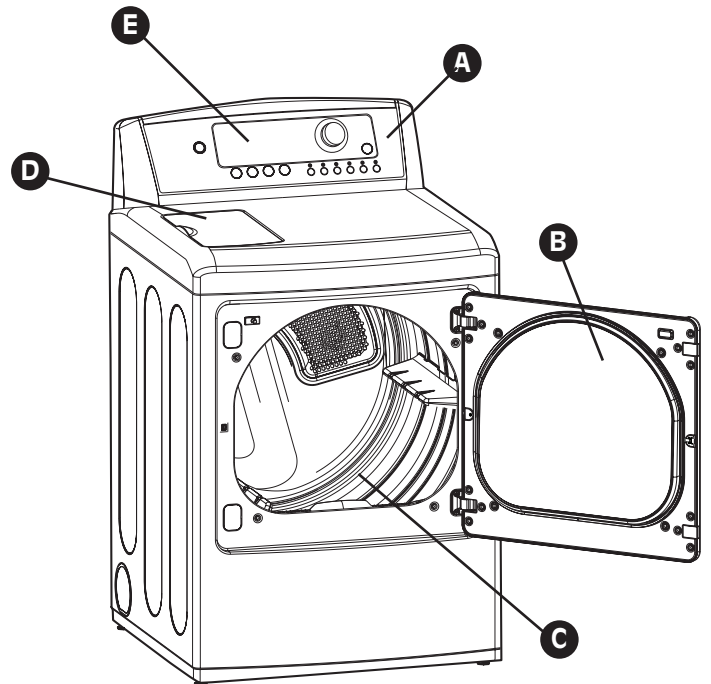

Protocol P154
Sanitization Performance of
Residential Clothes Dryer

PARTS AND FEATURES

KEY PARTS AND COMPONENTS

In addition to the special features and components outlined in the *Special Features* section, there are several other important components that are referenced in this manual.

A FRONT-MOUNT LINT FILTER

Front-mounted lint filter allows for easy access and cleaning after every load.

B LEVELING FEET

Four leveling feet (two in the front, and two in the back) adjust to improve dryer stability on uneven floors.

C DRYING RACK

Use the drying rack with the RACK DRY cycle to safely dry such items as sweaters, delicates and gym shoes without tumbling or overheating.

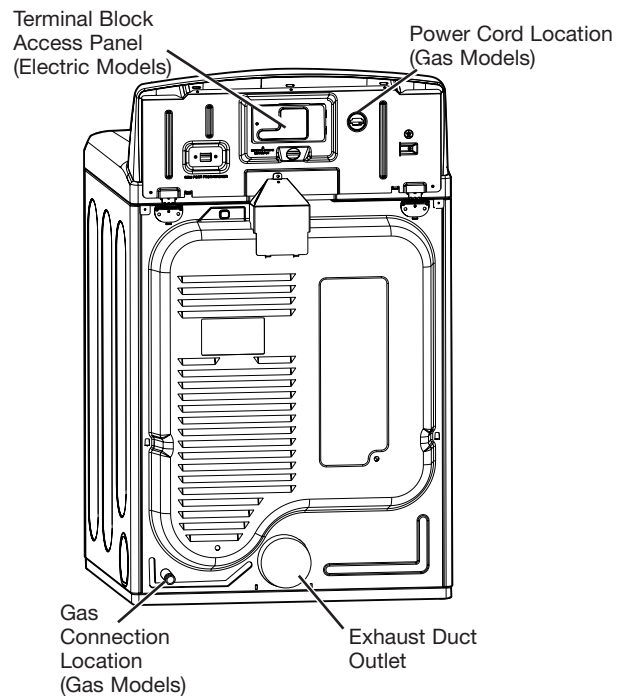
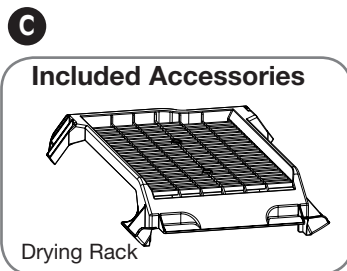
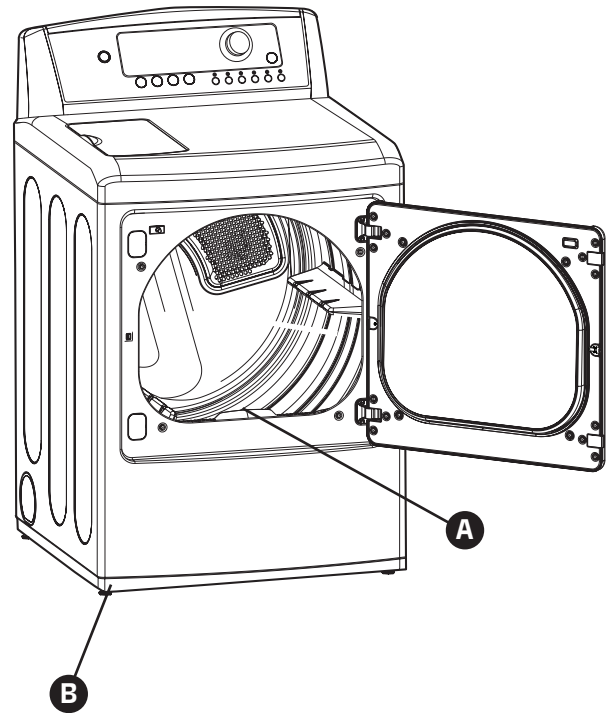

Rear of Dryer

INSTALLATION INSTRUCTIONS

IMPORTANT: Follow the operating and care instructions in this manual and your dryer will provide many years of reliable service.

It is important that you review this entire manual before installing and using your dryer. Detailed instructions concerning electrical connections, gas connections, and exhaust requirements are provided on the following pages.

INSTALLATION LOCATION REQUIREMENTS

- A location that allows for proper exhaust installation. A gas dryer must be exhausted to the outdoors. See **Venting Requirements**.
- A grounded electrical outlet located within 2 ft. (61 cm) of either side of the dryer. See **Electrical Requirements**.
- A sturdy floor to support the total dryer weight of 200 lbs (90.7 kg). The combined weight of a companion appliance should also be considered.
- A level floor with a maximum slope of 1 inch (2.5 cm) under entire dryer. If slope is greater than 1 inch (2.5 cm), install Extended Dryer Feet Kit. Clothes may not tumble properly, and automatic sensor cycles may not operate correctly if dryer is not level.
- For a garage installation, you will need to place the dryer at least 18 inches (46 cm) above the floor. If using a pedestal, you will need 18 inches (46 cm) to the bottom of the dryer.

Do not operate your dryer at temperatures below 45° F (7° C). At lower temperatures, the dryer might not shut off at the end of an automatic cycle. This can result in longer drying times.

The dryer must not be installed or stored in an area where it will be exposed to water and/or weather.

Check code requirements. Some codes limit, or do not permit, installation of the dryer in garages, closets, mobile homes or sleeping quarters. Contact your local building inspector.

NOTE: No other fuel-burning appliance can be installed in the same closet as a dryer.

CLEARANCES

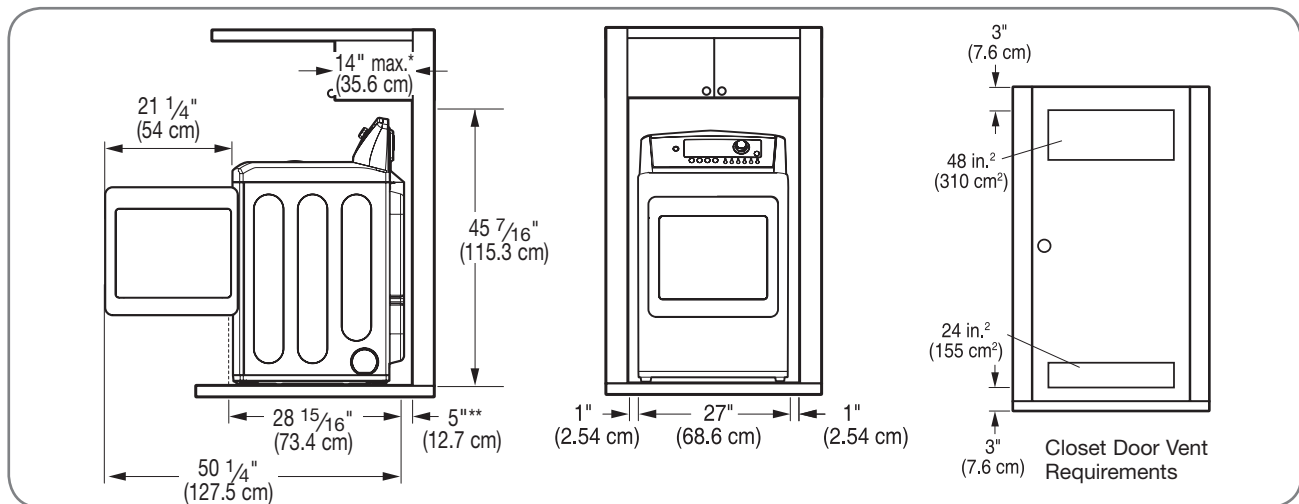

Installation spacing for recessed area or closet installation

The following spacing dimensions are recommended for this dryer. This dryer has been tested for spacing of 0 inches (0 cm) clearance on the sides and rear. Recommended spacing should be considered for the following reasons:

- Additional spacing should be considered for ease of installation and servicing.
- Additional clearances might be required for wall, door and floor moldings.

Suggestion: There should be at least a little space around the dryer (or any other appliance) to eliminate the transfer of vibration from one to the other. Too much vibration could cause them to make noise or touch each other, causing paint damage and making even more noise.

- Additional spacing should be considered on all sides of the dryer to reduce noise transfer.
For closet installation, with a door, minimum ventilation openings in the top and bottom of the door are required. Louvered doors with equivalent ventilation openings are acceptable.
- Companion appliance spacing should also be considered.

INSTALLATION INSTRUCTIONS

CLEARANCES (cont.)

IMPORTANT: If you are installing your dryer using an optional pedestal base or stacking kit, please refer to **Optional Accessories** in this manual or to the instructions for your pedestal or stacking kit before proceeding with the installation.

Recommended installation spacing for cabinet installation

■ For cabinet installation, with a door, minimum ventilation openings in the top of the cabinet are required.

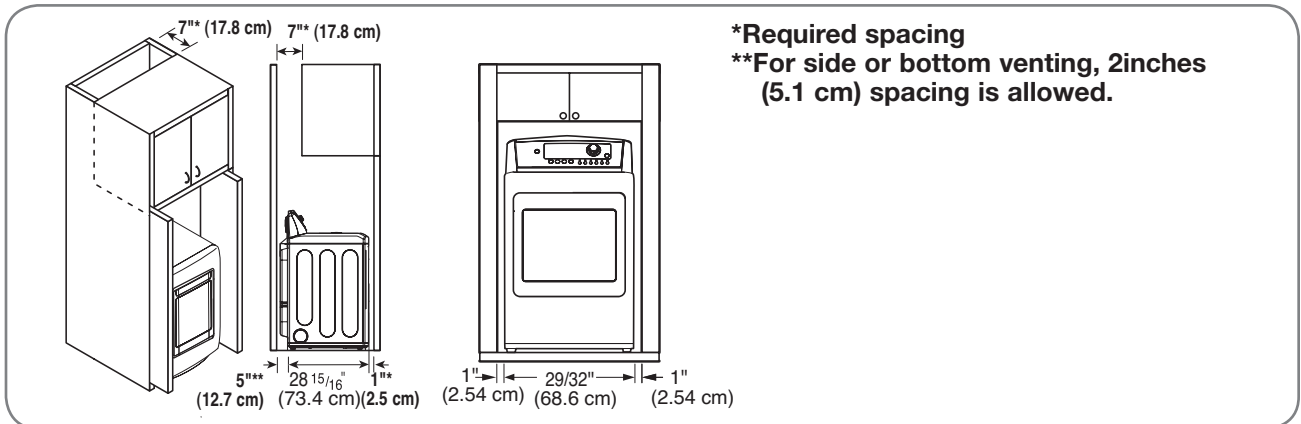

LEVELING THE DRYER

⚠ WARNING To reduce the risk of personal injury, adhere to all industry recommended safety procedures including the use of long sleeved gloves and safety glasses. Failure to follow all of the safety warnings in this manual could result in property damage, personal injury or death.

To ensure that the dryer provides optimal drying performance, it must be level. To minimize vibration, noise, and unwanted movement, the floor must be a level, solid surface.

NOTE: Adjust the leveling feet only as far as necessary to level the dryer. Extending the leveling feet more than necessary can cause the dryer to vibrate.

- All four leveling feet must rest solidly on the floor. Gently push on the top corners of the dryer to make sure that the dryer does not rock from corner to corner.

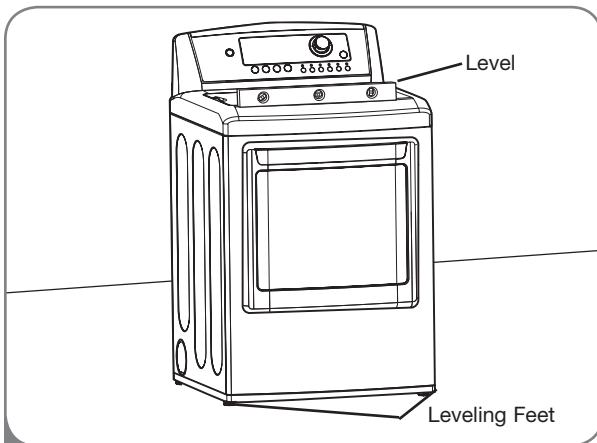

- 1 Position the dryer in the final location. Place a level across the top of the dryer.

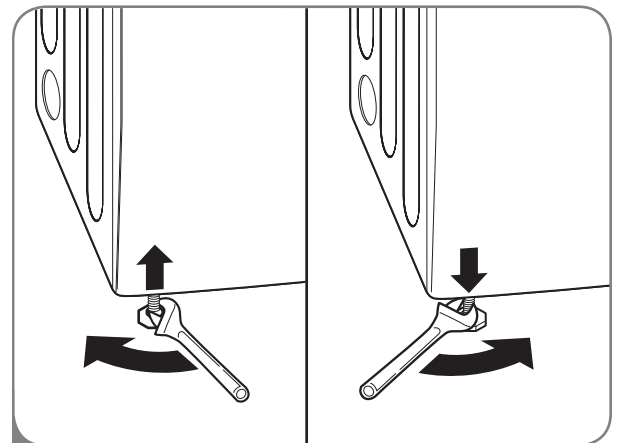

- 2 Use an adjustable wrench to turn the leveling feet. Turn clockwise to raise the dryer or counterclockwise to lower it. Raise or lower the leveling feet until dryer is level from side to side and front to back.

Make sure that all 4 leveling feet are in firm contact with the floor.

INSTALLATION INSTRUCTIONS

REVERSING THE DOOR

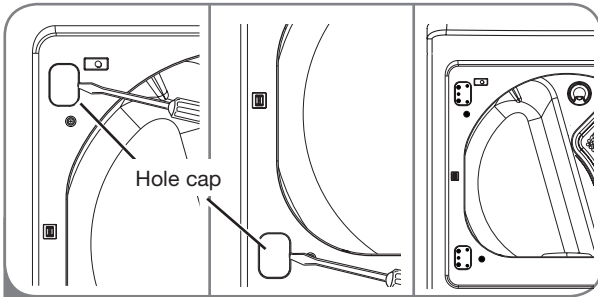

- 1 Open the door and remove the two plastic hole caps on the catch side by gently prying up with a flat blade screwdriver. Save these for step 6.

CAUTION

Support the weight of the door when removing the screws in the next step. Failure to properly support the weight of the door could result in property damage, damage to the dryer, or personal injury.

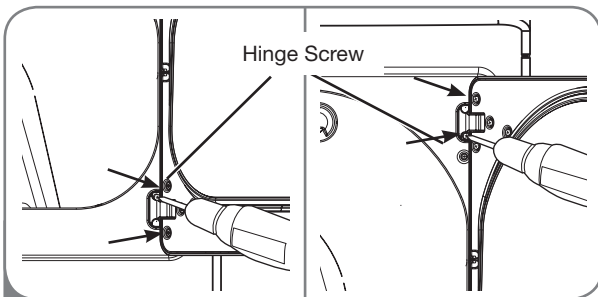

- 2 While supporting the door, remove the 4 screws, two from each hinge. Set the door aside face down on a protected surface to prevent damage to the door or the work surface.

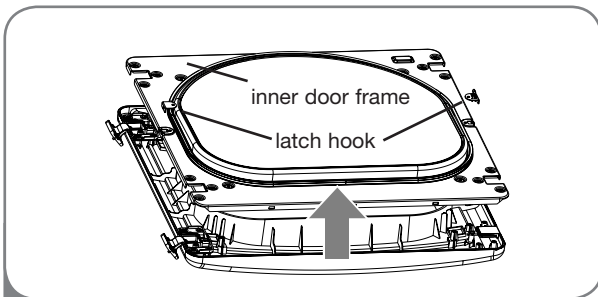

- 3 With the door on a protected surface, remove the 12 screws on each side of the door and lift off the inner door frame using a flat blade screwdriver. Remove the latch hook and blank and move them to the opposite side.

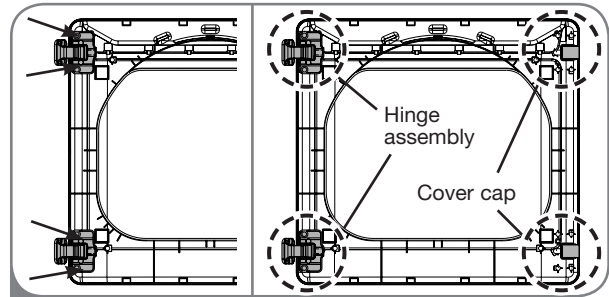

- 4 Remove the 4 screws securing the hinges to the door frame. Remove the two plastic cover caps. Reinstall the hinges and cover caps on the opposite sides from which they were removed.

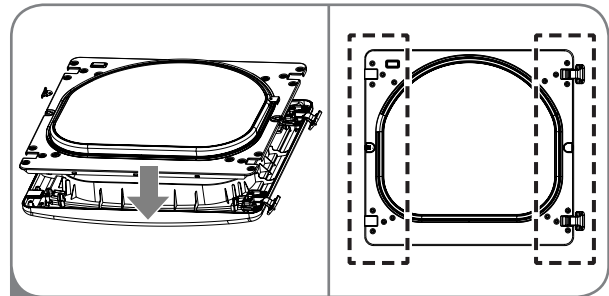

- 5 With the hinges and cover caps in the new locations, remount the inner door frame onto the outer door frame with the screws removed in step 3 above.

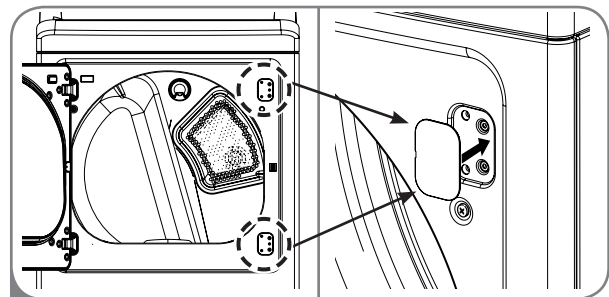

- 6 Reinstall the door with the screws from step 1,2.

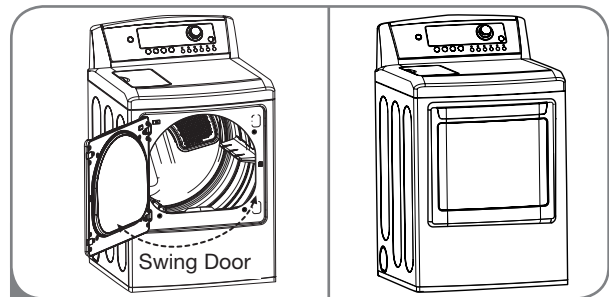

- 7 Test the swing of the door to make sure the hinges and latch are properly aligned and that the door closes and latches correctly.

INSTALLATION INSTRUCTIONS

CHANGING THE DRYER VENT LOCATION

⚠ WARNING

- Use a heavy metal vent.
- Do not use plastic or thin foil duct.
- Clean old ducts before installing this dryer.
- Protect your hands and arms from sharp edges when working inside the cabinet.
- To reduce the risk of personal injury, adhere to all industry recommended safety procedures including the use of long sleeved gloves and safety glasses.
- Failure to follow all of the safety warnings in this manual could result in property damage, personal injury or death.

Your new dryer is shipped to vent to the rear. It can also be configured to vent to the bottom or side (right-side venting is not available on gas models).

An adapter kit, part number **383EEL9001B**, may be purchased from your LG retailer. This kit contains the necessary duct components to change the dryer vent location.

OPTION 1: Side Venting

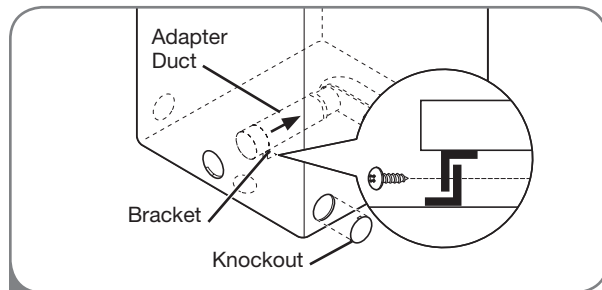

- 2 Press the tabs on the knockout and carefully remove the knockout for the desired vent opening (right-side venting is not available on gas models). Press the adapter duct onto the blower housing and secure to the base of the dryer as shown.

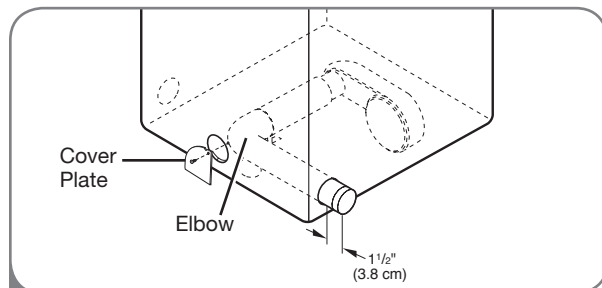

- 3 Preassemble a 4-inch (10 cm) elbow to the next 4-inch (10 cm) duct section, and secure all joints with duct tape. Be sure that the male end of the elbow faces AWAY from the dryer. Insert the elbow/duct assembly through the side opening and press it onto the adapter duct. Secure in place with duct tape. Be sure that the male end of the duct protrudes 1½ inches (3.8 cm) to connect the remaining ductwork. Attach cover plate to the back of the dryer with included screw.

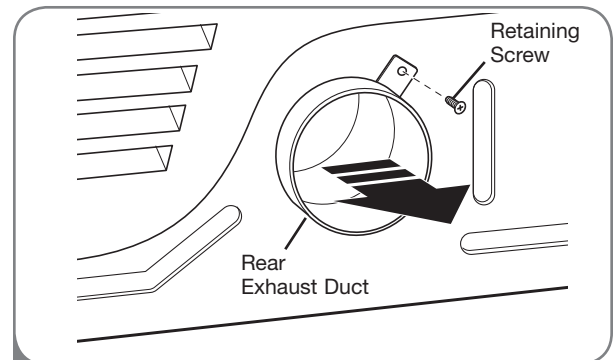

- 1 Remove the rear exhaust duct retaining screw. Pull out the exhaust duct.

OPTION 2: Bottom Venting

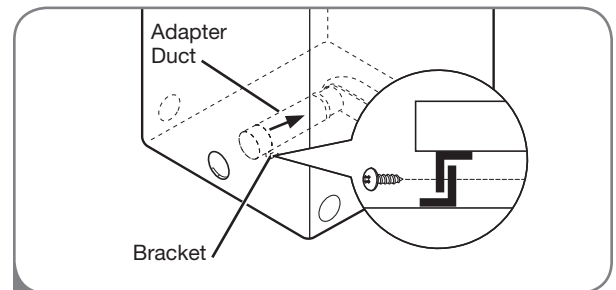

- 2 Press the adapter duct onto the blower housing and secure to the base of the dryer as shown.

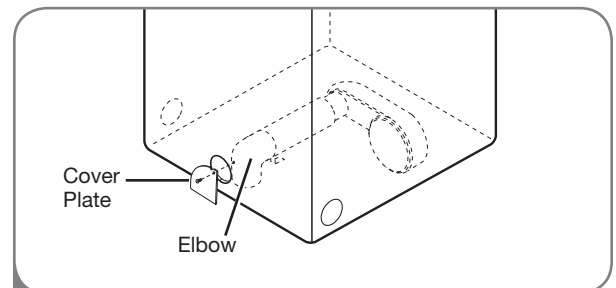

- 3 Insert the 4-inch (10 cm) elbow through the rear opening and press it onto the adapter duct. Be sure that the male end of the elbow faces down through hole in the bottom of the dryer. Secure in place with duct tape. Attach the cover plate to the back of the dryer with included screw.

INSTALLATION INSTRUCTIONS

VENTING THE DRYER

⚠WARNING: To reduce the risk of fire, electric shock, or personal injury when using this appliance, follow basic precautions, including the following:

- **Do not crush or collapse ductwork.** Failure to follow these instructions can result in fire or death.
- **Do not allow ductwork to rest on or contact sharp objects.** Failure to follow these instructions can result in fire or death.
- **If connecting to existing ductwork, make sure it is suitable and clean before installing the dryer.** Failure to follow these instructions can result in fire or death.
- **Venting must conform to local building codes.** Failure to follow these instructions can result in fire or death.
- **Gas dryers MUST exhaust to the outdoors.** Failure to follow these instructions can result in fire or death.
- **Use only 4-inch (10.2 cm) rigid or flexible metal ductwork inside the dryer cabinet and for venting outside.** Failure to follow these instructions can result in fire or death.
- **To reduce the risk of fire, combustion, or accumulation of combustible gases, DO NOT exhaust dryer air into an enclosed and unventilated area, such as an attic, wall, ceiling, crawl space, chimney, gas vent, or concealed space of a building.** Failure to follow these instructions can result in fire or death.
- **To reduce the risk of fire, DO NOT exhaust the dryer with plastic or thin foil ducting.** Failure to follow these instructions can result in fire or death.
- **The exhaust duct must be 4 inches (10.2 cm) in diameter with no obstructions. The exhaust duct should be kept as short as possible. Make sure to clean any old ducts before installing your new dryer.** Failure to follow these instructions can result in fire or death.
- **Rigid or semirigid metal ducting is recommended for use between the dryer and the wall. In special installations when it is impossible to make a connection with the above recommendations, a UL-listed flexible metal transition duct may be used between the dryer and wall connection only. The use of this ducting will affect drying time.** Failure to follow these instructions can result in fire or death.
- **DO NOT use sheet metal screws or other fasteners which extend into the duct that could catch lint and reduce the efficiency of the exhaust system. Secure all joints with duct tape.** Failure to follow these instructions can result in fire or death.
- **To maximize operating results, please observe the duct length limitations noted in the chart on page 15.** Failure to follow these instructions can result in fire or death.
- **Ductwork is not provided with the dryer. You should obtain the necessary ductwork locally. The end cap should have hinged dampers to prevent backdraft when the dryer is not in use.** Failure to follow these instructions can result in fire or death.
- **The Total length of flexible metal duct shall not exceed 8 ft. (2.4m)**
- **In Canada, that only those foil-type flexible ducts, if any, specifically identified for use with the appliance by the manufacturer shall be used.** In the United States, that only those foil-type flexible ducts, if any, specifically identified for use with the appliance by the manufacturer and that comply with the outline for Clothes Dryer Transition Duct, Subject 2158A, shall be used.

INSTALLATION INSTRUCTIONS

VENTING THE DRYER (cont.)

Ductwork

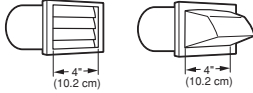
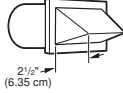
| Wall Cap Type | Number of 90° Elbows | Maximum Length of 4-inch Diameter Rigid Metal Duct |
|---|----------------------|--|
| <p>Recommended</p>  | 0 | 65 ft. (19.8 m) |
| | 1 | 55 ft. (16.8 m) |
| | 2 | 47 ft. (13.7 m) |
| | 3 | 36 ft. (11.0 m) |
| | 4 | 28 ft. (8.5 m) |
| <p>Use Only for Short Run Installations</p>  | 0 | 55 ft. (16.8 m) |
| | 1 | 47 ft. (13.7 m) |
| | 2 | 41 ft. (12.5 m) |
| | 3 | 30 ft. (9.1 m) |
| | 4 | 22 ft. (6.7 m) |

NOTE: Deduct 6 ft. (1.8 m) for each additional elbow. It is not recommended to use more than four 90° elbows.

Routing and Connecting Ductwork

Follow the guidelines below to maximize drying performance and reduce lint buildup and condensation in the ductwork.

NOTE: Ductwork and fittings are NOT included and must be purchased separately.

- Use 4-inch (10.2 cm) diameter rigid or semirigid metal ductwork.
- The exhaust duct run should be as short as possible.
- Use as few elbow joints as possible.
- The male end of each section of exhaust duct **must** point away from the dryer.
- Use duct tape on all duct joints.
- Insulate ductwork that runs through unheated areas in order to reduce condensation and lint buildup on duct surfaces.

IMPORTANT: Failure to exhaust the dryer correctly will void the dryer's warranty.

Correct Venting

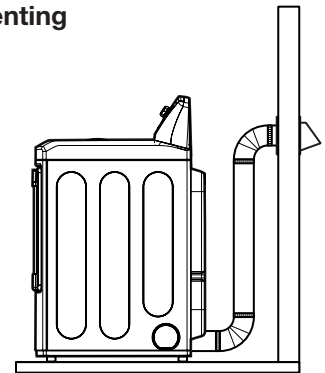

Incorrect Venting

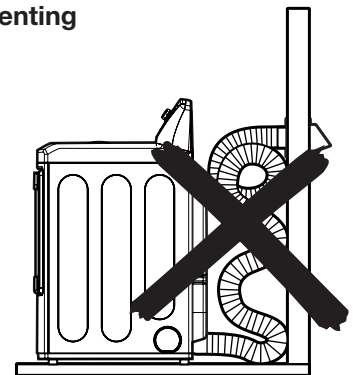

INSTALLATION INSTRUCTIONS

CONNECTING GAS DRYERS

⚠WARNING: To reduce the risk of fire, electric shock, or personal injury when using this appliance, follow basic precautions, including the following:

- **Gas supply requirements:**
As shipped from the factory, this dryer is configured for use with natural gas. It can be converted for use with LP (Liquefied Propane) gas. Gas pressure must not exceed 13 inches of water column.
- **A qualified service or gas company technician must connect the dryer to the gas service.** Failure to do so can result in fire, explosion, or death.
- **Isolate the dryer from the gas supply system by closing its individual manual shutoff valve during any pressure testing of the gas supply.** Failure to do so can result in fire, explosion, or death.
- **Supply line requirements:**
Your laundry room must have a rigid gas supply line to your dryer. In the United States, an individual manual shutoff valve **MUST** be installed within at least 6 ft. (1.8 m) of the dryer, in accordance with the National Fuel Gas Code ANSI Z223.1 or Canadian gas installation code CSA B149.1. A 1/8 - inch NPT pipe plug must be installed. Failure to do so can result in fire, explosion, or death
- **If using a rigid pipe, the rigid pipe should be 1/2 - inch IPS. If acceptable under local codes and ordinances and when acceptable to your gas supplier, 3/8 - inch approved tubing may be used where lengths are less than 20 ft. (6.1 m). Larger tubing should be used for lengths in excess of 20 ft. (6.1 m).** Failure to do so can result in fire, explosion, or death.
- **Connect the dryer to the type of gas shown on the nameplate.** Failure to do so can result in fire, explosion, or death.
- **To prevent contamination of the gas valve, purge the gas supply of air and sediment before connecting the gas supply to the dryer. Before tightening the connection between the gas supply and the dryer, purge remaining air until the odor of gas is detected.** Failure to do so can result in fire, explosion, or death.
- **DO NOT use an open flame to inspect for gas leaks. Use a noncorrosive leak-detection fluid.** Failure to do so can result in fire, explosion, or death.
- **Use only a new AGA- or CSA-certified gas supply line with flexible stainless steel connectors.** Failure to do so can result in fire, explosion, or death.
- **Securely tighten all gas connections.** Failure to do so can result in fire, explosion, or death.
- **Use Teflon® tape or a pipe-joint compound that is insoluble in Liquefied Petroleum (LP) gas on all pipe threads.** Failure to do so can result in fire, explosion, or death.
- **DO NOT attempt any disassembly of the dryer; any disassembly requires the attention and tools of an authorized and qualified service person or company.** Failure to do so can result in fire, explosion, or death.

Electrical Requirements for Gas Models Only

⚠WARNING: To reduce the risk of fire, electric shock, or personal injury when using this appliance, follow basic precautions, including the following:

- **Do not, under any circumstances, cut or remove the third (ground) prong from the power cord.** Failure to follow this warning can result in fire, explosion, or death.
- **For personal safety, this dryer must be properly grounded.** Failure to follow this warning can result in fire, explosion, or death.
- **The power cord of this dryer is equipped with a 3-prong (grounding) plug which mates with a standard 3-prong (grounding) wall outlet to minimize the possibility of electric shock hazard from this appliance.** Failure to follow this warning can result in fire, explosion, or death.
- **This dryer must be plugged into a 20-amp, 120 VAC. grounded outlet protected by a 15-ampere fuse or circuit breaker.** Failure to follow this warning can result in fire, explosion, or death.
- **Where a standard 2-prong wall outlet is encountered, it is your personal responsibility and obligation to have it replaced with a properly grounded 3-prong wall outlet.** Failure to follow this warning can result in fire, explosion, or death.

INSTALLATION INSTRUCTIONS

CONNECTING GAS DRYERS (cont.)

⚠ WARNING: To reduce the risk of fire, electric shock, or personal injury when using this appliance, follow basic precautions, including the following:

- **Installation and service must be performed by a qualified installer, service agency, or the gas supplier.** Failure to do so can result in fire, explosion, or death.
- **Use only a new stainless steel flexible connector and a new AGA-certified connector.** Failure to do so can result in fire, explosion, or death.
- **A gas shutoff valve must be installed within 6 ft. (1.8 m) of the dryer.** Failure to do so can result in fire, explosion, or death.
- **The dryer is configured for Natural Gas when shipped from the factory. Make sure that the dryer is equipped with the correct burner orifice for the type of gas being used (Natural Gas or Liquefied Petroleum).** Failure to do so can result in fire, explosion, or death.
- **If necessary, the correct orifice (for the LP conversion kit order part number 4948EL4002B) should be installed by a qualified technician and the change should be noted on the dryer.** Failure to do so can result in fire, explosion, or death.
- **All connections must be in accordance with local codes and regulations.** Failure to do so can result in fire, explosion, or death.
- **Gas dryers MUST exhaust to the outdoors.** Failure to do so can result in fire, explosion, or death.

Connecting the Gas Supply

- 1 Make sure that the gas supply to the laundry room is turned OFF. Confirm that the type of gas available in your laundry room is appropriate for the dryer. The dryer is prepared for Natural Gas with a $\frac{3}{8}$ - inch NPT gas connection.
- 2 Remove the shipping cap from the gas connection at the back of the dryer. Be careful not to damage the threads of the gas connector when removing the shipping cap.
- 3 Connect the dryer to your laundry room's gas supply using a new flexible stainless steel connector with a $\frac{3}{8}$ - inch NPT fitting.
- 4 Securely tighten all connections between the dryer and your laundry room's gas supply. Turn on your laundry room's gas supply and check all pipe connections (both internal and external) for gas leaks with a noncorrosive leak-detection fluid.

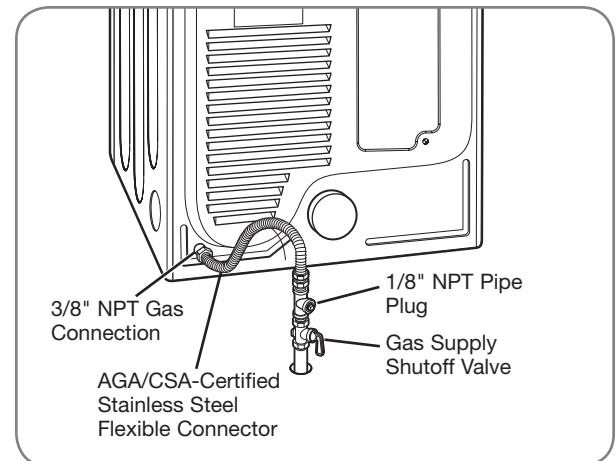

Electrical Connection

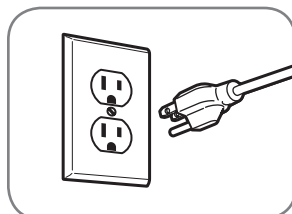

Plug dryer into a **120-VAC, 60-Hz.** grounded 3-prong outlet.

High-Altitude Installations

The BTU rating of this dryer is AGA-certified for elevations below 10,000 feet.

If your gas dryer is being installed at an elevation above 10,000 feet, it must be derated by a qualified technician or gas supplier.

INSTALLATION INSTRUCTIONS

CONNECTING ELECTRIC DRYERS

⚠️WARNING: To help prevent fire, electric shock, serious injury, or death, the wiring and grounding must conform to the latest edition of the National Electrical Code, ANSI/NFPA 70 and all applicable local regulations. Please contact a qualified electrician to check your home's wiring and fuses to ensure that your home has adequate electrical power to operate the dryer.

Electrical Requirements for Electric Models Only

⚠️WARNING: To reduce the risk of fire, electric shock, or personal injury when using this appliance, follow basic precautions, including the following:

- This dryer must be connected to a grounded metal, permanent wiring system, or an equipment-grounding conductor must be run with the circuit conductors and connected to the equipment-grounding terminal or lead on the dryer. Failure to do so can result in fire, explosion, or death.
- The dryer has its own terminal block that must be connected to a separate 240 VAC, 60 Hertz, single-phase circuit, fused at 30 amperes (the circuit must be fused on both sides of the line). **ELECTRICAL SERVICE FOR THE DRYER SHOULD BE OF THE MAXIMUM RATE VOLTAGE LISTED ON THE NAMEPLATE. DO NOT CONNECT DRYER TO 110-, 115-, OR 120-VOLT CIRCUIT.** Heating elements are available for field installation in dryers which are to be connected to an electrical service of a different voltage than that listed on the rating plate. Failure to follow these instructions can result in fire, explosion, or death.
- If branch circuit to dryer is 15 ft. (4.5 m) or less in length, use UL (Underwriters Laboratories) listed No. 10 AWG wire (copper wire only), or as required by local codes. If over 15 ft. (4.50 m), use UL-listed No.-8 AWG wire (copper wire only), or as required by local codes. Allow sufficient slack in wiring so dryer can be moved from its normal location when necessary. Failure to do so can result in fire, explosion, or death.
- The power cord (pigtail) connection between wall receptacle and dryer terminal block IS NOT supplied with dryer. Type of pigtail and gauge of wire must conform to local codes and with instructions on the following pages. Failure to follow these instructions can result in fire, explosion, or death.
- A 4-wire connection is required for all mobile and manufactured home installations, as well as all new construction after January 1, 1996. A 4-wire connection must be used where local codes do not permit grounding through the neutral wire. Failure to do so can result in fire, explosion, or death.

⚠️WARNING: To reduce the risk of fire, electric shock, or personal injury when using this appliance, follow basic precautions, including the following:

- Do not modify the plug and internal wire provided with the dryer.
- The dryer should be connected to a 4-hole outlet.
- If it does not fit the outlet, a proper outlet will need to be installed by a qualified electrician.

Special Electrical Requirements for Mobile or Manufactured Homes

⚠️WARNING: To reduce the risk of fire, electric shock, or personal injury when using this appliance, follow basic precautions, including the following:

- Any installation in a manufactured or mobile home must comply with the Manufactured Home Construction and Safety Standards Title 24 CFR, Part 32-80 or Standard CAN/CSA02240 MH and local codes and ordinances.
- A 4-wire connection is required for all mobile and manufactured home installations, as well as all new construction after January 1, 1996. Failure to do so can result in fire, explosion, or death.

INSTALLATION INSTRUCTIONS

CONNECTING ELECTRIC DRYERS (cont.)

USA ONLY

⚠ WARNING:

- Connect the power cord to the terminal block. Each colored wire should be connected to same color screw. Wire color indicated on manual is connected to the same color screw in block. Failure to follow these instructions may result in a short or overload.
- Grounding through the neutral conductor is prohibited for: (1) new branch-circuit installations, (2) mobile homes, (3) recreational vehicles, and (4) areas where local codes prohibit grounding through the neutral conductor.



Four-Wire Connection for Electric Dryers: Power Cord

- A 4-wire connection is required for all mobile and manufactured home installations, as well as all new construction after January 1, 1996.
- A UL-listed strain relief is required.
- Use a **30 A, 240 V, UL-listed power cord with #10 AWG-minimum copper** conductor and closed loop or forked terminals with upturned ends.

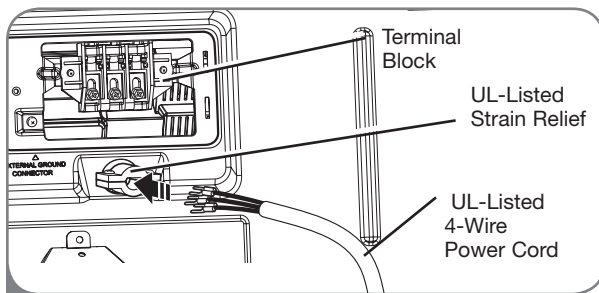

- 1 Remove the terminal block access cover on the upper back of the dryer. Install a UL-listed strain relief into the power cord through-hole; then thread a UL-listed, **30 A, 240 V, 4-wire, #10 AWG-minimum copper** conductor power cord through the strain relief.

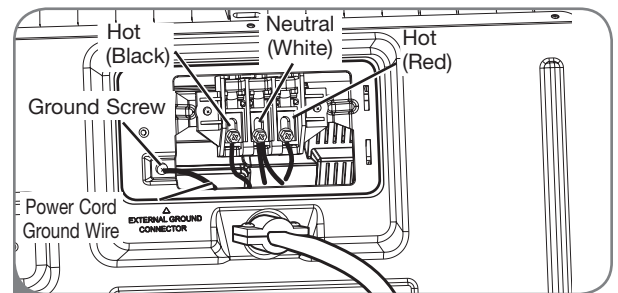

- 2 Transfer the dryer's ground wire from behind the green ground screw to the center screw of the terminal block. Attach the two hot leads of the power cord to the outer terminal block screws. Attach the white neutral wire to the center terminal block screw. Attach the power cord ground wire to the green ground screw. **TIGHTEN ALL SCREWS SECURELY.** Reinstall the terminal block access cover.

INSTALLATION INSTRUCTIONS

CONNECTING ELECTRIC DRYERS (cont.) USA ONLY

⚠ WARNING:

- Connect the power cord to the terminal block. Each colored wire should be connected to same color screw. Wire color indicated on manual is connected to the same color screw in block. Failure to follow these instructions may result in a short or overload.
- Grounding through the neutral conductor is prohibited for: (1) new branch-circuit installations, (2) mobile homes, (3) recreational vehicles, and (4) areas where local codes prohibit grounding through the neutral conductor.

Four-Wire Connection for Electric Dryers: Direct Wire

- A 4-wire connection is required for all mobile and manufactured home installations, as well as all new construction after January 1, 1996.
- A UL-listed strain relief is required.
- Use UL-listed **4-wire #10 AWG-minimum copper** conductor cable.
- Allow at least 5 ft. (1.5 m) length to allow for removal and reinstallation of the dryer.

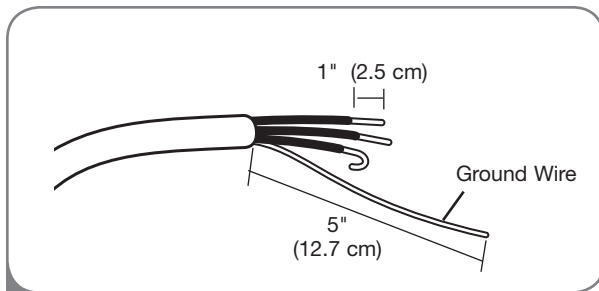

- 1** Remove 5 inches (12.7 cm) of the outer covering from the wire. Remove 5 inches of insulation from the ground wire. Cut off approximately 1½ inches (3.8 cm) from the other three wires and strip 1 inch (2.5 cm) insulation from each wire. Bend the ends of the three shorter wires into a hook shape.

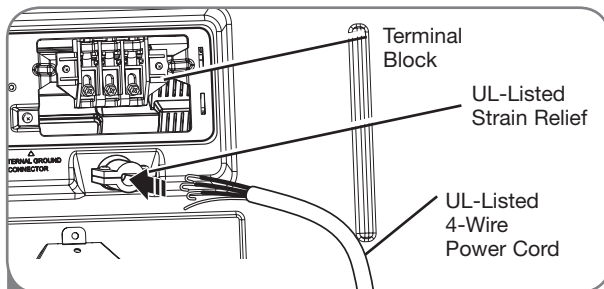

- 2** Remove the terminal block access cover on the upper back of the dryer. Install a UL-listed strain relief into the power cord opening; then thread the power cable prepared in Step 1 through the strain relief.

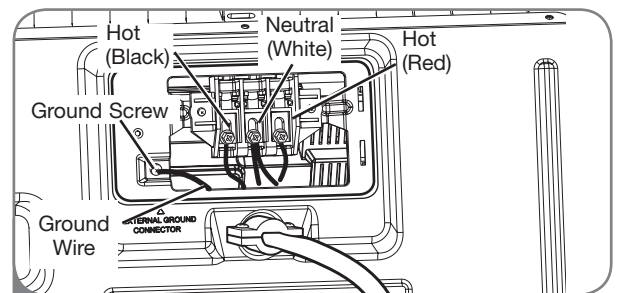

- 3** Transfer the dryer's ground wire from behind the green ground screw to the center screw of the terminal block. Attach the two hot leads of the power cable to the outer terminal block screws. Attach the white neutral wire to the center terminal block screw. Attach the power cable ground wire to the green ground screw. **TIGHTEN ALL SCREWS SECURELY.** Reinstall the terminal block access cover.

INSTALLATION INSTRUCTIONS

CONNECTING ELECTRIC DRYERS (cont.) USA ONLY

⚠ WARNING:

- Connect the power cord to the terminal block. Each colored wire should be connected to same color screw. Wire color indicated on manual is connected to the same color screw in block. Failure to follow these instructions may result in a short or overload.
- Grounding through the neutral conductor is prohibited for: (1) new branch-circuit installations, (2) mobile homes, (3) recreational vehicles, and (4) areas where local codes prohibit grounding through the neutral conductor.



Three-Wire Connection for Electric Dryers: Power Cord

- A 3-wire connection is NOT permitted on new construction after January 1, 1996.
- A UL-listed strain relief is required.

- Use a **30 A, 240 V, UL-listed power cord with #10 AWG-minimum copper** conductor and closed loop or forked terminals with upturned ends.

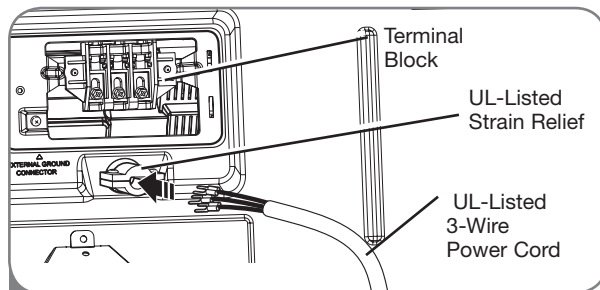

- 1 Remove the terminal block access cover on the upper back of the dryer. Install a UL-listed strain relief into the power cord opening; then thread a UL-listed, **30 A, 240 V, 3-wire, #10 AWG-minimum copper** conductor power cord through the strain relief.

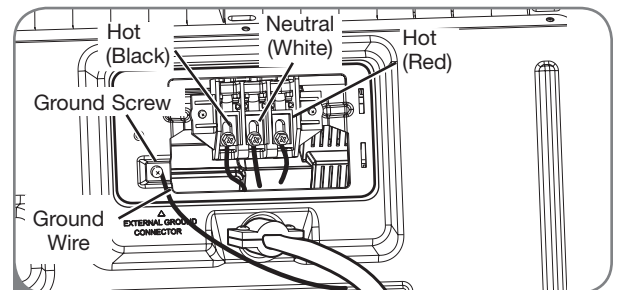

- 2 Attach the two hot leads of the power cord to the outer terminal block screws. Attach the neutral wire to the center terminal block screw. Connect the external ground (if required by local codes) to the green ground screw. **TIGHTEN ALL SCREWS SECURELY.** Reinstall the terminal block access cover.

INSTALLATION INSTRUCTIONS

CONNECTING ELECTRIC DRYERS (cont.)

USA ONLY

⚠ WARNING:

- Connect the power cord to the terminal block. Each colored wire should be connected to same color screw. Wire color indicated on manual is connected to the same color screw in block. Failure to follow these instructions may result in a short or overload.
- Grounding through the neutral conductor is prohibited for: (1) new branch-circuit installations, (2) mobile homes, (3) recreational vehicles, and (4) areas where local codes prohibit grounding through the neutral conductor.

Three-Wire Connection for Electric Dryers: Direct Wire

- A 3-wire connection is NOT permitted on new construction after January 1, 1996.
- A UL-listed strain relief is required.
- Use UL-listed **3-wire #10 AWG-minimum copper** conductor cable.
- Allow at least 5 ft. (1.5 m) length to allow for removal and reinstallation of the dryer.

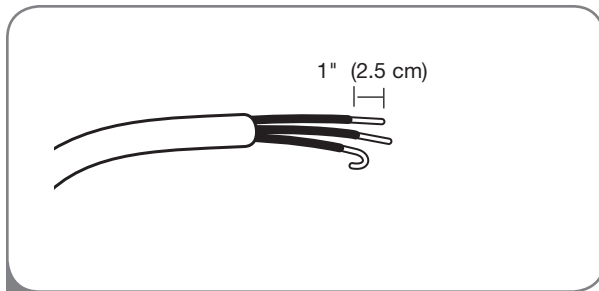

- 1 Remove 3½ inches (8.9 cm) of the outer covering from the wire. Strip 1 inch (2.5 cm) insulation from each wire. Bend the ends of the three wires into a hook shape.

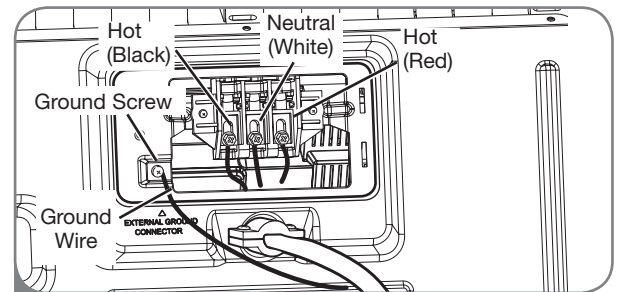

- 3 Attach the two hot leads of the power cord to the outer terminal block screws. Attach the neutral wire to the center terminal block screw. Connect the external ground (if required by local codes) to the green ground screw. **TIGHTEN ALL SCREWS SECURELY.** Reinstall the terminal block access cover.

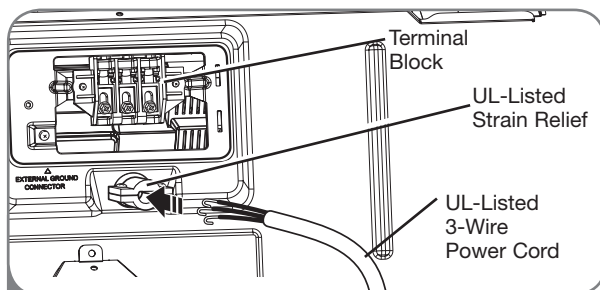

- 2 Remove the terminal block access cover on the upper back of the dryer. Install a UL-listed strain relief into the power cord through-hole; then thread the power cable prepared in Step 1 through the strain relief.

INSTALLATION INSTRUCTIONS

SPECIAL REQUIREMENTS FOR MANUFACTURED OR MOBILE HOMES

Any installation in a manufactured or mobile home must comply with the Manufactured Home Construction and Safety Standards Title 24 CFR, Part 32-80 or Standard CAN/CSA0Z240 MH and local codes and ordinances. If you are uncertain whether your proposed installation will comply with these standards, please contact a service and installation professional for assistance.

- A gas dryer must be permanently attached to the floor.
- The electrical connection for an electric dryer must be a 4-wire connection. More detailed information concerning the electrical connection is provided in the section *Connecting Electric Dryers*.
- To reduce the risk of combustion and fire, the dryer must be vented to the outside.
- DO NOT vent the dryer under a manufactured home or mobile home.
- Electric dryers may be vented to the outside using the back, left, right, or bottom panel.
- Gas dryers may be vented to the outside using the back, left, or bottom panel. Gas dryers may not be vented to the outside using the right side panel because of the burner housing.

- The dryer exhaust duct must be affixed securely to the manufactured or mobile home structure, and the exhaust duct must be made of a material that will resist fire and combustion. It is recommended that you use a rigid or flexible metal duct.
- DO NOT connect the dryer exhaust duct to any other duct, vent, chimney, or other exhaust duct.
- Make sure the dryer has adequate access to outside fresh air to ensure proper operation. The opening for outside fresh air must be at least 25 in² (163 cm²).
- It is important that the clearance of the duct from any combustible construction be at least 2 inches (5 cm), and when venting the dryer to the outdoors, the dryer can be installed with a clearance of 1 inch (2.5 cm) at the sides and back of the dryer.
- Please be aware that venting materials are not supplied with the dryer. You should obtain the venting materials necessary for proper installation.

FINAL INSTALLATION CHECK

Once you have completed the installation of the dryer and it is in its final location, confirm proper operation with the following tests and Duct Condition Testing on the following page.

Testing Dryer Heating

GAS MODELS

Close the dryer door, press the ON/OFF switch to turn the dryer on, and start the dryer on a heat setting. When the dryer starts, the igniter should ignite the main burner.

NOTE: If all air is not purged from the gas line, the gas igniter may turn off before the main burner ignites. If this happens, the igniter will reattempt gas ignition after approximately two minutes.

ELECTRIC MODELS

Close the dryer door, press the ON/OFF switch to turn the dryer on, and start the dryer on a heat setting. The exhaust air should be warm after the dryer has been operating for 3 minutes.

Checking Airflow

Effective dryer operation requires proper airflow. The adequacy of the airflow can be measured by evaluating the static pressure. Static pressure in the exhaust duct can be measured with a manometer, placed on the exhaust duct approximately 2 ft. (60.9 cm) from the dryer. Static pressure in the exhaust duct should not exceed 0.6 inches (1.5 cm). The dryer should be checked while the dryer is running with no load.

Checking Levelness

Once the dryer is in its final location, recheck the dryer to be sure it is level. Make sure it is level front to back and side to side, and that all 4 leveling feet are firmly on the floor.

INSTALLATION INSTRUCTIONS

DUCT CONDITION TEST

Your dryer features FlowSense™, an innovative sensing system that automatically detects blockages and restrictions in dryer ductwork. Keeping ductwork clean of lint buildup and free of restrictions allows clothes to dry faster and reduces energy use.

NOTE: When the dryer is first installed, this test should be performed to alert you to any existing problems with the exhaust duct in your home. However, since the test performed during normal operation provides more accurate information on the condition of the exhaust duct than does the installation test, the number of bars displayed during the two tests may not be the same.

To activate the duct condition test :

NOTE: Dryer heating test must be performed before proceeding. If heating is normal, perform cooling properly. Then perform the duct condition test below:

- 1 Press and hold the DAMP DRY BEEP and TEMP. CONTROL buttons at the same time. While holding these buttons, press POWER ON/OFF.



- 2 The dryer will show InS in the number display to indicate that it is in duct condition testing mode.

- 3  Press the START/PAUSE button. The dryer will run for approximately 2 minutes to test for blockages or restrictions to air flow in the ductwork.

 If no bars are shown in the display, the ductwork is free from serious blockages or restrictions.

 If all bars are lit, the dryer ductwork has a serious blockage that needs to be removed immediately.

IMPORTANT: Do **NOT** interrupt the test cycle!

NOTE: Even if no bars are displayed during the duct condition test, some restrictions may still be present in the exhaust duct. Refer to pages 14-15 for more information.

Correct Venting

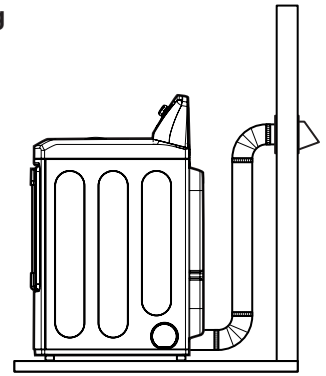

Restricted or Blocked Airflow



Avoid long runs or runs with multiple elbows or bends.

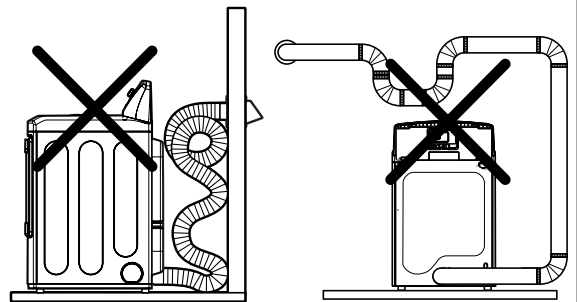

Check for blockages and lint buildup.

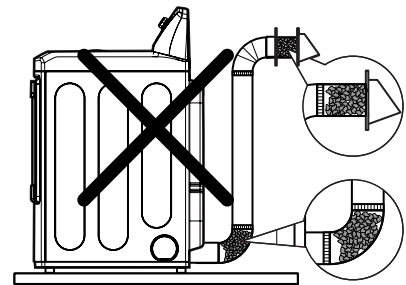

Make sure the ductwork is not crushed or restricted.

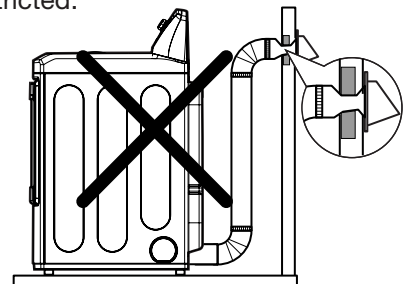

CONTROL PANEL FEATURES

Following are instructions for starting and using your new dryer. Please refer to specific sections of this manual for more detailed information.

Important Warning: To reduce the risk of fire, electric shock, or personal injury, read this entire manual, including the Important Safety Instructions, before operating this dryer.

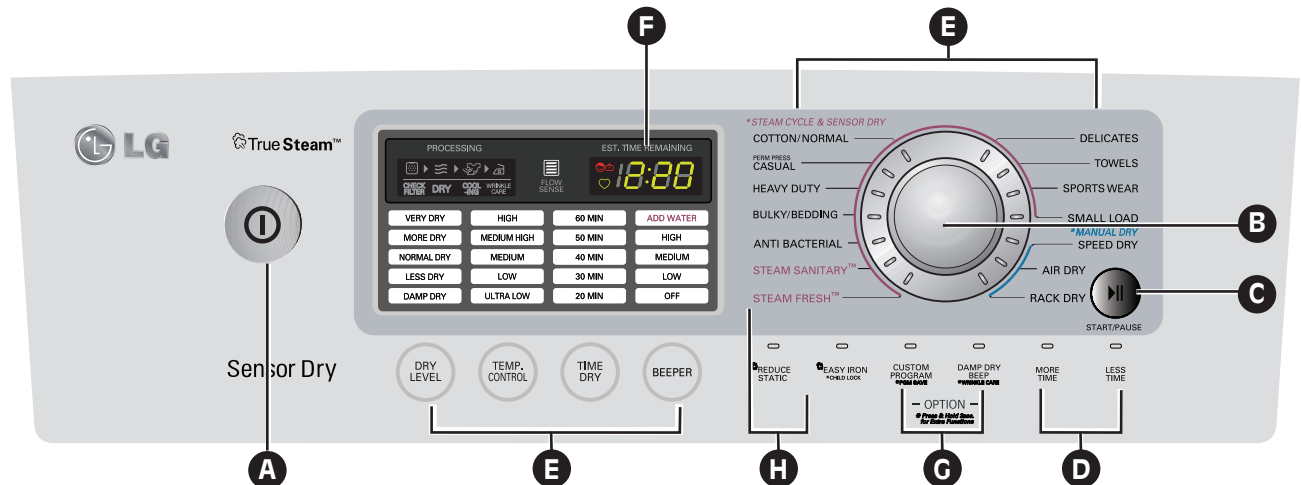

A POWER ON/OFF BUTTON

Press to turn the dryer ON. Press again to turn the dryer OFF.

NOTE: Pressing the ON/OFF button during a cycle will cancel that cycle and any load settings will be lost.

B CYCLE SELECTOR KNOB

Turn this knob to select the desired cycle. Once the desired cycle has been selected, the standard presets will be shown in the display. On MANUAL DRY cycles, these settings can be adjusted using the cycle settings buttons anytime.

C START/PAUSE BUTTON

Press this button to START the selected cycle. If the dryer is running, use this button to PAUSE the cycle without losing the current settings.

NOTE: If you do not press the START/PAUSE button to resume a cycle within 4 minutes, the dryer automatically turns off.

D MORE TIME/LESS TIME BUTTONS

To adjust the drying time, use these buttons with MANUAL DRY, TIME DRY, and STEAMFRESH™ cycles, as well as the REDUCE STATIC and EASY IRON options. Press the MORE TIME button to increase the selected manual cycle time by a minute; press LESS TIME to decrease the cycle time by a minute.

E CYCLE SETTING BUTTONS

Use these buttons to select the desired cycle settings for the selected cycle. The current settings are shown in the display. Press the button for that option to view and select other settings.

F TIME AND STATUS DISPLAY

The display shows the settings, estimated time remaining, options, and status messages for your dryer.

G OPTION BUTTONS

The option buttons allow you to select additional cycle options. Certain buttons feature a special function (see the following pages for details) that can be activated by pressing and holding that option button.

H STEAM FUNCTIONS

LG's steam technology allows you to inject fabrics with a swirling jet of hot steam to refresh clothes, reduce static, and make ironing easier. Simply select the STEAMFRESH™ cycle.

For detailed information about the individual options, please see the following pages.

HOW TO USE

OPERATING THE DRYER

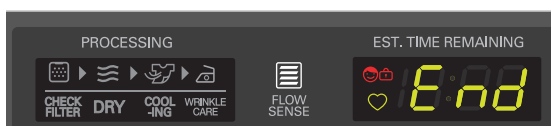
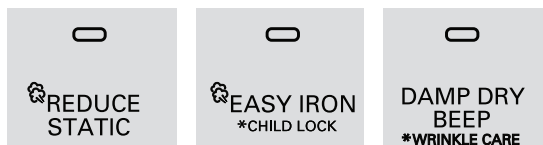
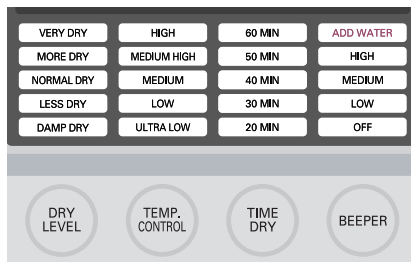
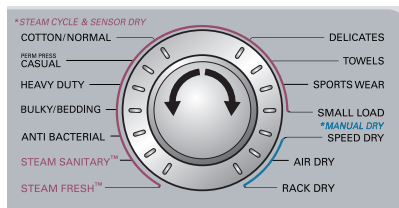
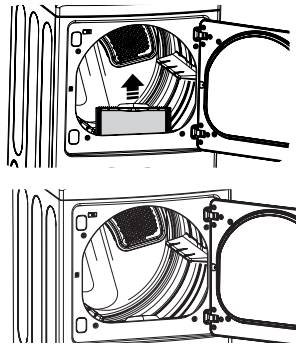

1 CLEAN THE LINT FILTER

If the lint filter has not already been cleaned, lift out the filter and remove the lint from the last load. This will help ensure the fastest and most efficient drying performance.

2 LOAD THE DRYER

Load the dryer with the wet laundry from the washer. If the load is extra large, you may need to divide it into smaller loads for proper performance and fabric care.

3 TURN ON THE DRYER

Press the POWER button to turn on the dryer. The cycle LEDs will illuminate and a beep will sound, if turned on. Refer to page 25.

4 SELECT A CYCLE

Turn the Cycle Selector Knob either direction until the LED for the desired cycle is on. The preset temperature, dry level, and option settings for that cycle will be shown. Refer to page 27.

5 SELECT CYCLE MODIFIERS

Default settings for the selected cycle can now be changed if desired. This can be done using the cycle modifier buttons as shown on page 30 (temperature, dry level, and beeper).

NOTE: Not all options or modifiers are available on all cycles. A different beep will sound and the LED will not come on if the selection is not allowed.

6 SELECT CYCLE OPTIONS

Cycle options can be added using the option buttons as shown on pages 31-32 (Reduce Static, Easy Iron, Child Lock and Wrinkle Care).

NOTE: Not all options or modifiers are available on all cycles. A different beep will sound and the LED.

7 BEGIN CYCLE

Press the START/PAUSE button to begin the cycle. The cycle can be paused at any time either by opening the door or by pressing the START/PAUSE button. If the cycle is not restarted within 4 minutes, the dryer will shut off and the cycle settings will be lost.

8 END OF CYCLE

When the cycle is finished, the chime will sound if it is set. Remove your clothing from the dryer immediately to reduce wrinkling. If Wrinkle Care is selected, the dryer will tumble briefly every few minutes to help prevent wrinkles from setting in the clothes.

CYCLE GUIDE

The cycle guide below shows the options and recommended fabric types for each cycle.

| Type | Cycle | Fabric Type | Dry Level | Temperature | Time in Min. | More Time/ Less Time | Wrinkle Care | Damp Dry | Reduce Static | Easy Iron | |
|--------------------------|--|--|-------------|------------------------|--------------|-------------------------|--------------|----------|---------------|-----------|---|
| STEAM CYCLE / SENSOR DRY | STEAM FRESH™ | Comforter, Shirts, Trouser (except especially delicate fabrics) | Off | MEDIUM HIGH Adjustable | 20 | ● | ● | | ● | ● | |
| | STEAM SANITARY™ | Comforter, Bedding, Children' clothing | Off | HIGH | 39 | | ● | | | | |
| | ANTI-BACTERIAL | Do not use this cycle with delicate fabrics. | Very Dry | HIGH | 70 | | ● | | | | |
| | BULKY/ BEDDING | comforters, Pillows, shirt | Normal Dry | MEDIUM | 55 | | | | | ● | |
| | | | Adjustable | | | | | | | | |
| | HEAVY DUTY | Jeans, heavyweight items | Normal Dry | HIGH | 54 | | | ● | ● | ● | ● |
| | | | Adjustable | | | | | | | | |
| | PERM PRESS CASUAL | Permanent press, synthetic items | Normal Dry | LOW | 36 | | | ● | ● | ● | ● |
| | | | Adjustable | | | | | | | | |
| | COTTON/ NORMAL | Work clothes, corduroys, etc. | Normal Dry | MEDIUM | 41 | | | ● | ● | ● | ● |
| | | | Adjustable | | | | | | | | |
| | DELICATES | Lingerie, sheets, blouses | Normal Dry | LOW | 32 | | | ● | ● | ● | ● |
| Adjustable | | | | | | | | | | | |
| TOWELS | Denims, towels, heavy cottons | Normal Dry | MEDIUM HIGH | 55 | | | ● | ● | ● | ● | |
| | | Adjustable | | | | | | | | | |
| SPORTS WEAR | Sports Wear | Off | - | 27 | | | ● | | ● | | |
| SMALL LOAD | Only Normal & Cotton/Towels Fabric Type (Max 3 lb) | Normal | HIGH | 30 | | | ● | | | | |
| | | Adjustable | | | | | | | | | |
| MANUAL DRY | SPEED DRY | For small loads with short drying times | Off | HIGH | 25 | ● | ● | | ● | ● | |
| | AIR DRY | For items that require heat-free drying such as plastics or rubber | Off | NO HEAT | 30 | ● | ● | | | | |
| | RACK DRY | Wool sweaters, silk, lingerie | Off | OFF | 50 | ● | | | | | |
| ULTRA LOW | | | | | | | | | | | |
| LOW | | | | | | | | | | | |

Sensor Dry Cycles

Sensor Dry cycles utilize LG's unique dual sensor system to detect and compare the moisture level in clothes and in the air and adjust the drying time as needed to ensure superior results. The dryer automatically sets the dryness level and temperature at the recommended setting for each cycle. The estimated time remaining will be shown in the display.

NOTE:

To protect your garments, not every dryness level, temperature, or option is available with every cycle. See the Cycle Guide for details.

Manual Dry Cycles

Use Manual Dry cycles to select a specific amount of drying time and a drying temperature. When a Manual Dry cycle is selected, the ESTIMATED TIME REMAINING display shows the actual time remaining in your cycle. You can change the actual time in the cycle by pressing MORE TIME or LESS TIME.

| | |
|---|---|
|  | Certified by NSF NSF International (formerly the National Sanitation Foundation), certifies that ANTI BACTERIAL Cycle reduces 99.9% of bacteria on laundry, and none of bacteria will carry over onto the next laundry load. |
|---|---|

HOW TO USE

Following are instructions for starting and using your new dryer. Please refer to specific sections of this manual for more detailed information. **Important Warning: To reduce the risk of fire, electric shock, or personal injury, read this entire manual, including the Important Safety Instructions, before operating this dryer.**

SORTING LOADS

Fabric Care Labels

Most articles of clothing feature fabric care labels that include instructions for proper care.

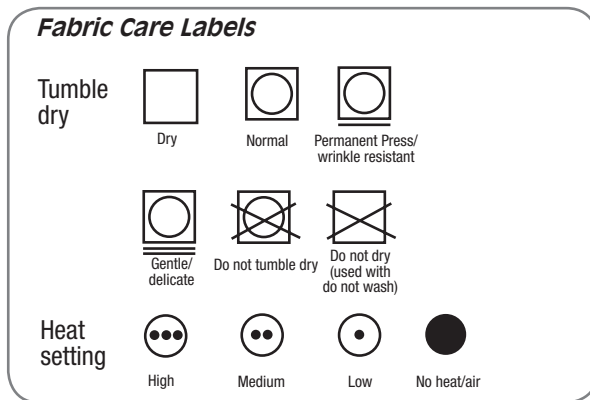

Grouping Similar Items

For best results, sort clothes into loads that can be dried with the same drying cycle. Different fabrics have different care requirements, and some fabrics will dry more quickly than others.

LOADING THE DRYER

⚠WARNING: To reduce the risk of fire, electric shock, or injury to persons when using this appliance, follow basic precautions, including the following:

- **Check all pockets to make sure that they are empty. Items such as clips, pens, coins, and keys can damage both your dryer and your clothes. Flammable objects such as lighters or matches could ignite, causing a fire.** Failure to do so can result in fire, explosion, or death.
- **Never dry clothes that have been exposed to oil, gasoline, or other flammable substances. Washing clothes will not completely remove oil residues.** Failure to obey this warning can result in fire, explosion, or death.

Loading Tips

- Combine large and small items in a load.
- Damp clothes will expand as they dry. Do not overload the dryer; clothes require room to tumble dry properly.
- Close zippers, hooks, and drawstrings to prevent these items from snagging or tangling on other clothes.

CHECK THE LINT FILTER BEFORE EVERY LOAD

Always make sure the lint filter is clean before starting a new load; a clogged lint filter will increase drying times.

To clean, pull the lint filter straight up and roll any lint off the filter with your fingers. Do not rinse or wash the filter to remove lint. Push the lint filter firmly back into place. See **Regular Cleaning (Page 35)** for more information.

Always ensure the lint filter is properly installed before running the dryer. Running the dryer with a loose or missing lint filter may damage the dryer and articles in the dryer.

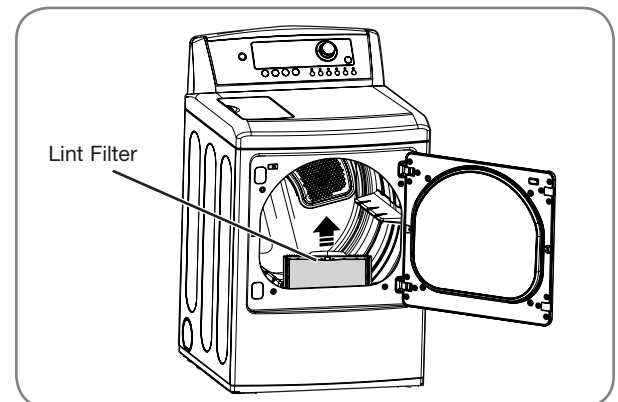

THE DISPLAY

The display shows the settings, estimated time remaining, options, and status messages for your dryer. When the dryer is turned on, the light in the display will illuminate.

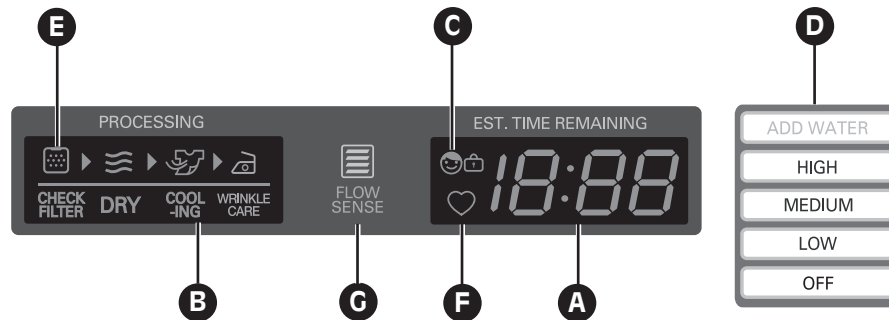

A ESTIMATED TIME REMAINING

When the START/PAUSE button is pressed, the dryer will display the estimated (SENSOR DRY) or set time (TIME DRY) remaining, and begin tumbling.

NOTE: The cycle time on SENSOR DRY cycles may fluctuate as the dryer recalculates drying time for optimal results.

B CYCLE COMPLETION INDICATOR WITH CHECK FILTER REMINDER

This portion of the display shows which stage of the drying cycle is currently underway (CHECK FILTER, DRY, COOLING, WRINKLE CARE).

C CHILD LOCK INDICATOR

When CHILD LOCK is set, the Child Lock indicator will appear and all buttons are disabled except the ON/OFF button. This prevents children from changing settings while the dryer is operating.

D ADD WATER INDICATOR

If the steam feeder is low on water, this error may be displayed. Fill the feeder and restart the cycle.

E CHECK FILTER REMINDER

The display will show CHECK FILTER when the dryer is turned on as a reminder to check the filter. It turns off when the START/PAUSE button is pressed.

F CUSTOM PROGRAM

If you have a special combination of settings that you use frequently, you can save these settings as a CUSTOM PROGRAM.

G FLOW SENSE™ DUCT BLOCKAGE SENSING SYSTEM INDICATOR

The FLOW SENSE™ duct blockage sensing system detects and alerts you to blockages in the ductwork that reduce exhaust flow from the dryer. This improve operating efficiency and help minimize service calls, saving you money.

HOW TO USE

CYCLE SETTING BUTTONS

SENSOR DRY cycles have preset settings that are selected automatically.

MANUAL DRY cycles have default settings, but you may also customize the settings using the cycle setting buttons.

Press the appropriate button for that option to view and select other settings.

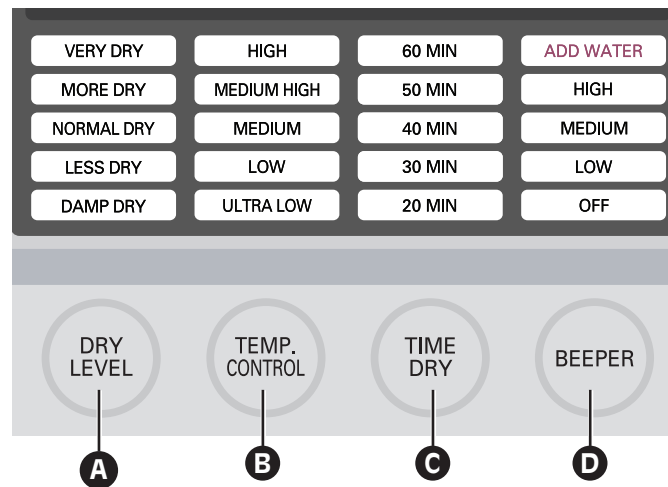

A DRY LEVEL



Selects the level of dryness for the cycle. Press the DRY LEVEL button repeatedly to scroll through available settings.

- This option is only available with SENSOR DRY cycles.
- The dryer will automatically adjust the cycle time. Selecting VERY DRY or MORE DRY will increase the cycle time, while LESS DRY or DAMP DRY will decrease the cycle time.
- Use a LESS DRY or DAMP DRY setting for items that you wish to iron.

C TIME DRY



Allows you to manually select the drying time, from 20 to 60 minutes, in 10-minute increments. Use this for small loads or to remove wrinkles. Use the MORE TIME/LESS TIME buttons to add or reduce the drying time in 1-minute increments.

D BEEPER

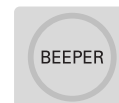

Adjusts the volume of the end-of-cycle beeper, or turns off the beeper.

B TEMP. CONTROL



Adjusts the temperature setting from ULTRA LOW to HIGH. This allows precise care of your fabrics and garments. Press the TEMP. CONTROL button repeatedly to scroll through available settings.

Adjusts the volume of the end-of-cycle beeper, or turns off the beeper.

CYCLE OPTION BUTTONS

Your dryer features several additional cycle options to customize cycles to meet your individual needs. Certain option buttons also feature a special function that can be activated by pressing and holding that option button for 3 seconds.

To Add Cycle Options to a Cycle:

- 1 Turn on the dryer and turn the cycle selector knob to select the desired cycle.
- 2 Use the cycle settings buttons to adjust the settings for that cycle.
- 3 Press the cycle option button for the option you would like to add. A confirmation message will be shown in the display.
- 4 Press the START/PAUSE button to start the cycle. The dryer will start automatically.

DAMP DRY BEEP



With this option, the dryer will beep when the load is approximately 80% dry. This allows you to remove faster-drying lightweight items or items that you would like to iron or hang while still slightly damp.

* WRINKLE CARE



Selecting this function will tumble the load periodically for up to 3 hours after the selected cycle, or until the door is opened. This is helpful in preventing wrinkles when

you are unable to immediately remove items from the dryer. Press and hold the DAMP DRY BEEP button for 3 seconds to activate or deactivate the WRINKLE CARE function.

* CHILD LOCK

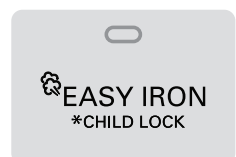

Use this option to prevent unwanted use of the dryer or to keep cycle settings from being changed while the dryer is operating. Press and hold the EASY IRON button for 3 seconds

to activate or deactivate the CHILD LOCK function. The lock icon will be shown in the display, and all controls are disabled except the ON/OFF button.

NOTE: CHILD LOCK lasts after the end of cycle. If you want to deactivate this function, Press and hold the EASY IRON button for 3 seconds.

To Install the Drying Rack

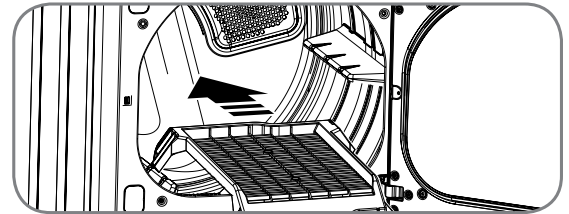

- 1 With the dryer door open, slide the rack into the dryer drum.

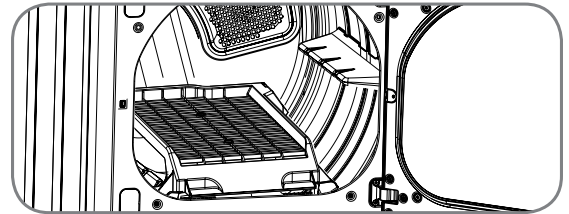

- 2 Make sure it is seated evenly on the edge of the inner door rim and resting flat on the inside of the dryer.

NOTE: Be sure to remove the drying rack after using the RACK DRY cycle.

CUSTOM PROGRAM



If you have a special combination of settings that you use frequently, you can save these settings as a CUSTOM PROGRAM.

NOTE: You may only save one custom program at a time. Pressing and holding the CUSTOM PROGRAM button will overwrite any previously saved custom program.

* To Save a Custom Program:

- 1 Turn on the dryer and turn the cycle selector knob to select the desired cycle.
- 2 Use the cycle setting buttons to adjust the settings for that cycle.
- 3 Press the cycle option button(s) for the option you would like to add. A confirmation message will be shown in the display.
- 4 Press and hold the CUSTOM PROGRAM button for 3 seconds.

To Recall a Custom Program:

- 1 Turn on the dryer.
- 2 Press the CUSTOM PROGRAM button.
- 3 Press the START/PAUSE button to start the cycle.

HOW TO USE

STEAM FUNCTIONS

LG's new steam technology allows you to inject fabrics with a swirling jet of hot steam to refresh clothes, reduce static, and make ironing easier. Simply select the STEAMFRESH™ cycle, or you can add a steam option to selected cycles.

Using the STEAMFRESH™ Cycle

STEAMFRESH™ uses the power of steam alone to quickly reduce wrinkles and odor in fabrics. It brings new life to wrinkled clothes that have been stored for an extended time and makes heavily wrinkled clothes easier to iron. STEAMFRESH™ can also be used to help reduce odors in fabrics.

NOTES:

- REDUCE STATIC or EASY IRON options can also be used during the STEAMFRESH™ cycle.
- Depending on the load (quantity of items), you may change the amount of time for the cycle by pressing the MORE TIME or LESS TIME button. The display will show 3, 5, or $\frac{b}{g}$. 3 means 3 or fewer items, 5 is for 4 or 5 items, and $\frac{b}{g}$ indicates a large load such as a comforter.

To Use the STEAMFRESH™ Cycle:

- 1 Turn on the dryer and turn the cycle selector knob to select the **STEAMFRESH™** cycle.
- 2 To add an option function, select REDUCE STATIC, EASY IRON, or WRINKLE CARE.
- 3 Depending on the load (quantity of items), steam time can be changed by pressing the MORE TIME or LESS TIME buttons.
- 4 Press START/PAUSE button to start the cycle.

To Add STEAM to a Standard Cycle:

- 1 Turn on the dryer and turn the cycle selector knob to select the desired cycle.
- 2 Use the cycle setting buttons to adjust the settings for that cycle.
- 3 Press the Steam option button for the Steam option you would like to add. Then adjust for the load size using the MORE TIME or LESS TIME buttons.

Press START/PAUSE button to start the cycle.

Using the Steam Options:



This option injects steam late in the drying cycle to reduce the static electricity caused by dry fabrics rubbing together. Change the amount of time for the cycle by pressing the MORE TIME or LESS TIME button, depending on the load (quantity of items). The display will show the recommended number of items, such as 7, 9, 11, 14, 16, or 18.



The EASY IRON option provides uniform, properly dampened fabrics for ironing, which can save time and make ironing easier. Change the amount of time for the cycle by pressing the MORE TIME or LESS TIME button, depending on the load (quantity of items). The display will show the recommended number of items, such as 1, 2, 3, 4, or 5.

The REDUCE STATIC and EASY IRON options can only be used with the PERM PRESS CASUAL, HEAVY DUTY, BULKY/BEDDING, COTTON/NORMAL, DELICATES and TOWELS cycles.

NOTES:

- When SENSOR DRY is selected with the REDUCE STATIC option, a DRY LEVEL of LESS or DAMP cannot be selected.
- The REDUCE STATIC or EASY IRON option may also be selected during TIME DRY cycles.
- After the Steam option is selected in TIME DRY, the MORE TIME or LESS TIME buttons will change the steam time ONLY.
- After pressing START/PAUSE, the MORE TIME or LESS TIME buttons will be disabled.

Using the STEAMSANITARY™ cycle

New STEAMSANITARY™ cycle is ideal for sanitizing non washable items quickly and easily using the power of steam alone. Recommend to use this cycle for cotton and polyester material. (Do NOT use for urethane foam, down feathers or delicates items)

HOW TO USE

STEAM FUNCTIONS (cont.)

To Fill the Steam Feeder

1 Open the lid.

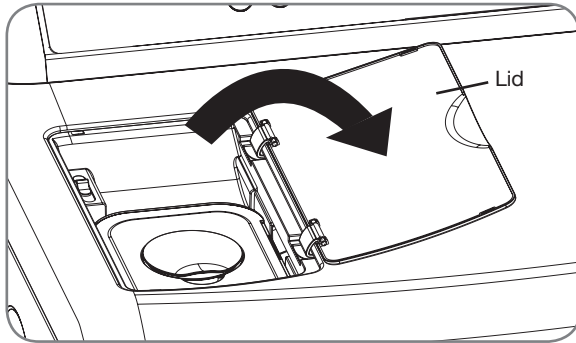

3 Fill the steam feeder to MAX with water.

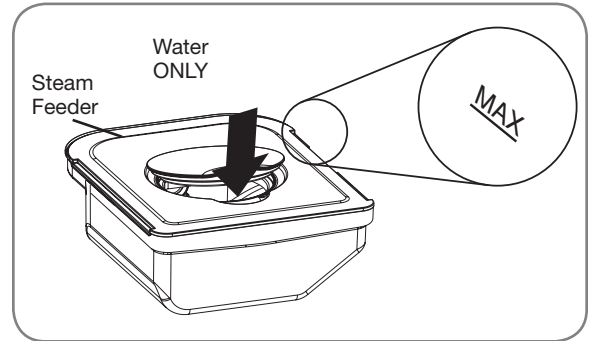

2 Lift out the steam feeder.

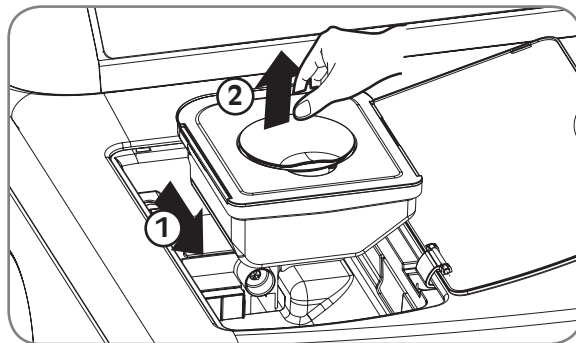

4 Place the steam feeder in the square barrel, then cover the lid.

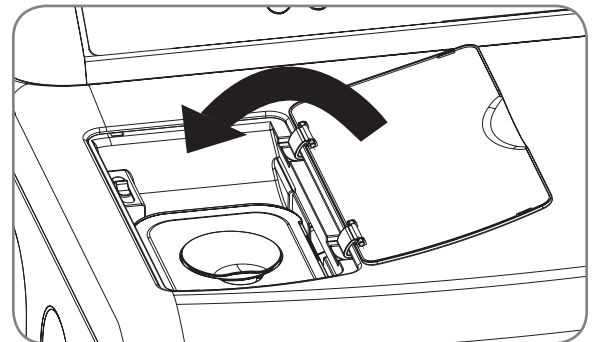

IMPORTANT NOTES ABOUT STEAM CYCLES

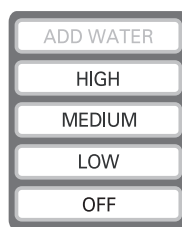

Before using a Steam Cycle, the steam feeder must be filled with water up to the MAX line. If not, the ADD WATER light will blink. Make sure that the steam feeder is filled with water and the cartridge is completely connected. Turn the dryer off then restart the Steam Cycle.

- Only use water. Do not fill the steam feeder with foreign substances, rinse agents, or detergents.
- Before moving the dryer, make sure the steam feeder is empty.
- Do not use distilled water; the water level sensor in the steam generator will not work.
- Be careful while filling the steam feeder to avoid overflow and spilling.
- Wipe up any spilled water around the steam feeder and the drawer before starting the dryer.

⚠ WARNING:

- Do not fill the steam feeder with liquids such as gasoline, dry-cleaning solvents, or other flammable or explosive substances. They give off vapors that could explode.
- Do not fill the steam feeder with hot water (over 86°F/30°C).
- Do not drink water from the steam feeder.

HOW TO USE

STEAM FUNCTIONS (cont.)

⚠ WARNING:

- Do not open the dryer door during steam cycle. Steam can cause severe burns.
- Do not fill the steam feeder with gasoline, dry-cleaning solvents, or other flammable or explosive substances. They give off vapors that could explode.
- Do not drink water from the steam feeder.
- Do not fill the steam feeder with hot water (over 86°F/30°C).
- Do not touch the steam nozzle in the drum during or after the STEAM cycle.

IMPORTANT NOTES ABOUT STEAM CYCLES:

- Steam may not be clearly visible during the steam cycle. This is normal.
- Do not use STEAMFRESH™ with items such as wool, wool blanket, leather jackets, silk, wet clothes, lingerie, foam products, or electric blankets.
- For best results, load articles of similar size and fabric type. Do not overload.
- When the filter/duct is clogged, the steam option may not have optimal results.
- When the steam function is operating, the drum will stop to allow steam to stay in the drum.
- The steam feeder must be filled with water up to the MAX line. Otherwise, an error message will be displayed.

STEAM CYCLE GUIDE

| CYCLE | STEAM | DEFAULT TIME | TEMP. CONTROL | DRY LEVEL | FABRIC STATE | FABRIC TYPE | MAXIMUM AMOUNT |
|--|-----------------------|----------------------------------|---------------|-----------|--------------|--|---------------------------|
| STEAMSANITARY™ | | 39 minutes | | | Dry | Comforter Bedding Children's clothing | Single (1 each) 3 lbs. |
| STEAMFRESH™ | | 20 minutes | ● | | Dry | Comforter Shirts* | Single (1 each) 5 each |
| | + REDUCE STATIC | 10 minutes Only reduce static | | | Dry | Shirts* | 8 lbs. (18 Items.) |
| | + EASY IRON | 12 minutes | | | Dry | | Shirts* (5 each) |
| BULKY/BEDDING HEAVY DUTY PERM PRESS CASUAL COTTON/NORMAL DELICATES TOWELS | + REDUCE STATIC | Follow selected cycle | | ● | Wet | Follow selected cycle | 8 lbs. (18 Items.) |
| | + EASY IRON | | | ● | Wet | Follow selected cycle | Shirts* (5 each) |
| TIME DRY | + REDUCE STATIC | 45 minutes | ● | | Wet | Follow selected temp | 8 lbs. (18 Items.) |
| | + EASY IRON | 47 minutes | ● | | Wet | Follow selected temp | Shirts* (5 each) |
| SPORTS WEAR | + EASY IRON | 27 minutes | | | Wet | Sports wear | |

*Shirt: 70% cotton/30% poly blend. Avoid especially delicate fabrics.

- When the lint filter or exhaust duct is clogged, steam options will not give proper results.
- For best results, load articles of similar size and fabric type. Do not overload.

USER-MAINTENANCE INSTRUCTIONS

REGULAR CLEANING

⚠ WARNING: To reduce the risk of fire, electric shock, or personal injury when using this appliance, follow basic precautions, including the following:

- **Unplug the dryer before cleaning to avoid the risk of electric shock.** Failure to follow this warning can cause serious injury, fire, electrical shock, or death.
- **Never use harsh chemicals, abrasive cleaners, or solvents to clean the washer.** They will damage the finish.

Cleaning the Exterior

Proper care of your dryer can extend its life. The outside of the machine can be cleaned with warm water and a mild, nonabrasive household detergent.

Immediately wipe off any spills with a soft, damp cloth.

IMPORTANT: Do not use methylated spirits, solvents, or similar products.

Never use steel wool or abrasive cleansers; they can damage the surface.

Cleaning the Interior

Wipe around the door opening and seal with a soft, damp cloth to prevent lint and dust buildup that could damage the door seal.

Clean the window with a soft cloth dampened with warm water and a mild, nonabrasive household detergent; then wipe dry.

The stainless steel drum can be cleaned with a conventional stainless steel cleaner, used according to the manufacturer's specifications. Never use steel wool or abrasive cleansers; they can scratch or damage the surface.

Cleaning Around and Under the Dryer

Vacuum lint and dust from around the dryer and underneath it regularly. Vent ductwork should be checked for lint buildup and cleaned at least once per year. If any noticeable reduction in airflow or drying performance occurs, immediately check ductwork for obstructions and blockages.

Maintaining Ductwork

Vent ductwork should be checked for lint buildup and cleaned at least once per year. If any noticeable reduction in airflow or drying performance occurs, immediately check ductwork for obstructions and blockages. Contact a qualified technician or service provider.

Cleaning the Lint Filter

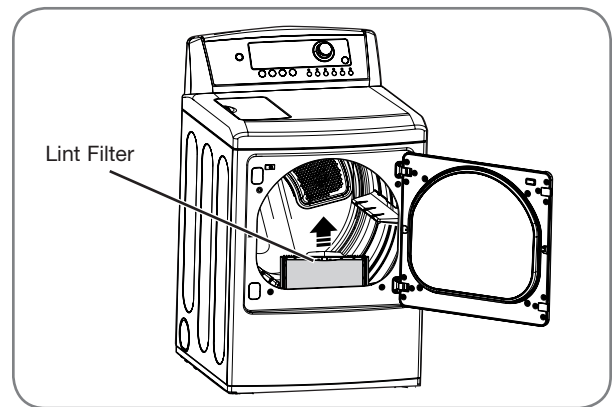

Always clean the lint filter after every cycle.

To clean, open the dryer door and pull the lint filter straight up. Then:

- 1 Roll any lint off the filter with your fingers, or

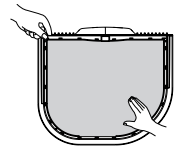

- 2 Vacuum the lint filter, or

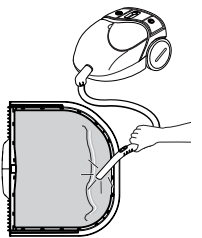

- 3 Wash the lint filter in warm, soapy water and allow to dry thoroughly before reinstalling.

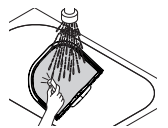

NOTE: NEVER operate the dryer without the lint filter in place.

TROUBLESHOOTING

BEFORE CALLING FOR SERVICE

Your dryer is equipped with an automatic error-monitoring system to detect and diagnose problems at an early stage. If your dryer does not function properly or does not function at all, check the following before you call for service.

| Problem | Possible Causes | Solutions |
|--|---|--|
| Dryer will not turn on | <ul style="list-style-type: none"> • Power cord is not properly plugged in. • House fuse is blown, circuit breaker has tripped, or power outage has occurred. | <ul style="list-style-type: none"> • Make sure that the plug is plugged securely into a grounded outlet matching the dryer's rating plate. • Reset circuit breaker or replace fuse. Do not increase fuse capacity. If the problem is a circuit overload, have it corrected by a qualified electrician. |
| Dryer does not heat | <ul style="list-style-type: none"> • House fuse is blown, circuit breaker has tripped, or power outage has occurred. • Gas supply or service turned off (gas models only). | <ul style="list-style-type: none"> • Reset circuit breaker or replace fuse. Do not increase fuse capacity. If the problem is a circuit overload, have it corrected by a qualified electrician. • Confirm that the house gas shutoff and the dryer gas shutoff are both fully open. |
| Greasy or dirty spots on clothes | <ul style="list-style-type: none"> • Fabric softener used incorrectly. • Clean and dirty clothes being dried together. • Clean and dirty clothes being dried together. | <ul style="list-style-type: none"> • Confirm and follow the instructions provided with your fabric softener. • Make sure to use your dryer to dry only clean items, because dirty items can soil clean clothes placed in the same or subsequent loads. • Stains on dried clothes are actually stains that weren't removed during the washing process. Make sure that clothes are being completely cleaned according to the instructions for your washer and detergent. |
| Display shows error code tE1 or tE2 | <ul style="list-style-type: none"> • Thermistor is malfunctioning. | <ul style="list-style-type: none"> • Turn off the dryer and call for service. |
| Lint on clothes | <ul style="list-style-type: none"> • Lint filter not cleaned properly. • Laundry not sorted properly. • Excess static in clothes. • Dryer is overloaded. • Tissue, paper, etc., left in pockets. | <ul style="list-style-type: none"> • Make sure the lint filter is cleaned before every load. With some loads that produce high amounts of lint, it may be necessary to clean the filter during the cycle. • Some fabrics are lint producers (i.e., a fuzzy white cotton towel) and should be dried separately from clothes that are lint trappers (i.e., a pair of black linen pants). • See the <i>Excess static in clothes after drying</i> section below. • Divide larger loads into smaller loads for drying. • Check pockets thoroughly before washing and drying clothes. |
| Excess static in clothes after drying | <ul style="list-style-type: none"> • Fabric softener not used or used incorrectly. • Clothes dried too long (overdried). • Drying synthetics, permanent press, or synthetic blends. | <ul style="list-style-type: none"> • Use a fabric softener to reduce static electricity. Be sure to follow the manufacturer's instructions. • Overdrying a load of laundry can cause a buildup of static electricity. Adjust settings and use a shorter drying time, or use SENSOR DRY cycles. • These materials can cause static buildup. Try using a fabric softener. |

TROUBLESHOOTING

BEFORE CALLING FOR SERVICE (cont.)

| Problem | Possible Causes | Solutions |
|---|--|---|
| Drying time is not consistent | <ul style="list-style-type: none"> Heat settings, load size, or dampness of clothing is not consistent. | <ul style="list-style-type: none"> The drying time for a load will vary depending on the heat setting, the type of heat used (electric, natural, or LP gas), the size of the load, the type of fabrics, the wetness of the clothes, and the condition of the exhaust ducts and lint filter. |
| Clothes take too long to dry | <ul style="list-style-type: none"> Load is not properly sorted. Large load of heavy fabrics. Dryer controls are not set properly. Lint filter needs to be cleaned. Exhaust ducts blocked, dirty, or duct run is too long. House fuse is blown, circuit breaker has tripped, or power outage has occurred. Dryer is overloaded. Dryer is underloaded. | <ul style="list-style-type: none"> Separate heavy items from lightweight items. Larger and heavier items take longer to dry. Heavy fabrics take longer to dry because they tend to retain more moisture. To help reduce and maintain more consistent drying times for large and heavy fabrics, separate these items into smaller loads of a consistent size. Use the appropriate control settings for the type of load you are drying. Make sure the lint filter is cleaned before every load. With some loads that produce high amounts of lint, it may be necessary to clean the filter during the cycle. Confirm that the exhaust ductwork is properly configured and free of debris, lint, and obstructions. Make sure that outside wall dampers can open properly and are not blocked, jammed, or damaged. Reset circuit breaker or replace fuse. Do not increase fuse capacity. If the problem is a circuit overload, have it corrected by a qualified electrician. Divide larger loads into smaller loads for drying. If you are drying a very small load, add a few extra items to ensure proper tumbling action. |
| Clothes are wrinkled | <ul style="list-style-type: none"> Clothes dried too long (overdried). Clothes left in dryer too long after cycle ends. | <ul style="list-style-type: none"> Overdrying a load of laundry can lead to wrinkled clothes. Try a shorter drying time, and remove items while they still retain a slight amount of moisture. Remove items from the dryer immediately at the end of the cycle. Use the WRINKLE CARE option to continue tumbling clothes at the end of the cycle, for up to 3 hours. |
| Clothes are shrinking | <ul style="list-style-type: none"> Garment care instructions are not being followed. | <ul style="list-style-type: none"> To avoid shrinkage, please carefully follow the fabric care instructions for your garment, because some fabrics will naturally shrink when washed. Other fabrics can be washed but will shrink when dried in a dryer. Use a low or no heat setting and/or the RACK DRY option. |
| ADD WATER indicator light is on during the drying cycle and beep | <ul style="list-style-type: none"> Water supply error. | <ul style="list-style-type: none"> Check steam feeder drawer: <ol style="list-style-type: none"> Make sure steam feeder is filled with water to MAX line. Make sure steam feeder is seated properly and drawer is fully closed. Turn the dryer off then restart the Steam cycle. Do not use distilled water; the water level sensor in steam generator will not work. Pump not working. Unplug dryer and call for service. |
| Water drips from nozzle when Steam Cycle starts. | <ul style="list-style-type: none"> This is normal. | <ul style="list-style-type: none"> This is steam condensation. The dripping water will stop after a short time. |

TROUBLESHOOTING

BEFORE CALLING FOR SERVICE (cont.)

| Problem | Possible Causes | Solutions |
|--|---|---|
| Steam doesn't generate but no error code is shown. | <ul style="list-style-type: none"> Water level error. | <ul style="list-style-type: none"> Unplug dryer and call for service. |
| Garments still wrinkled after STEAMFRESH™. | <ul style="list-style-type: none"> Too many or too different types of garments in dryer. | <ul style="list-style-type: none"> Small loads of 1 to 5 items work best. Load fewer garments. Load similar-type garments. |
| There are no creases left on garment after STEAMFRESH™. | <ul style="list-style-type: none"> The function of this cycle is to remove wrinkles from fabric. | <ul style="list-style-type: none"> Use an iron to make creases. |
| Garments have static after REDUCE STATIC. | <ul style="list-style-type: none"> This is normal. | <ul style="list-style-type: none"> Depends on individual moisture level in skin. |
| Garments are too damp or too dry after REDUCE STATIC. | <ul style="list-style-type: none"> Correct drying options not selected. | <ul style="list-style-type: none"> Select load weight manually before starting REDUCE STATIC option. |
| Garments are not uniformly damp after EASY IRON. | <ul style="list-style-type: none"> This is normal. | <ul style="list-style-type: none"> Depends on the amount or type of garments. |
| Water drips from door during Steam Cycle. | <ul style="list-style-type: none"> This is normal. | <ul style="list-style-type: none"> This is steam condensation on door surface. |
| Steam is not visible during Steam Cycle. | <ul style="list-style-type: none"> This is normal. | <ul style="list-style-type: none"> Steam vapor is difficult to see when the door is closed. |
| Drum does not turn during Steam Cycle. | <ul style="list-style-type: none"> This is normal. | <ul style="list-style-type: none"> The drum is turned off so that the steam vapor remains in the drum. |
| Cannot see steam vapor at the beginning of cycle. | <ul style="list-style-type: none"> This is normal. | <ul style="list-style-type: none"> Steam is released at different stages of the cycle for each option. |
| The display shows. <i>bl 9</i> | <ul style="list-style-type: none"> MORE TIME button pressed. | <ul style="list-style-type: none"> Pressing the MORE TIME button several times will set the cycle for a large load such as a comforter. |
| Odors remain in clothing after STEAMFRESH™. | <ul style="list-style-type: none"> STEAMFRESH™ did not remove odor completely. | <ul style="list-style-type: none"> Fabrics containing strong odors should be washed in a normal cycle. |
| FLOW SENSE indicator light is on during the drying cycle | <ul style="list-style-type: none"> Ductwork is too long or has too many turns/restrictions. Significant blockage of the ductwork due to lint buildup or debris. | <ul style="list-style-type: none"> Install a shorter or straighter duct run. See the Installation Instructions. Ductwork should be checked/cleaned soon. Dryer can be used in this condition, but drying times may be longer. |

SPECIFICATIONS

KEY DIMENSIONS AND SPECIFICATIONS

The appearance and specifications listed in this guide may vary due to constant product improvements.

| Dryer Models DLEX5101W, DLGX5102W , DLEX5101V, DLGX5102V | |
|--|--|
| Description | STEAM DRYER |
| Electrical Requirements* | Please refer to the rating label regarding detailed information. |
| Gas Requirements* | NG: 10–13 inches WC/LP: 10–13 inches WC (Gas Models only) |
| Dimensions | 27" (W) X 28 ¹⁵ / ₁₆ " (D) X 45 ⁷ / ₁₆ " (H), 50 ¹ / ₄ " (D with door open) 68.6 cm (W) X 73.4 cm (D) X 115.3 cm (H), 127.5 cm (D with door open) |
| Net Weight | 133.2 lb (60.4 kg) |
| Drying Capacity - Normal Cycle | IEC 7.3 cu.ft. (22.5 lb/10.2 kg) |

*Refer to the rating plate on your dryer.

LG ELECTRONICS, INC. LG DRYER LIMITED WARRANTY - USA



Your LG Dryer will be repaired or replaced, at LG's option, if it proves to be defective in material or workmanship under normal use, during the warranty period ("Warranty Period") set forth below, effective from the date ("Date of Purchase") of original consumer purchase of the product. This warranty is good only to the original purchaser of the product and effective only when used in the United States, including Alaska, Hawaii, and U.S. Territories.

ENGLISH

| | |
|---|--|
| <p><u>WARRANTY PERIOD:</u></p> <p>LABOR: One Year from the Date of Purchase.</p> <p>PARTS: One Year from the Date of Purchase.</p> <p>Replacement Units and Repair Parts may be new or remanufactured.</p> <p>Replacement Units and Repair Parts are warranted for the remaining portion of the original unit's warranty period.</p> | <p><u>HOW SERVICE IS HANDLED:</u></p> <p>In-Home Service:</p> <p>Please retain dealer's dated bill of sale or delivery ticket as evidence of the Date of Purchase for proof of warranty, and submit a copy of the bill of sale to the service person at the time warranty service is provided.</p> <p>Please call 1-800-243-0000 and choose the appropriate option to locate your nearest LG Authorized Service Center.</p> <p>Or visit our Web site at: http://www.lgservice.com.</p> |
|---|--|

THIS WARRANTY IS IN LIEU OF ANY OTHER WARRANTY, EXPRESS OR IMPLIED, INCLUDING WITHOUT LIMITATION, ANY WARRANTY OF MERCHANTABILITY OR FITNESS FOR A PARTICULAR PURPOSE. TO THE EXTENT ANY IMPLIED WARRANTY IS REQUIRED BY LAW, IT IS LIMITED IN DURATION TO THE EXPRESS WARRANTY PERIOD ABOVE. NEITHER THE MANUFACTURER NOR ITS U.S. DISTRIBUTOR SHALL BE LIABLE FOR ANY INCIDENTAL, CONSEQUENTIAL, INDIRECT, SPECIAL, OR PUNITIVE DAMAGES OF ANY NATURE, INCLUDING WITHOUT LIMITATION, LOST REVENUES OR PROFITS, OR ANY OTHER DAMAGE WHETHER BASED IN CONTRACT, TORT, OR OTHERWISE. Some states do not allow the exclusion or limitation of incidental or consequential damages or limitations on how long an implied warranty lasts, so the above exclusion or limitation may not apply to you. This warranty gives you specific legal rights and you may also have other rights that vary from state to state.

THIS LIMITED WARRANTY DOES NOT APPLY TO:

- Service trips to your home to deliver, pick up, and/or install the product, instruct, or replace house fuses or correct wiring, or correction of unauthorized repairs.
- Damages or operating problems that result from misuse, abuse, operation outside environmental specifications or contrary to the requirements of precautions in the Operating Guide, accident, vermin, fire, flood, improper installation, acts of God, unauthorized modification or alteration, incorrect electrical current or voltage, or commercial use, or use for other than intended purpose.

The cost of repair or replacement under these excluded circumstances shall be borne by the consumer.

CUSTOMER INTERACTIVE CENTER NUMBERS

| | |
|--|--|
| <p>To obtain Customer Assistance, Product Information, or Dealer or Authorized Service Center location:</p> | <p>Call 1-800-243-0000 (24 hours a day, 365 days per year), and select the appropriate option from the menu.</p> <p>Or visit our Web site at: http://www.lgservice.com.</p> |
|--|--|

TO CONTACT LG ELECTRONICS BY MAIL:

LG Customer Interactive Center
P. O. Box 240007
201 James Record Road
Huntsville, Alabama 35824
ATTN: CIC

Product Registration Information

Model: _____

Serial Number: _____

Date of Purchase: _____

The model and serial number can be located on the rating plate inside the front door.

LG ELECTRONICS CANADA, INC. LG DRYER LIMITED WARRANTY - Canada

WARRANTY: Should your LG Dryer ("Product") fail due to a defect in material or workmanship under normal home use during the warranty period set forth below, LG Canada will at its option repair or replace the Product upon receipt of proof of original retail purchase. This warranty is valid only to the original retail purchaser of the product and applies only to a Product distributed in Canada by LG Canada or an authorized Canadian distributor thereof. The warranty only applies to Products located and used within Canada.

| | | |
|---|--|---|
| WARRANTY PERIOD: (Note: If the original date of purchase can not be verified, the warranty will begin sixty (60) days from the date of manufacture). | | |
| Dryer | Extended Component Warranty (Parts Only) (Consumer will be charged for Labor after one (1) year from the date of purchase) | |
| One (1) year from the date of original retail purchase | Three (3) years from the date of original retail purchase | Five (5) years from the date of original retail purchase |
| Parts and Labor (internal/functional parts only) | Controller | Drum Tub |

- Replacement products and parts are warranted for the remaining portion of the original warranty period or ninety (90) days, whichever is greater.
- Replacement products and parts may be new or remanufactured.
- LG Authorized Service Center warranties their repair work for thirty (30) days.

LG CANADA'S SOLE LIABILITY IS LIMITED TO THE WARRANTY SET OUT ABOVE. EXCEPT AS EXPRESSLY PROVIDED ABOVE, LG CANADA MAKES NO AND HEREBY DISCLAIMS ALL OTHER WARRANTIES AND CONDITIONS RESPECTING THE PRODUCT, WHETHER EXPRESS OR IMPLIED, INCLUDING, BUT NOT LIMITED TO, ANY IMPLIED WARRANTY OR CONDITION OF MERCHANTABILITY OR FITNESS FOR A PARTICULAR PURPOSE, AND NO REPRESENTATIONS SHALL BE BINDING ON LG CANADA. LG CANADA DOES NOT AUTHORIZE ANY PERSON TO CREATE OR ASSUME FOR IT ANY OTHER WARRANTY OBLIGATION OR LIABILITY IN CONNECTION WITH THE PRODUCT. TO THE EXTENT THAT ANY WARRANTY OR CONDITION IS IMPLIED BY LAW, IT IS LIMITED TO THE EXPRESS WARRANTY PERIOD ABOVE. LG CANADA, THE MANUFACTURER OR DISTRIBUTOR SHALL NOT BE LIABLE FOR ANY INCIDENTAL, CONSEQUENTIAL, SPECIAL, DIRECT OR INDIRECT DAMAGES, LOSS OF GOODWILL, LOST PROFITS, PUNITIVE OR EXEMPLARY DAMAGES OR ANY OTHER DAMAGE, WHETHER ARISING DIRECTLY OR INDIRECTLY FROM ANY CONTRACTUAL BREACH, FUNDAMENTAL OR OTHERWISE, OR FROM ANY ACTS OR OMISSIONS, TORT, OR OTHERWISE.

This warranty gives you specific legal rights. You may have other rights which may vary from province to province depending on applicable provincial laws. Any term of this warranty that negates or varies any implied condition or warranty under provincial law is severable where it conflicts with provincial law without affecting the remainder of this warranty's terms.

THIS LIMITED WARRANTY DOES NOT COVER:

1. Service trips to deliver, pick up, or install the product; instructing a customer on operation of the product; repair or replacement of fuses or correction of wiring, or correction of unauthorized repairs/installation.
2. Failure of the product to perform during power failures and interruptions or inadequate electrical service.
3. Damage caused by leaky or broken water pipes, frozen water pipes, restricted drain lines, inadequate or interrupted water supply or inadequate supply of air.
4. Damage resulting from operating the Product in a corrosive atmosphere or contrary to the instructions outlined in the Product owner's manual.
5. Damage to the Product caused by accidents, pests and vermin, lightning, wind, fire, floods, or acts of God.
6. Damage resulting from the misuse, abuse, improper installation, repair, or maintenance of the Product. Improper repair includes use of parts not approved or specified by LG Canada.
7. Damage or product failure caused by unauthorized modification or alteration, or use for other than its intended purpose, or resulting from any water leakage due to improper installation.
8. Damage or Product failure caused by incorrect electrical current, voltage, commercial or industrial use, or use of accessories, components, or cleaning products that are not approved by LG Canada.
9. Damage caused by transportation and handling, including scratches, dents, chips, and/or other damage to the finish of your product, unless such damage results from defects in materials or workmanship and is reported within one (1) week of delivery.
10. Damage or missing items to any display, open box, discounted, or refurbished Product.
11. Products with original serial numbers that have been removed, altered, or cannot be readily determined. Model and Serial numbers, along with original retail sales receipt, are required for warranty validation.
12. Increases in utility costs and additional utility expenses. Replacement of light bulbs, filters, or any consumable parts. Repairs when your Product is used in other than normal and usual household use (including, without limitation, commercial use, in offices or recreational facilities) or contrary to the instructions outlined in the Product owner's manual.
15. Costs associated with removal of the Product from your home for repairs.
16. The removal and reinstallation of the Product if it is installed in an inaccessible location or is not installed in accordance with published installation instructions, including the Product owner's and installation manuals.
17. Accessories to the Product such as door bins, drawers, handles, shelves, etc.. Also excluded are parts besides those that were originally included with the Product.

All costs associated with the above excluded circumstances shall be borne by the consumer.

For complete warranty details and customer assistance, please call or visit our website:

Call 1-888-542-2623 (24 hours a day, 365 days a year) and select the appropriate option from the menu, or visit our website at <http://www.lg.ca>

Write your warranty information below:

Product Registration Information:

Model:

Serial Number:

Date of Purchase:



This product qualifies for ENERGY STAR in the "factory default (Home Use)" setting.

Changing the factory default settings or enabling other features may increase power consumption that could exceed the limits necessary to qualify for ENERGY STAR.

LG Customer Information Center

1-800-243-0000 USA

1-888-542-2623 CANADA

Register your product Online!

www.lge.com

Free Manuals Download Website

<http://myh66.com>

<http://usermanuals.us>

<http://www.somanuals.com>

<http://www.4manuals.cc>

<http://www.manual-lib.com>

<http://www.404manual.com>

<http://www.luxmanual.com>

<http://aubethermostatmanual.com>

Golf course search by state

<http://golfingnear.com>

Email search by domain

<http://emailbydomain.com>

Auto manuals search

<http://auto.somanuals.com>

TV manuals search

<http://tv.somanuals.com>