



PLASMA MONITOR OWNER'S MANUAL

MODELS: 42PM1M 42PM1M-UC
42PM3MV 42PM3MV-UC
50PM1M 50PM1M-UC

Please read this manual carefully and completely before operating your Monitor.
Retain this manual for future reference.
Record model number and serial number of the Monitor in the spaces provided below.
See the label attached on the back cover and relate this information to your dealer if you require service.

Model Number :
Serial Number :

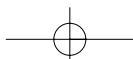

Warning/Caution



WARNING/CAUTION:

TO REDUCE THE RISK OF ELECTRIC SHOCK DO NOT REMOVE COVER (OR BACK). NO USER SERVICEABLE PARTS INSIDE. REFER TO QUALIFIED SERVICE PERSONNEL.



The lightning flash with arrowhead symbol, within an equilateral triangle, is intended to alert the user to the presence of uninsulated "dangerous voltage" within the product's enclosure that may be of sufficient magnitude to constitute a risk of electric shock to persons.



The exclamation point within an equilateral triangle is intended to alert the user to the presence of important operating and maintenance (servicing) instructions in the literature accompanying the appliance.

WARNING/CAUTION:

TO PREVENT FIRE OR SHOCK HAZARDS, DO NOT EXPOSE THIS PRODUCT TO RAIN OR MOISTURE.

FCC NOTICE

• A Class B digital device

This equipment has been tested and found to comply with the limits for a Class B digital device, pursuant to Part 15 of the FCC Rules. These limits are designed to provide reasonable protection against harmful interference in a residential installation. This equipment generates, uses and can radiate radio frequency energy and, if not installed and used in accordance with the instructions, may cause harmful interference to radio communications. However, there is no guarantee that interference will not occur in a particular installation. If this equipment does cause harmful interference to radio or television reception, which can be determined by turning the equipment off and on, the user is encouraged to try to correct the interference by one or more of the following measures:

- Reorient or relocate the receiving antenna.
- Increase the separation between the equipment and receiver.
- Connect the equipment into an outlet on a circuit different from that to which the receiver is connected.
- Consult the dealer or an experienced radio/TV technician for help.

• Any changes or modifications not expressly approved by the party responsible for compliance could void the user's authority to operate the equipment.

CAUTION:

Do not attempt to modify this product in any way without written authorization from LG Electronics. Unauthorized modification could void the user's authority to operate this product.

COMPLIANCE:

The responsible party for this product's compliance is:

LG Electronics U.S.A., Inc
1000 Sylvan Avenue, Englewood Cliffs, NJ 07632
1-800-243-0000
<http://www.lgusa.com>

WARNING/CAUTION

TO REDUCE THE RISK OF FIRE AND ELECTRIC SHOCK, DO NOT EXPOSE THIS PRODUCT TO RAIN OR MOISTURE.

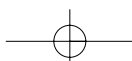

Safety Instructions

IMPORTANT SAFETY INSTRUCTIONS

Important safety instructions shall be provided with each apparatus. This information shall be given in a separate booklet or sheet, or be located before any operating instructions in an instruction for installation for use and supplied with the apparatus.

This information shall be given in a language acceptable to the country where the apparatus is intended to be used.

The important safety instructions shall be entitled "Important Safety Instructions". The following safety instructions shall be included where applicable, and, when used, shall be verbatim as follows. Additional safety information may be included by adding statements after the end of the following safety instruction list. At the manufacturer's option, a picture or drawing that illustrates the intent of a specific safety instruction may be placed immediately adjacent to that safety instruction :

1. Read these instructions.

2. Keep these instructions.



3. Heed all warnings.

4. Follow all instructions.

8. Do not install near any heat sources such as radiators, heat registers, stoves, or other apparatus (including amplifiers) that produce heat.



5. Do not use this apparatus near water.



9. Do not defeat the safety purpose of the polarized or grounding-type plug. A polarized plug has two blades with one wider than the other. A grounding type plug has two blades and a third grounding prong. The wide blade or the third prong are provided for your safety. If the provided plug does not fit into your outlet, consult an electrician for replacement of the obsolete outlet.

6. Clean only with dry cloth.

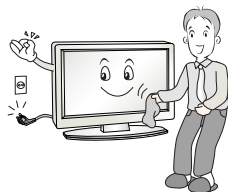

10. Protect the power cord from being walked on or pinched particularly at plugs, convenience receptacles, and the point where they exit from the apparatus.

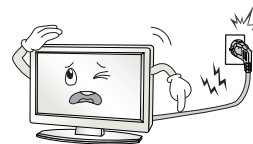

7. Do not block any ventilation openings. Install in accordance with the manufacturer's instructions.



11. Only use attachments/accessories specified by the manufacturer.

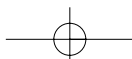

Safety Instructions

12. Use only with the cart, stand, tripod, bracket, or table specified by the manufacturer, or sold with the apparatus. When a cart is used, use caution when moving the cart/apparatus combination to avoid injury from tip-over.



13. Unplug this apparatus during lightning storms or when unused for long periods of time.



14. Refer all servicing to qualified service personnel. Servicing is required when the apparatus has been damaged in any way, such as power-supply cord or plug is damaged, liquid has been spilled or objects have fallen into the apparatus, the apparatus has exposed to rain or moisture, does not operate normally, or has been dropped.



15. CAUTION concerning the Power Cord :

Most appliances recommend they be placed upon a dedicated circuit; that is, a single outlet circuit which powers only that appliance and has no additional outlets or branch circuits. Check the specification page of this owner's manual to be certain.

Do not overload wall outlets. Overloaded wall outlets, loose or damaged wall outlets, extension cords, frayed power cords, or damaged or cracked wire insulation are dangerous. Any of these conditions could result in electric shock or fire. Periodically examine the cord of your appliance, and if its appearance indicates damage or deterioration, unplug it, discontinue use of the appliance, and have the cord replaced with an exact replacement part by an authorized servicer.

Protect the power cord from physical or mechanical abuse, such as being twisted, kinked, pinched, closed in a door, or walked upon. Pay particular attention to plugs, wall outlets, and the point where the cord exits the appliance.

16. Outdoor Use Marking :

WARNING - To Reduce The Risk Of Fire Or Electric Shock, Do Not Expose This Appliance To Rain Or Moisture.

17. Wet Location Marking :

Apparatus shall not be exposed to dripping or splashing and no objects filled with liquids, such as vases, shall be placed on the apparatus.

18. Any DATA saved on HDD may be lost or damaged, making a back up copy of data is strongly recommended. The manufacturer will NOT be responsible for any data loss or damage.

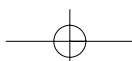

Contents

Warning/Caution	2	Time Setting	
Safety Instructions	3-4	Clock Setup	22
Introduction		On/Off Timer Setup	22
Accessories	7	Auto Off / Sleep Timer	23
Controls	7	Optional Features	
Connection Options	8	Key Lock	24
Remote Control Key Functions	9	ISM (Image Sticking Minimization) Method ...	24
Installation Instructions		Low Power	25
Desktop Pedestal Installation	10	XD Demo	25
External Equipment Connections		OSD Rotate	25
VCR Setup / Cable TV Setup	11	Screen Adjustment	
External A/V Source Setup	12	Auto Adjustment	26
DVD Setup	12	Setting Picture Format	26
DTV Setup	13	Manual Configure	26
Monitor Output Setup	13	Selecting VGA/XGA Mode (RGB Mode Only) .	27
PC Setup	14~15	Picture size Zoom	27
Basic Operation		Screen Position	27
Turning the monitor On	16	Cinema Mode Setup	27
Volume Adjustment	16	NR (Noise Reduction)	28
On-screen Menu Language Selection	16	Initializing (Reset to original factory value) .	28
On Screen Menu Selection and Adjustment .	17	Split Zoom	28
Picture Adjustment		Lock Adjustment	
APC (Auto Picture Control)	18	Setting Up Your password	29
XD	18	Lock System	29
Color Temperature Control	18	Set Password	30
ACM	19	MPAA(Movie rating)	30
sRGB	19	Age block	31
Manual Picture Control(Off option)	19	Content block	31
Audio Adjustment		Aux. Block	32
DASP (Digital Auto Sound Processing)	20	Appendix	
BBE	20	External Control Device Setup	33~38
AVL (Auto Volume Leveler)	21	IR Codes	39~40
Manual Sound Control (Off option)	21	Troubleshooting Checklist	41
TV speaker Setup	21	Product Specifications	42
		Warranty	43~44

After reading this manual, keep it handy for future reference.

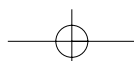

Introduction

What is a Plasma Display Panel (PDP)?

A plasma display panel is the latest display technology and the best way to achieve flat panel displays with excellent image quality and large screen sizes that are easily viewable. The PDP can be thought of as a descendant of the neon lamp and it can be also be viewed as a series of fluorescent lamps.

How does it work?

PDP is an array of cells, known as pixels, which are comprised of 3 sub pixels, corresponding to the colors red, green, and blue. Gas in a plasma state is used to react with phosphors in each sub-pixel to produce colored light (red, green, or blue). These phosphors are the same types used in Cathode Ray Tube (CRT) devices such as televisions and common computer monitors.

You get the rich, dynamic colors that you expect. Each sub-pixel is individually controlled by advanced electronics to produce over 16 million different colors. All of this means that you get perfect images that are easily viewable in a display that is less than 5 inches thick.

160° - Wide angle range of vision

Your flat panel plasma screen offers an exceptionally broad viewing angle -- over 160 degrees. This means that the display is clear and visible to viewers anywhere in the room who can see the screen.

Wide Screen

The screen of the Plasma Display is so wide that your viewing experience is as if you are in a theater.

Multimedia

Connect your plasma display to a PC and you can use it for conferencing, games, and Internet browsing. The Picture-in-Picture feature allows you to view your PC and video images simultaneously.

Versatile

The light weight and thin size makes it easy to install your plasma display in a variety of locations where conventional monitors will not fit.

The PDP Manufacturing Process: a few minute colored dots may be present on the PDP screen

The PDP (Plasma Display Panel), which is the display device of this product is composed of 0.9 to 2.2 million cells. A few cell defects will normally occur in the PDP manufacturing process. Several tiny, minute colored dots visible on the screen should be acceptable. This also occurs in other PDP manufacturers' products. The tiny dots appearing does not mean that this PDP is defective. Thus a few cell defects are not sufficient cause for the PDP to be exchanged or returned. Our production technology minimizes these cell defects during the manufacture and operation of this product.

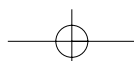

Accessories

Ensure that the following accessories are included with your plasma display. If an accessory is missing, please contact the dealer where you purchased the product.

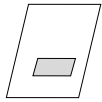

Owner's Manual

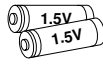

Batteries



Remote Control



Power Cord

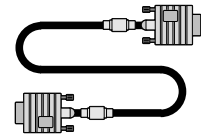

D-sub 15 pin Cable

Controls

- This is a simplified representation of front panel.
Here shown may be somewhat different from your Monitor.

Front Panel Controls

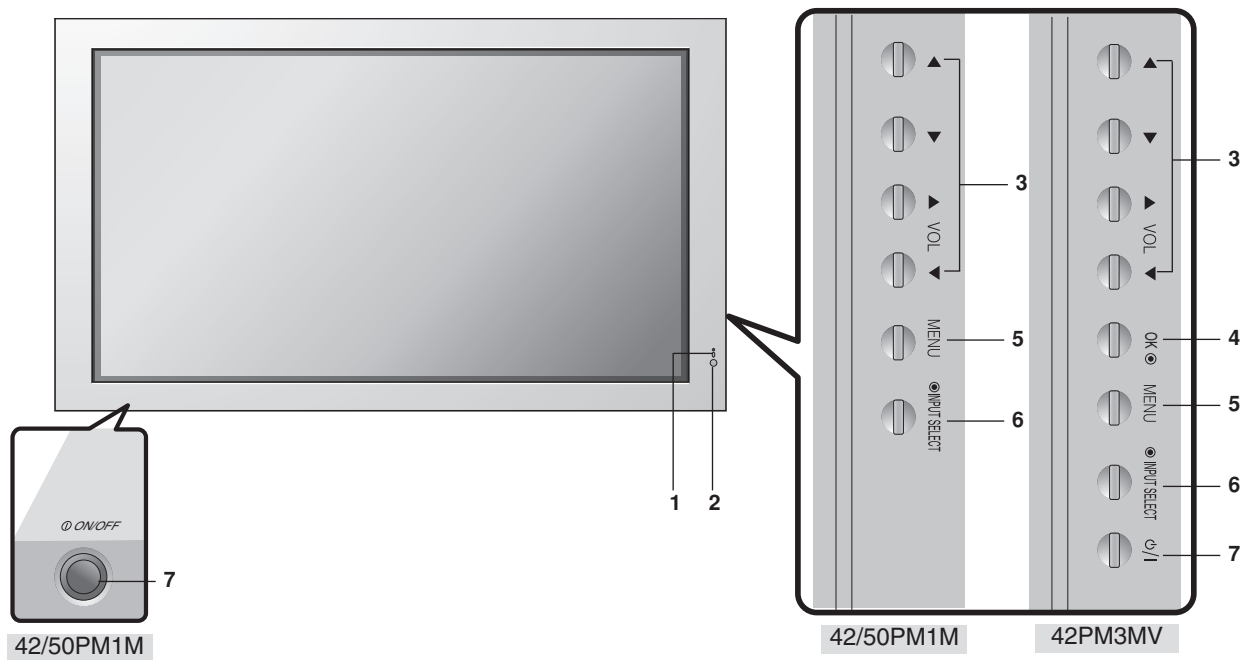

1. Power Standby Indicator

Illuminates red in standby mode, Illuminates green when the Set is turned on.

2. Remote Control Sensor

**3. VOLUME (◀, ▶) Buttons
▼, ▲ Buttons**

4. OK Button

5. MENU Button

6. INPUT SELECT Button

7. Main Power Button

Switches the set on from standby or off to standby.

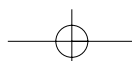

Connection Options

- Connection panels shown may be somewhat different from your Monitor.

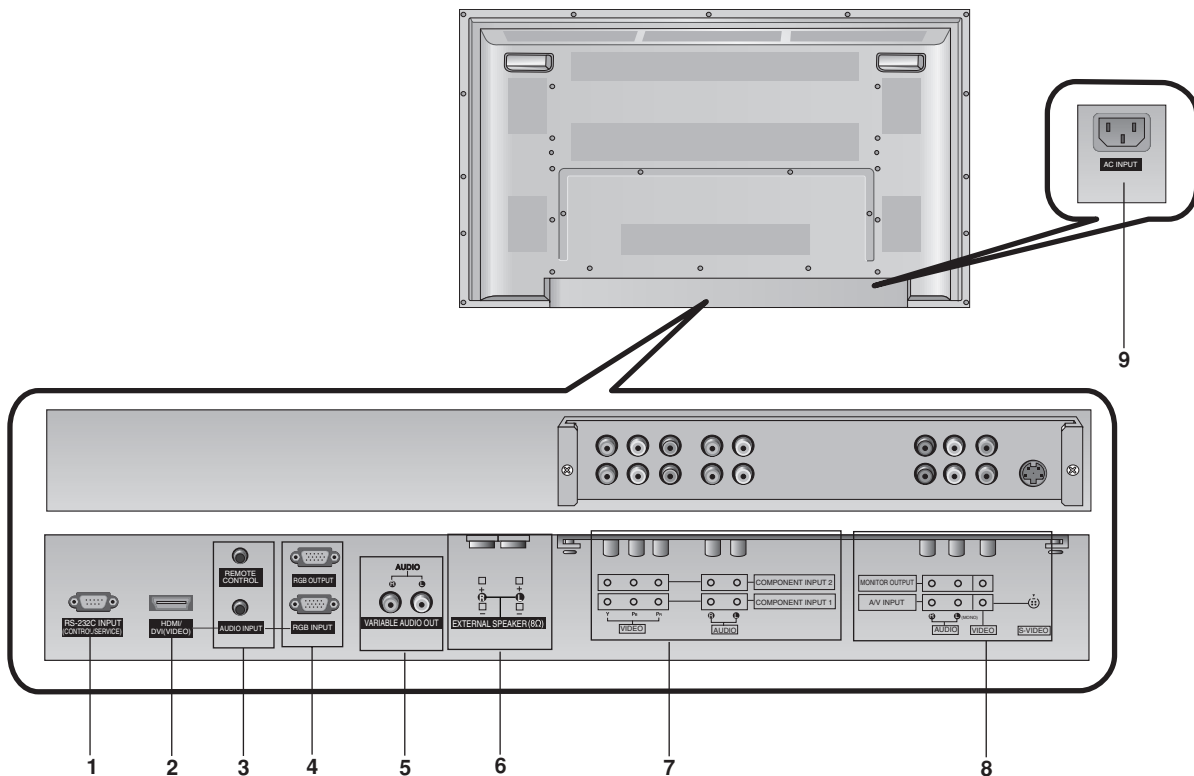

1. RS-232C INPUT (CONTROL/SERVICE) PORT
Connect to the RS-232C port on a PC.

2. HDMI/DVI (VIDEO)
Connect a HDMI signal to this jack. Or connect a DVI (Video) signal.

3. REMOTE CONTROL / AUDIO INPUT (for RGB, DVI)

4. RGB INPUT
Connect the set output connector from a PC to the appropriate input port.

RGB OUTPUT
You can watch the RGB signal on another set, connect RGB OUTPUT to another set's PC input port.

5. VARIABLE AUDIO OUTPUT

6. EXTERNAL SPEAKER (8 ohm output)
Connect to optional external speaker(s).
* For further information, refer to 'Speaker & Speaker Stand' manual.

7. COMPONENT INPUT 1-2
Connect a component video/audio device to these jacks.

8. VIDEO/AUDIO IN/OUT SOCKETS
Connect the video/audio out sockets of external equipment to these sockets.

S-VIDEO/AUDIO IN SOCKETS
Connect the S-VIDEO out socket of an VCR to the **S-VIDEO** socket.

Connect the audio out sockets of the VCR to the audio sockets as in **AV**.

MONITOR OUTPUT
Connect a second Set or monitor.

9. POWER CORD SOCKET
This set operates on an AC power. The voltage is indicated on the Specifications page. Never attempt to operate the set on DC power.

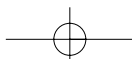

Remote Control Key Functions

- When using the remote control, aim it at the remote control sensor on the Monitor.
- Under certain conditions such as if the remote IR signal is interrupted, the remote control may not function. Press the key again as necessary.

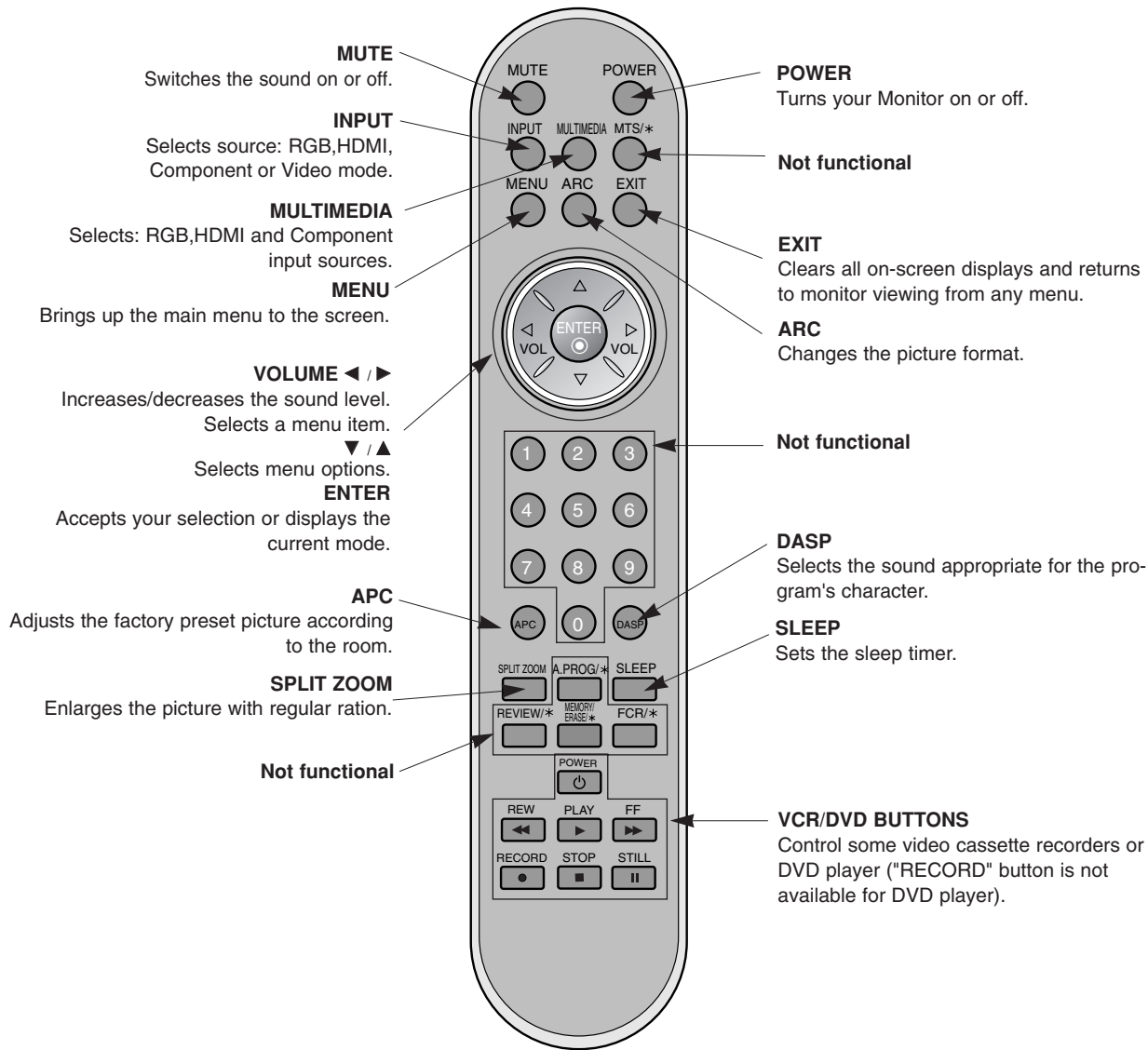

Installing Batteries

- Open the battery compartment cover on the back side and install the batteries matching correct polarity (+ with +, - with -).
- Install two 1.5V AAA batteries. Don't mix old or used batteries with new ones. Replace cover.

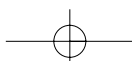
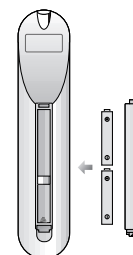

● Installation Instructions

GROUNDING

Ensure that you connect the earth ground wire to prevent possible electric shock. If grounding methods are not possible, have a qualified electrician install a separate circuit breaker. Do not try to ground the unit by connecting it to telephone wires, lightening rods, or gas pipes.

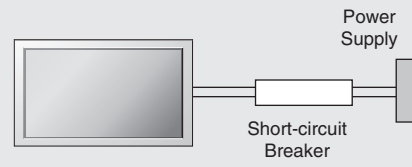

Desktop Pedestal Installation

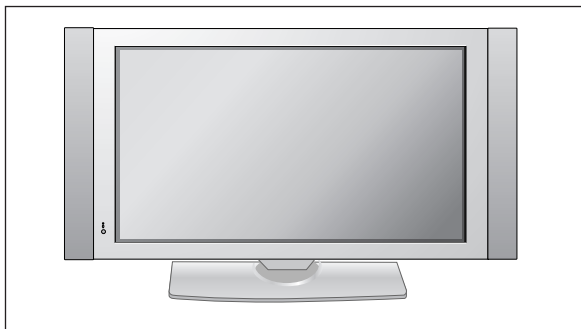

- For proper ventilation, allow a clearance of 4" on each side and the top, 2.36" on the bottom, and 2" from the wall. Detailed installation instructions are included in the optional Desktop Stand Installation.
- Speakers shown are optional, and are shown for example only.

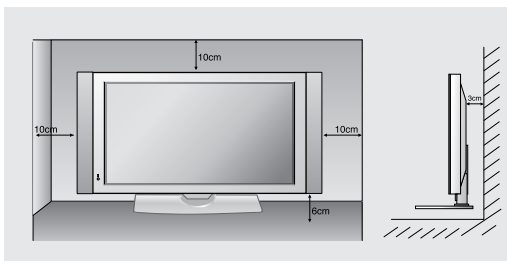

- Pedestal mount minimum allowable clearances for adequate ventilation.

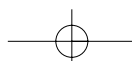

External Equipment Connections

NOTE: All cables shown are not included with the monitor.

VCR Setup

- To avoid picture noise (interference), leave an adequate distance between the VCR and monitor.
- Use the ISM Method (on the Special menu) feature to avoid having a fixed image remain on the screen for a long period of time. Typically a frozen still picture from a VCR. If the 4:3 picture format is used; the fixed images on the sides of the screen may remain visible on the screen.

Connection Option

1. Connect the audio and video cables from the VCR's output jacks to the set input jacks, as shown in the figure.
When connecting the set to VCR, match the jack colors (Video = yellow, Audio Left = white, and Audio Right = red).
If you connect an S-VIDEO output from VCR to the S-VIDEO input, the picture quality is improved; compared to connecting a regular VCR to the Video input.
2. Insert a video tape into the VCR and press PLAY on the VCR. (Refer to the VCR owner's manual.)
3. Select the input source with using the **INPUT** button on the remote control.



Do not connect to both Video and S-Video at the same time. In the event that you connect both Video and the S-Video cables, only the S-Video will work.

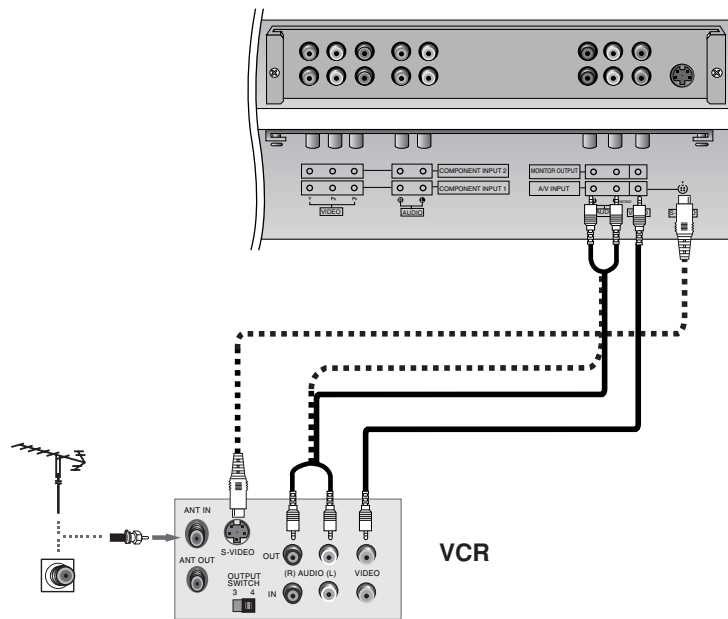

Cable TV Setup

- After subscribing to a cable TV service from a local provider and installing a converter, you can watch cable TV programming. The set cannot display TV programming unless a TV tuner device or cable TV converter box is connected to the set.
- For further information regarding cable TV service, contact your local cable TV service provider(s).

Connection Option

1. Connect the audio and video cables from the Cable Box's output jacks to the set input jacks, as shown in the figure.
When connecting the set to a Cable Box, match the jack colors (Video = yellow, Audio Left = white, and Audio Right = red).
2. Select the input source with using the **INPUT** button on the remote control.
3. Select your desired channel with the remote control for cable box.

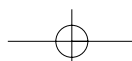
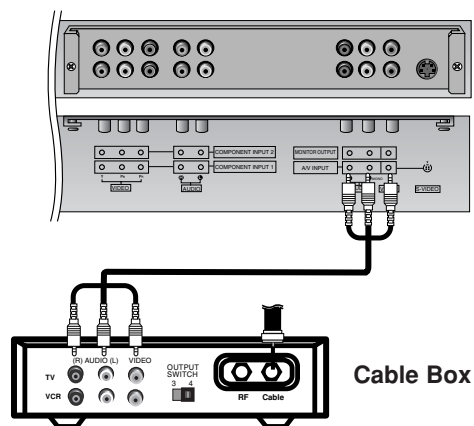

External Equipment Connections

External A/V Source Setup

How to connect

Connect the audio and video cables from the external equipment's output jacks to the set input jacks, as shown in the figure.

When connecting the set to external equipment, match the jack colors (Video = yellow, Audio Left = white, and Audio Right = red).

How to use

1. Select the input source with using the **INPUT** button on the remote control.
2. Operate the corresponding external equipment. Refer to external equipment operating guide.

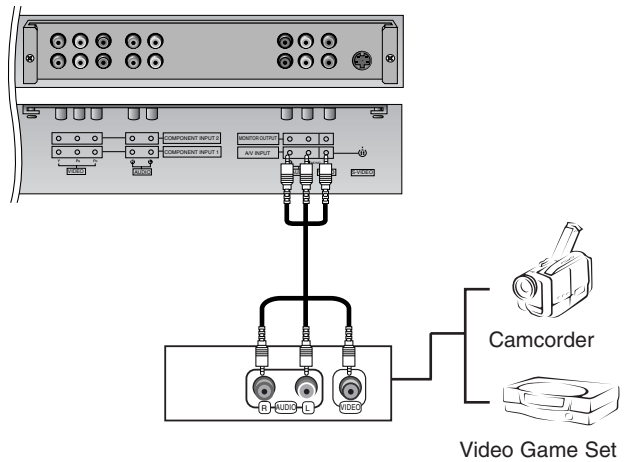

DVD Setup

How to connect

1. Connect the DVD video outputs (Y, P_B, P_R) to the COMPONENT (Y, P_B, P_R) INPUT or HDMI INPUT jacks on the set and connect the DVD audio outputs to the AUDIO INPUT jacks on the set, as shown in the figure.
2. If your DVD only has an S-Video output jack, connect this to the S-VIDEO input on the set and connect the DVD audio outputs to the AUDIO INPUT jacks on the set, as shown in the figure.

NOTE: If your DVD does not have component video output, use S-Video.

How to use

1. Turn on the DVD player, insert a DVD.
2. Use the **INPUT** or **MULTIMEDIA** button on the remote control to select **Component 1**, **Component 2** or **HDMI**. (If connected to S-VIDEO, select the **Video** external input source.)
3. Refer to the DVD player's manual for operating instructions.

• Component Input ports

To get better picture quality, connect a DVD player to the component input ports as shown below.

Component ports on the TV	Y	P _B	P _R
---------------------------	---	----------------	----------------

Video output ports on DVD player	Y	P _b	P _r
	Y	B-Y	R-Y
	Y	Cb	Cr
	Y	P _B	P _R

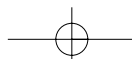
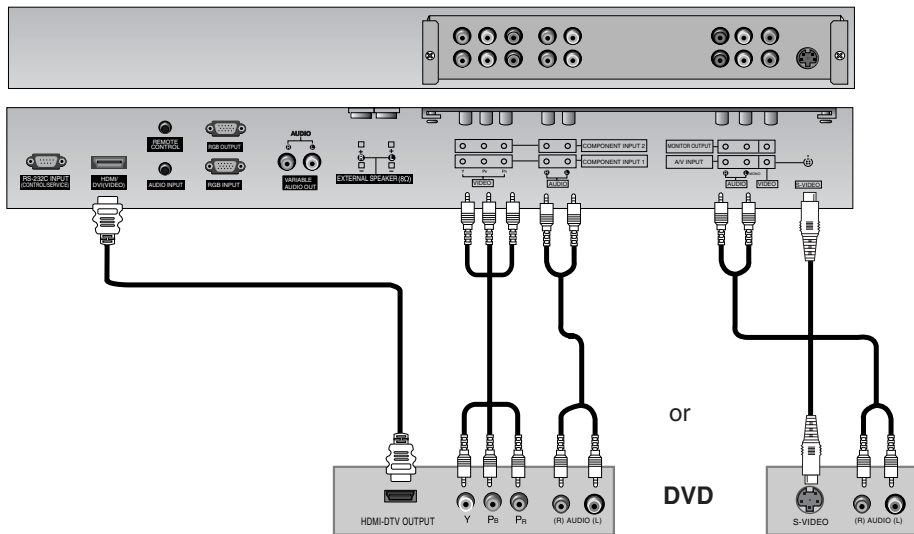

DTV Setup

- To watch digitally broadcast programs, purchase and connect a digital set-top box.

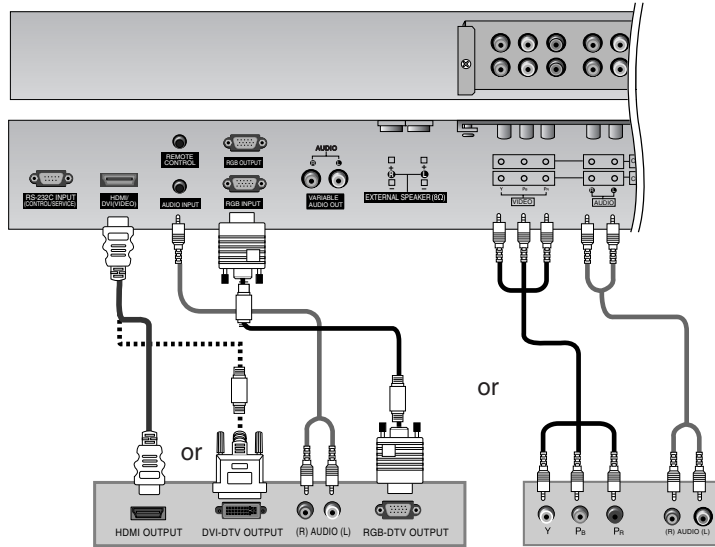

Digital Set-top Box

How to connect

Use the set's COMPONENT (Y, Pb, Pr) INPUT, RGB or HDMI/DVI jack for video connections, depending on your set-top box connector. Then, make the corresponding audio connections.

Signal	Component 1/2	RGB, HDMI
480i	Yes	No
480p	Yes	Yes
720p	Yes	Yes
1080i	Yes	Yes

How to use

1. Turn on the digital set-top box. (Refer to the owner's manual for the digital set-top box.)
2. Use **MULTIMEDIA** on the remote control to select **RGB, HDMI, Component 1** or **Component 2** source.

Monitor Output Setup

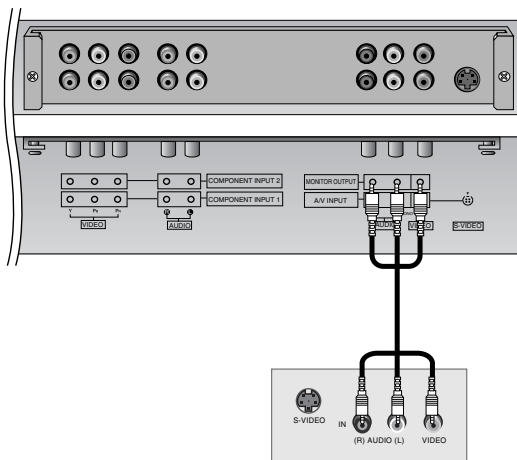

The set has a special signal output capability which allows you to hook up a second set.

Connect the second set to the set's MONITOR OUTPUT. See the Operating Manual of the second set for further details regarding that device's input settings.

NOTE

- Component, RGB, HDMI input sources cannot be used for Monitor output.

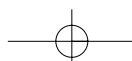

PC Setup

NOTE: All cables shown are not included with the Monitor

How to connect

- To get the best picture quality, adjust the PC graphics card to 1024x768, 60Hz. But in 42PM3MV series, we recommend using 640x480, 60HZ for the PC mode.
- Use the set's RGB INPUT or HDMI/DVI (VIDEO) INPUT port for video connections, depending on your PC connector.
 - If the graphic card on the PC does not output analog and digital RGB simultaneously, connect only one of either RGB INPUT or HDMI/DVI (VIDEO) to display the PC on the set.
 - If the graphic card on the PC does output analog and digital RGB simultaneously, set the set to either RGB or HDMI/DVI (VIDEO); (the other mode is set to Plug and Play automatically by the set.)
- Then, make the corresponding audio connection. If using a sound card, adjust the PC sound as required.

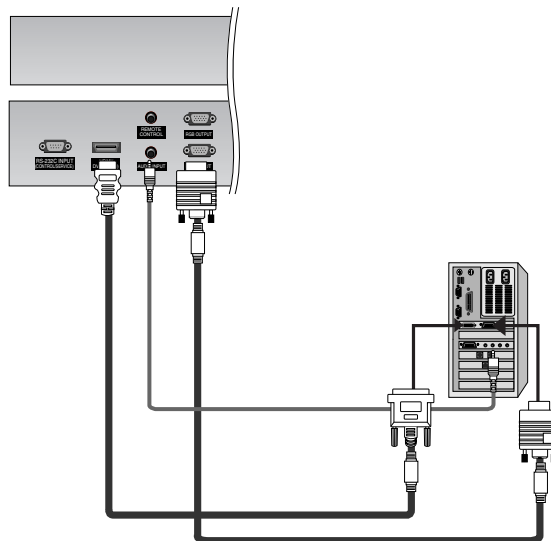

How to use

- Turn on the PC and the set.
- Turn on the display by pressing the POWER button on the set's remote control.
- Use **INPUT** or **MULTIMEDIA** on the remote control to select **RGB** or **HDMI** source.
- Check the image on your set. There may be noise associated with the resolution, vertical pattern, contrast or brightness in PC mode. If noise is present, change the PC mode to another resolution, change the refresh rate to another rate or adjust the brightness and contrast on the menu until the picture is clear. If the refresh rate of the PC graphic card can not be changed, change the PC graphic card or consult the manufacturer of the PC graphic card.

Note:

- Check the image on your TV. There may be noise associated with the resolution, vertical pattern, contrast or brightness in PC mode. If noise is present, change the PC output to another resolution, change the refresh rate to another rate or adjust the brightness and contrast on the VIDEO menu until the picture is clear. If the refresh rate of the PC graphic card can not be changed, change the PC graphic card or consult the manufacturer of the PC graphic card.
- When you use too long RGB-PC cable, there might be a noise on the screen. We recommend using under 5m of the cable. It provides the best picture quality.

Notes:

- Depending on the graphics card, DOS mode may not work if a HDMI to DVI Cable is in use.
- Avoid keeping a fixed image on the screen for a long period of time. The fixed image may become permanently imprinted on the screen. Use the Orbiter feature on the ISM Method menu.
- When Source Devices connected with HDMI/DVI Input, output PC Resolution(VGA, XGA), Position and Size may not fit the Screen.
- When Source Devices connected with HDMI/DVI Input, output TV SET Resolution(480p, 720p, 1080i) and SET Display fit EIA/CEA-861-B Specification to Screen. If not, refer to the Manual of HDMI/DVI Source Devices or contact your service center.
- In case HDMI/DVI Source Devices is not connected Cable or poor cable connection, "No signal" OSD display in HDMI/DVI Input. In case that Video Resolution is not supported SET output in HDMI/DVI Source Devices, "Invalid Format" OSD display. Refer to the Manual of HDMI/DVI Source Devices or contact your service center.

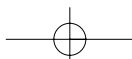

Monitor Display Specifications (RGB / HDMI-PC)

Resolution	Horizontal Frequency(KHz)	Vertical Frequency(Hz)	Proposed	Resolution	Horizontal Frequency(KHz)	Vertical Frequency(Hz)	Proposed
640x350	31.468	70.09	EGA	1024x768	48.363	60.00	VESA(XGA)
	37.861	85.08	EGA		56.476	70.06	VESA(XGA)
720x400	31.469	70.08	DOS		60.023	75.02	VESA(XGA)
	37.927	85.03	DOS		68.677	85.00	VESA(XGA)
640x480	31.469	59.94	VESA(VGA)	1152x864	54.348	60.05	VESA
	35.000	66.66	Macintosh		63.995	70.01	VESA
	37.861	72.80	VESA(VGA)		67.500	75.00	VESA
	37.500	75.00	VESA(VGA)	1152x870	68.681	75.06	VESA
	43.269	85.00	VESA(VGA)		1280x960	60.023	60.02
848x480	31.500	60.00	WVGA	1280x1024	63.981	60.02	VESA(SXGA)
	37.799	70.00	WVGA	1280x768	47.776	59.870	WXGA
	39.375	75.00	WVGA		60.091	74.93	WXGA
852x480	31.500	60.00	WVGA	1360x768	47.700	60.00	WXGA
	37.799	70.00	WVGA		59.625	75.02	WXGA
	39.375	75.00	WVGA	1366x768	47.700	60.00	WXGA
800x600	35.156	56.25	VESA(SVGA)		59.625	75.02	WXGA
	37.879	60.31	VESA(SVGA)	<div style="text-align: center;">  <p>Only 42/50PM1M Models</p> </div>			
	48.077	72.18	VESA(SVGA)				
	46.875	75.00	VESA(SVGA)				
	53.674	85.06	VESA(SVGA)				
53.674	85.06	VESA(SVGA)					
832x624	49.725	74.55	Macintosh	<div style="display: flex; align-items: center;"> <div style="width: 20px; height: 10px; background-color: gray; margin-right: 5px;"></div> SUB Not Supported </div>			

Supported Display Resolution (RGB / HDMI-DTV)

Resolution	Horizontal Frequency(KHz)	Vertical Frequency(Hz)	Proposed
720x480	31.47	59.94	SDTV 480P
	31.50	60.00	SDTV 480P
1280x720	44.96	59.94	HDTV 720P
	45.00	60.00	HDTV 720P
1920x1080	33.72	59.94	HDTV 1080I
	33.75	60.00	HDTV 1080I

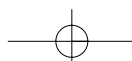

Basic Operation

Turning the monitor On

Turning on the set just after installation

1. Connect power cord correctly, the set is switched to standby mode.
2. Press the **ON/OFF (or ϕ / I)**, **INPUT SELECT** button on the set or press the **POWER, MULTIMEDIA, INPUT** on the remote control and then the set will switch on.

Turning on the set (power cord is still connected)

If the set was turned off with the remote control power button and the **ON/OFF (or ϕ / I)** button on the set.

- Press the **ON/OFF (or ϕ / I)**, **INPUT SELECT** button on the set or press the **POWER, MULTIMEDIA, INPUT** on the remote control and then the set will switch on.

NOTE

- If you intend to be away on vacation, disconnect the power plug from the wall power outlet.

Volume Adjustment

1. Press the **VOL \blacktriangleleft / \blacktriangleright** button to adjust the volume.
2. If you want to switch the sound off, press the **MUTE** button.
3. You can cancel this function by pressing the **MUTE** or **VOL \blacktriangleleft / \blacktriangleright** button.

On-screen Menus Language Selection

- The menus can be shown on the screen in the selected language. First select your language.

1. Press the **MENU** button and then use **\blacktriangle / \blacktriangledown** button to select the **SPECIAL** menu.
2. Press the **\blacktriangleright** button and then use **\blacktriangle / \blacktriangledown** button to select **Language**.
3. Press the **\blacktriangleright** button and then use **\blacktriangle / \blacktriangledown** button to select your desired language.
From this point on, the on-screen menus will be shown in the language of your choice.
4. Press the **ENTER** button to save.

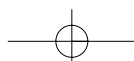

On Screen Menu Selection and Adjustment

• Your monitor's OSD (On Screen Display) may differ slightly from what is shown in this manual.

1. Press the **MENU** button and then ▲ / ▼ button to select each menu.
2. Press the ► button and then use ▲ / ▼ / ◀ / ▶ button to display the available menus.

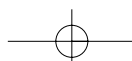
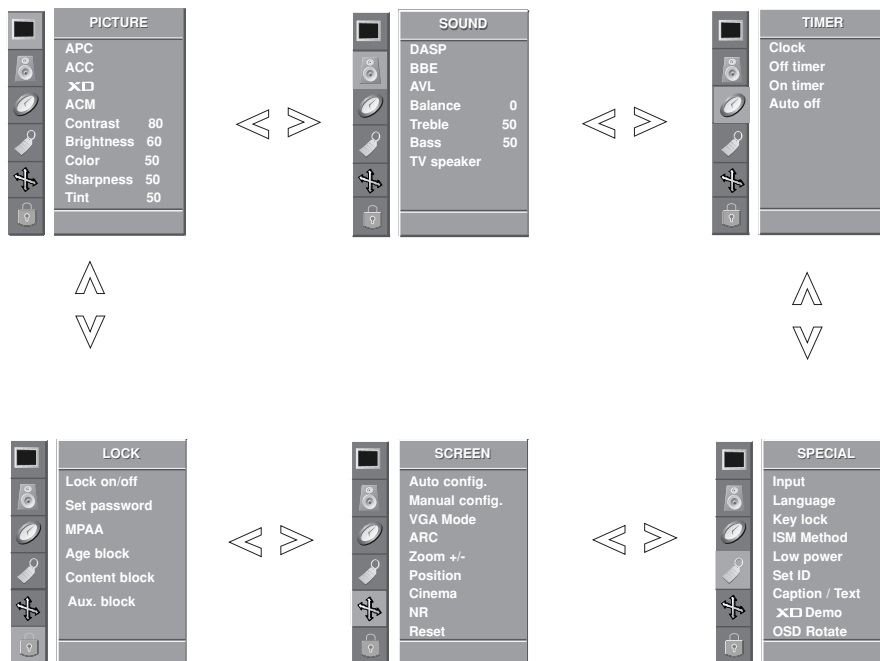

Picture Adjustment

APC (Auto Picture Control)

- APC adjusts the Monitor to the best picture appearance.
- If adjusting picture options (contrast, brightness, color, sharpness, or tint) manually, APC automatically changes to **Off**.

1. Press the **APC** button repeatedly to select the picture appearance setup option as shown below.



- You can also adjust **APC** in the **PICTURE** menu.
- **Daylight**, **Optimum**, and **Night time** settings are preset for good picture quality at the factory and cannot be changed.

XD

- XD is LG Electronic's unique picture improving technology to display a real HD source through an advanced digital signal processing algorithm.
- When selecting APC options (Daylight, Optimum and Night time), XD is automatically change to On.
- XD demo is not available for RGB (PC) and HDMI (PC) sources.

1. Press the **MENU** button and then use **▲ / ▼** button to select the **PICTURE** menu.
2. Press the **▶** button and then use **▲ / ▼** button to select **XD**.
3. Press the **▶** button and then use **▲ / ▼** button to set **On** or **Off**.
4. Press the **ENTER** button to save.

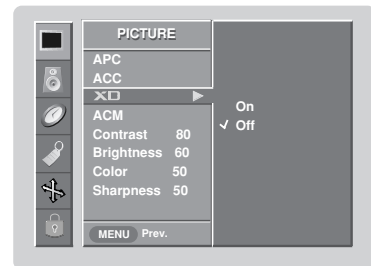

Color Temperature Control

Auto Color Temperature Control

- To initialize values (reset to default settings), select the **Normal** option.

1. Press the **MENU** button and then use **▲ / ▼** button to select the **PICTURE** menu.
2. Press the **▶** button and then use **▲ / ▼** button to select **ACC**.
3. Press the **▶** button and then use **▲ / ▼** button to select either: **Cool** (Preset), **Normal** (Default), or **Warm** (Preset).
4. Press the **ENTER** button to save.

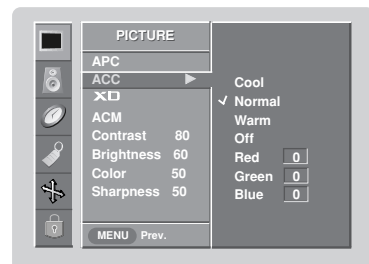

Manual Color Temperature Control (ACC set to Off option)

- You can adjust red, green, or blue to any color temperature you prefer.

1. Press the **MENU** button and then use **▲ / ▼** button to select the **PICTURE** menu.
2. Press the **▶** button and then use **▲ / ▼** button to select **ACC**.
3. Press the **▶** button and then use **▲ / ▼** button to select **Off**.
4. Press the **▶** button and then use **▲ / ▼** button to select **Red**, **Green** or **Blue**.
5. Use the **◀ / ▶** button to make appropriate adjustments.
 - The adjustment range of **Red**, **Green**, and **Blue** is -40 ~ +40.
6. Press the **ENTER** button to save.

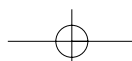

ACM (Active Color Management)

- Adjust the **ACM** to select the desired skin color option.
- This function works in the following mode:
VIDEO, COMPONENT1, 2, RGB-DTV, HDMI-DTV.
- This feature is not operational with the **XD Off** feature.

1. Press the **MENU** button and then use **▲ / ▼** button to select the **PICTURE** menu.
2. Press the **▶** button and then use **▲ / ▼** button to select **ACM**.
3. Press the **▶** button and then use **◀ / ▶** button to make appropriate adjustments.
4. Press the **ENTER** button to save.

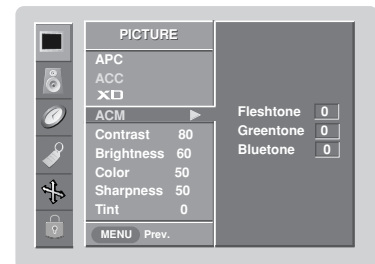

sRGB (Only RGB-PC, DVI-PC Modes)

- If the Monitor is connected to external equipment using sRGB, set sRGB to On to adjust for the color difference.

1. Press the **MENU** button and then use **▲ / ▼** button to select the **PICTURE** menu.
2. Press the **▶** button and then use **▲ / ▼** button to select **sRGB**.
3. Press the **▶** button and then use **▲ / ▼** button to select **On** or **Off**.
4. Press the **ENTER** button to save.

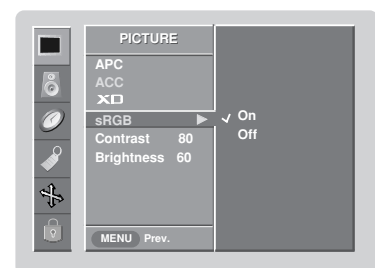

Manual Picture Control (APC set to Off option)

- You can adjust picture contrast, brightness, color and sharpness options to the levels you prefer.

1. Press the **MENU** button and then use **▲ / ▼** button to select the **PICTURE** menu.
2. Press the **▶** button and then use **▲ / ▼** button to select the desired picture option
: RGB-DTV, HDMI-DTV : (**Contrast, Brightness, Color, Sharpness, Tint**).
: RGB-PC, HDMI-PC: (**Contrast, Brightness**).
3. Press the **▶** button and then use **◀ / ▶** button to make appropriate adjustments.
4. Press the **ENTER** button to save.

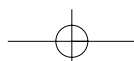
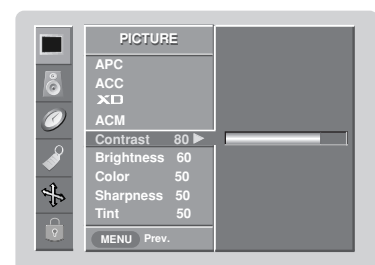

● Sound Adjustment

DASP (Digital Auto Sound Processing)

- This function lets you enjoy the best sound without any special adjustment because the Monitor has the appropriate sound options based on the program content.
- If you adjust sound options (Treble and Bass) manually, DASP automatically changes to **Off**.

1. Press the **DASP** button repeatedly to select the appropriate sound setup as shown below.



- You can also adjust **DASP** in the **SOUND** menu.
- **SRS TSXT**, **Flat**, **Music**, **Movie**, and **Sports** are preset for good sound quality at the factory and cannot be changed.
- **SRS**  is a trademark of SRS Labs, Inc.
- TruSurround XT technology is incorporated under license from SRS Labs, Inc.

BBE

- BBE High Definition Sound restores clarity and presence for better speech intelligibility and music realism.

1. Press the **MENU** button and then use **▲** / **▼** button to select the **SOUND** menu.
2. Press the **▶** button and then use **▲** / **▼** button to select **BBE**.
3. Press the **▶** button and then use **▲** / **▼** button to select **On** or **Off**.
4. Press the **ENTER** button to save.

- **BBE**. Manufactured under license from BBE Sound, Inc.
- Treble, Bass or BBE aren't suitable for **SRS TSXT** mode.

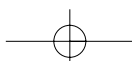
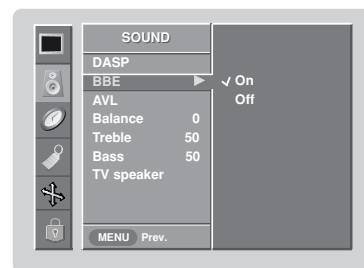

AVL (Auto Volume Leveler)

- AVL maintains an equal sound level; even if you change channels.

1. Press the **MENU** button and then use ▲ / ▼ button to select the **SOUND** menu.
2. Press the ► button and then use ▲ / ▼ button to select **AVL**.
3. Press the ► button and then use ▲ / ▼ button to select **On** or **Off**.
4. Press the **ENTER** button to save.



Manual Sound Control (DASP Off option and balance)

- You can adjust sound options Balance, Treble, and Bass to the levels you prefer.

1. Press the **MENU** button and then use ▲ / ▼ button to select the **SOUND** menu.
2. Press the ► button and then use ▲ / ▼ button to select the desired sound option (**Balance, Treble, Bass**).
3. Press the ► button and then use ◀ / ▶ button to make appropriate adjustments.
4. Press the **ENTER** button to save.

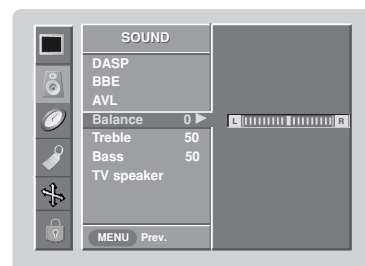

TV speaker Setup

- You can adjust internal speaker status.
 - If you want to use your external hi-fi stereo system, turn off the internal speakers of the set.

1. Press the **MENU** button and then use ▲ / ▼ button to select the **SOUND** menu.
2. Press the ► button and then use ▲ / ▼ button to select **TV speaker**.
3. Press the ► button and then use ▲ / ▼ button to select **On** or **Off**.
4. Press the **ENTER** button to save.

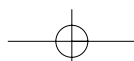
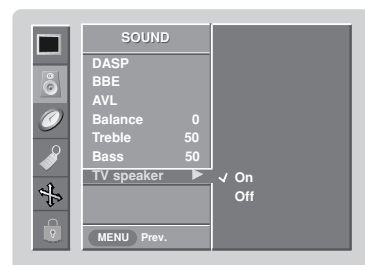

● Time Setting

Clock Setup

- If current time setting is wrong, reset the clock manually.

1. Press the **MENU** button and then use ▲ / ▼ button to select the **TIMER** menu.
2. Press the ► button and then use ▲ / ▼ button to select **Clock**.
3. Press the ► button and then use ▲ / ▼ button to set the hour.
4. Press the ► button and then use ▲ / ▼ button to set the minutes.
5. Press the **ENTER** button to save.

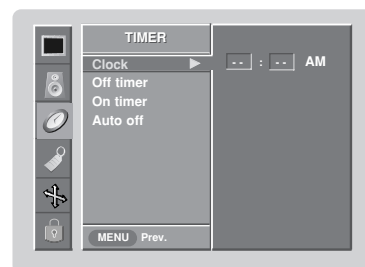

On/Off Timer Setup

- Timer function operates only if current time has been set.
- Off-Timer function overrides On-Timer function if they are set both set to the same time.
- The Monitor must be in standby mode for the On-Timer to work.

1. Press the **MENU** button and then use ▲ / ▼ button to select the **TIMER** menu.
2. Press the ► button and then use ▲ / ▼ button to select **Off timer** or **On timer**.
3. Press the ► button and then use ▲ / ▼ button to select **On**.
 - To cancel **On/Off timer** function, select **Off**.
4. Press the ► button and then use ▲ / ▼ button to set the hour.
5. Press the ► button and then use ▲ / ▼ button to set the minutes.
6. **For only On timer function**
 - Press the ► button and then use ▲ / ▼ button to set sound level.
7. Press the **ENTER** button to save.

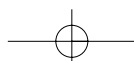
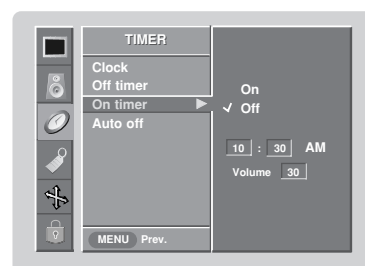

Auto Off

- If set to on and there is no input signal, the Monitor turns off automatically after 10 minutes.

1. Press the **MENU** button and then use ▲ / ▼ button to select the **TIMER** menu.
2. Press the ► button and then use ▲ / ▼ button to select **Auto off**.
3. Press the ► button and then use ▲ / ▼ button to select **On** or **Off**.
4. Press the **ENTER** button to save.

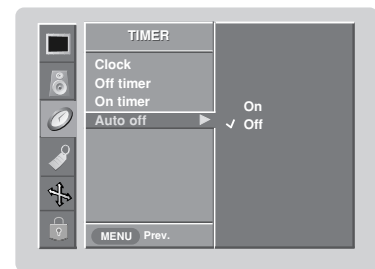

Sleep Timer

- The Sleep Timer turns the Monitor off at the preset time. Note that this setting is cleared when the Monitor is turned off.

1. Press the **SLEEP** button repeatedly to select the number of minutes. First the **Off** option appears on the screen, followed by the following sleep timer options: 10, 20, 30, 60, 90, 120, 180, and 240 minutes.
2. When the number of minutes you want is displayed on the screen, press the **ENTER** button. The timer begins to count down from the number of minutes selected.
3. To check the remaining minutes before the Monitor turns off, press the **SLEEP** button once.
4. To cancel the Sleep Timer, press the **SLEEP** button repeatedly to select **Off**.

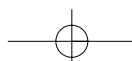
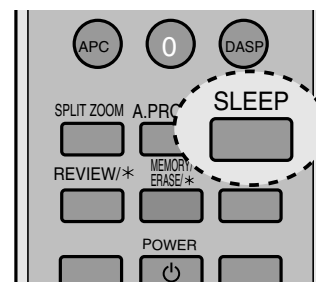

Special Features

Key Lock

- The Monitor can be set up so that it can only be used with the remote control.
- This feature can be used to prevent unauthorized viewing by locking out the front panel controls.
- This Monitor is programmed to remember which option it was last set to even if you turn the Monitor off.

1. Press the **MENU** button and then use ▲ / ▼ button to select the **SPECIAL** menu.
2. Press the ► button and then use ▲ / ▼ button to select **Key lock**.
3. Press the ► button and then use ▲ / ▼ button to select **On** or **Off**.
4. Press the **ENTER** button to save.

- With the Key lock On, the display '▲ Key lock' appears on the screen if any button on the front panel is pressed.



ISM (Image Sticking Minimization) Method

- A frozen still picture from a PC/video game displayed on the screen for prolonged periods will result in a ghost image remaining even when you change the image. Avoid allowing a fixed image to remain on the Monitor's screen for a long period of time.

1. Press the **MENU** button and then use ▲ / ▼ button to select the **SPECIAL** menu.
2. Press the ► button and then use ▲ / ▼ button to select **ISM Method**.
3. Press the ► button and then use ▲ / ▼ button to select either **Normal**, **White wash**, **Orbiter** or **Inversion**.

- **Normal**

If image sticking is never a problem, ISM is not necessary - set to Normal.

- **White wash**

White Wash removes permanent images from the screen. Note: An excessive permanent image may be impossible to clear entirely with White Wash. To return to normal viewing, press any button.

- **Orbiter**

Orbiter may help prevent ghost images. However, it is best not to allow any fixed image to remain on the screen. To avoid a permanent image on the screen, the image will move every 2 minutes: Right → Right → Left → Left → Downside → Downside → Upside → Upside → Left → Left → Right → Right → Upside → Upside → Downside → Downside.

- **Inversion**

Inversion will automatically invert the Monitor panel color every 30 minutes.

4. Press the **ENTER** button to save.

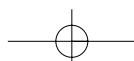
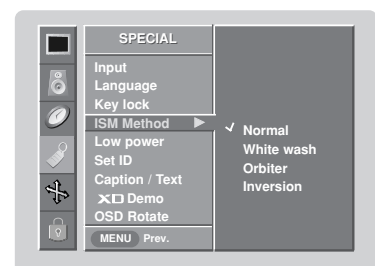

Low Power

- Low power reduces the plasma display power consumption.

1. Press the **MENU** button and then use ▲ / ▼ button to select the **SPECIAL** menu.
2. Press the ► button and then use ▲ / ▼ button to select **Low power**.
3. Press the ► button and then use ▲ / ▼ button to select **On** or **Off**.
 - When you select **On**, the screen darkens.
4. Press the **ENTER** button to save.

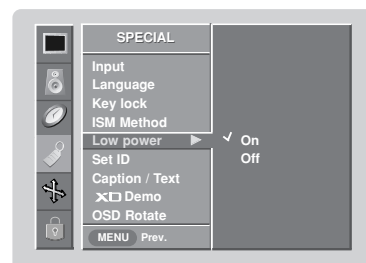

XD Demo

- Use it to see the difference between XD Demo on and XD Demo off.
 - XD demo is not available for RGB (PC) and HDMI (PC) sources.

1. Press the **MENU** button and then use ▲ / ▼ button to select the **SPECIAL** menu.
2. Press the ► button and then use ▲ / ▼ button to select **XD Demo**.
3. Press the ► button to begin **XD Demo**.
4. Press the **EXIT** button to stop **XD Demo**.

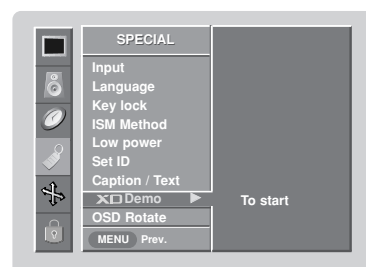

OSD Rotate

1. Press the **MENU** button and then use ▲ / ▼ button to select the **SPECIAL** menu.
2. Press the ► button and then use ▲ / ▼ button to select **OSD Rotate**.
3. Press the ► button and then use ▲ / ▼ button to select **Normal** or **Rotate**.
 - **Normal** : If the set is installed horizontally.
 - **Rotate** : If the set is installed vertically.
4. Press the **ENTER** button to save.

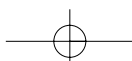
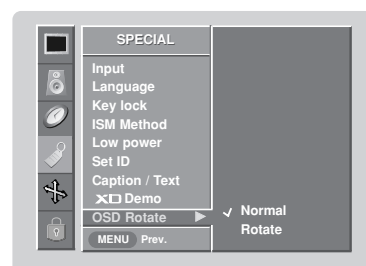

Screen Adjustment

Auto Adjustment

- RGB (PC) mode only; This function doesn't work for RGB (DTV) mode.
- Automatically adjusts picture position and minimizes image shaking.
- After adjustment, if the image is still not correct, your set is functioning properly but needs further adjustment.
- The **Auto config.** and **Manual config.** are not active in HDMI mode.

1. Press the **MENU** button and then use **▲ / ▼** button to select the **SCREEN** menu.
2. Press the **▶** button and then use **▲ / ▼** button to select **Auto config.**
3. Press the **▶** button to run Auto configure.
 - When **Auto config.** has finished, **OK** will be seen on the screen.
 - If the position of the image is still not correct, try Auto adjustment again.
4. In RGB (PC) mode, if the image needs to be adjusted more after using **Auto config.**, you can make further adjustments with the **Manual config.** option.

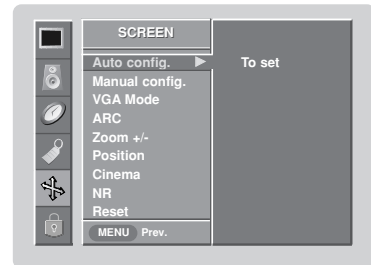

Setting Picture Format

- Caution: If a 4:3 fixed image is on the screen for a long time, it may remain visible.
- Set every aspect ratio for Video, Component 480i sources.
- Use 4:3 or 16:9 for other RGB(PC), HDMI(PC) sources.
- Horizon is not available for RGB (DTV), HDMI (DTV), and Component (DTV) sources.

1. Press the **ARC** button repeatedly to select the desired picture format. You can also adjust **ARC** in the **SCREEN** menu.
 - **4:3**
Choose **4:3** when you want to view a picture with an original 4:3 aspect ratio, with black bars appearing at both the left and right sides.
 - **16:9**
Choose **16:9** when you want to adjust the picture horizontally, in a linear proportion to fill the entire screen.
 - **Horizon**
Choose **Horizon** when you want to adjust the picture in a non-linear proportion, that is, more enlarged at both sides, to create a spectacular view.
 - **Zoom**
Choose **Zoom** when you want to view the picture without any alteration. However, the top and bottom portions of the picture will be cropped.

Manual Configure

- If the image still isn't clear after auto adjustment and especially if characters are still jittery, adjust the picture Phase manually.
- To correct the screen size, adjust **Clock**.
- Phase, Clock, H-position, V-position function works in the following mode : RGB-PC.
- Only H-position, V-position function works in the following mode : RGB-DTV, COMPONENT (480p, 720p,1080i), HDMI-DTV (480p, 720p,1080i) mode.

1. Press the **MENU** button and then use **▲ / ▼** button to select the **SCREEN** menu.
2. Press the **▶** button and then use **▲ / ▼** button to select **Manual config.**
3. Press the **▶** button and then use **▲ / ▼** button to select **Phase**, **Clock**, **H-Position** or **V-Position**.
4. Use the **◀ / ▶** button to make appropriate adjustments.
 - The **Phase** adjustment range is 0 ~ 63.
 - The **Clock** adjustment range is -20 ~ +50.
5. Press the **ENTER** button to save.

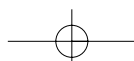
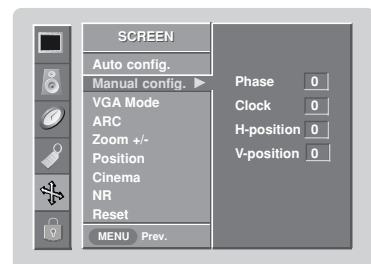

Selecting VGA/XGA Mode (RGB mode only)

- To see a normal picture, match the resolution of RGB VGA/XGA mode (640x480, 848x480, 852x480 / 1024x768, 1280x768, 1360x768, 1366x768) with the selection for VGA/XGA mode in the **SCREEN** menu.
- 42PM3MV model is only available in VGA mode.

1. Press the **MENU** button and then use **▲ / ▼** button to select the **SCREEN** menu.
2. Press the **▶** button and then use **▲ / ▼** button to select **VGA Mode** (or **XGA Mode**).
3. Press the **▶** button and then use **▲ / ▼** button to select the desired VGA/XGA resolution.
4. Press the **ENTER** button to save.

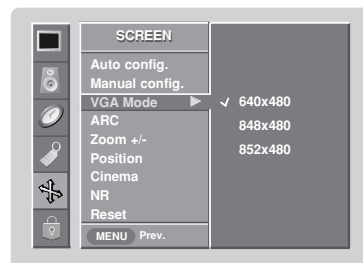

Picture size Zoom

- When enlarging or reducing the picture, the screen may display an incorrect picture.

1. Press the **MENU** button and then use **▲ / ▼** button to select the **SCREEN** menu.
2. Press the **▶** button and then use **▲ / ▼** button to select **Zoom +/-**.
3. Press the **▶** button and then use **▲ / ▼ / ◀ / ▶** button to adjust the position.
4. Press the **ENTER** button to save.

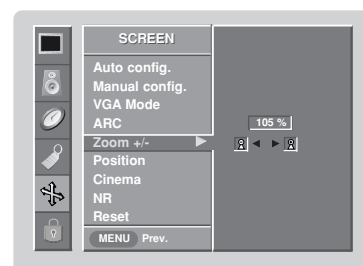

Screen Position

- You are available to this function after adjusting Zoom +/-.

1. Press the **MENU** button and then use **▲ / ▼** button to select the **SCREEN** menu.
2. Press the **▶** button and then use **▲ / ▼** button to select **Position**.
3. Press the **▶** button and then use **▲ / ▼ / ◀ / ▶** button to adjust the position.
4. Press the **ENTER** button to save.

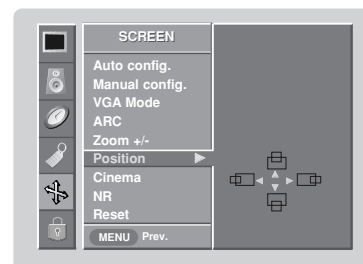

Cinema Mode Setup (Video and Component 480i mode only)

- Sets up the set for the best picture appearance for viewing movies.
- This function works in the following mode:
Video or COMPONENT (480i).

1. Press the **MENU** button and then use **▲ / ▼** button to select the **SCREEN** menu.
2. Press the **▶** button and then use **▲ / ▼** button to select **Cinema**.
3. Press the **▶** button and then use **▲ / ▼** button to select **On** or **Off**.
4. Press the **ENTER** button to save.

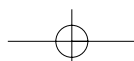
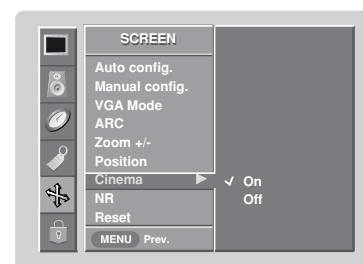

● Screen Adjustment

NR (Noise Reduction)

- You can select **3D NR** or **MPEG NR** to reduce the picture noise which may appear on the screen while watching the set.

1. Press the **MENU** button and then use **▲ / ▼** button to select the **SCREEN** menu.
2. Press the **▶** button and then use **▲ / ▼** button to select **NR**.
3. Press the **▶** button and then use **▲ / ▼** button to select **3D NR** or **MPEG NR**.
4. Press the **◀ / ▶** button to make appropriate adjustments.
5. Press the **ENTER** button to save.

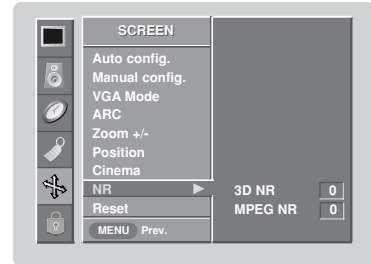

Initializing (Reset to original factory value)

- Reset is unique to each function: Position, Zoom +/-.
- Use the Reset option to initialize the adjusted settings.

1. Press the **MENU** button and then use **▲ / ▼** button to select the **SCREEN** menu.
2. Press the **▶** button and then use **▲ / ▼** button to select **Reset**.
3. Press the **▶** button.

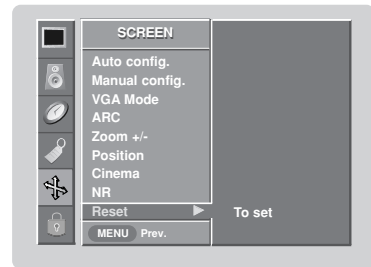

Split Zoom

- Enlarges the picture in correct proportions.
- Split Zoom can be used for all input sources.
- In 2-Split Zoom mode, you can only move the image up or down.
- If an image is enlarged, a section can be viewed without using Split Zoom.

1. Press the **SPLIT ZOOM** button repeatedly to select either 2, 4, or 9 Split Zoom.



2. Press the number button corresponding to the section you wish to enlarge. You can move within the enlarged picture using the **▲ / ▼ / ◀ / ▶** button. To return to normal viewing, press the **SPLIT ZOOM** button again.

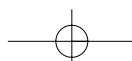
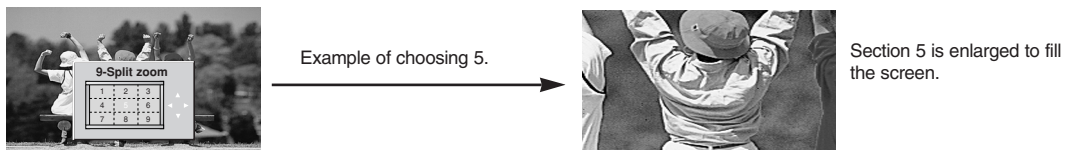

Lock Adjustment

Parental Control can be used to block specific channels, ratings and other viewing sources.

The Parental Control Function (V-Chip) is used to block program viewing based on the ratings sent by the broadcasting station. The default setting is to allow all programs to be viewed. Viewing can be blocked by choosing the type of the program and the categories. It is also possible to block all program viewing for a time period. To use this function, the following must be done :

1. Set ratings and categories to be blocked.
2. Specify a password
3. Enable the lock

V-Chip rating and categories

Rating guidelines are provided by broadcasting stations. Most television programs and television movies can be blocked by TV Rating and/or Individual Categories. Movies that have been shown at the theaters or direct-to-video movies use the Movie Rating System (MPAA) only.

Ratings for Television programs including made-for-TV movies :

- TV-G (General audience)
- TV-PG (Parental guidance suggested)
- TV-14 (Parents strongly cautioned)
- TV-MA (Mature audience only)
- TV-Y (All children)
- TV-Y7 (Children 7 years older)

Setting Up Your Password

- Set up blocking schemes to block specific channels, ratings, and external viewing sources.
- A password is required to gain access to this menu.

1. Press the **MENU** button and then use the **▲ / ▼** button to select the **LOCK** menu. Then, press the **▶** button.

- Enter the password as requested.
- The TV is set up with the initial password "0-0-0-0".

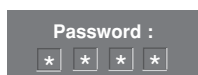

Lock System

Enables or disables the blocking scheme you set up previously.

1. After inputting the password, use the **▲ / ▼** button to choose **Lock System**.
2. Press the **▶** button and then use the **▲ / ▼** to select **On** or **Off**.
 - When you select , the Lock System is enable.
3. Press the **ENTER** button to save.

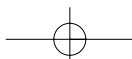
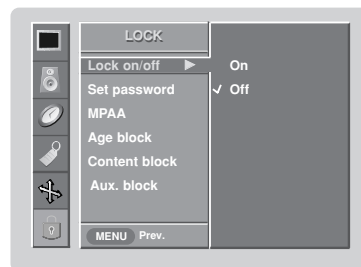

Set Password

Change the password by inputting a new password twice.

1. After inputting the password, use the ▲ / ▼ button to choose **Set password**.
2. Press the ► button and then choose any 4 digits for your new password and enter the them on the **new**.
As soon as the 4 digits are entered, re-enter the same 4 digits on the **Confirm**.
Then your changed password has been memorized.
3. Press the **ENTER** button to save.

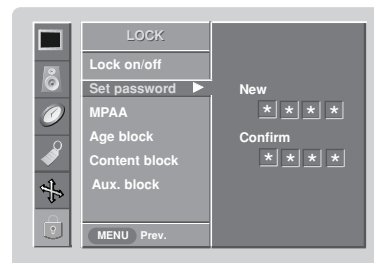

MPAA (Movie Rating)

Blocks movies according to the movie ratings limits specified, so children cannot view certain movies. You can set the ratings limit by blocking out all the movies with the ratings above a specified level. Keep in mind that the movie ratings limit only applies to movies shown on TV, not TV programs, such as soap operas.

1. After inputting the password, use the ▲ / ▼ button to choose **MPAA**.
2. Press the ► button and then use the ▲ / ▼ to select **G&above**, **PG&above**, **PG-13&above**, **R&above**, **NC-17&above**, or **X**.

- Unblocked (Permits all programs)
- G&above (General audience)
- PG&above (Parental guidance suggested)
- PG-13&above (Parents strongly cautioned)
- R&above (Restricted)
- NC-17&above (No one 17 and under admitted)
- X (Adult only)

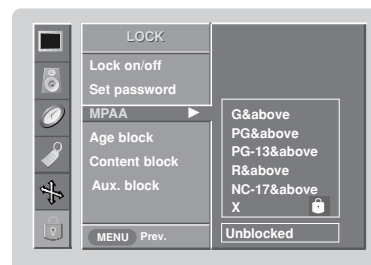

If you set PG-13&above : G&above and PG&above movies will be available , PG-13&above, R&above, NC-17&above and X will be blocked.

3. Press the **ENTER** button to save.

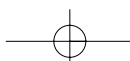

Age block

1. After inputting the password, use the ▲ / ▼ button to choose **Age block**.
2. Press the ► button and then use the ▲ / ▼ to select **General** or **Children**.

General

- Based on the ratings, blocks certain monitor programs that you and your family do not want to view.

- TV-G&above (General audience)
- TV-PG&above (Parental guidance suggested)
- TV-14&above (Parents strongly cautioned)
- TV-MA (Mature audience only)

Children

- Prevents children from watching certain children's monitor programs, according to the ratings limit set. The children rating does not apply to other Tmonitor programs. Unless you block certain monitor programs intended for mature audiences in the monitor Rating - sub menu, your children can view those programs.

- TV-Y&above (All children)
- TV-Y7 (Children 7 years older)

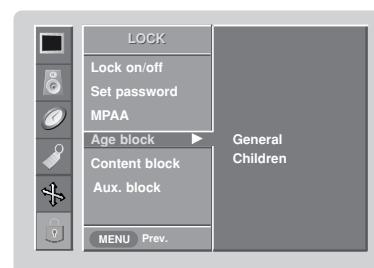

3. Press the **ENTER** button to save.

Content block

1. After inputting the password, use the ▲ / ▼ button to choose **Content block**.
2. Press the ► button and then use the ▲ / ▼ to select **Dialogue**, **Language**, **Sex scene**, **Violence** or **F.Violence**.

- Dialogue - sexual dialogue (applies to TV-PG&above, TV-14)
- Language - adult language (applies to TV-PG&above, TV-14&above, TV-MA)
- Sex scene- sexual situations (applies to TV-PG&above, TV-14&above, TV-MA)
- Violence (applies to TV-PG&above, TV-14&above, TV-MA)
- F.Violence (applies to TV-Y7)

3. Press the **ENTER** button to save.

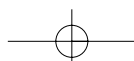
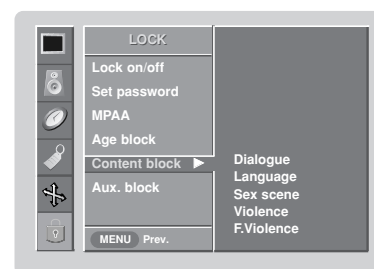

Aux. block

Enables you to select a source to block from the external source devices you have hooked up.

1. After inputting the password, use the ▲ / ▼ button to choose **Aux. block**.
2. Press the ► button and then use the ▲ / ▼ to select a source.
3. Press the ► button and then use the ▲ / ▼ to select **RGB, HDMI, Component 1, Component 2** or **Video** on the each source and then you can select **Blocked** or **Unblocked**.
4. Press the **ENTER** button to save.

Note:

- If you ever forget your password, key in '7', '7', '7', '7' on the remote control.

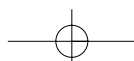
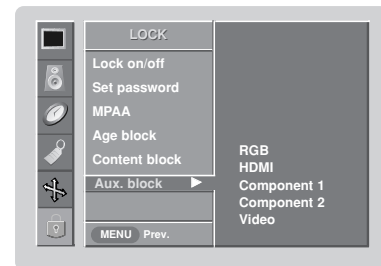

Appendix

External Control Device Setup

- Connect the RS-232C input jack to an external control device (such as a computer or an A/V control system) and control the Monitor's functions externally.
- Connect the serial port of the control device to the RS-232C jack on the Monitor back panel.
- RS-232C connection cables are not supplied with the Monitor.
- RS-232C connection cables are used for service.

RS-232C Setup

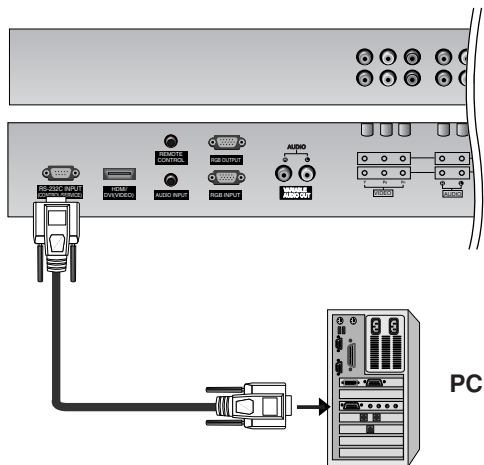

Type of Connector; D-Sub 9-Pin Male

No.	Pin name
1	No connection
2	RXD (Receive data)
3	TXD (Transmit data)
4	DTR (DTE side ready)
5	GND
6	DSR (DCE side ready)
7	RTS (Ready to send)
8	CTS (Clear to send)
9	No Connection

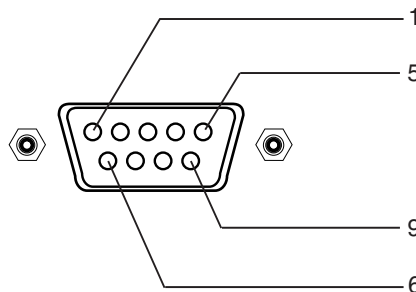

RS-232C Configurations

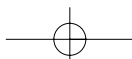
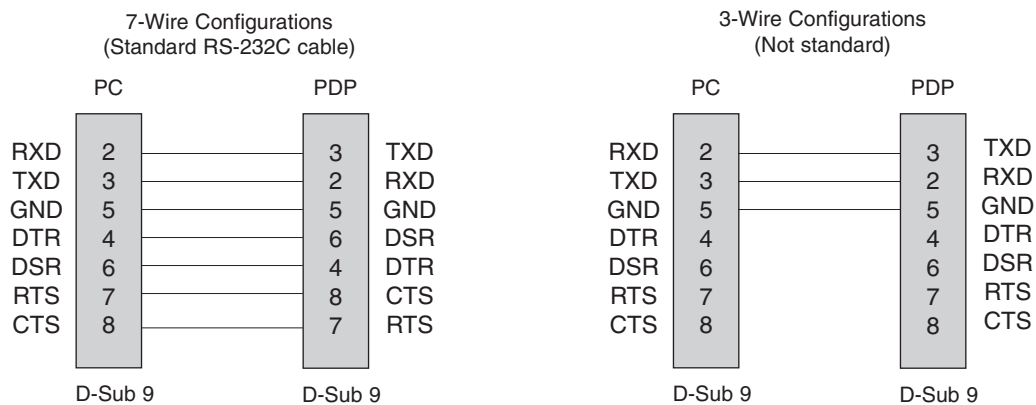

External Control Device Setup

Set ID

- Use this function to specify a Monitor ID number.
 - Refer to 'Real Data Mapping 1'. See page 35.
1. Press the **MENU** button and then use **▲ / ▼** button to select the **SPECIAL** menu.
 2. Press the **▶** button and then use **▲ / ▼** button to select **Set ID**.
 3. Press the **▶** button and then use **◀ / ▶** button to adjust **Set ID** to choose the desired Monitor ID number. The adjustment range of **Set ID** is 1 ~ 99.
 4. Press the **ENTER** button to save.

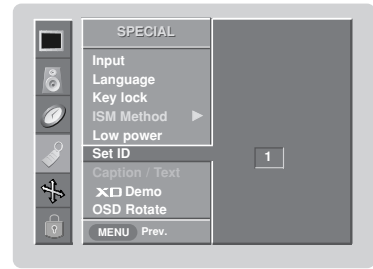

Communication Parameters

- Baud rate : 9600 bps (UART)
- Data length : 8 bits
- Parity : None
- * Use a crossed (reverse) cable.
- Stop bit : 1 bit
- Communication code : ASCII code

Command Reference List

	COMMAND 1	COMMAND 2	DATA (Hexadecimal)
01. Power	k	a	0 ~ 1
02. Input Select	k	b	2 ~ 9
03. Aspect Ratio	k	c	1 ~ 4
04. Screen Mute	k	d	0 ~ 1
05. Volume Mute	k	e	0 ~ 1
06. Volume Control	k	f	0 ~ 64
07. Contrast	k	g	0 ~ 64
08. Brightness	k	h	0 ~ 64
09. Color	k	i	0 ~ 64
10. Tint (option)	k	j	0 ~ 64
11. Sharpness	k	k	0 ~ 64
12. OSD Select	k	l	0 ~ 1
13. Remote control lock mode	k	m	0 ~ 1
14. Split Zoom	k	p	0 ~ 99
15. Treble	k	r	0 ~ 64
16. Bass	k	s	0 ~ 64
17. Balance	k	t	0 ~ 64
18. Color Temperature (ACC)	k	u	0 ~ 3
19. Red Adjustment	k	v	0 ~ 50
20. Green Adjustment	k	w	0 ~ 50
21. Blue Adjustment	k	\$	0 ~ 50
22. Abnormal Status	k	z	0 ~ a
23. ISM Method	j	p	1 ~ 8
24. Low Power	j	q	0 ~ 1
25. Orbiter Time Setting	j	r	1 ~ FE
26. Orbiter Pixel Setting	j	s	1 ~ 3
27. Auto Configure	j	u	1
28. Key	m	c	Key Code
29. Input select (Main)	x	b	Refer to p.38

* When setting the 22 ~ 27, a menu doesn't display on screen.

Transmission / Receiving Protocol

Transmission

[Command1][Command2][][Set ID][][Data][Cr]

- * [Command 1] : First command to control PDP set.
(j, k or m)
- * [Command 2] : Second command to control PDP set.
- * [Set ID] : You can adjust the set ID to choose desired monitor ID number in special menu.
Adjustment range is 1 ~ 99.
When selecting Set ID '0', every connected PDP set is controlled.
Set ID is indicated as decimal (1~99) on menu and as Hexa decimal (0x0~0x63) on transmission/receiving protocol.
- * [DATA] : To transmit command data.
Transmit 'FF' data to read status of command.
- * [Cr] : Carriage Return
ASCII code '0x0D'
- * [] : ASCII code 'space (0x20)'

OK Acknowledgement

[Command2][][Set ID][][OK][Data][x]

- * The Monitor transmits ACK (acknowledgement) based on this format when receiving normal data. At this time, if the data is data read mode, it indicates present status data. If the data is data write mode, it returns the data of the PC computer.

Error Acknowledgement

[Command2][][Set ID][][NG][Data][x]

- * The Monitor transmits ACK (acknowledgement) based on this format when receiving abnormal data from non-viable functions or communication errors.

- Data 1: Illegal Code
- 2: not support function
- 3: Wait more time

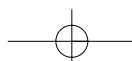

01. Power (Command2:a)

▶ To control Power On/Off of the monitor.

Transmission

```
[k][a][ ][Set ID][ ][Data][Cr]
```

Data 0 : Power Off 1 : Power On

Ack

```
[a][ ][Set ID][ ][OK][Data][x]
```

▶ To show Power On/Off.

Transmission

```
[k][a][ ][Set ID][ ][FF][Cr]
```

Ack

```
[a][ ][Set ID][ ][OK][Data][x]
```

* In like manner, if other functions transmit '0xFF' data based on this format, Acknowledgement data feed back presents status about each function.

02. Input Select (Command 2 : b)

▶ To select input source for the monitor.
You can also select an input source using the INPUT button on the Monitor's remote control.

Transmission

```
[k][b][ ][Set ID][ ][Data][Cr]
```

Data 2 : Video 6 : RGB-DTV
4 : Component1 7 : RGB-PC
5 : Component2 8 : HDMI-DTV
9 : HDMI-PC

Ack

```
[b][ ][Set ID][ ][OK][Data][x]
```

If you use either RGB-DTV or RGB-PC command, It is possible to select RGB input. And HDMI input mode is also the same.

**If you read status of the input mode in RGB or HDMI input , Monitor will always send the DTV mode status.*

03. Aspect Ratio (Command 2 : c) (Main Picture Size)

▶ To adjust the screen format. (Main picture format)
You can also adjust the screen format using the ARC (Aspect Ratio Control) button on remote control or in the SCREEN menu.

Transmission

```
[k][c][ ][Set ID][ ][Data][Cr]
```

Data 1 : Normal screen (4:3)
2 : Wide screen (16:9)
3 : Horizon
4 : Zoom

Ack

```
[c][ ][Set ID][ ][OK][Data][x]
```

* Using the PC input, you select either 16:9 or 4:3 screen aspect ratio.

04. Screen Mute (Command 2 : d)

▶ To select screen mute on/off.

Transmission

```
[k][d][ ][Set ID][ ][Data][Cr]
```

Data 0 : Screen mute off (Picture on)
1 : Screen mute on (Picture off)

Ack

```
[d][ ][Set ID][ ][OK][Data][x]
```

05. Volume Mute (Command 2 : e)

▶ To control volume mute on/off.
You can also adjust mute using the MUTE button on remote control.

Transmission

```
[k][e][ ][Set ID][ ][Data][Cr]
```

Data 0 : Volume mute on (Volume off)
1 : Volume mute off (Volume on)

Ack

```
[e][ ][Set ID][ ][OK][Data][x]
```

06. Volume Control (Command 2 : f)

▶ To adjust volume.
You can also adjust volume with the volume buttons on remote control.

Transmission

```
[k][f][ ][Set ID][ ][Data][Cr]
```

Data Min : 0 ~ Max : 64
* Refer to 'Real data mapping 1'.

Ack

```
[f][ ][Set ID][ ][OK][Data][x]
```

<p>* Real data mapping 1</p> <p>0 : Step 0 ⋮ A : Step 10 (Set ID 10) ⋮ F : Step 15 (Set ID 15) 10 : Step 16 (Set ID 16) ⋮ 64 : Step 100 ⋮ 6E : Step 110 ⋮ 73 : Step 115 74 : Step 116 ⋮ C7 : Step 199</p>	<p>* Real data mapping 2</p> <p>0 : -40 1 : -39 2 : -38 ⋮ 28 : 0 ⋮ 4E : +38 4F : +39 50 : +40</p>
--	--

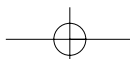

External Control Device Setup

07. Contrast (Command 2 : g)

- ▶ To adjust screen contrast.
You can also adjust contrast in the PICTURE menu.

Transmission

```
[k][g][ ][Set ID][ ][Data][Cr]
```

Data Min : 0 ~ Max : 64
* Refer to 'Real data mapping 1'. See page 35.

Ack

```
[g][ ][Set ID][ ][OK][Data][x]
```

08. Brightness (Command 2 : h)

- ▶ To adjust screen brightness.
You can also adjust brightness in the PICTURE menu.

Transmission

```
[k][h][ ][Set ID][ ][Data][Cr]
```

Data Min : 0 ~ Max : 64
* Refer to 'Real data mapping 1'. See page 35.

Ack

```
[h][ ][Set ID][ ][OK][Data][x]
```

09. Color (Command 2 : i)

- ▶ To adjust the screen color.
You can also adjust color in the PICTURE menu.

Transmission

```
[k][i][ ][Set ID][ ][Data][Cr]
```

Data Min : 0 ~ Max : 64
* Refer to 'Real data mapping 1'. See page 35.

Ack

```
[i][ ][Set ID][ ][OK][Data][x]
```

10. Tint (Command 2 : j) (option)

- ▶ To adjust the screen tint.
You can also adjust tint in the PICTURE menu.

Transmission

```
[k][j][ ][Set ID][ ][Data][Cr]
```

Data Red : 0 ~ Green : 64
* Refer to 'Real data mapping 1'. See page 35.

Ack

```
[j][ ][Set ID][ ][OK][Data][x]
```

11. Sharpness (Command 2 : k)

- ▶ To adjust the screen sharpness.
You can also adjust sharpness in the PICTURE menu.

Transmission

```
[k][k][ ][Set ID][ ][Data][Cr]
```

Data Min : 0 ~ Max : 64
* Refer to 'Real data mapping 1'. See page 35.

Ack

```
[k][ ][Set ID][ ][OK][Data][x]
```

12. OSD Select (Command 2 : l)

- ▶ To select OSD (On Screen Display) on/off when controlling remotely.

Transmission

```
[k][l][ ][Set ID][ ][Data][Cr]
```

Data 0 : OSD off 1 : OSD on

Ack

```
[l][ ][Set ID][ ][OK][Data][x]
```

13. Remote control lock mode (Command 2 : m)

- ▶ To lock the front panel controls on the monitor and remote control.

Transmission

```
[k][m][ ][Set ID][ ][Data][Cr]
```

Data 0 : Lock off 1 : Lock on

Ack

```
[m][ ][Set ID][ ][OK][Data][x]
```

- * If you're not using the remote control, use this mode.
When main power is on/off, external control lock is released.

14. Split Zoom (Command 2:p)

- ▶ To operate split zoom function and select the split zoom section number.

Transmission

```
[k][p][ ][Set ID][ ][Data][Cr]
```

Data Min: 0 ~ Max:99
• Refer to 'Real data mapping 2'.

Acknowledgement

```
[p][ ][Set ID][ ][OK][Data][x]
```

* Real data mapping 2

- 0 : Reset split zoom
- 21: Selection 1 of 2 split zoom
- 24: Selection 4 of 2 split zoom
- 41: Selection 1 of 4 split zoom
- 42: Selection 2 of 4 split zoom
- 44: Selection 4 of 4 split zoom
- 45: Selection 5 of 4 split zoom
- 91: Selection 1 of 9 split zoom
- ⋮
- 99: Selection 9 of 9 split zoom

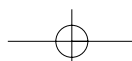

15. Treble (Command 2 : r)

- To adjust treble.
You can also adjust treble in the SOUND menu.

Transmission

```
[k][r][ ][Set ID][ ][Data][Cr]
```

Data Min : 0 ~ Max : 64
* Refer to 'Real data mapping 1'. See page 35.

Ack

```
[r][ ][Set ID][ ][OK][Data][x]
```

16. Bass (Command 2 : s)

- To adjust bass.
You can also adjust bass in the SOUND menu.

Transmission

```
[k][s][ ][Set ID][ ][Data][Cr]
```

Data Min : 0 ~ Max : 64
* Refer to 'Real data mapping 1'. See page 35.

Ack

```
[s][ ][Set ID][ ][OK][Data][x]
```

17. Balance (Command 2 : t)

- To adjust balance.
You can also adjust balance in the SOUND menu.

Transmission

```
[k][t][ ][Set ID][ ][Data][Cr]
```

Data Min : 0 ~ Max : 64
* Refer to 'Real data mapping 1'. See page 35.

Ack

```
[t][ ][Set ID][ ][OK][Data][x]
```

18. Color Temperature (Command 2 : u)

- To adjust color temperature.
You can also adjust ACC in the PICTURE menu.

Transmission

```
[k][u][ ][Set ID][ ][Data][Cr]
```

Data 0: Normal 1: Cool 2: Warm 3: Off

Ack

```
[u][ ][Set ID][ ][OK][Data][x]
```

19. Red Adjustment (Command 2 : v)

- To adjust red in color temperature.

Transmission

```
[k][v][ ][Set ID][ ][Data][Cr]
```

Data Min : 0 ~ Max : 50
* Refer to 'Real data mapping 2'. See page 36.

Ack

```
[v][ ][Set ID][ ][OK][Data][x]
```

20. Green Adjustment (Command 2 : w)

- To adjust green in color temperature.

Transmission

```
[k][w][ ][Set ID][ ][Data][Cr]
```

Data Min : 0 ~ Max : 50
* Refer to 'Real data mapping 2'. See page 36.

Ack

```
[w][ ][Set ID][ ][OK][Data][x]
```

21. Blue Adjustment (Command 2 : \$)

- To adjust blue in color temperature.

Transmission

```
[k][$][ ][Set ID][ ][Data][Cr]
```

Data Min : 0 ~ Max : 50
* Refer to 'Real data mapping 2'. See page 36.

Ack

```
[$][ ][Set ID][ ][OK][Data][x]
```

22. Abnormal State (Command 2 : z)

- To recognize an abnormal state.

Transmission

```
[k][z][ ][Set ID][ ][FF][ ][Cr]
```

Data FF : Read

Ack

```
[z][ ][Set ID][ ][OK][Data][x]
```

Data 0: Normal (Power on and signal exist)
1: No signal (Power on)
2: Turn the monitor off by remote control
3: Turn the monitor off by sleep time function
4: Turn the monitor off by RS-232C function
5: 5V down
6: AC down
7: Turn the monitor off by Fan Alarm function (option)
8: Turn the monitor off by Off time function
9: Turn the monitor off by Auto sleep function
a: Turn the monitor off by AV board detect

* This function is "read only".

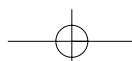

External Control Device Setup

23. ISM Method
(Command 1 : j, Command 2 : p)

► To control the ISM method. You can also adjust ISM Method in SPECIAL menu.

Transmission

[j][p][][Set ID][][Data][Cr]

Data 8 : Normal Mode 2 : Orbiter
4 : White Wash 1 : Inversion

Ack

[p][][Set ID][][OK][Data][x]

24. Low Power
(Command 1 : j, Command 2 : q)

► To reduce the power consumption of the monitor. You can also adjust Low Power in SPECIAL menu.

Transmission

[j][q][][Set ID][][Data][][Cr]

Data 0 : Off
1 : On

Ack

[q][][Set ID][][OK][Data][x]

25. Orbiter Time Setting
(Command 1 : j, Command 2 : r)

► To adjust orbiter operation time term.

Transmission

[j][r][][Set ID][][Data][][Cr]

Data Min: 1 ~ Max: FE
* Refer to 'Real data mapping 1'. See page 35.

Ack

[r][][Set ID][][OK][Data][x]

26. Orbiter Pixel Setting
(Command 1 : j, Command 2 : s)

► To adjust pixel number in orbiter function.

Transmission

[j][s][][Set ID][][Data][Cr]

Data Min: 1 ~ Max: 3
* Refer to 'Real data mapping 1'. See page 35.

Ack

[s][][Set ID][][OK][Data][x]

27. Auto Configure
(Command 1 : j, Command 2 : u)

► To adjust picture position and minimize image shaking automatically. It works only in RGB (PC) mode.

Transmission

[j][u][][Set ID][][Data][Cr]

Data 1: To set

Ack

[u][][Set ID][][OK][Data][x]

28. Key
(Command 1 : m, Command 2 : c)

► To send IR remote key code.

Transmission

[m][c][][Set ID][][Data][Cr]

Data Key code - Refer to page 40.

Ack

[c][][Set ID][][OK][Data][x]

29. Input select (Command 1 : x, Command 2 : b)
(Main Picture Input)

► To select input source for monitor.

Transmission

[x][b][][Set ID][][Data][Cr]

Data Structure

MSB				LSB			
0	0	0	0	0	0	0	0
└ External Input ─┘				└ Input Number ─┘			

External Input				Data
0	0	1	0	Video
0	1	0	0	Component
0	1	0	1	RGB-DTV
0	1	1	0	RGB-PC
1	0	0	1	HDMI

Input Number				Data
0	0	0	0	Input1
0	0	0	1	Input2

Ack

[b][][Set ID][][OK][Data][x]

If you use either RGB-DTV or RGB-PC command, It is possible to select RGB input.

* If you read status of the input mode in RGB input, Monitor will always send the DTV mode status.

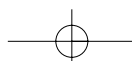

IR Codes

How to Connect

- ▶ Connect your wired remote control to the Remote Control port on the Monitor.

Remote Control IR Code

▶ Output waveform

Single pulse, modulated with 37.917KHz signal at 455KHz

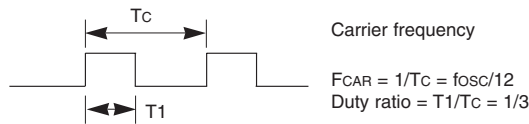

▶ Configuration of frame

- 1st frame

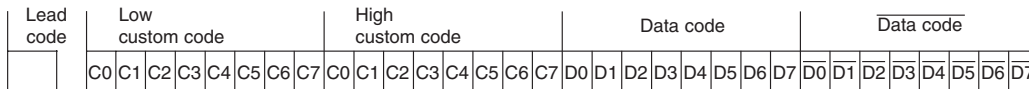

- Repeat frame

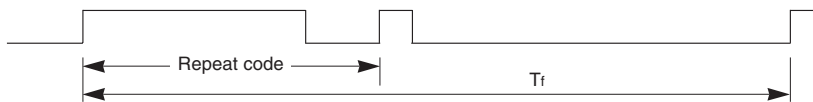

▶ Lead code



▶ Repeat code

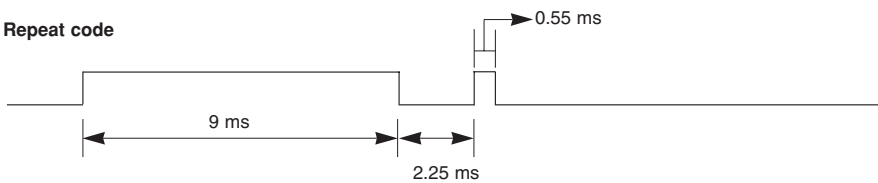

▶ Bit description

- Bit "0"

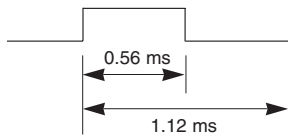

- Bit "1"

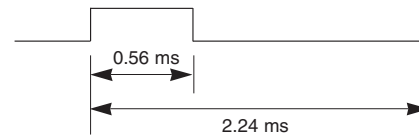

▶ Frame interval : Tf

The waveform is transmitted as long as a key is depressed.

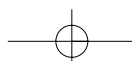
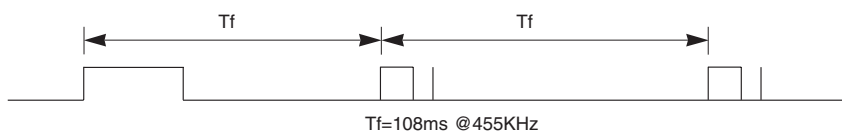

IR Codes

Code (Hexa)	Function	Note
00	▲	R/C Button
01	▼	R/C Button
02	VOL (▶)	R/C Button
03	VOL (◀)	R/C Button
08	POWER	R/C Button (Power On/Off)
C4	POWER ON	Discrete IR Code (Only Power On)
C5	POWER OFF	Discrete IR Code (Only Power Off)
09	MUTE	R/C Button
5B	EXIT	R/C Button
10	Number Key 0	R/C Button
11	Number Key 1	R/C Button
12	Number Key 2	R/C Button
13	Number Key 3	R/C Button
14	Number Key 4	R/C Button
15	Number Key 5	R/C Button
16	Number Key 6	R/C Button
17	Number Key 7	R/C Button
18	Number Key 8	R/C Button
19	Number Key 9	R/C Button
98	MULTIMEDIA	R/C Button
0B	INPUT	R/C Button
5A	VIDEO	Discrete IR Code (Input VIDEO Selection)
BF	COMPONENT1	Discrete IR Code (Input COMPONENT1 Selection)
D4	COMPONENT2	Discrete IR Code (Input COMPONENT2 Selection)
C6,CE	HDMI	Discrete IR Code (Input HDMI Selection)
D5	RGB	Discrete IR Code (Input RGB Selection)
0E	SLEEP	R/C Button
43	MENU	R/C Button
44	ENTER	R/C Button
4D	APC	R/C Button
52	DASP	R/C Button
5D	ZOOM -	R/C Button
5C	ZOOM +	R/C Button
79	ARC	R/C Button
76	ARC (4:3)	Discrete IR Code (Only 4:3 mode)
77	ARC (16:9)	Discrete IR Code (Only 16:9 mode)
AF	ARC (Zoom)	Discrete IR Code (Only Zoom mode)
99	AUTO CONFIG	Discrete IR Code

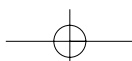

Troubleshooting Checklist

<p>No picture & No sound</p>	<ul style="list-style-type: none"> • Check whether the Monitor is turned on. • Is the power cord inserted into wall power outlet? • Test the wall power outlet, plug another product's power cord into the outlet where the Monitor's power cord was plugged in.
<p>Picture OK & No sound</p>	<ul style="list-style-type: none"> • Press the VOLUME (▶) button. • Sound muted? Press MUTE button.
<p>The remote control doesn't work</p>	<ul style="list-style-type: none"> • Check to see if there is any object between the Monitor and the remote control causing obstruction. • Are batteries installed with correct polarity (+ to +, - to -)? (Refer to p.9) • Correct remote operating mode set: Monitor, VCR etc.? • Install new batteries. (Refer to p.9)
<p>Picture appears slowly after switching on</p>	<ul style="list-style-type: none"> • This is normal, the image is muted during the Monitor startup process. Please contact your service center, if the picture has not appeared after five minutes.
<p>No or poor color or poor picture</p>	<ul style="list-style-type: none"> • Select Color in the Picture menu and press the VOLUME (▶) button. (Refer to p.19) • Keep a sufficient distance between the Monitor and the VCR. • Activate any function to restore the brightness of the picture. (If still picture is on the screen for more than 5 minutes, the screen gets dark.)
<p>Horizontal/vertical bars or picture shaking</p>	<ul style="list-style-type: none"> • Check for local interference such as an electrical appliance or power tool.
<p>No output from one of the speakers</p>	<ul style="list-style-type: none"> • Adjust Balance in the Sound menu. (Refer to p.21)
<p>Unusual sound from inside the Monitor</p>	<ul style="list-style-type: none"> • A change in ambient humidity or temperature may result in an unusual noise when the plasma display is turned on or off and does not indicate a fault with the Monitor.

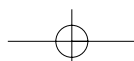

Product Specifications

MODELS	42PM1M-UC	42PM3MV-UC	50PM1M-UC
Width (inches / mm)	42.0 / 1066.0	41.3 / 1050.0	49.3 / 1253.0
Height (inches / mm)	25.6 / 650.0	24.8 / 630.0	29.3 / 745.0
Depth (inches / mm)	3.8 / 97.5	3.6 / 91.5	3.9 / 99.5
Weight (pounds / kg)	66.1 / 30.0	50.9 / 23.1	84.7 / 38.4
Resolution	1024 x 768 (Dot)	852 x 480 (Dot)	1366 x 768 (Dot)
Power requirement	AC100-240V, 50/60Hz	AC100-240V, 50/60Hz	AC100-240V, 50/60Hz
Operating Temperature Range	32 ~ 104°F (0 ~ 40°C)	32 ~ 104°F (0 ~ 40°C)	32 ~ 104°F (0 ~ 40°C)
Operating Humidity Range	Less than 80%	Less than 80%	Less than 80%

- The specifications shown above may be changed without notice for quality improvement.

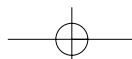



**LG ELECTRONICS, INC.
PLASMA TV — U.S. LIMITED WARRANTY**

Your LG Plasma TV will be repaired or replaced in accordance with the terms of this warranty, at LGE's option, if it proves to be defective in material or workmanship under normal use, during the warranty period ("Warranty Period") listed below, effective from the date ("Date of Purchase") of original consumer purchase of the product. This warranty is good only to the original purchaser of the product and effective only when used in the United States, including Alaska, Hawaii, and U.S. Territories.

<p><u>WARRANTY PERIOD:</u></p> <p>LABOR and PARTS: 2 YEARS from the Date of Purchase. Your unit will be repaired or replaced with a new, substitute model or factory reconditioned unit, at LGE's option. If repaired, parts used in the repair may be new or remanufactured.</p> <p>Replacement Units and Repair Parts are warranted for the remaining portion of the original unit's warranty period.</p> <p>EFFECTIVE DATE OF WARRANTY: Your warranty period begins on the date of sale to the original consumer/end user. KEEP THE DEALER'S DATED BILL OF SALE OR PROOF OF DELIVERY as evidence of the purchase date. You will be required to submit a legible copy of your bill of sale or proof of delivery when requesting warranty service.</p>	<p><u>HOW SERVICE IS HANDLED:</u></p> <p>In-Home Service: Please retain dealer's dated bill of sale or delivery ticket as evidence of the Date of Purchase for proof of warranty, and submit a copy of the bill of sale to the service person at the time warranty service is provided.</p> <p>Please call 1-800-243-0000 to locate your nearest LGE Authorized Service Center.</p> <p>Visit our website at: http://www.lgservice.com</p>
--	--

THIS WARRANTY IS IN LIEU OF ANY OTHER WARRANTY, EXPRESS OR IMPLIED, INCLUDING WITHOUT LIMITATION, ANY WARRANTY OF MERCHANTABILITY OR FITNESS FOR A PARTICULAR PURPOSE. TO THE EXTENT ANY IMPLIED WARRANTY IS REQUIRED BY LAW, IT IS LIMITED IN DURATION TO THE EXPRESS WARRANTY PERIOD ABOVE. NEITHER THE MANUFACTURER NOR ITS U.S. DISTRIBUTOR SHALL BE LIABLE FOR ANY INCIDENTAL, CONSEQUENTIAL, INDIRECT, SPECIAL, OR PUNITIVE DAMAGES OF ANY NATURE, INCLUDING WITHOUT LIMITATION, LOST PROFITS, LOST OR CORRUPTED PROGRAMMING OR DATA, OR ANY OTHER DAMAGE WHETHER BASED IN CONTRACT, TORT, OR OTHERWISE. Some states do not allow the exclusion or limitation of incidental or consequential damages or limitations on how long an implied warranty lasts, so the above exclusion or limitation may not apply to you. This warranty gives you specific legal rights and you may also have other rights that vary from state to state.

CONCERNING PIXEL FUNCTIONALITY: Your Plasma TV contains about one million individual pixels. Plasma TV typically contain a small number of pixels that do not function normally. Your display has been inspected and is in compliance with manufacturer's specifications, indicating that any pixel defects do not effect the operation or use of your display.

IMPORTANT: Please fill out and mail in your Product Registration Card or go to www.lgservice.com to register your product online. This information will allow us to reach you promptly should we discover a safety or reliability problem that could affect you.

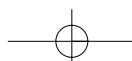

THIS LIMITED WARRANTY DOES NOT APPLY TO:

<ul style="list-style-type: none"> ● damage caused in shipping or transit ● service required as a result of improper installation, including incorrect or insufficient AC supply (please consult the owner's manual for power supply requirements) ● installation or repair of antenna systems, cable converters, cable company supplied equipment, or other components in a video system ● set-up or adjustment on consumer controls, or damage caused by improper adjustments ● damage caused by other system components ● any panel that has been modified or incorporated into any other product ● replacement of batteries on the remote control. ● damage (including cosmetic damage), failure, loss or personal injury due to misuse, abuse, negli- 	<p>gence, improper maintenance or storage, or to acts of nature or other causes beyond our control. (Causes beyond our control include but are not limited to lightning strike, power surges, power outages and water damage.)</p> <ul style="list-style-type: none"> ● image burn-in ● repair or replacement of warranted parts by other than LGE authorized service centers. ● units purchased or serviced outside of the coverage area. ● product where the original factory serial numbers have been removed, defaced or changed in any way. ● product sold and labeled as "as is, where is" or similar disclaimer.
--	--

The cost of repair or replacement under these excluded circumstances shall be borne by the consumer.

CUSTOMER INTERACTIVE CENTER NUMBERS:

<p>To obtain customer assistance, product information or Dealer or Service locations</p>	<p>Call 1-800-243-0000 24 hours a day, 365 days per year</p>
---	---

FOR SERVICE:

Before you call for warranty service, check your operating guide – you may avoid a service call.

For warranty service information, please contact the LGE Customer Interactive Center telephone number.

When calling for service, **please have your product model number, serial number and the date of purchase or the date of original installation available.**

If a replacement unit is required, under some circumstances you may be asked to provide a reserve deposit to the LGE Service Center against a credit card number as surety for advanced shipment. Your credit card will not be charged if you return the defective unit within 10 working days.

If a replacement unit is received, please use the carton and packaging from that unit in returning the defective unit to the LG®Brand Service Center.

Parts and service in accordance with the LGE warranty are LGE's responsibility and will be provided without charge. Other service requirements will be at the owner's expense. If you have problems in obtaining satisfactory warranty service, write or call the LGE Customer Interactive Center. Service may be provided by independently owned and operated service organizations.

To assure proper credit and avoid unnecessary charges, you must obtain an LGE Return Authorization before returning any product to the LGE Service Center. Contact the Customer Interactive Center for details.

STO CONTACT THE LGE CUSTOMER SERVICE CENTER BY MAIL:

LGE Customer Interactive Center
 P.O. Box 240007
 201 James Record Road
 Huntsville, Alabama 35824
<http://www.lgservice.com>

P/N : 38289U0514A ⑥

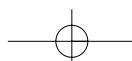

Free Manuals Download Website

<http://myh66.com>

<http://usermanuals.us>

<http://www.somanuals.com>

<http://www.4manuals.cc>

<http://www.manual-lib.com>

<http://www.404manual.com>

<http://www.luxmanual.com>

<http://aubethermostatmanual.com>

Golf course search by state

<http://golfingnear.com>

Email search by domain

<http://emailbydomain.com>

Auto manuals search

<http://auto.somanuals.com>

TV manuals search

<http://tv.somanuals.com>