



DVD PLAYER

OWNER'S MANUAL

MODEL : DVD-3350E



Before connecting, operating or adjusting this product,
please read this instruction booklet carefully and completely.

FOR THE GUARANTEE TERMS & CONDITIONS,
PLEASE REFER TO BACK COVER OF THIS MANUAL.

Safety Precautions

WARNING: TO REDUCE THE RISK OF FIRE OR ELECTRIC SHOCK, DO NOT EXPOSE THIS PRODUCT TO RAIN OR MOISTURE.

CAUTION: THIS DVD PLAYER EMPLOYS A LASER SYSTEM.

TO ENSURE PROPER USE OF THIS PRODUCT, PLEASE READ THIS OWNER'S MANUAL CAREFULLY AND RETAIN FOR FUTURE REFERENCE, SHOULD THE UNIT REQUIRE MAINTENANCE, CONTACT AN AUTHORIZED SERVICE LOCATION-SEE SERVICE PROCEDURE.

USE OF CONTROLS, ADJUSTMENTS OR THE PERFORMANCE OF PROCEDURES OTHER THAN THOSE SPECIFIED MAY RESULT IN HAZARDOUS RADIATION EXPOSURE.

TO PREVENT DIRECT EXPOSURE TO LASER BEAM, DO NOT TRY TO OPEN THE ENCLOSURE. VISIBLE LASER RADIATION WHEN OPEN THE ENCLOSURE. DO NOT STARE INTO BEAM.

WARNING: CHANGES OR MODIFICATIONS NOT EXPRESSLY APPROVED BY THE PARTY RESPONSIBLE FOR COMPLIANCE COULD VOID THE USER'S AUTHORITY TO OPERATE THE EQUIPMENT.

POWER: This DVD player operates on a mains supply of 100-240V~, 50/60Hz.

WIRING: This DVD player is supplied with a BSI 1363 approved 13 amp mains plug, fused at 13 or 5 amp. When replacing the fuse always use a 13 or 5 amp BS 1362, BSI or ASTA approved type. Never use this plug with the fuse cover omitted. To obtain a replacement fuse cover contact your dealer or "LG Electronics U.K.Ltd." If the type of plug supplied is not suitable for the mains sockets in your home, then the plug should be removed and a suitable type fitted. Please refer to the wiring instructions below:

WARNING: A mains plug removed from the mains lead of this DVD player must be destroyed. A mains plug with bared wires is hazardous if inserted in a mains socket.

Do not connect either wire to the earth pin, marked with the letter E or with the earth symbol \perp or coloured green or green and yellow.

If any other plug is fitted, use a 13 or 5 amp fuse, either in the plug, or at the distribution board.

IMPORTANT: The wires in this mains lead are coloured in accordance with the following codes:

- **BLUE: NEUTRAL, BROWN: LIVE** - As the colours of the wires in the mains lead of this DVD player may not correspond with the coloured marking identifying the terminals in your plug, proceed as follows: The wire which is coloured blue must be connected to the terminal which is marked with the letter N or coloured black. The wire which is coloured brown must be connected to the terminal which is marked with the letter L or coloured red.

 This product is manufactured to comply with the radio interference requirements of EEC DIRECTIVE 89/336/EEC, 93/68/EEC and 73/23/EEC.

RECORD YOUR MODEL NUMBER (Now, while you can see it)

The model and serial number of your new DVD player are located on the back of the DVD player cabinet. For your future convenience, we suggest that you record these numbers here:

MODEL NO. _____

SERIAL NO. _____

Table of Contents

Introduction

- ❑ Safety Precautions 2
- ❑ Table of Contents 3
- ❑ Precautions 4
- ❑ Notes on Discs 5
- ❑ Identification of Controls 6-9
 - Front Panel/Display window 6
 - Rear Panel 7
 - Remote Control 8
 - Preparing the Remote Control 9
 - Operating with the Remote Control 9

Connections

- ❑ Connecting to a TV 10
- ❑ Connecting to an Audio System 11
- ❑ Connecting to Optional Audio System 12-15
 - Enjoying Dolby Digital Sound 12
 - Enjoying Dolby Digital (5.1CH) Sound 13
 - Enjoying Dolby Pro Logic Surround Sound 14
 - Enjoying 2 Channel Digital Stereo Sound 15
 - Enjoying DTS Sound 15

Basic Operations

- ❑ Basic Playback 16-18
- ❑ Various speed playback with Shuttle Ring 19

Operation Using GUI Menu Icons

- ❑ General Information about GUI menu icons 20
- ❑ Detailed description of each GUI menu icon 21

Advanced Operation

- ❑ Using a title menu 22
- ❑ Using a DVD menu 22
- ❑ Memorizing Settings for Viewed DVDs 23
- ❑ Changing subtitle language 24
- ❑ Changing audio soundtrack language 24
- ❑ Viewing from another angle 25
- ❑ Producing a 3D Surround effect 25
- ❑ Repeat Play 26
- ❑ Storing markers in memory to be viewed (listened to) again 27
- ❑ Zoom Feature 28
- ❑ Random Play 28
- ❑ Program Play 29
- ❑ Playback with MP3 30-31

Initial Settings

- ❑ Common procedures of initial settings 32
- ❑ Selecting disc Languages 33
- ❑ Selecting rating level and password 34-35
- ❑ Selecting TV Aspect 36
- ❑ Selecting Menu Language 37
- ❑ Selecting TV Output 37
- ❑ Selecting Pseudo PAL 38
- ❑ Selecting Digital Audio Output 39
- ❑ Setting the Speaker Setup 40
- ❑ Table of Languages and Their Abbreviations 41

Reference

- ❑ Disc Requirements/Copyright Information 42
- ❑ Before Calling Service Personnel 43
- ❑ Specifications 44

Precautions

Notes on handling

- ❑ When shipping the DVD player, always use the original shipping carton and packing materials. For maximum protection, repack the unit as it was originally packed at the factory.
- ❑ Do not use volatile liquids, such as insect spray, near the DVD player. Do not leave rubber or plastic products in contact with the DVD player for a long time. They will leave marks on the finish.
- ❑ The top and rear panels of the DVD player may become warm after a long period of use. This is normal and not a malfunction.
- ❑ When the DVD player is not in use, be sure to remove the disc and turn off the power.
- ❑ If you do not use the DVD player for a long period, the unit may not function properly in the future. Turn on and use the DVD player occasionally.

Notes on Locating

- ❑ When you place this DVD player near a TV, radio, or VCR, the playback picture may become poor and the sound may be distorted. In this case, move the DVD player away from the TV, radio, or VCR.

Notes on Cleaning

Use a soft, dry cloth for cleaning.

- ❑ For stubborn dirt, soak the cloth in a weak detergent solution, wring well and wipe. Use a dry cloth to wipe it dry. Do not use any type of solvent, such as thinner and benzene, as they may damage the surface of the DVD player.
- ❑ If you use a chemical saturated cloth to clean the unit, follow that product's instructions.

Warning: Cleaning and adjustment of lenses and/or other components of playback mechanism should be performed by a qualified service technician.

To Obtain a Clear Picture

The DVD player is a high technology, precision device. If the optical pick-up lens and disc drive parts are dirty or worn down, the picture quality becomes poor. To obtain a clear picture, we recommend regular inspection and maintenance (cleaning or parts replacement) every 1,000 hours of use depending on the operating environment. For details, contact your nearest dealer.

Notes on Moisture Condensation

Moisture condensation damages the DVD player. Please read the following carefully.

Moisture condensation occurs, for example, when you pour a cold drink into a glass on a warm day. Drops of water form on the outside of the glass. In the same way, moisture may condense on the optical pick-up lens inside this unit, one of the most crucial internal parts of the DVD player.

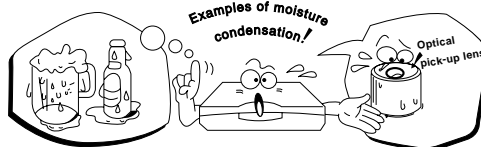

Moisture condensation occurs during the following cases.

- ❑ When you bring the DVD player directly from a cold place to a warm place.
- ❑ When you use the DVD player in a room where you just turned on the heater, or a place where the cold wind from the air conditioner directly hits the unit.
- ❑ In summer, when you use the DVD player in a hot and humid place just after you move the unit from an air conditioned room.
- ❑ When you use the DVD player in a humid place.

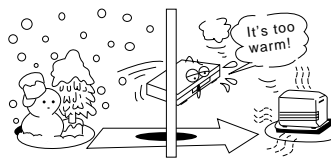

- ❑ **Do not use the DVD player when moisture condensation may occur.**

If you use the DVD player in such a situation, it may damage discs and internal parts. Remove the disc, connect the power cord of the DVD player to the wall outlet, turn on the DVD player and leave it "ON" for two or three hours. After two or three hours, the DVD player will have warmed up and evaporated any moisture. Keep the DVD player connected to the wall outlet and moisture condensation will seldom occur.

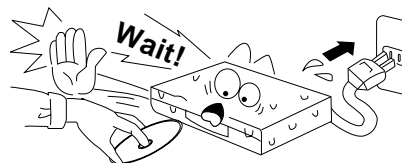

Notes on Discs

This section shows you how to handle, clean, and store discs.

On Handling Discs

- Do not touch the playback side of the disc.

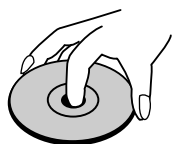

- Do not attach paper or tape to discs.



On Storing Discs

- Do not store discs in a place subject to direct sunlight or near heat sources.
- Do not store discs in places subject to moisture and dust such as a bathroom or near a humidifier.
- Store discs vertically in a case. Stacking or placing objects on discs outside of their case may cause warping.

On Cleaning Discs

- Fingerprints and dust on the disc cause picture and sound deterioration. Wipe the disc from the centre outward with a soft cloth. Always keep the disc clean.
- If you cannot wipe off the dust with a soft cloth, wipe the disc lightly with a slightly moistened soft cloth and finish with a dry cloth.
- Do not use any type of solvents such as thinner, benzene, commercially available cleaners or anti-static spray for vinyl LPs. They may damage the disc.

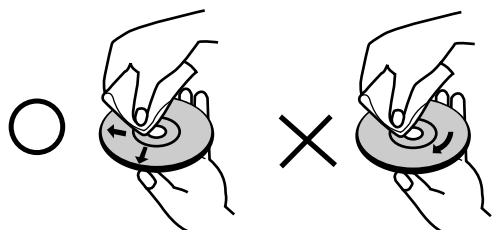

About This Owner's Manual

- This owner's manual explains the basic instructions of this DVD player.
- Some DVD video discs have functions that may not be explained in this owner's manual. Therefore, some instructions may differ from this owner's manual, and there may be extra instructions. In this case, follow the instructions displayed on the TV screen or package.
- "⊗" may appear on the TV screen during operation. This icon means the function explained in this owner's manual is not available on that specific DVD video disc.

Identification of Controls

Front Panel

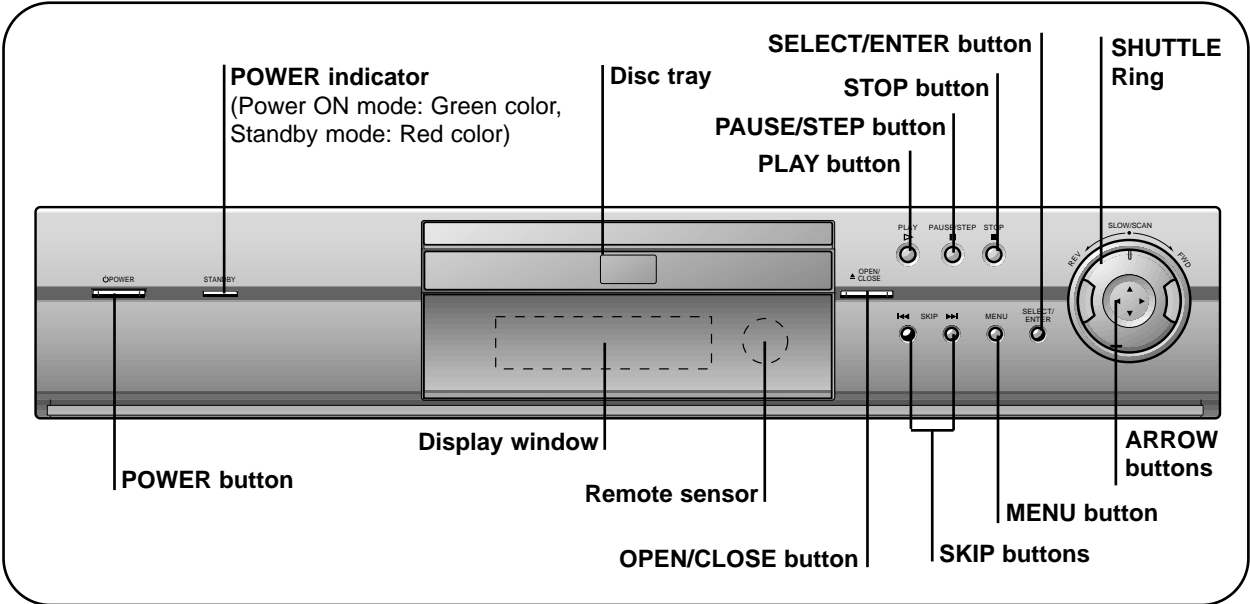

Display Window

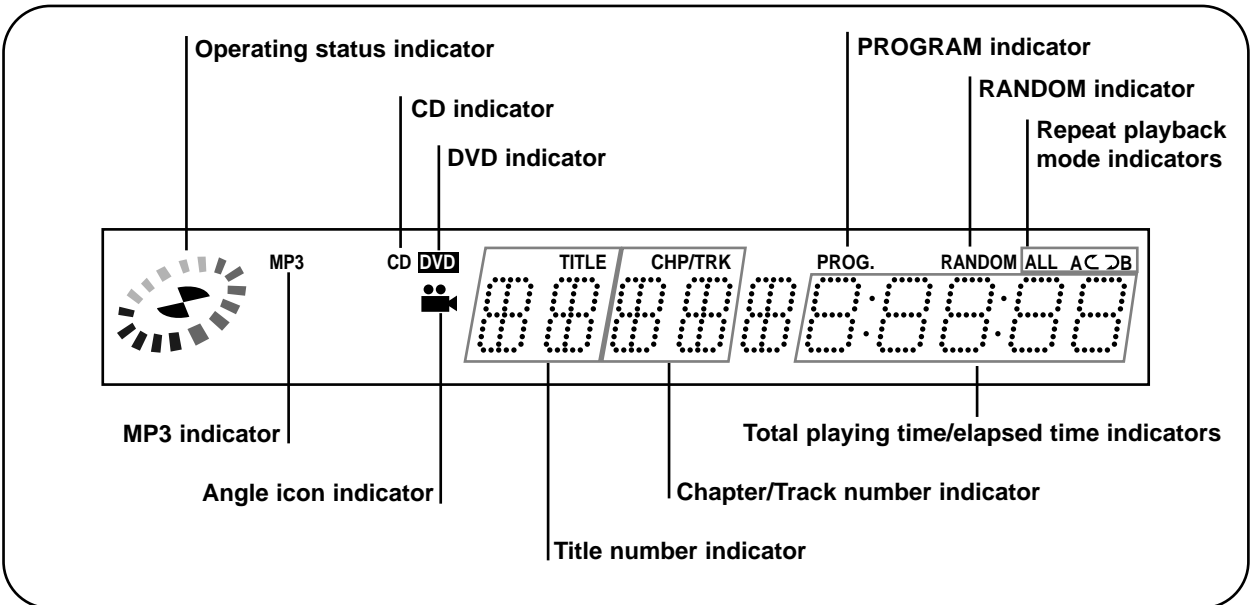

Identification of Controls

Rear Panel

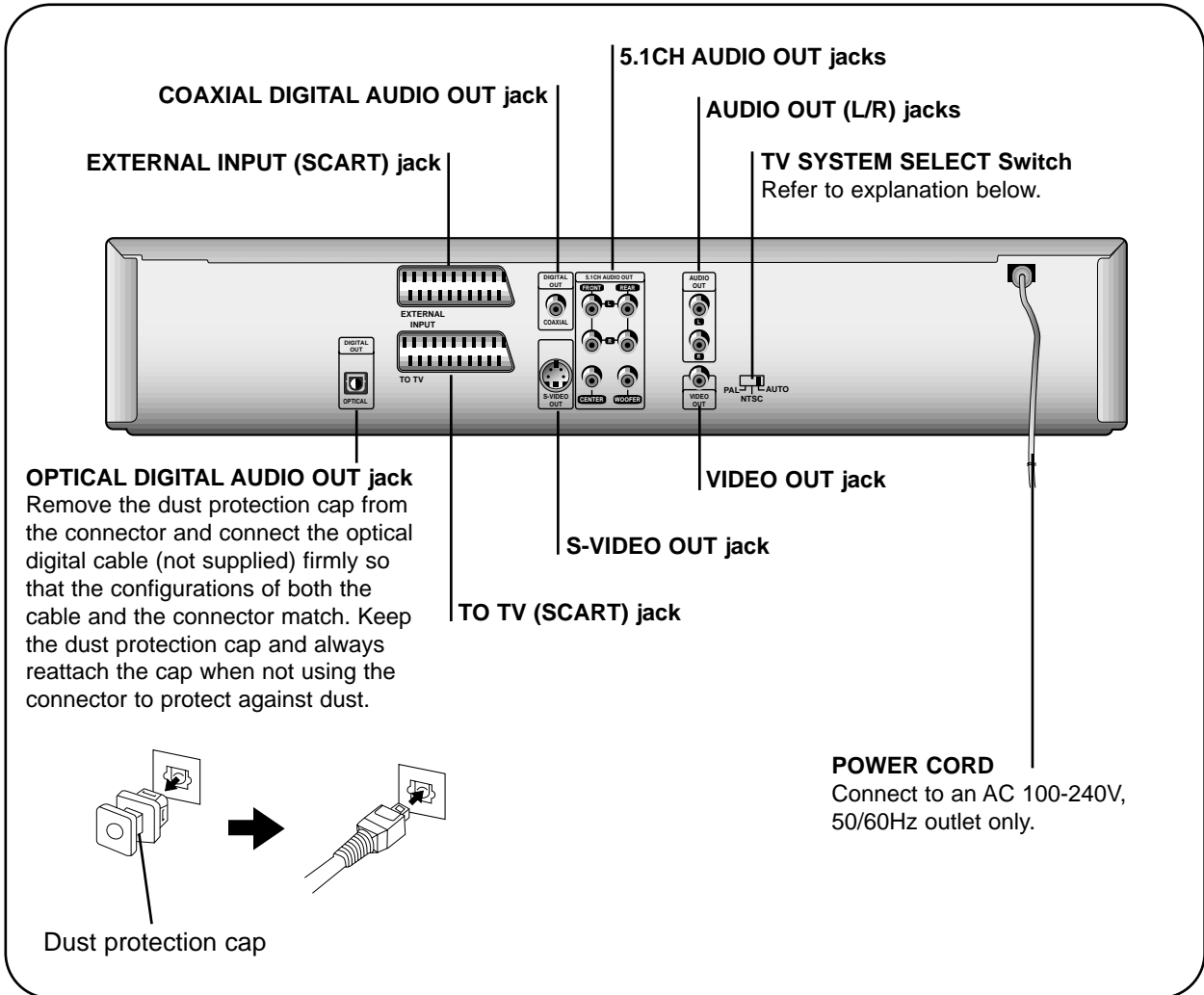

You can enjoy NTSC or PAL discs by using your TV SYSTEM SELECT switch to choose the appropriate system.

- If you try to playback PAL disc with NTSC-TV. The player will not playback the disc.
- When the selected TV SYSTEM SELECT switch does not coincide with the system of your TV, normal color picture may not be displayed.
- Select the TV SYSTEM SELECT switch when the power is turned off.
- When you playback NTSC disc with PAL-TV, some discs may produce black bands at the top and bottom of the screen.

Position of TV SYSTEM SELECT switch	Connected TV	Available disc
PAL	PAL	NTSC/PAL DVD disc
NTSC	NTSC	NTSC DVD disc
AUTO	MULTI system TV	NTSC/PAL DVD disc

Identification of Controls (con'd)

REMOTE CONTROL

You will find instructions for each of the remote control functions in the appropriate sections of this instruction manual.

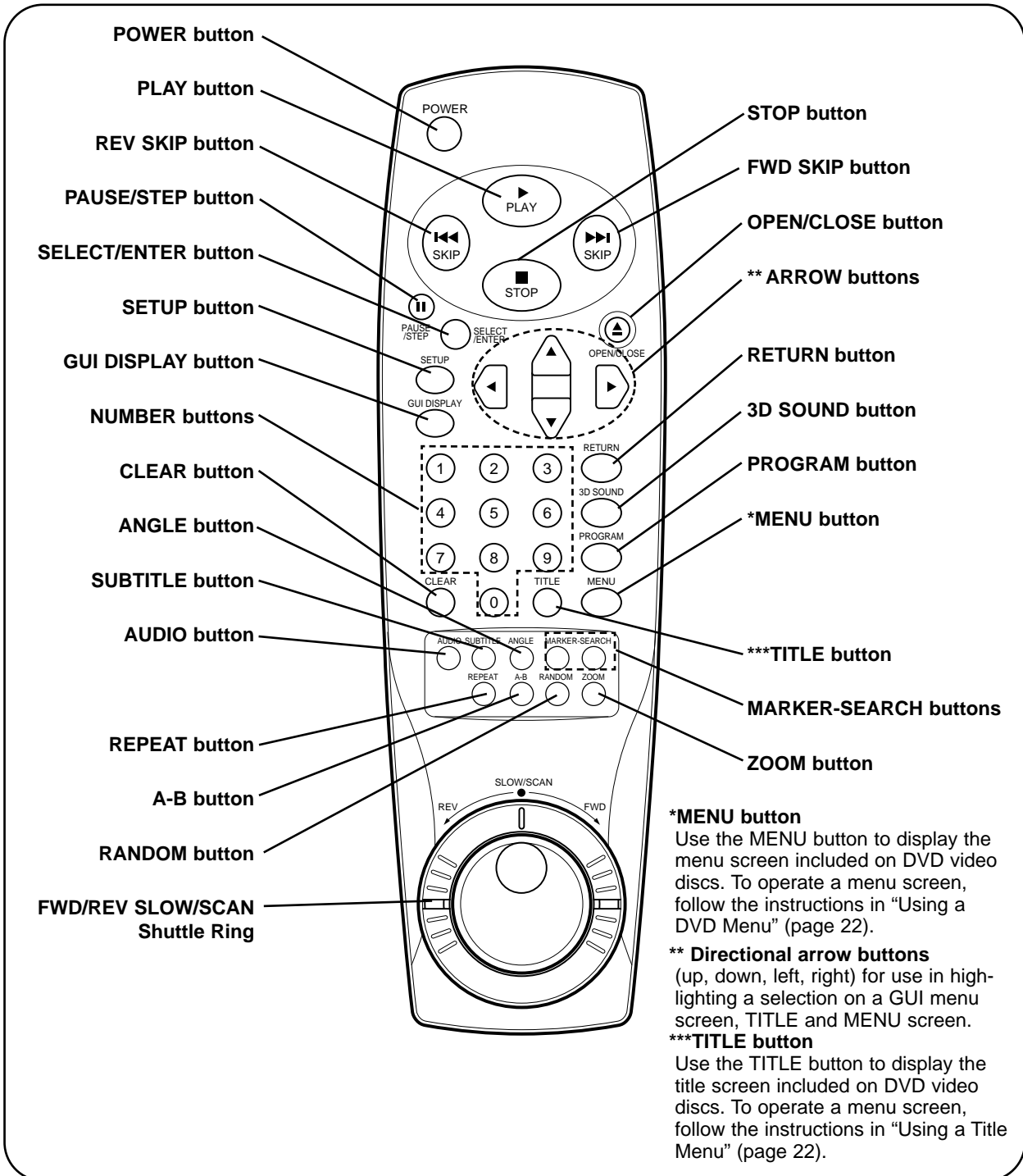

Identification of Controls (con'd)

Preparing the Remote Control

Insert the batteries into the remote control so you can use it to operate the DVD player.

1 Open the battery cover.

2 Insert batteries (AAA size).

- Make sure to match the + and - on the batteries to the marks inside the battery compartment.

3 Close the cover.

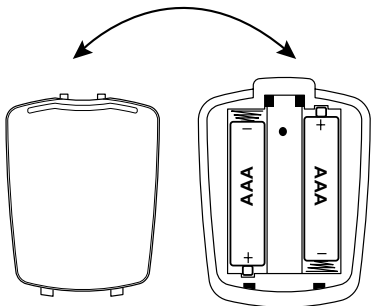

Notes on batteries

- Improper use of batteries may cause battery leakage and corrosion.
- To operate the remote control correctly, follow the instructions.
- Do not insert the batteries into the remote control in the wrong direction.
- Do not charge, heat, open, or short-circuit the batteries. Do not throw the batteries into fire.
- Do not leave dead or exhausted batteries in the remote control.
- Do not use different types of batteries together, or mix old and new batteries.
- If you do not use the remote control for a long period of time, remove the batteries to avoid possible damage from battery corrosion.
- If the remote control does not function correctly or if the operating range becomes reduced, replace all batteries with new ones.
- If battery leakage occurs, wipe the battery liquid from the battery compartment, then insert new batteries.
- The batteries should last about one year with normal use.

Operating with the Remote Control

This section shows you how to use the remote control.

Point the remote control at the remote sensor and press the buttons.

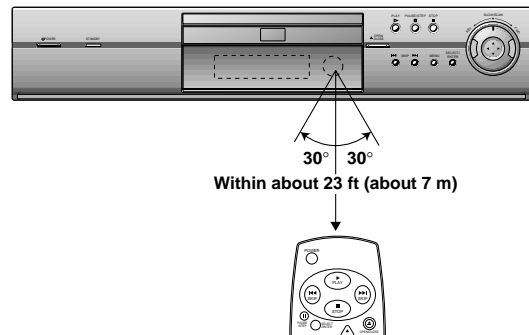

Distance: About 23 ft (7 m) from the front of the remote sensor

Angle: About 30° in each direction of the front of the remote sensor

- * Do not expose the remote sensor of the DVD player to a strong light source such as direct sunlight or illumination. If you do so, you may not be able to operate the DVD player with the remote control.

Notes on the remote control

- Direct the remote control at the remote sensor of the DVD player.
- Do not drop or give the remote control a shock.
- Do not leave the remote control near an extremely hot or humid place.
- Do not spill water or put anything wet on the remote control.
- Do not open the remote control.

Connecting to a TV

Connect the DVD player to your TV

If the DVD player is connected to the TV through a video cassette recorder, the picture may not be played back normally with some DVDs. So we strongly recommended you not to connect the DVD player to your video cassette recorder when setting up your home entertainment system.

- To view pictures from the video cassette recorder, set the player to the standby mode.

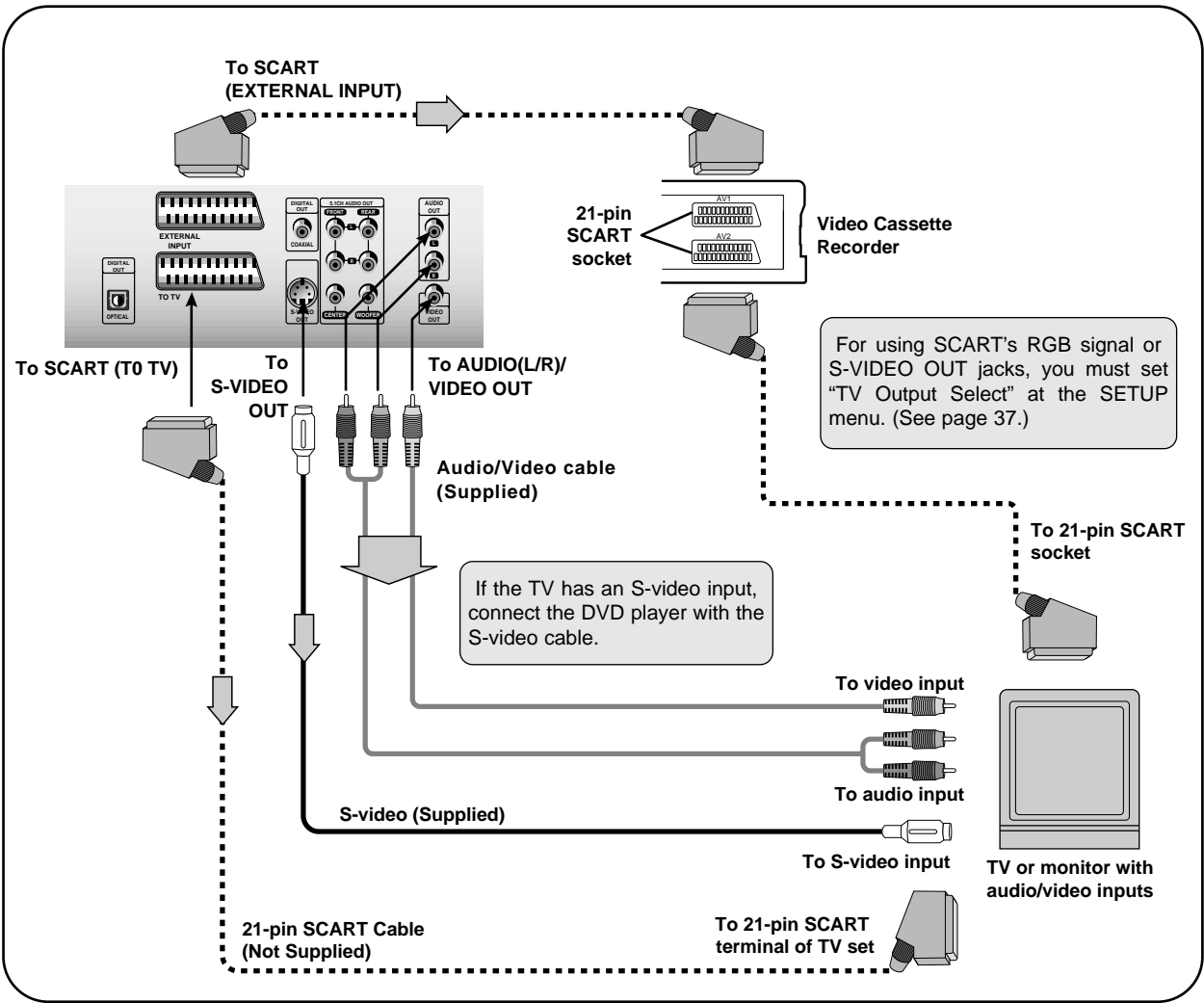

Notes

- Refer to the owner's manual of your TV as well.
- When you connect the DVD player to your TV, be sure to turn off the power and unplug both units from the wall outlet before making any connections.
- Connect the DVD player to your TV directly. If you connect the DVD player to a VCR, the playback picture will be distorted because DVD video discs are copy protected.
- In case of the TV set corresponding to RGB signal, the RGB signal is automatically selected in the TV. (Only when the "TV Output Select" is select to "Component" on the SETUP menu)

⚠ Warning

Do not set the Digital Audio Output of this DVD player to "Dolby Digital" unless you are connecting the DIGITAL OUT jack of this DVD player to an AV decoder that has the Dolby Digital decoding function. High volume sound may damage your hearing as well as the speakers. (Refer to "Selecting Digital Audio Output" on page 39.)

Connecting to an Audio System

You can listen to the sound of audio CDs and DVD video discs in stereo.

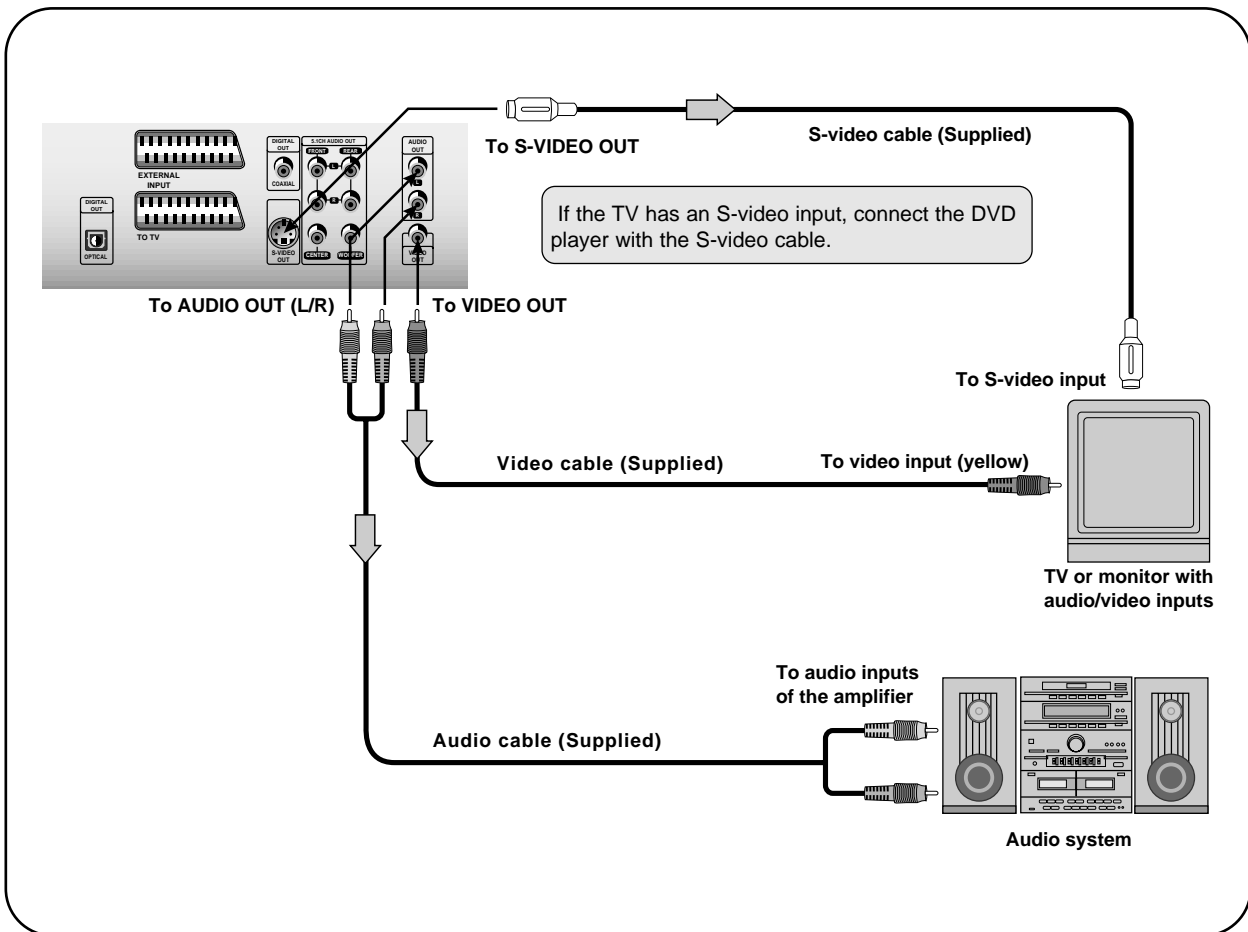

Notes

- Refer to the owner's manual of your audio system as well.
- When you connect the DVD player to other equipment, be sure to turn off the power and unplug all of the equipment from the wall outlet before making any connections.
- If you place the DVD player near a tuner or radio, the radio broadcast sound might be distorted. In this case, move the DVD player away from the tuner and radio.
- The output sound of the DVD player has a wide dynamic range. Be sure to adjust the receiver's volume to a moderate listening level. Otherwise, the speakers may be damaged by a sudden high volume sound.
- Turn off the receiver before you connect or disconnect the DVD player's power cord. If you leave the receiver power on, the speakers may be damaged.

Warning

Do not set the Digital Audio Output of this DVD player to "Dolby Digital" unless you are connecting the DIGITAL OUT jack of this DVD player to an AV decoder that has the Dolby Digital decoding function. High volume sound may damage your hearing as well as the speakers. (Refer to "Selecting Digital Audio Output" on page 39.)

Connecting to Optional Audio System

Enjoying Dolby Digital Sound

You can enjoy the high quality dynamic sound of Dolby Digital, Dolby Pro Logic, and 2 Channel Digital Stereo.

Dolby Digital

Dolby Digital is the surround sound technology used in theatres showing the latest movies, and is now available to reproduce this realistic effect in the home. You can enjoy motion picture and live concert DVD video discs with this dynamic realistic sound by connecting the DVD player to a 6 channel receiver equipped with a Dolby Digital decoder or Dolby Digital processor.

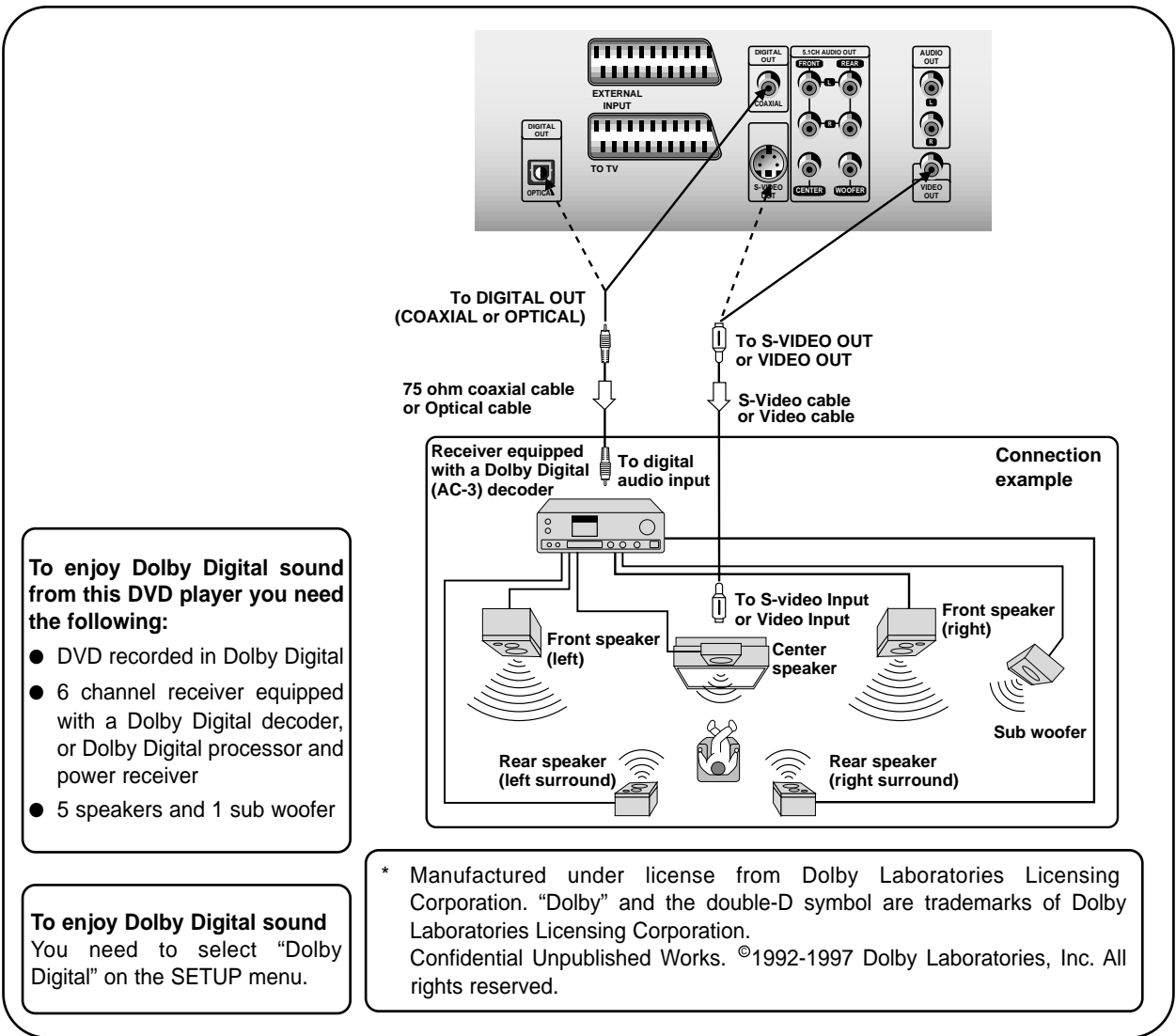

Notes

- Refer to the owner's manual of your audio equipment as well.
- When you connect the DVD player to other equipment, be sure to turn off the power and unplug all of the equipment from the wall outlet before making any connections.
- The output sound of the DVD player has a wide dynamic range. Be sure to adjust the receiver's volume to a moderate listening level. Otherwise, the speakers may be damaged by a sudden high volume sound.
- Turn off the receiver before you connect or disconnect the DVD player's power cord. If you leave the receiver power on, the speakers may be damaged.

Connecting to Optional Audio System

Enjoying Dolby Digital (5.1 CH) Sound

Dolby Digital Surround (5.1 CH)

Dolby Digital is a six-channel digital surround sound technology developed by Dolby Laboratories for theatre-like surround sound reproduction. DVDs supporting Dolby Digital technology feature the  logo. You can enjoy realistic, theatre-like surround sound from DVD movie or music disc featuring this logo. Two front, one centre and two rear speakers plus a subwoofer make up the "5.1-channel" audio system that Dolby Digital uses.

Hookups

Connect a receiver with 5.1 channel inputs to the player and to the speakers. See the figure below.

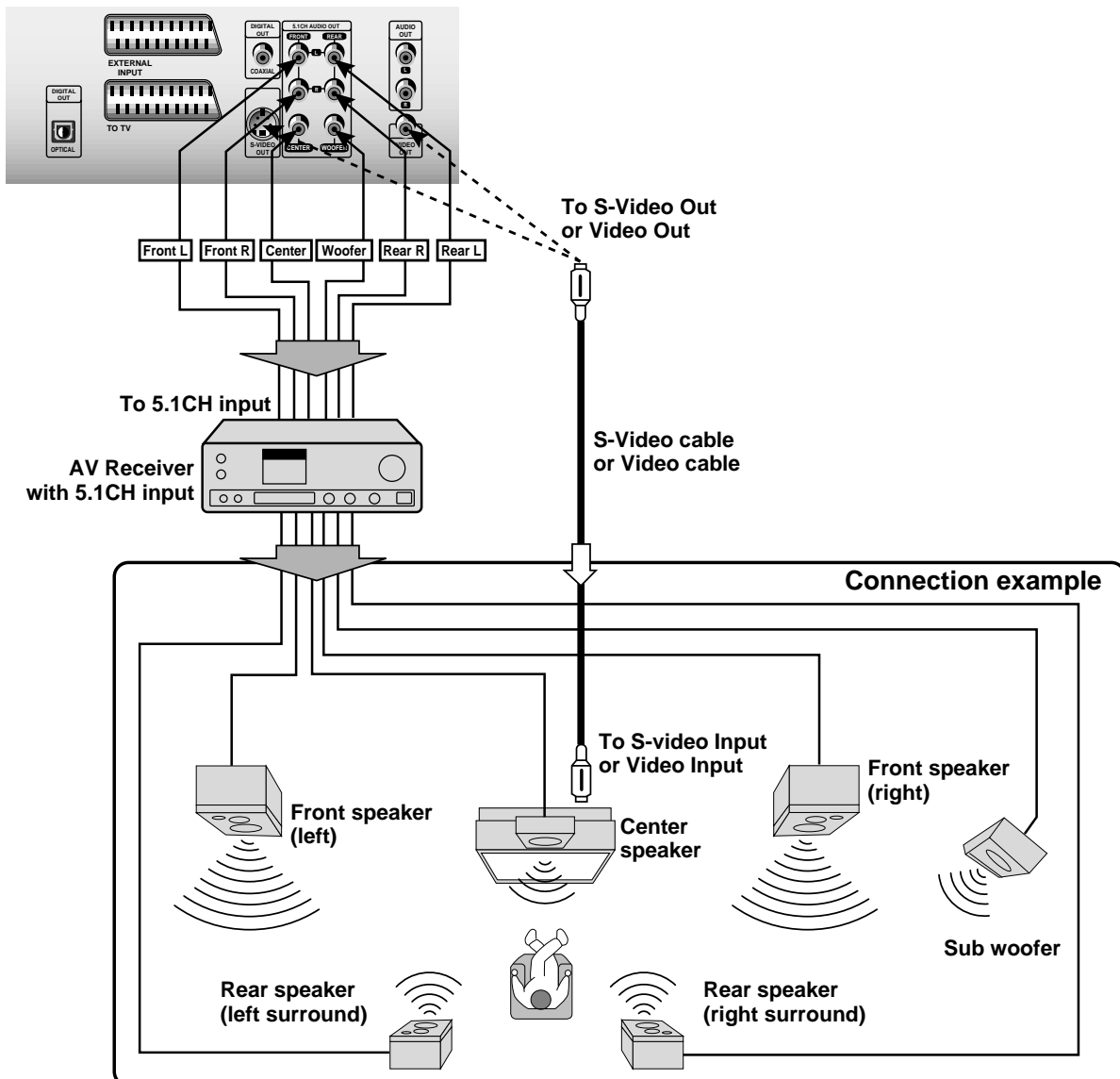

Connecting to Optional Audio System

Enjoying Dolby Pro Logic Surround Sound

Dolby Pro Logic Surround

You can still enjoy the excitement of Surround Sound even if your A/V receiver does not offer Dolby Digital decoding, if your A/V receiver has a Dolby Pro Logic decoder. Refer to the following connection diagram.

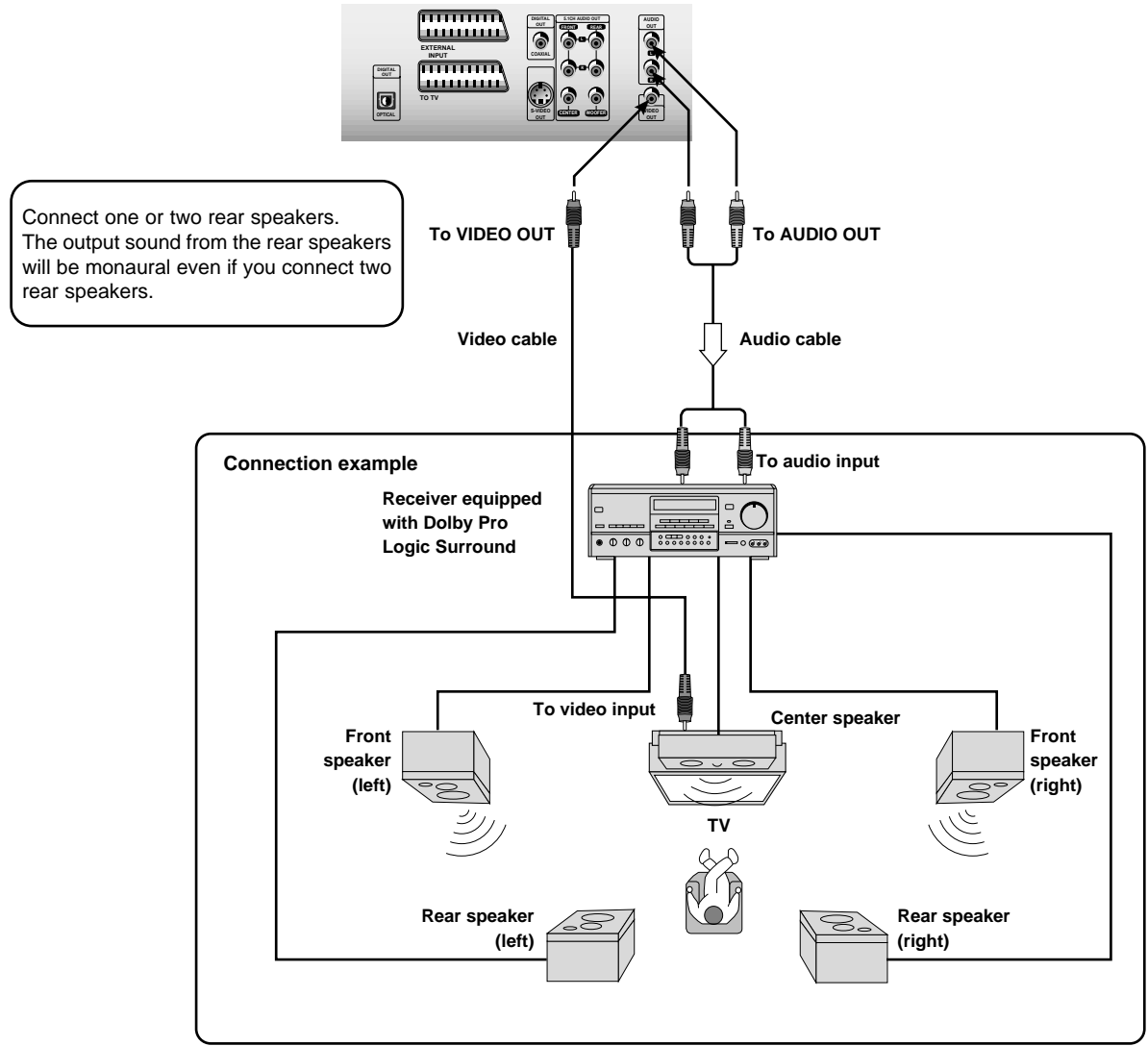

- **With a receiver equipped with Dolby Digital**
Connect the equipment the same way as described in "Enjoying Dolby Digital Sound" on the previous page. Refer to that receiver's owner's manual and set the receiver so you can enjoy Dolby Pro Logic Surround sound.

Warning

Do not set the Digital Audio Output of this DVD player to "Dolby Digital" unless you are connecting the DIGITAL OUT jack of this DVD player to an AV decoder that has the Dolby Digital decoding function. High volume sound may damage your hearing as well as the speakers. (Refer to "Selecting Digital Audio Output" on page 39.)

Connecting to Optional Audio System

Enjoying 2 Channel Digital Stereo Sound

2 Channel Digital Stereo

You can enjoy the dynamic sound of 2 Channel Digital Stereo by connecting this DVD player to a receiver equipped with a digital audio input and speaker system (right and left front speakers).

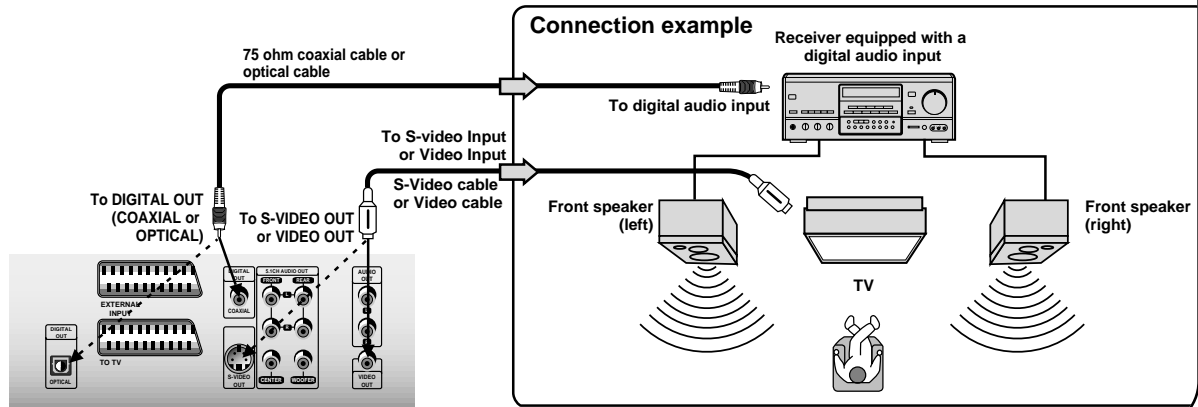

Enjoying DTS Sound

Introducing DTS Digital Surround™...the finest technology ever invented to transform existing "home theatre" systems into six discrete channels of exceptionally clear, better-than-compact disc, digital audio performance. And DTS Digital Surround is the only 5.1 surround sound format that can deliver this revolutionary 3-dimensional experience through new music recordings on compact discs, original 5.1 soundtracks on motion picture laserdiscs, and soon, a wide variety of products on DVD.

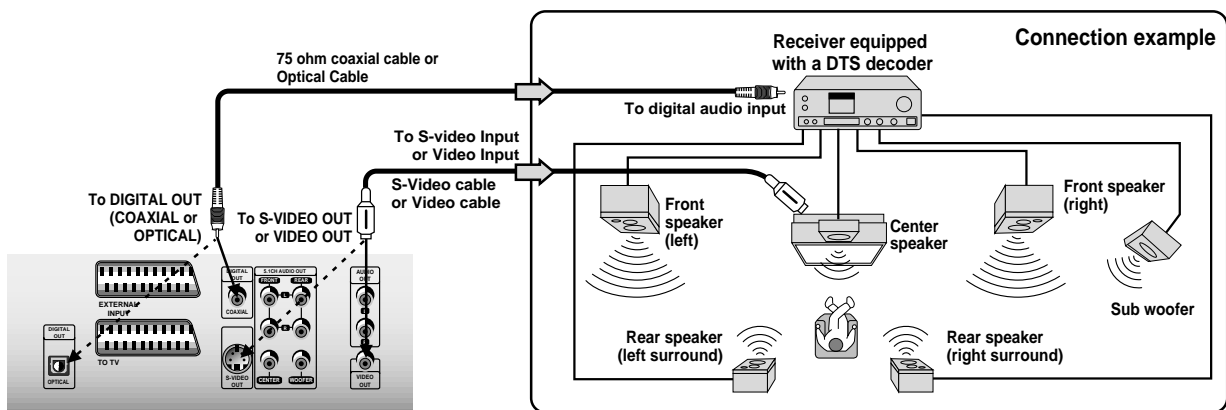

"DTS" and "DTS Digital Out" are trademarks of Digital Theater Systems, Inc.

Notes

- Refer to the owner's manual of your receiver as well.
- When you connect the DVD player to other equipment, be sure to turn off the power and unplug all of the equipment from the wall outlet before making any connections.
- The output sound of the DVD player has a wide dynamic range. Be sure to adjust the receiver's volume to a moderate listening level. Otherwise, the speakers may be damaged by a sudden high volume sound.
- Turn off the receiver before you connect or disconnect the DVD player's power cord. If you leave the receiver power on, the speakers may be damaged.

Basic Playback



This section shows you the basics on how to play back a DVD video disc.

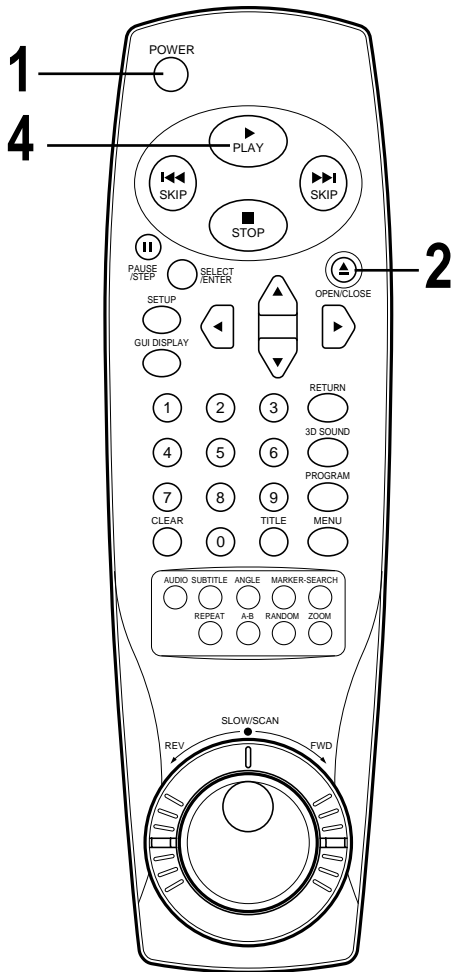
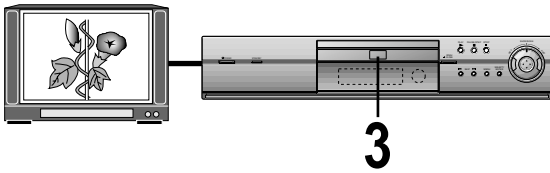

Preparations

- When you want to play back DVD video discs, turn on the TV and select the video input source connected to the DVD player.
- When you want to enjoy the sound of DVD video discs or audio CDs from the audio system, turn on the audio system and select the input source connected to the DVD player.
- For connection details, see pages 10 through 15.
- Set the playback picture size according to the aspect ratio of the connected TV at the SETUP menu (TV Aspect).
- If you do not have the necessary equipment to enjoy Dolby Digital sound, set the Digital Audio Output at the SETUP menu to "PCM".

1 Press POWER.

The DVD player turns on and the power indicator light is changed to a green color.

2 Press OPEN/CLOSE.

The disc tray opens.

- You can open the disc tray by pressing this button even if the DVD player is in standby mode.

3 Place a disc on the disc tray with the playback side down.

- There are two different disc sizes. Place the disc in the correct guide on the disc tray. If the disc is out of the guide, it may damage the disc and cause the DVD player to malfunction.
- Do not place anything except 3" discs or 5" discs on the disc tray.

4 Press PLAY.

The disc tray is automatically closed and playback begins.

- If the disc is placed in upside down (and it is a single sided disc), "NO DISC" or "DISC ERROR" appears on the TV screen.

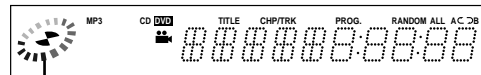

Operating status indicator

- If you insert an audio CD, the CD indicator lights up in the DVD display. The title number does not appear.
- After playing back all of the chapters in the title, the DVD player automatically stops and returns to the menu screen.

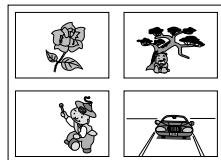

Example of interactive DVD On-Screen Menu

When a menu screen appears on the TV screen.

In case of interactive DVDs with control, a menu screen appears on the TV screen. Perform step 5 on page 17 to start play.

Basic Playback



5 Press ▲/▼/◀▶ and press SELECT/ENTER, or press the numeric button(s), to select the desired item.

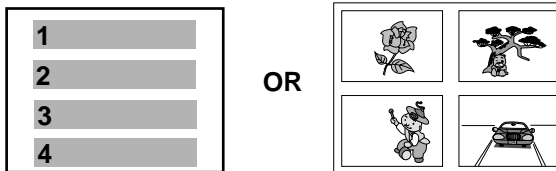
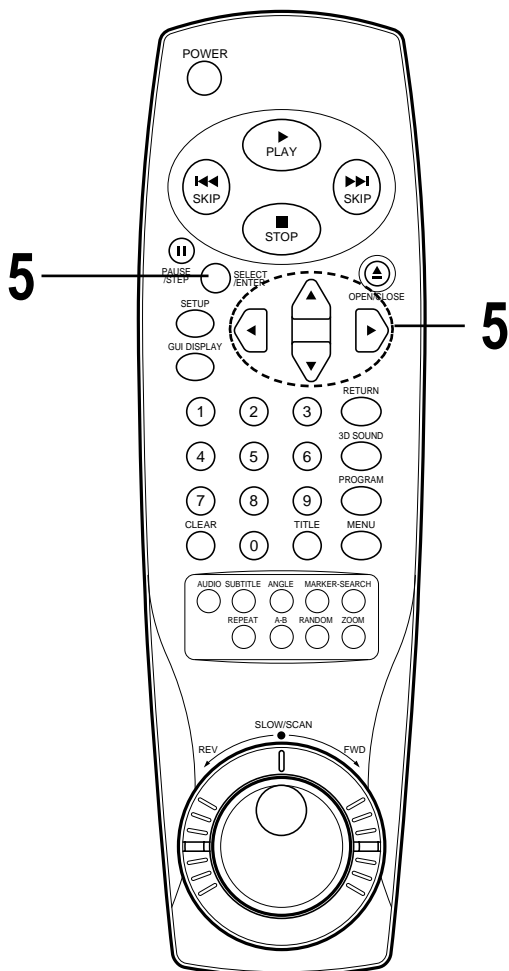

Play of the selected item now begins.

- For further information, also refer to the jacket or case of the disc you are playing.

After operation

When the unit is not in use, remove the disc and press POWER to turn off the power.

Notes

- Do not move the DVD player during playback. Doing so may damage the disc and the DVD player.
- Use the OPEN/CLOSE button on the remote control or DVD player to open and close the disc tray. Do not push the disc tray while it is moving. Doing so may cause the DVD player to malfunction.
- Do not push up the disc tray or put any objects other than discs on the disc tray. Doing so may cause the DVD video player to malfunction.
- Keep your fingers well clear of the disc tray as it is closing. Be especially careful with children's fingers around the closing disc tray as there is a risk of personal injury.
- When "⊘" appears on the TV screen while a button is pressed, it means that this function is not available on the disc you are playing.
- Depending on the DVD disc, some operations may be different or restricted. Refer to the jacket or case of the disc you are playing.

Basic Playback

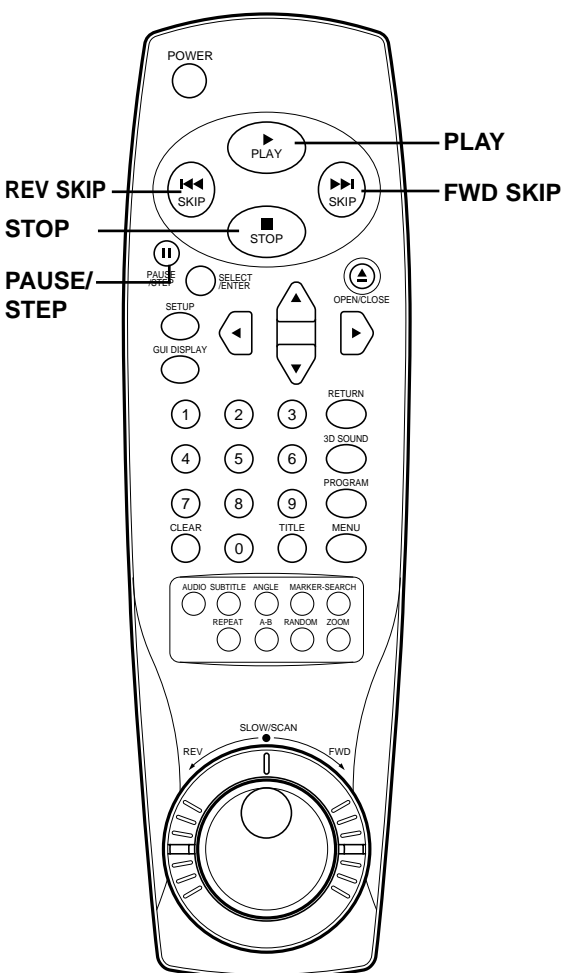

Stopping Play

Press **STOP** during playback.

Resume Play

- When play is stopped, the unit records the point where **STOP** was pressed (**RESUME** function). Press **PLAY** and play will resume from this point.

Notes

- Resume function will be cleared when the **STOP** is pressed on the **STOP** mode.
- Resume function will be cleared when the power is turned off and then on.
- Opening the disc tray cancels Resume function.
- The Resume function may not be available on some DVD discs.
- If the player is left in the stop mode for more than 8 minutes, the power shuts off automatically.

Still Picture (Pause)

Press **PAUSE/STEP** during playback.

- DVD
The player will be placed in the still picture mode.
- CD
The player will be placed in the pause mode.

Frame advance (DVD only)

Press **PAUSE/STEP** during still playback.

(Each time you press **PAUSE/STEP**, the picture advances one frame)

To resume normal playback, press **PLAY**.

Skipping forward or back

Skipping forward

Press **SKIP ►►** during playback.

A chapter (DVD) or a track (CD) is skipped each time the button is pressed.

Skipping back

Press **SKIP ◄◄** during playback.

- When the button is pressed once midway through a chapter/track, the player returns to the start of that chapter/track. When it is pressed again, a chapter/track is skipped each time the button is pressed.

Various speed playback with Shuttle Ring



You can play back discs at various speeds, and resume normal playback.

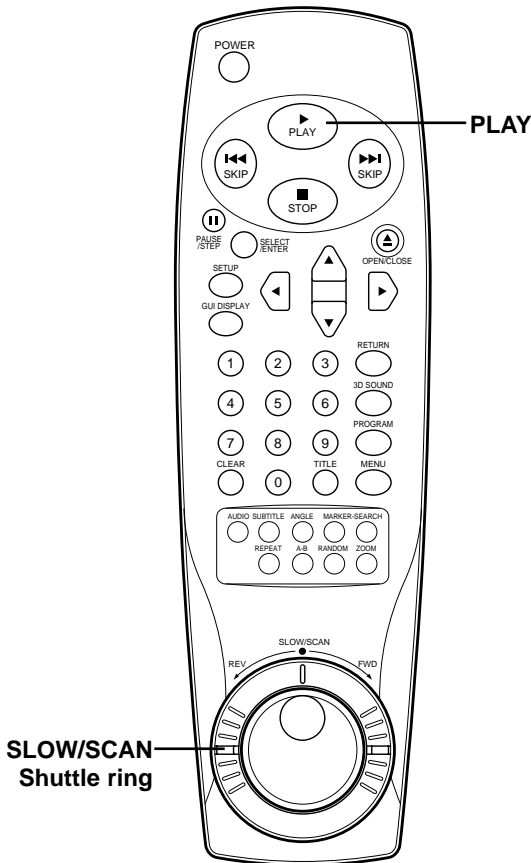

To play in slow-motion

During still picture mode, rotating and holding the SHUTTLE ring to the positions indicated gives those slow modes.

- The variable-speed slow picture will appear on the TV screen.

Release the SHUTTLE ring to resume the still picture mode.

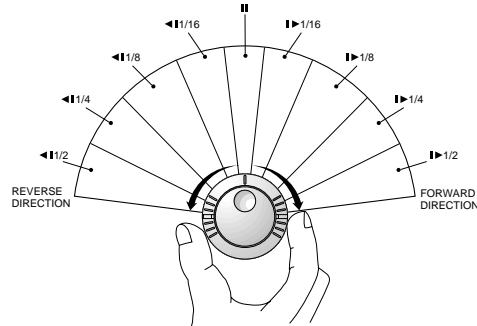

To scan at fast forward or fast reverse.

During playback mode, rotating and holding the SHUTTLE ring to the positions indicated gives those fast search modes.

- The variable-speed search picture will appear on the TV screen.

Release the SHUTTLE ring to resume normal playback.

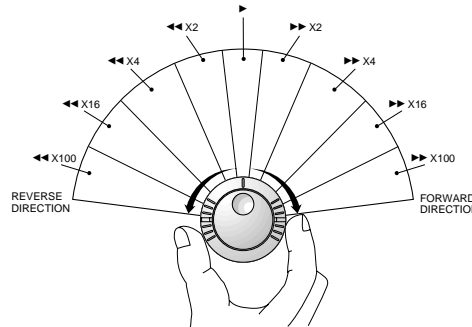

Notes

- The DVD player does not play back sound during slow-motion playback, the high speed reverse and forward playback of DVD video discs. However, the DVD player plays back sound during fast forward or fast reverse playback of audio CDs.
- Subtitles do not appear on the screen during slow motion and scan playback.
- The DVD player provides four (4) scan speeds for DVD movie play. Only two (2) scan speeds are available during Audio CD play.
- The DVD player does not play back in slow-motion in case of audio CD.

General Information about GUI menu icons



This unit features GUI Menu Icons showing disc information (title/chapter/track number, elapsed playing time, audio/subtitle language, angle, and sound) and player information (repeat play, play mode, marker, etc.). Some icons only show the indicated information. Other icons allow the settings to be changed.

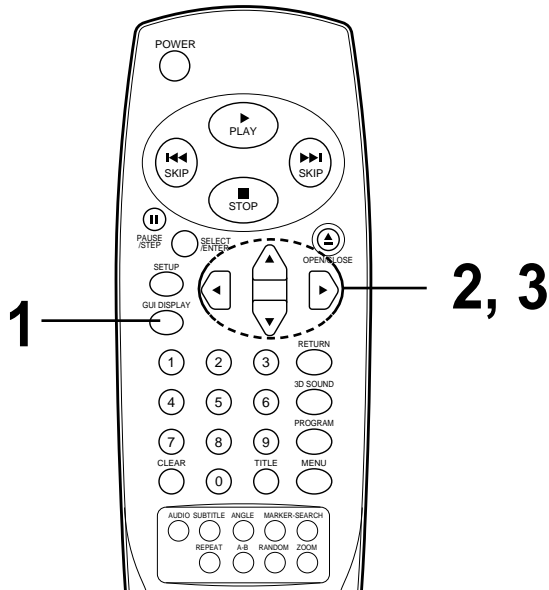

Common procedures

1 Press GUI DISPLAY during playback.

- Title function can be accessed from the stop mode.

2 Press ▲/▼ to select the desired item.

- The current selected item is indicated by a yellow frame on its GUI menu icons.

3 Press ◀▶ to select the desired setting.

- When numbers are displayed (e.g. title No.), the numeric buttons can also be used for setting instead of ◀▶.
- For some functions, the setting will be registered immediately; for others, SELECT/ENTER must be pressed.

To clear the GUI Menu Icons, press GUI DISPLAY.

Examples of GUI Menu Icons.

(The screens may differ depending on the disc contents.)



(DVD GUI)



(CD GUI)



(DVD and CD GUI)

Detailed description of each GUI menu icon



You can view information about a disc and its operational status on the TV screen.

Press GUI DISPLAY during playback.
[TV screen] DVD GUI



FUNCTION (Press ▲/▼ to select desired item)	SELECTION METHOD
To show the current title No. and to jump to the desired title No.	◀▶, or Numeric SELECT/ENTER
To show the current chapter No. and to jump to the desired chapter No.	◀▶, or Numeric SELECT/ENTER SKIP
To show the elapsed time and directly select scenes by the desired time.	Numeric SELECT/ENTER
To show the current audio soundtrack language, encoding method, channel No. and to change the settings.	◀▶, AUDIO
To show the current subtitles language and to change the setting.	◀▶, SUBTITLE
To show the current angle No. and to change the angle.	◀▶, ANGLE
To show the current sound (NORMAL or 3D SURROUND) and to change the setting.	◀▶, 3D SOUND

Press GUI DISPLAY during playback.
[TV screen] CD GUI



FUNCTION (Press ▲/▼ to select desired item)	SELECTION METHOD
To show the current track No. and to jump to the desired track No.	◀▶, or Numeric SELECT/ENTER SKIP
To show the elapsed time. (Display only)	—
To show the current audio (STEREO, LEFT, RIGHT) and to select to the desired audio channel.	◀▶, AUDIO
To show the current sound (NORMAL or 3D SURROUND) and to change the setting.	◀▶, 3D SOUND

Note

- Some DVD discs may not provide all of the above GUI menu icons.

Using a title menu



Some movie discs may contain two or more titles. If the disc has a title menu recorded on it, the TITLE button can be used to select the movie title. (The details of operation differ depending on the disc used.)

- Selecting a title may not be possible on certain DVD discs.

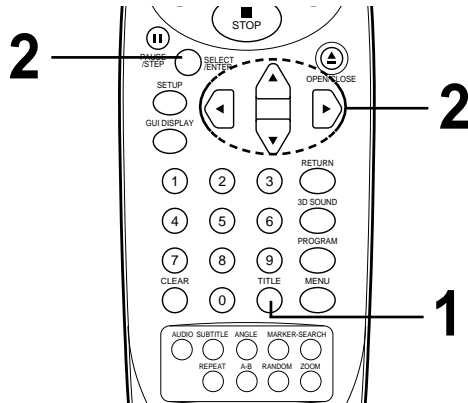

- 1 Press TITLE.**
A list of the titles on the disc is displayed.

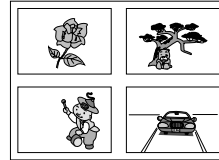

Pressing TITLE again to resume play from the scene when TITLE was first pressed.

- Resume play may not be possible on certain discs.

- 2 Press ▲/▼/◀▶ and press SELECT/ENTER or PLAY, or press the numeric button(s), to select desired title.**

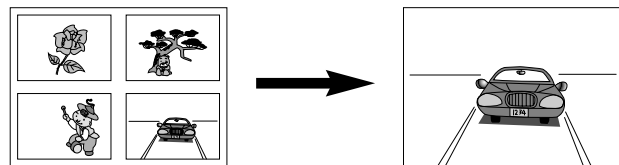

The selected title now starts playing.

Using a DVD menu



Some DVDs have unique menu structures called DVD menus. For example, DVDs programmed with complex contents provide guide menus, and those recorded with various languages provide menus for audio and subtitle language. Although the DVD menu's contents and operation differ from disc to disc, the following explains the basic operation when this feature is used.

- 1 Press MENU during play.**
The DVD menu available on the disc is now displayed.

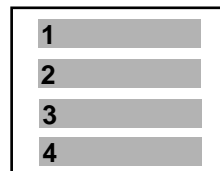

Pressing MENU again resumes play from the scene when MENU was first pressed.

- Resume play may not be possible on certain discs.

- 2 Press ▲/▼/◀▶ and press SELECT/ENTER, or press the numeric button(s), to select desired item.**

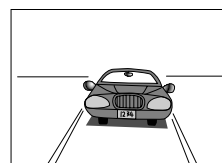

The selected item is now executed.

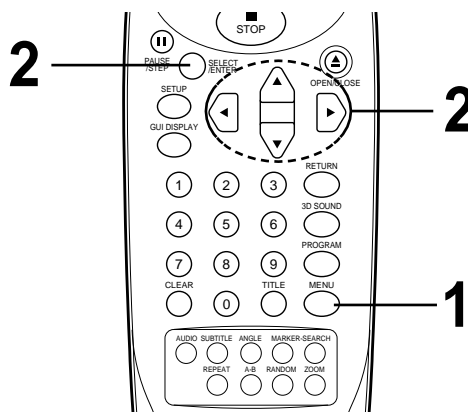

Memorizing Settings for Viewed DVDs (Condition Memory)



This unit stores, in memory, settings for DVDs you have watched. Settings remain in memory even if you remove the disc from the player, or switch power to the player OFF. If you load a disc that has its settings memorized, the "Resume disc from last position?" message will appear on the TV screen. When you start playing the disc, the memorized settings are automatically recalled.

You can memorize details for the following six settings.

- Latest Stop Position (Page 18)**
- TV Aspect (Page 36)**
- Disc Audio Language (Page 24)**
- Disc Subtitle Language (Page 24)**
- Disc Menu Language (Page 33)**
- Angle (Page 25)**

1 Load the DVD that has memorized.

It will appear on the TV screen as below

- If the screen is left for more than 10 seconds, playback will start from the beginning of the title automatically.

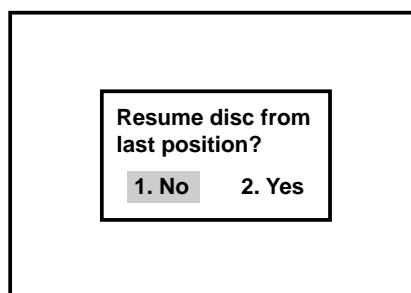
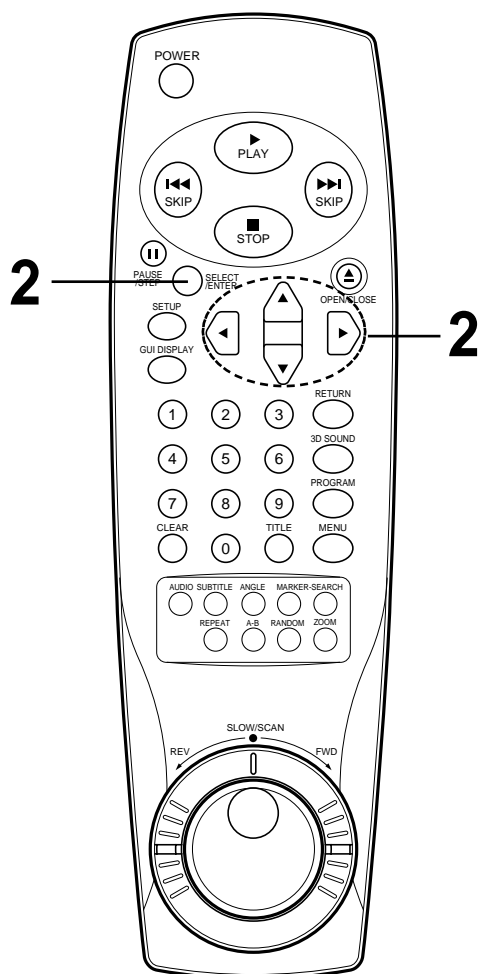

2 Press to select "Yes" and press SELECT/ENTER.

The memorized settings are automatically recalled.

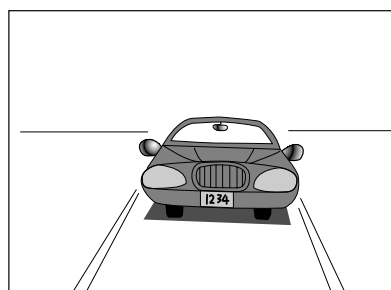

Notes

- Settings are stored in memory for use any time.
- You can store settings for up to 15 DVDs in memory. If you memorize settings for more than 15 DVDs previously memorized settings are erased in order from the least recently memorized settings. Subsequently, if you try to call up these previously memorized settings, you will get the latest settings that have taken their place.
- Switching of the audio mode etc., is automatic on some discs.
- This unit does not store settings in memory, if you remove the disc from the player or switch power to the player OFF when DVD or title menu is displayed on the TV screen.

Changing subtitle language



It is possible to change the subtitle language to a different language from the one selected at the initial settings. (See page 33 for further info.) This operation works only with discs on which multiple subtitle languages are recorded.

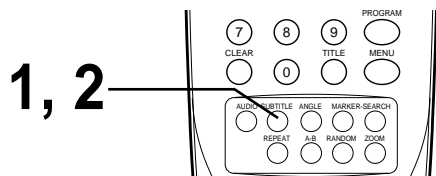

Notes

- In some cases, the subtitle language is not changed to the selected one immediately.
- When a disc supporting the closed caption is played, the subtitle and the closed caption may overlap each other on the TV screen. In this case, turn the subtitle off.
- When the desired language is not selected even after pressing the button several times, it means that the language is not available on the disc.
- When the power is turned on or the disc is removed, subtitles appears in the language selected at the initial settings. If this language is not recorded on the disc, the disc's priority language appears.

- 1 Press SUBTITLE during playback.**
When no subtitles are recorded, "OFF" will be displayed instead of the language number.



- 2 Press repeatedly SUBTITLE until the desired language is selected.**
Number of the subtitle language being played back.



To eliminate the On Screen Subtitles.
Press SUBTITLE repeatedly to select OFF at step 2.

Changing audio soundtrack language



It is possible to change the audio soundtrack language to a different language from the one selected at the initial settings in case of DVD disc. (See page 33 for further info.) This operation works only with discs on which multiple audio soundtrack languages are recorded. And it is possible to change the audio channel in case of audio CD.

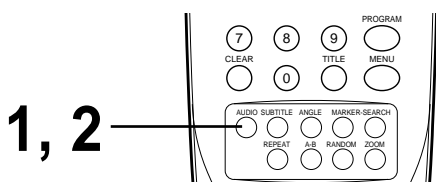

Notes

- When the desired language is not selected even after pressing the button several times, it means that the language is not available on the disc.
- When the power is turned on or the disc is removed, the language heard is the one selected at the initial settings. If this language is not recorded on the disc, only the available language on the disc will be heard.
- Some discs may not respond to Audio feature.

- DVD
- 1 Press AUDIO during play.**
Number of the audio soundtrack language being played back.



- 2 Press AUDIO repeatedly until the desired language is selected.**



- CD
- 1 Press AUDIO during play.**



- 2 Press AUDIO repeatedly until the desired sound is selected.**



Viewing from another angle



Some DVDs may contain scenes which have been shot simultaneously from a number of different angles. For these discs, the same scene can be viewed from each of these different angles using the ANGLE button. (The recorded angles differ depending on the disc used.)

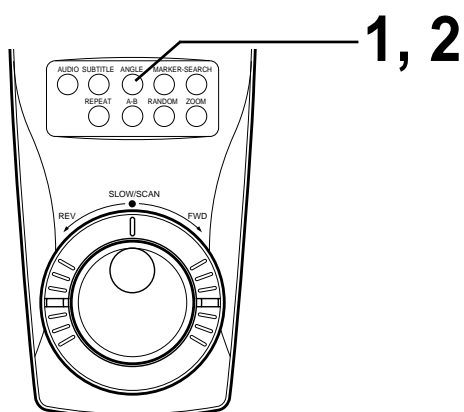
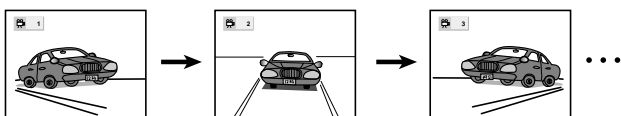

1 Press ANGLE during playback.

Number of angle being played back.



2 Press ANGLE repeatedly until the desired angle is selected.



For your reference

- The ANGLE indicator will blink in the DVD display window at scenes recorded at different angles to indicate that angle switching is possible.
- The angle number can be programmed beforehand; the angle will be switched to the selected number when the ANGLE indicator blinks.

Note

- This function only works for discs having scenes recorded at different angles.

Producing a 3D SURROUND effect



This unit can produce a 3D Surround effect, using Spatializer™ N-2-2™ technology, which simulates multi-channel audio playback from two conventional stereo speakers instead of the five or more speakers normally required to listen to multi-channel audio from a home theatre. This feature works with DVD discs encoded with Dolby Pro Logic, Dolby Digital and DTS multi-channel audio tracks.

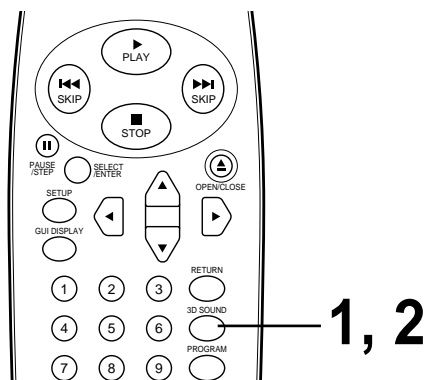

1 Press 3D SOUND during playback.

Each time this button is pressed, the TV screen display changes:



2 Press 3D SOUND repeatedly until the desired sound is selected.



Notes

- This 3D Surround effect may not be available on some DVD discs, such as those recorded with a mono audio soundtrack.
- Turn off the TV surround sound and other surround effects when using this 3D surround effect.
- For best 3D Surround effect using only two speakers it is recommended that the two speakers be positioned approximately 2m to 2.5m apart, and the listening position should be 2m to 2.5m away from the speakers.

Repeat Play



Repeating viewing (listening)

Press REPEAT during playback.

Each time this button is pressed, the TV screen changes as shown below and the disc will repeat a chapter or title (DVD) or a track (CD).

• DVD

Repeat of chapter being played

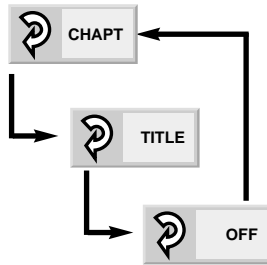

Repeat of title being played

Cancel repeat mode (normal play)

• CD

Repeat of track being played

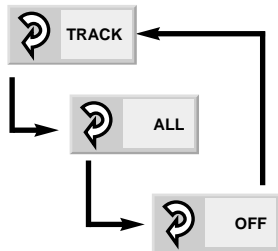

Repeat of entire disc contents

Cancel repeat mode (normal play)

To enjoy program repeat play (CD)

If REPEAT is pressed during program play, repeat play is operated as below.

Repeat of the current programmed track

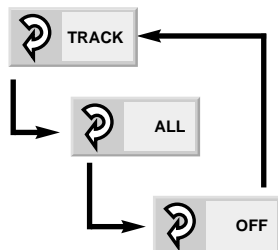

Repeat of all programs

Cancel repeat mode (Program play)

To return to normal play

Press REPEAT several times until "OFF" is displayed.

Repeating sections between two specific points (A-B repeat)

1 Press A-B during play at the point where repeat play is to start (A).



- You can select "OFF" at this step by pressing CLEAR.

2 Press A-B during play at the point where repeat play is to be concluded (B).



Repeat play of the selection between points A and B starts.

To return to normal play

Press A-B once "OFF" is displayed.



Notes

- Repeat play works only with discs for which the elapsed playing time appears in the DVD display window during playback.
- Repeat play may not work correctly with some DVDs.
- A-B repeat play works only within a title DVD or a track CD.
- Some subtitles recorded around point A or B may fail to appear (DVD).

Storing markers in memory to be viewed (listened to) again



Storing a MARKER in the DVD memory is similar to marking your page in a book. It allows you to quickly return to any point on the disc.

Storing a marker in the memory

- 1 Press **MARKER** during play at the starting point to be viewed (listened to) again.



Indicates "1/5" is stored in the memory. Up to 5 markers can be stored in the memory.

Recalling/Clearing a marker

- 2 Press **SEARCH** during playback.

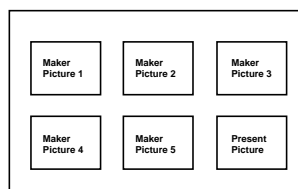

- 3 Press **▲/▼/◀/▶** to select the marker to be recalled/cleared.

- 4 Press **PLAY** or **SELECT/ENTER** to recall a marker. or Press **CLEAR** to clear a marker.

Play resumes from the point corresponding to the selected marker, or the selected marker is cleared.

- The "Present Picture" is not cleared.

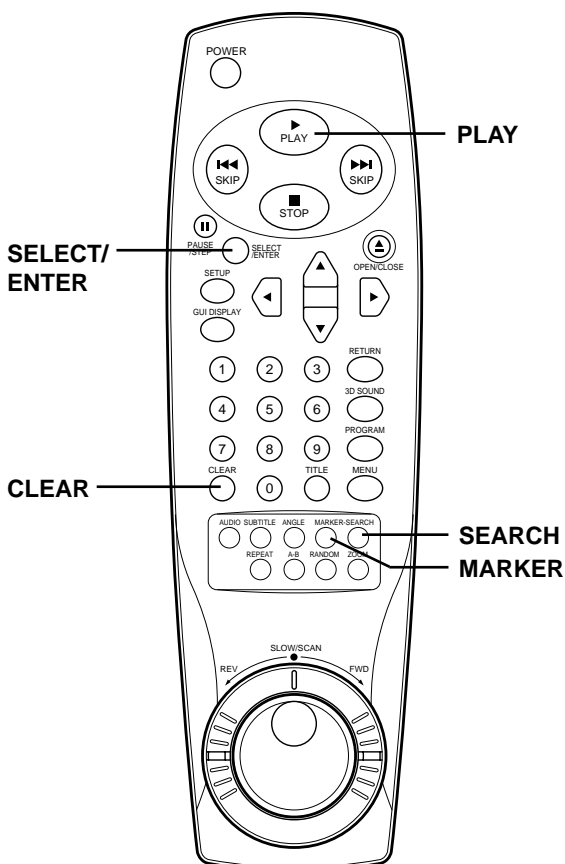

Notes

- These operations work only with discs for which the elapsed playing time appears in the DVD display window during playback or stop.
- Some subtitles recorded around the marker may fail to appear (DVD).
- All the markers are cleared when the power is turned off or the disc is removed and when TV Aspect mode is changed at the SETUP menu.
- The marker is not stored when the DVD or title menu is displayed on the TV screen.

Zoom feature



The Zoom feature allows you to “ZOOM-IN” and enlarge the picture on the screen to either 4 times (X4) or 16 times (X16) its normal size.

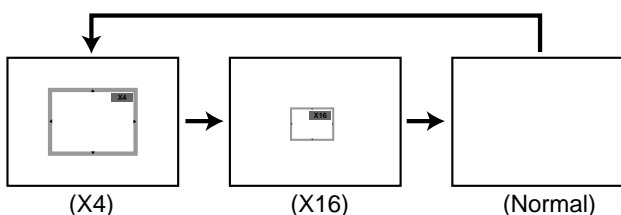
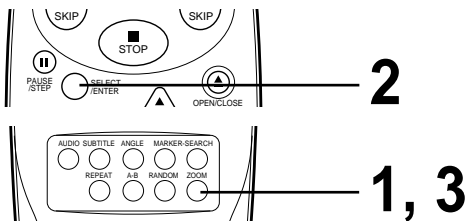

1 Press ZOOM during normal playback or still playback.

- The square frame will be displayed in the centre of the picture. If no button is pressed for more than 10 seconds, the square frame will disappear.
- Each press of the ZOOM button changes the TV screen in the left sequence.
- The magnification level will be displayed in the upper right corner of the zoom area.

If you press ▲/▼/◀▶ buttons the zoom point shifts.

2 Press SELECT/ENTER.

The selected frame is displayed in full size on the TV screen.

3 To resume normal playback

Press ZOOM again to cancel Zoom feature and resume normal playback or still playback.

Notes

- Some discs may not respond to the Zoom feature.
- Zoom does not work on subtitles or menus included on DVD video discs.

Random play



Note: This function only works with karaoke DVD and with audio CD discs. Random does not work with DVD movies.

You can playback titles, or tracks in random order. (Random playback)

The DVD player automatically selects the titles in a DVD video karaoke disc only and plays them back randomly.

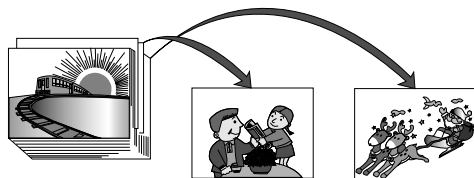
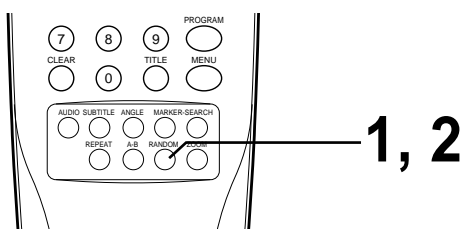

Notes

- Random playback may not be possible on certain discs.
- If you press the SKIP ►► button during random playback, the DVD player goes to another track randomly and starts playback.

Random play (DVD)

1 Press RANDOM during stop.

The DVD player starts random playback.

- If you press the RANDOM during normal playback, the DVD player will randomly select another title and begin random playback immediately.

2 To resume normal playback, press RANDOM.

The RANDOM indicator in the DVD display window disappears.

Random play (CD)

The player plays the tracks on the disc in random order.

1 Press RANDOM during stop.

The random playback screen appears on the TV screen.

- If you press the RANDOM button during normal playback, the DVD player immediately selects another track and begins random playback.

2 To resume normal playback, press RANDOM during random playback.

The RANDOM indicator in the DVD display window disappears.



Program play

The player plays the tracks on the disc in an order you specify.

Note: Program play function is possible only with audio CDs. It does not work with DVD movie discs.

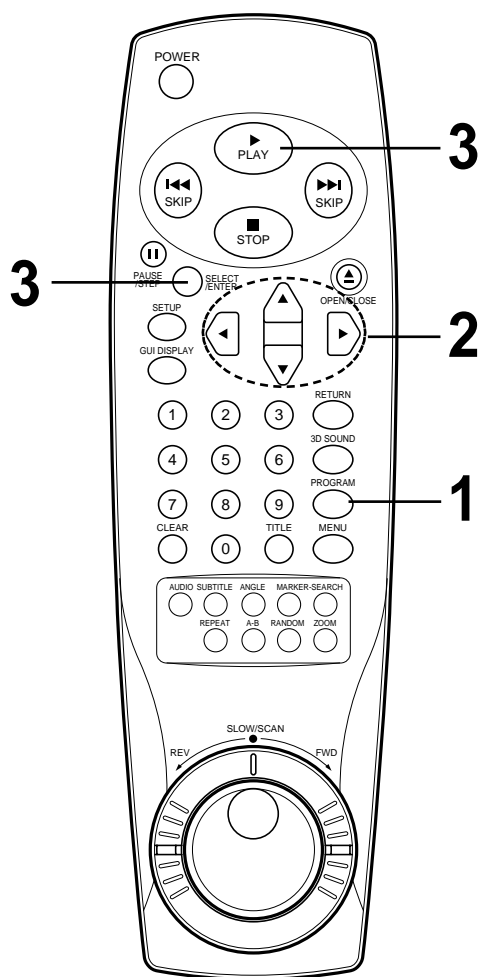

1 Press PROGRAM during playback or stop mode.

The program playback screen appears on the TV screen.

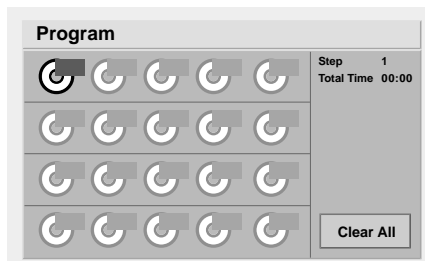

- To exit the screen, press PLAY or PROGRAM.

2 Press ▲/▼/◀▶ and press the numeric button(s), to select the desired track number.

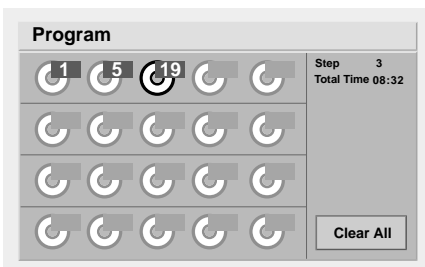

- Repeat step 2 to select another track.
- Up to 20 tracks can be programmed.

3 Press PLAY or SELECT/ENTER to exit the screen.

The selected track is stored in the memory and play now begins in the programmed sequence.

- If you press PROGRAM to exit the screen, the selected tracks are not memorized.

After playback of all tracks programmed

Play is stopped.

Clearing the program

• To clear the program one by one

Press ▲/▼/◀▶ to select the unwanted No. and then press CLEAR.

• To clear all the programs

Press ▲/▼/◀▶ to select the "Clear All" and press SELECT/ENTER. Press PLAY or SELECT/ENTER to exit the screen. If you press PROGRAM to exit the screen, the programs are not cleared. (The programs are also cleared when the power is turned off or the disc is removed.)

Playback with MP3

To play an MP3 file

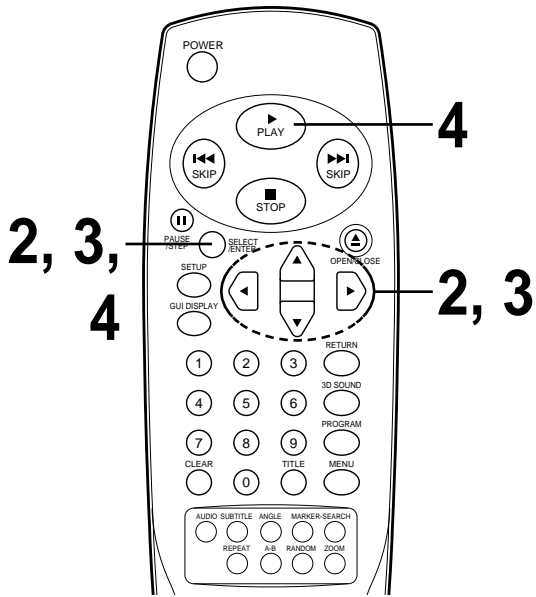

- 1 Load an MP3 disc.**
The MP3 menu is displayed.

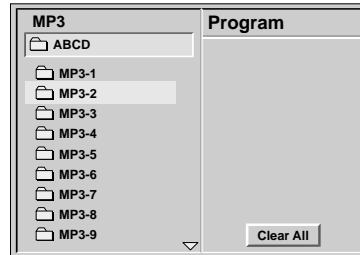

- 2 Press ▲/▼ buttons to select the directory where MP3 files that you want to play are located and then press SELECT/ENTER.**

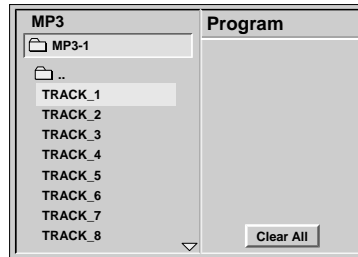

- 3 Press ▲/▼ button to select the desired MP3 file of the selected directory on your disc.**

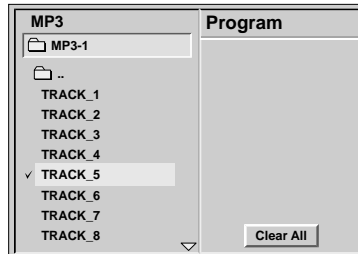

If you want to return to the previous menu, press RETURN button.

- 4 Press SELECT/ENTER or PLAY to start playback of a file.**

To play an MP3 file repeatedly

- If you press REPEAT button once during play, the current MP3 file will play repeatedly.
- If you press REPEAT button twice during play, the directory will play repeatedly.
- If you press REPEAT button three times, the repeat play will be cancelled.

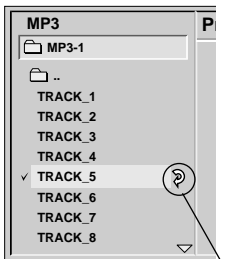
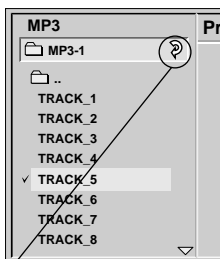
REPEAT symbol

Notes

- The directory and file name is only to display with English.
- If there is an impossible code to display, it will be displayed under lined () instead of English.
- If a directory has no MP3 file, the " ? " is displayed with the directory name.
- If you select another file by pressing ▲/▼ during playback, the file is played after 5 seconds automatically.
- If you select a directory by pressing ▲/▼ during playback, the playback is stopped after 5 seconds.

For your reference

- Press SKIP ►► or SKIP ◀◀ to play the next file or previous file during playback.
- Press TITLE to move to 1'st page of current directory during playback and press TITLE again to move to the next page within 5 seconds.
- Press MENU to move to the Root Directory during playback.

Playback with MP3

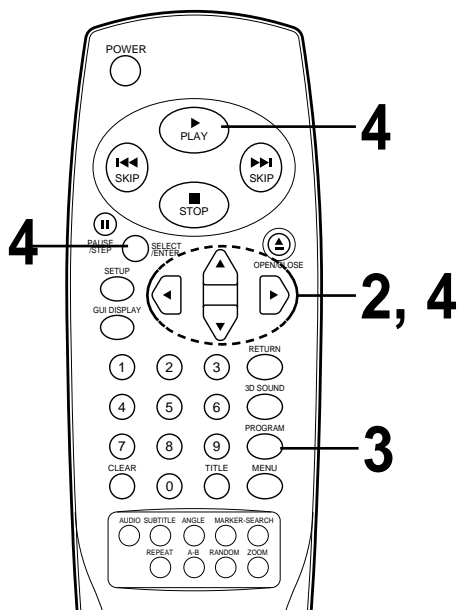

To program play an MP3 file

- 1 Follow steps 1 to 2 on previous page.
- 2 Select an MP3 file to program with ▲/▼.

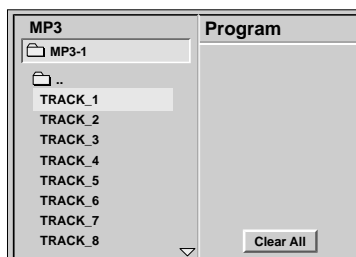

- 3 Press PROGRAM button to add an MP3 file on the program list.

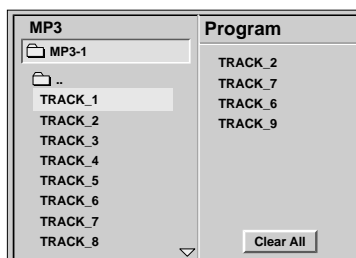

- Repeat steps 2 - 3 to select another track.
- Up to 60 files can be programmed.

- 4 Press ► button and select the desired MP3 file and press SELECT/ENTER or PLAY button to play.

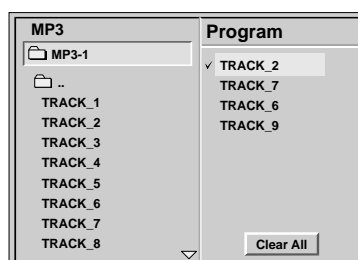

To play an MP3 file repeatedly

- If you press REPEAT button once during play, the current MP3 file will play repeatedly.
- If you press REPEAT button twice during play, the all MP3 files on the program list will play repeatedly.
- If you press REPEAT button three times, the repeat play will be cancelled.

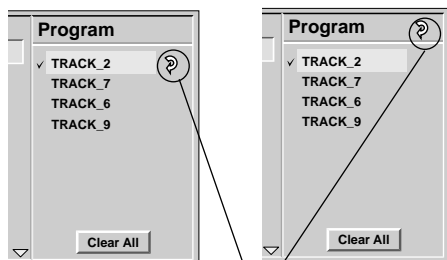

REPEAT symbol

Clearing the program

• To clear the program one by one

Press ▲/▼/◀/▶ to select the unwanted MP3 file on the program list and then press CLEAR.

• To clear all the programs

Press ▲/▼/◀/▶ to select the "Clear All" and press SELECT/ENTER.

If you want to enter the main menu, press ◀ button.

After playback all tracks programmed

Play is stopped.

Common procedures of initial settings



Once the initial settings have been completed, the player can always be operated under the same conditions (especially with DVD discs). The settings will be retained in the memory until they are changed, even if the power is switched off.

Common procedures of initial settings

1 Press SETUP in the stop or playback mode.
The SETUP menu is displayed.

Disc Audio	✓Original
Disc Subtitle	English
Disc Menu	French
Rating	German
Password	Spanish
TV Aspect	Italian
Menu Language	Chinese
TV Output Select	Polish
Pseudo PAL	Hungarian
Digital Audio Output	Russian
5.1 Speaker Setup	Other - - - -

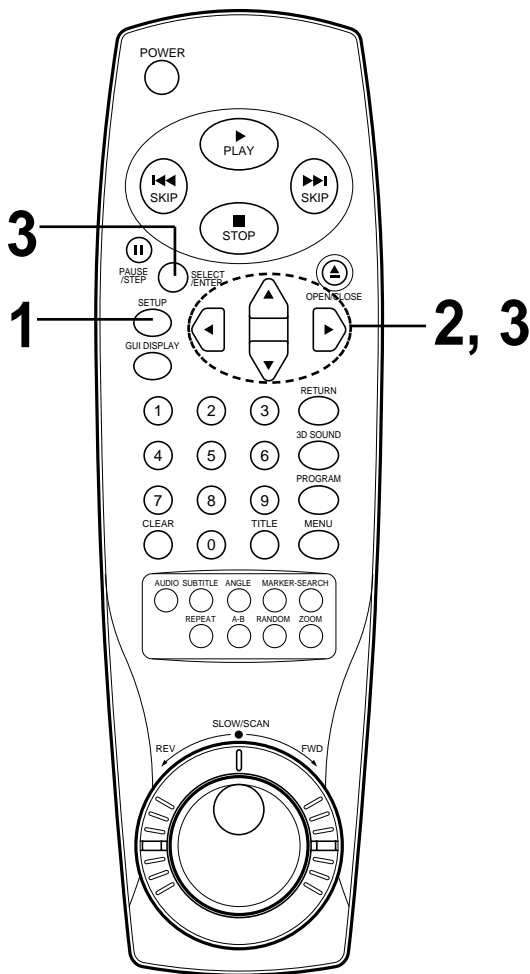

2 Press ▲/▼ to select the desired item.
The screen will show the current setting for the selected item, and the alternate setting(s).

- Disc Audio (see page 33)
- Disc Subtitle (see page 33)
- Disc Menu (see page 33)
- Rating (see page 34)
- Password (see page 35)
- TV Aspect (see page 36)
- Menu Language (see page 37)
- TV Output Select (see page 37)
- Pseudo PAL (see page 38)
- Digital Audio Output (see page 39)
- 5.1 Speaker Setup (see page 40)

3 Press ► and then ▲/▼ to select the desired setting and press SELECT/ENTER.
• Some items require additional steps. (See the respective page.)

When the alternate setting is selected the screen returns to the Initial Settings display.

To exit SETUP menu
Press SETUP, RETURN or PLAY.

Selecting disc languages



This is to select the audio soundtrack language, subtitle language and the language used in title menus or DVD menus which will always be used for every disc to be played back.

When you play back a DVD video disc, the DVD player automatically displays the pre-selected subtitle language if it is included on the disc.

1 At the setup screen, press ▲/▼ to select “Disc Audio” and press ►.



2 Press ▲/▼ to select the desired language and then press SELECT/ENTER.

Original :The original language of each disc will be selected.
English : The English will be Selected.
Other : Another language can be selected. You can input 4-digit language code. (Refer to the language codes on page 41. Press CLEAR if an incorrect language code is entered.)

The “Disc Subtitle” and “Disc Menu” are selected by the same method.

Note

- If the language selected is not available on the disc, the original language designated by each disc will be selected.

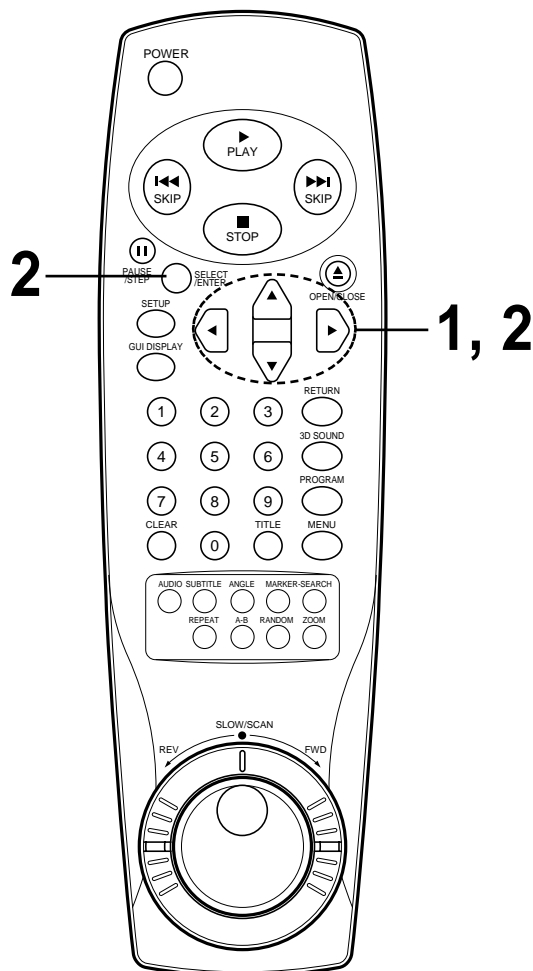

Selecting rating level and password DVD

This is to prohibit the playing of specified DVDs which are unsuitable for children.

- Some DVD discs contain a restriction level which enables parents to remove scenes or prevent playback of discs by children. DVD players are equipped with a password designed to prevent children changing the level.

Selecting rating level (DVD only)

1 At the SETUP screen, press ▲/▼ to select "Rating" and press ►.

Disc Audio	8
Disc Subtitle	7
Disc Menu	6
Rating	5
Password	4
TV Aspect	3
Menu Language	2
TV Output Select	1
Pseudo PAL	►Unlock
Digital Audio Output	
5.1 Speaker Setup	

2 Press ▲/▼ to select the desired level and press SELECT/ENTER.

Disc Audio	8 Blocked
Disc Subtitle	7 Blocked
Disc Menu	√6
Rating	5
Password	4
TV Aspect	3
Menu Language	2
TV Output Select	1
Pseudo PAL	Unlock
Digital Audio Output	
5.1 Speaker Setup	

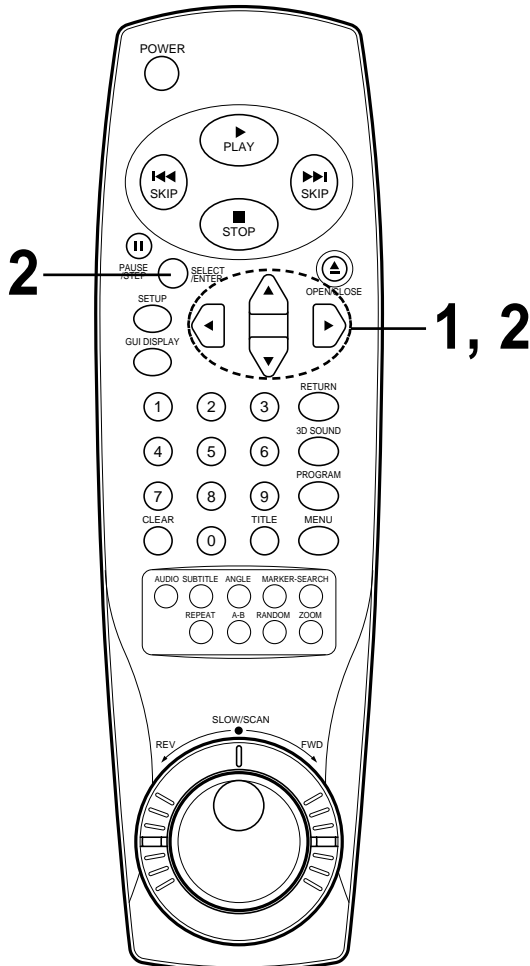

You cannot play DVD video discs rated higher than the level you selected unless you cancel the parental lock function. For example, when you select level 7, discs rated higher than level 7 are blocked and cannot be played.

If you change the level and enter a password, playback of all DVDs with ratings higher than your selection will be blocked, unless the correct password is entered again. For example: if you change the level to "5", the DVD player will not play discs with ratings of "6", "7" or "8" unless the correct password is entered on the remote control.

Selecting rating level and password

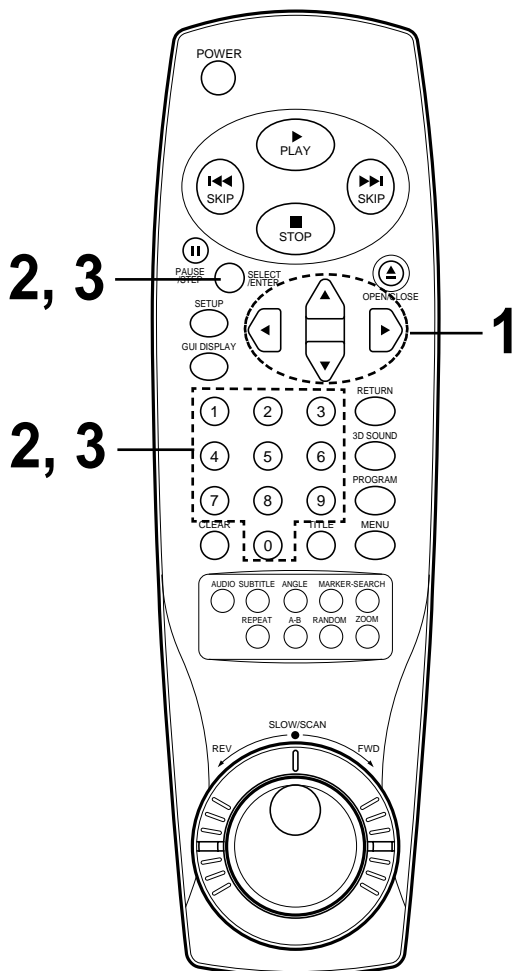

Setting your password (DVD only)

If you change the rating level to "7" or lower, you must enter a 4-digit "password" to prevent playback of discs with higher ratings.

- 1** At the **SETUP** screen, press **▼** to select "Password" and press **▶**.



- 2** Input a 4-digit password and press **SELECT/ENTER**.

Example : 1234

Do not forget your password.

- 3** Input the 4-digit password again and press **SELECT/ENTER** to verify.

Setting is finished.

- The rating is locked. Any discs whose rating is higher than the setting cannot be played back unless the correct password is entered.

To change/clear memorized password

- 1** At the **SETUP** screen, press **▼** to select "Password" and press **▶**.

- 2** Input your password and Press **SELECT/ENTER**.

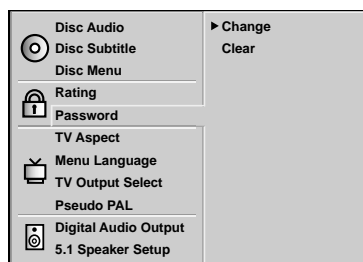

- 3** To change or clear your password, press **▲/▼** to select the "Change" or "Clear" and press **SELECT/ENTER**.

To change the rating level/password, follow the steps on page 34-35 again.

To clear your 4-digit password

If you forget your password, to clear the current password, follow the procedure below.

At the **SETUP** screen

- 1** Press **▼** to select "Password" item.
- 2** Enter 6-digit number "210499" and then press **SELECT/ENTER**.
The 4-digit password is cleared.
- 3** Enter a new password
Refer to "Setting your password" section on the right.

Selecting TV Aspect



Select the appropriate screen type according to your TV set; conventional size screen (4:3) or wide-screen (16:9).

1 At the **SETUP** screen, press **▲/▼** to select “**TV Aspect**” and press **▶**.

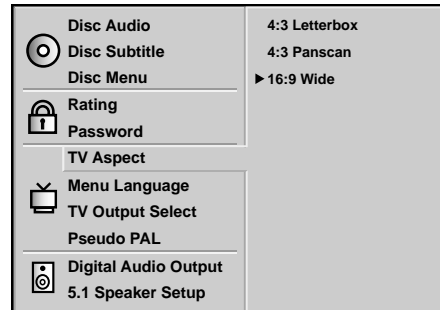
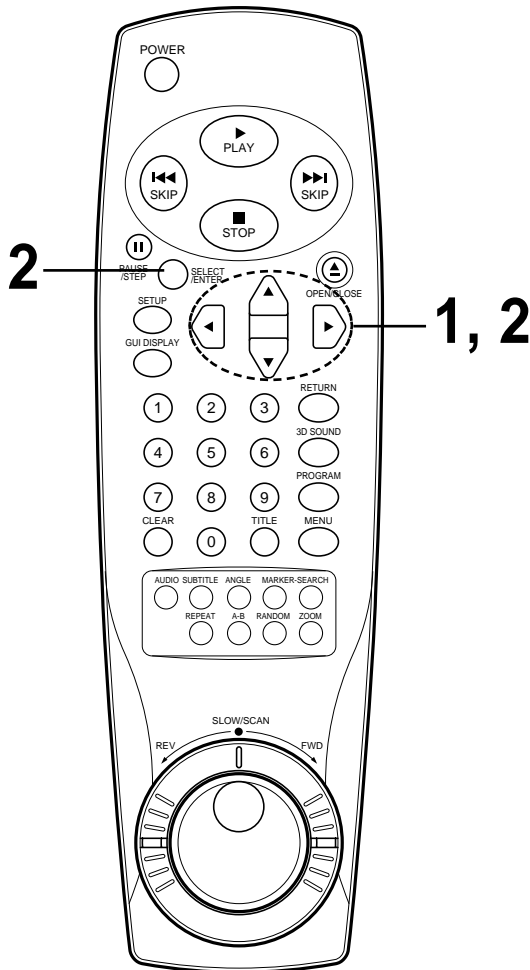

2 Press **▲/▼** to select the desired Aspect and press **SELECT/ENTER**.

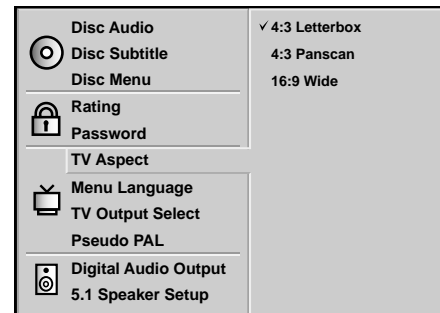

4:3 Letterbox : The video material not formatted in the Pan & Scan style is played back in the letterbox style (black bands appear at top and bottom of screen).

4:3 Panscan : Select when a conventional TV set is connected. The video material formatted in the Pan & Scan style is played back in that style (the left and right edges are cut off).

16:9 Wide : Select when a wide-screen TV set is connected. Played in “FULL” size. (Setting the wide-screen TV to “FULL” mode is also necessary.)

* Each screen shows an example when the video material for a wide-screen is played. (This setting does not affect the video material for conventional size.)



4:3 Letterbox

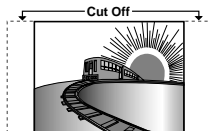

4:3 Panscan

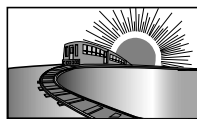

16:9 Wide

Selecting Menu Language



Selects language for DVD menus and displays on the TV.

- 1 At the SETUP screen, press ▲/▼ to select “Menu Language” and press ►.

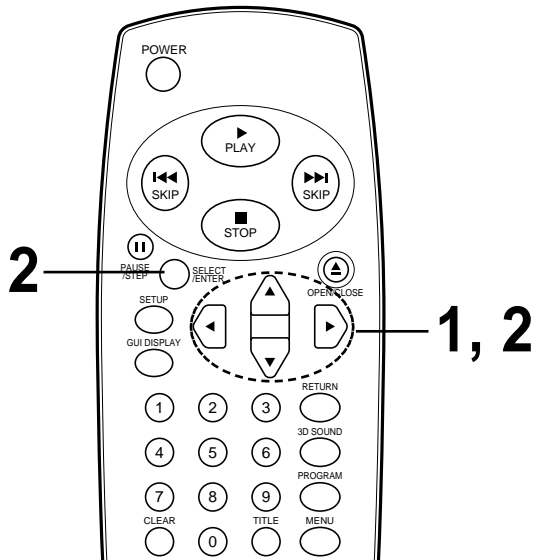

- 2 Press ▲/▼ to select the desired Language and press SELECT/ENTER.



Selecting TV Output



It can be used to select the video output between S-VIDEO OUT and SCART's RGB signal (component).

- 1 At the SETUP screen, press ▲/▼ to select “TV Output Select” and press ►.

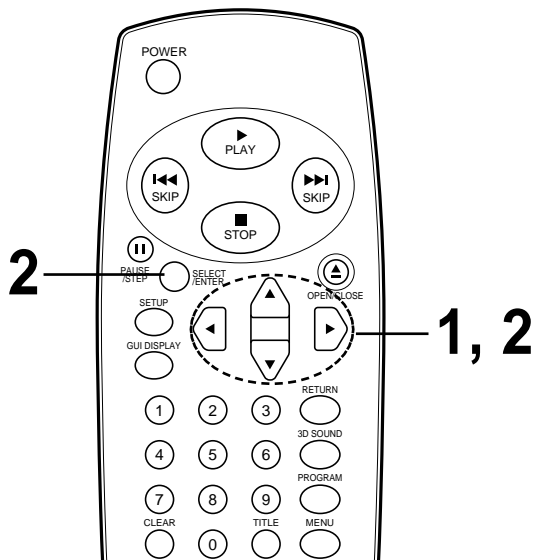

- 2 Press ▲/▼ to select the desired TV Output and press SELECT/ENTER.



Selecting Pseudo PAL



Depending on a disc, you can play a NTSC DVD disc by Pseudo PAL ON mode.

1 At the SETUP screen, press ▲/▼ to select “Pseudo PAL” and press ►.

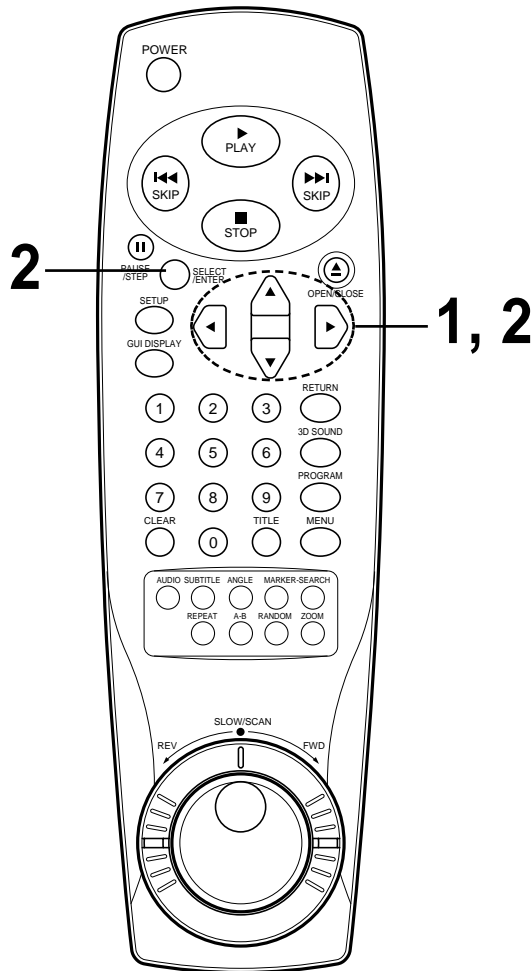

2 Press ▲/▼ to select the desired mode and press SELECT/ENTER.



Notes

- The Pseudo PAL can be displayed when the SYSTEM selector on the rear panel is switched to PAL mode.
- If there are some problems during playback of a NTSC disc, select the “Pseudo PAL” to “On” mode.
- The picture can be streamed according to TV type when the “Pseudo PAL” is “On” mode.

Selecting Digital Audio Output



Each DVD disc has a variety of audio output options. Set the player's Digital Audio Output according to the type of audio system you use.

1 At the **SETUP** screen, press **▲/▼** to select **Digital Audio Output** and press **▶**.

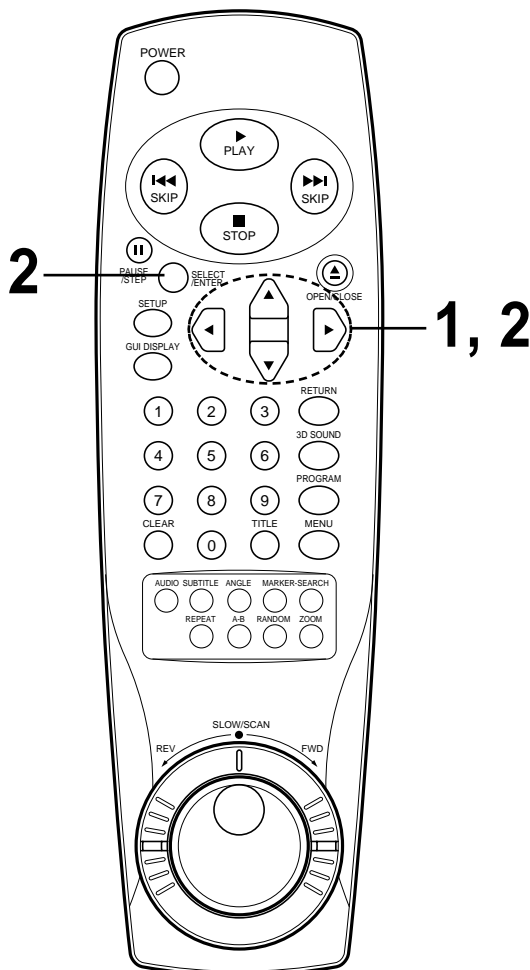
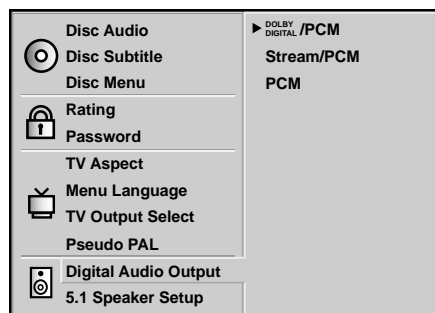

2 Press **▲/▼** to select the desired output and press **SELECT/ENTER**.

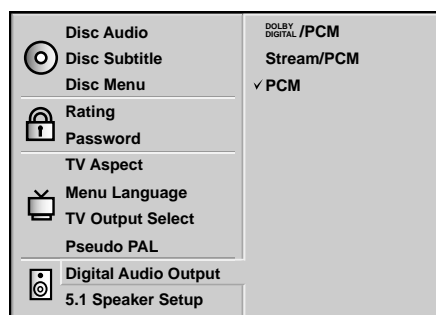

DOLBY DIGITAL/PCM: Select “DOLBY DIGITAL/PCM” if an active digital output is supplied to a Dolby Digital decoder, (or an amplifier or other equipment with Dolby Digital decoder).

Stream/PCM: Select “Stream/PCM” if an active digital output is supplied to an amplifier or other equipment with DTS decoder, Dolby Digital decoder and MPEG decoder.

PCM: Select “PCM” if an active digital output is supplied to an amplifier or other equipment with linear PCM only (or MD recorder or DAT deck).

Playback Disc	OUTPUT		
	Stream/PCM	Dolby Digital/PCM	PCM only
96 kHz Linear PCM DVD	PCM	PCM	PCM
DTS DVD	DTS bit Stream	Not Output	Not Output
Dolby Digital DVD	Dolby Digital bit Stream	Dolby Digital bit Stream	PCM
MPEG DVD	MPEG bit Stream	PCM	PCM
Audio CD	PCM	PCM	PCM
DTS Audio CD	DTS bit Stream	DTS bit Stream	DTS bit Stream

Notes

- When you are not using the player's digital audio output, don't select any of the options.
- If an active digital audio output signal is supplied to a receiver or other equipment without a corresponding digital decoding capability, a very loud noise may be produced which could permanently damage the speakers.
- The DTS DVD disc sound is played back only when the DVD player is connected to a receiver with a DTS decoder.

Selecting Speaker DVD VIDEO

Select the speaker to adjust the audio output mode of the speaker.

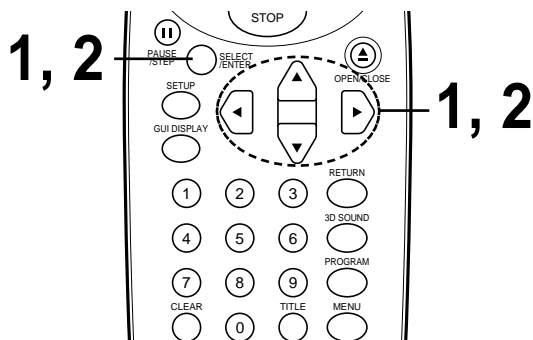

1 At the **SETUP** screen, press ▲/▼ to select “5.1 Speaker Setup” and press ►.

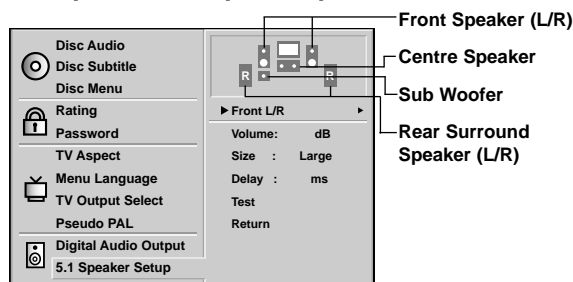

2 Press ◀/▶ to select the desired speaker and press ▲/▼/◀/▶ to adjust options.



Note

- Do not place the centre or rear speakers farther away from the listening position than the front speakers.
- The test tone does not output from the subwoofer.

Volume: Press ◀/▶ to adjust the output level of selected speaker. (-6dB ~ 0dB)

Size: Press ◀/▶ to set a mode. (Large, Small, None)

- If you have connected the system to a speaker with low frequency of 100Hz or below, select “Large”
- If you have connected the system to a speaker without low frequency of 100Hz or below, select “Small” But if you haven’t connected to sub woofer, always select “Large” of Front Speaker (L/R).
- When you don’t connect to speaker, select “None”.
- Front L/R speaker’s size can be selected to Large” or “Small”.
- If Front L/R speaker’s size is selected to “Small”, Rear and Centre speaker’s size can be selected to “Small” or “None”, and Sub woofer speaker’s size can be selected only to “Large”.

Delay: Press ◀/▶ to customize the sound to conform to the acoustics of your room by adding a delay effect to the sound of the Centre Speaker and Surround Speaker.

- When 5.1CH Surround is played, you can enjoy the best sound if the distance between you and each speaker is same. You can set Delay time in the Centre/Surround Speaker to customize the sound to to the acoustic of your room.

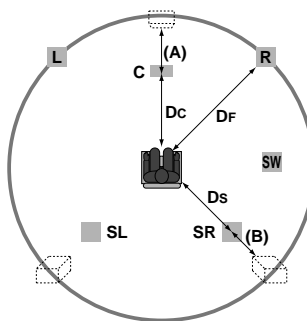

Setting Centre Speaker
If the distance of Dc is equal to or longer than the Df in the left figure, set the mode as 0ms. Otherwise, change the setting according to the table below.

(A) = $Df - Dc$

Distance of (A)(cm)	Setting(ms)
34	1
68	2
102	3
136	4
170	5

Setting Rear Surround Speaker

If the distance of Df is equal to the distance of Ds in the above, set the mode as 0ms. Otherwise, change the setting according to the table below.

(B) = $Df - Ds$

Distance of (B)(cm)	Setting(ms)
170	5
340	10
510	15

Test : Press SELECT/ENTER to test signals of each speaker. Adjust Volume to match to the volume of test signals memorized in the system.

- Front (L) → Front (R) → Centre → Rear (L) → Rear (R)

Return: Press SELECT/ENTER to return to the previous menu screen.

Table of Language and Their Abbreviations





Enter the appropriate code number for the initial settings "Audio", "Subtitle" and/or "Menu" (See page 33).

Code	Language	Code	Language	Code	Language	Code	Language
6565	Afar	7079	Faroese	7678	Lingala	8375	Slovak
6566	Abkhazian	7082	French	7679	Laothian	8376	Slovenian
6570	Afrikaans	7089	Frisian	7684	Lithuanian	8377	Samoa
6577	Ameharic	7165	Irish	7686	Latvian, Lettish	8378	Shona
6582	Arabic	7168	Scots Gaelic	7771	Malagasy	8379	Somali
6583	Assamese	7176	Galician	7773	Maori	8381	Albanian
6588	Aymara	7178	Guarani	7775	Macedonian	8382	Serbian
6590	Azerbaijani	7185	Gujarati	7776	Malayalam	8385	Sundanese
6665	Bashkir	7265	Hausa	7778	Mongolian	8386	Swedish
6669	Byelorussian	7273	Hindi	7779	Moldavian	8387	Swahili
6671	Bulgarian	7282	Croatian	7782	Marathi	8465	Tamil
6672	Bihari	7285	Hungarian	7783	Malay	8469	Telugu
6678	Bengali; Bangla	7289	Armenian	7784	Maltese	8471	Tajik
6679	Tibetan	7365	Interlingua	7789	Burmese	8472	Thai
6682	Breton	7378	Indonesian	7865	Nauru	8473	Tigrinya
6765	Catalan	7383	Icelandic	7869	Nepali	8475	Turkmen
6779	Corsican	7384	Italian	7876	Dutch	8476	Tagalog
6783	Czech	7387	Hebrew	7879	Norwegian	8479	Tonga
6789	Welsh	7465	Japanese	7982	Oriya	8482	Turkish
6865	Danish	7473	Yiddish	8065	Panjabi	8484	Tatar
6869	German	7487	Javanese	8076	Polish	8487	Twi
6890	Bhutani	7565	Georgian	8083	Pashto, Pushto	8575	Ukrainian
6976	Greek	7575	Kazakh	8084	Portuguese	8582	Urdu
6978	English	7576	Greenlandic	8185	Quechua	8590	Uzbek
6979	Esperanto	7577	Cambodian	8277	Rhaeto-Romance	8673	Vietnamese
6983	Spanish	7578	Kannada	8279	Rumanian	8679	Volapük
6984	Estonian	7579	Korean	8285	Russian	8779	Wolof
6985	Basque	7583	Kashmiri	8365	Sanskrit	8872	Xhosa
7065	Persian	7585	Kurdish	8368	Sindhi	8979	Yoruba
7073	Finnish	7589	Kirghiz	8372	Serbo-Croatian	9072	Chinese
7074	Fiji	7665	Latin	8373	Singhalese	9085	Zulu

Disc Requirements/Copyright Information

Playable Discs

This DVD player can play back the following discs.

	Disc mark	Contents	Disc size	Maximum playback time
DVD video discs		Audio+Video (moving pictures)	12 cm	Approx. 4 hours (single sided disc)
				Approx. 8 hours (double sided disc)
			8 cm	Approx. 80 minutes (single sided disc)
				Approx. 160 minutes (double sided disc)
Audio CDs		Audio	12 cm	74 minutes
			8 cm	20 minutes

You can play back CD-R and CD-RW disc also. You cannot playback discs other than those listed above. (Video CD, CD-ROM, CD-Extra, CD-G, photo CD, and CD-i discs can not be played on this DVD player.)

“Certain audio features of this product manufactured under a license from Desper Products, Inc., Spatializer® 3-D Stereo, Spatializer N-2-2 (TM) and the circle-in-square device are trademarks owned by Desper Products, Inc.,”

Region Management Information

Region Management Information: This DVD Player is designed and manufactured to respond to the Region Management Information that is recorded on a DVD disc. If the Region number described on the DVD disc does not correspond to the Region number of this DVD player, this DVD player cannot play that disc.

The Region number of this DVD player is 2.



Notes on Unauthorized Discs

You may not be able to play back some DVD video discs on this player if they were purchased from outside your geographic area or made for business purposes. When you try to play back an unauthorized disc, “**Check Regional Code**” appears on the TV screen.

Notes on Copyright

It is forbidden by law to copy, broadcast, show, broadcast on cable, play in public, and rent copyrighted material without permission. DVD video discs are copy protected, and any recordings made from these discs will be distorted. This product incorporates copyright protection technology that is protected by method claims of certain U.S. patents and other intellectual property rights owned by Macrovision Corporation and other rights owners. Use of this copyright protection technology must be authorized by Macrovision Corporation, and is intended for home and other limited viewing uses only, unless otherwise authorized by Macrovision Corporation. Reverse engineering or disassembly is prohibited.

Before Calling Service Personnel

Symptoms and Correction

Check the following guide for the possible cause of a problem before contacting service.

Symptom	Cause	Correction
No power.	<ul style="list-style-type: none"> The power cord is disconnected. 	<ul style="list-style-type: none"> Plug the power cord into the wall outlet securely.
The power is on, but the DVD player does not work.	<ul style="list-style-type: none"> No disc is inserted. 	<ul style="list-style-type: none"> Insert a disc. (Check that the DVD or, audio CD indicator in the DVD display is lit.)
No picture.	<ul style="list-style-type: none"> The TV is not set to receive DVD signal output. 	<ul style="list-style-type: none"> Select the appropriate video input mode on the TV so the picture from the DVD player appears on the TV screen.
	<ul style="list-style-type: none"> The video cable is not connected securely. 	<ul style="list-style-type: none"> Connect the video cable into the jacks securely.
	<ul style="list-style-type: none"> The connected TV power is turned off. 	<ul style="list-style-type: none"> Turn on the TV.
No sound.	<ul style="list-style-type: none"> The equipment connected with the audio cable is not set to receive DVD signal output. 	<ul style="list-style-type: none"> Select the correct input mode of the audio receiver so you can listen to the sound from the DVD player.
	<ul style="list-style-type: none"> The audio cables are not connected securely. 	<ul style="list-style-type: none"> Connect the audio cable into the jacks securely.
	<ul style="list-style-type: none"> The power of the equipment connected with the audio cable is turned off. 	<ul style="list-style-type: none"> Turn on the equipment connected with the audio cable.
	<ul style="list-style-type: none"> The Digital Audio Output is set to the wrong position. 	<ul style="list-style-type: none"> Set the Digital Audio Output to the correct position, then turn on the DVD player again by pressing the POWER button.
The playback picture is poor.	<ul style="list-style-type: none"> The disc is dirty. 	<ul style="list-style-type: none"> Clean the disc.
The DVD player does not start playback.	<ul style="list-style-type: none"> No disc is inserted. 	<ul style="list-style-type: none"> Insert a disc. (Check that the DVD, or audio CD indicator in the DVD display is lit.)
	<ul style="list-style-type: none"> An unplayable disc is inserted. 	<ul style="list-style-type: none"> Insert a playable disc. (Check the disc type, color system and Regional code.)
	<ul style="list-style-type: none"> The disc is placed upside down. 	<ul style="list-style-type: none"> Place the disc with the playback side down.
	<ul style="list-style-type: none"> The disc is not placed within the guide. 	<ul style="list-style-type: none"> Place the disc on the disc tray correctly inside the guide.
	<ul style="list-style-type: none"> The disc is dirty. 	<ul style="list-style-type: none"> Clean the disc.
	<ul style="list-style-type: none"> A menu is on the TV screen. 	<ul style="list-style-type: none"> Press the SETUP button to turn off the menu screen.
	<ul style="list-style-type: none"> The Rating level is set. 	<ul style="list-style-type: none"> Cancel the Rating function or change the rating level.
The remote control does not work properly.	<ul style="list-style-type: none"> The remote control is not pointed at the remote sensor of the DVD player. 	<ul style="list-style-type: none"> Point the remote control at the remote sensor of the DVD player.
	<ul style="list-style-type: none"> The remote control is too far from the DVD player. 	<ul style="list-style-type: none"> Operate the remote control within about 23 ft (7 m).
	<ul style="list-style-type: none"> There is an obstacle in the path of the remote control and the DVD player. 	<ul style="list-style-type: none"> Remove the obstacle.
	<ul style="list-style-type: none"> The batteries in the remote control are exhausted. 	<ul style="list-style-type: none"> Replace the batteries with new ones.

Specifications

DVD player/Outputs/Supplied Accessories

[DVD player]	Power supply	AC 100-240V, 50/60 Hz
	Power consumption	16 W
	Mass	7.1 lbs (3.2 kg)
	External dimensions (W X H X D)	17" X 3.5" X 8.46" (430 x 88 x 215 mm)
	Signal system	PAL 625/50, NTSC 525/60
	Laser	Semiconductor laser, wavelength 650 nm
	Frequency range (audio)	4 Hz to 20 kHz
	Signal-to-noise ratio (audio)	More than 100 dB (EIAJ)
	Dynamic range (audio)	More than 95 dB (EIAJ)
	Harmonic distortion (audio)	0.008 %
	Wow and flutter	Below measurable level (less than + 0.001 % (W.PEAK)) (EIAJ)
	Operating conditions	Temperature: 41°F to 95°F, Operation status: Horizontal
	[Outputs]	Video output
S-video output		(Y) 1.0 V (p-p), 75 Ω, negative sync., Mini DIN 4-pin x 1 (C) 0.286 V (p-p), 75 Ω,
Audio output (digital audio)		0.5 V (p-p), 75 Ω, RCA jack x 1
Audio output (optical audio)		Optical connector x 1
Audio output (analog audio)		2.0 Vrms(1 KHz, 0 dB), 330 Ω, RCA jack (L, R) x 1/SCART(TO TV)
[Supplied Accessories]	<ul style="list-style-type: none"> ● S-video cable1 ● Video cable1 ● Audio cable1 ● Remote control.....1 	

* Designs and specifications are subject to change without notice.



Technology with the human touch

GUARANTEE

- LG Electronics U.K. Ltd. will provide the following services in order to expedite this Guarantee.
 1. All faulty components which fail due to defective manufacture will be replaced free of charge for a period of 12 months from the original date of purchase.
 2. The dealer (or his service agent) who sold the product will be reimbursed for any labour provided in the repair of this LG equipment, for a period of 12 months from the original date of purchase. These claims must be made in accordance with the published scale of service charges and relevant claims procedure.

PLEASE NOTE:

- A. The dealer may restrict the guarantee to the original purchaser.
- B. The dealer is not obliged to carry out service under guarantee if unauthorized modifications are made to the apparatus, or if non standard components are used or if the serial number of the apparatus is removed, defaced, misused, or altered.
- C. Any claims made under guarantee must be directed to the dealer from whom the equipment was originally purchased. The dealer may, before carrying out service under guarantee, require a receipted account as evidence of the date of purchase.
- D. We respectfully point out that your dealer is not obligated to replace batteries if they become exhausted or worn in use.
- E. Aerial alignment and consumer control adjustments are not covered by this guarantee.

This guarantee does not affect your statutory rights.

● REQUIREMENTS TO MAINTAIN WARRANTY COVERAGE:

RETAIN YOUR RECEIPT TO PROVE DATE OF PURCHASE. A COPY OF YOUR RECEIPT MUST BE SURRENDERED AT THE TIME GUARANTEE SERVICE IS PROVIDED.

- Product Registration Card : It is helpful to complete at least your name, address, phone, model & serial numbers and return it. This will enable LG to assist you in the future should you lose your receipt, your units be stolen, or should modifications be necessary.

- To obtain information or assistance: Call 01753 500470 Monday-Friday 9.00am-4.30pm

MODEL NO.*	SERIAL NO.*	DATE OF PURCHASE.*

* Please complete for your own record

**In all cases of difficulty - consult your LG dealer
from whom the product was purchased**

Free Manuals Download Website

<http://myh66.com>

<http://usermanuals.us>

<http://www.somanuals.com>

<http://www.4manuals.cc>

<http://www.manual-lib.com>

<http://www.404manual.com>

<http://www.luxmanual.com>

<http://aubethermostatmanual.com>

Golf course search by state

<http://golfingnear.com>

Email search by domain

<http://emailbydomain.com>

Auto manuals search

<http://auto.somanuals.com>

TV manuals search

<http://tv.somanuals.com>