



VCR & DVD RECORDER

OWNER'S MANUAL

MODEL: LRY-517

Before connecting, operating or adjusting this product, please read this owner's manual carefully and completely.

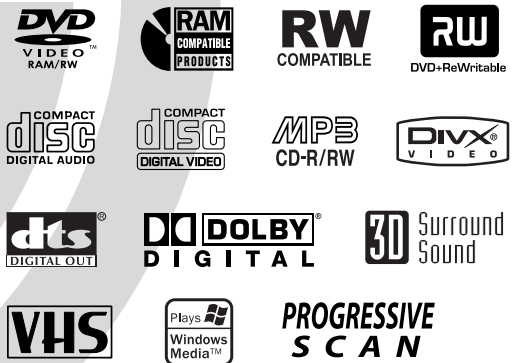
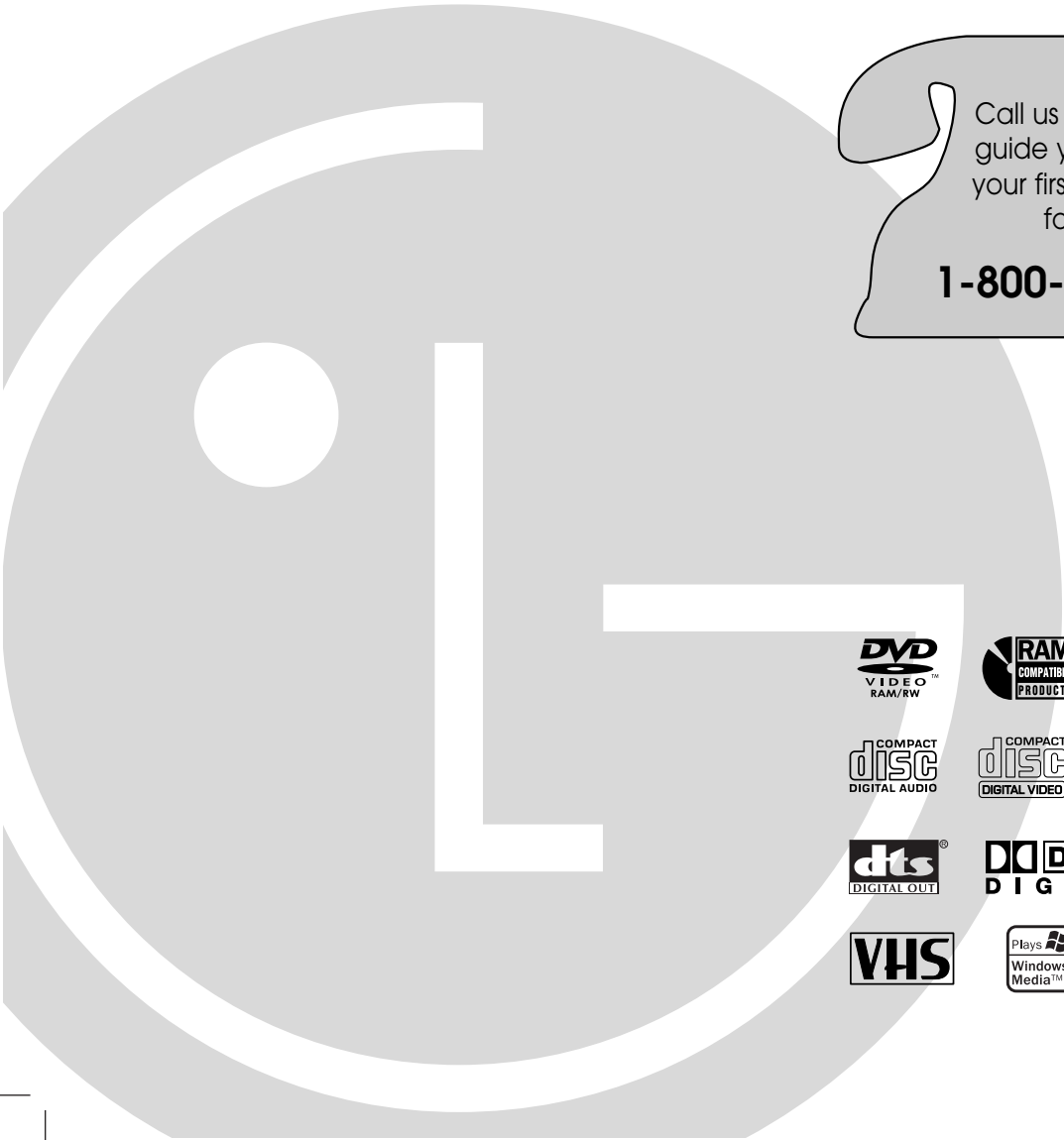



CAUTION
RISK OF ELECTRIC SHOCK
DO NOT OPEN



CAUTION: TO REDUCE THE RISK OF ELECTRIC SHOCK DO NOT REMOVE COVER (OR BACK) NO USER-SERVICEABLE PARTS INSIDE REFER SERVICING TO QUALIFIED SERVICE PERSONNEL.



This lightning flash with arrowhead symbol within an equilateral triangle is intended to alert the user to the presence of uninsulated dangerous voltage within the product's enclosure that may be of sufficient magnitude to constitute a risk of electric shock to persons.



The exclamation point within an equilateral triangle is intended to alert the user to the presence of important operating and maintenance (servicing) instructions in the literature accompanying the product.

WARNING: TO PREVENT FIRE OR ELECTRIC SHOCK HAZARD, DO NOT EXPOSE THIS PRODUCT TO RAIN OR MOISTURE.

WARNING: Do not install this equipment in a confined space such as a bookcase or similar unit.

CLASS 1 LASER PRODUCT
KLASSE 1 LASER PRODUKT
LUOKAN 1 LASER LAITE
KLASS 1 LASER APPARAT
CLASSE 1 PRODUIT LASER

CAUTION:

This product employs a Laser System. To ensure proper use of this product, please read this owner's manual carefully and retain it for future reference. Should the unit require maintenance, contact an authorized service center. Performing controls, adjustments, or carrying out procedures other than those specified herein may result in hazardous radiation exposure. To prevent direct exposure to laser beam, do not try to open the enclosure. Visible laser radiation when open. **DO NOT STARE INTO BEAM.**

CAUTION: The apparatus should not be exposed to water (dripping or splashing) and no objects filled with liquids, such as vases, should be placed on the apparatus.

CAUTION: CLASS 2M VISIBLE AND INVISIBLE LASER RADIATION WHEN OPEN AND INTERLOCKS DEFEATED DO NOT STARE INTO THE BEAM OR VIEW DIRECTLY WITH OPTICAL INSTRUMENTS

FCC WARNING: This equipment may generate or use radio frequency energy. Changes or modifications to this equipment may cause harmful interference unless the modifications are expressly approved in the instruction manual. The user could lose the authority to operate this equipment if an unauthorized change or modification is made.

REGULATORY INFORMATION: FCC Part 15

This equipment has been tested and found to comply with the limits for a Class B digital device, pursuant to Part 15 of the FCC Rules. These limits are designed to provide reasonable protection against harmful interference when the product is operated in a residential installation. This product generates, uses, and can radiate radio frequency energy and, if not installed and used in accordance with the instruction manual, may cause harmful interference to radio communications. However, there is no guarantee that interference will not occur in a particular installation. If this product does cause harmful interference to radio or television reception, which can be determined by turning the product off and on, the user is encouraged to try to correct the interference by one or more of the following measures:

- Reorient or relocate the receiving antenna.
- Increase the separation between the product and receiver.
- Connect the product into an outlet on a circuit different from that to which the receiver is connected.
- Consult the dealer or an experienced radio/TV technician for help.

FCC COMPLIANCE: The responsible party for this product's compliance is:
LG Electronics U.S.A., Inc., 1000 Sylvan Avenue,
Englewood Cliffs, NJ.
Phone: 1-800-243-0000.

CAUTION concerning the Power Cord

Most appliances recommend they be placed upon a dedicated circuit;

That is, a single outlet circuit which powers only that appliance and has no additional outlets or branch circuits. Check the specification page of this owner's manual to be certain.

Do not overload wall outlets. Overloaded wall outlets, loose or damaged wall outlets, extension cords, frayed power cords, or damaged or cracked wire insulation are dangerous. Any of these conditions could result in electric shock or fire. Periodically examine the cord of your appliance, and if its appearance indicates damage or deterioration, unplug it, discontinue use of the appliance, and have the cord replaced with an exact replacement part by an authorized servicer.

Protect the power cord from physical or mechanical abuse, such as being twisted, kinked, pinched, closed in a door, or walked upon. Pay particular attention to plugs, wall outlets, and the point where the cord exits the appliance.

SERIAL NUMBER:

You can find the serial number on the back of the unit. This number is unique to this unit and not available to others. You should record requested information here and retain this guide as a permanent record of your purchase.

Model No. _____

Serial No. _____

IMPORTANT SAFETY INSTRUCTIONS

CAUTION: PLEASE READ AND OBSERVE ALL WARNINGS AND INSTRUCTIONS IN THIS OWNER'S MANUAL. AND THOSE MARKED ON THE PRODUCT. RETAIN THIS BOOKLET FOR FUTURE REFERENCE.

This product has been designed and manufactured to assure personal safety. Improper use can result in electric shock or fire hazard. The safeguards incorporated in this product will protect you if you observe the following procedures for installation, use, and servicing.

This product does not contain any parts that can be repaired by the user.

DO NOT REMOVE THE CABINET COVER, OR YOU MAY BE EXPOSED TO DANGEROUS VOLTAGE. REFER SERVICING TO QUALIFIED SERVICE PERSONNEL ONLY.

- 1. Read these instructions.** - All these safety and operating instructions should be read before the product is operated.
- 2. Keep these instructions.** - The safety, operating and use instructions should be retained for future reference.
- 3. Heed all warnings.** - All warnings on the product and in the operating instructions should be adhered to.
- 4. Follow all instructions.** - All operating and use instructions should be followed.
- 5. Do not use this product near water.** - For example: near a bath tub, wash bowl, kitchen sink, laundry tub, in a wet basement; or near a swimming pool; and other areas located near water.
- 6. Clean only with dry cloth.** - Unplug this product from the wall outlet before cleaning. Do not use liquid cleaners.
- 7. Do not block any ventilation openings. Install in accordance with the manufacturer's instructions.** - Slots and openings in the cabinet are provided for ventilation and to ensure reliable operation of the product and to protect it from over-heating. The openings should never be blocked by placing the product on a bed, sofa, rug or other similar surface. This product should not be placed in a built-in installation such as a bookcase or rack unless proper ventilation is provided or the manufacturer's instructions have been adhered to.
- 8. Do not install near any heat sources such as radiators, heat registers, stoves, or other apparatus (including amplifiers) that produce heat.**
- 9. Do not defeat the safety purpose of the polarized or grounding-type plug.** A polarized plug has two blades with one wider than the other. A grounding type plug has two blades and a third grounding prong. The wide blade or the third prong are provided for your safety. If the provided plug does not fit into your outlet, consult an electrician for replacement of the obsolete outlet.
- 10. Protect the power cord from being walked on or pinched particularly at plugs, convenience receptacles, and the point where they exit from the product.**
- 11. Only use attachments/accessories specified by the manufacturer.**
- 12. Use only with the cart, stand, tripod, bracket, or table specified by the manufacturer, or sold with apparatus. When a cart is used, use caution when moving the cart/product combination to avoid injury from tip-over.**
- 13. Unplug this product during lightning storms or when unused for long periods of time.**
- 14. Refer all servicing to qualified service personnel. Servicing is required when the product has been damaged in any way, such as power-supply cord or plug is damaged, liquid has been spilled or objects have fallen into the product, the product has been exposed to rain or moisture, does not operate normally, or has been dropped.**



INTRODUCTION

Symbol Used in this Manual	6
About the \emptyset Symbol Display	6
Notes on Discs	6
Moisture Condensation	6
Recordable and Playable Discs	7
The recommendable recordable DVD discs	7
Playable Discs	8
Regional code of the recorder and DVDs	8
Restrictions on video recording	9
What is 'CPRM'?	9
Copyright	9
Notice for Progressive Scan Use	9
Card useable on this unit	10
Using Memory Card	10
About the Remote Control	10
Disc-related terms	11
Front Panel	12
Function Display Window	13
Remote Control	14
Rear Panel	15

HOOKUP AND SETTINGS

Connecting an Antenna or Cable TV	16
Connections to your TV	16-17
Optional TV Connections	17
Connection to an Amplifier	17-18
Initial Settings	19-26
General Operation	19
General Settings	19-21
• Tuning Band Select	19
• Auto Channel Set	19
• To Add or Erase Channels from Memory	20
• Clock Set	20
• TV Aspect	20
• Progressive Scan	21
• Power Save Mode	21
• Factory Setting	21
Language Settings	21
• Display Menu	21
• Disc Menu / Audio / Subtitle	21
Audio Settings	22
• Dolby Digital / DTS / MPEG	22
• Sampling Freq. (Frequency)	22
• DRC (Dynamic Range Control)	22
• Vocal	22
Lock (Parental Control) Settings	23
• Rating	23
• Set Password	23
• Area Code	23
Recording Settings	24
• Disc Record Mode	24
• VCR Record Mode	24
• DV Record Audio	24
• Auto Chapter	24

Disc Settings	24-26
• Initialize	24
• Finalize	25
• Disc Label	25
• Disc Protect	25
• PBC	26
• AutoPlay	26
• DivX Registration Code	26

General Explanation of On-Screen

Display	27
Displaying Information While Watching TV	27
Displaying Disc Information on-screen	27

PLAYBACK

VCR Tape Playback	28-29
Basic Instructions	28
Auto Tracking	28
Manual Tracking	28
Search	28
Still Picture and Frame-by-Frame Playback	28
Slow Motion	28
Counter Memory Function	29
S-VHS Quasi Playback (SQPB)	29
Playing a DVD or Video CD	29-32
Playback Setup	29-32
• Moving to another TITLE	29
• Moving to another CHAPTER / TRACK	29
• Slow Motion	30
• Search	30
• Time Search	30
• Marker Search	30
• Random	30
• Still Picture and Frame-by-Frame Playback	31
• Zoom	31
• Repeat	31
• Repeat A-B	31
• Title Menu	31
• Disc Menu	31
• Camera Angle	31
• Subtitles	31
• Changing the Audio Soundtrack	32
• Changing the Audio Channel	32
• 3D Surround	32
• Last Condition Memory	32
• Finding Locations on a Disc	32
Playing a DivX Movie File	33-34
Notice for displaying the DivX subtitle	33
Movie menu options	33
About DivX movie files	34
Playing an Audio CD or MP3/WMA files	35-36
Audio CD and Music menu options	35
Audio CD and MP3/WMA file Features	35
• Pause	35
• Moving to another Track	35
• Repeat	35
• Changing the Audio Channel	36
• Random	36

• Repeat A-B	36
• Search	36
Notes on MP3/WMA Recordings	36
• MP3/WMA disc compatibility with this unit is limited as follows:	36
Program Playback with Audio CD and MP3/WMA files	37
Program List menu options	37
• Repeat Programmed Tracks	37
• Erasing a Track from the Program List	37
• Changing Track Order in the Program List	37
Viewing a JPEG files	38-39
Photo menu options	38-39
• Still picture	38
• Skip Images	38
• Rotate Images	38
• View Slide Shows	39
About JPEG image files	39
• JPEG disc compatibility with this recorder is limited as follows:	39

RECORDING

About DVD recording	40
Disc types and recording formats, modes, and settings	40
Notes for recording	40
Basic Recording from a TV	41
Instant Timer Recording	41-42
Checking the Recording Time	41
To Extend the Recording Time	41
To Pause the Recording	41
To record one TV program while watching another	42
Timer Recording	42-43
Checking Timer Recording Details	42
Canceling a Timer Recording	42
Timer Recording Troubleshooting	43
Playing while you are recording	43
Dubbing from DVD to VCR	44
Dubbing from VCR to DVD	44
Recording from External Components	45
Additional Information	45
Recording from DV Input	46
Before DV dubbing	46
Recording from a Digital Camcorder	46
Troubleshooting	46

EDITING

Title List and Chapter List Menu Overview	47
VR Mode: Original and Playlist Editing	48
Titles, Chapters and Parts	48
Is editing a DVD like editing a video tape?	48
About word 'Original' and 'Playlist'	48
Adding Chapter Markers	48

Changing Title Thumbnails	48
Making a New Playlist	49
Adding Additional Title/Chapters to the Playlist	49
Deleting an Original or Playlist Title/Chapter	50
Deleting a Part	50
Naming a Title	51
Time Search	51
Divide One Titles Into Two	52
Combining Two Chapters Into One	52
Moving a Playlist Chapter	53
Hide a Chapter/Title	53
Protect a Title	53
Overwriting Recording	54
Viewing Title List menu displayed on other DVD Recorders or Players	54
Playing Your Recordings on Other DVD Players (Finalizing a Disc)	54

REFERENCE

Controlling Your TV with the Supplied Remote	55
Language Code List	56
Area Codes List	56
Troubleshooting	57-59
Reset the Recorder	59
Specifications	60-61

Introduction

To ensure proper use of this product, please read this owner's manual carefully and retain for future reference.

Symbol Used in this Manual



Indicates hazards likely to cause harm to the unit itself or other material damage.

Note: Indicates special notes and operating features.

Tip: Indicates tips and hints for making the task easier.

A section whose title has one of the following symbols are applicable only to those discs represented by the symbol.

- RW_{VR}** DVD-RW with VR recording mode
- RW_{Video}** DVD-RW with Video recording mode
- RAM** DVD-RAM disc
- +RW** DVD+RW disc
- R** DVD-R disc
- +R** DVD+R disc
- DVD** DVD-Video disc
- DivX** DivX files
- VCD** Video CDs
- ACD** Audio CDs
- MP3** MP3 files
- WMA** WMA files
- JPEG** JPEG files

About the Symbol Display

"" may appear on your TV display during operation and indicates that the function is not permitted by this unit or the disc.

Notes on Discs

Handling Discs

Do not touch the playback side of the disc. Hold the disc by the edges so that fingerprints do not get on the surface. Never stick paper or tape on the disc.

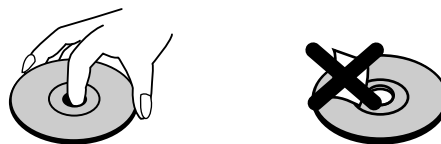

Storing Discs

After playing, store the disc in its case. Do not expose the disc to direct sunlight or sources of heat and never leave it in a parked car exposed to direct sunlight.

Cleaning Discs

Fingerprints and dust on the disc can cause poor picture quality and sound distortion. Before playing, clean the disc with a clean cloth. Wipe the disc from the center out.

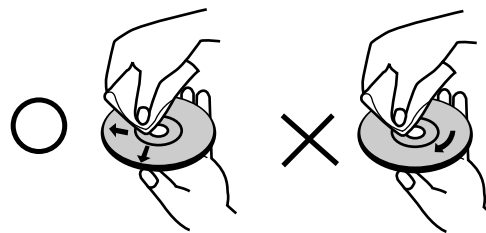

Do not use strong solvents such as alcohol, benzene, thinner, commercially available cleaners, or anti-static spray intended for older vinyl records.

Moisture Condensation

Never operate this product immediately after moving it from a cold location to a warm location. Leave it for two or three hours without operating it. If you use this product in such a situation, it may damage discs/tapes and internal parts.

Recordable and Playable Discs



DVD-RW (DVD - ReWritable)

- DVD-RW discs can be formatted for VR mode recording or Video mode recording.
- These Discs can be recorded on repeatedly. Recordings can be erased, then you can record again on the same Disc.

[VR mode]

- Recordings can be extensively edited
- Playable only on VR mode compatible players (after finalization)

[Video mode]

- Playable on regular DVD players (after finalization)
- Limited editing features



DVD-R (DVD - Recordable)

- These Discs can be recorded only once. After you finalize a DVD-R, you cannot record on it or edit it.
- DVD-R discs can be only formatted to Video mode.
- Playable on regular DVD players (after finalization)
- Limited editing features



DVD-RAM (DVD - Random Access Memory)

- DVD-RAM discs can be formatted for VR mode recording.
- These Discs can be recorded on repeatedly. Recordings can be erased, then you can record again on the same Disc.
- Playable on DVD-RAM compatible players.
- Recordings can be extensively edited.
- Only DVD-RAM standard Version 2.0, 2.1 and 2.2 discs can be used in this unit.
- You cannot use the cartridge-type DVD-RAM disc in this unit.



DVD+RW (DVD+ ReWritable)

- These Discs can be recorded on repeatedly. Recordings can be erased, then you can record again on the same Disc.
- Playable on DVD+RW compatible players (automatically finalization)
- The edited contents are playable on DVD+RW compatible players only after finalization.
- Recordings can be edited the title/chapter



DVD+R (DVD + Recordable)

- These Discs can be recorded only once. After you finalize a DVD+R, you cannot record on it or edit it any more.
- Playable on DVD+R compatible players (after finalization)
- Any edited contents are not be compatible on DVD+R compatible players. (Hide, chapter combine, added chapter mark, etc.)
- Limited title/chapter editing features.



DVD+R DL (DVD + Recordable; Double Layer)

- These Discs can be recorded only once. After you finalize a DVD+R DL, you cannot record on it or edit it any more.
- Storage space is nearly doubled with double layer DVD+R media, allowing consumers to record up to 8.5GB of video on a single DVD+R DL disc.
- Playable on DVD+R compatible players (after finalization)
- Any edited contents are not be compatible on DVD+R DL compatible players. (Hide, chapter combine, added chapter mark, etc.)
- Limited title/chapter editing features.

Recommended recordable DVD discs

DVD-R	DVD+R	DVD-RW	DVD+RW	DVD+R(DL)	DVD-RAM
SONY (8x, 16x)	SONY (2.4x, 4x, 8x, 16x)	Victor (1x, 4x)	SONY (2.4x)	Mitsubishi (2.4x)	Maxell (3x, 5x)
TDK (4x, 8x)	TDK (4x)	Maxell (1x, 2x, 4x)	TDK (2.4x)	Maxell (2.4x)	-
Verbatim (4x, 8x)	Mitsubishi (4x, 8x)	VerbatimTDK (2x)	Philips (4x)	-	-
Panasonic (2x, 4x)	Ricoh (2x, 4x, 8x)	Mitsubishi (2x)	Ricoh (2.4x)	-	-
-	-	-	HP (2.4x, 4x)	-	-

Playable Discs



DVD (8 cm / 12 cm disc)

- Discs such as movies that can be purchased or rented
-



Video CD (VCD) (8 cm / 12 cm disc)

- VIDEO CDs or CD-Rs/CD-RWs in VIDEO CD/Super VIDEO CD format
-



Audio CD (8 cm / 12 cm disc)

- Music CDs or CD-Rs/CD-RWs in music CD format that can be purchased
-



CD-R/CD-RW (8 cm / 12 cm disc)

- CD-R/CD-RW discs that contain audio titles, MP3, WMA, JPEG or DivX files.
-

Notes:

- Depending on the conditions of the recording equipment or the CD-R/RW (or DVD±R/RW) disc itself, some CD-R/RW (or DVD±R/RW) discs cannot be played on the unit.
- Do not attach any seal or label to either side (the labeled side or the recorded side) of a disc.
- Do not use irregularly shaped CDs (e.g., heart-shaped or octagonal). Doing so may result in malfunctions.
- Depending on the recording software & the finalization, some recorded discs (CD-R/RW or DVD±R/RW) may not be playable.
- DVD-R/RW, DVD+R/RW and CD-R/RW discs recorded using a personal computer or a DVD or CD Recorder may not play if the disc is damaged or dirty, or if there is dirt or condensation on the Recorder's lens.
- If you record a disc using a personal computer, even if it is recorded in a compatible format, there are cases in which it may not play because of the settings of the application software used to create the disc. (Check with the software publisher for more detailed information.)

Region code of the recorder and DVDs



This recorder is designed and manufactured for playback of Region 1 encoded DVD software. The region code on the labels of some DVD discs indicates which type of the recorder can play those discs. This unit can play only DVD discs labeled 1 or ALL. If you try to play any other discs, the message "Incorrect region code. Can't play back" will appear on the TV screen. Some DVD discs may not have a region code label even though their playback is prohibited by area limits.

Notes on DVDs and Video CDs

Some playback operations of DVDs and Video CDs may be intentionally fixed by software manufacturers. As this unit plays DVDs and Video CDs according to disc content designed by the software manufacturer, some playback features of the unit may not be available or other functions may be added.

Refer also to the instructions supplied with the DVDs and Video CDs. Some DVDs made for business purposes may not be played on the unit.

Restrictions on video recording

- You cannot record copy-protected video using this recorder. Copy-protected video includes DVD-Video discs and some satellite broadcasts. If copy-protected material is encountered during a recording, recording will pause or stop automatically and an error message will be displayed on-screen.
- Video that is 'copy-once only' can only be recorded using a DVD-RW disc in VR mode or DVD-RAM disc with CPRM (see below).

What is 'CPRM'?

CPRM is a copy protection system (with scramble system) only allowing the recording of 'copy once' broadcast programs. CPRM stands for Content Protection for Recordable Media.

This Recorder is CPRM compatible, which means that you can record copy-once broadcast programs, but you cannot then make a copy of those recordings. CPRM recordings can only be made on DVD-RW discs formatted in VR mode or DVD-RAM discs, and CPRM recordings can only be played on players that are specifically compatible with CPRM.

Copyright

- Recording equipment should be used only for lawful copying and you are advised to check carefully what is lawful copying in the area in which you are making a copy. Copying of copyright material such as films or music is unlawful unless permitted by a legal exception or consented to by the rights owner.
- This product incorporates copyright protection technology that is protected by method claims of certain U.S. patents and other intellectual property rights owned by Macrovision Corporation and other rights owners. Use of this copyright protection technology must be authorized by Macrovision Corporation, and is intended for home and other limited viewing uses only, unless otherwise authorized by Macrovision corporation. Reverse engineering or disassembly is prohibited.

Notice for Progressive Scan Use

CONSUMERS SHOULD NOTE THAT NOT ALL HIGH DEFINITION TELEVISION SETS ARE FULLY COMPATIBLE WITH THIS PRODUCT AND MAY CAUSE ARTIFACTS TO BE DISPLAYED IN THE PICTURE. IN CASE OF 525 PROGRESSIVE SCAN PICTURE PROBLEMS, IT IS RECOMMENDED THAT THE USER SWITCH THE CONNECTION TO THE 'STANDARD DEFINITION' OUTPUT. IF THERE ARE QUESTIONS REGARDING YOUR TV SET COMPATIBILITY WITH THIS MODEL 525p DVD+VCR RECORDER, PLEASE CONTACT OUR CUSTOMER SERVICE CENTER.

Card useable on this unit

- Compact Flash Card (CF)
- Micro Drive (MD)
- Secure Digital Card (SD)
- Multi Media Card (MMC)
- SmartMedia Card (SMC)
- xD-Picture Card (xD)
- Memory Stick (MS)
- Memory Stick Pro (MS-Pro)
- Compatible with: FAT 12, FAT 16, or FAT 32
- Only use the memory cards recommended above.

Regarding Write Protect

For cards that have a write protect switch, if the switch is on it will not be possible to write or erase the card.

Inserting/Removing the Memory Card

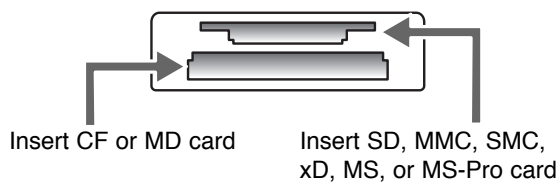

Inserting the card: Insert straight-in until it fits into place.

Removing the card: Withdraw the card carefully.

Notes:

- Keep the memory card out of reach of children. If swallowed, seek medical advice immediately.
- Some memory card may not work in this recorder, depending on the formatting.
- **Do not extract the memory card while operating (play, copy, etc.).**

Using Memory Card

1. Insert a memory card.
2. Press MEMORY on the Remote Control while in the DVD Tuner mode.
The Memory Card slot choice menu appears on the TV screen.



3. Use ▲/▼ to select the desired Memory Card slot then press ENTER.
The Photo or Music menu appears on the TV screen.
4. Press RETURN to exit the Photo or Music menu for memory card.

Note:

For details on each operation item, refer to relevant pages.

About the Remote Control

Operation Range

Point the Remote Control at the remote sensor and press the buttons.

Distance: About 23 ft (7 m) from the front of the remote sensor.

Angle: About 30° in each direction of the front of the remote sensor.

Battery installation

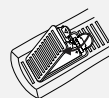

Detach the battery cover on the rear of the Remote Control, and insert two (R03/AAA) size batteries with ⊕ and ⊖ aligned correctly.



Do not mix old and new batteries and never mix different types of batteries such as standard, alkaline, etc.

Disc-related terms

DVD +R (Double Layer)

Double layer recording technology offers two recordable layers on a single DVD disc, providing nearly double the capacity of 4.7GB single layer DVDs. The greatest, most valuable benefit of double layer recording technology is increased capacity. Storage space is nearly doubled with double layer DVD+R media, allowing consumers to burn up to 8.5GB of video on a single DVD+R disc.

DVD ±R / DVD ±RW

DVD -R and DVD +R are two different standards for recordable DVD drives and discs. This format allows information to be recorded onto the DVD disc only once. DVD +RW and DVD -RW are two standards for re-writable media, meaning the DVD content can be erased and re-recorded. Single-sided discs can hold 4.7 GB and double-sided discs hold twice as much.

DVD-RAM

DVD-RAM disc can be formatted in DVD-Video Recording format (VR mode). This type of disc is able to be rewritten and edited.

VCD (Video CD)

A VCD holds up to 74 minutes (650 MB disc) or 80 minutes (700 MB disc) of MPEG-1 full-motion video along with quality stereo sound.

MPEG

MPEG is an international standard for video and audio compression. MPEG-1 is used in encoding video for VCD and provides for multichannel surround sound coding such as PCM, Dolby Digital, DTS and MPEG audio.

MP3

MP3 is a popular compression format used for digital audio files that yields very high near-CD quality.

WMA

Windows media audio file. A type of coding / decoding developed by Microsoft Corp.

JPEG

Joint Pictures Expert Group. JPEG is a compressed file format that allows you to save images with no limit on the number of colors.

DivX

DivX is the name of a revolutionary new video codec which is based on the new MPEG-4 compression standard for video. You will be able to play DivX movies using this recorder.

PBC: Playback Control (Video CD only)

Playback control is available for Video CD (VCD) version 2.0 disc formats. PBC allows you to interact with the system via menus, search functions, or other typical computer-like operations. Moreover, still pictures of high resolution can be played if they are included in the disc. Video CDs not equipped with PBC (Version 1.1) operate in the same way as audio CDs.

Title (DVD video discs only)

A title is generally a distinct section of a DVD disc. For example the main feature could be title 1, a documentary describing how the film was made could be title 2, and cast interviews could be title 3. Each title is assigned a reference number enabling you to locate it easily.

Chapter (DVD video discs only)

A chapter is a segment of a title such as a scene in a film or one interview in a series. Each chapter is assigned a chapter number, enabling you to locate the chapter you want. Depending on the disc, chapters may not be recorded.

Scene (VCD)

On a video CD with PBC (playback control) functions, moving pictures and still pictures are divided into sections called "scenes". Each scene is displayed in the menu screen and assigned a scene number, enabling you to locate the scene you want. A scene is composed of one or several tracks.

Track

A distinct element of audiovisual information, such as the picture or sound track for a specific language (DVD), or a musical piece on a video or audio CD. Each track is assigned a track number, enabling you to locate the track you want. DVD discs allow one track of video (with multiple angles) and several tracks of audio.

Front Panel

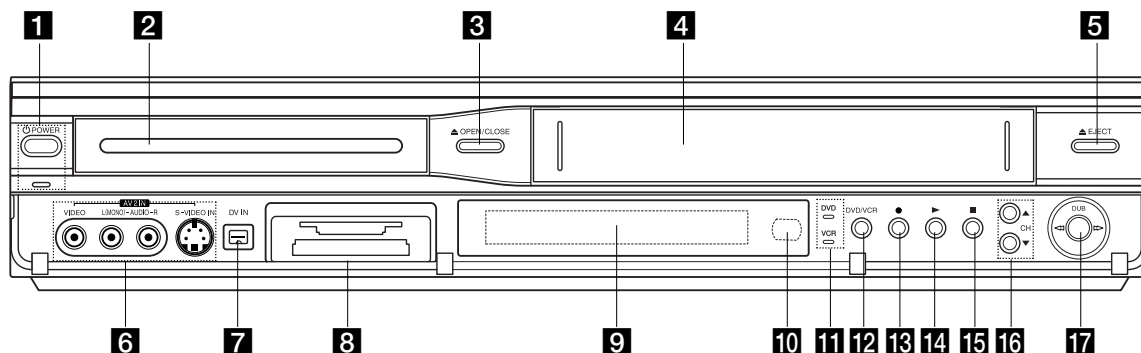

- 1 POWER button and indicator**
Switches the Recorder ON and OFF.
Lights green when the Recorder is turned on.
- 2 Disc Tray (DVD deck)**
Insert a disc here.
- 3 ▲ OPEN/CLOSE**
Opens or closes the disc tray.
- 4 Cassette Compartment (VCR deck)**
Insert a video cassette here.
- 5 ▲ EJECT**
Ejects the tape in the VCR deck.
- 6 AV 2 IN**
- VIDEO /AUDIO (Left/Right)
Connect the audio/video output of an external source (Audio system, TV/ Monitor, VCR, Camcorder, etc.).
- S-VIDEO IN
Connect the S-Video output of an external source (TV/ Monitor, VCR, Camcorder, etc.).
- 7 DV IN**
Connect the DV output of a digital camcorder.
- 8 MEMORY CARD Slot**
Insert a memory card (CF, MD, SMC, MMC, SD, MS, MS-Pro or XD-Picture).
- 9 Display window**
Shows the current status of the Recorder.
- 10 Remote Sensor**
Point the Recorder Remote Control here.
- 11 DVD/VCR indicator**
Indicates the active DVD or VCR deck.
- 12 DVD/VCR**
Toggles control between the DVD deck and the VCR deck.
- 13 ● (REC)**
Starts recording.
Press repeatedly to set the recording time.
- 14 ► (PLAY)**
To play back a disc or tape.
- 15 ■ (STOP)**
Stops playback.
- 16 CH (▲ / ▼)**
Scans up or down through memorized channels.
- 17 DUB (DUBBING)**
Press to copy DVD to VCR (or VCR to DVD).

LOCK function

The Lock feature disables the front panel buttons to prevent children from tampering with this unit. Simply press LOCK on the remote control to toggle this feature on and off.

Function Display Window

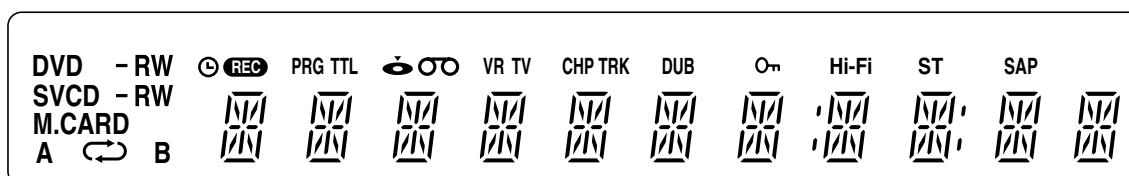

DVD - RW Indicates the type of disc loaded.
SVCD - RW

M.CARD Indicates when Memory Card is activated.

A B Indicates repeat mode.

⌚ Indicates when the recorder is in timer recording or a timer recording is programmed.

REC The recorder is recording.

PRG Programmed playback active.

TTL Indicates current title.

📀 A disc is inserted in the DVD deck.

📼 A VHS tape is inserted in the VCR deck.

VR Indicates a DVD-RW disc (VR mode only) or DVD-RAM disc is inserted in the DVD deck.

TV Indicates that TV mode is active.

CHP TRK Indicates current chapter or track number

DUB Indicates that a DVD to VCR (or VCR to DVD) dubbing is in progress.

🔒 Indicates when the Recorder is Locked.

Hi-Fi Indicates when the Recorder is playing a tape in Hi-Fi.

ST Indicates a stereo broadcast is being received.

SAP Indicates when a SAP BILINGUAL broadcast is being received.



Indicates clock, total playing time, elapsed time, remaining time, title number, chapter/track number, channel, etc.

Remote Control

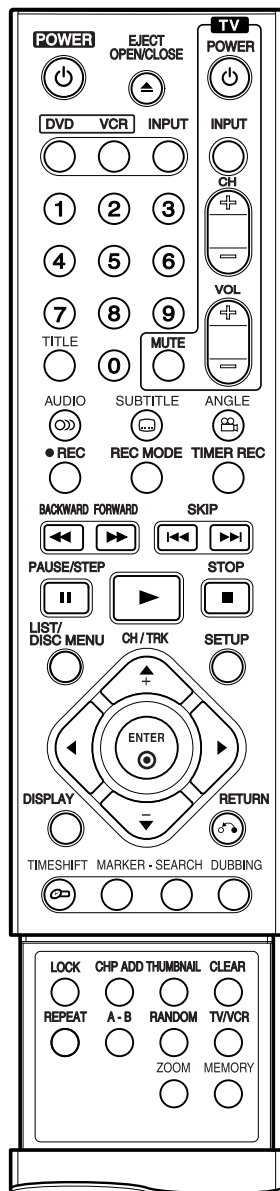

A-B

Repeats sequence between two points (A and B)

ANGLE

Selects a DVD camera angle, if available.

AUDIO

Selects an audio language (DVD) or an audio channel (CD).

BACKWARD / FORWARD

(◀▶)

- DVD: Search backward or forward.
- VCR: Rewinds/Advances the tape during the STOP mode, for fast reverse/ forward picture search.

CHP ADD

Inserts a chapter marker when playing/ recording.

CH/TRK(▲/▼):

Selects a program. Adjusts manually the tape's picture onscreen.

CLEAR

Removes a mark on the Marker Search menu.

DISPLAY

Accesses On-Screen Display. Displays information of current status.

DUBBING

Press to copy DVD to VCR (or VCR to DVD).

DVD

Select the Recorder's function mode to DVD.

EJECT, OPEN/CLOSE

- Opens and closes the disc tray.
- Ejects the tape in the VCR deck.

ENTER (⊙)

Confirms menu selections.

INPUT

Changes the input to use for recording (Tuner, AV1, AV2, or DV IN).

LIST/DISC MENU

Accesses menu on a DVD disc, Title List or Playlist menu.

LOCK

Locks/unlocks front panel buttons.

MARKER

Marks any point during playback.

MEMORY

Accesses the Photo (or Music) menu for memory card.

POWER

Turns Recorder ON and OFF.

PAUSE/STEP (||)

Pause playback or recording temporarily.

Press repeatedly for frame-by-frame playback.

RETURN (↶)

- Removes the menu.
- Displays the menu of a video CD with PBC.

REPEAT

Repeat chapter, track, title or all.

RANDOM

Plays tracks in random order.

REC MODE

- Selects the recording mode:
- DVD : SP, LP, EP or XP.
- VCR : SP or SLP.

● REC

Starts recording. Press repeatedly to set the recording time.

STOP (■)

Stops playback or recording.

SEARCH

Displays Marker Search menu.

SETUP

Accesses or removes the Setup menu.

SKIP (◀◀ / ▶▶)

Go to next chapter or track. Returns to beginning of current chapter or track or go to previous chapter or track.

SUBTITLE

Selects a subtitle language.

TITLE

Displays the disc's Title menu, if available.

THUMBAIL

Selects a thumbnail picture for the current title for use in the Title List or Chapter List menu.

TIMER REC

Displays Timer Record menu.

TIME SHIFT

To play the title being recorded and also currently being recorded appears as PIP.

TV Control Buttons

See page 55.

TV/VCR

To view channels selected by the VCR tuner or by the TV tuner.

VCR

Select the Recorder's function mode to VCR.

ZOOM

Enlarges DVD video image.

0-9 numerical buttons

- Selects numbered options in a menu.
- Inputs channel numbers.

▶ (PLAY)

Starts playback.

◀ ▶ ▲ ▼ (left/right/up/down)

Selects menu options.

Rear Panel

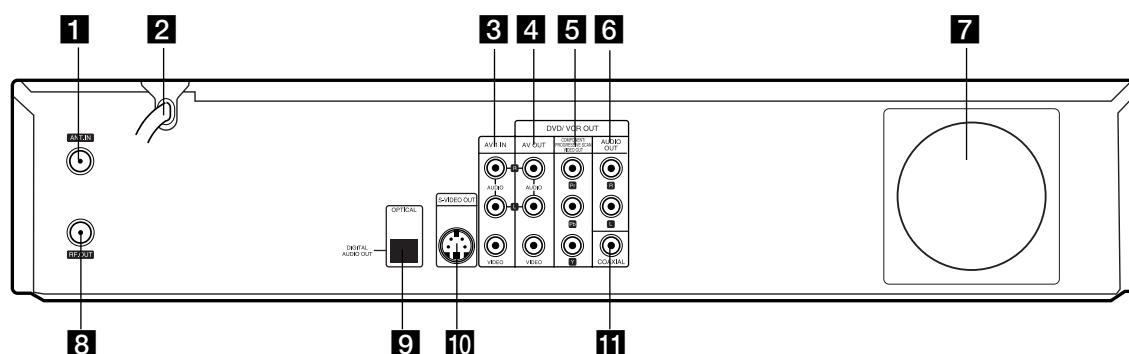

- | | |
|--|--|
| <p>1 ANT.IN
Connect the antenna to this terminal.</p> <p>2 AC Power Cord
Plug into the power source.</p> <p>3 AV 1 IN (VIDEO IN /AUDIO IN (Left/Right))
Connect the audio/video output of an external source (Audio system, TV/Monitor, VCR, Camcorder).</p> <p>4 AV OUT (VIDEO OUT/AUDIO OUT (Left/Right))
Connect to a TV with video and audio inputs.</p> <p>5 COMPONENT/PROGRESSIVE SCAN VIDEO OUT (Y Pb Pr)
Connect to a TV with Y Pb Pr inputs.</p> | <p>6 AUDIO OUT (Left/Right)
Connect to a TV or other equipment with audio inputs.</p> <p>7 Cooling fan</p> <p>8 RF. OUT
Connect to a TV with RF coaxial inputs.</p> <p>9 OPTICAL (DIGITAL AUDIO OUT jack)
Connect to digital (optical) audio equipment.</p> <p>10 S-VIDEO OUT
Connect to a S-Video Input on TV.</p> <p>11 COAXIAL (DIGITAL AUDIO OUT jack)
Connect to digital (coaxial) audio equipment.</p> |
|--|--|

Caution

Do not touch the inner pins of the jacks on the rear panel. Electrostatic discharge may cause permanent damage to the unit.

Hookup and Settings

Depending on your TV and other equipment there are various ways you can connect the recorder. Please refer to the manuals of your TV, VCR, Stereo System or other devices as necessary for additional connection information.

Notes:

- Make sure the Recorder is connected directly to the TV and tune the TV to the correct video input channel.
- Do not connect the Recorder's AUDIO OUT jack to the phono in jack (record deck) of your audio system. Do not connect the Recorder via another VCR. The DVD image could be distorted by the copy protection system.
- The picture and sound of a nearby TV, VCR, or radio may be distorted during playback. Position the units away from each other or turn off the unit after removing the disc.

Connecting an Antenna or Cable TV

1 Antenna:

Disconnect the antenna from the rear of the TV and identify the antenna cable. If it is a round 75 ohm coaxial cable connect it directly to the jack marked ANT.IN on your Recorder. If your antenna cable is flat connect it to a 300-ohm to 75-ohm antenna adaptor (not supplied) and slip the adaptor over the ANT.IN jack. Don't attempt to screw it into the Recorder.

2 Cable TV:

If your cable connection has no converter or descrambler, unscrew the cable from your TV and attach it to the ANT.IN jack on the Recorder. If a converter is required connect a coaxial cable from the wall jack to the IN connector on the converter, and a coaxial cable from the OUT connector on the converter to the ANT.IN on your Recorder. This cable hookup permits both TV and Recorder operation.

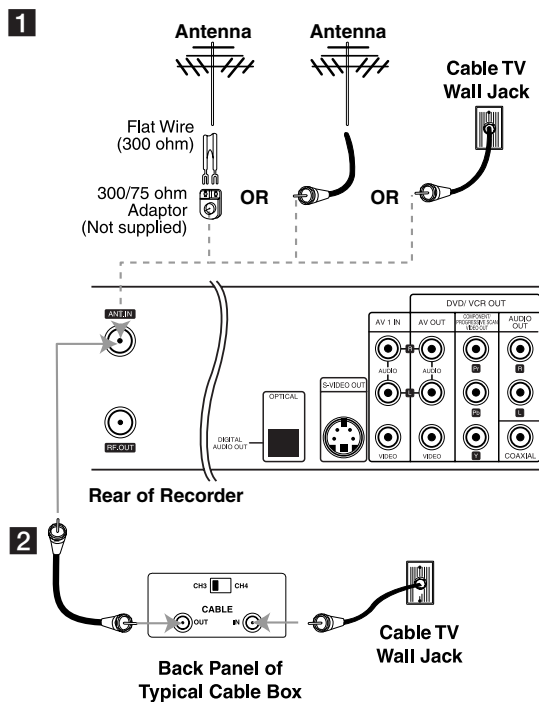

To view or record a CATV channel

1. Tune the TV to the Recorder output channel (CH 3 or 4).
2. Set the Recorder channel selector to the cable output channel. (Example: CH3)
3. Select a channel using the cable converter.

Notes:

- With this connection, you cannot record one program while viewing another.
- If you are using a cable box to tune channels, it is not necessary to do Auto Channel Set.

Connections to your TV

Make one of the following connections, depending on the capabilities of your TV.

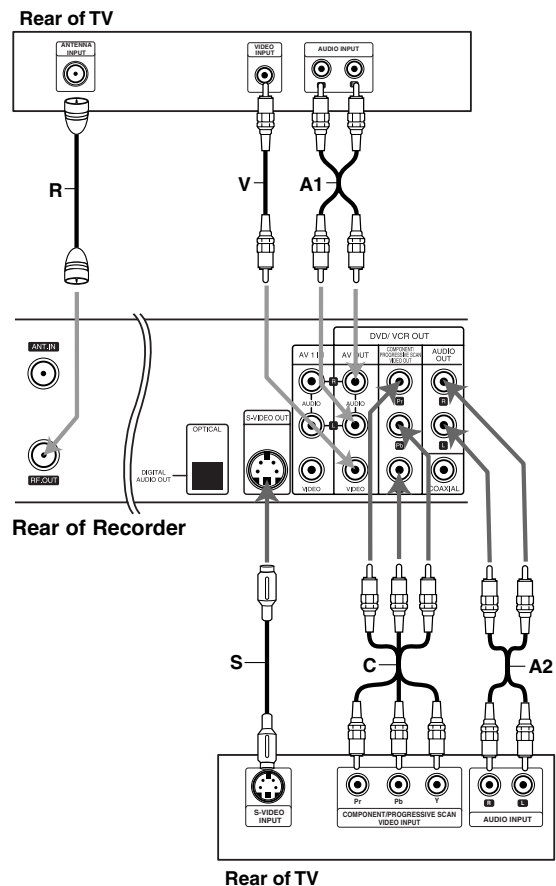

RF coaxial connection

Connect the RF.OUT jack on the Recorder to the antenna in jack on the TV using the supplied 75-ohm Coaxial Cable (R).

How to set the Recorder's RF output channel

1. When the Recorder is turned off, press and hold CH (▼/▲) on the front panel for more than five seconds. [RF-03] or [RF-04] appears in the display window.
2. Press CH (▼/▲) to change the RF output channel (RF-03 or RF-04).
3. Tune the TV to this channel.

Video connection

Connect the DVD/VCR VIDEO OUT jack on the Recorder to the video in jack on the TV using the video cable supplied (V).

Note:

If you use this connection, set the TV's source selector to VIDEO.

S-Video connection

Connect the S-VIDEO OUT jack on the Recorder to the S-Video in jack on the TV using the optional S-Video cable (S).

Component Video / Progressive Scan connection

If your television is a high-definition or "digital ready" television, you may take advantage of the Recorder's progressive scan output for the highest video resolution possible.

Connect the COMPONENT/PROGRESSIVE SCAN VIDEO OUT jacks on the Recorder to the corresponding in jacks on the TV using an optional Y Pb Pr cable (C).

Notes:

- Set Progressive Scan option to [ON] in the setup menu, see page 21.
- Progressive Scan does not work with the RF, Audio/Video or S-Video connections.
- If your TV does not accept the Progressive Scan format, the picture will appear scrambled.
- When you use Component Video signal, set the Progressive Scan to [OFF] on the setup menu.

Audio connection

Connect the Left and Right DVD/VCR AUDIO OUT jacks on the Recorder to the audio left/right in jacks on the TV using the supplied audio cables (A1 or A2).

Connection to an Amplifier

Connecting to an amplifier equipped with two channel analog stereo or Dolby Pro Logic II/Pro Logic

Connect the Left and Right AUDIO OUT (or DVD/VCR AUDIO OUT) jacks on the Recorder to the audio left and right in jacks on your amplifier, receiver, or stereo system using the audio cables (A) supplied.

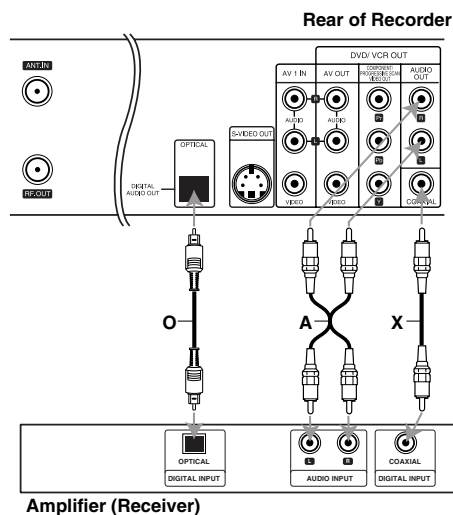

Manufactured under license from Dolby Laboratories. "Dolby", "Pro Logic", and the double-D symbol are trademarks of Dolby Laboratories.

DTS and DTS Digital Out are trademarks of Digital Theater Systems, Inc.

Connecting to an amplifier equipped with two channel digital stereo (PCM) or to an Audio/Video receiver equipped with a multi-channel decoder (Dolby Digital™, MPEG 2, or DTS)

1. Connect one of the Recorder's DIGITAL AUDIO OUT jacks (OPTICAL **O**, COAXIAL **X**) to the corresponding in jack on your amplifier. Use an optional digital (OPTICAL **O**, COAXIAL **X**) audio cable.
2. You will need to activate the Recorder's digital output. (See [Audio Settings] on page 22).

Digital Multi-channel sound

A digital multi-channel connection provides the best sound quality. For this you need a multi-channel Audio/Video receiver that supports one or more of the audio formats supported by your Recorder (MPEG 2, Dolby Digital and DTS). Check the receiver manual and the logos on the front of the receiver.

Caution:

Due to the DTS Licensing agreement, the digital output will be in DTS digital out when DTS audio stream is selected.

Notes:

- If the audio format of the digital output does not match the capabilities of your receiver, the receiver will produce a strong, distorted sound or no sound at all.
- Six Channel Digital Surround Sound via digital connection can only be obtained if your receiver is equipped with a Digital Multi-channel decoder.
- To see the audio format of the current DVD in the on-screen display, press AUDIO.
- This Recorder does not perform internal (2 channel) decoding of a DTS sound track. To enjoy DTS multi channel surround, you must connect this Recorder to a DTS compatible receiver via one of this Recorder's digital audio outputs.

Accessory Audio/Video (A/V) Connections to Recorder

Connect the AV 1 IN or AV 2 IN jacks on the Recorder to the audio/video out jacks on your accessory component, using the optional audio/video cables. (Refer to page 45 for [Recording from External Components].)

Note:

If you use the S-VIDEO IN jack on the front panel, the VIDEO IN jack on the front panel is not available.

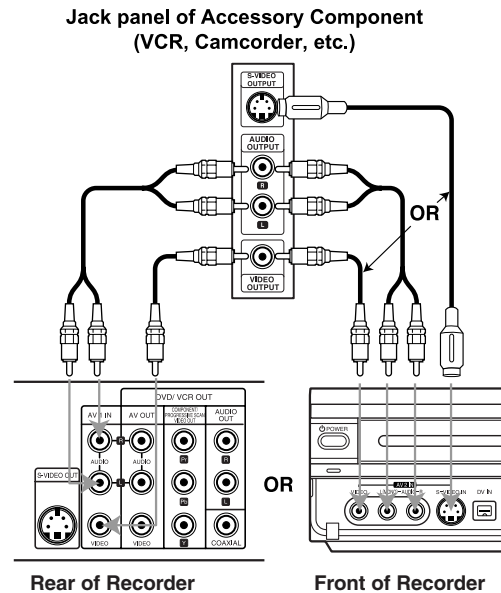

Connecting a Digital Camcorder

Use a DV cable (not supplied) to connect the DV in/out jack of your DV Digital Camcorder to the front panel DV IN jack of this Recorder.

Note:

This jack is for connection to DV equipment only. It is not compatible with digital satellite tuners or D-VHS video decks.

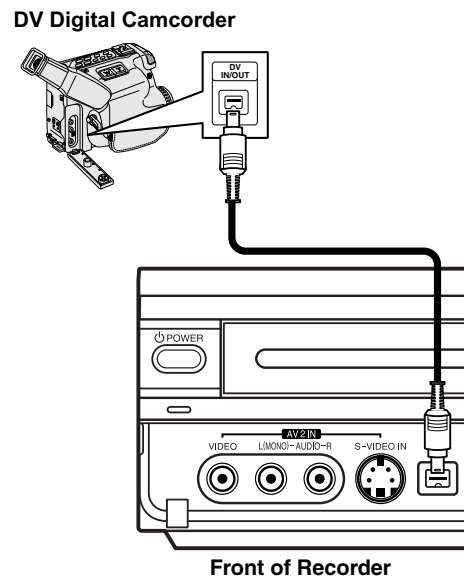

Initial Settings

In this menu system, there are several ways to customize the settings provided. Most menus consist of three levels to set up the options, but some require greater depth for the variety of settings.

General Operation

1. Press SETUP and the Setup menu appears.
2. Use ▲ / ▼ to select the desired option.
3. While the desired item is selected, press ► to move to the second level.
4. Use ▲ / ▼ to select the second desired option.
5. Press ► to move to the third level.
6. Use ▲ / ▼ to select the desired setting then press ENTER to confirm your selection.
Some items require additional steps.
7. Press SETUP to exit the Setup menu.

Note:

Press ◀ to go back to the previous level.

General Settings

Tuning Band Select

1. Select the [Tuning Band] option then press ►.
2. Use ▲ / ▼ to select the tuning band (TV or CATV) option then press ENTER.
TV: If you are using a standard antenna to receive channels.
CATV: If you are using basic cable to receive channels.



Auto Channel Set

Connect the Recorder to the desired type of antenna or cable TV system as shown on page 16.

This Recorder is equipped with a frequency synthesized tuner capable of receiving up to 181 channels. These include VHF channels 2-13, UHF channels 14-69 and CATV channels 1-125.

1. Select the [Auto Channel Set] option.
2. Press ► to move to the third level.
[Start] icon is highlighted.
3. Press ENTER to begin the channel search.
The tuner will automatically cycle through all available channels in the area and place them in the tuner's memory.

Note:

After the Auto Channel Set proceeding is complete, make sure the Tuning Band is set appropriately (TV or CATV) on tuning band, follow steps 1~2 as shown previous (Tuning Band Select) to choose the correct Tuning Band (TV or CATV).

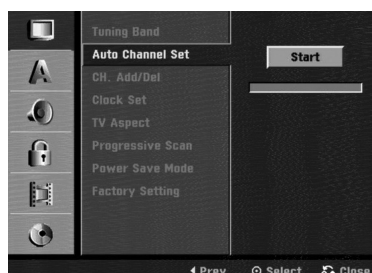

To Add or Erase Channels from Memory

This feature allows you to add to or erase channels from memory manually.

1. Select the [CH. Add/Del] option.
2. Press ► to move to the third level. [Edit] icon is highlighted.
3. Press ENTER and the Channel Edit menu appears.



4. Use ▲ / ▼ or number buttons to select a channel to add or delete then press ►. [Add] or [Delete] icon is highlighted.
5. Press ENTER to confirm your setting.
6. Repeat steps 4-5 to add or erase additional channels.
7. Press SETUP or RETURN (↵) to exit the menu.

Clock Set

1. Select the [Clock Set] option.
2. Press ► to move to the third level.

Auto

The Auto option is set at the factory. In the Auto option, the Recorder looks for a channel carrying XDS (Extended Data Services) information. XDS updates the clock using the Coordinated Universal Time.

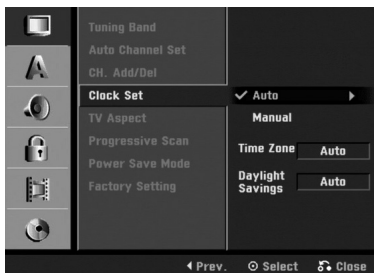

1. Use ▲ / ▼ to choose your Time Zone manually. When Timezone is set to Auto, the Recorder will use XDS information to determine the proper setting.
2. Use ► to choose the [Daylight Savings] option. Use ▲ / ▼ to choose Auto, On, or Off. When it is set to Auto, the Recorder will use XDS information to determine the proper setting.
3. Press ENTER to confirm your setting.

Note :

The Auto Clock Feature enables the Recorder to set up the clock when the Recorder is turned off.

Manual

If your local TV station does not send date and time information, or sends incorrect information, you can set the clock manually.

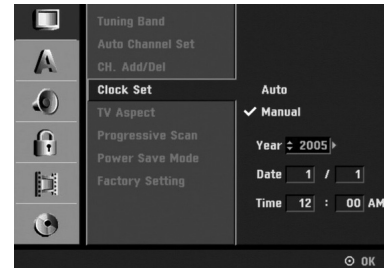

1. Enter the necessary information for year, date and time.
 - ◀ / ▶ (left/right): Moves the cursor to the previous or next column.
 - ▲ / ▼ (up/down): Changes the setting at the current cursor position.
2. Press ENTER to confirm your setting.
3. Press SETUP to exit the Setup menu.

TV Aspect

4:3 Letter Box:

Select when a standard 4:3 TV is connected. Displays theatrical images with masking bars above and below the picture.

4:3 Pan Scan:

Select when a standard 4:3 TV is connected. Displays pictures cropped to fill your TV screen. Both sides of the picture are cut off.

16:9 Wide:

Select when a 16:9 wide TV is connected.

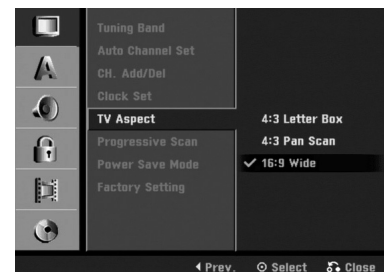

Progressive Scan

Progressive Scan Video provides the highest quality pictures with less flickering.

[ON] : Using the COMPONENT/PROGRESSIVE SCAN VIDEO OUT jacks for connection to a TV or monitor that is compatible with a progressive scan signal.

[OFF] : Using the COMPONENT/PROGRESSIVE SCAN VIDEO OUT jacks, but are connecting the Recorder to a standard (analog) television.

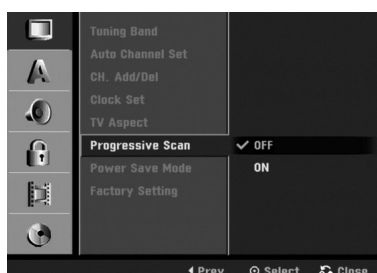

Caution

Once the setting for Progressive Scan output is entered, an image will only be visible on a Progressive Scan compatible TV or monitor. If you set Progressive Scan to [ON] in error, you must reset the Recorder. First, remove the disc or tape in the Recorder. Next, press STOP (■) and hold it for five seconds before releasing it. The video output will be restored to the standard setting, and a picture will once again be visible on a conventional analog TV or monitor.

Power Save Mode

Set Power Save Mode to [ON] to place your Recorder into an economic power save mode.

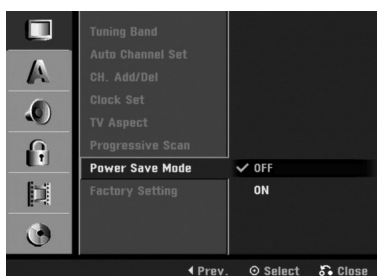

Factory Setting

You can reset the Recorder to its original factory settings. Some options cannot be reset (Rating, Password, Area Code).

1. Select the [Factory Setting] option.
2. Press ► to select [SET] then press ENTER. The Initialize menu will appear.

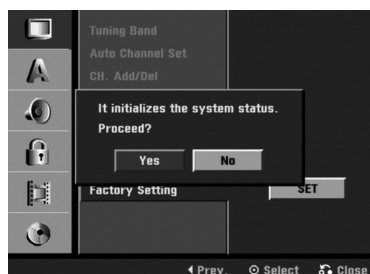

3. Select [Yes] and press ENTER.

Language Settings

Display Menu

Select a language for the Setup menu and information display.



Disc Menu / Audio / Subtitle

[Original] : Refers to the original language in which the disc was recorded.

[Others] : To select another language, press number buttons then ENTER to enter the corresponding 4-digit number according to the language code list in the reference chapter (see p. 56). If you enter the wrong language code, press CLEAR.

[OFF] (for Disc Subtitle) : Turn off Subtitle.



Audio Settings

Each DVD disc has a variety of audio output options. Set the Recorder's Audio Output according to the type of audio system you use.

Dolby Digital / DTS / MPEG

[Bitstream]: Select [Bitstream] if you connect the DVD+VCR's DIGITAL AUDIO OUT jack to an amplifier or other equipment with a Dolby Digital, DTS or MPEG decoder.

[PCM] (for Dolby Digital / MPEG): Select when connected to a two-channel digital stereo amplifier. DVDs encoded in Dolby Digital or MPEG will be automatically downmixed to two-channel PCM audio.

[OFF] (for DTS): If you select [Off], the DTS signal is not output through the DIGITAL AUDIO OUT jack.

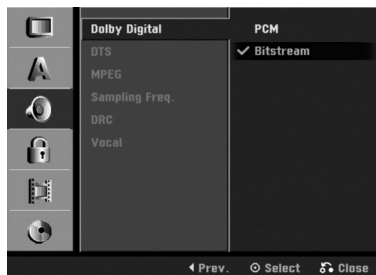

Sampling Freq. (Frequency)

If your receiver or amplifier is NOT capable of handling 96 kHz signals, select 48 kHz. When this choice is made, this unit automatically converts any 96 kHz signals to 48 kHz so your system can decode them. If your receiver or amplifier is capable of handling 96 kHz signals, select 96 kHz. When this choice is made, this unit passes each type of signal through without any further processing.

Check the documentation for your amplifier to verify its capabilities.

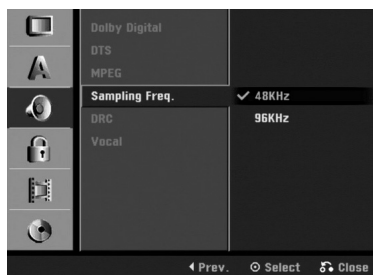

DRC (Dynamic Range Control)

With the DVD format, you can hear a program's soundtrack in the most accurate and realistic presentation possible, thanks to digital audio technology. However, you may wish to compress the dynamic range of the audio output (the difference between the loudest sounds and the quietest ones). This allows you to listen to a movie at a lower volume without losing clarity of sound. Set DRC to [ON] for this effect.

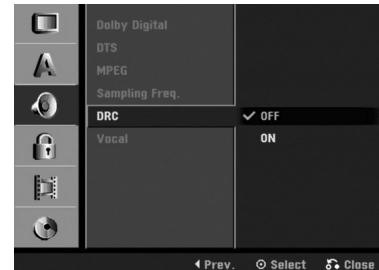

Vocal

Set Vocal to [ON] only when a multi-channel karaoke DVD is playing. The karaoke channels on the disc will mix into normal stereo sound.

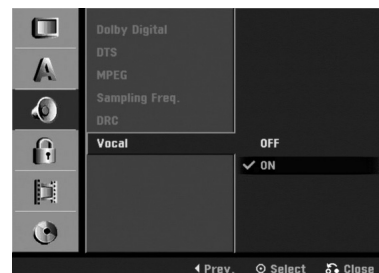

Lock (Parental Control) Settings

Rating

Some movies contain scenes that may not be suitable for children to view. Many of these discs contain parental control information that applies to the complete disc or to certain scenes on the disc. Movies and scenes are rated from 1 to 8, depending on the area. DVD video discs may or may not respond to the parental control setting if the Area code of the disc is set wrongly. Some discs offer more suitable scenes as an alternative. Ratings are area dependent. The parental control feature allows you to block access to scenes below the rating you input, thereby preventing your children from being able to view material you believe is unsuitable.

1. Select [Rating] option then press ►.
2. To access the Rating, Password and Area Code features, you must input the 4-digit security code you created.

If you have not yet entered a security code you are prompted to do so. Input a 4-digit code. Enter it again to verify. If you make a mistake press CLEAR.

3. Select a rating from 1 to 8 using the ▲ / ▼ buttons.

[1]-[8] : Rating one (1) has the most restrictions and rating eight (8) is the least restrictive.

[No Limit] : If you select [No Limit], parental control is not active and the disc plays in full.

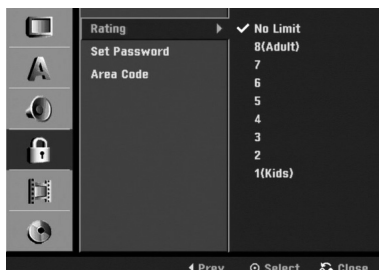

4. Press ENTER to confirm your rating selection, then press SETUP to exit the menu.
5. Press OPEN/CLOSE (▲) to activate parental control.

Note:

If you set a rating for the recorder, all disc scenes with the same rating or lower are played. Higher rated scenes are not played unless an alternate scene is available on the disc. The alternative must have the same rating or a lower one. If no suitable alternative is found, playback stops. You must enter the 4-digit password or change the rating level in order to play the disc.

Set Password

You can enter or change password.

1. Select [Set Password] option then press ►.



2. Follow step 2 as shown [Rating]. To change the password, select the [Change], press ENTER and input the new 4-digit code. Input it again to verify.
3. Press SETUP to exit the menu.

If you forget your password

If you forget your password you can clear it using the following steps:

1. Press SETUP to display the Setup menu.
2. Input the 6-digit number [210499]. The message appears, select [Yes] then press ENTER. The security code is cleared.
3. Enter a new code as described above.

Area Code

Enter the Area Code whose standards were used to rate the DVD video disc, based on the list in the reference chapter (see p. 56).



1. Select [Area Code] option then press ►.
2. Follow step 2 as shown [Rating].
3. Select the first character using ▲ / ▼ buttons.
4. Shift the cursor using ► buttons and select the second character using ▲ / ▼ buttons.
5. Press ENTER to confirm your area code selection, then press SETUP to exit the menu.

Recording Settings

Disc Record Mode

You can set the picture quality for recording; XP (Excellent quality), SP (Standard quality), LP (Low quality), EP (Extend quality).



1. Select the [Disc Record Mode] option then press **▶**.
2. Use **▲ / ▼** to select a desired Disc Record Mode (XP, SP, LP or EP).
3. Press **ENTER** to confirm your selection, then press **SETUP** to exit the menu.

VCR Record Mode

You can set the picture quality for VCR recording; SP (Standard Play), SLP (Super Long Play).

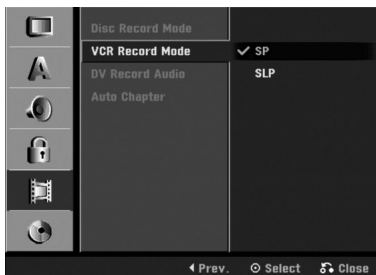

DV Record Audio

You need to set this if you have a camcorder using 32kHz/12-bit sound connected to the front panel DV IN jack. Some digital camcorders have two stereo tracks for audio. One is recorded at the time of shooting; the other is for overdubbing after shooting. On the Audio 1 setting, the sound that was recorded while shooting is used. On the Audio 2 setting, the overdubbed sound is used.

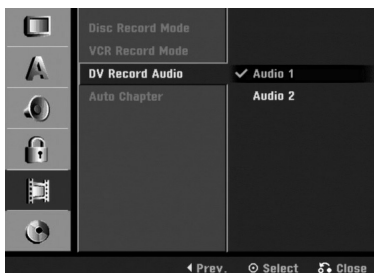

Auto Chapter

During recording, chapter markers are added automatically at fixed intervals. You can set this interval to 5 minutes or 10 minutes. To turn off automatic chapter marking, select [None].



Disc Settings

Initialize

If you load a completely blank disc, the recorder will initialize the disc.

- DVD-R: The recorder initialize the disc to Video mode. The recording mode will always be Video mode.
- DVD-RW: The Initialize menu will appear. Select [VR Mode] or [Video Mode] then press **ENTER**.
- DVD+RW/DVD+R(DL)/DVD-RAM: The Initialize menu will appears. Select [Yes] then press **ENTER**.

Also, you can reformat the DVD-RW/DVD+RW/ DVD-RAM from the Setup menu as below.

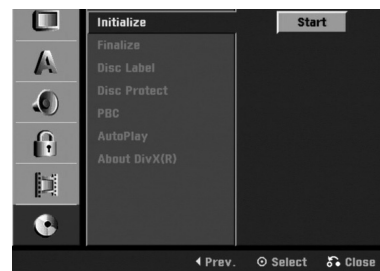

1. Select the [Initialize] option then press **▶**. [Start] icon is highlighted.
 2. Press **ENTER**.
- In case of DVD-RW, use **◀ / ▶** to select a desired Disc Initialize Mode (VR Mode or Video Mode) then press **ENTER**.
 - In case of DVD+RW/DVD-RAM, use **◀ / ▶** to select [OK], and press **ENTER**. It takes a few moments to format the disc.

Caution

If you want to change the disc format, everything recorded on the disc will be erased.

Finalize

Finalizing 'fixes' the recordings in place so that the disc can be played on a regular DVD player or computer equipped with a suitable DVD-ROM drive. Finalizing a Video mode disc creates a menu screen for navigating the disc. This is accessed by pressing LIST/DISC MENU or TITLE.

Caution

Once you have finalized a DVD-R and DVD+R (DL) disc, you cannot edit or record anything else on that disc except DVD+RW. However, you can record and edit a DVD-RW disc by choosing [Unfinalize] option.

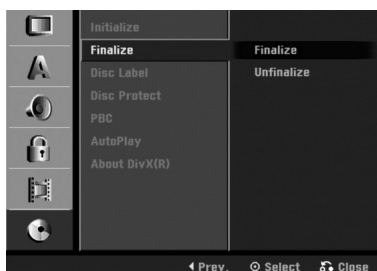

1. Select the [Finalize] option then press ►.
2. Press ENTER while [Finalize] is selected. Finalize menu appears.
3. Select [OK] then press ENTER. The Recorder starts finalizing the disc.

Notes:

- Finalization can take up to 3-4 minutes or more depending on the type of disc, how much is recorded on the disc, and the number of titles on the disc.
- DVD+R DL disc can take up to 30 minutes to finalize.

Tips:

- If you load a DVD-RW that has already been finalized, you can 'Unfinalize' it by choosing [Unfinalize] from the Finalize menu. After doing this, you can edit and re-record onto the disc.
- You cannot unfinalize a DVD-R and DVD+R (DL) disc.
- If [Disc Protect] option is set to [ON], the finalize is not available. To finalize, set [Disc Protect] option to [OFF].

Disc Label

Use the Disc Label feature to enter a name for the disc. This name appears when you load the disc and when you display disc information on-screen.

- The Disc label can be up to 32 characters long.
- For discs formatted on a different Recorder, you will see only a limited character set.

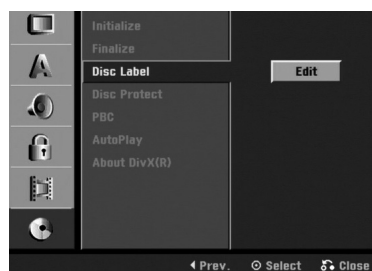

1. Select the [Disc Label] option then press ►. [Edit] icon is highlighted.
2. Press ENTER. Keyboard menu appears. To enter characters, see page 51.

Disc Protect

Depending on the type of disc you are using, Disc Protect allows you to preserve your recordings in a variety of ways:

- DVD+RW : Prevents editing, erasing, or overwriting of existing recordings. Allows regular recording.
- DVD+R : Prevents editing or erasing of existing recordings. Allows regular recording.
- DVD-RW (VR mode)/DVD-RAM : Prevents editing, erasing, and regular recording.

Notes:

- Disc Protect is not compatible with DVD-RW discs in Video mode or DVD-R discs.
- If you need to unlock a disc to make edits, select [OFF].

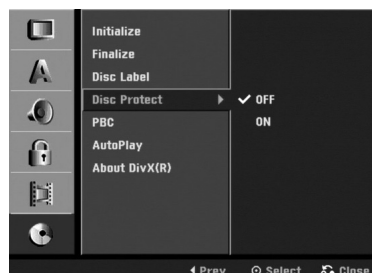

PBC

PBC stands for Playback Control and refers to special menus and navigation features that are available on some Video CDs.

[ON]: Video CDs are played according to the PBC, if available.

[OFF]: Video CDs are played the same way as Audio CDs.

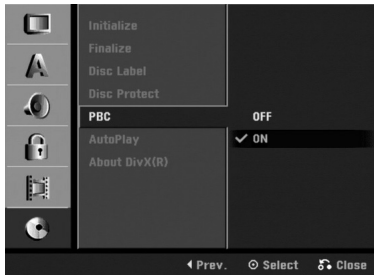

AutoPlay

When you load a DVD with AutoPlay turned on, the Recorder will bypass the Disc menu and trailers and start playing the movie automatically. Set [AutoPlay] to [ON] or [OFF].

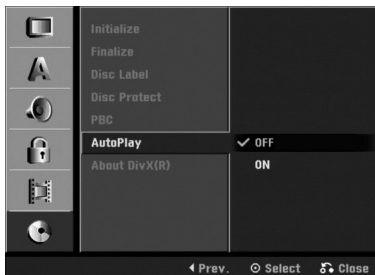

DivX Registration Code **DivX**

We provide you the DivX® VOD (Video On Demand) registration code that allows you to rent and purchase videos using the DivX® VOD service. For more information, visit www.divx.com/vod.

1. Select [About DivX(R)] option then press ►.
2. Press ENTER while [Enter] is selected and the registration code will appear.



3. Use the registration code to purchase or rent the videos from DivX® VOD service at www.divx.com/vod. Follow the instructions and download the video onto a disc for playback on this unit.

Note:

All the downloaded videos from DivX® VOD can only be played back on this unit.

General Explanation of On-Screen Display

Some DVDs require specific operation or allow only limited operation during playback. When this occurs,  is displayed, action prohibited or not available.

Displaying Information While Watching TV

While watching TV, press DISPLAY to display/remove the information displayed on-screen.

e.g., when DVD-RW in VR mode is inserted.

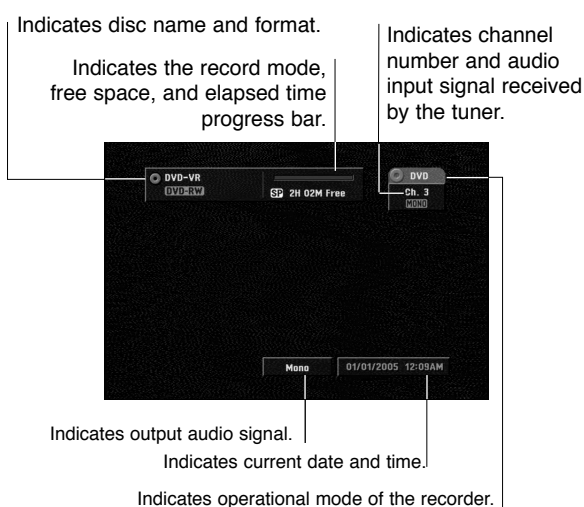

Changing TV Audio Channel

Some TV programs are broadcast with both a main and a Secondary Audio Program (SAP). You can change the TV audio.

Press AUDIO repeatedly to change the TV audio, according to Broadcast audio signal as shown below.

- STEREO+SAP Audio Signal
Stereo → SAP → Mono → Stereo
- STEREO Audio Signal
Stereo → L → R → Mono → Stereo
- SAP Audio Signal
Mono → SAP → Mono
- MONO Audio Signal
Mono

The current audio channel is displayed on-screen.

- If SAP is selected, but there is no SAP channel being broadcast, you will still hear the main audio (Mono or Stereo) channel.
- If the sound is poor quality when set to Stereo, you can often improve it by changing to Mono.
- When an external input is selected, the audio channel can be switched only to Stereo.

Displaying Disc Information on-screen

You can display various information about the disc or tape loaded on-screen. Some items can be changed using the menu.

1. Press DISPLAY once to show current status.



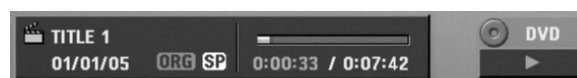

Example: DVD-RW in VR mode



2. Press DISPLAY once again to show various playback information.

The items displayed differ depending on the disc type or playing status.



3. You can select an item by pressing  /  and change or select the setting by pressing  / . For details about each item, see the pages in parentheses.

- [Title]: Current title (or track) number/total number of titles (or tracks) (page 29)
- [Chapter]: Current chapter number/total number of chapters (page 29)
- [Time]: Elapsed playing time (page 30)
- [Audio]: Selected audio language (DVD VIDEO only) or audio channel (page 32)
- [Subtitle]: Selected subtitle (page 31)
- [Angle]: Selected angle/total number of angles (page 31)
- [Sound]: Selected sound mode (page 32)

Note:





If no button is pressed for 7 seconds, the on-screen display disappears.

Playback

VCR Tape Playback

Press **VCR** button to select the device to be operated.

Basic Instructions

1. Insert a pre-recorded video cassette.
The  indicator lights and the Recorder powers on automatically.
2. If the  (TIMER) indicator in the display window is lit press **POWER** once.
3. If a tape without a safety tab is inserted the unit starts playback automatically.
If not, press  (**PLAY**).
4. Press **STOP** () to stop playback. **STOP** appears on the TV screen. If the tape reaches the end before you press **STOP** () the Recorder automatically stops, rewinds and ejects the tape.

Note:





It is not necessary to select the tape speed for playback because it is automatically selected by the Recorder. Also, during playback the TV/VCR selector switches to VCR mode automatically.

Auto Tracking

Automatic tracking adjusts the picture to remove snow or streaks and beings when:

- A tape is played for the first time.
- The tape speed (SP, LP, SLP) changes.
- Streaks or snow appear due to scratches on the tape.

Manual Tracking

To manually adjust the tracking use the **CH/TRK** () () buttons on the Remote Control or **CH** () () on the front panel during playback.



Notes:

- Vertical jitter requires a very fine adjustment.
- Tracking is automatically reset to normal when the tape is ejected or the power cord is unplugged for more than 3 seconds.

Search

This function lets you visually search for a tape section in either direction: forward and reverse. During the high-speed picture search modes, the audio is muted and horizontal lines (noise bars) appear. Also, a short time is needed to stabilize the tape speed when re-entering the **PLAY** mode so slight interference may be observed during this time.





To search:

1. Press **BACKWARD** () or **FORWARD** () during playback.
2. To return to playback, press  (**PLAY**).

Note:

After 3 minutes in **SEARCH** mode the Recorder returns to **PLAY** mode to protect the tape and video heads.

Still Picture and Frame-by-Frame Playback





1. Press **PAUSE/STEP** () during playback.
A still picture appears on the TV screen and the audio is muted.
2. If the still picture vibrates vertically, stabilize it by using **CH/TRK** () () on the Remote Control.
3. Press **PAUSE/STEP** () repeatedly to advance the video picture one frame at a time.
4. To return to playback, press  (**PLAY**).

Note:

After 5 minutes in **STILL** mode the Recorder stops to protect the tape and video heads.

Slow Motion

During slow motion, audio is muted and horizontal lines (noise bars) may appear on the TV screen. This is normal.

1. While in still mode, press **FORWARD** (). The tape is played at a speed 1/19 times slower than the normal speed.
2. Use **CH/TRK** () () on the Remote Control if necessary to adjust the tracking.
3. To return to the normal speed, press  (**PLAY**).

Note:

After 3 minutes in **SLOW MOTION** mode the Recorder goes back to **PLAY** mode to protect the tape and video heads.

Counter Memory Function

This feature is useful if there is a section of tape you want to view immediately after recording or if you want to return to the same point several times.

1. Begin recording or playing a tape.
2. Press DISPLAY until the real-time counter is displayed on the TV screen.
3. At the point that you want to locate later, reset the real-time counter to [0:00:00] by pressing CLEAR.
4. Continue to play or record.
5. Press STOP (■) when recording or playback finishes.
6. Press RETURN (↶). The tape automatically stops when the tape counter returns to about [0:00:00].

S-VHS Quasi Playback (SQPB)

- This Recorder can play back S-VHS recorded tapes, however, it cannot make recordings using S-VHS format tapes.
- SQPB is an abbreviation for S-VHS Quasi Playback.

Playing a DVD or Video CD

Playback Setup

1. Press OPEN/CLOSE (▲) to open the disc tray. Load your chosen disc in the tray, with the playback side down.
2. Press OPEN/CLOSE (▲) to close the tray. Playback starts automatically. If playback does not start, press ► (PLAY).

In some cases, the disc menu might appear instead.

DVD

Use the ◀ ▶ ▲ ▼ buttons to select the title/chapter you want to view, then press ENTER to start. Press TITLE or LIST/DISC MENU to return to the menu screen.

VCD

Use the number buttons to select the track you want to view and press RETURN to return to the menu screen. Menu settings and operating procedures may differ. Follow the instructions on each menu screen. You may also set PBC to [OFF] (See page 26).

3. To stop the playback, press STOP (■). The unit records the stopped point, depending on the disc. "II■" appears on the screen briefly. Press ► (PLAY) to resume playback (from the scene point). If you press STOP (■) again or unload the disc ("■" appears on the screen.), the unit will clear the stopped point. Press OPEN/CLOSE (▲) to remove the disc. Press OPEN/CLOSE (▲) to close disc tray or press POWER (⏻), the disc tray closes automatically and unit turns off.

Notes:

- If parental control is set and the disc is not within the rating settings you must input the password. (See [Rating] on page 23).
- DVDs may have a region code. Your Recorder will not play discs that have a region code different from your Recorder. The region code for this player is 1 (one).
- Unless stated otherwise, all operations described use the Remote Control. Some features may also be available on the Setup menu.

Moving to another TITLE **-RW_{VR}** **-RW_{Video}** **RAM** **+RW** **-R** **+R** **DVD** **DivX**

When a disc has more than one title, you can move to another title:

Press DISPLAY twice then use ▲ / ▼ to select the title icon. Then, press the appropriate numbered button (0-9) or ◀ / ▶ to select a title number.

Moving to another CHAPTER / TRACK

-RW_{VR} **-RW_{Video}** **RAM** **+RW** **-R** **+R** **DVD** **VCD**

When a title on a disc has more than one chapter or a disc has more than one track, you can move to another chapter/track as follows:

- Press SKIP (▶▶) or (◀◀) briefly during playback to select the next chapter/track or to return to the beginning of the current chapter/track.
- Press SKIP (◀◀) twice in quick successions to step back to the previous chapter/track.
- To go directly to any chapter/track during playback, press DISPLAY twice and use ▲ / ▼ to select the chapter or track (for Video CD) icon. Input the chapter/track number or use ◀ / ▶.

Note:

On a Video CD with PBC, you must set PBC to [OFF] in the Setup menu to use this function (See page 26).

Slow Motion **-RW_{VR}** **-RW_{Video}** **RAM** **+RW**
-R **+R** **DVD** **VCD**

1. Press BACKWARD (◀◀) or FORWARD (▶▶) during pause mode.
2. Use the BACKWARD (◀◀) or FORWARD (▶▶) to select the required speed:
DVD : 4 steps (forward and backward)
Video CD: 3 steps (forward only).
3. To exit Slow Motion mode, press ▶ (PLAY).

Search **-RW_{VR}** **-RW_{Video}** **RAM** **+RW** **-R**
+R **DVD** **VCD**

1. Press BACKWARD (◀◀) or FORWARD (▶▶) during playback.
2. Press BACKWARD (◀◀) or FORWARD (▶▶) to select the required speed (forward and backward):
DVD ; 5 steps
Video CD ; 3 steps
3. To exit SEARCH mode, press ▶ (PLAY).

Time Search **-RW_{VR}** **-RW_{Video}** **RAM** **+RW**
-R **+R** **DVD** **DivX**

To start playing at any chosen time on the disc:

1. Press DISPLAY twice during playback. The time search box shows the elapsed playing time.
2. Press ▲ / ▼ to select the time clock icon and [:-:--:] appears.
3. Input the required start time in hours, minutes, and seconds from left to right. If you enter the wrong numbers, press ◀ / ▶ to move the under bar () to the wrong number. Then enter the correct numbers.
4. Press ENTER to confirm. Playback starts from the selected time.

Marker Search **-RW_{VR}** **-RW_{Video}** **RAM** **+RW**
-R **+R** **DVD** **VCD**

To enter a Marker

You can start playback from up to six memorized points. To enter a marker, press MARKER at the desired point on the disc. The Marker icon appears on the TV screen briefly. Repeat to enter up to six markers.

To Recall or Clear a Marked Scene

1. During disc playback, press SEARCH.
The marker search menu appears on the screen.

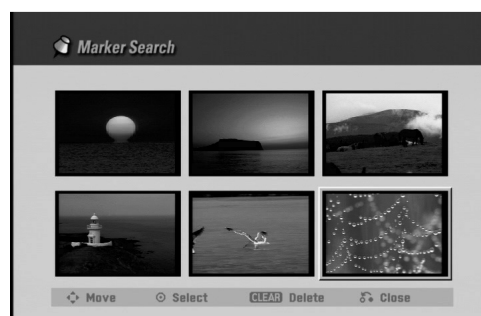

2. Use ◀/▶/▲/▼ to select a marker scene that you want to recall or clear.
3. Press ENTER and playback starts from the marked scene. Or, Press CLEAR and use ◀ / ▶ to select [Yes] then press ENTER to delete marked scene from the list.
4. To remove the Marker Search menu, press RETURN (↵)

Random Karaoke DVD **VCD**

1. Press RANDOM during playback.
The unit automatically begins Random Playback and [RANDOM] appears on the TV screen.
2. Press RANDOM again to normal.

Tip:

By pressing SKIP (▶▶) during Random playback, the Recorder selects another title (track) and resumes Random playback.

Notes:

- This function only works with DVD Karaoke discs or video CDs without PBC.
- On a Video CD with PBC, you must set PBC to [OFF] in the setup menu to use this function. See page 26.

Still Picture and Frame-by-Frame Playback

-RW_{VR} -RW_{Video} RAM +RW -R +R
DVD VCD

1. Press PAUSE/STEP (II) during playback. Advance the picture frame-by-frame by pressing PAUSE/STEP (II) repeatedly.
2. To exit still motion mode, press ► (PLAY).

Tips:

- You can advance or back up the picture frame-by-frame by pressing ◀ / ▶ repeatedly during PAUSE mode.
- The picture frame-by-frame in reverse is not available for Video CD.

Zoom

-RW_{VR} -RW_{Video} RAM +RW -R +R
DVD

Use zoom to enlarge the video image.

1. Press ZOOM during playback or still playback to activate the Zoom function.
2. Each press of the ZOOM button changes the TV screen in the sequence: X1 (normal size) → X2 size → X4 size → X1 (normal size)
3. Use the ◀ ▶ ▲ ▼ buttons to move through the zoomed picture.
4. To resume normal playback, press ZOOM repeatedly or CLEAR button.

Note:

The Zoom function may not work on some DVDs.

Repeat

-RW_{VR} -RW_{Video} RAM +RW -R +R
DVD VCD

Press REPEAT to select a desired repeat mode.

- [CHAPTER] repeats the current chapter. (DVD only)
- [TITLE] repeats the current title. (DVD only)
- [All] repeats the all titles/tracks. (Video CD, DVD-RAM or VR mode DVD-RW only).
- [TRACK]: repeats the current track. (Video CD only)
- [OFF] does not play repeatedly.

Note:

On a Video CD with PBC, you must set PBC to [OFF] on the setup menu to use this function (See page 26).

Repeat A-B

-RW_{VR} -RW_{Video} RAM +RW -R +R
DVD VCD

To repeat a sequence during playback.

1. Press A-B at your chosen starting point. [REPEAT A -] appears briefly on the TV screen.
2. Press A-B again at your chosen end point. [REPEAT A - B] appears briefly on the TV screen and the repeat sequence begins.
3. Press A-B again to cancel.

Title Menu DVD

1. Press TITLE. If the current title has a menu, the menu appears on the screen. Otherwise, the disc menu may not appear.
2. The menu offers features such as camera angles, spoken language and subtitle options, and chapters for the title.

Disc Menu DVD

1. Press LIST/DISC MENU and the disc menu is displayed.
2. Press LIST/DISC MENU again to exit.

Camera Angle DVD

If the disc contains scenes recorded at different camera angles, you can change to a different camera angle during playback. Press ANGLE then press ◀ / ▶ repeatedly during playback to select a desired angle. Note that the number of the current angle appears on the display.

Tip:

The Camera Angle icon is displayed on the TV screen when alternate angles are available.

Subtitles DVD DivX

Press SUBTITLE then press ◀ / ▶ repeatedly during playback to see the different subtitle languages.

Changing the Audio Soundtrack **DVD**

Press AUDIO then press ◀ / ▶ repeatedly during playback to hear a different audio language or audio soundtrack if available.

Note:

Some discs feature both Dolby Digital and DTS soundtracks. There is no analog audio output when DTS is selected. To listen to the DTS soundtrack, connect this recorder to a DTS decoder via one of the digital outputs. See page 17 for connection details.

Changing the Audio Channel

-RW_{VR} **-RW_{Video}** **RAM** **+RW** **-R** **+R**
VCD

Press AUDIO then press ◀ / ▶ repeatedly during playback to hear a different audio channel. With DVD-RW discs recorded in VR mode that have both a main and a Bilingual audio channel, you can switch between Main (L), Bilingual (R), or a mix of both (Main + Bilingual) by pressing AUDIO.

3D Surround

-RW_{VR} **-RW_{Video}** **RAM** **+RW** **-R** **+R**
DVD **VCD** **DivX**

This unit can produce a 3D Surround effect, which simulates multi-channel audio playback from two conventional stereo speakers, instead of the five or more speakers normally required to listen to multi-channel audio from a home theater system.

1. Press DISPLAY twice then use ▲ / ▼ to select the sound icon. Then, use ◀ / ▶ to select [3D SUR.].
2. To turn off the 3D Surround effect, select [NORMAL].

Last Scene Memory **DVD**

This Recorder memorizes last scene from the last disc that is viewed. The last scene remains in memory even if you remove the disc from the Recorder or switch off the Recorder. If you load a disc that has the scene memorized, the scene is automatically recalled.

Notes:

- Settings are stored in memory for use any time.
- This Recorder does not memorize settings of a disc if you switch off the Recorder before commencing to play it.
- The Last Scene Memory function may not work on some DVDs.
- Last Scene Memory function for a previous DVD title is erased once a different DVD title is played.

Finding Locations on a Disc **VCD**

You can directly access any point on a video CD using this function within 95% of progress bar. Use this function only while a video CD is playing. Playback jumps to the point specified.

1. Press SEARCH during playback. The progress bar appears on the TV screen.
2. Use ◀ / ▶ to find the desired starting position for playback.
3. Press ENTER to confirm the selected position. Playback starts from the selected position.

Notes:

This function will not work if any bookmarks have been set; see page 30.

Playing a DivX Movie File

The Recorder can play Divx files on CD-R/RW or DVD±R/RW discs. Before playing DivX files, read "About DivX movie files" on page 34.

1. Use ▲ / ▼ to select a folder, and press ENTER twice.
A list of files in the folder appears.
2. Use ▲ / ▼ to select a file then press ► (PLAY).
Playback starts.
You can use variable playback functions. Refer to pages 29-32.



3. Press STOP (■) to stop the playback. The Movie menu appears.

Note:

This recorder cannot play back the DivX file(s) in the Memory card.

Notice for displaying the DivX subtitle

Please refer to following notice when the DivX subtitle does not display properly.

1. Press SETUP.
The Setup menu appears.
2. Use ▲ / ▼ / ◀ / ▶ to select [LANGUAGE] → [Disc Subtitle] then find a suitable language for the DivX subtitle.
Refer to [Disc Menu/Audio/Subtitle] on page 21.

Tip:

If the subtitle still does not display properly after the steps 1-2 proceeded, press and hold SUBTITLE about 3 seconds then use ◀ / ▶ to select another language code during playback until the subtitle is displayed properly.

Movie menu options

1. Press ▲ / ▼ to select a folder/file on the Movie menu then press ENTER.
Movie menu options appear.



2. Press ▲ / ▼ to select an option, and press ENTER.
 - **[Play]** Start playback the selected title.
 - **[Open]** Opens the folder and a list of files in the folder appears.
 - **[Dubbing]** Dubs the DivX movie to VCR. (page 44)

About DivX movie files

DivX disc compatibility with this recorder is limited as follows:

- Available resolution size of the DivX file is under 720x576 (W x H) pixel.
- The file name of the DivX subtitle is limited to characters.
- If there is impossible code to express in the DivX file, it may be displayed as “_” mark on the display.
- The total number of files and folders on the disc are free but the total number of files and folders on the folder should be less than 1999.
- **If the number of the screen frame is over 29.97 frames per second, this unit may not operate normally.**
- **If the video and audio structure of recorded file is not interleaved, returns to the menu screen.**
- **If the file is recorded with GMC, the unit supports only 1-point of the record level.**
 - * GMC?
GMC is the acronym for Global Motion Compensation. It is an encoding tool specified in MPEG4 standard. Some MPEG4 encoders, like DivX or Xvid, have this option.
There are different levels of GMC encoding, usually called 1-point, 2-point, or 3-point GMC.

Playable DivX file

“.avi”, “.divx”

Playable DivX subtitle

“.smi”, “.srt (SubRip only)”

“.sub (Micro DVD format only)”

- DivX subtitle except those listed above is not displayed on the TV screen.

Playable Codec format

“DIV3”, “DIV4”, “MP43”, “DIVX”, “XVID”, “DX50”, “DXSB”.

Playable Audio format

“AC3”, “PCM”, “MP2”, “MP3”, “WMA”, “DTS”.

- Sampling frequency: within 8 - 48 kHz (MP3), within 32 - 48kHz (WMA)
- Bit rate: within 8 - 320kbps (MP3), 32 - 192kbps (WMA)

Playing an Audio CD or MP3/WMA files

The Recorder can play Audio CDs and MP3/WMA files on CD-ROM, CD-R/RW, DVD+R/RW, DVD-R/RW, DVD-RAM discs or Memory Card. Before playing MP3/WMA files, read [Notes on MP3/WMA Recordings] on page 36.

Audio CD

Once you insert an audio CD a menu appears on the TV screen. Use ▲ / ▼ to select a track then press ► (PLAY) and playback starts.



MP3 / WMA

- Use ▲ / ▼ to select a folder, and press ENTER twice. A list of files in the folder appears.
- Use ▲ / ▼ to select a track then press ► (PLAY) and Playback starts.

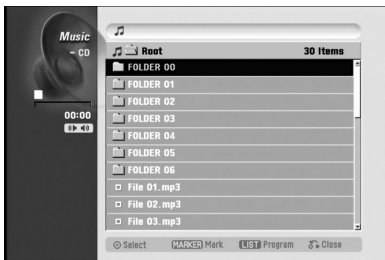

Tips:

- You can view TV channel or video input source by pressing RETURN (↵). If you want to return to the Music menu, press LIST/DISC MENU.
- Press DISPLAY to view ID3-Tag information for the MP3 file. If ID3-Tag information is not present, [MP3 ID3 tag :None] will appear. If you select a folder, the number of subfolders and number of MP3/WMA files in the folder are displayed. Press DISPLAY again to remove the information screen.
- On the Music menu, you can display the folders on the disc. Use ▲▼◀▶ to select the "Folder" icon on the Music menu then press ENTER twice.
- On CDs, DVDs or Memory Card with mixed content (Audio tracks, MP3/WMA files, DivX files or JPEG files), you can select among the Music menu, Movie menu and Photo menu by pressing TITLE repeatedly.
- If you are in a file list and want to return to the Folder list, use the ▲/▼ to highlight [Folder icon] and press ENTER to return to the previous menu screen.

Audio CD and Music menu options

- Press ▲ / ▼ to select a track/file or folder on the Audio CD or Music menu then press ENTER.



- Use ▲ / ▼ to select an option, then press ENTER.
 - [Play]** Start playback the selected track or file.
 - [Open]** Opens the folder and a list of files in the folder appears.
 - [Program Add]** Adds the track(s)/file(s) or folder(s) to Program List. (page 37)
 - [Delete]** Deletes the file(s) or folder(s) from the Memory Card.

Audio CD and MP3/WMA file Features

Pause

- Press PAUSE/STEP (⏸) during playback.
- To return to playback, press ► (PLAY) or press PAUSE/STEP (⏸) again.

Moving to another Track

- Press SKIP (⏭ or ⏮) briefly during playback to go to the next track or to return to the beginning of the current track.
- Press SKIP (⏮) twice in quick successions to go back to the previous track.
- On an Audio CD, to go directly to any track, enter the track number using the numbered buttons (0-9) during playback.

Repeat

Press REPEAT to select a desired repeat mode.

- [TRACK]: Repeats the current track.
- [ALL] (CD): Repeats all the tracks on a disc.
- [FOLDER] (MP3/WMA): Repeats all the tracks on a folder of a disc.
- [OFF](No display): Does not play repeatedly.

Changing the Audio Channel

Press AUDIO repeatedly to hear a different audio channel (stereo, left or right).

Random

1. Press RANDOM during playback or in stop mode. Random Playback begins immediately and [RANDOM] appears on the menu screen.
2. To return to normal playback, press RANDOM repeatedly until [RANDOM] disappears from the menu screen.

Tip:

By pressing SKIP (◀◀ or ▶▶) during random playback, the unit selects another track and resumes random playback.

Repeat A-B **ACD**

1. To repeat a sequence during disc playback. Press A-B at your chosen starting point. The Repeat icon and [A -] appear on the menu screen.
2. Press A-B again at your chosen end point. The Repeat icon and [A-B] appear on the menu screen, and the sequence begins to play repeatedly.
3. Press A-B again to cancel.

Search **ACD**

1. Press BACKWARD (◀◀) or FORWARD (▶▶) during playback.
2. Press BACKWARD (◀◀) or FORWARD (▶▶) to select the required speed (3steps).
3. To exit SEARCH mode, press ▶ (PLAY).

Notes on MP3/WMA Recordings

MP3/WMA disc compatibility with this unit is limited as follows:

- Sampling frequency: within 8 - 48 kHz (MP3), within 32 - 48 kHz (WMA)
- Bit rate: within 8 - 320 kbps (MP3), 32 - 192 kbps (WMA)
- This unit cannot read an MP3/WMA file that has a file extension other than “.mp3” / “.wma”.
- CD-R physical format should be “ISO 9660” and “JOLIET”.
- DVD±R/RW physical format should be “ISO 9660 (UDF Bridge format)”.
- If you record MP3 / WMA files using software that cannot create a file system (eg. Direct-CD) it is impossible to playback MP3 / WMA files. We recommend that you use Easy-CD Creator, which creates an ISO 9660 file system.
- The total number of files and folders on the disc are free but the total number of files and folders on the folder should be less than 1999.

This unit requires discs and recordings to meet certain technical standards in order to achieve optimal playback quality. Pre-recorded DVDs are automatically set to these standards. There are many different types of recordable disc formats (including CD-R containing MP3 or WMA files) and these require certain pre-existing conditions (see above) to ensure compatible playback.

Customers should note that permission is required in order to download MP3 / WMA files and music from the Internet. Our company has no right to grant such permission. Permission should always be sought from the copyright owner.

Program Playback with Audio CD and MP3/WMA files

The program function enables you to store your favourite tracks from any disc in the player memory. Program can contain 99 tracks (Audio CD) or 256 tracks (MP3/WMA).

1. Use ▲ / ▼ to select a track/file or folder on the List then press ENTER.
2. Use ▲ / ▼ to select [Program Add] option then press ENTER.
3. Repeat steps 1-2 to place additional tracks on the Program list.



4. **Audio CD** : Use ► to move to the Program list. The programmed track you selected last is highlighted on the program list.
MP3/WMA : Go to next step.
5. Use ▲ / ▼ to select the track or file you want to start playing.
6. Press ► (PLAY) to start. Playback begins in the order in which you programmed the tracks and [PRG] indicator appears on the display window. Playback stops after playing the last programmed track on the program list.

Tips:

- Use the CLEAR button to select all tracks/files and folders, or cancel all marked tracks/files and folders.
- Selecting multiple tracks/files or folders.
 1. Press **MARKER**.
A check mark appears on the track/file or folder. Press **MARKER** again to cancel the marked track/file or folder.
 2. Repeat step 1 to mark additional track/file (folders).
- If you select folder for Programmed Playback, all tracks in the folder are added to the program list.
- You can access or remove the Program List screen by pressing LIST/DISC MENU.

Program List menu options

1. Press ▲ / ▼ to select a track/file on the Program List then press ENTER. The menu options appear.



2. Use ▲ / ▼ to select an option then press ENTER to confirm your selection.
 - **[Play]** Playback begins in the order in which you programmed the tracks from the selected track.
 - **[Move]** Moves the track(s) to change the program order.
 - **[Delete]** Deletes the track(s) from the Program List menu.

Repeat Programmed Tracks

Press REPEAT to select the desired Repeat mode.

- [TRACK] Repeats the current track.
- [ALL] Repeats all tracks on the Program List.
- [OFF] Cancels Repeat mode (no display).

Erasing a Track from the Program List

1. Select the track you wish to erase from the Program List. Use **MARKER** button to select multiple tracks.
2. Press ENTER. The menu options appears.
3. Select [Delete] option then press ENTER.

Changing Track Order in the Program List

1. Select the track you wish to move on the Program List. Use **MARKER** button to select multiple tracks.
2. Press ENTER. The menu options appears
3. Select [Move] option then press ENTER.
4. Use ▲ / ▼ to move the yellow bar to the desired location, then press ENTER.

Viewing a JPEG files

This unit can play JPEG files on CD-R/RW, DVD+R/RW, DVD-R/RW, DVD-RAM discs or Memory Card. Before playing JPEG recordings, read "About JPEG image files" on page 39.

1. Use ▲▼◀▶ to select a file or folder and press ENTER.



2. Use ▲ / ▼ to select option and press ENTER.

Example: When you select a file.

3. Use ▲ / ▼ to select [Full Screen] then press ENTER.
The selected image is displayed in full screen.



Press ENTER to appear or disappear this menu.

4. To stop viewing at any time, press STOP.

Notes:

- If the icon displays in the Photo menu, it means you cannot see those JPEG files.
- You can view TV channel or video input source by pressing RETURN (↵). If you want to return to the Photo menu, press LIST/DISC MENU.
- If you are in a file list and want to return to the Folder list, use the ▲/▼ to highlight and press ENTER to return to the previous menu screen.
- On CDs, DVDs or Memory Card with mixed content (Audio tracks, MP3/WMA files, DivX files or JPEG files), you can select among the Music menu, Movie menu and Photo menu by pressing TITLE repeatedly.

Photo menu options

1. Use ▲▼◀▶ to select a file then press ENTER. The menu options appear.



2. Use ▲ / ▼ to select an option then press ENTER to confirm your selection.
 - **[Open]** Opens the folder and a list of files in the folder appears.
 - **[Full Screen]** Shows the selected file as full screen.
 - **[Slide Show]** Displays Slide Show menu.
 - **[Delete]** Deletes the selected file(s) or folder(s) from the Memory Card.
 - **[Copy]** Copies the file(s) or folder to Memory Card.

Tip:

You can create new folder in the Memory Card. Select [New Album] option then press ENTER. [NONAME##] folder is created.

Still picture

Use PAUSE/STEP (⏸) while showing a picture to pause mode.

Skip Images

While viewing a picture, press SKIP (▶▶ or ◀◀) once to advance to the next file or return to the previous file.

Rotate Images

Use ▲ / ▼ while viewing a picture to flip the picture clockwise or counterclockwise.

View Slide Shows

1. Select [Slide Show] option on the Photo menu.
2. Press ENTER.

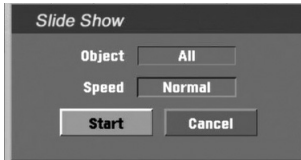

3. Use ◀ / ▶ / ▲ / ▼ to set the options.
[Object] option:
 - [Selected] Views slide show only selected files.
 - [All] Views slide show all files.**[Speed]** option:
Sets the Slide Show speed to [Normal], [Slow], or [Fast].
4. Select the [Start] option then press ENTER to start the Slide Show.
5. Press STOP (■) to stop the Slide Show and returns to the Photo menu.

Tips:

- Use the CLEAR button to select all files, or cancel all marked files.
- Selecting multiple files
 1. Press **MARKER**.
A check mark appears on the file. Press **MARKER** again to cancel the marked file.
 2. Repeat step 1 to mark additional file.

About JPEG image files

JPEG disc compatibility with this recorder is limited as follows:

- Depending upon the size and number of JPEG files, it could take a long time for the recorder to read the files. If you don't see an on-screen display after several minutes, some of the files may be too large — reduce the resolution of the JPEG files to less than 4M pixels.
- The total number of files and folders on the disc are free but the total number of files and folders on the folder should be less than 1999.
- Some discs may be incompatible due to a different recording format or the condition of disc.
- Ensure that all the selected files have the “.jpg” extensions when copying into the CD layout.
- If the files have “.jpe” or “.jpeg” extensions, please rename them as “.jpg” file.
- File names without “.jpg” extension will not be able to be read by this recorder. Even though the files are shown as JPEG image files in Windows Explorer.
- Progressive and lossless compression JPEG image files are not supported.

Recording

About DVD recording

Notes:

- This Recorder cannot record CD-R or CD-RW discs.
- Fingerprints and small scratches on a disc can affect playback and/or recording performance. Please take proper care of your discs.
- The company does not hold any responsibility to compensate the contents which should have been recorded, and any losses or damages (e.g. losses of business profit, or business intermission) that may arise from malfunction of this recorder (not recording/editing as intended).

Disc types and recording formats, modes, and settings

This recorder can play many different kinds of DVD discs: pre-recorded DVD-Video discs, DVD-RW, DVD-R, DVD+RW, DVD+R(DL) and DVD-RAM discs.

The disc format for DVD-R, DVD+R(DL), DVD+RW discs is always "Video format"—the same as pre-recorded DVD-Video discs. This means that once finalized, you can play a DVD-R, DVD+R (DL), or DVD+RW in a regular DVD player. The DVD-RAM disc format is Video Recording (VR) format.

The DVD-RW disc format is Video Recording (VR) format or Video format. You can change Recording format, if required. (Reinitializing the disc will erase the contents of the disc.)

The recording mode is closely related to the disc format. If the disc format is Video Recording format, then the recording mode is VR mode; if the disc format is Video format, then the recording mode is Video mode (except for DVD-Video, which is not recordable, and so does not have a recording mode). These can be changed as required for each recording and determine the picture quality and how much space the recording will take up on the disc.

Notes for recording

- The recording times shown are not exact because the recorder uses variable bit-rate video compression. This means that the exact recording time will depend on the material being recorded.
- When recording a TV broadcast, if the reception is poor or the picture contains interference, the recording times may be shorter.
- If you record still pictures or audio only, the recording time may be longer.
- The displayed times for recording and time remaining may not always add up to exactly the length of the disc.
- The recording time available may decrease if you heavily edit a disc.
- If using a DVD-RW disc, make sure you change the recording format (Video mode or VR mode) before you record anything on the disc. See page 24 (Initialize) for how to do this.
- When using a DVD-R or DVD+R disc, you can keep recording until the disc is full, or until you finalize the disc. Before you start a recording session, check the amount of recording time left on the disc.
- When using a DVD-RW disc in Video mode, recording time available will only increase if you erase the last title recorded on the disc.
- The Delete Title option in the Title List (Original) menu only hides the title, it does not actually erase the title from the disc and increase the recording time available (except for the last recorded title on a DVD-RW disc in Video mode).
- Overwrite recording is available using DVD+RW discs.
- When using a DVD+R/RW, the recorder will execute the Menu-making operation to update the new title and editing when removing the disc from the recorder.

Basic Recording from a TV

Follow the instructions below to record a TV program. Recording starts immediately and continues until the disc or tape is full or you stop the recording.

1. Switch on the Recorder, select the device (VCR or DVD) for Recording and load a recordable disc or tape. Also make sure that the TV input is set to this recorder.
2. Set a recording mode as necessary by pressing REC MODE repeatedly.
DVD: XP, SP, LP, EP.
VCR: SP, SLP.
3. Select the TV channel to record.
4. Use AUDIO to select the audio channel to record. The table below shows what will be recorded on the different settings for different types of broadcast. The last column (Monitor Audio) shows what you'll hear as it is recording.

TV Broadcast	Selected Audio	Broadcast Audio		Monitor Audio
		L Ch	R Ch	
MONO	MONO	MONO	MONO	MONO
STEREO	STEREO	L	R	STEREO
	Left	L	L	Left
	Right	R	R	Right
	MONO	MONO	MONO	MONO
MONO+SAP	MONO	MONO	MONO	MONO
	SAP	SAP	SAP	SAP
STEREO +SAP	STEREO	L	R	STEREO
	SAP	SAP	SAP	SAP
	MONO	MONO	MONO	MONO

If you set the audio channel to SAP, but there is no SAP channel being broadcast, the main audio (mono or stereo) will be recorded.

5. Press ● REC once to start recording. The REC indicator lights in the display window.
6. Press STOP (■) to stop recording.

Notes:

- The maximum numbers of DVD titles are as show below;
- DVD-R/RW, DVD-RAM : 99
- DVD+R(DL)/RW : 49
- If the Recorder is powered off during DVD recording, the recording will not be saved.

Instant Timer Recording

Instant Timer Recording allows you to make a recording easily of a preset length without using the program timer.

1. Follow steps 1-4 as shown left (Basic Recording from a TV).
2. Press ● REC repeatedly to select the recording time length. Recording starts after the first press.
DVD: Each subsequent press increases the recording time by 10 minutes.
VCR: Each subsequent press increases the recording time by 30 minutes (maximum 540 minutes). Please confirm the VHS tape has enough remaining time to be recorded before recording.



Instant Timer Record Menu

Checking the Recording Time

Press ● REC or DISPLAY once to check the recording time. The recalled setting will automatically return to the TV screen for a moment. Also, remaining time of recording is shown in the display window.

To Extend the Recording Time

The recording time can be extended anytime by pressing ● REC. Each subsequent press increases the recording time by 10 minutes (DVD) or 30 minutes (VCR).

To Pause the Recording

1. Press PAUSE/STEP (||) to pause the recording.
2. When you want to continue recording, press PAUSE/STEP (||) or ● REC.

Notes:

- If you press PAUSE/STEP (||) during the Instant Timer Recording, it will be canceled.
- The Recorder will automatically power off when the Instant Timer Recording ends.
- If the unit is DVD mode when the VCR Instant timer recording ends, the unit will not automatically power off.

To record one TV program while watching another

1. Press TV/VCR to select the TV mode during recording. The TV indicator appears.
2. Using the TV, select the channel to be viewed.

Tip (VCR mode only)

Always use PAUSE/STEP (■) for best results when making changes during recording.

For example: To change channels during recording, first press PAUSE/STEP (■) to put the unit in pause mode. Then select the desired channel on the Recorder, and press PAUSE/STEP (■) again to resume recording.

Timer Recording

The Timer Recording function allows you to record up to 8 programs within a period of one month.

1. Press TIMER REC.
The Timer Record menu will appear.

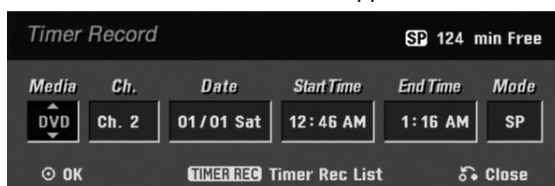

- [Media] – Choose a media (DVD or VCR).
 - [Ch.] – Choose a channel (2-69 or 1-125 for antenna or cable channels respectively, excluding skip channels), or one of the external inputs from which to record (AV1 or AV2).
 - [Date] – Choose a date up to 1 month in advance, or select a daily or weekly program.
 - [Start Time] – Set the recording start time.
 - [End Time] – Set the recording end time.
 - [Mode] – Choose a record mode.
DVD: EP, LP, SP, XP, or AT (Auto)
VCR: SP, SLP, or AT (Auto)
AT(Auto) mode determines how much time is available on the disc or tape and switches record mode, if necessary, to complete recording the program.
2. Enter the necessary information for your timer recording(s).
 - ◀ / ▶ (left/right) – Move the cursor left/right
 - ▲ / ▼ (up/down) – Change the setting at the current cursor position
 - Press RETURN (↵) to exit the Timer Record menu.
 - Press TIMER REC to display Timer Record List.

3. Press ENTER to save the program.
The Timer Record List will appear.
4. Press RETURN (↵) to exit the Timer Record List.

Notes:

- The Timer indicator lights on the front panel display.
- If the Disc and Tape indicator are blinking, either no disc or tape is loaded, or the loaded disc is not recordable.
- The Recorder will record the audio according to the current TV tuner setting (Stereo, Mono or SAP). Use the AUDIO button to set the audio before switching the Recorder to Standby mode.
- The Recorder will automatically power off when the Timer Recording ends.
- If the unit is DVD mode when the VCR timer recording ends, the unit will not automatically power off.
- There is a short delay when a timer recording finishes to confirm the recorded program. If two timer recordings are set to record sequentially (one right after the other), the very beginning of the later program may not be recorded.
- You must press STOP (■) to stop the Timer Recording.

Checking Timer Recording Details

Programming can be checked whenever the Recorder is turned on. Press TIMER REC twice.

- Use ▲ / ▼ to select a timer recording.
- Press ENTER to edit the selected program.
Timer Record menu appears.



Canceling a Timer Recording

You can clear a timer setting anytime before the recording actually starts.

- Use ▲ / ▼ to select a program you want to erase on the Timer Recorder List, then press CLEAR and select [Yes] than press ENTER.

Timer Recording Troubleshooting

Even though the timer is set, the recorder will not record when:

- There is no disc (or tape) loaded.
- A non-recordable disc (or tape) is loaded.
- Disc Protect is set to ON in the Disc menu (see page 26).
- There are already 99 titles (DVD-RW, DVD-R, DVD-RAM), 49 titles (DVD+RW, DVD+R(DL)) recorded on the disc.

You cannot enter a timer program when:

- A recording is already underway.
- The time you're trying to set has already passed.
- There are already 8 timer programs set.

If two or more timer programs overlap:

- The earlier program takes priority.
- When the earlier program finishes, the later program starts.
- If two programs are set to start at exactly the same time, the program entered first takes priority.

If the disc is damaged, the recording may not complete successfully. In this case even though the Check field shows [Rec. OK], it may not be.

Playing while you are recording **RAM**

You can start play from the beginning of the title while continuing to record it.

While recording (in DVD mode)

1. Press ► (PLAY).
Start play of the title you are recording.
2. Press STOP (■) to return to the current recording screen.



or

1. Press TIMESHIFT.
The PIP(Picture-In-Picture) window appears on the screen as shown below. What is currently being recorded appears as a PIP and you will hear the playback audio.



2. Press STOP (■) to return to the current recording screen.

Notes:

- Play cannot be started until at least 30 seconds after recording starts.
- This function does not work in VCR Recording mode.

Dubbing from DVD to VCR

You can copy the contents of a DVD to a VHS tape using the DUBBING (or DUB) button.

1. Insert a blank VHS videotape into the VCR deck.
2. Insert the disc you wish to copy in the DVD deck and close the disc tray.
3. Find the place on the DVD (or Disc) from which you want to start dubbing using the PLAY, FF, REW and PAUSE functions. For best results, pause playback at the point from which you want to record.
4. Press the DUBBING button on the Remote Control or DUB on the front panel. The Dubbing menu appears.



5. Use ▲ / ▼ / ◀ / ▶ to select the desired Record Mode: SP or SLP (3 times SP).
6. Select [Dubbing] then press ENTER or DUBBING to start copying.
7. To stop dubbing at any other time, press STOP (■). You must stop the dubbing process manually when the DVD movie ends, or the unit may replay and record over and over again.

Note:

If the DVD (or Discs) you are attempting to copy is copy protected, you will not be able to copy the disc. It is not permitted to copy Macrovision encoded DVDs (or Discs). [Copy-protected. Cannot record.] is displayed on the TV screen.

Tip:

If you press PAUSE during Dubbing mode, both the DVD and VCR decks go into Pause mode and the [DUB] indicator blinks on the front panel display. While in Pause mode, you can adjust the DVD playback position using PLAY, REW, FF, PAUSE/STEP, etc. The VCR deck will remain in Pause mode. To resume Dubbing, press the DUBBING button twice.

Dubbing from VCR to DVD

You can copy the contents of a VHS tape to a DVD using the DUBBING (DUB) button. This allows you to archive your old VHS tapes to DVD.

1. Insert a blank DVD disc in the DVD deck and close the disc tray.
2. Insert the VHS video tape you wish to copy into the VCR deck.
3. Find the place on the VHS tape from which you want to start dubbing using the PLAY, FF, REW and PAUSE functions. For best results, pause playback at the point from which you want to record.
4. Press the DUBBING button on the Remote Control or DUB on the front panel. The Dubbing menu appears.



5. Use ▲ / ▼ / ◀ / ▶ to select the desired Record Mode: EP, LP, SP or XP.
6. Select [Dubbing] then press ENTER or DUBBING to start copying.
7. To stop dubbing at any other time, press STOP (■). Dubbing will stop automatically when the VHS tape ends.

Note:

If the VHS video tape you are attempting to copy is copy protected, you will not be able to copy the tape. It is not permitted to copy Macrovision encoded tapes.

Tip:

If you press PAUSE during Dubbing mode, both the DVD and VCR decks go into Pause mode and the [DUB] indicator blinks on the front panel display. While in Pause mode, you can adjust the VCR playback position using PLAY, REW, FF, PAUSE/STEP, etc. The DVD deck will remain in Pause mode. To resume Dubbing, press the DUBBING button twice.

Recording from External Components

You can record from an external component, such as a camcorder or VCR, connected to any of the Recorder's external inputs.

1. Make sure that the component you want to record from is connected properly to the Recorder. See page 18.
2. Press INPUT repeatedly to select the external input to record from.
 - AV1: Audio/Video Input mounted on back panel.
 - AV2: Audio/Video Input mounted on front panel.
 - DV: DV Input mounted on front panel.
3. Load a recordable disc or tape.
4. Set a recording mode as necessary by pressing REC MODE repeatedly.
DVD: XP, SP, LP or EP.
VCR: SP or SLP
5. Press ● REC once to start recording.
The REC indicator lights in the display window.
6. Press STOP (■) to stop recording.

Notes:

- Check that the Audio In settings DV Record Audio are as you want them. See page 24.
- If your source is copy-protected using CopyGuard, you will not be able to record it using this recorder. See Copyright on page 9 for more details.
- Recording continues until you press STOP (■) or the disc is full.
- To record for a fixed length of time, see [Instant Timer Recording] on page 41.

Additional Information

Simultaneous Play and Record

You can play or record a DVD during the VCR playback, press DVD to change DVD mode and perform the DVD playback or recording.

Notes:

- You cannot play or record both DVD and VCR at the same time.
- You can not change VCR mode during the DVD recording mode.
- If you wish VCR playback or record during the DVD playback, press VCR to change VCR mode and perform the VCR playback or recording.

Recording from DV Input

Before DV dubbing

You can connect a DV-equipped camcorder to this recorder using a single DV cable for input and output of audio, video, data and control signals.

- This recorder is only compatible with DV-format (DVC-SD, DV25) camcorders. Digital satellite tuners and Digital VHS video recorders are not compatible.
- You cannot connect more than one DV camcorder at a time to this recorder.
- You cannot control this recorder from external equipment connected via the DV IN jack (including two recorders).
- It may not always be possible to control the connected camcorder via the DV IN jack.
- Digital camcorders can usually record audio as stereo 16-bit/48kHz, or twin stereo tracks of 12-bit/32kHz. This recorder can only record one stereo audio track. Set [DV Record Audio] option to Audio 1 or Audio 2 as required (see page 24).
- Audio input to the DV IN jack should be 32 or 48kHz (not 44.1kHz).
- Picture disturbance on the recording may occur if the source component pauses playback or plays an unrecorded section of tape, or if the power fails in the source component, or the DV cable becomes disconnected.

Recording from a Digital Camcorder

You can record from a digital camcorder connected to the DV IN jack on the front panel of this recorder.

Using the recorder's remote, you can control both the camcorder and this recorder.

Before recording, make sure that the audio input for the DV IN jack is set up (see page 24).

Tips:

- The source signal must be DVC-SD format.
- Some camcorders cannot be controlled using this recorder's remote.
- If you connect a second recorder using a DV cable, you cannot control the second DVD from this one.
- You cannot control this unit remotely from a component connected to the DV IN jack.
- You cannot record date and time information from a DV cassette.

1. Make sure your digital camcorder is connected to the front panel DV IN jack. See page 18.
2. Check that the DV audio input is as you require. You can choose between Audio 1 (original audio) and Audio 2 (overdubbed audio).
 - DV Input is set from the DV Record Audio in sub-menu of the Setup menu. See [DV Record Audio] on page 24 for more information.
3. Press INPUT repeatedly to select the DV input. DV appears in the display window and on the TV screen.
4. Find the place on the camcorder tape that you want to the recording to start from. For best results, pause playback at the point from which you want to record.
 - Depending on your camcorder, you can use this recorder's remote to control the camcorder using the STOP, PLAY, BACKWARD, FORWARD and PAUSE functions.
5. Press ● REC once to start recording.
 - Recording is automatically stopped if the recorder detects no signal.
 - You can pause or stop the recording by pressing PAUSE/STEP (||) or STOP (■). You cannot control the camcorder from this Remote Control during recording.
 - In Video mode, the final frame of the recording may remain displayed on screen for a while after recording stops.

Troubleshooting

If you cannot get a picture and/or audio through the DV IN jack, check the bullet points:

- Make sure the DV cable is properly connected.
- Try switching off the connected equipment then switch back on.
- Try switching the audio input.

Note:

Depending on the connected camcorder, you may not be able to control it using the Remote Control supplied with this recorder.

Editing

Title List and Chapter List Menu Overview

Using the Title List menu you can edit video content. The editing features available in the Title List menu depend on whether you are editing video on DVD, and whether you're editing Original content, or a Playlist.

There are two ways to edit VR mode DVD-RW discs. You can directly edit the Original content of the disc, or you can create and edit a Playlist. The Playlist doesn't actually change any of the content on the disc, but just controls how the content is played back.

- Press LIST/DISC MENU to display the Title List menu. Playback should be stopped when you do this.
 - When selecting titles, use the ▲ / ▼ buttons to display the previous/next page if there are more than six titles.
 - If you are editing a VR mode disc, press LIST/DISC MENU to switch between Original and Playlist menu.
 - On the left side of the screen are the menu options. The main part of the screen shows thumbnails of the titles (or chapter) on the DVD. You can change these thumbnails using the THUMBNAIL button. (see [Changing Title Thumbnails] on page 48.)
 - Press DISPLAY to display the information of selected title on the Title List menu.
 - After selecting a title or chapter on the Title List of Chapter List menu, then press ENTER. The menu options on the left side of the menu. Use ▲ / ▼ to select a option then press ENTER to confirm your selection.
- To exit the Title List menu, press RETURN (↵) repeatedly.

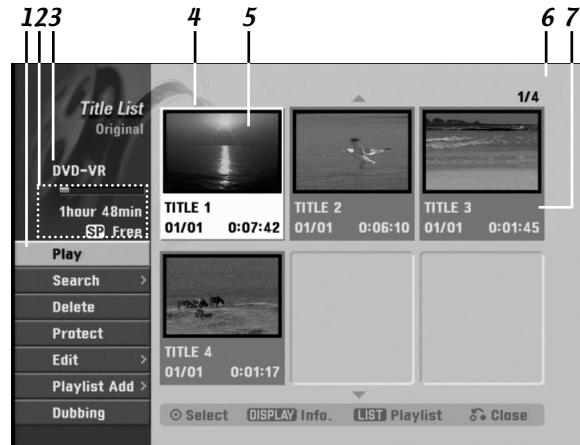

- Menu options: To display menu option, select a title or chapter then press ENTER. The options displayed differ depending on the disc type.
 - [Play] Start playback of the selected title or chapter. The hidden titles and chapters on the DVD+R/RW cannot be play back.
 - [Search]
 - [Chapter] ; Displays Chapter List of the Title.
 - [Time] ; Search time for you want start point of the title .
 - [Delete] Deletes the title or chapter. (page 50)
 - [Move] Moves chapter position on [Chapter List - Playlist] menu (page 53).
 - [Protect] Protects accidental recording, editing or deleting of the title.(page 53)
 - [Edit] Edits or Deletes a part of the title.
 - [Title Name] Edits the title name. (page 51).
 - [Delete Part] Deletes a part of the Title (page 50).
 - [Divide] Divides a title into two (page 52).
 - [Hide (Show)] Hides (or Shows) the selected title or chapter. (page 53)
 - [Playlist Add] Adds the title or chapter to the Playlist. (page 49)
 - [Dubbing] Dubs the title to VCR.
 - [Title] Displays Title List of the chapter.
 - [Combine] Combines two titles or chapters into one (page 52).
 - [Full Play] Starts playback of the selected title including the hidden chapters.
- Indicates the record mode, free space, and elapsed time progress bar.
- Current media.
- Currently selected title.
- Thumbnail.
- Shows the selected title number and total number of titles.
- Shows the title name, recorded date, and recording length.

VR Mode: Original and Playlist Editing

Titles, Chapters and Parts

Titles in the disc's original content contain one or more chapters. When you insert a disc's title into the Playlist, all the chapters within that title also appear. In other words, chapters in the Playlist behave exactly as chapters on a DVD-Video disc do. Parts are sections of Original or Playlist titles. From the Original and Playlist menu you can add or delete parts. Adding a chapter or title to the Playlist creates a new title made up of a section (ie., chapter) of an Original title. Deleting a part removes part of a title from the Original or Playlist menu.

Caution

- When editing using the Delete, Add and Move functions, the start and end frames may not be exactly as set in the start and end point display.
- During Playlist playback, you may notice a momentary pause between edits. This is not a malfunction.

Is editing a DVD like editing a video tape?

No. When you edit a video tape you need one video deck to play the original tape and another to record the edits. With DVD, you edit by making a 'Playlist' of what to play and when to play it. On playback, the Recorder plays the disc according to the Playlist.

About word 'Original' and 'Playlist'

-RWVR **RAM**

Throughout this manual, you will often see the words Original and Playlist to refer to the actual content and the edited version.

- **Original:** content refers to what's actually recorded on the disc.
- **Playlist:** content refers to the edited version of the disc — how the Original content is to be played.

Adding Chapter Markers

 **Chapter** **-RWVR** **+RW** **+R** **RAM**

You can create chapters within a title by inserting chapter marks at the desired points.

Note:

Chapter markers are inserted at regular intervals automatically. You can change this interval from the Initial Setup menu (see [Auto Chapter] on page 24).

During recording or playing back, at the point you want to start a new chapter, press **CHP ADD**. A chapter marker icon appears on the TV screen.

Changing Title Thumbnails

 **Thumb.** **-RWVR** **+RW** **+R** **RAM**

Each title displayed in the Title List menu is represented by a thumbnail picture taken from the start of that title or chapter.

If you prefer, select a different still picture from within a title.

Press **THUMBNAIL** to make the currently displayed picture the one that appears in the Title List menu.

The still picture that you choose appears in both the Original or Playlist menu.

Tip:

You can also change the thumbnail picture of the title on the Chapter List menu. Select a chapter on the Chapter List menu then press **THUMBNAIL**. The thumbnail picture of the title that includes the chapter is changed.

Making a New Playlist

-RWVR **RAM**

Use this function to add an Original title or chapter to the Playlist. When you do this, the whole title is put into the Playlist (you can delete bits you don't need later - see [Deleting an Original or Playlist title/chapter] on page 50).

The title appears in the Playlist complete with the chapter markers that appear in the Original. However, if you add more chapter markers to the Original later, these are not automatically copied over into the Playlist title.

1. Choose a title or chapter on the [Title List-Original] menu or [Chapter List-Original] menu to put into the Playlist, then press ENTER. The menu options appears on the left side of the menu.



2. Use ▲ / ▼ to select [Playlist Add] option then press ENTER.



3. Select [New Playlist] then press ENTER. The new title appears in the updated Playlist. All chapters of the title are added to the Playlist.

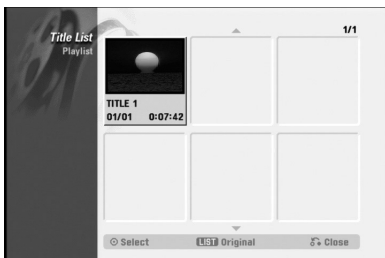

Adding Additional Title / Chapters to the Playlist

-RWVR **RAM**

You can add an Original title or chapter to add to a Playlist title even if it is already registered.

1. Choose a title or chapter on the [Title List-Original] menu or [Chapter List-Original] menu to put into the Playlist, then press ENTER. The menu options appears on the left side of the screen.



2. Use ▲ / ▼ to select [Playlist Add] from menu options then press ENTER.



3. Choose a Title List-Playlist that is already registered to insert a title or chapter, then press ENTER.
4. Repeat steps 1-3 to add additional title or chapter on the Playlist. You can view the added chapters on the [Chapter List-Playlist] menu.



5. Press RETURN (↵) to exit, or LIST/DISC MENU to go back to the [Title List-Original] menu.

Deleting an Original or Playlist Title/Chapter

When you erase a title or chapter from the Playlist menu, you only remove it from the Playlist; the title/chapter remains in the Original menu.

If you choose to delete a title or chapter from the Original (title/chapter) menu, the title or chapter is actually deleted from the disc and the remaining time available for recording increases. Titles/chapters deleted from the Original are also removed from the Playlist.

Note:

It may not be possible to delete chapters that are less than 5 seconds long.

1. Use ◀ / ▶ / ▲ / ▼ to choose a chapter or title you want to delete on the [Title List] or [Chapter List] menu then press ENTER. The menu options appears on the left side of the screen.

2. Select [Delete] option from the options on the menu.

Example: Title List (DVD-VR)



3. Press ENTER to confirm. The confirm message for deleting will appear.
4. Use ◀ / ▶ to select [Yes] then press ENTER. The selected chapter or title is deleted. After pressing ENTER, the new, updated menu is displayed.
5. Repeat steps 1 - 4 to continue to delete from the menu.
6. Press RETURN (↵) repeatedly to exit the menu.

Notes:

- When DVD+RW recording, the deleted title's name is changed to [Deleted Title].
- If more than two titles are repeatedly deleted, the titles are combined into one.
- When you are deleting a title or chapter, only the last one on DVD+R/RW increases remaining recording time.

Deleting a Part **-RW/VR** **RAM**

You can delete a part which you do not want in the title.

1. Use ◀ / ▶ / ▲ / ▼ to choose a title you want to delete on the Title List menu then press ENTER. The options appears on the left side of the menu.
2. Select [Delete Part] option then press ENTER. [Title Edit (Delete Part)] menu appears on the TV screen. [Start Point] icon is highlighted.

Example: Title Edit (Delete Part) (DVD-VR)

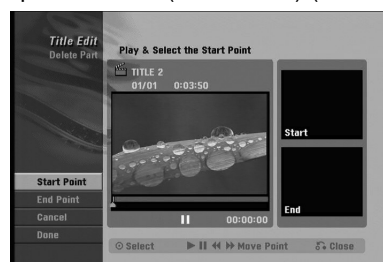

3. Starts playback and use pause step, search and slow-motion to find the starting point.
4. Press ENTER at the starting point of the section you want to delete. [End Point] icon is highlighted. The part is indicated on the Progress Bar.
5. Use pause step, search and slow-motion to find the ending point.
6. Press ENTER at the ending point of the section you want to delete. You can cancel the selected point, use ▲ / ▼ to select [Cancel] icon then press ENTER.
7. If you finish to edit, select [Done] icon then press ENTER. The confirm message for deleting will appear. Use ◀ / ▶ to select [Yes] then press ENTER. The selected part is deleted from the title and Title List menu appears.

Notes:

- It may not be possible to delete parts that are less than 3 seconds long.
- If you select [Cancel] then press ENTER, the Recorder will go to previous option and into Pause mode.

Naming a Title

You can name Original and Playlist titles independently.

1. Choose the title you want to name on the Title List menu, then press ENTER.
The menu options appears on the left side of the menu.
2. Use ▲/▼ to select [Title Name] option then press ENTER.
Keyboard menu appears.



3. Enter a name for the title. Use ◀/▶/▲/▼ to select a character then press ENTER to confirm your selection.
 - **Language** : Selects a keyboard type.
 - **Space**: Inserts a space at the cursor position.
 - **Delete**: Deletes the character to the left of the cursor position.
 - **◀ / ▶**: Moves the cursor left or right.
 - **OK**: Confirms the name you have entered.
 - **Cancel**: Deletes all characters and exits the Keyboard menu.

Remote control buttons for entering a name

- **▶ (PLAY)**: Inserts a space at the cursor position.
- **PAUSE/STEP (II)**: Deletes the character to the right of the cursor position.
- **SKIP (I◀◀ / ▶▶I)**: Moves the cursor left or right.
- **STOP (■), CLEAR**: Deletes the character to the left of the cursor position.
- **0-9**: Enters the character corresponding to the selected column.
- **LIST/DISC MENU, DISPLAY**: Switches the keyboard type (English/Latin Capital, English/Latin Lowercase, Symbol)

4. Choose [OK] then press ENTER to fix the name and return to the previous menu screen.
5. Press RETURN (↵) repeatedly to exit the menu.

Notes:

- Names can be up to 32 characters long.
- For discs formatted on a different recorder, you will see only a limited character set.
- When recording on DVD-R, DVD+R or DVD+RW discs, the entered name is displayed on the DVD player only after finalization.

Time Search

You can select start point of the title.

1. Use ◀/▶/▲/▼ to choose a title on the Title List menu then press ENTER.
The options appears on the left side of the menu.
2. Select [Time] option then press ENTER.
Example: Title List (DVD-VR)



3. Press ENTER.
[Time Search] menu appears on the TV screen.

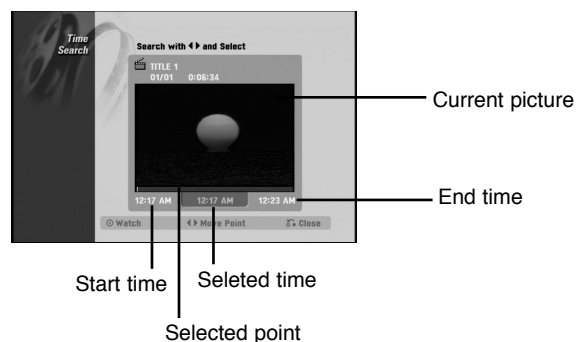

4. Use ◀/▶ to find the point you want to start. The point increase 1 minute step.
If you press and hold ◀/▶ then the point increase 5 minute step.
5. Press ENTER to start selected point.

Divide One Title Into Two

+RW

Use this command to split a title up into two new titles.

1. On the Title List menu, select a title you want to divide then press ENTER. The menu options appears on the left side of the screen.
2. Select [Divide] option.
Example: Title List (DVD+RW)



3. Press ENTER. [Title Edit (Divide)] menu appears. [Divide] option is highlighted.

Current picture

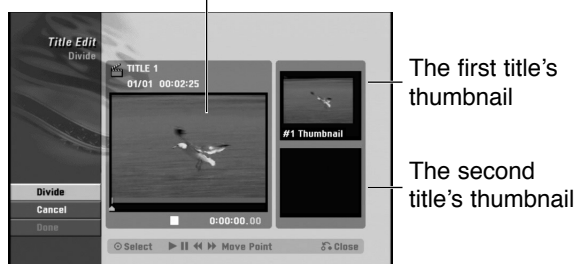

4. Use play, pause step, search and slow-motion to find the point you want to divide the title.
5. Select [Divide] option then press ENTER at the point.
To reset the point, select [Cancel] option then press ENTER. Repeat from step 3.
6. Choose [Done] option then press ENTER to fix the dividing point.
The title is divided into two new titles. It take up to 4 minutes to divide.

Note:

You cannot select dividing point less than 3 seconds.

Combining Two Chapters Into One

-RW/VR +RW +R RAM

Use this function to combine two adjacent chapters into one.

1. On the Chapter List menu, select the second chapter of the two chapters you want to combine then press ENTER. The menu options appears on the left side of the screen.
2. Use ▲ / ▼ to select [Combine] option.
The combine indicator appears between the two chapters you want to combine.
Example: Title List (DVD+RW)

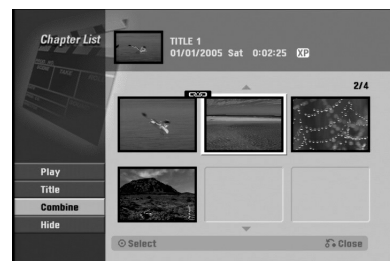

3. Repeat steps 1 - 2 to continue to combine from the menu.
4. Press RETURN (↵) repeatedly to exit the menu.

Notes:

This function cannot operate listed as below;

- If there is only one chapter within the title.
- If you select first chapter.
- If two chapters created by erasing a part from an original title.
- If two chapters created from different titles.
- If two chapters created by moving an order from an original title.

Moving a Playlist Chapter **-RWVR**

Use this function to re-arrange the playing order of Playlist chapters on the Chapter List-Playlist menu.

Note:

This function is not available if there is only one chapter.

1. Select a chapter on the Chapter List-Playlist menu.
2. Press ENTER.
The menu options appears on the left side of the menu.
3. Use ▲ / ▼ to select [Move] option from Playlist options then press ENTER.



4. Use ◀ / ▶ / ▲ / ▼ to choose the place you want to move the chapter then press ENTER.
After pressing ENTER, the updated menu is displayed.

Hide a Chapter/Title **+RW +R**

You can skip playing chapters or titles without deleting from the disc.

1. Use ▲ ▼ ◀ ▶ to choose a chapter or title you want to hide on the [Title List] or [Chapter List] menu, then press ENTER.
Options appear on the left side of the screen.
2. Select [Hide] option.

Example: Title List (DVD+RW)



3. Press ENTER to confirm.
The chapter's or title's thumbnail will dim.

Tip:

If you select a hidden chapter or title on the Title List or Chapter List menu, you can 'show' it by choosing [Show] option on the menu. After doing that, you are able to see the chapter or title.

Protect a Title **+RW +R -RWVR RAM**

Use this function to protect against accidental recording, editing or deleting of the title.

1. Press LIST/DISC MENU to display the [Title List] menu.
2. Use ▲ ▼ ◀ ▶ to choose a title you want to protect then press ENTER.
Options appear on the left side of the screen.
3. Select [Protect] from the options.

Example: Title List (DVD+RW)



4. Press ENTER to confirm.
The lock mark will appears on the title's thumbnail.

Tip:

If you select a title that has already been protected on the Title List menu, you can 'unprotect' it by choosing [Unprotect] option from the Title List menu options. After doing that, you can edit and delete the title.

Overwriting Recording **+RW**

To overwrite a new video recording on a previously recorded title, follow these steps. This feature is not available for DVD+Rs, that always record at the end of the Disc.

1. Select input source you want to record (TV channel, AV1-2, DV).
2. Press LIST/DISC MENU to display the Title List menu.



3. Use **▲ ▼ ◀ ▶** to choose a title you want to overwrite.
4. Press **● REC** to start overwrite recording. Overwrite recording starts from the start point of the title.
5. Press **STOP (■)** to stop the overwrite recording. The new title is created and updated menu is displayed.

Notes:

- This function is not available for a protected title.
- **If the overwrite is longer than the recording length of the current title, the next title is overwritten. But if next title is protected, the overwriting stops at the starting point of the title.**
- If the selected title's recording length is less than 10 seconds, the next title is overwritten. But if the next title is protected, overwriting stops.

Viewing Title List menu displayed on other DVD Recorders or Players

+RW +R

You can view the Title List menu displayed on the other DVD player that is capable of playing DVD+RW or DVD+R discs.

1. Insert DVD+R or DVD+RW disc recorded already.

2. Press TITLE in Play mode or DVD tuner mode. Title List menu will appear as shown below.



3. To play back a title, select the title you want then press ENTER or **▶ (PLAY)**.

Tip:

You can remove the Title List menu by pressing **STOP (■)**.

Playing Your Recordings on Other DVD Players (Finalizing a Disc)

Most regular DVD players can play finalized discs recorded in Video mode, finalized DVD+R or DVD+RWs. A small number of players can also play DVD-RW discs recorded in VR mode, finalized or not. Check the manual that came with the other player to check what formats of discs it will play.

Finalizing 'fixes' the recordings and editings in place so that the disc can be played on a regular DVD player or computer equipped with a suitable DVD-ROM drive.

Finalizing a Video mode disc creates a menu screen for navigating the disc. The menu can be accessed by pressing LIST/DISC MENU or TITLE.

To finalize a disc, refer to [Finalize] on page 25.

Notes:

- Unfinalized DVD+RW is playable on regular DVD players.
- The edited contents of a DVD+RW (DL) disc is compatible on regular DVD players only after finalization.
- Any edited contents of the DVD+R disc are not compatible on regular DVD players. (Hide, chapter combine, added chapter mark, etc.)
- How long finalization takes depends on the type of disc, how much is recorded on the disc, and the number of titles on the disc.
- DVD+R DL disc can take up to 30 minutes to finalize.

Reference

Controlling Your TV with the Supplied Remote

You can control the sound level, input source, and power switch of your LG TV with the supplied remote. You can control your TV using the buttons below.

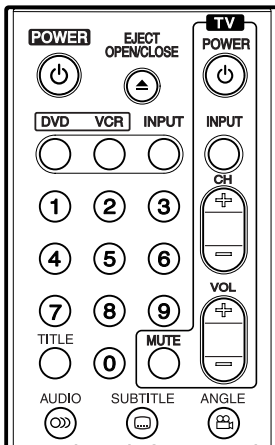

By pressing	You can
POWER	Turn the TV on or off.
INPUT	Switch the TV's input source between the TV and other input sources.
CH +/-	Scans up or down through memorized channels.
VOL +/-	Adjust the volume of the TV.
MUTE	Turns on or off TV sound.

Note:

Depending on the unit being connected, you may not be able to control your TV using some of the buttons.

Controlling other TVs with the remote

You can control the sound level, input source, and power switch of non-LG TVs as well. If your TV is listed in the table below, set the appropriate manufacturer code.

1. While holding down TV POWER button, press the number buttons to select the manufacturer code for your TV (Refer to table on the right column).
2. Release TV POWER button.

Code numbers of controllable TVs

If more than one code number is listed, try entering them one at a time until you find the one that works with your TV.

Manufacturer	Code Number	Manufacturer	Code Number
ADMIRAL	16,33,37,44,45	MONTGOMERY	01,06,08,09
AIWA	70	WARD	23,24,32,33,34
AKAI	01	NEC	01,08
AMARK	09	NOBLEX	07
AOC	01	PACKARD BELL	43
BELL & HOWELL	33	PANASONIC	07,11,13,25,35,36
BROKSONIC	16,19	PHILCO	01,06,07,08,09,
CANDLE	51		15,38,43,58
CCE	07	PHILIPS	06,07,43,61,62,65
CENTURION	08	PIONEER	30
CINERAL	43	PORTLAND	09
CITIZEN	49,50,51,52,53,54,55	PROSCAN	03,37,44
CORONADO	09	QUASAR	11,13
CROWN	09	RADIO SHACK	16,17,23
CURTIS MATHES	01,03,08,33,35,37,44	RCA	01,03,37,44,69
DAEWOO	16,38,39,40,41,42,43	REALISTIC	16,17,23
DAYTRON	01,08	SAMPO	08
EMERSON	01,09,16,17,18,19	SAMSUNG	01,08,09,25,68
FISHER	28,29	SANYO	28,29
FUNAI	46,47	SCOTT	01,08
GENERAL ELECTRIC	03,10,11,13,37,44	SEARS	09,25,26,27,28,29
GRADIENTE	01,56,57,63,67	SEMP	64
HITACHI	09,14,15,43	SHARP	09,22,23,24,60,66
JC PENNEY	01,08,10,27,35	SIGNATURE 2000	01,06,08,09,10,
JVC	20,21,63,67		23,24,33,34
KIOTE	43	SONY	12,62
KMC	09	SOUNDESIGN	51
KTV	01,08,09,31	SYLVANIA	01,04,05,06,07,
LG (GOLDSTAR)	01,07,08,09,35,39,40		08,35,51
LODGENET	33	SYMPHONIC	46,47
LOGIK	33	TATUNG	11
LXI	09,24,25,26,27,28,29	TEKNIKA	07,09,16,33,51
MAGNAVOX	01,02,04,05,06,	TELERENT	09,33
	07,08,09,20,	THOMSON	69
	34,35,43,51,61,62,65	YORX	08
MAJESTIC	33	TOSHIBA	01,25,26,27,64
MARANTZ	01,32	WARDS	01,06,08,09,10,33,34
MEMOREX	33	XR1000	48
MGA/MITSUBISHI	01,08,32,34	ZENITH	01,02,33,59

Notes:

- Depending on your TV, some or all buttons may not function on the TV, even after entering the correct manufacturer code.
- If you enter a new code number, the code number previously entered will be erased.
- When you replace the batteries of the remote, the code number you have set may be reset to the default setting. Set the appropriate code number again.

Language Code List

Use this list to input your desired language for the following initial settings: Disc Audio, Disc Subtitle, Disc Menu.

Language	Code	Language	Code	Language	Code	Language	Code
Abkhazian	6566	Fiji	7074	Lingala	7678	Singhalese	8373
Afar	6565	Finnish	7073	Lithuanian	7684	Slovak	8375
Afrikaans	6570	French	7082	Macedonian	7775	Slovenian	8376
Albanian	8381	Frisian	7089	Malagasy	7771	Somali	8379
Ameharic	6577	Galician	7176	Malay	7783	Spanish	6983
Arabic	6582	Georgian	7565	Malayalam	7776	Sudanese	8385
Armenian	7289	German	6869	Maltese	7784	Swahili	8387
Assamese	6583	Greek	6976	Maori	7773	Swedish	8386
Aymara	6588	Greenlandic	7576	Marathi	7782	Tagalog	8476
Azerbaijani	6590	Guarani	7178	Moldavian	7779	Tajik	8471
Bashkir	6665	Gujarati	7185	Mongolian	7778	Tamil	8465
Basque	6985	Hausa	7265	Nauru	7865	Tatar	8484
Bengali; Bangla	6678	Hebrew	7387	Nepali	7869	Telugu	8469
Bhutani	6890	Hindi	7273	Norwegian	7879	Thai	8472
Bihari	6672	Hungarian	7285	Oriya	7982	Tibetan	6679
Breton	6682	Icelandic	7383	Panjabi	8065	Tigrinya	8473
Bulgarian	6671	Indonesian	7378	Pashto, Pushto	8083	Tonga	8479
Burmese	7789	Interlingua	7365	Persian	7065	Turkish	8482
Byelorussian	6669	Irish	7165	Polish	8076	Turkmen	8475
Cambodian	7577	Italian	7384	Portuguese	8084	Twi	8487
Catalan	6765	Japanese	7465	Quechua	8185	Ukrainian	8575
Chinese	9072	Javanese	7487	Rhaeto-Romance	8277	Urdu	8582
Corsican	6779	Kannada	7578	Rumanian	8279	Uzbek	8590
Croatian	7282	Kashmiri	7583	Russian	8285	Vietnamese	8673
Czech	6783	Kazakh	7575	Samoan	8377	Volapük	8679
Danish	6865	Kirghiz	7589	Sanskrit	8365	Welsh	6789
Dutch	7876	Korean	7579	Scots Gaelic	7168	Wolof	8779
English	6978	Kurdish	7585	Serbian	8382	Xhosa	8872
Esperanto	6979	Laothian	7679	Serbo-Croatian	8372	Yiddish	7473
Estonian	6984	Latin	7665	Shona	8378	Yoruba	8979
Faroese	7079	Latvian, Lettish	7686	Sindhi	8368	Zulu	9085

Area Code List

Choose a area code from this list.

Area	Code	Area	Code	Area	Code	Area	Code
Afghanistan	AF	Ethiopia	ET	Malaysia	MY	Saudi Arabia	SA
Argentina	AR	Fiji	FJ	Maldives	MV	Senegal	SN
Australia	AU	Finland	FI	Mexico	MX	Singapore	SG
Austria	AT	France	FR	Monaco	MC	Slovak Republic	SK
Belgium	BE	Germany	DE	Mongolia	MN	Slovenia	SI
Bhutan	BT	Great Britain	GB	Morocco	MA	South Africa	ZA
Bolivia	BO	Greece	GR	Nepal	NP	South Korea	KR
Brazil	BR	Greenland	GL	Netherlands	NL	Spain	ES
Cambodia	KH	Islands	HM	Netherlands Antilles	AN	Sri Lanka	LK
Canada	CA	Hong Kong	HK	New Zealand	NZ	Sweden	SE
Chile	CL	Hungary	HU	Nigeria	NG	Switzerland	CH
China	CN	India	IN	Norway	NO	Taiwan	TW
Colombia	CO	Indonesia	ID	Oman	OM	Thailand	TH
Congo	CG	Israel	IL	Pakistan	PK	Turkey	TR
Costa Rica	CR	Italy	IT	Panama	PA	Uganda	UG
Croatia	HR	Jamaica	JM	Paraguay	PY	Ukraine	UA
Czech Republic	CZ	Japan	JP	Philippines	PH	United States	US
Denmark	DK	Kenya	KE	Poland	PL	Uruguay	UY
Ecuador	EC	Kuwait	KW	Portugal	PT	Uzbekistan	UZ
Egypt	EG	Libya	LY	Romania	RO	Vietnam	VN
El Salvador	SV	Luxembourg	LU	Russian Federation	RU	Zimbabwe	ZW

Troubleshooting

Check the following guide for the possible cause of a problem before contacting service.

Symptom	Cause	Correction
No power.	<ul style="list-style-type: none"> The power cord is disconnected. 	<ul style="list-style-type: none"> Plug the power cord into the wall outlet securely.
No picture.	<ul style="list-style-type: none"> The TV is not set to receive Recorder signal output. 	<ul style="list-style-type: none"> Select the appropriate video input mode on the TV so the picture from the Recorder appears on the TV screen.
	<ul style="list-style-type: none"> The video cable is not connected securely. 	<ul style="list-style-type: none"> Connect the video cable into the jacks securely.
	<ul style="list-style-type: none"> The Progressive Scan is set to [ON] on the setup menu but is connected to a standard(analog) television with component video input. 	<ul style="list-style-type: none"> Set Progressive Scan to [OFF] (see page 21).
	<ul style="list-style-type: none"> Wrong connection. 	<ul style="list-style-type: none"> Check the connection.
No sound.	<ul style="list-style-type: none"> The equipment connected with the audio cable is not set to receive Recorder signal output. 	<ul style="list-style-type: none"> Select the correct input mode of the audio receiver so you can listen to the sound from the Recorder.
	<ul style="list-style-type: none"> The audio cables are not connected securely. 	<ul style="list-style-type: none"> Connect the audio cable into the jacks securely.
	<ul style="list-style-type: none"> The power of the equipment connected with the audio cable is turned off. 	<ul style="list-style-type: none"> Turn on the equipment connected with the audio cable.
	<ul style="list-style-type: none"> The AUDIO options are set to the wrong position. 	<ul style="list-style-type: none"> Set the AUDIO options to the correct position.
The playback picture is poor.	<ul style="list-style-type: none"> The disc is dirty. 	<ul style="list-style-type: none"> Clean the disc.
	<ul style="list-style-type: none"> The TV channels are not tuned in properly. 	<ul style="list-style-type: none"> Check tuning, carry out tuning again.
	<ul style="list-style-type: none"> Tape heads are dirty. 	<ul style="list-style-type: none"> Clean video heads.
	<ul style="list-style-type: none"> Tape is a rental or was recorded on another VCR. 	<ul style="list-style-type: none"> Use CH/TRK (▲/▼) for manual tracking adjustment while tape is playing.
	<ul style="list-style-type: none"> This unit can only output 525p Progressive scan picture. 	<ul style="list-style-type: none"> Make sure that your TV can support 525p Progressive scan picture or set Progressive scan to off.
Picture from external input is distorted.	<ul style="list-style-type: none"> The video signal from the external component is copy-protected. 	<ul style="list-style-type: none"> You cannot connect via the Recorder. Connect the component directly to your TV.
Some channels are skipped over when using CH (▲ / ▼).	<ul style="list-style-type: none"> The skipped channels were deleted with the CH. Add/Del feature. 	<ul style="list-style-type: none"> Use the CH. Add/Del feature to restore channels. See [To Add or Erase Channels from Memory] on page 20.

Symptom	Cause	Correction
The Recorder does not start playback.	<ul style="list-style-type: none"> • No disc is inserted. • No tape is inserted. 	<ul style="list-style-type: none"> • Insert a disc or tape. (Check that the disc or tape indicator in the display window is lit.)
	<ul style="list-style-type: none"> • An unplayable disc is inserted. 	<ul style="list-style-type: none"> • Insert a playable disc. (Check the disc type and Regional code.)
	<ul style="list-style-type: none"> • The disc is placed upside down. 	<ul style="list-style-type: none"> • Place the disc with the playback side down.
	<ul style="list-style-type: none"> • The disc is not placed within the guide. 	<ul style="list-style-type: none"> • Place the disc on the disc tray correctly inside the guide.
	<ul style="list-style-type: none"> • The disc is dirty. 	<ul style="list-style-type: none"> • Clean the disc.
	<ul style="list-style-type: none"> • The Rating level is set. 	<ul style="list-style-type: none"> • Cancel the Rating function or change the rating level.
Video tape cannot be inserted.	<ul style="list-style-type: none"> • Is the cassette compartment empty? 	<ul style="list-style-type: none"> • Eject the tape in.
The Remote Control does not work properly.	<ul style="list-style-type: none"> • There is an obstacle in the path of the Remote Control and this unit. 	<ul style="list-style-type: none"> • Remove the obstacle.
	<ul style="list-style-type: none"> • The batteries in the Remote Control are exhausted. 	<ul style="list-style-type: none"> • Replace the batteries with new ones.
	<ul style="list-style-type: none"> • The Remote Control is not pointed at the remote sensor of the Recorder. 	<ul style="list-style-type: none"> • Point the Remote Control at the remote sensor of the Recorder.
	<ul style="list-style-type: none"> • The Remote Control is too far from the Recorder. 	<ul style="list-style-type: none"> • Operate the Remote Control within 23ft (7m).
	<ul style="list-style-type: none"> • This Remote Control use the same buttons for VCR and DVD functions (ex.PLAY). 	<ul style="list-style-type: none"> • When using a VCR, first press the VCR button. When using a DVD, first press the DVD button.
Camcorder image is not shown.	<ul style="list-style-type: none"> • Camcorder is off. 	<ul style="list-style-type: none"> • Turn camcorder on and operate properly.
Camcorder image via A/V input or DV IN to Recorder is not shown on TV screen.	<ul style="list-style-type: none"> • The recorder's source is incorrect. 	<ul style="list-style-type: none"> • Use INPUT to select input channel (AV1, AV2 or DV IN).
Timer recording is not possible.	<ul style="list-style-type: none"> • Clock in record is not set to correct time. 	<ul style="list-style-type: none"> • Set clock to correct time.
	<ul style="list-style-type: none"> • Timer has been programmed incorrectly. 	<ul style="list-style-type: none"> • Reprogram Timer.
	<ul style="list-style-type: none"> • Ⓞ (TIMER Record) indicator light does not appear after programming timer. 	<ul style="list-style-type: none"> • Reprogram Timer and turn record off to enable timer.

Symptom	Cause	Correction
Picture or sound of broadcasting channel is weak or missing.	• Antenna or cables are loose.	• Tighten connections or replace cable.
	• Wrong Tuning Band is selected in the Recorder Setup menu.	• Try [Tuning Band Select] options; see page 19 for details.
Can't play disc recorded on this Recorder on another DVD player.	• The disc was recorded in Video mode.	• Finalize the disc; see page 25.
	• Some players will not play even a finalized disc recorded in Video mode.	• No solution.
	• The disc was recorded in VR mode.	• The other player must be RW compatible in order to play it.
	• Discs recorded with copy-once material cannot be played on other players.	• No solution.
Cannot record or did not record successfully.	• The remaining blank space on the disc is insufficient.	• Use another disc.
	• The source you are trying to record is copy-protected.	• You cannot record the source.
	• When setting the recording channel, the channel is tuned on the TV's own tuner.	• Select the channel on the Recorder's built-in TV tuner.
	• When recording to a Video mode disc, programs that are copy-once protected cannot be recorded.	• Use a VR mode formatted disc for copy-once material.
Stereo Audio Record and/or Playback not present.	• TV is not Stereo-compatible.	• No solution.
	• Broadcast program is not in stereo format.	• No solution.
	• Recorder A/V Out jacks are not connected to TV A/V In jacks.	• Make A/V connections. Stereo is available only via A/V output from Recorder.
	• Recorder Audio/Video Out is not selected for viewing at the TV.	• Select AUX or A/V source as TV input.
	• Recorder's TV audio channel is set to SAP or MONO.	• Set TV audio channel mode to Stereo. See [Changing TV Audio Channel] on page 27.

Reset the Recorder

If you observe any of the following symptoms...

- When the Recorder is plugged in, but the power will not turn on or off.
- When the display window does not working.
- When the Recorder does not operate normally.

You can reset the Recorder as follows :

- Press and hold the POWER button for more than five seconds. This will force the Recorder to power off. Press the POWER button again to turn the Recorder back on.
- Unplug the power cord and then plug the power cord again after more than five seconds.

Specifications

General

Power requirements	AC 120V, 60 Hz
Power consumption	35W
Dimensions (approx.)	430 X 78.5 X 354 mm (16.9 x 3.1 x 13.9 inches) (w x h x d)
Mass (approx.)	6.8 kg (14.96 lbs)
Operating temperature	5°C to 35°C (41°F to 95°F)
Operating humidity	5 % to 90 %
Signal system	NTSC

Recording

Recording format	DVD VideoRecording, DVD-VIDEO
Recordable discs	DVD-ReWritable, DVD-Recordable, DVD+ReWritable, DVD+Recordable (Double Layer), DVD-Random Access Memory
Recordable time	DVD ; Approx. 1 hour (XP mode), 2 hours (SP mode), 4 hours (LP mode), 6 hours (EP mode) DVD+R DL (8.5GB): Approx. 1 hour 50 minutes (XP mode), 3 hours 40 minutes (SP mode), 7 hours 10 minutes (LP mode), 11 hours (EP mode) VCR ; SP: 2 HOURS (T-120), SLP: 6 HOURS (T-120)/8 HOURS (T-160)

Video recording format

Sampling frequency	27MHz
Compression format	MPEG 2

Audio recording format

Sampling frequency	48kHz
Compression format	Dolby Digital

VCR Specifications

Head system	Four head helical scan azimuth system
Timer	12-hour display type with AM, PM
Tape speed	SP: 33.35 mm/sec, LP: 16.67 mm/sec, SLP: 11.12 mm/sec
Tape width	12.7 mm
Rewind time	About 65 seconds (T-120)
Antenna	75 ohms (VHF/UHF)
VHF output signal	Channel 3 or 4 (Switchable)
Channel coverage	VHF: 2-13, UHF: 14-69, CATV: 1-125 (4A, A-W, W+1 - W+84, A-5 - A-1)
Frequency range	20Hz to 20kHz
Signal-to-noise ratio	43dB
Dynamic range	88 dB
Channel separation	60 dB

DVD Specifications

Laser system	Semiconductor laser, wavelength 650 nm
Frequency response	DVD (PCM 48 kHz): 8 Hz to 22 kHz, CD: 8 Hz to 20 kHz
Signal-to-noise ratio	More than 95dB
Harmonic distortion	Less than 0.008%
Dynamic range	More than 90 dB

Inputs

ANTENNA IN	Antenna or CATV input, 75 ohms
VIDEO IN (AV1,2)	1.0 Vp-p 75 ohms, sync negative, RCA jack x 2
AUDIO IN (AV1,2)	-6 dBm more than 47 kohms, RCA jack (L, R) x 2
S-VIDEO IN	(Y) 1.0 V (p-p), 75 Ω , negative sync, Mini DIN 4-pin x 1 (C) 0.286 V (p-p) 75 Ω
DV IN	4 pin (i.LINK/IEEE 1394 standard)

Outputs

VIDEO OUT	1 Vp-p 75 Ω , sync negative, RCA jack x 1
S-VIDEO OUT	(Y) 1.0 V (p-p), 75 Ω , negative sync, Mini DIN 4-pin x 1 (C) 0.286 V (p-p) 75 Ω
COMPONENT VIDEO OUT (PROGRESSIVE SCAN)	(Y) 1.0 V (p-p), 75 Ω , negative sync, RCA jack x 1 (Pb)/(Pr) 0.7 V (p-p), 75 Ω , RCA jack x 2
Audio output (digital audio)	0.5 V (p-p), 75 Ω , RCA jack x 1
Audio output (optical audio)	Optical connector x 1
Audio output (analog audio)	1.1 Vrms (1 kHz, -6 dB), 600 Ω , RCA jack (L, R) x 2
RF OUT	Channel 3 or 4 (Switchable)

Accessory:

Video cable	1	Audio cable (L, R)	1
RF 75-ohm Coaxial Cable	1	Remote Control	1
Batteries	2		

Design and specifications are subject to change without notice.



LG Electronics, Inc. Limited Warranty - USA

This LG Electronics product, will be repaired or replaced, at LG's option, if it proves to be defective in material or workmanship, under normal use, during the warranty period ("Warranty Period") listed below, effective from the date ("Date of Purchase") of original consumer purchase of the product. This warranty is good only to the original purchaser of the product and effective only when used in the United States, excluding U.S. Territories.

WARRANTY PERIOD: LABOR: 90 days from the Date of Purchase. PARTS: One Year from the Date of Purchase. * Parts replaced are warranted for the remaining portion of the original warranty period.	HOW SERVICE IS HANDLED: Call 1-800-243-0000 for instructions on getting the defective unit repaired or replaced. Please retain dated sales receipt and your box to return the unit to LG for repair or replacement. Shipping both ways will be paid by LG during the Warranty Period. After the Warranty Period, you pay inbound shipping charges and LG pays return shipping charges. Visit our website at: http://www.lgservice.com
---	---

THIS WARRANTY IS IN LIEU OF ANY OTHER WARRANTIES, EXPRESS OR IMPLIED, INCLUDING WITHOUT LIMITATION, ANY WARRANTY OF MERCHANTABILITY OR FITNESS FOR A PARTICULAR PURPOSE. TO THE EXTENT ANY IMPLIED WARRANTY IS REQUIRED BY LAW, IT IS LIMITED IN DURATION TO THE EXPRESS WARRANTY PERIOD ABOVE. LG ELECTRONICS WILL NOT BE LIABLE FOR ANY INCIDENTAL, CONSEQUENTIAL, INDIRECT, SPECIAL OR PUNITIVE DAMAGES OF ANY NATURE, EVEN IF ADVISED OF THE POSSIBILITY OF SUCH DAMAGES, INCLUDING WITHOUT LIMITATION, LOST REVENUES OR PROFITS, LOST OR CORRUPTED PROGRAMMING OR DATA, OR ANY OTHER DAMAGE WHETHER BASED IN CONTRACT, TORT OR OTHERWISE. Some states do not allow the exclusion or limitation of incidental or consequential damages or limitation on how long an implied warranty lasts, so the above exclusion or limitation may not apply to you. This warranty gives you specific legal rights and you may also have other rights that may vary from state to state.

THIS LIMITED WARRANTY DOES NOT APPLY TO:

- Damages or operating problems that result from shipping, installation, adjustment of user controls, calibration, maintenance or failure to maintain, or separate system components; and
- Damages or operating problems that result from normal wear and tear, misuse, abuse, operation outside environmental specifications or contrary to the requirements or precautions in the Operating Guide, accident, lightning strikes or other natural causes, unauthorized modification or alteration, incorrect electrical current or voltage, reception problem caused by inadequate home antenna or faulty antenna connections, computer software, institutional or commercial use, or other causes not arising out of defect in material or workmanship.

Therefore, the cost of repair or replacement of such defective product shall be borne by the consumer.

CUSTOMER INTER-ACTIVE CENTER NUMBERS:

For nearest Authorized Service Center, Where to buy, Product Assistance, or Customer Assistance	Call 1-800-243-0000 (24 hours a day, 365 days per year) and select appropriate options from the menu. Or visit our website at http://www.lgservice.com
--	---

Free Manuals Download Website

<http://myh66.com>

<http://usermanuals.us>

<http://www.somanuals.com>

<http://www.4manuals.cc>

<http://www.manual-lib.com>

<http://www.404manual.com>

<http://www.luxmanual.com>

<http://aubethermostatmanual.com>

Golf course search by state

<http://golfingnear.com>

Email search by domain

<http://emailbydomain.com>

Auto manuals search

<http://auto.somanuals.com>

TV manuals search

<http://tv.somanuals.com>