



DIGITAL VIDEO RECORDER

OWNER'S MANUAL

MODEL: LDV-S504
LDV-S503

Before connecting, operating or adjusting this product,
please read this owner's manual carefully and completely.





CAUTION: TO REDUCE THE RISK OF ELECTRIC SHOCK DO NOT REMOVE COVER (OR BACK) NO USER-SERVICEABLE PARTS INSIDE REFER SERVICING TO QUALIFIED SERVICE PERSONNEL.



This lightning flash with arrowhead symbol within an equilateral triangle is intended to alert the user to the presence of uninsulated dangerous voltage within the product's enclosure that may be of sufficient magnitude to constitute a risk of electric shock to persons.



The exclamation point within an equilateral triangle is intended to alert the user to the presence of important operating and maintenance (servicing) instructions in the literature accompanying the product.

FCC WARNING: This equipment may generate or use radio frequency energy. Changes or modifications to this equipment may cause harmful interference unless the modifications are expressly approved in the instruction manual. The user could lose the authority to operate this equipment if an unauthorized change or modification is made.

REGULATORY INFORMATION: FCC Part 15

This equipment has been tested and found to comply with the limits for a Class A digital device, pursuant to Part 15 of the FCC Rules. These limits are designed to provide reasonable protection against harmful interference when the equipment is operated in a commercial environment.

This equipment generates, uses, and can radiate radio frequency energy and, if not installed and used in accordance with the instruction manual, may cause harmful interference to radio communications. Operation of this equipment in a residential area is likely to cause harmful interference in which case the user will be required to correct the interference at his own expense.

- A suitable conduit entries, knock-outs or glands shall be provided in the cable entries of this product in the end user.
- Caution: Danger of explosion if battery is incorrectly replaced. Replaced only with the same or equivalent type recommended by the manufacturer. Dispose of used batteries according to the manufacturer's instructions.
- Holes in metal, through which insulated wires pass, shall have smooth well rounded surfaces or shall be provided with brushings.

Warning: Do not install this equipment in a confined space such as a bookcase or similar unit.

Warning: Wiring methods shall be in accordance with the National Electric Code, ANSI/NFPA 70.

Warning: This is a class A product. In a domestic environment this product may cause radio interference in which case the user may be required to take adequate measures.

Warning: To reduce a risk of fire or electric shock, do not expose this product to rain or moisture.

Caution: This installation should be made by a qualified service person and should conform to all local codes.

Caution: To avoid electrical shock, do not open the cabinet. Refer servicing to qualified personnel only.

Caution: The apparatus should not be exposed to water (dripping or splashing) and no objects filled with liquids, such as vases, should be placed on the apparatus.



This product is manufactured to comply with the EEC DIRECTIVE 89/336/EEC, 93/68/EEC and 73/23/EEC.



Disposal of your old appliance

1. When this crossed-out wheeled bin symbol is attached to a product it means the product is covered by the European Directive 2002/96/EC.
2. All electrical and electronic products should be disposed of separately from the municipal waste stream via designated collection facilities appointed by the government or the local authorities.
3. The correct disposal of your old appliance will help prevent potential negative consequences for the environment and human health.
4. For more detailed information about disposal of your old appliance, please contact your city office, waste disposal service or the shop where you purchased the product.

IMPORTANT SAFETY INSTRUCTIONS

CAUTION: PLEASE READ AND OBSERVE ALL WARNINGS AND INSTRUCTIONS IN THIS OWNER'S MANUAL. AND THOSE MARKED ON THE PRODUCT. RETAIN THIS BOOKLET FOR FUTURE REFERENCE.

This product has been designed and manufactured to assure personal safety. Improper use can result in electric shock or fire hazard. The safeguards incorporated in this product will protect you if you observe the following procedures for installation, use, and servicing.

This product does not contain any parts that can be repaired by the user.

DO NOT REMOVE THE CABINET COVER, OR YOU MAY BE EXPOSED TO DANGEROUS VOLTAGE. REFER SERVICING TO QUALIFIED SERVICE PERSONNEL ONLY.

- 1. Read these instructions.** - All these safety and operating instructions should be read before the product is operated.
- 2. Keep these instructions.** - The safety, operating and use instructions should be retained for future reference.
- 3. Heed all warnings.** - All warnings on the product and in the operating instructions should be adhered to.
- 4. Follow all instructions.** - All operating and use instructions should be followed.
- 5. Do not use this apparatus near water.** - For example: near a bath tub, wash bowl, kitchen sink, laundry tub, in a wet basement; or near a swimming pool; and other areas located near water.
- 6. Clean only with dry cloth.** - Unplug this product from the wall outlet before cleaning. Do not use liquid cleaners.
- 7. Do not block any ventilation openings. Install in accordance with the manufacturer's instructions.** - Slots and openings in the cabinet are provided for ventilation and to ensure reliable operation of the product and to protect it from over-heating. The openings should never be blocked by placing the product on a bed, sofa, rug or other similar surface. This product should not be placed in a built-in installation such as a bookcase or rack unless proper ventilation is provided or the manufacturer's instructions have been adhered to.
- 8. Do not install near any heat sources such as radiators, heat registers, stoves, or other apparatus (including amplifiers) that produce heat.**
- 9. Do not defeat the safety purpose of the polarized or grounding-type plug.** A polarized plug has two blades with one wider than the other. A grounding type plug has two blades and a third grounding prong. The wide blade or the third prong are provided for your safety. If the provided plug does not fit into your outlet, consult an electrician for replacement of the obsolete outlet.
- 10. Protect the power cord from being walked on or pinched particularly at plugs, convenience receptacles, and the point where they exit from the apparatus.**
- 11. Only use attachments/accessories specified by the manufacturer.**
- 12. Use only with the cart, stand, tripod, bracket, or table specified by the manufacturer, or sold with the apparatus. When a cart is used, use caution when moving the cart/apparatus combination to avoid injury from tip-over.**
- 13. Unplug this apparatus during lightning storms or when unused for long periods of time.**
- 14. Refer all servicing to qualified service personnel. Servicing is required when the apparatus has been damaged in any way, such as power-supply cord or plug is damaged, liquid has been spilled or objects have fallen into the apparatus, the apparatus has been exposed to rain or moisture, does not operate normally, or has been dropped.**



Safety warnings and Cautions

The following are warnings and cautions for the safety of the users and for the prevention of any property damage. Please read the following carefully.

WARNING

- Turn off the system before installation. Do not plug in several electric devices to the same outlet.
 - This may cause heating, fire, or electric shock.
- Do not place any liquid container on the system, such as water, coffee, or other beverage.
 - If liquid is poured onto the system, it can cause a system breakdown or fire.
- Prevent the power cable from being severely bent or having pressure exerted on it by a heavy object.
 - This may cause fire.
- Clean the dust around the system on a regular basis. When cleaning the system, always use a dry cloth. Do not use a wet cloth or other organic solvents.
 - This may damage the surface of the system and can cause a system breakdown or electric shock.
- Avoid any place with moisture, dust, or soot.
 - This can cause fire or electric shock.
- When pulling the power cable from the plug, do so gently. Do not touch the plug with wet hands and avoid using the plug if the holes in the outlet are too loose.
 - This may cause fire or electric shock.
- Do not attempt to disassemble, repair, or modify the system on your own. It is extremely dangerous due to the high voltage running through the system.
 - This may cause fire, electric shock, or serious injury.
- Check for any danger signs such as a moist floor, a loosened or damaged power cable, or an unstable surface. If you encounter any problems, ask your dealer for assistance.
 - This may cause fire or electric shock.
- Keep a distance of at least 15cm between the back of the system and the wall for the cables connected to the system otherwise, they may be bent, damaged, or cut.
 - This may cause fire, electric shock, or injury.
- Install the system in a cool place without direct sunlight and always maintain room temperature. Avoid candlelight and heat generating devices such as heaters. Keep the system away from places where many people pass.
 - This may cause fire.
- Install the system on a plain surface with sufficient air ventilation. Do not place the system on an elevated surface.
 - This may cause system breakdown or serious injury.
- The power outlet must be placed on the ground, and the voltage range must be within 10% of the voltage rate. Do not use the same outlet with a hair dryer, iron, refrigerator, or any heating appliances.
 - This may cause fire, over heating or electric shock.
- When the system's battery is depleted, replace it with the same or equivalent type of battery specified by the manufacturer. Depleted batteries should be discarded according to the manufacturer's instructions.
 - This may cause an explosion.
- If the system's HDD exceeds its life span, you may not be able to recover any data stored inside the HDD. If the video on the system screen appears 'damaged' while playing a recording stored inside the system's HDD, it must be replaced with a new one. Ask for an engineer's assistance for HDD replacement from your dealer.
 - LG Electronics is not responsible for deleted data caused by user mishandling.

CAUTION

Please beware of the following precautions before installing the DVR.

- Avoid positioning the product in any place where the unit may come into contact with moisture, dust, or soot.
 - Avoid placing in direct sunlight or near heating appliances.
 - Keep the product away from electric sparks or magnetic substances.
 - Avoid temperature extremes (recommended operating temperature is between 0°C - 40°C).
 - Do not place any conductive material through the ventilation grills.
 - Keep the system turned off before installation.
 - Ensure enough space is left for cable connections.
 - Place the system on a solid surface with sufficient air ventilation. Avoid any surface that vibrates.
 - Placing the system near electronic devices such as a radio or a TV may cause the product to breakdown.
 - Do not disassemble the product without seeking assistance from LG Electronics.
 - Do not place any heavy object on the system.
-
- Prevent any substances from being inserted into the system.
 - This may cause system breakdown.
 - Install the system in a place with sufficient air ventilation.
 - Keep at least 15cm distance between the back of the system and the wall, and at least 5cm distance between the side of the system and the wall.
 - Do not install the system in a place with high magnetic, electric wave, or wireless devices such as a radio or a TV.
 - Do not install the system in a place with magnetic objects, electric frequencies, or vibration.
 - Do not place any heavy object on the system.
 - This may cause system breakdown.
 - Install the system on a stable, level surface.
 - The system may not operate properly.
 - Install the system in a place with appropriate moisture and temperature levels.
 - Avoid installing the system in a place with high (over 40°C) or low (under 0°C) temperature.
 - The system can be damaged from a strong impact or vibration. Avoid throwing objects within the vicinity of the system.
 - Avoid direct sunlight or any heating appliances.
 - Recommended operating temperature is over 0°C (32°F).
-
- Ventilate the air inside the system operation room, and tighten the system cover firmly.
 - System breakdown may be caused by an inappropriate environment.
 - It is recommended to use AVR (Automatic Voltage Regulator) for a stable power supply.
 - It is recommended to coil the core-ferrite around the connector of the system to avoid electromagnetic interference.
 - The outlet must be placed on the ground.
 - If there is strange sound or smell, unplug the power cable immediately and contact the service center.
 - This may cause fire or electric shock.
 - In order to maintain stable system performance, have your system checked regularly by the service center.
 - LG Electronics is not held responsible for system breakdown caused by user mishandling.
 - There is a risk of explosion if a battery is replaced by an incorrect type. Dispose of used batteries according to the instructions.
 - Do not overturn the product during use.

INTRODUCTION

Features	7
Front Panel	8-9
Rear Panel	10
Remote Control	11

HOOKUP AND SETTINGS

Precautions	12
Basic Connection Overview	12
Connecting the RS-422/485 Device	13
Connecting Sensor Input and Alarm Output	13
Connecting the USB Device	14
Network Connection	14
Connecting the RS-232C Port	14
Connecting CONSOLE	14
Concerning the Internal Hard Disk Drive ...	15
Installing or Replacing the Hard Disk Drive	15-19
Before Operating the System	19
System Operation	20
System Shutdown	20
General Explanation of the Live Screen on the Main Monitor	21
Selecting Live Screen Mode	22
PTZ Camera Control	23-24
Viewing System Information	24
Viewing the System Log List	24
Menu Configuration	25
Camera Settings	26-27
Schedule Settings	28-29
Display Settings	30
Event Settings	31
Network Settings	32-33
System Settings	34-37

RECORDING

Instant Recording	38
-------------------------	----

SEARCH AND PLAYBACK

PLAYBACK	39
SEARCH	40-43
EXPORT	44

CLIENT PROGRAM

PC Requirements	45
Client Program Installation	45
Connecting to the DVR	46-47
Live Mode	48-50
Search Mode	51-52
Remote Setup Mode	53-57

ADDITIONAL PROGRAMS

Emergency Agent Program	58-59
Export Viewer Program	59-60

REFERENCE

Troubleshooting	61-63
Recommended Devices	64
Factory Default Configuration Settings ...	65-67
Recording Time Table (250GB HDD) ...	68-69
Specifications	70

INTRODUCTION

Features

- Stable embedded Linux operating system.
- Journal filing system for HDD file recovery following power recovery.
- Small file sizes through MPEG-4 compression.
- Internal storage expandable to 2TB. (Expandable if new high capacity HDD is launched)
- NTSC and PAL selectable video format.
- Full realtime recording.
 - Up to 480IPS@352 X 240: LDV-S504 NTSC
 - Up to 400IPS@352 X 288: LDV-S504 PAL
 - Up to 270IPS@352 X 240: LDV-S503 NTSC
 - Up to 220IPS@352 X 288: LDV-S503 PAL
- Various recording resolutions and quality levels.
 - D1(704x480), Half D1(704x240), CIF(352x240) : NTSC
 - D1(704x576), Half D1(704x288), CIF(352x288) : PAL.
 - 5 step quality level (Best, High, Normal, Low, Lowest).
- Easy operation using various user interface & user friendly GUI.
 - Optical mouse, Full function IR remote controller, Jog/Shuttle
- Powerful multiplex function.
 - Simultaneous live display, recording, playback, network transmission, back-up.
- Various search function.
 - Date/time search, event search, bookmark search, smart search.
- Event data protection by event partition recording.
- Pre-alarm recording (Up to 1minute).
- Motion event recording and preview test function of motion sensitivity.
- Recording image rate & quality adjustment per individual camera.
- Powerful record scheduling.
- Instant playback in surveillance mode.
 - Play within 1~2 sec of recording start.
- POP(picture over picture) playback.
 - Viewing live and playback video simultaneously.
- 8 audio channel input & perfect audio/video synchronization.
 - Recording and playback of eight audio channels.
 - Perfect audio/video synchronization during recording, playback, and network transmission.
- Automatic backup by schedule.
- Image authentication (Watermark).
- Three USB 2.0 ports for backup interface.
- Setup configuration export/import with USB memory stick or network.
- Easy system S/W update with USB memory stick or network.
- Clients S/W can manage max 100 DVR servers.
- Max five clients can access one DVR server simultaneously.
- Network bandwidth throttle.
 - Automatically adjust a bandwidth according to network speed status of unit.
- Remote alarm notification via client software or E-mail.
- Time and date sync from NTP server.
- Daylight saving mode.
- Covert camera protection.
- Back-up CD auto run.
- User management (User level control).
- PTZ Control.
 - For more details see page 64.
 - Dome camera telemetry control (Dome OSD control).

Model LDV-S504 (16 Channel) is used for the description, operation and details provided in this operating guide.

Front Panel

■ LDV-S504

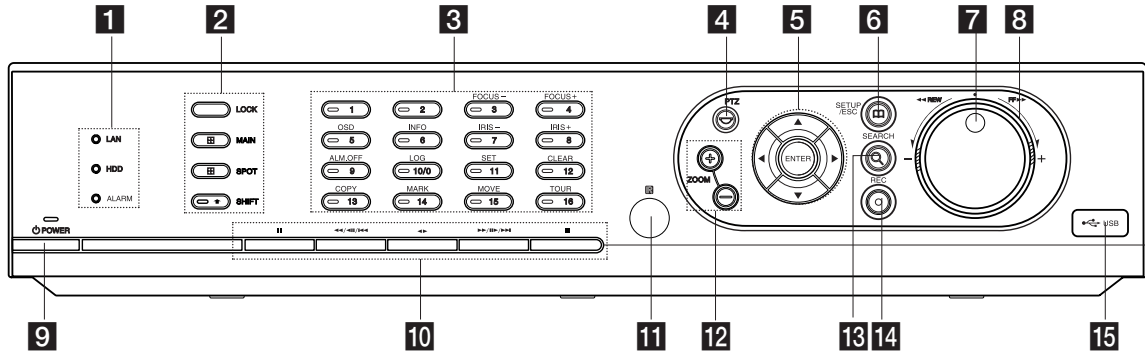

■ LDV-S503

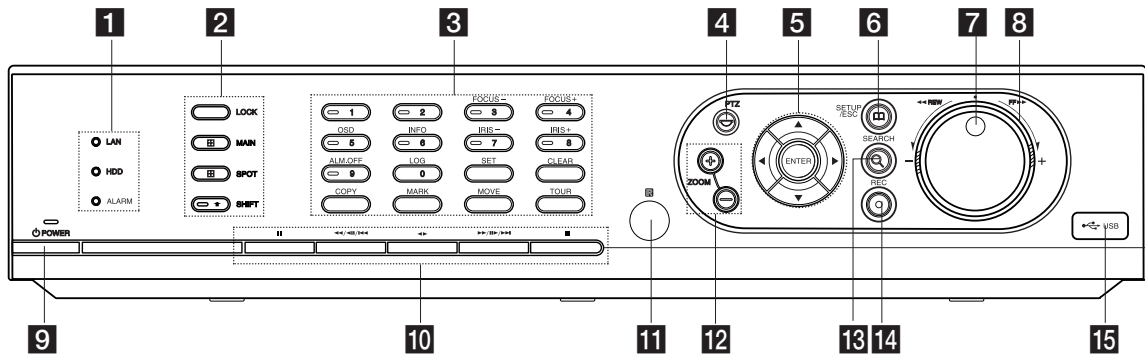

1 LAN Indicator
Lights when the network is connected.

HDD Indicator
Blinks when the HDD is accessed.

ALARM Indicator
Lights when the alarm out is in progress.

2 LOCK
Displays the lock menu to change the user type or disable the system operation.

MAIN
Display the MAIN menu to set the screen mode to full, 4, 6, 8, 9 or 16 screens. Set the video output signal to VGA mode.

SPOT
Enter SPOT mode to allow spot monitor control. Set the video output signal to MAIN-OUT and S-VIDEO mode.

SHIFT
If you use the Sub-function of the channel button, the button is activated.

3 Channel Buttons
You can input a number with channel buttons. You can also use the channel buttons for sub-function with SHIFT button. The LED in the button indicates the status as follows:

- Off: No video input signal.
- Green: The current status is for live mode.
- Red: Recording mode.
Blinks when an event occurs.

(3) FOCUS - / (4) FOCUS +
Adjusts focus position.

(5) OSD
Accesses or removes the System Control Bar (OSD).

(6) INFO

Displays or removes system information.

(7) IRIS - / (8) IRIS +

Adjust iris position.

(9) ALM.OFF

Cancels alarm activation and returns the system to the condition before the alarm was activated.

(10/0) LOG

Displays or removes the System Log List.

(11) SET

Registers the PTZ camera's preset position.

(12) CLEAR

Deletes a memorized preset position.

(13) COPY

Copies the recording data to an external device.

(14) MARK

Sets the mark point for recording search.

(15) MOVE

Moves the camera to the preset position.

(16) TOUR

Tours all registered preset positions in the camera.

4 PTZ

Switches this unit to PTZ mode to control the PTZ camera connected.

5 Arrow Buttons (◀ ▶ ▲ ▼)

Select or move between the menu options.

ENTER

Confirms menu selections.

6 SETUP/ESC

Displays the setup menu or cancels operation on the setup menus.

7 JOG Dial

Allows a forward or reverse frame search.

In pause mode, plays recorded images frame by frame through rotation. Increases or decreases the options value.

8 Shuttle Ring

Fast forward or reverse picture search when the dial is rotated.

9 Power

Turns DVR on or off.

Press and hold for more than 2 seconds to turn on or off.

10 Playback Control Buttons

- **II**: Pauses playback.

- **◀◀/◀II/▶▶**: Search the recorded images in reverse or skip the recorded images.

- **◀▶**: Playback or reverse playback of recorded images.

- **▶▶/II▶/▶▶**: Forward search the recorded images or skip the recorded images.

- **■**: Stops playback.

11 Remote Sensor

Point the remote control here.

12 ZOOM + / -

Zooms in/out on live images or on playback window.

13 SEARCH

Displays the search menu.

14 REC

Starts or stops recording.

15 USB Port

Connect an external USB device for backup or playback.

Accessories

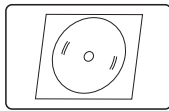

Software Install CD

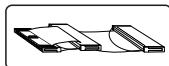

IDE Cable

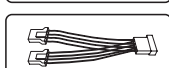

Extension HDD Power Cable

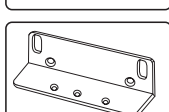

Rack Mount Bracket

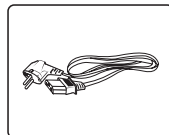

Power Plug

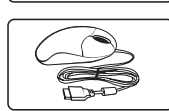

Mouse

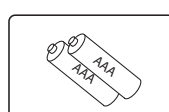

AAA Type Battery

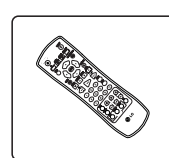

Remote Control

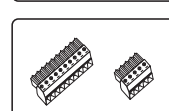

Terminal Blocks

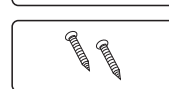

Screws

Rear Panel

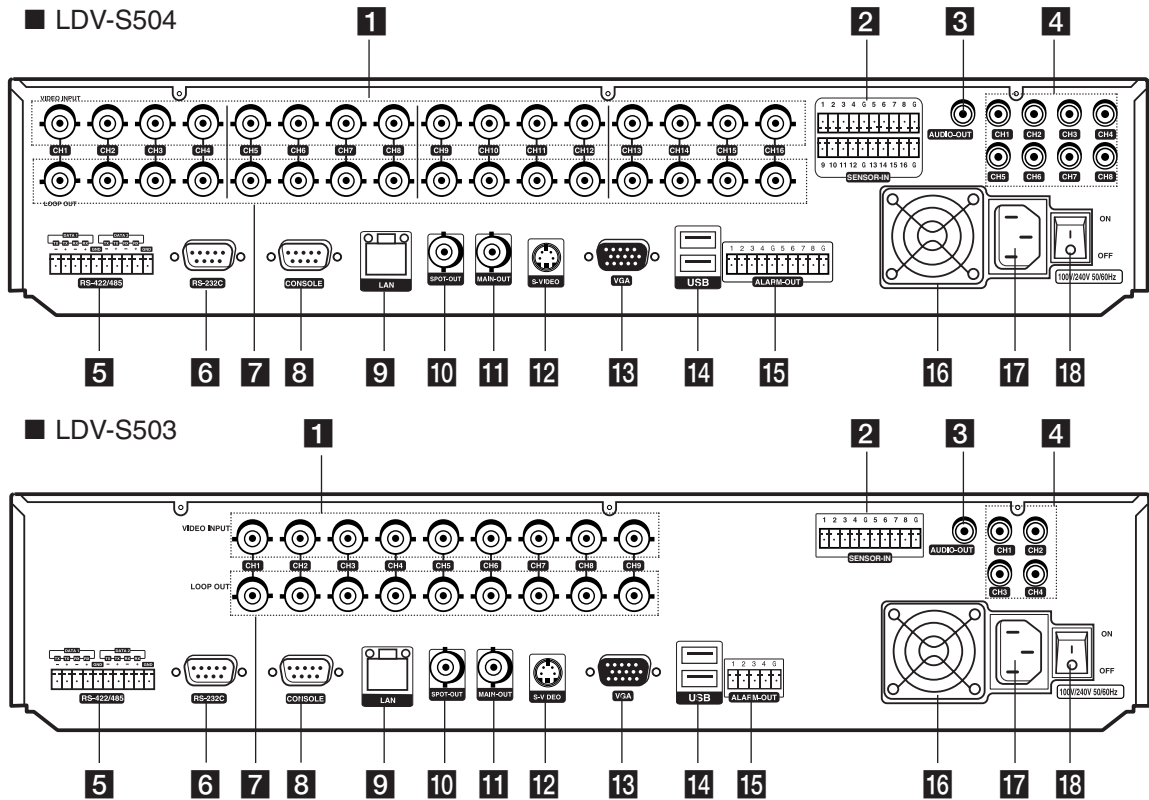

- | | |
|---|---|
| <p>1 VIDEO INPUT
Connect the camera's video output to these BNC connectors.</p> <p>2 SENSOR-IN Terminals
Input terminals for alarm signal.</p> <p>3 AUDIO OUT
Connect the audio input signal of an external device.</p> <p>4 AUDIO INPUT
Connect the audio output of an external device.</p> <p>5 RS-422/485 Terminals
Connect RS422/485 compatible cameras.</p> <p>6 RS-232C Connector
Used to connect to a host device equipped with RS-232C connector (such as a personal computer). This unit can be controlled from other devices via this connector.</p> <p>7 LOOP OUT
The signal from VIDEO INPUT connector is looped out to this connector.</p> <p>8 CONSOLE
Used to connect to a host device equipped with RS-232C connector (such as a personal computer). This unit can be controlled from other devices via this connector.</p> | <p>9 LAN Port
Connect the ethernet 10/100Mbps network cable for controlling this unit via a PC network.</p> <p>10 SPOT-OUT (BNC Type Connector)
Connect to spot monitor or display device.</p> <p>11 MAIN-OUT (BNC Type Connector)
Connect to main monitor or display device.</p> <p>12 S-VIDEO
Connect an S-Video compatible monitor. The image will be the same as when the monitor is connected to the MAIN-OUT jack.</p> <p>13 VGA
Connect a VGA monitor.</p> <p>14 USB Ports
Connect an optional extension USB device.</p> <p>15 ALARM-OUT Terminals
Output terminals for alarm signal.</p> <p>16 Cooling Fan</p> <p>17 Power Cord Inlet (AC IN)
Connect the power plug.</p> <p>18 Power Switch
Turns the main power on and off.</p> |
|---|---|

Remote Control

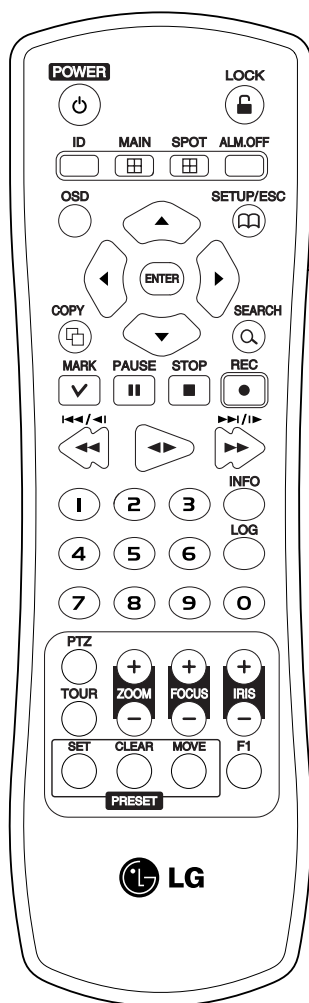

POWER (⏻)

Turns DVR on or off.

LOCK

Displays the lock menu to change user type or disable system operation.

ID

Set the appropriate DVR system ID to operate via the IR Remote Controller when using the multiple DVR.

Press the ID button then press the number button within 2 seconds to select the system ID of the DVR. If you set the system ID to "0", you can control multiple DVR at the same time.

MAIN

Displays the MAIN menu to set the screen mode to full, 4, 6, 8, 9 or 16 screens.

SPOT

Enter SPOT mode to allow spot monitor control.

ALM.OFF

Cancels alarm activation and returns the system to the condition before the alarm was activated.

OSD

Accesses or removes the system control bar (OSD).

SETUP/ESC

Displays the setup menu or cancels operation of the setup menu.

Arrow Buttons (◀▶▲▼)

Selects or moves between the menu options.

ENTER

Confirms menu selections.

COPY

Copies the recording data to an external device.

SEARCH

Displays the search menu.

MARK

Sets the mark point for recording search. You can set the mark point during the single channel playback of recorded data.

PAUSE (⏸)

Pauses playback.

STOP (■)

Stops playback.

REC (●)

Starts or stops recording.

◀◀/◀||/▶▶

Searches the recorded images in reverse or skips the recorded images.

◀▶

Playback or reverse playback of recorded images.

▶▶/||▶▶/▶▶▶▶

Forward searches the recorded images or skips the recorded images.

Number Buttons (0,1-9)

To select the PTZ preset number, ID, or channel.

INFO

Displays or removes the system information window.

LOG

Displays or removes the System Log List window.

PTZ

Switches this unit to PTZ mode to control the connected PTZ camera.

TOUR

Tours all registered preset positions in the camera.

ZOOM + / -

Zooms in/out on live images or on the playback window.

FOCUS + / -

Adjusts the focus of a camera.

IRIS + / -

Adjusts the iris of a camera.

PRESET

- SET: Registers the PTZ camera's preset positions.
- CLEAR: Deletes a memorized preset position.
- MOVE: Moves the camera to the preset position.

F1

This button is not available.

HOOKUP AND SETTINGS

Precautions

- Depending on the camera and other equipment there are various ways to connect the unit. Please refer to the camera manual or manuals for other devices as necessary for additional connection information.
- Be sure to switch off the camera before installation and connection.

Basic Connection Overview

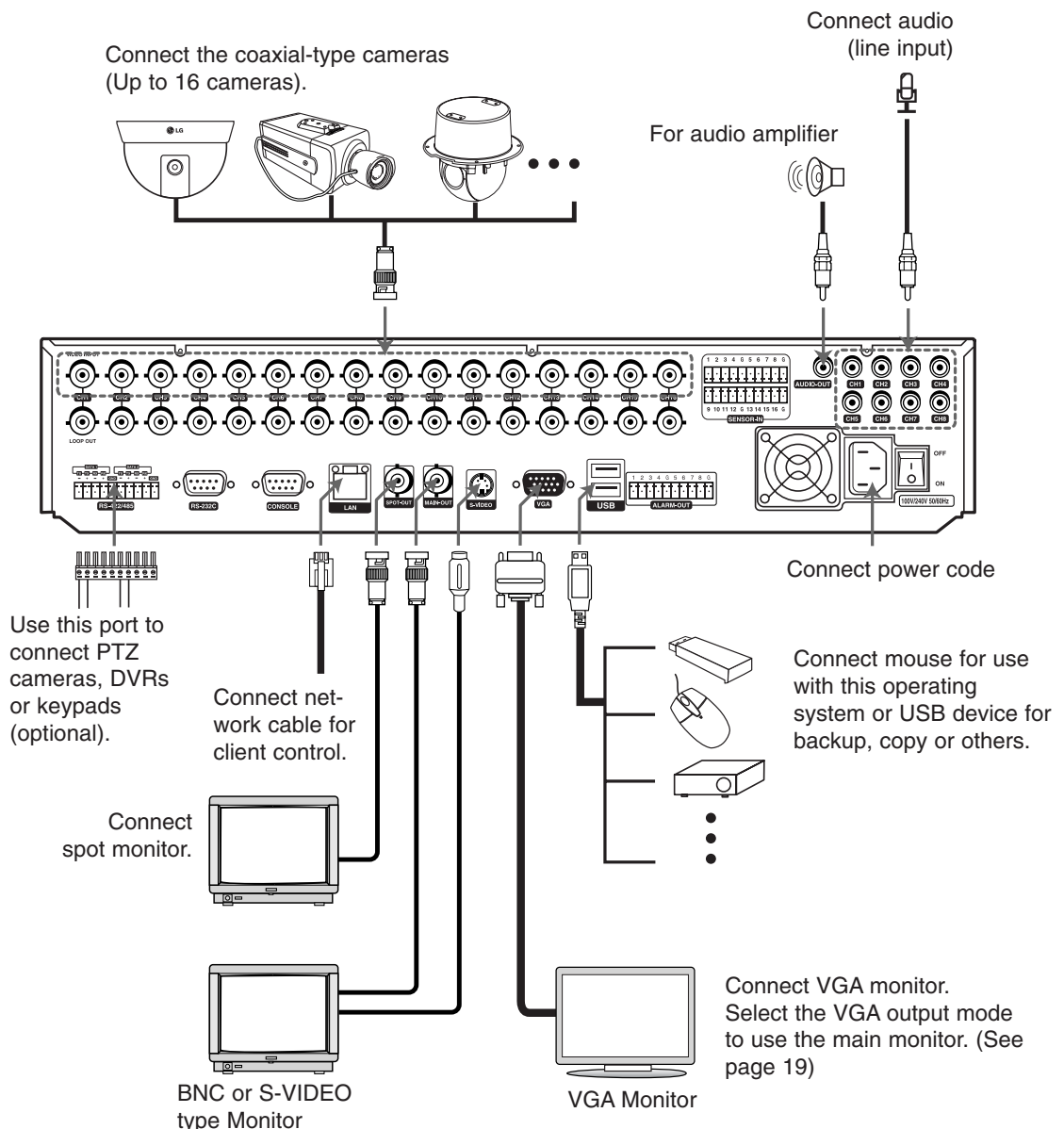

Connecting the RS-422/485 Device

This DVR has two data terminals. Use this port to connect PTZ cameras, DVRs or key-pads (optional).

Example, when the PTZ camera is connected.

1. Connecting the PTZ serial communication lines to terminal block.
2. Connecting the terminal block to the RS-422/485 terminal.

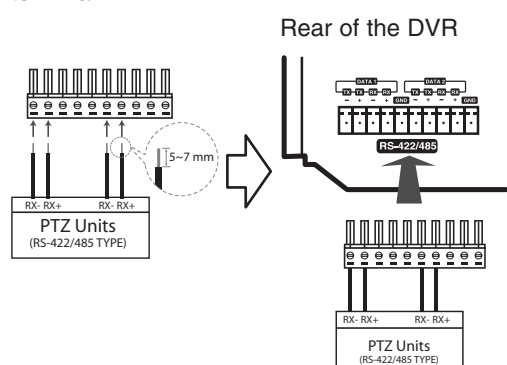

RS-422/485 Terminal	Description
TX - (DATA -)	Data Transmission
TX + (DATA +)	Data Transmission
RX - (DATA -)	Data Reception
RX + (DATA +)	Data Reception
GND	Shield

Notes:

- When connecting lines, connect the TX - of the DVR to RX - of the PTZ unit and TX + of the DVR to RX + of the PTZ unit correctly.
- Recommended initial data are 9600 Baud Rate, 8 Data bits, 1 Stop bit and No parity.
- When connecting PTZ cameras to DVRs it is necessary to set the setup menu for this unit according to the RS-485 settings of the camera and DVRs.

Connecting Sensor Input and Alarm Output

Alarm terminals are used to connect the alarm devices such as sensors, door switches, etc.

Sensor Input

Connect up to 16 alarm sensors (LDV-S503: 8 alarm sensors) using the terminal blocks.

Each alarm sensor should be connected with G (GND). The signal state is adjustable to N/O (Normal Open) or N/C (Normal Close) through the setup menu.

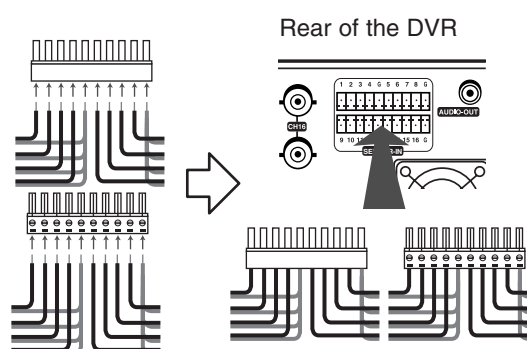

Terminal No.	Description
1	Sensor Input 1
2	Sensor Input 2
3	Sensor Input 3
4	Sensor Input 4
G	Ground
5	Sensor Input 5
6	Sensor Input 6
7	Sensor Input 7
8	Sensor Input 8
G	Ground
9	Sensor Input 9
10	Sensor Input 10
11	Sensor Input 11
12	Sensor Input 12
G	Ground
13	Sensor Input 13
14	Sensor Input 14
15	Sensor Input 15
16	Sensor Input 16
G	Ground

Alarm Output

Connect up to 8 separate alarms (LDV-S503: 4 separate alarms) to the alarm output.

Alarm signal output at an event occurrence.

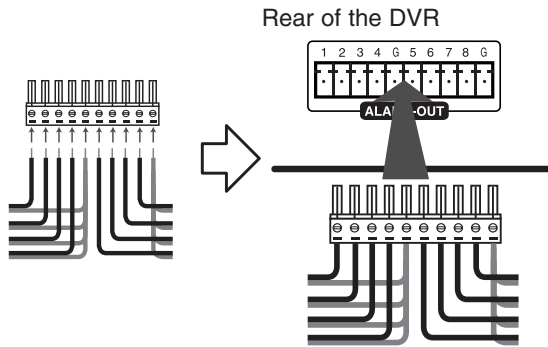

Note:

The internal switching relays are rated for 0.5A at 125V AC or 1A at 30V DC. If the electric current is higher than that the unit can be damaged.

Terminal No.	Description
1	Alarm output 1
2	Alarm output 2
3	Alarm output 3
4	Alarm output 4
G	Ground
5	Alarm output 5
6	Alarm output 6
7	Alarm output 7
8	Alarm output 8
G	Ground

Connecting the USB Device

USB Memory Device

Insert the memory device into the USB port. The system automatically recognizes the device.

Using a USB memory device the system S/W can be easily upgraded.

USB Backup Device

Connect the USB cable of the USB backup device to the USB port on the rear panel of the unit.

(Example: CD/DVD-R/RW drive, HDD, and other external storage.)

Mouse

Connect the USB mouse for function control of the unit.

Network Connection

LAN Connection

Connect the LAN port to an available 10/100 base-T port with a straight ethernet cable (not supplied). The LAN indicator on the front panel will be lit.

Automatic Network Configuration

The DVR can automatically obtain and configure the network interface via DHCP. (see page 32)

Manually Configure Network

The DVR may be manually configured by assigning an IP address, subnet mask, gateway DNS. (see page 32)

Connecting the RS-232C Port

The RS-232C is used for communication with a connected PC. This terminal is compliant with the RS-232C standard.

Connecting CONSOLE

Used to connect to a host device equipped with an RS-232C connector (such as a personal computer). This unit can be controlled from other devices via this connector.

Concerning the Internal Hard Disk Drive

The internal hard disk drive (HDD) is a fragile piece of equipment. Please follow the guidelines below when using the DVR to protect against possible HDD failure.

We recommend that you back up your important recordings onto an external backup device in order to prevent accidental loss.

Make sure that the power is turned OFF when attaching or removing the HDD.

- Do not move the DVR while the power is on.
- Do not block the rear vent/cooling fan.
- Do not use the DVR in excessively hot or humid places, or in places that may be subject to sudden changes in temperature. Sudden changes in temperature can cause condensation to form inside the DVR. This can be a cause of HDD failure.
- While the DVR is switched on, do not unplug from the wall socket or switch the electricity off from the breaker switch.
- If there's a power failure while the DVR is on there is a chance that some data on the HDD will be lost.
- Do not drop the HDD. Also do not put the metallic object such as coins or screwdrivers into the HDD tray.
- When a power failure occurs during recording, avoid adding, replacing or transporting the HDD as the recorded data may be erased. In this case, turn the power back on to boot up the unit normally with the HDD that was being used at the time of the power failure attached. Then add, replace, or transport the HDD.
- The HDD is very delicate. Handle the HDD with care and follow the precautions below because even a small shock may damage the internal components of the HDD.
 - Do not place the HDD on a desk or a table directly. Put a thick cushion under the HDD because even a small shock may damage the internal components of the HDD.
 - Do not use an electric screwdriver. Vibrations and shocks caused by an electric screwdriver may damage the internal components of the HDD.
 - When replacing the HDD, do not knock the HDD with other components such as another HDD and the HDD tray.
 - Do not knock the HDD with tools such as a driver when replacing the HDD.
- Protect the hard disk drives from static electricity.

Installing or Replacing the Hard Disk Drive

Installing the Hard Disk Drive

You can install up to 4 HDDs.

However, since the product contains many parts which may incur electric shocks, accidents or product breakdown, and because improper installation or setup may disturb HDD recognition or normal product operation, you should consult with an expert from the store where the product was purchased.

Turn the power of the unit off and detach the power plug from the outlet.

1. Remove the fixing screws on the left/right side and rear panel.

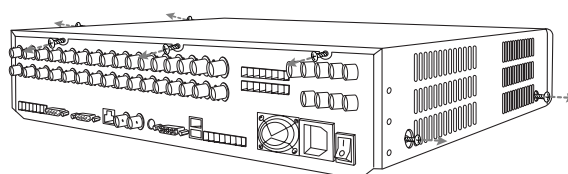

2. Detach the top case by sliding it after removing the screws.

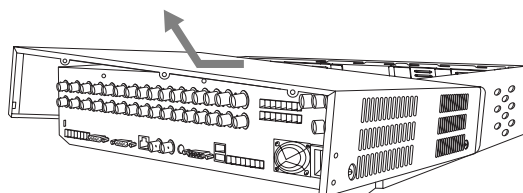

3. Detach the front panel as shown below.

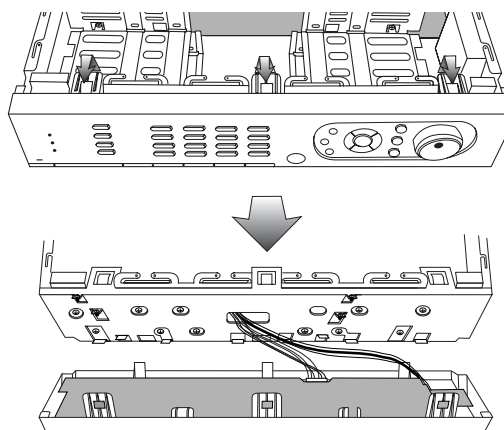

- Remove the screws and detach the hard disk mounting brackets from the unit.

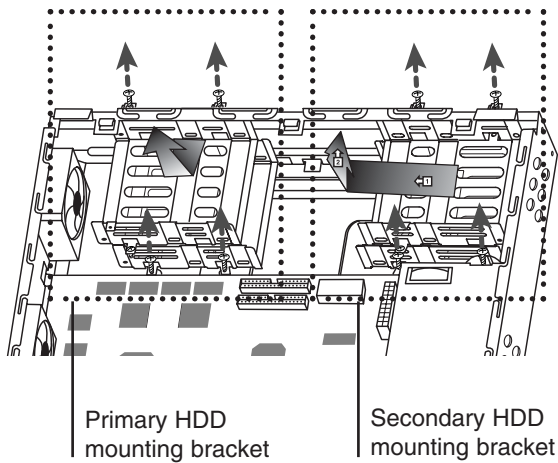

- Attach the HDD onto the hard disk mounting brackets with four screws as shown below.

- When installing 1 HDD.
: Attach the HDD onto the upper side of the Primary HDD mounting bracket and set the Primary Master HDD.

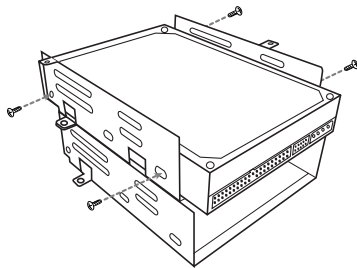

- When installing 2 HDDs.
1 Attach one of the HDDs onto the upper side of the primary HDD mounting bracket and set the primary master HDD.
2 Attach the other HDD onto the lower side of the primary HDD mounting bracket and set the primary slave HDD.

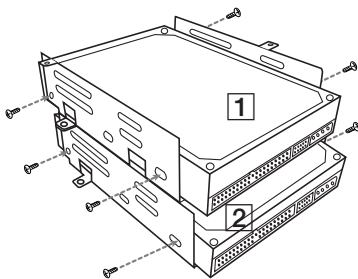

- When installing 3 HDDs.

- Attach the first HDD onto the upper side of the primary HDD mounting bracket and set the primary master HDD.
- Attach the second HDD onto the lower side of the primary HDD mounting bracket and set the primary slave HDD.
- Attach the third HDD onto the upper side of the secondary HDD mounting bracket and set the secondary master HDD.

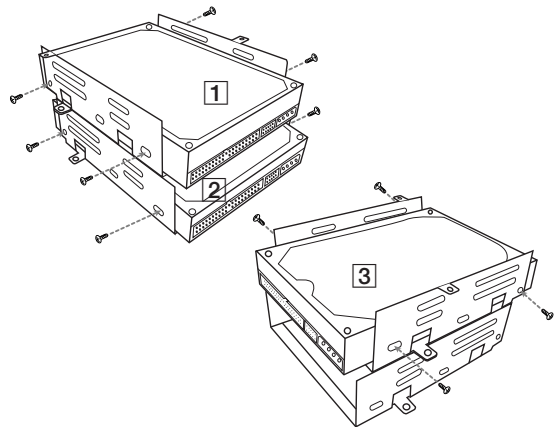

- When installing 4 HDDs.

- Attach the first HDD onto the upper side of the primary HDD mounting bracket and set the primary master HDD.
- Attach the second HDD onto the lower side of the primary HDD mounting bracket and set the primary slave HDD.
- Attach the third HDD onto the upper side of the secondary HDD mounting bracket and set the secondary master HDD.
- Attach the fourth HDD onto the lower side of the secondary HDD mounting bracket and set the secondary slave HDD.

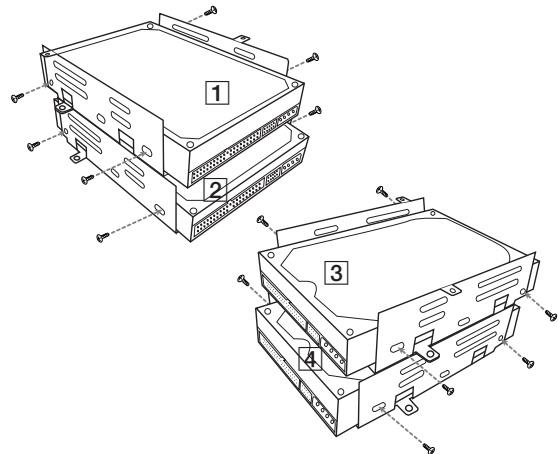

6. Connect the HDD power cable extension.

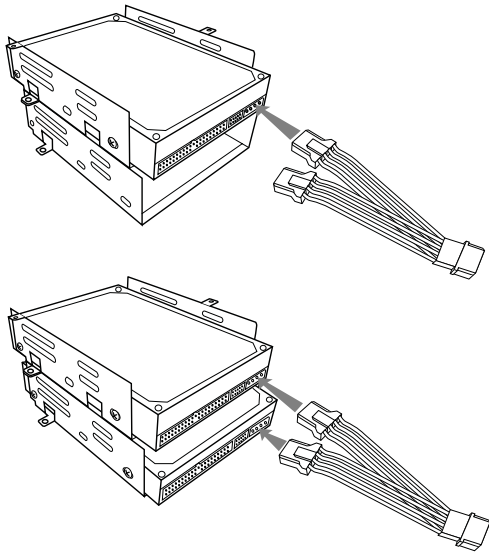

7. Connect the IDE cable.
You must connect the IDE cable as shown below.

- When installing 1 or 2 HDDs.
Connect the IDE cable to the IDE terminal of the HDD using the primary IDE cable.

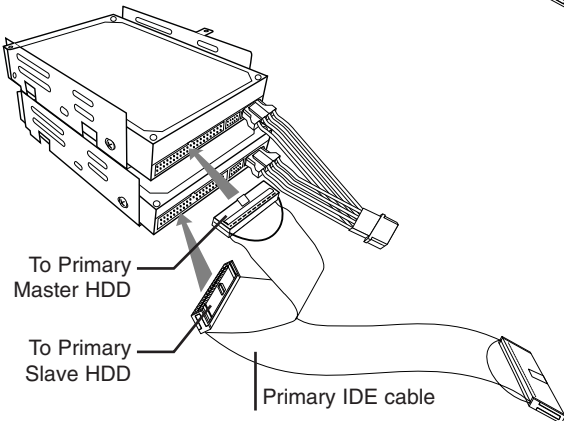
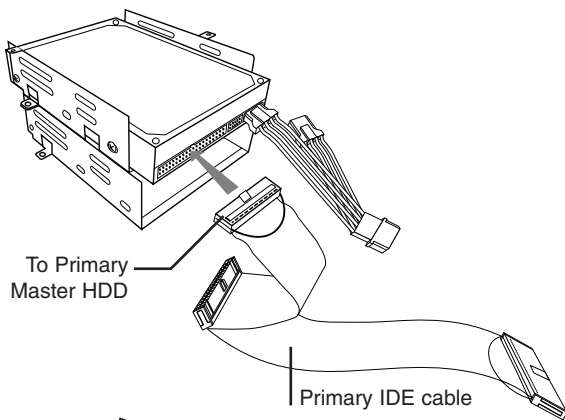

- When installing 3 HDDs.
Connect the IDE cable to the IDE terminal of HDD using the Primary and Secondary IDE cables.

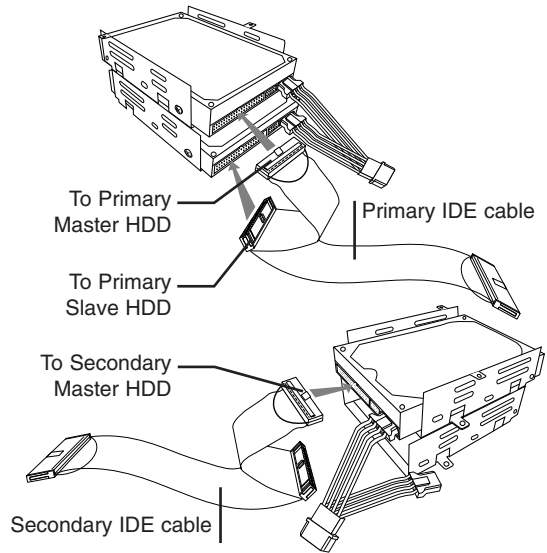

- When installing 4 HDDs.
Connect the IDE cable to the IDE terminal of the HDD using the primary and secondary IDE cables.

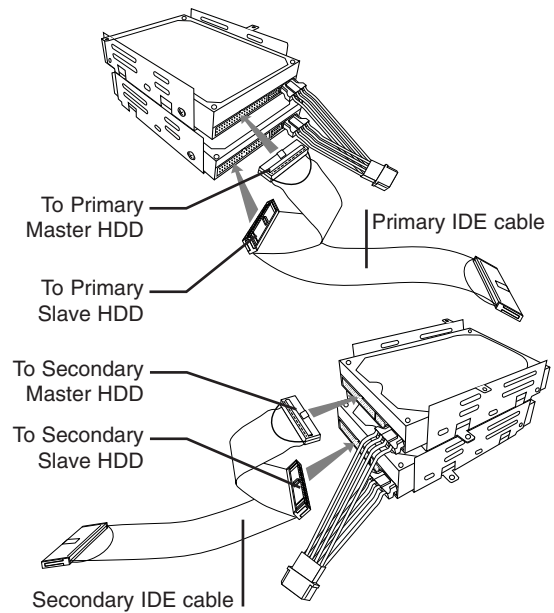

8. Attach the hard disk mounting brackets with the screws.
9. Connect the power cable.

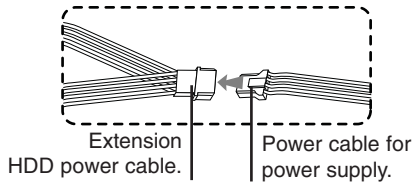

10. Connect the IDE cable to the IDE connector on the main board. You must connect the IDE cable as shown below.

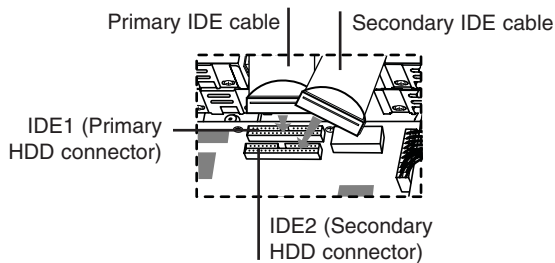

11. Assemble the front panel and top case.
12. Fix the screws.
13. After installing the HDD, you must format the HDD using the setup menu (See page 35).

Notes:

- When you add the new HDD, do not change the position or jump setting of the HDD. It may delete the current data and cause a malfunction.
- You must connect the primary IDE cable to the primary IDE connector on the main board and the secondary IDE cable to the secondary IDE connector on the main board.

Replacing the Hard Disk Drive

Turn the power of the unit off and detach the power plug from the outlet.

1. Follow steps 1-3 described in "Installing the Hard Disk Drive".
2. Remove the screws and detach the hard disk mounting brackets from the unit.

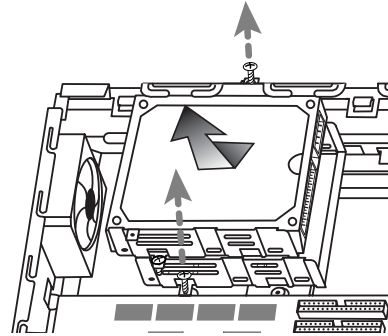

3. Remove the connector from the HDD.

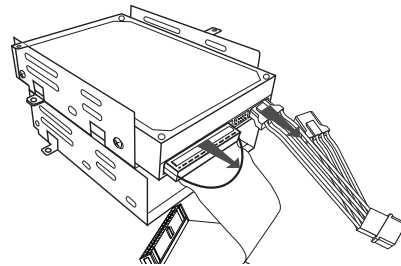

4. Remove the screws from the hard disk drive on the left/right side of the hard disk the mounting bracket.

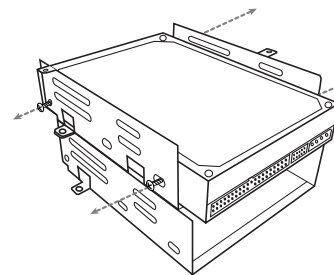

- Remove the HDD from the hard disk mounting bracket.

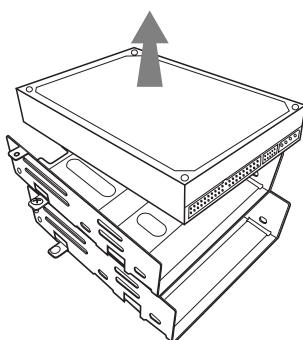

- Install the new HDD in the reverse order to when replacing the hard disk drive.
- After replacing the hard disk drive, insert the power plug into the outlet and turn the power of the unit on.

Notes:

- **When you install or replace the HDDs to the hard disk mounting bracket, you must set the HDD jumper to slave or master. You must install the HDD as shown below.**
 - **Upper sides: Set the master HDD.**
 - **Lower sides: Set the slave HDD.**
- How and where to set the HDD jumper depends on the manufacturer or model specification. Therefore, carefully read the instructions printed on top of the product or in the manual enclosed with the product before installing the jumper.
 - If the jumper pin settings are identical with each other in terms of priority, either HDD may not be detected in the DVR or malfunction may occur.
- Make sure that each of the IDE cables is connected to the connector housing through its holes.
- Do not stack them nor keep them upright.
- Do not use an electric screwdriver to fix them.

Before Operating the System

You can select the main monitor type to display the main screen.

- Insert the power plug to an outlet. (Make sure the power source is AC 100~240V, 50/60Hz)
- Turn on the main power switch on the rear panel. The power indicator LED on the front panel will show a red light.
- Select monitor type.

VGA Monitor:

When you connect the VGA jack on the rear of the DVR, press and hold the MAIN button on the front panel until the beep sounds to display the main screen.

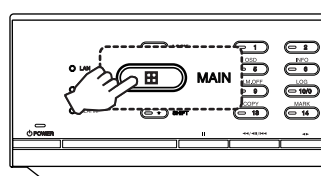

CCTV (Composite Video Type) Monitor:

When you connect the MAIN-OUT or S-VIDEO jack on the rear of the DVR, press and hold the SPOT button on the front panel until the beep sounds to display the main screen.

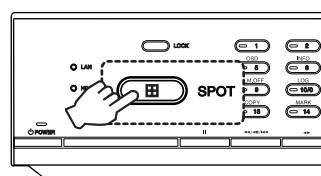

Note:

You can select the monitor type by using the MAIN or SPOT button at anytime. If you change the monitor type, the system will be rebooted automatically.

- Turn on the sub-power.

Recommended HDD

The following HDD has been tested and compatibility is ensured. When you attach multiple HDDs use the recommended HDDs.

Maker	RPM	Capacity	Interface	Model No.
Hitachi	7,200	80 GB	Ultra ATA133	HDS728080PLAT20
	7,200	160 GB		HDT722516DLAT80
	7,200	250 GB		HDT722525DLAT80
	7,200	320 GB		HDT725032VLAT80
	7,200	500 GB		HDT725050VLAT80
Seagate	7,200	200 GB	Ultra ATA100	ST3200827ACE
	7,200	250 GB		ST3250824ACE
	7,200	300 GB		ST3300822ACE
	7,200	500 GB		ST3500841ACE

System Operation

1. Press and hold POWER for a few seconds to turn on the sub-power. The power indicator displays a green light and system booting will commence. The LG logo image will be displayed on the main monitor during the system booting.
2. When the booting is completed the login window will be displayed.
Select a user type by using the mouse or arrow and the ENTER button on the remote control or front panel.



- Administrator: Unlimited operation of the unit.
 - Power User: Use of the limited functions of the system. (The setup configuration is not allowed to change.)
 - Normal User: Use of the limited functions of the system. (Split monitor and live image view are available.)
3. Enter the password by using the virtual keyboard. (Initial password is "0000".)
 4. Press LOCK or click the OK(LOCK) icon. You can see the live screen and operate the system.

Notes:

- User access rights

User Level	Administrator	Power	Normal
Live image view	YES	YES	YES
Alarm Off	YES	YES	NO
Export	YES	YES	NO
PTZ	YES	YES	NO
Setup	YES	NO	NO
Search & Play	YES	YES	NO
Instant Record	YES	YES	NO
Shut Down	YES	NO	NO

- You are not allowed to connect the VGA monitor and the composite monitor simultaneously. Consequently, the user is obliged to choose either the composite monitor or the VGA monitor. When set to composite monitor there is no VGA output. When set to VGA monitor there is no composite output. SPOT-OUT is unaffected by the monitor setting.
- This DVR is based on a VGA monitor using OSD. We recommend to using the VGA monitor with this unit. If you use a composite monitor, the OSD quality may lower to read it.

System Shutdown

1. First, you must stop playback and exit the setup menu.
In playback, press STOP.
2. Press and hold POWER for a few seconds and the logout window will be displayed.



3. Enter the password by using the virtual keyboard.
4. Press LOCK or click the OK(LOCK) icon. The system will shutdown and the power indicator will display a red light on the front panel.
5. Turn off the main power switch on the rear panel.

General Explanation of the Live Screen on the Main Monitor

Main Monitor Screen

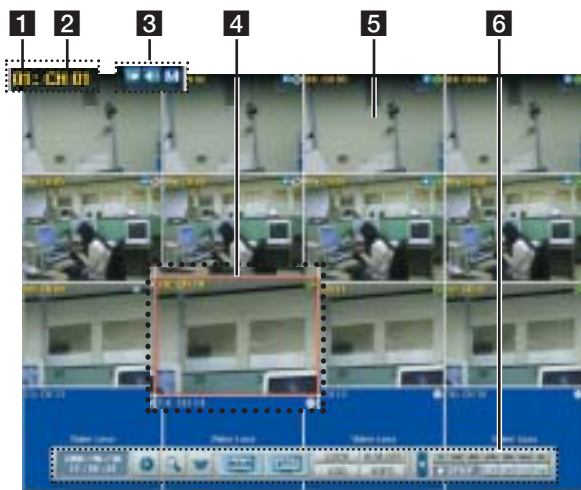

1 Channel Number

Displays the channel number.

2 Channel Name

Displays the edited channel name.

3 Camera Status Icon



- PTZ camera icon
Displays the PTZ camera status.



- Input audio icon
Displays the input audio status.



- Recording status icon
Displays the recording status.
 - Green "C" indicates continuous recording.
 - Green "I" indicates Instant recording.
 - Red "S" indicates sensor triggered recording.
 - Blue "M" indicates motion detection recording.
 - White "N" indicates the channel is not being recorded.

4 Selected Channel

Displays the selected channel with red box.

5 Live Screen

Displays the current surveillance live screen.

6 System Control Bar

	- N (Normal partition): Used size/total size. - E (Event partition): Used size/total size.
	Displays the setup menu.
	Displays the search menu.
	Displays the PTZ remote control window.
	Displays the screen division selection window for the main monitor.
	Displays the screen division selection window for the spot monitor.
	Displays the lock menu to change the user type or disable system operation.
	Displays the system log list window.
	Turns the alarm off.
	Displays the system information window.
	Displays the remaining HDD status.
	- N (Normal partition): Used size/total size. - E (Event partition): Used size/total size. Display/hide playback control bar. Pause playback. Jump to the beginning of the current data recorded on the same date. Select the required scanning speed. Jump to the last minute of the current data recorded on the same date. Stop playback. Display playback status. Enlarge/reduce the playback window. Click at a desired point to be marked during playback. Up to 15 points can be marked. Display copy/export menu.

Note:

Use OSD with the SHIFT button on the front panel or click the right button on the mouse to display / remove the system control bar displayed on-screen.

Selecting Live Screen Mode

Main Monitor

You can select the live screen mode to display a full, 4-split, 6-split, 8-split, 9-split or 16-split screens on the main monitor.

1. Press MAIN or click the MAIN icon in the system control bar.
Screen mode select menu of main monitor is displayed on the main monitor.
2. Select screen mode.

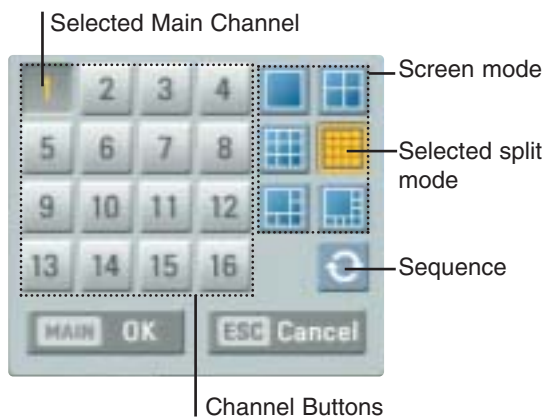

- **Channel Number:** Press the 1 to 16 channel button to see the current surveillance images in selected live screens on the main monitor.
- **Full Screen Mode:** When you see the selected channel on the full screen.
- **4, 6, 8, 9 and 16 Split Mode:** Displays selected split screens on the main monitor.
- **Sequence:** View all channels in sequence.

3. Select [OK (MAIN)] and press ENTER to confirm your selection.

Note:

To display the screen you desire to watch in full screen mode, double click the desired channel.

Spot Monitor

You can select the live screen mode to full or 4-split screens on the spot monitor.

1. Press SPOT or Click the SPOT icon in the system control bar.
Screen mode select menu of spot monitor is displayed on the main monitor.
2. Select screen mode.

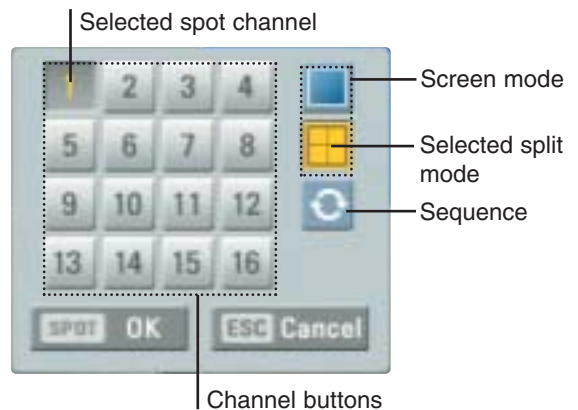

- **Channel Number:** Press the 1 to 16 channel button to see the current surveillance image on the spot monitor.
- **Full Screen Mode:** When you see the selected channel on the full screen.
- **4 Split Mode:** Displays 4 split screens on the spot monitor.
- **Sequence:** Views the all channels in sequence.

3. Select [OK (SPOT)] and press ENTER to confirm your selection.

PTZ Camera Control

You can control the cameras connected via the data port of RS-422/485 terminal. You must set the configuration between the PTZ camera and the DVR.

1. Select the PTZ camera channel on the main monitor you want to control.
2. Press PTZ or Click the PTZ icon in the system control bar.
Virtual PTZ remote control is displayed on the main monitor.
3. Use each item to control the PTZ camera.

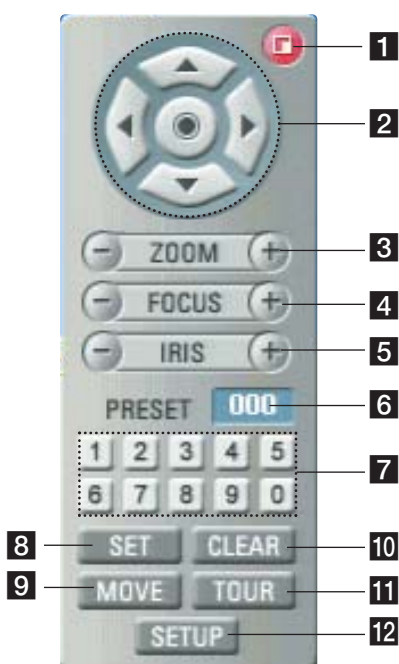

- 1 Exit**
Remove the PTZ virtual remote control.
- 2 ▲/▼/◀/▶**
Use to pan/tilt the camera.
⊙
Confirm the preset position.
- 3 ZOOM + / -**
To adjust the camera zoom.
- 4 FOCUS + / -**
To manually adjust the focus of a camera.
- 5 IRIS + / -**
To manually adjust the iris of a camera.
- 6 Displays the Selected Preset Number**
- 7 Number Buttons**
To input the preset number.

- 8 SET**
To register preset positions.
- 9 MOVE**
To move the camera to the preset position.
- 10 CLEAR**
To delete a memorized preset position.
- 11 TOUR**
To start a preset tour.
- 12 SETUP**
To displays the setup menu of the PTZ camera.

Preset Settings

Preset position is the function to register camera monitoring positions (preset positions) associated with position numbers.

By entering the position numbers, you can move cameras to the preset positions.

Note:

To activate this function, you need to register the preset positions of combination cameras.

To Register Preset Positions

1. Move the camera to a point you wish by using the ▲/▼/◀/▶.
2. Press SET or click the [SET] icon.
3. Select the preset number you wish to register.
4. Press ENTER or click the [⊙] icon.
The position and its number are memorized.
5. Repeat steps 1-4 to add additional positions.

Note:

Preset numbers from 0 to 255 are available on this unit but the actual preset range differs depending on PTZ cameras.

Changing to a Picture in a Preset Position

The following function is available only with cameras provided with the preset function.

The preset function makes the combination camera move to the programmed preset position. It is necessary to program preset positions for the combination camera beforehand.

1. Press the MOVE button or click the [MOVE] icon.
2. Use number buttons to enter the memorized preset position's index number then press ENTER or click the [⊙] icon. The camera moves to the preset position and the picture of the camera in that position appears on the monitor.

To Clear the Preset Position

You can clear a memorized preset position.

1. Press the CLEAR button or Click the [CLEAR] icon.
2. Use number buttons to enter the memorized preset index number then press ENTER or Click the [OK] icon to clear the preset positions.

Note:

This function may not be available depending on PTZ cameras.

To Tour The Preset Positions

You can tour all preset positions.

1. Press the TOUR button or Click the [TOUR] icon.
All registered preset positions in the camera will be selected and the camera position image will be switched on the active monitor.
2. You can stop the tour by pressing the TOUR button or clicking the [TOUR] icon.

Setup for PTZ Cameras

You can adapt the camera to your requirements by setting up the respective items in menus.

1. Click the [SETUP] icon.
The setup menu appears in the selected window of the main monitor.
2. Use arrows, ZOOM +/- and ENTER buttons to set the options.

Notes:

- Refer to the manuals of the PTZ camera for more details.
- Some PTZ cameras may not operated correctly with this unit.
- You cannot control the other functions when the PTZ virtual remote control is displayed.

Viewing System Information

To view system information:

1. Press INFO or click the INFO icon in the system control bar.
The system information window is displayed on the main monitor.



2. Press INFO or click the [Exit(Info)] button to exit the window.

Viewing the System Log List

To view the system log list:

1. Press LOG or click the LOG icon in the system control bar.
The system information window is displayed on the main monitor.

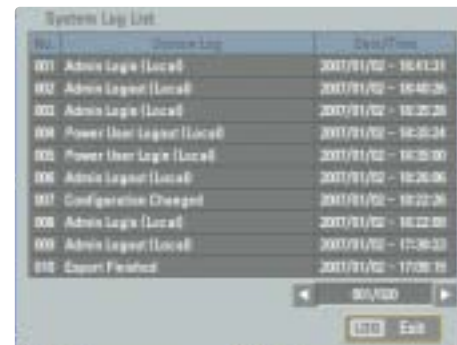

2. Use ◀ / ▶ to see the previous or next log list.
3. Press LOG or click the [Exit(LOG)] button to exit the window.

Notes:

The system log message indicates power on/off, power recovery, remote and local user login/logout, configuration changed, configuration imported, backup and export information (start, finished, failed).

Menu Configuration

The features and options of the DVR are configured through the menu.

The operations of this unit can be set via a menu displayed on the main monitor. You can select and set the operational conditions by using the buttons on the front panel and the remote control or using a USB Mouse connected to the unit.

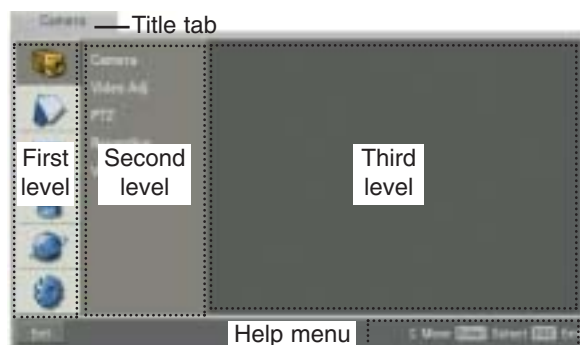

Using a Mouse to Set a Menu

Use the left and right mouse buttons to set the menu.

- **Left button:** Use to select a required item or decrease the options value.
- **Right button:** Use to increase the options value.

1. Click the [SETUP] icon on the bottom of the on-screen display with the left mouse button to display a setup menu.
2. Click the desired option with the left mouse button to move to the second or third level.
3. Click the desired option with the left mouse button.
4. Set the selected options value.
5. Click the Exit icon to exit setup menu. If the save message appears, click [OK] with the left mouse button to save the settings.

Setting the Menu Using the Front Panel Buttons or Remote Control Buttons

Arrow Buttons:

Use these buttons to select the menu options or adjust the options value.

ENTER:

Select the option or confirm the setting.

ESC:

Return to the previous menu or level.

1. Press SETUP/ESC to display the setup menu.
2. Use ▲ / ▼ to select the desired option.
3. While the desired item is selected, press ENTER to move to the second level.
4. Use ▲ / ▼ to select the desired option then press ENTER to move to the third level.
5. Use ▲ / ▼ / ◀ / ▶ to select the desired option then press ENTER to set the value.
6. Use ◀ / ▶ to select the desired setting then press ENTER to confirm your selection.
7. Press SETUP/ESC to exit the Setup menu. If the save message appears, press ENTER to save the settings.

Notes:

- When you operate the function menu by using the remote control and front panel buttons, both buttons are operated in the same way to control the function menu.
- To use other functions of number buttons on the front panel as shown below.
 1. Press SHIFT. The button indicator turns green.
 2. Select the function button you want.
- **All the operation explanations are based on using the remote control.**

Camera Settings

Camera

The channel name, covert and input audio channel settings are configured.

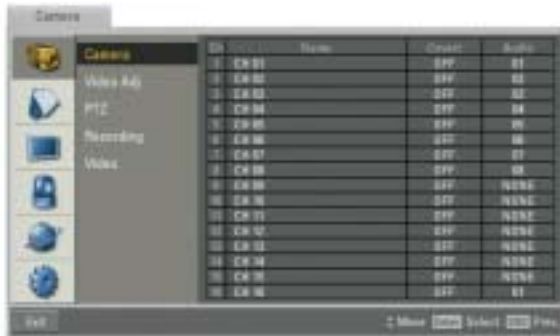

- **Ch:** Displays the channel number.
- **Name:** Enter the channel name using up to 12 characters.
 - ◀/▶/▲/▼: Select a character.
 - ENTER: Confirms your selection.
 - ESC: Exits the virtual keyboard menu.
- **Covert:** You can set the camera conditions to prevent operation by other users. If the covert option is set to ON, "Video Loss" is displayed on the live window with POWER or NORMAL user.
- **Audio:** You can hear from the selected input audio channel.

Video Adj

Adjust the brightness, contrast and color settings of each camera channel. You can see the settings screen from the preview windows.



- **Channel:** Selects the desired channel to adjust.
- **Brightness:** Adjust the brightness value from 0 to 100 for the selected channel.
- **Contrast:** Adjust the contrast value from 0 to 100 for the selected channel.
- **Color:** Adjust the color value from 0 to 100 for the selected channel.

PTZ

Settings for the PTZ cameras connected via the data port of the RS-422/485 terminal.



- **Channel:** Selects the desired channel to set the connected PTZ camera.
- **Port:** Selects the connected data port of the RS-422/485 terminal on the rear panel.
- **Control ID:** Selects the PTZ camera ID from 0 to 255. Make the same settings as the PTZ camera.
- **Protocol:** Selects the protocol supported by PTZ camera.
- **Baud Rate:** Selects the communication speed. (1200, 2400, 4800, 9600, 19200 or 38400)
- **PTZ Test:** After the PTZ setting, you can test the pan/tilt function for the selected PTZ camera. You can see the test screen from the preview windows on the right side of the PTZ test option.
 - ◀ / ▶: Test the pan direction.
 - ▲ / ▼: Test the tilt direction.

Note:

The supported PTZ camera list is on page 64 for reference.

Recording

Settings concerning normal recording and event recording.

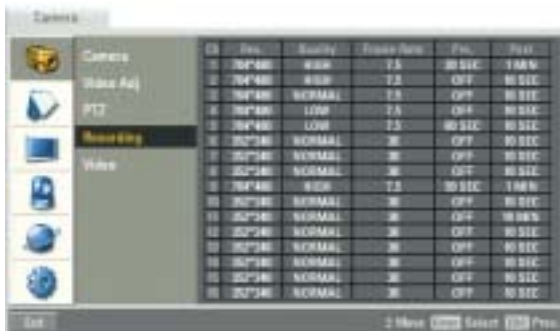

- **Ch:** Displays the channel number.
- **Res.:** Selects the recording resolution.
- **Quality:** Selects the recording picture quality (LOWEST, LOW, NORMAL, HIGH or BEST).
- **Frame Rate:** Selects the frame rate. The frame rate is the number of recorded frames per second. According to resolution, the frame rate is set automatically. If you wish to set manually, refer to the below.

	Resolution	Frame Rate
NTSC	352*240	1, 3, 5, 7.5, 15, 20, 30
	704*240	1, 3, 5, 7.5, 15
	704*480	1, 3, 5, 7.5
PAL	352*288	1, 3, 5, 6, 12.5, 20, 25
	704*288	1, 3, 5, 6, 12.5
	704*576	1, 3, 5, 6

- **Pre.:** Specify the pre-event recording time that records the situation until the sensor alarm signal has input or motion has been detected. (OFF, 5, 10, 20, 30, 40, 50 or 60 SEC)
- **Post:** Specify the post-event recording time that records the situation from when the sensor alarm signal has input or motion has been detected. (10, 20, 30, 40, 50 SEC or 1, 2, 3, 5, 10 MINUTE)

Video

Selects the video format to NTSC or PAL according to your video system format.

1. Select the video format.
The confirmation message is displayed.
2. Select [OK] and press ENTER.
After the HDD has been formatted, the system will reboot.



Schedule Settings

The DVR can record according to a schedule set by the user. It can also record manually regardless of date and time. The recording can be made either continuously or triggered by events (alarm and motion detection).

The recording schedule screen displays one day of the week showing the schedule of all channels over a 24-hour period.

For each 1-hour cell block the recording method can be specified. The recording method (continuous, sensor, motion, sensor+motion) for each block is shown in color for easy viewing.

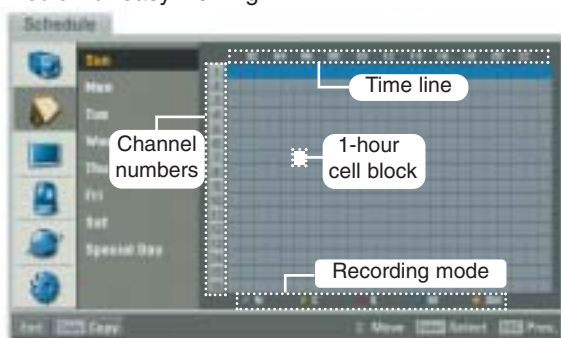

To Set the Recording Schedule for a Typical Day of the Week

1. Select a day of the week.
2. Select the desired channel to schedule recording.
3. Select the time cell block for the start time.
4. Press ENTER or click the left mouse button to select a recording mode. The color of the cell blocks will change automatically.
 - Gray: No scheduled recording
 - Green (continuous recording): recording starts automatically from the preset time.
 - Red (sensor event recording): recording starts automatically when the sensor alarm is occurs within a designated time.
 - Blue (motion event recording): recording starts automatically when motion is detected within a designated time.
 - Yellow (sensor+motion recording): recording starts automatically when the sensor alarm signal has input or motion has been detected.
5. Select the next time cell block of schedule time cell blocks to confirm the schedule time.

6. Press ENTER or click the left mouse button repeatedly to select gray to set the time for the end of the schedule. The settings cell block is highlighted.
7. Press SETUP/ESC to move to the previous menu.

To Set a Recording Schedule for a Special Day

In addition to the weekly schedule, up to 10 specific date/time periods can be defined. To configure the specific recording schedule select Specific Dates.

1. Select the [Special Day] option.
2. Select a cell block.



3. Press the ZOOM + button or click the [Add] icon on the special day setting menu. The specific date selection menu appears.



4. Enter the necessary information for year, month and date.
 - ◀ / ▶ / ▲ / ▼: Press to move the columns, [OK] or [Cancel] buttons.
 - ◀ / ▶ (or left/right mouse button): Changes the value at the current position.
 - ENTER: Confirm the selection.
 - Press ESC to exit the specific date selection menu.

- Use ◀ / ▶ / ▲ / ▼ to select [OK] button and press ENTER.
The virtual keyboard menu appears.



- Enter the name of the special day. Use ▲/▼/◀/▶ to select a character then press ENTER to confirm your selection.
- Use ▲ / ▼ to select the [OK] icon then press ENTER to fix the date of the special day and return to the special day menu screen.
- Select the schedule time and set the recording method for each channel.

Checking the Special Day Schedule List

- Press INFO when the "Special Day" option is selected.
The special day scheduled list appears.

No.	Name	Date
1	EEEE	2006/08/18
2	4EBUT	2006/08/22
3	TEST	2006/09/15
4		
5		
6		
7		
8		
9		
10		

At the bottom of the table are three buttons: "Edit", "Delete", and "Exit".

- Select a special day title on the list and press ENTER.
The title color turns orange.
- Select the [Edit] icon then press ENTER to edit the special day or press ZOOM - to delete the special day schedule.
- Press ESC to exit the special day schedule list.

Note:

If the special day recording schedule is duplicated with the other recordings, only the special day recording is possible.

Copying the Recording Schedule

Copying from the Scheduled Data of the Channel

You can copy the schedule data of the channel to the other channel(s) within the selected day of the week.

- Select the day of the week and press ENTER.
- Select channel that you want to copy.
- Press COPY then the channel selection menu appears.



- Use ◀ / ▶ to move to the left or right column then press ENTER to select the target channel(s).
You can cancel the selected channel by pressing ENTER.
- Use ▲ / ▼ to select [OK] then press ENTER to confirm your selection.

Copying from the Scheduled Data of the Day

You can copy the scheduled day of the week to another day of the week, weekday and weekend using the COPY button.

- Select the day of week that you want to copy.
- Press COPY then the select date(s) menu appears.



- Use ◀ / ▶ to select the target date(s).
- Use ▲ / ▼ to select [OK] then press ENTER to confirm your selection.

Display Settings

OSD



- **Language:** Select a language for the setup menu and information display.
- **Channel Name**
 - ON: Displays the title of the channel.
 - OFF: Displays the live picture without the title of the channel.
- **Recording Mode**
 - ON: The current channel recording status is displayed.
 - OFF: Remove the current channel recording status.

Main Monitor



- **Dwell Time:** You can set the channel sequence time to 2 seconds, 5 seconds, 10 seconds, 30 seconds or 1 minute.

Spot Monitor



- **Dwell Time:** You can set the channel sequence time to 2 seconds, 5 seconds, 10 seconds, 30 seconds or 1 minute.
- **Event Popup:** Displays an event popup on the spot monitor if motion, sensor or all (motion+sensor) occur.

Event Settings

Sensor

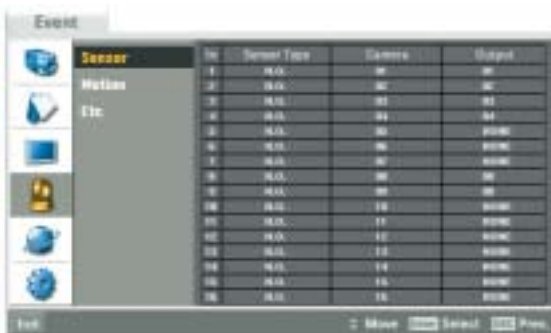

- **In:** Displays the number of the SENSOR-IN terminal.
- **Sensor Type:** The alarm state can be set to either N.O. (Normally Open) or N.C. (Normally Closed).
- **Camera:** Select the connected camera channel to the SENSOR-IN terminal.
- **Output:** Select the alarm output number for the ALARM-OUT terminal for the output alarm signal.

Motion



- **Channel:** Select the channel to set motion detection.
- **Sensitivity:** Set the level of sensitivity for the created motion detection area. Sensitivity can be set from level 0 to 10.
- **Alarm Out:** Select the number of the ALARM-OUT terminal for the output alarm signal when motion is detected.

- **Area:** Select the desired motion detection area on the preview window screen.
 - ◀ / ▶ / ▲ / ▼: Moves the yellow cell box to another cell zone.
 - ENTER: Selects or cancels the motion detection area at the current cell position.
 - Press ESC to exit the settings.

Note:

You can select the motion detection area by using the mouse.

- To select the area: Drag & drop a cell to the right to select the motion detection area.
- To cancel area: Drag & drop a cell point of a selected cell area to the left to cancel the motion detection area.

Etc



- **Alarm Off**
 - MANUAL: Use the ALM.OFF button to stop alarm.
 - POST-ALARM TIME: The alarm is stopped after post-alarm time.

Network Settings

TCP/IP



- **DHCP:**
DHCP stands for Dynamic Host Configuration Protocol.
 - ON: Network settings of this unit are configured automatically by the DHCP server.
If you set to ON, the [IP Address], [Subnet Mask], [Gateway], [Primary DNS] and [Secondary DNS] options are dimmed and these options are not set.
 - OFF: Enter the network settings manually.
- **IP Address:** Enter an IP address using the virtual keyboard.
- **Subnet Mask:** Enter a subnet mask address using the virtual keyboard.
- **Gateway:** Enter the gateway address using the virtual keyboard.
- **Primary DNS:** Enter the Main DNS server address using the virtual keyboard.
- **Secondary DNS:** Enter the Sub DNS server address using the virtual keyboard.
- **TCP/IP Port No.:** Enter the TCP/IP Port number using the virtual keyboard. You can watch the live surveillance image over the network with the PC Client program. The factory default port for transmission of video and audio data is 9001. However in some cases it is better to change this port number for added flexibility or security. If desired change the port number(1025 ~ 65535).
- **Web Server Port No.:** Enter the Web Server Port number using the virtual keyboard. You can watch the live surveillance image over the network with a web browser. Typically the TCP port used by HTTP is 80. However in some cases it is better to change this port number for added flexibility or security. If desired change the port number (80 or 1025~65535).
- **Bandwidth:** Enter the Bandwidth using the virtual keyboard to adjust the data traffic (1~100Mbps).

Note:

When you change the TCP/IP port or web sever port number, all connections with the PC Client programs or web browser will be connected.

DDNS (Dynamic Domain Name System)



- **User Name:** Enter the DDNS registered user name using the virtual keyboard.
- **Password:** Enter the user password in [User Name] using the virtual keyboard.

Note:

The DDNS function is serviced using a TCP 8245 port by "No-IP"(<http://www.no-ip.com/>). In case the DVR is used in the network system with a firewall, you have to open the TCP 8245 port so that DDNS data can get into firewall. For more detail on firewall setup, ask your network administrator and/or network service provider.

Notification



- **Sensor On:**
 - ON: Sends an e-mail when a sensor has occurred.
 - OFF: Not used.
- **Motion Detect:**
 - ON: Sends an e-mail when an motion detection has occurred.
 - OFF: Not used.
- **Disk Full:**
 - ON: Sends an e-mail when the HDD has fully recorded.
 - OFF: Not used.
- **Admin PW Changed:**
 - ON: Sends an e-mail when the administrator password has changed.
 - OFF: Not used.
- **Video Loss:**
 - ON: Sends an e-mail when a video signal from the camera has stopped because of a cable disconnection or malfunction of a camera.
 - OFF: Not used.
- **Power On/Off:**
 - ON: Sends an e-mail when power is on or off.
 - OFF: Not used.

- **SMTP Port No.:** Enter the SMTP Port Number using the virtual keyboard. Typically the TCP port used for SMTP is 25. However in some cases it is better to change this port number for added flexibility or security. If desired change the port number (25 or 1025 ~ 65535).
- **User Name:** Enter the user name using the virtual keyboard.
- **Password:** Enter the password using the virtual keyboard.
- **Mail Address (1-4):** Enter the mail address using the virtual keyboard. You can input up to 4 e-mail addresses.
- **E-mail Test:** Select [E-mail Test] to test send an e-mail.

Note:

The SMTP server, SMTP port no., user name or password settings are optional. The DVR can send e-mail directly without the use of an SMTP server or MTA (message transfer agent). In certain cases all e-mail should be forwarded to a specific SMTP server. Specify the server host name or IP address in such a case. For more detail on SMTP setup, ask your network administrator and/or mail service provider.

Mail



- **Notification**
 - ON: Notifies the user of unit operating information by e-mail according to notification settings.
 - OFF: The notification function is not used. The mail options are dimmed.
- **SMTP Server:** Enter the SMTP Server address using the virtual keyboard. If notification is set to ON and the SMTP server option is empty, the SMTP port no., user name, and password options are dimmed and the options are not set.

Emergency



- **Notification:**
 - ON: Notifies the emergency agent about unit operating information according to your notification settings.
 - OFF: Notification function is not used.
- **IP/Port No.:** Enter the IP/port number of the emergency agent program using the virtual keyboard. The factory default port for this function is 9002. However in some cases it is better to change this port number for added flexibility or security. If desired change the port number (1025 ~ 65535). You can set up to 9 IP/port numbers.

System Settings

Date/Time



- **NTP:** Set to ON when using the NTP (Network Time Protocol) server for time adjustment. If the NTP is set to OFF, the time settings should be entered manually and the [Time Server], [Private Time Server], [Sync. Interval] and [NTP Test] options are deactivated.
- **Date:** Enter the current date.
- **Time:** Enter the current time.
- **Date Format:** Select the date display format.
- **Daylight Saving:** Set to ON to you use the daylight saving function.
- **Time Zone:** Select your Time Zone.
- **Time Server:** For most cases select public. The DVR will obtain the average time among 5 public servers (rime.nist.gov, time-a.nist.gov, time-b.nist.gov, ntp.nasa.gov, clock.isc.org).
- **Private Time Server:** Enter the private time server's IP address or host name using the virtual keyboard.
- **Sync. Interval:** You can set synchronized intervals with the NTP time server to 1 day, 1 hour, 1 month and 1 week.
- **NTP Test:** Select [NTP Test] to test the NTP server.

Buzzer



- **Button Beep**

- ON: Makes a sound when using the buttons.
- OFF: Turns off the button beep.

- **Sensor Buzzer**

- ON: Makes a sound when a sensor occurs.
- OFF: Turns off the sensor buzzer.

- **Motion Buzzer**

- ON: Makes a sound when a motion is detected.
- OFF: Turns off the motion buzzer.

Note:

The buzzer is a low sound on this unit. If you want to make a loud sound, connect an external alarming device to the ALARM-OUT terminals (ex. Siren).

User

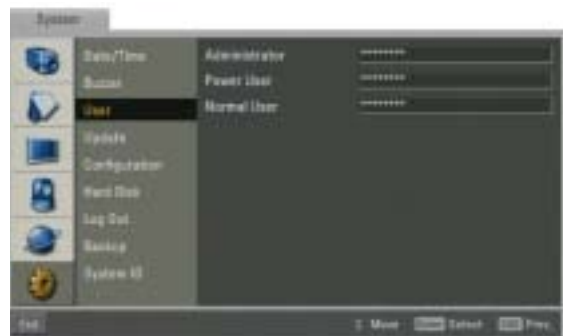

- **Administrator:** Enter the new password for the administrator using the virtual keyboard.
- **Power User:** Enter the new password for the power user using the virtual keyboard.
- **Normal User:** Enter the new password for the normal user using the virtual keyboard.

Note:

Remember the new password. If you forget the new password please contact an authorized service center or the store where you purchased the system.

Update



- **Item:** Select the item to be updated.
 - PTZ PROTOCOL: Select to PTZ PROTOCOL update.
 - SYSTEM S/W: Select to SYSTEM S/W update.
- **Method:** Select the update method.
 - USB: When you update from USB memory stick.
 - NETWORK: Update from the update server.
- **Update Server:** If you select the method option for NETWORK, enter the IP address of an update server using the virtual keyboard for network update.
- **Update:** Select the [Update] tab to start update.

Notes:

- If you can not update from the update server, check the TCP/IP options and the IP address of update server.
- If you use a USB memory stick to update, you must disconnect the other external USB devices.

Configuration

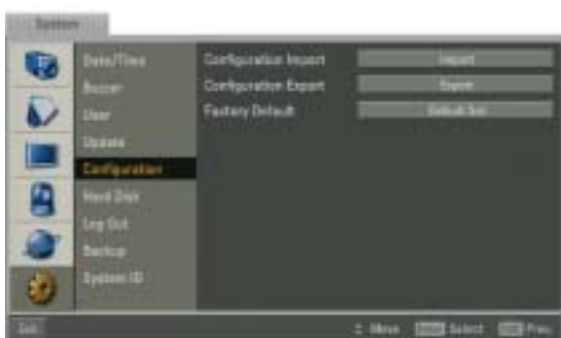

- **Configuration Import:** Import the DVRs configuration data from the USB memory stick.

- **Configuration Export:** Export the configuration data from this DVR to the USB memory stick.
- **Factory Default:** You can reset the DVR to its original factory settings. Some options cannot be reset (date, time, daylight saving, time zone and user password settings).

Notes:

- Configuration data import is available when the configuration data of a DVR is the same kind as this unit's data.
- If you use a USB memory stick for configuration export, you must disconnect the other external USB devices.

Hard Disk



- **Format:** Initializes the HDD (Hard Disk Drive). All data on the selected HDD will be erased.
- **Overwrite:**
 - ALL: Overwrite recording is possible when the normal partition and event partition of HDD have fully recorded.
 - NORMAL PARTITION: Overwrite recording is possible for normal partition of HDD when the normal partition of HDD has fully recorded.
 - EVENT PARTITION: Overwrite recording is possible for event partition of HDD when the event partition of HDD has fully recorded.
 - OFF: Do not use overwriting.
- **Full Warning:** When the HDD has overflowed a warning message is displayed.
- **Event Partition:** Set the space of event partition for event recording.

Note:

If you change the value of event partition, the current recorded data of HDD is deleted and the partition is reset. The partitions will be formatted automatically and the system will be restarted.

Log Out



- **Auto Logout:** To set the logout time.
 - ON: Logout is automatically at fixed intervals.
 - OFF: Not used. The time option is dimmed.
- **Time:** You can set auto logout time to 5 minutes, 10 minutes, 30 minutes or 60 minutes.

Backup



- **Schedule:** You can set the backup schedule.
 - OFF: All options are disabled.
 - INSTANT: The backup data is saved manually.
 - WEEKLY or DAILY: The backup data will be automatically saved according to the setting.
- **Device:** Select a backup device.
- **Schedule Start:** Set the schedule start date (A day of the week and time).
- **Time Range:** Enter the backup time range.
 - Date: Enter the date you want to backup.
 - Start: Enter the start day of the week or time.
 - End: Enter the end day of the week or time.
- **Estimate Size:** Displays the size of backup data and the free space of external USB devices.
- **Start Backup:** To start backup.
- **Erase Media:** To erase the media.

Notes:

- Use the recommended external USB devices for preventing malfunction (See page 64).
- The CD-R, DVD-R or DVD+R discs cannot be formatted.
- An external media has to be formatted on this unit to prevent malfunction.
- DVD+RW and DVD-RW discs have to be initialized before using.
- You cannot use the [Estimate size], [Start Backup] and [Erase Media] options in backup progressing.
- Do not remove the USB device while the backup is in progress, it may cause a malfunction. If you reuse the removed device, you must format the media by using erase media options.
- If you format the external media by using a PC with FAT32, the media may not be used on this unit.

Instant Backup

1. Connect the backup USB device.
2. Select INSTANT from on the schedule options.
3. Select the backup device.
4. Enter the date, start time and end time from the time range options for backup.
5. Select the [Estimate Size] icon and press ENTER.
6. Check the size of the selected data and free space of the USB device. If the USB device has not enough space, create space on the USB device or erase the connected USB device.
7. Select the [Start Backup] icon and press ENTER to start backup.
8. Exit the setup menu.
You can check the backup status on the system control bar in backup progress.

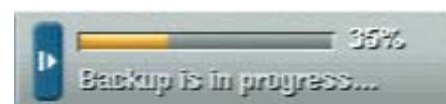

Notes:

- You cannot stop the backup in backup progress.
- The warning message will appear for the conditions listed below.
 - When the start time and end time are the same value.
 - When the start time is later than the end time.
 - A media has not enough space.
 - When you set the time for data that does not exist.
- The disc burning is carried out by a single session closed format.

Daily/Weekly backup

1. Connect the USB device for backup.
You cannot use the CD or DVD writer for daily or weekly backup.
2. Select WEEKLY or DAILY on the schedule options.
3. Select the backup device.
4. Enter the date and/or time to start backup on the schedule start option.
5. Enter the day of week and/or time on the Time Range Start option.
6. Enter the day of week and/or time on the Time Range End option.
7. Select [Estimation Size] icon and press ENTER.
8. Check the size of selected data and free space of USB device. If the USB device has not enough space, change the USB device of enough space or erase the connected USB device.

Notes:

- You cannot stop the backup in backup progress.
- The warning message will appear for the conditions listed below.
 - When the start time and end time setting are wrong.
 - A media does not have enough space.
 - When you set the time for data that does not exist.
 - When the selected USB device is disconnected.
- The estimated size of backup data is only the approximate size. So you must prepare sufficient space on the media to prevent lack of space.
- At the scheduled recording time, you can check the backup status on the system control bar.
- While export is in progress or searching the backup data from the external USB device, the scheduled backup will not be started.
After the export or backup search is finished, scheduled backup will be restarted.
- If you use the CD/DVD writer device for backup, the backup status will be displayed as shown below.

- 1st. Status of making ISO image



- 2nd. Status of writing

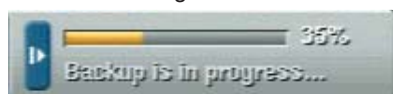

System ID



- **IR Remote Control:** Select the system ID for this unit (1~9). If you use multi systems set the systems ID for each DVR unit.

RECORDING

Images from a camera will be recorded on the built-in hard disk.

Note:

External recording devices can be used as copy areas for images recorded on the hard disk. It is impossible to record images on the external recording devices directly.

Instant Recording

Ensure all the cameras are connected and that time and date have been set correctly.

Before you start recording, first check the repeat recording settings in the recording menu of the system setup, and then make the recording settings.

1. Press the REC button on the front panel and then press the channel button you want to record. The button indicator turns red and the recording type indicator turns green on the selected channel screen of the main monitor.
2. Press the REC button on the front panel and then press the channel button you want to stop recording. If you stop instant recording, the recording mode will be changed into the scheduled recording mode (Continuous/ Alarm/ Motion records). If the schedule is not set, the button indicator turns green and the recording type indicator turns white on the selected channel screen of the main monitor.



Notes:

- You can record instantly with the left mouse button.
 1. Move the cursor to the desired channel screen on the main monitor.
 2. Click the recording type indicator with the left mouse button and recording starts. Click it once again and the instant record stops and the recording type indicator will be changed into the scheduled recording mode (Continuing/ Alarm/ Motion record). If the schedule is not set, the recording type indicator turns white.
- You can instant record that the channels scheduled such as alarm, motion or continuous.
- Once you stop instant recording, the recording type indicator will be changed to the scheduled recording mode.
- You can not record the Instant and Continuous recording in following conditions.
 - A HDD is not attached.
 - A HDD is not formatted.
 - The channel has no video input for display.
 - Overwrite sets to "OFF" and normal partition is full.
 - On the HDD setting, the event partition is set to 0%.
 - The continuous record is not set.
- You can not record the Alarm and Motion recording in following conditions.
 - A HDD is not attached.
 - A HDD is not formatted.
 - The channel has no video input for display.
 - Overwrite sets to "OFF" and event partition is full.
 - On the HDD setting, the event partition is set to 100%.
 - The schedule (Alarm/Motion) record is not set.
- HDD partition according to a recording type.
 - Normal Partition: It is the space in the HDD that stores the continuous and instant recorded data. Once the normal partition is set to 0% (the event partition is 100%), you can not record the continuous or instant recordings.
 - Event Partition: It is the space in the HDD that stores the alarm and motion recorded data. Once the event partition is set to 0%, you can not record the alarm and motion recording.
- Priority of record.
Instant record > Alarm/Motion record > Continuous record.

SEARCH AND PLAYBACK

PLAYBACK

Instant Playback in PIP (Picture in Picture)

It is possible to play a recorded image without stopping recording.

1. Select a channel you want to playback.
2. Press ◀▶ to play a recorded image of the previous 1 or 2 seconds of recording. The playback image will be displayed on the PIP window and display the playback control bar on the system control bar.



3. Press ■ (STOP) to stop the playback.

Notes:

- The PIP window can be moved through the live picture using ◀▶▲▼ buttons.
- Instant playback is possible for forward playback only.

Instant Playback in POP (Picture over Picture)

Use the ZOOM +/- buttons to enlarge or reduce the PIP window as below.

x1 size ↔ x4 size ↔ x9 size ↔ Full screen size.



Notes:

- The POP window can be moved through the live picture using ◀▶▲▼ buttons.
- Instant playback is possible for forward playback only.
- The full size screen of the POP window has the best picture quality compared to other sizes of the POP window.

SEARCH

The various search functions of this unit can be used to go to the beginning of the desired picture. This unit is equipped with 4 search functions.

When the SEARCH button is pressed the search menu is displayed.



Select Source Device

This item is used to set the playback or search device.

1. Use ▲/▼ to select [INTERNAL HDD] then press ENTER.



2. Use ◀/▶ to select the desired source device.
 - INTERNAL HDD:** Plays back or searches recorded contents of the internal HDD device.
 - External Device:** Plays back or searches backup contents of the external device.
3. Press ENTER to confirm your selection.

Notes:

- While the backup is in progress, you can not search the data on the backup device.
- Do not remove the external USB device whilst the backup search is in progress from the USB device. It may cause a malfunction.

Date and Time Search

Use to search recorded pictures by specifying date, hour and minute.



1. Use ▲/▼ to select the [Date/Time Search] icon then press ENTER.
2. Select the year, month, date, hour or minute column then press ENTER.
3. Use ◀/▶ to input the date or time.
4. Press ENTER to confirm it.
5. Select the [Update] icon then press ENTER. The search result is displayed in the time table of the search menu.
6. Use the channel buttons on the front panel to select the channel(s) you want to playback.
7. Press PLAY or Click the [Play] icon to start playback. The picture(s) is (are) displayed in the POP window(s) on the main monitor.



8. Press STOP (■) to stop playback and return to the search menu.
9. Press SETUP/ESC to exit the [Date/Time Search] menu.

Notes:

- Recorded data shown on the time graph will be displayed in different colors depending on the recording type.
 - Green: Continuous recording.
 - Red: Sensor recording.
 - Blue: Motion-detection recording.
 - Gray: No recording.
- Use the ZOOM + button to view the detailed time by 6 hour intervals.

7. Select the recording data on the event list then press PLAY, click [Play] or double click the selected data to start playback. The picture is displayed in the POP window of the main monitor.
8. Press STOP (■) to stop playback and return to the event list menu.
9. Press SETUP/ESC repeatedly to exit the event search menu.

Event Search

Search a recorded picture by date and type of event.



1. Use ▲/▼ to select [Event Search] then press ENTER. The event search menu is displayed.
2. Set the year, month and date.
 - ◀/▶: Moves to the previous or next column or changes the setting at the current position.
 - ENTER: Selects the column or confirms the setting.
3. Select the channel for event search using ENTER.
4. Use ▲/▼ to select the [Event Type] then press ENTER.
5. Use ◀/▶ to select the event type then press ENTER.
6. Select the [Search] icon then press ENTER. The event list menu appears.

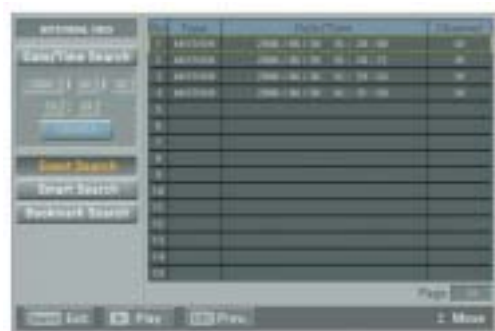

Smart Search

Pictures recorded via motion detection can be searched by specifying the motion detection conditions.



1. Use ▲/▼ to select the [Smart Search] icon then press ENTER. The smart search menu is displayed.
2. Set the channel number, start time, end time and sensitivity options.
 - ◀/▶/▲/▼: Moves to the options.
 - ◀/▶: Sets the selected option.
 - ENTER: Selects option or confirms the setting.

Note:
The time between the start time and the end time is automatically set at 1hour.
3. Select the [Set] in the [Area] option then press ENTER. The picture from the selected camera is displayed.
4. Set the motion mask setting. The area switches between active and inactive each time you press ENTER. Click the one point and drag & drop the end point to select the motion using the mouse. The active areas are indicated in red.
5. Press SETUP/ESC to exit the mask setting.

6. Select [Search] then press ENTER.
The motion detect list menu is displayed.

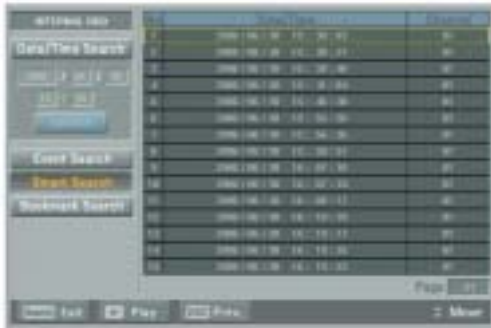

7. Select the recording data on the motion detect list then press PLAY, click [Play] or double click the selected data to start playback.
The picture is displayed in the POP window of the main monitor.
8. Press STOP (■) to the stop playback and return to motion detect list menu.
9. Press SETUP/ESC repeatedly to exit the smart search menu.

3. Press STOP (■) to stop playback and return to the bookmark list menu.
4. Press SETUP/ESC to exit the bookmark search menu.

Notes:

- Backup data can not be played back by a bookmark search.
- You can register a bookmark only in the single channel playback.
- You can not register a bookmark during instant playback.

Bookmark Search

Search the desired picture with a bookmark registered by the bookmark function.

1. Use ▲/▼ to select [Bookmark Search] then press ENTER.
The bookmark list menu is displayed.



2. Select the recording data on the list then press PLAY, click [Play] or double click the selected data to start playback.
The picture is displayed in the POP window of the main monitor.

Note:

If you delete the bookmark on the list, press the ZOOM - button.

EXPORT

This unit can manually copy recorded images from built-in HDD to the external recording devices.



1. Press COPY or click EXPORT.
The export menu window appears.
2. Select a target device to export.
3. Select the channel number(s).
4. Set the start date/time and end date/time to copy.
5. Press COPY or Click the [Export] icon to start exporting.
The exported data will be authorized by the unit before saving and it can only be played back with the exclusive player.

Notes:

- Check the export device before you proceed.
- Export can not be executed while the backup is in progress.
- You can search the exported data with the supplied viewer software.
- When you export the recorded data the export viewer program will also be exported in the [ExportViewer] folder of USB device. The exported data file name is made automatically as the [Channel name_export date_export time.exp] type.
- Do not remove the USB device while the export is in progress, it may cause a malfunction. If you reuse the removed device, you must format the media by using erase media options.
- The warning message appears for the conditions listed below.
 - When the start date/time and end date/time are the same value.
 - When the start date/time is later than the end date/time.
 - The export media does not have enough space.
 - When you set the time for data that does not exist.

- An external media has to be formatted on this unit to prevent a malfunction.
- DVD+RW and DVD-RW discs have to be initialized before using.
- You can format the external media with the backup tab in the setup menu.

CLIENT PROGRAM

Client Program is the network program of the LDV-S504 and LDV-S503. This manual is written based on LDV-S504 (16 channels).

The description pictures may differ from your OS (Operating System) type. The pictures used in this manual are based on Windows XP.

Note:

Do not use other applications with this client program. This can cause memory shortage and client program malfunction.

PC Requirements

- **OS (Operating System):** Windows 2000 or above, DirectX 8.1 or above.
- **CPU:** Intel Pentium III or above, AMD Athlon with 800 MHz or above.
- **RAM:** 512 MB or above.
- **Graphics Card:** AGP VGA with 64 MB Video RAM or above.

Recommended PC Requirements

- **OS:** Windows XP
- **CPU:** Intel Pentium IV
- **RAM:** 512 MB
- **Graphics Card:** AGP VGA with 128 MB Video RAM

Client Program Installation

1. Insert the Client Program CD which will be started automatically.
If the disc does not run automatically on your PC, open the Client Program CD and install the program manually.
2. Run the install file and install the programs to your computer following the InstallShield Wizard displayed.
3. After installation finished you will find the programs in the start menu of the computer.

Note:

The [Emergency Agent] and [Export viewer] programs will be installed with the client program installation.

Connecting to the DVR

Register the Site Name

You should register a site name to control DVR by the Client Program.

1. Double-Click the [LDV-S500 Network Client] icon to start the Client Program. The [S500 Network Client] menu is displayed.
2. Select [Tools] > [Connection Information]. The connection list menu is displayed.
3. Select [Add] and the connection setup menu is displayed.



4. Enter the site name, IP address and port.
 - Site Name: Enter the description of the site.
 - IP Address: Enter the IP Address or URL of the DVR.
 - Port: Enter the Port number of the DVR. If it isn't entered, the port number is set by default.

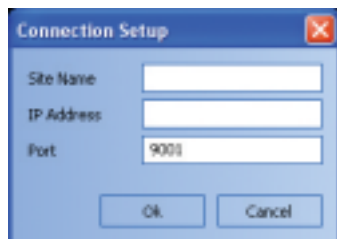

5. Select [OK].



6. Select [OK] to confirm the settings. The registered site name is displayed.

Note:

In case of entering the server name instead of the IP Address. You should set up the DDNS configuration properly in the server. Please refer to the server manual to set up the DDNS function.

User Log-In

1. Select the registered site name and right click the mouse.
2. Select [User Log-In].



3. Select [User Type] and enter the password.
 - Administrator: To operate the unit without limitations.
 - Power User: To use the live and search mode functions.
 - Normal User: Show the live image only.

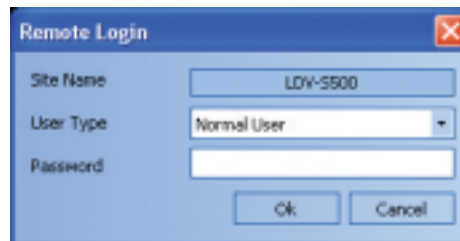

4. Select [Ok] and the [S500 Network Client] main window is displayed.

Notes:

- If someone logged in the DVR using the Admin ID, you can not log-in using the Admin ID.
- If you want to log-out, right click the mouse on the site name and select [User Log-Out].
- Up to 5 users can connect to the DVR system using the client program as shown below.

User	User1	User 2	User3	User4	User5
Case 1	Admin	Power	Normal	Normal	Normal
Case 2	Power	Power	Normal	Normal	Normal
Case 3	Normal	Normal	Normal	Normal	Normal
Case 4	Admin	Normal	Normal	Normal	Normal
Case 5	Power	Normal	Normal	Normal	Normal

Main Screen of DVR Client Program



1. Program Menu

- **File**
 - Exit: Exit the program.
- **View**
 - OSD
 - > Channel Number: Displays or removes the channel number in the channel window.
 - > Site Name: Displays or removes the site name in the channel window.
 - > Camera Name: Displays or removes the camera name in the channel window.
 - > Playback Time: Displays or removes the date/time of playback data in the channel window.
 - > PTZ: Displays PTZ camera icon in the channel window.
 - > Audio: Displays audio icon in the channel window.
 - > Select All: Displays all OSD options in the channel window.
 - Sequence (Dwell Time): Select the sequence to 5 seconds, 10 seconds, 15 seconds or 20 seconds.
 - Video Size: Select the video size from 100%, 150% or 200%.
 - Language: Select the language for client program.
- **Tools**
 - Connection Information: To register a site name.
- **Help**
 - S500 Client Information: Displays S500 Network Client Version Information.

2. Mode Selection Icons



- **Live Mode**
 - Camera View: You can see the surveillance cameras' images in the window(s) and the camera information.
 - Pan/Tilt/Zoom: You can control the PTZ cameras.
 - Log View: Displays system log list.
- **Search Mode**

You can search the recorded data as shown below.

 - Date/Time Search (See page 51)
 - Event Search (See page 51)
 - Bookmark Search (See page 52)
 - Smart Search (See page 52)
- **Remote Setup Mode**

You can set the configuration of the unit.

 - Camera / Display (See page 53)
 - Schedule (See page 54)
 - Event (See page 55)
 - Network (See page 56)
 - System (See page 57)

3. Screen Mode Selection Icons



When the icon is clicked, the screen will be changed to split mode and if the icon is clicked again, the screen will be changed by sequence. Choose the display window mode.



You can view the live window(s) in full screen mode. To return to the normal screen right click the mouse.

4. Sequence Icon



View all the channels in sequence. You cannot use sequence mode with the 16 split.

5. Information Display Window



Displays current date and time, user information, and the remaining HDD status of the selected site name.

Live Mode



Using the Camera View

1. Select the [Camera View] tab in the live mode.
2. Select the registered site name and double click the left mouse button or click the plus mark of the registered site name.



3. Select [Cameras] and double click the left mouse button or click the plus mark.



4. Select the channel number you want to view.
5. Click the channel number and drag and drop to live window position.
If you select [Cameras] and drag and drop to a live window then all channels are displayed.
6. Live image is displayed in the selected window.



7. Repeat steps 3-5 to set the other live windows.

Note:

Configuration of camera view is set the first time only. This configuration setup is memorized for the next time and displayed as it is.

Using the live window

Playback of Recorded Data



1. Select the camera's display window.
2. Select the date.
The day is displayed in a blue text when recorded data exists.
3. Select playback start time.
When using timeline to search a start time, use the zoom in/out icons for more detailed searches (4 step).
4. Select playback speed.
5. Start playback using these control buttons.

Notes:

- If you don't want to play with sound click the speaker icon to mute.
- You can not use the playback function when you log in with the Normal User ID.

Using the Pan/Tilt/Zoom Function

You can control the PTZ cameras via the network.



1. Select the PTZ camera channel window in the camera view mode.
2. Select Pan/Tilt/Zoom tab.
3. Use virtual remote control buttons to control the PTZ camera.

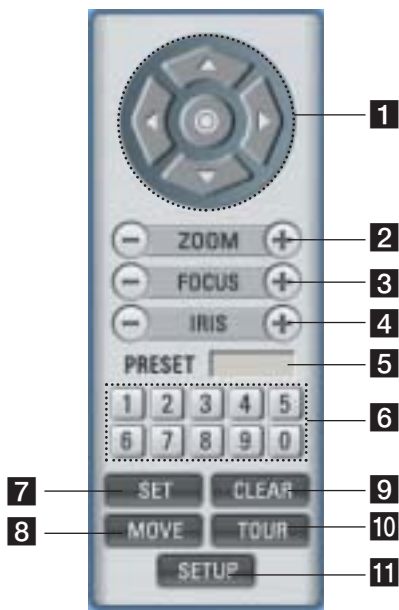

- 1 **▲/▼/◀/▶**: Use to Pan/Tilt the camera.
⊙: To confirm the preset position and set a menu option in the PTZ camera.
- 2 **ZOOM + / -**
 To adjust the camera zoom.
- 3 **FOCUS + / -**
 To manually adjust the focus of a camera.
- 4 **IRIS + / -**
 To manually adjust the iris of a camera.

- 5 **Displays Selected Preset Numbers**
- 6 **Number Buttons**
 To input the preset number.
- 7 **SET**
 To register preset positions.
- 8 **MOVE**
 To move the camera to the preset position.
- 9 **CLEAR**
 To delete a memorized preset position.
- 10 **TOUR**
 To start a preset tour.
- 11 **SETUP**
 To displays the setup menu of the PTZ camera.

Notes:

- If someone is controlling a PTZ camera using the DVR, you cannot use the PTZ function and vice versa.
- You can not use the PTZ function when you log in with a normal user ID.

To Register Preset Positions

1. Move the camera to the point you wish by using the **▲/▼/◀/▶**.
2. Click the [SET] icon.
3. Select preset the number you wish to register.
4. Click the **⊙** icon.
 The position and its numbers are memorized.
5. Repeat steps 1-4 to add additional positions.

Note:

The preset range is available from 0 to 255 on this unit. but the actual preset range differs depending on the PTZ cameras.

Changing to a Picture in a Preset Position

The following function is available only with cameras equipped with the preset function.

The preset function makes the combination camera move to the programmed preset position. It is necessary to program preset positions for the combination camera beforehand.

1. Click the [MOVE] icon.
2. Use number icons to enter the memorized preset position's index number then Click the **⊙** icon.
 The camera moves to the preset position and the picture of the camera in that position appears on the monitor.

To Clear the Preset Position

You can delete a memorized preset position.

1. Click the [CLEAR] icon.
2. Use number icons to enter the memorized preset index number then Click the [⊙] icon.
The preset position will be deleted.

To Tour the Preset Positions

You can tour all preset positions.

1. Click the [TOUR] icon.
All registered preset positions in the camera will be selected and the camera position image will be switched on to the active window.
2. You can stop the tour by clicking the [TOUR] icon.

Setup for PTZ camera

You can change the setting of PTZ camera using each item in the menu.

1. Click the [SETUP] icon.
MENU appears in the windows.
2. Use the arrow and ⊙ icons to set the options.

Note:

Refer to the manuals of the PTZ camera for more details.

Using the Log View Function

You can see the system log list of selected site names in the remote setup tab via the network.

1. Select the log view tab.
Log search menu appears.



2. Click the date icon and select the day for the log search.
(The selectable days are displayed in blue text color.)



3. Click the search icon.
The system log is displayed in the list.



Search Mode



You can search the data of a selected site name in the remote setup tab via the network.

Using the Date/Time Search function

Use to search a recorded picture by specifying date, hour and minute.



1. Select the date/time search tab.
2. Click the date icon and select the day.
(The selectable days are displayed in blue color.)
3. Select the channel window you want to view.

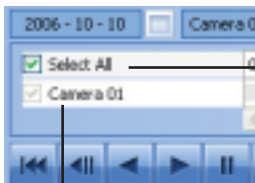

Mark up when you want to view from all camera channel windows.

Displays selected camera number.

4. Use the timeline and time input column to search recorded data.



5. Playback the searched data using the playback control buttons.



Using the Event Search function

Search a recorded picture by date and event type.

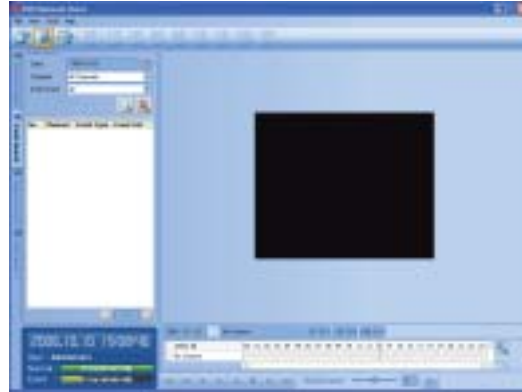

1. Select the event search tab.
2. Click the date icon and select the day.
(The selectable days are displayed in blue color.)
3. Select the camera channel for event search.
4. Select the event type.
5. Click the search icon.
The event list is displayed.
6. Select the event from the event list.
7. You can play the searched data using the playback control buttons.

Using the Bookmark Search Function

Search the desired picture with a registered bookmark using the bookmark function.



1. Select the bookmark search tab.
2. Click the search icon.
All bookmark data is displayed in the list.
3. Select the data in the list.
4. Play the searched data using the playback control buttons.



Using the Smart Search function

Picture recorded via motion detection can be searched by specifying the motion detection conditions.



1. Select the Smart Search tab.
2. Click the date icon and select the day.
(The selectable days are displayed in blue color.)
3. Select the camera channel.
4. Select the start time using the timeline.



5. Select the end time.
6. Select the motion sensitivity level and motion area on the display window using the mouse.

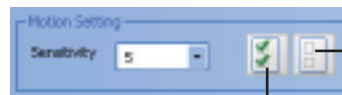

Cancel the selected area.

Select the all area.



Selected area within red box.

- Click the search icon.
The smart search data is displayed.



- Select the channel from the list.
- You can play the searched data using the play-back control buttons.

Remote Setup Mode



You can set the DVR of a selected site name in the remote setup tab via the network.

Camera / Display Setup



Camera Setting



- Select a channel for settings.
If you want to block a channel from other users, mark up the convert option. The marked up channels are displayed "Video Loss" on the live windows for POWER or NORMAL user.
- Enter the new channel name.
- Select input audio channel.
- Set the PTZ control options.
 - Port:** Select the connected data port of the RS-422/485 terminal on the rear panel.
 - Control ID:** Select the PTZ camera ID from 0 to 255. Make the same settings as the PTZ camera.
 - Protocol:** Select the protocol supported by PTZ camera.
 - Baud Rate:** Select the communication speed.(1200, 2400,4800,9600,19200 or 38400)
- Set the motion options.
 - Sensitivity:** Set the sensitivity level for the created motion detection area. Sensitivity can be set from 0 to 10.
 - Alarm Out:** Select the number of the ALARM-OUT terminal for the output alarm signal when motion is detected.
 - Area:** Select the desired motion detection area on the preview window screen using the mouse. Click the one point and drag & drop the end point to select the motion area.

Notes:

- If you want to display the grid, mark up the [Show Grid] option.
- If you want to select the entire area, click the [Set All] button or click the [Clear All] button to cancel the selected area.

Recording Frame Rate Settings

1. Click the [Frame Rate Settings] button.
The recording frame rate settings window appears.



2. Set each options using the mouse.
 - **Resolution:** Select the recording resolution. (NTSC: 352*240, 704*240 or 704*480
PAL: 352*288, 704*288 or 704*576)
 - **Quality:** Select the recording picture quality. (Lowest, Low, Normal, High or Best)
 - **Frame Rate:** Select the frame rate. The frame rate is the number of recorded frames in a second. According to resolution, the frame rate is set automatically. If you set manually, refer below.

	Resolution	Frame Rate
NTSC	352*240	1, 3, 5, 7.5, 15, 20, 30
	704*240	1, 3, 5, 7.5, 15
	704*480	1, 3, 5, 7.5
PAL	352*288	1, 3, 5, 6, 12.5, 20, 25
	704*288	1, 3, 5, 6, 12.5
	704*576	1, 3, 5, 6

- **Pre-Alarm Time:** Specify the pre-event recording time to records the situation until the sensor alarm signal has input or motion has been detected. (Off, 5, 10, 20, 30, 40, 50, 60 Sec)
 - **Post-Alarm Time:** Specify the post-event recording time that records the situation after the sensor alarm signal has input or motion has been detected. (10, 20, 30, 40, 50 Sec or 1, 2, 3, 5, 10 Min)
3. Click the [OK] button to confirm the settings.

Display Settings



1. Set the OSD options.
2. Set the main monitor option.
3. Set the spot monitor options.

Schedule setup



1. Select a day of the week.
2. Mark up the desired recording option.
 - No recording: Do not schedule recording.
 - Continuous: Recording starts automatically at the preset time.
 - Sensor: Recording starts automatically when alarm occurs within a designated time.
 - Motion: Recording starts automatically when motion is detected within a designated time.
 - Motion+Sensor: Recording starts automatically when alarm and motion detection occur within a designated time.
3. Select the channel to set the schedule.
4. Click the start time cell block and drag & drop to select a time period cell block.
 - or**
 - Click the start time cell block of a channel and drag & drop across the channels to select the time period block for multi-channel setting at the same time.
 - The color of the cell blocks will change.

Schedule Copy Settings

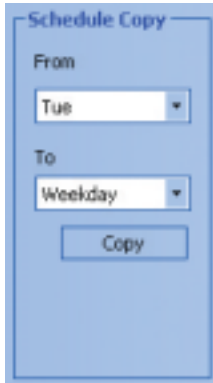

1. Select the source day to copy.
2. Select the destination day from the day of the week, weekday or weekend options.
3. Click the copy button to copy the schedule data.

Special Day Settings



1. Mark up the special day option.
2. Select the date to set the special day schedule.
3. Mark up the desired recording option.
4. Select the channel to set the schedule.
5. Click the start time cell block and drag & drop to select a time period cell block.
or
 Click the start time cell block of a channel and drag & drop across the channels to select the time period block for multi channel setting at the same time.
 The color of the cell block will change.
6. Enter the name of the special day.
7. Click the add button to add the special day settings.
 The special day is added to the list.
 If you want to cancel the registered special day, select the special day in the list and click the delete button.

Event setup



1. Set the event options.
 - Sensor In: Displays the number of the SENSOR-IN terminal.
 - Sensor Type: The alarm state can be set to either N.O. (Normally Open) or N.C. (Normally Closed).
 - Linked Camera: Select the connected camera channel with the SENSOR-IN terminal.
 - Alarm Out: Select the alarm output number of the ALARM-OUT terminal for the output alarm signal.
2. Setting [Etc] options.
 - Alarm Off: Set the manual or post-alarm time option to off.

Network setup



TCP/IP Settings

The [DHCP], [IP Address], [Subnet Mask], [Gateway], [Primary DNS], [Secondary DNS], [TCP/IP Port No.] and [Web Server Port No.] option settings are not available in the client program. You can set these options in the system menu of the DVR.

- **Bandwidth throttle:** Enter the bandwidth to adjust the data traffic (1~100Mbps).

Mail Settings

Set the mail options.

- **Notification:** When you mark up the notification option, notify the user about unit operating information by E-mail according to your notification settings.
- **SMTP Server:** Enter the SMTP Server address.
- **SMTP Port No.:** Enter the SMTP Port Number. Typically the TCP port used for SMTP is 25. However in some cases it is better to change this port number for added flexibility or security. If desired change the port number (25 or 1025 ~ 65535).
- **User Name:** Enter the user name.
- **Password:** Enter the password.
- **Mail Address 1~4:** Enter the mail address. You can input up to 4 E-mail addresses.

Note:

The [SMTP Server], [SMTP Port No.], [User Name] or [Password] settings are optional. The DVR can send e-mail directly without the use of an SMTP server or an MTA (message transfer agent). In certain cases all e-mail should be forwarded to a specific SMTP server. Specify the server host name or IP address in such cases. For more detail on SMTP setup, ask your network administrator and/or mail service provider.

Notification

Set the notification options.

- **Sensor On:** Sends an E-mail when a sensor has been detected.
- **Video Loss:** Sends an E-mail when a video signal from the camera has stopped because of a cable disconnection or malfunction of a camera.
- **Motion Detect:** Sends an E-mail when motion detection has occurred.
- **Power On/Off:** Sends an E-mail when power is on or off.
- **Disk Full:** Sends an E-mail when the HDD has fully recorded.
- **Admin PW Changed:** Sends an E-mail when the administrator password has changed.

Emergency

- **Notification:** Notify the emergency agent about unit operating information according to your notification settings.
- **IP Address, Port:** Enter the IP Address and port number of the emergency agent program installed in the PC. The factory default port for this function is 9002. However in some cases it is better to change this port number for added flexibility or security. If desired change the port number (1025 ~ 65535). You can set up to 9 IP address and port numbers.

System setup



Date/Time settings

Set the date/time options.

- **NTP:** Mark up when using the NTP (Network Time Protocol) server for time adjustment.
- **Date Format:** Select the date display format.
- **Time Zone:** Select your time zone.
- **Time Server:** Select your time server.
The DVR will obtain the average time among 5 public servers (rime.nist.gov, time-a.nist.gov, time-b.nist.gov, ntp.nasa.gov, clock.isc.org).
- **Private Time Server:** Enter the private time server's IP address or host name.
- **Sync. Interval:** You can set synchronized interval with the NTP time server to 1 day, 1 hour, 1 week and 1 month.

Update Settings

Set the update options.

- **Item:** Select the items for updating.
 - PTZ PROTOCOL: Set to PTZ PROTOCOL update.
 - SYSTEM S/W: Set to SYSTEM S/W update.
- **Method:** Select the update method.
 - USB: Update from USB memory stick.
 - Network: Update from the update server.
- **Update Server:** Enter the IP address of the update server.

Note:

If you can not update from the update server, check the TCP/IP options and the IP address of the update server.

Administrator

- **Administrator:** Enter the new password for the administrator using the virtual keyboard.
- **Power User:** Enter the new password for the power user using the virtual keyboard.
- **Normal User:** Enter the new password for the normal user using the virtual keyboard.

Note:

Remember the new password. If you forget the new password please contact an authorized service center or the store where you purchased the system.

Buzzer Settings

Select the buzzer options.

- **Button Beep:** Makes a sound when using the buttons.
- **Sensor Buzzer:** Makes a sound when an alarm occurs.
- **Motion Buzzer:** Makes a sound when motion is detected.

Log Out

- **Auto Logout:** Setting the logout time.
If you mark up the option it will automatically logout at selected intervals.
- **Time:** You can set the auto logout time to 5 minutes, 10 minutes, 30 minutes or 60 minutes.

Hard Disk

- **Overwrite:** Select the overwrite recording type (Off, Normal Partition, Event Partition or All). This function is possible when the selected HDD type has fully recorded.
- **Full Warning:** When the HDD has overflowed the warning message is displayed.
- **Event Partition:** Sets the space of event partitions for event recording.

Additional Programs

Emergency Agent Program

If you set the notification in the emergency option to ON, the system sends a message according to the settings of the notification options in the setup menu. (See page 33).

1. Double-click the [Emergency Agent] icon to start the emergency agent program.
The Emergency icon is displayed in the system tray on the bottom right of the screen.



2. Whenever a notification function occurs, a message box is displayed on the bottom right of the screen.
The Emergency icon is changed to a message icon.
The message box is displayed for 5 seconds.



3. Check the message.
4. Click the message box within 5 seconds to display the [Received Messages] window.
or
Right click the mouse on the program icon in the system tray and select the [Check Message Box] option to display the [Received Messages] window.
5. You can check all the subjects of received messages.
6. Click the [CLOSE] button to close the [Received Messages] window.

Main Screen of Emergency Agent

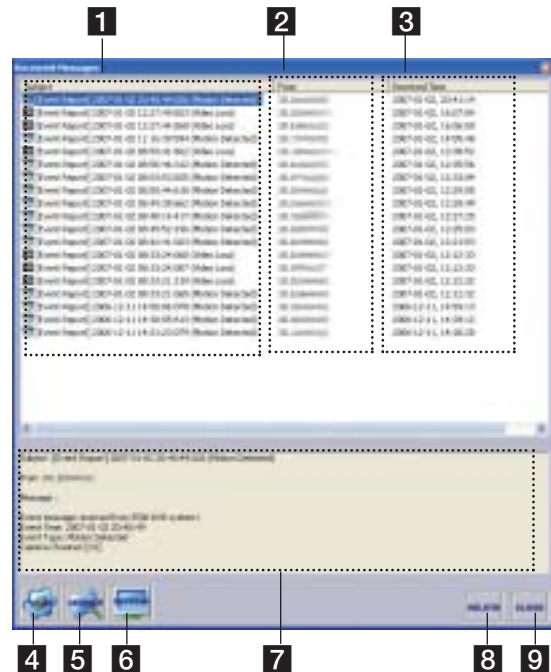

- 1 Displays message type.
- 2 Displays IP Address.
- 3 Displays received time.
- 4 Displays the port change window.
- 5 Displays the search window.
- 6 Refreshes the received message on the list.
- 7 Detailed view of the received message.
- 8 Deletes the selected message from the list.
- 9 Closes the [Received Messages] window.

Port Setting

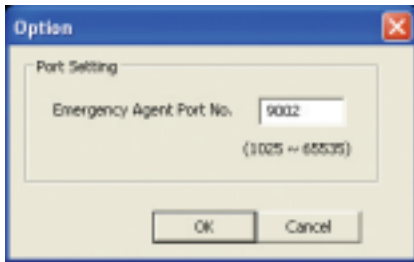

1. Click the PORT button.
The option window is displayed.
2. Enter the port number of the emergency agent listening port. The factory default port is 9002. However in some cases it is better to change this port number for added flexibility or security. If desired change the port number (1025 ~ 65535).
3. Click the OK button to exit.

Message Search



1. Click the SEARCH button.
The message search window is displayed.
2. Select the search method.
 - Event Search: Search by selected type of event for the message.
 - Date Search: Search by selected date.
3. Click the Search button.
The search message is displayed on the [Received Messages] window.

Delete the Message from the List

1. Select the message(s) you want to delete.
2. Click the DELETE button.
The confirmation window is displayed.

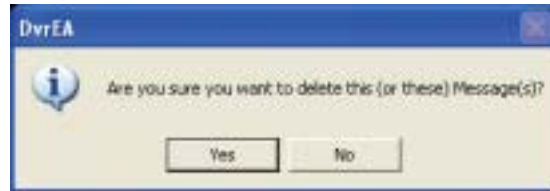

3. Click [Yes] to delete the message.

Export Viewer Program

You can playback from the export data on the PC using this program. The export viewer program is saved automatically when you install the client program or export the data. (See page 44)

Main Screen of Export Viewer

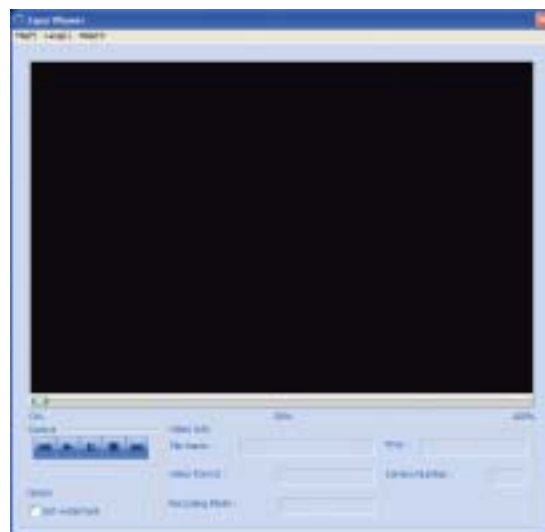

- **Program Menu.**
 - **File(F)**
 - > Open: Open the data file.
 - > Exit: Exit the program.
 - **Lang(L)**
Select the language for Export Viewer program.
 - **Help(H)**
 - > About Export Viewer: Displays Export Viewer information.

- **Control Icons**

- : Jumps to the beginning of the file.
- : Starts playback.
- : Pauses playback.
- : Stops playback.
- : Jumps to the end of the file.

- **Watermark Setting**

The warning window will appear with watermark option, if the file which is in playback differs from the file that is originally recorded.

- **Video Information**

- **File Name:** Displays the file name.
- **Time:** Displays the recorded date and time of data.
- **Video Format:** Displays the video type of the data.
- **Camera Number:** Displays the camera channel number of recorded data.
- **Recording Mode:** Displays the save mode of the data. (continuous, motion or other).

4. Click the [Open] button.

The selected data is played back automatically.



5. Click the (STOP) button to stop playback.

Playing Data

1. Double-Click the [Export Viewer] icon on the PC or [ExportViewer] folder of the external USB device. If you insert the exported data CD or DVD disc, the export viewer program run automatically. The Export Viewer window is displayed.
2. Select [File(F)] > [Open].
The open window is displayed.
3. Select the root directory of the USB device and search&select the desired file.
An example of playable file format is "Channel name_date_time.exp".

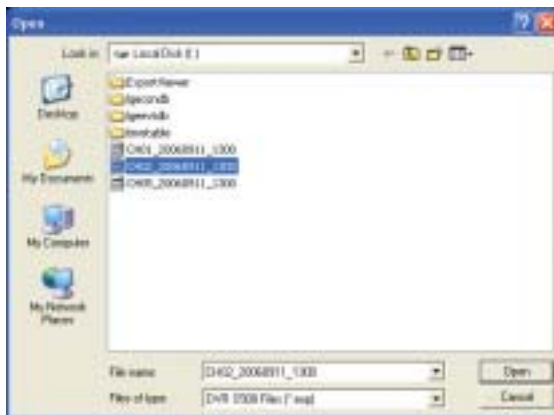

REFERENCE

Troubleshooting

Check the following guide for the possible cause of a problem before contacting service.

Symptoms	Resolutions
The system power does not turn on.	<ul style="list-style-type: none"> • Check the power cable is connected correctly. • Check the input voltage is correct. • Make sure that the main power switch on the rear panel is set to ON. • If the system power does not turn on even if the power cable is connected correctly, please contact the service center.
The system power is turned on but no video data is displayed on the monitor.	<ul style="list-style-type: none"> • Check the monitor power cable is connected properly. • Make sure the monitor is turned on. • Check the video output cable of the LDV-S500 DVR is properly connected to the monitor. • Check the selected monitor type (see page 19). • Unplug the power cable and plug in again.
The camera numbers are displayed on the screen but the camera images are not displayed.	<ul style="list-style-type: none"> • Check the camera video output is connected to the DVR system correctly. • Check the power cable on the camera is connected correctly. • Check there is no problem with the video cable connection from the camera to the LDV-S500 DVR system. • Turn off the DVR system and turn it on again.
The camera video is shown on the screen but the system does not record the video.	<ul style="list-style-type: none"> • Check the recording mode in the record setting menu. • Check the HDD detection status in the System Information window. If the HDD detection status is abnormal, check the HDD formatting and the connection of the HDD. • Check the recordable disk space in the HDD. • Check the overwrite option in the setup menu for overwrite recording.
It is impossible to search through the recorded video.	<ul style="list-style-type: none"> • Check if there is recorded video data at the time that you are trying to search on the table. • If there is no recorded video data, check the recording mode in the record setting menu. • Check the HDD detection status in the system information window. If the HDD detection status is abnormal, check the HDD formatting and the connection of the HDD. • Check the user type. The search function is not available for a normal user.

Symptoms	Resolutions
Audio data recorded with video data is not playing.	<ul style="list-style-type: none"> • Check the audio recording option is correctly set for the camera you wish to record audio. • Check the speaker and audio (line input) on the rear of system are connected correctly. • Check the connected speaker is working properly.
The colors of some camera videos are strange or videos are displayed abnormally.	<ul style="list-style-type: none"> • If the camera connected to the system has a problem, make sure that the camera is not damaged by trying another camera into a working video output. • Check the video format setting of the unit is the same as the connected camera's video format. Depending on your region, the camera's video format can support either PAL or NTSC. Depending on the camera's video format, the video process can differ greatly, therefore it can be difficult to recognize the video data if the video format setting is different from the camera's video format.
There is a lot of (screen) noise accompanying the image.	<ul style="list-style-type: none"> • Check if the video signal output from the camera has a problem. Ensure the camera is not damaged by trying another camera with a working video output. • Check if the video cable connection between the camera and the DVR is cut, crosswired or shorted. • Check if there is a high voltage wire around the video cable connection between camera and DVR system. It can cause interference and affect video quality. • Check the video cable connection between the camera and the DVR system is the correct video cable. When a normal power-supplying cable is used instead of the video cable, screen noise can be generated.
The connected sensor is not operating.	<ul style="list-style-type: none"> • Check the type of sensor in the camera setting is the same as with the connected sensor. • Check the system is set to use the sensor in the recording schedule window in the recording setting menu. • Check the sensor is properly connected to the SENSOR-IN.
The connected PTZ camera is not operating.	<ul style="list-style-type: none"> • Check the system is set to use the PTZ camera in the camera setting menu. • Check the power cable of the PTZ camera is properly connected. • Check the signal cable of the PTZ camera is properly connected. • Check the selected channel to control the PTZ camera. • Check the user type. The PTZ camera control is not available for a normal user.

Symptoms	Resolutions
<p>An E-mail sent from this product was not received.</p>	<ul style="list-style-type: none"> • E-mail reception failed without SMTP server setting. <ul style="list-style-type: none"> - Make sure the network is correctly set. - Make sure the mail address is input correctly. - Check the spam mail setting of the inputted mail address. (If you set the spam mail, some mails are deleted automatically or classified in the spam mail box) - Some of SMTP mail services do not support an E-mails from private SMTP servers. In this case use the public SMTP server. • E-mail reception failed even if the SMTP server was set. <ul style="list-style-type: none"> - When the [Please check the SMTP information or internet cable] message is displayed. <ul style="list-style-type: none"> > Check the SMTP server address. > Check the SMTP port number. (Default setting is 25). > Check the network settings. - When the [Please check the authentication information] message is displayed. <ul style="list-style-type: none"> > Check the user name. > Check the password. - The mail reception failed without error message. <ul style="list-style-type: none"> > Check the receiver's mail address. > Check your E-mail is not classified as a spam mail on the receiver's mail setting.
<p>The remote control does not work properly.</p>	<ul style="list-style-type: none"> • Check the batteries in the remote control. • Check the ID setting for the remote control (See page 37).

Note:

If you observe any of the following symptoms:

- Some of the front panel LEDs do not light.
- The DVR does not operate normally.

You can reboot the DVR as follows:

- Turn off the DVR and turn it on again after a few seconds.

When the recorder does not work normally after rebooting, contact the service center.

Recommended Devices

• Supported USB Memory list

No.	Maker	Model Name	Capacity	USB Version
1	Sandisk	Cruzer Micro	256MB/512MB/1GB	Ver 2.0
2	Sony	Ultra Mini USM	256MB/512MB/1GB	Ver 2.0
3	Transcend	JF 120 2.0	256MB/512MB/1GB	Ver 2.0
4	Imation	Mini Drive	256MB/512MB/1GB	Ver 2.0

• Supported CD/DVD writing device list

Maker	Model Name
LG	GSA-E10N
Plextor	PX-716UF

• Supported CD/DVD Media list

Maker	CD-R	CD-RW	DVD-R	DVD-RW	DVD+R	DVD+RW
Mitsubishi	YES	YES	YES	YES	YES	YES
Imation	YES	YES	YES	YES	YES	YES

• Supported function list for external USB device

Device	Instant backup	Schedule backup	Export	Configuration Import/Export
CD/DVD	O	X	O	X
USB memory	O	O	O	O
HDD	O	O	O	O

Note:

If you use a USB memory stick or HDD for configuration import/export you must disconnect the other external USB devices.

• Supported PTZ Camera list

Protocol Name	Maker	Pan/Tilt	Zoom	Focus	Iris	Preset	Tour	Setup
LG_MULTIX	LG	YES	YES	YES	YES	YES	YES	YES
LG_SD168	LG	YES	YES	YES	YES	YES	YES	YES
PELCO D	PELCO	YES	YES	YES	YES	YES	YES	YES
PELCO P	PELCO	YES	YES	YES	YES	YES	YES	YES
GANZ_DSCP	CBC	YES	YES	YES	YES	YES	YES	YES
GANZ_P360V1	CBC	YES	YES	YES	YES	YES	YES	NO
KALATEL_CYBERDOM	KALATEL	YES	YES	YES	YES	YES	YES	NO
PANASONIC_CS850	PANASONIC	YES	YES	YES	YES	YES	YES	YES
SAMSUNG_SCC	SAMSUNG	YES	YES	YES	YES	YES	YES	YES

Factory Default Configuration Settings

Classification	Detailed Items		Default Setting
1st level	2nd level	3rd level	
Camera	Camera	Name	CH 01 ~ CH 16
		Covert	OFF
		Audio	01 ~ 08, NONE
	Video Adj.	Channel	01
		Brightness	50
		Contrast	50
		Color	50
	PTZ	Channel	01
		Port	NONE
		Control ID	0
		Protocol	LG_MULTIX
		Baud Rate	9600
	Recording	PTZ Test	-
		Res.	352X240 (NTSC) / 352X288 (PAL)
		Quality	NORMAL
		Frame Rate	30 (NTSC) / 25 (PAL)
		Pre	OFF
Video	Post	10SEC	
	Video Format	NTSC	
Schedule	Sun ~ Sat		No Record
	Special Day		No Record
Display	OSD	Language	ENGLISH
		Channel Name	ON
		Channel Status	ON
	Main Monitor	Dwell Time	2 SEC
	Spot Monitor	Dwell Time	2 SEC
Event Popup		OFF	
Event	Sensor	In	01
		Sensor Type	N.O.
		Camera	Channel
		Output	NONE
	Motion	Channel	01
		Sensitivity	5
		Alarm Out	NONE
		Area	OFF
Etc	Alarm Off	POST-ALARM TIME	

Classification	Detailed Items		Default Setting
1st level	2nd level	3rd level	
Network	TCP/IP	DHCP	ON
		IP Address	Null
		Subnet Mask	Null
		Gateway	Null
		Primary DNS	Null
		Secondary DNS	Null
		TCP/IP Port No.	9001
		Web Server Port No.	80
		Bandwidth	100
	DDNS	User Name	Null
		Password	Null
	Notification	Sensor On	OFF
		Motion Detect	OFF
		Disk Full	OFF
		Admin PW Changed	OFF
		Video Loss	OFF
		Power On/Off	OFF
		Notification	OFF
	Mail	SMTP Server	Null
		SMTP Port No.	25
		User Name	Null
		Password	Null
		Mail Address 1-4	Null
E-mail Test		-	
Emergency	Notification	OFF	
	IP/Port No.	Null / 9002	

Classification	Detailed Items		Default Setting
1st level	2nd level	3rd level	
System	Date/Time	NTP	OFF
		Date	2006.01.01
		Time	-
		Date Format	YYYY/MM/DD
		Daylight Saving	OFF
		Time Zone	GMT
		Time Server	PUBLIC SERVER
		Private Time Server	Null
		Sync. Interval	1 Day
		NTP Test	-
	Buzzer	Button Beep	OFF
		Sensor Buzzer	OFF
		Motion Buzzer	OFF
	User	Administrator	"0000"
		Power User	"0000"
		Normal User	"0000"
	Update	Item	SYSTEM S/W
		Method	USB
		Update Server	Null
		Update	-
	Configuration	Configuration Import	-
		Configuration Export	-
		Factory Default	-
	Hard Disk	Format	ALL
		Overwrite	ALL
		Full Warning	70%
		Event Partition	50%
	Log Out	Auto Logout	OFF
		Time	0
	Backup	Schedule	OFF
		Device	-
		Schedule Start	-
		Time Range Date	-
Time Range Start		-	
	Time Range End	-	
System ID	IR Remote Controller	01	

Recording Time Table (250GB HDD)

Resolution	Quality	FPS (NTSC/PAL)	Recording Time (Hr)			
			Video(NTSC/PAL)		Video+Audio(NTSC/PAL)	
			9 ch	16 ch	9 ch	16 ch
352x240	Lowest	30 / 25	245 / 196	138 / 110	223 / 178	125 / 100
		20 / 20	254 / 203	143 / 114	230 / 184	130 / 104
		15 / 12.5	370 / 296	208 / 167	323 / 258	181 / 145
		7.5 / 6	527 / 421	296 / 237	435 / 348	245 / 196
		5 / 5	634 / 507	357 / 285	506 / 405	285 / 228
		3 / 3	761 / 609	428 / 342	584 / 467	328 / 263
		1 / 1	1201 / 961	676 / 541	812 / 650	457 / 366
	Low	30 / 25	214 / 171	120 / 96	197 / 158	111 / 89
		20 / 20	240 / 192	135 / 108	219 / 175	123 / 99
		15 / 12.5	311 / 249	175 / 140	277 / 222	156 / 125
		7.5 / 6	428 / 342	241 / 193	366 / 292	206 / 165
		5 / 5	466 / 373	262 / 210	393 / 314	221 / 177
		3 / 3	527 / 421	296 / 237	435 / 348	245 / 196
		1 / 1	856 / 685	481 / 385	638 / 511	359 / 287
	Normal	30 / 25	143 / 114	80 / 64	135 / 108	76 / 61
		20 / 20	152 / 122	86 / 68	143 / 115	81 / 65
		15 / 12.5	245 / 196	138 / 110	223 / 178	125 / 100
		7.5 / 6	318 / 255	179 / 143	283 / 226	159 / 127
		5 / 5	362 / 290	204 / 163	317 / 253	178 / 142
		3 / 3	389 / 311	219 / 175	337 / 269	189 / 152
		1 / 1	623 / 498	350 / 280	499 / 399	281 / 224
	High	30 / 25	107 / 86	60 / 48	103 / 82	58 / 46
		20 / 20	123 / 99	69 / 56	118 / 94	66 / 53
		15 / 12.5	171 / 137	96 / 77	160 / 128	90 / 72
		7.5 / 6	240 / 192	135 / 108	219 / 175	123 / 99
		5 / 5	285 / 228	160 / 128	256 / 205	144 / 115
		3 / 3	342 / 274	193 / 154	301 / 241	169 / 136
		1 / 1	507 / 406	285 / 228	422 / 338	237 / 190
	Best	30 / 25	67 / 54	38 / 30	65 / 52	37 / 29
		20 / 20	80 / 64	45 / 36	78 / 62	44 / 35
		15 / 12.5	114 / 91	64 / 51	109 / 87	61 / 49
		7.5 / 6	167 / 134	94 / 75	157 / 125	88 / 70
		5 / 5	209 / 168	118 / 94	193 / 155	109 / 87
		3 / 3	238 / 190	134 / 107	217 / 174	122 / 98
		1 / 1	364 / 291	205 / 164	318 / 254	179 / 143

Resolution	Quality	FPS (NTSC/PAL)	Recording Time (Hr)			
			Video(NTSC/PAL)		Video+Audio(NTSC/PAL)	
			9 ch	16 ch	9 ch	16 ch
704x240	Lowest	15 / 12.5	285 / 228	160 / 128	256 / 205	144 / 115
		7.5 / 6	403 / 322	227 / 181	347 / 278	195 / 156
		5 / 5	507 / 406	285 / 228	422 / 338	237 / 190
		3 / 3	571 / 457	321 / 257	465 / 372	261 / 209
		1 / 1	1007 / 806	566 / 453	718 / 575	404 / 323
	Low	15 / 12.5	263 / 211	148 / 119	238 / 191	134 / 107
		7.5 / 6	370 / 296	208 / 167	323 / 258	181 / 145
		5 / 5	394 / 315	221 / 177	340 / 272	191 / 153
		3 / 3	423 / 338	238 / 190	362 / 289	203 / 163
		1 / 1	699 / 559	393 / 314	546 / 437	307 / 246
	Normal	15 / 12.5	190 / 152	107 / 86	177 / 141	99 / 80
		7.5 / 6	254 / 203	143 / 114	230 / 184	130 / 104
		5 / 5	282 / 225	159 / 127	253 / 203	142 / 114
		3 / 3	311 / 249	175 / 140	277 / 222	156 / 125
		1 / 1	489 / 391	275 / 220	409 / 327	230 / 184
	High	15 / 12.5	159 / 127	90 / 72	150 / 120	84 / 67
		7.5 / 6	214 / 171	120 / 96	197 / 158	111 / 89
		5 / 5	240 / 192	135 / 108	219 / 175	123 / 99
		3 / 3	263 / 211	148 / 119	238 / 191	134 / 107
		1 / 1	410 / 328	231 / 185	352 / 282	198 / 159
Best	15 / 12.5	93 / 74	52 / 42	89 / 71	50 / 40	
	7.5 / 6	140 / 112	79 / 63	132 / 106	74 / 60	
	5 / 5	176 / 140	99 / 79	164 / 131	92 / 74	
	3 / 3	192 / 154	108 / 87	179 / 143	100 / 80	
	1 / 1	331 / 265	186 / 149	292 / 234	164 / 132	
704 x 480	Lowest	7.5 / 6	190 / 152	107 / 86	177 / 141	99 / 80
		5 / 5	245 / 196	138 / 110	224 / 179	126 / 101
		3 / 3	285 / 228	160 / 128	256 / 205	144 / 115
		1 / 1	504 / 403	283 / 227	419 / 335	236 / 189
	Low	7.5 / 6	173 / 139	98 / 78	162 / 130	91 / 73
		5 / 5	206 / 165	116 / 93	190 / 152	107 / 86
		3 / 3	225 / 180	127 / 101	207 / 165	116 / 93
		1 / 1	349 / 279	197 / 157	307 / 245	172 / 138
	Normal	7.5 / 6	125 / 100	70 / 56	119 / 95	67 / 53
		5 / 5	134 / 107	76 / 60	127 / 102	72 / 57
		3 / 3	149 / 119	84 / 67	141 / 112	79 / 63
		1 / 1	222 / 177	125 / 100	204 / 163	115 / 92
	High	7.5 / 6	98 / 78	55 / 44	94 / 75	53 / 42
		5 / 5	117 / 94	66 / 53	112 / 89	63 / 50
		3 / 3	129 / 103	73 / 58	123 / 98	69 / 55
		1 / 1	196 / 157	110 / 88	181 / 145	102 / 82
	Best	7.5 / 6	72 / 58	41 / 32	70 / 56	39 / 32
		5 / 5	88 / 70	49 / 40	85 / 68	48 / 38
		3 / 3	98 / 78	55 / 44	94 / 75	53 / 42
		1 / 1	142 / 114	80 / 64	134 / 108	76 / 61

* This recording time table is for reference only.
The recording time can be different depending on your surveillance environment.

Specifications

Model		LDV-S503	LDV-S504	
Video	Input		9	16
	Output	Loop Through	9	16
		Composite	1	1
		S-Video	1	1
		VGA	1	1
	Spot	1	1	
Audio	Input		4	8
	Output		1	1
Alarm	Input		8	16
	Output		4	8
	Pre-Alarm Recording		Up to 60 sec	Up to 60 sec
Recording	Image Rate (/Sec)	NTSC	Up to 270 IPS @ 352x240	Up to 480 IPS @ 352x240
			Up to 130 IPS @ 704x240	Up to 240 IPS @ 704x240
			Up to 60 IPS @ 704x480	Up to 120 IPS @ 704x480
		PAL	Up to 220 IPS @ 352x288	Up to 400 IPS @ 352x288
			Up to 110 IPS @ 704x288	Up to 200 IPS @ 704x288
		Up to 50 IPS @ 704x576	Up to 100 IPS @ 704x576	
Search	Playback Function		FF, FB, Frame Advance Go to First, Go to Last	FF, FB, Frame Advance Go to First, Go to Last
	Search Mode		Date/Time, Event (Motion, Alarm) Bookmark, Smart	Date/Time, Event (Motion, Alarm) Bookmark, Smart
Display	Image Rate (/Sec)	NTSC	270 IPS (Real time per channel)	480 IPS (Real time per each channel)
		PAL	220 IPS (Real time per channel)	400 IPS (Real time per each channel)
	Division Mode		1, 4, 9, 1+5 PIP(1Channel), POP(Multi)	1, 4, 9, 16, 1+5, 1+7 PIP(1Channel), POP(Multi)
Internal HDD	Max Capacity		2TB (Up to 4 HDDs)	2TB (Up to 4 HDDs)
Backup	Backup Interface		USB 2.0, x3 Network	USB 2.0, x3 Network
	Supportable Devices		Memory Stick CD-RW, DVD-RW, HDD	Memory Stick CD-RW, DVD-RW, HDD
Serial I/F	PTZ Control Interface		RS-485/ RS-422, x2	RS-485/ RS-422, x2
	Serial Interface		RS-232C, x2 (D-SUB9)	RS-232C, x2 (D-SUB9)
Network	Network Connection		Ethernet 10/100 M (RJ-45)	Ethernet 10/100 M (RJ-45)
	Network Transmission Speed		Up to 120 IPS @ 352x240	Up to 120 IPS @ 352x240
	Bandwidth Control		Yes	Yes
Security	Password Protection		Yes	Yes
	Image Authentication		Yes	Yes
Power			AC Free 100~240 V, 50/60 Hz	AC Free 100~240 V, 50/60 Hz
Power consumption			Max. 85 W (1 HDD)	Max. 85 W (1 HDD)
Dimension (WxDxH mm)			430 x 360 x 88	430 x 360 x 88
Weight (without HDD)			6 Kg	6 Kg
Operation Temp. / Humidity			0 °C ~ 40 °C / 0%RH ~ 80%RH	0 °C ~ 40 °C / 0%RH ~ 80%RH



Free Manuals Download Website

<http://myh66.com>

<http://usermanuals.us>

<http://www.somanuals.com>

<http://www.4manuals.cc>

<http://www.manual-lib.com>

<http://www.404manual.com>

<http://www.luxmanual.com>

<http://aubethermostatmanual.com>

Golf course search by state

<http://golfingnear.com>

Email search by domain

<http://emailbydomain.com>

Auto manuals search

<http://auto.somanuals.com>

TV manuals search

<http://tv.somanuals.com>