



LCD TV

OWNER'S MANUAL

MODELS: 15LS1R * 20LS1R *
 20LS2R * 23LS2R *
 15LC1R * 20LC1R *



Please read this manual carefully before operating your set.
Retain it for future reference.
Record model number and serial number of the set.
See the label attached on the back cover and quote
this information to your dealer when you require service.

Contents

Installation	3
Location and function of controls	8
Remote control handset	
Battery installation / Front / Rear	
Basic operation	14
On and off	
On-Screen Menu Language/Country Selection	
On screen menus	15
Menu selection / Programme selection	
Volume adjustment	
Setting up TV stations	16
Auto programme tuning	
Manual programme tuning	
Programme edit / Favourite programme	
Calling the programme table	
Picture adjustment	21
PSM (Picture Status Memory)	
Picture adjustment	
CSM (Colour Status Memory)	
XD function / Cinema / Reset	
Sound adjustment	25
SSM (Sound Status Memory)	
Sound adjustment / Stereo/Dual reception	
NICAM reception / Sound output selection	
Time Menu	27
Clock / On/Off time	
Auto sleep / Sleep timer	
Other functions	29
Child lock / XD Demo	
TV, AV and PC modes / Auto AV switching	
Teletext	32
Switch on/off	
SIMPLE text / TOP text	
FASTEXT / Special teletext functions	
Connection of external equipment	34
Aerial socket / Euro scart socket (VCR)	
Audio/Video in sockets	
S-Video/Audio in sockets (S-Video)	
DVD input sockets	
DTV in sockets / Headphone socket	
Connection of PC	37
PC in socket	
PC Setup	
Selecting wide XGA mode	
Picture format	40
Troubleshooting checklist	41
Product Specifications	43

Installation

Stand Installation

1. Assemble parts of stand body with cover base of the stand. Insert stand body into a cover base until clicking sound.
2. Carefully place the product screen side down on a cushioned surface that will protect product and screen from damage.
3. Place the product stand on the product as shown.

Note: Here shown may be somewhat different from your set.

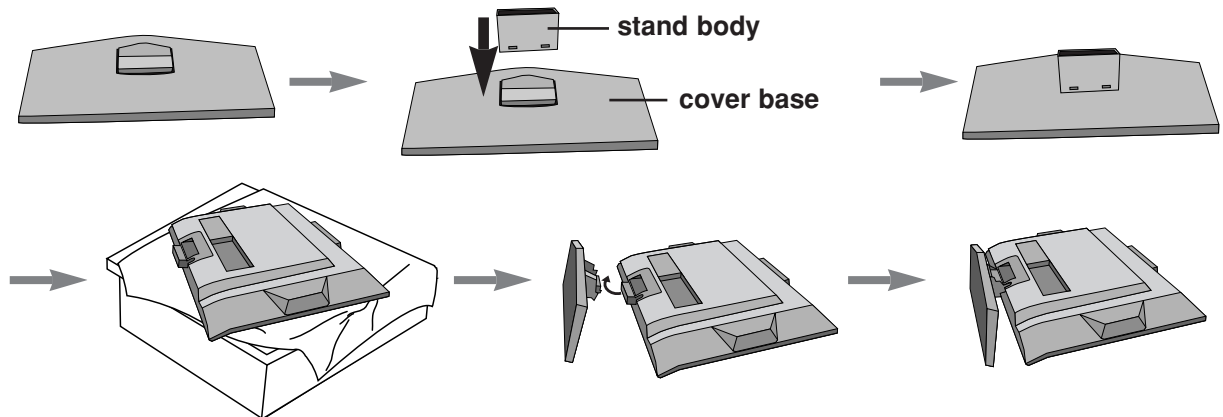

Detaching stand

1. Place the set with its front facing downward on a cushion or soft cloth.
2. Hold the stand with both hands and bend it upward.
3. Pull each side of cover base backward during pressing latch upward.
4. Hold cover base and pull with shake it backward to separate from stand body.
5. Pull stand body to separate from set during pressing 2 latches.

Note: Here shown may be somewhat different from your set.

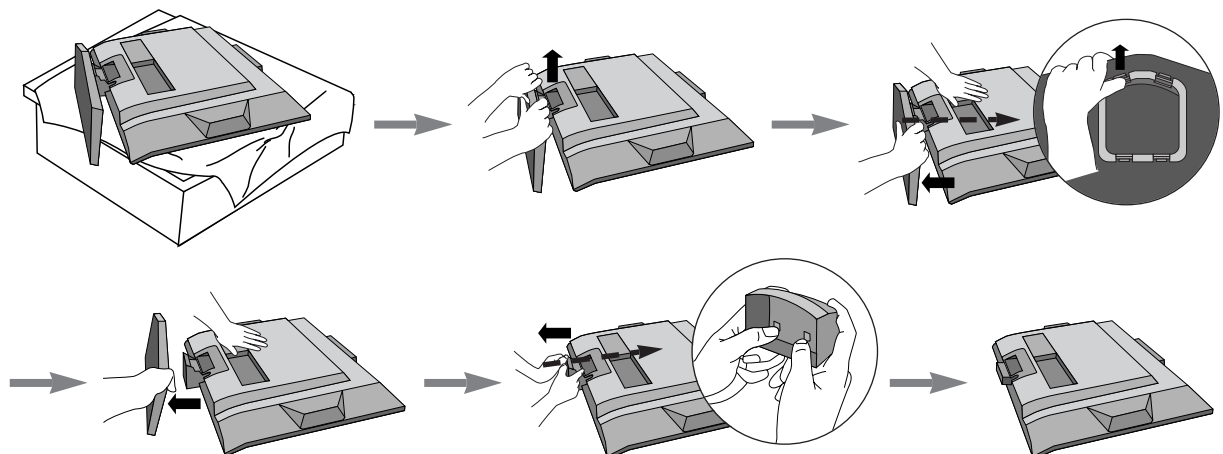

Installation

Unfolding the stand base

1. Place the set with its front facing downward on a cushion or soft cloth.
2. Hold down the release button inside the stand and strongly pull out the stand with your two hands.

Note: Here shown may be somewhat different from your set.

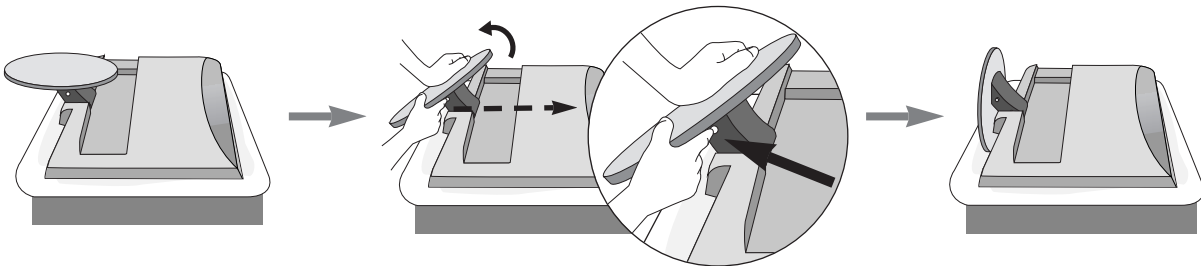

The stand won't move if you don't press release button.

Connection of TV

1. Connect the aerial cable to the socket marked **ANTENNA IN** on the back. For the best reception an outdoor aerial should be used.
2. To connect an additional equipment, see the **Connection of external equipment** section.
3. Connect the power cord.

Note: Here shown may be somewhat different from your set.

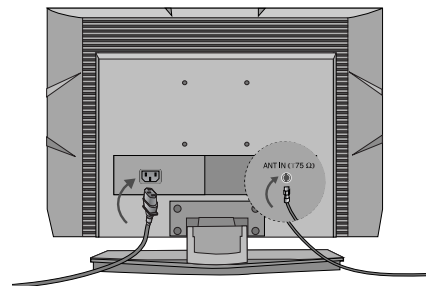

Basic connection

1. Connect the cables as necessary.
To connect an additional equipment, see the **Connection of external equipment** section.
2. Install the **Cable management** as shown.

Note: Here shown may be somewhat different from your set.

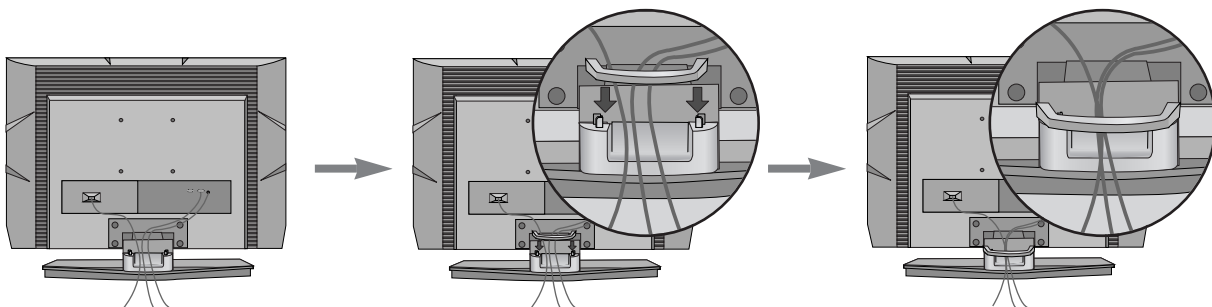

Installation

How to remove the Cable management

First, press the cable management.

Hold the **Cable management** with both hands and pull it upward.

Note: Do not hold the CABLE MANAGEMENT when moving the product. (If the product is dropped, you may be injured or the product may be broken.)

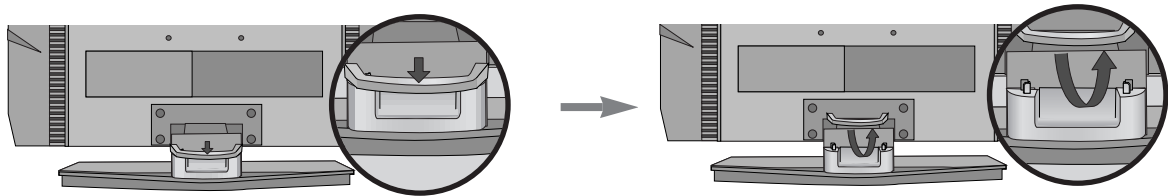

Wall Mount: Horizontal installation

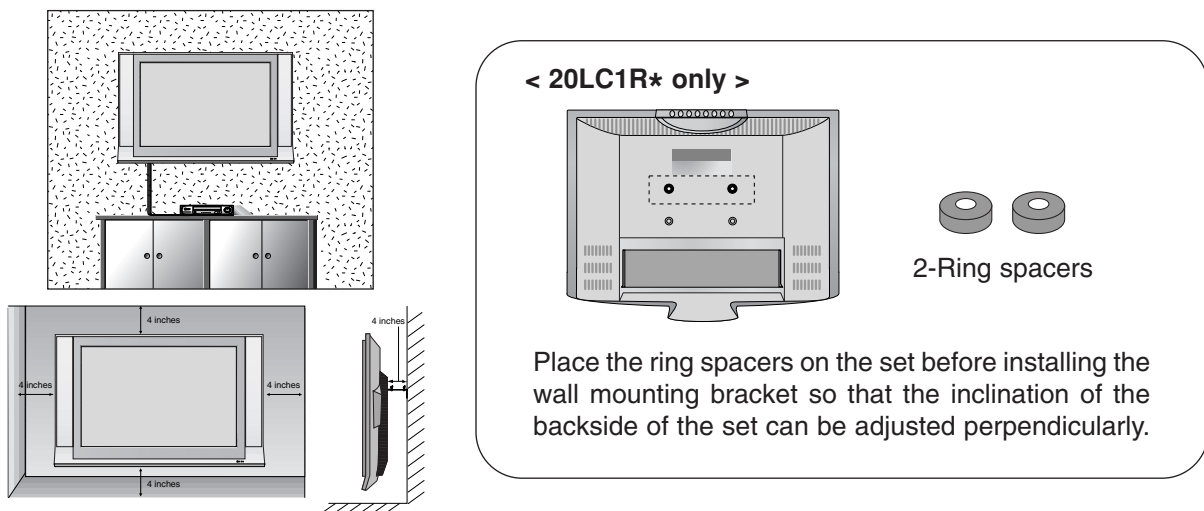

For proper ventilation, allow a clearance of 4" on each side and from the wall. Detailed installation instructions are available from your dealer, see the optional Tilt Wall Mounting Bracket Installation and Setup Guide.

Desktop Pedestal Installation

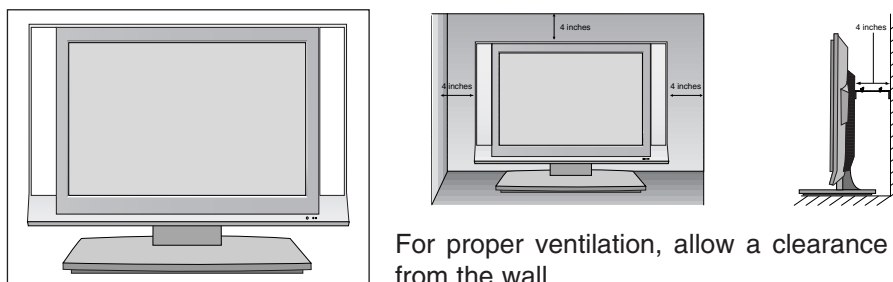

For proper ventilation, allow a clearance of 4" on each side and from the wall.

Installation

Positioning your display

Adjust the position of the panel in various ways for maximum comfort.

- Tilt range

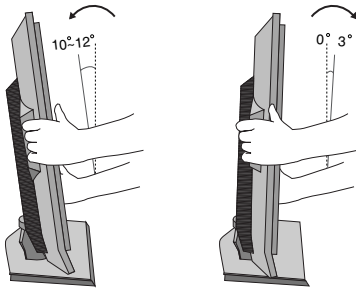

Location

Position your set so that no bright light or sunlight falls directly onto the screen. Care should be taken not to expose the set to any unnecessary vibration, moisture, dust or heat. Also ensure that the set is placed in a position to allow a free flow of air. Do not cover the ventilation openings on the back cover. If you intend to mount the TV to a wall, attach VESA standard mounting interface (optional parts) to the back of the TV.

When you install the set to use the wall mounting bracket (optional parts), fix it carefully so as not to drop.

Installation

Kensington Security System

- The TV is equipped with a Kensington Security System connector on the back panel. Connect the Kensington Security System cable as shown below.
- For the detailed installation and use of the Kensington Security System, refer to the user's guide provided with the Kensington Security System.
For further information, contact <http://www.kensington.com>, the internet homepage of the Kensington company. Kensington sells security systems for expensive electronic equipment such as notebook PCs and LCD projectors.

Note:

- *The Kensington Security System is an optional accessory.*

Note:

- If the TV feels cold to the touch, there may be a small "flicker" when when it is turned on. This is normal, there is nothing wrong with TV.*
- Some minute dot defects may be visible on the screen, appearing as tiny red, green, or blue spots. However, they have no adverse effect on the monitor's performance.*
- Avoid touching the LCD screen or holding your finger(s) against it for long periods of time. Doing so may produce some temporary distortion effects on the screen.*
- Here shown may be somewhat different from your set.*

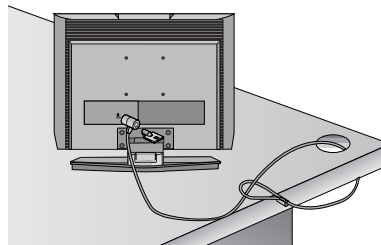
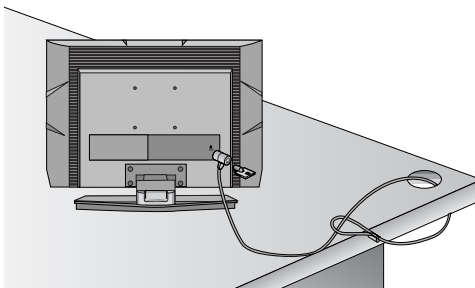
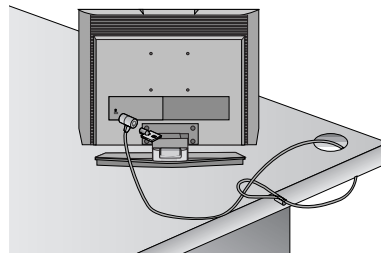
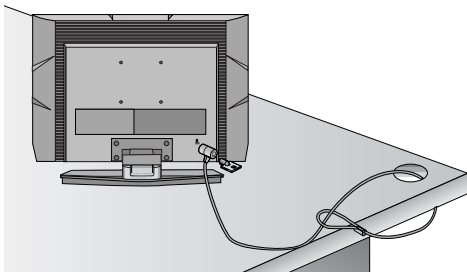

Location and function of controls

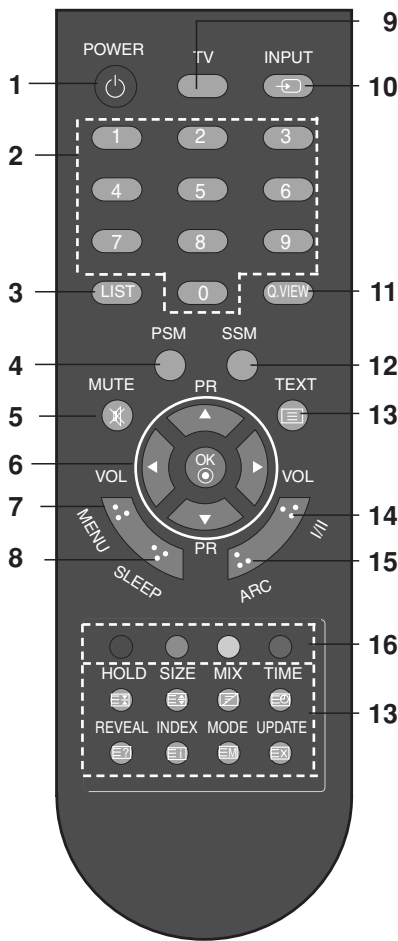

[with ARC]

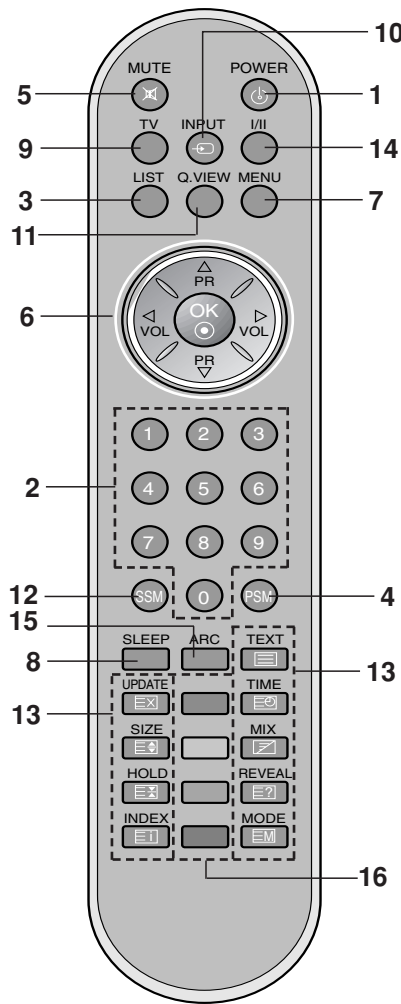

[with ARC]

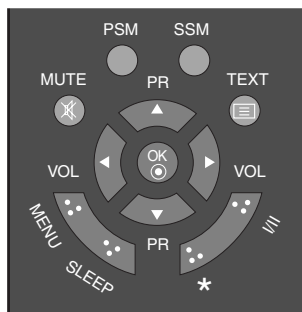
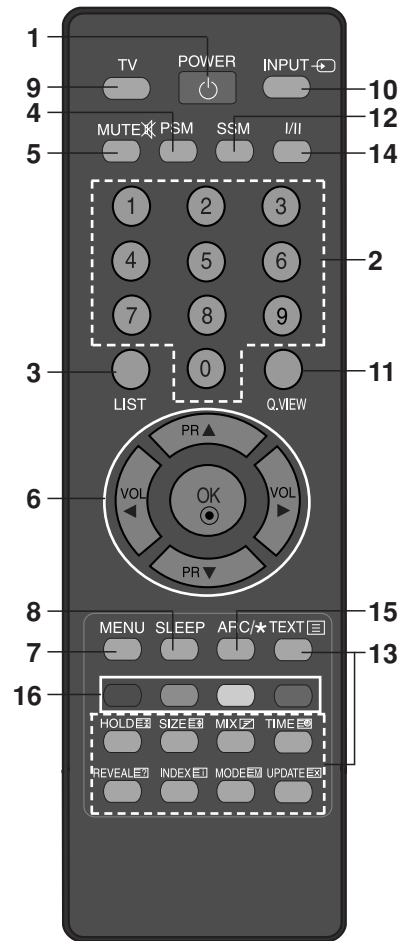

[without ARC]

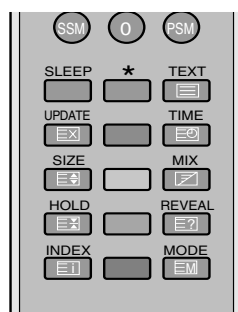

[without ARC]

Location and function of controls

All the functions can be controlled with the remote control handset. Some functions can also be adjusted with the buttons on the top panel of the set. Only the remote control handset supplied will operate this set.

Remote control handset

Before you use the remote control handset, please install the batteries. See the next page.

1. **POWER**
switches the set on from standby or off to standby.
2. **NUMBER BUTTONS**
switches the set on from standby and selects a programme.
3. **LIST**
displays the programme table.
4. **PSM (Picture Status Memory)**
recalls your preferred picture setting.
5. **MUTE**
switches the sound on or off.
Press the **MUTE** button. The sound is switched off and the display  appears. You can cancel it by pressing the **MUTE**, **◀ / ▶**, **I/II**, or **SSM** button.
6. **▲ / ▼ (Programme Up/Down)**
selects a programme or a menu item.
switches the set on from standby.
◀ / ▶ (Volume Down/Up)
adjusts the volume.
adjusts menu settings.
OK
accepts your selection or displays the current mode.
7. **MENU**
selects a menu.
8. **SLEEP**
sets the sleep timer.
9. **TV**
returns to the TV mode.
switches the set on from standby.
10. **INPUT**
selects the remote operating mode.
switches the set on from standby.

11. **Q.VIEW**
returns to the previously viewed programme.
Press the **Q.VIEW** button to view the last programme you were watching.
12. **SSM (Sound Status Memory)**
recalls your preferred sound setting.
13. **TELETEXT BUTTONS**
These buttons are used for teletext.
For further details, see the 'Teletext' section.
14. **I/II**
selects the language during dual language broadcast.
15. **ARC (20LS2R*/ 23LS2R*)**
select your desired picture format.
16. **COLOURED BUTTONS** : These buttons are used for teletext (only TELETEXT models) or programme edit.

* : No function

Battery installation

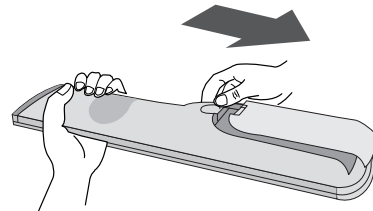

The remote control handset is powered by two AAA batteries. To load the batteries, turn the remote control handset over and open the battery compartment. Install two batteries as indicated by the polarity symbols (\oplus and \ominus) marked inside the compartment.

Note : To avoid damage from possible battery leakage, remove the batteries if you do not plan to use the remote control handset for an extended period of time.

Location and function of controls

Front

If your product has a protection film attached, remove the film and then wipe the product with a polishing cloth.

Top panel

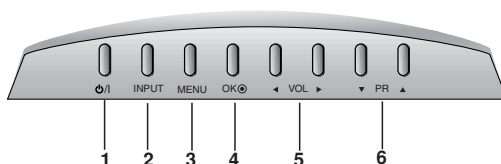

15LS1R*/ 20LS1R*

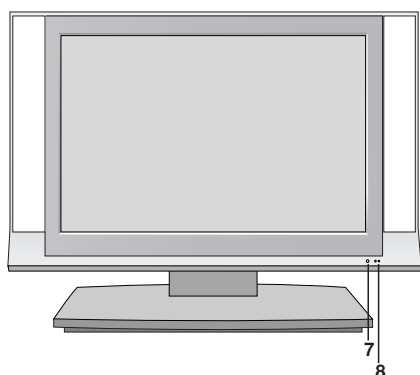

20LS2R*/ 23LS2R*

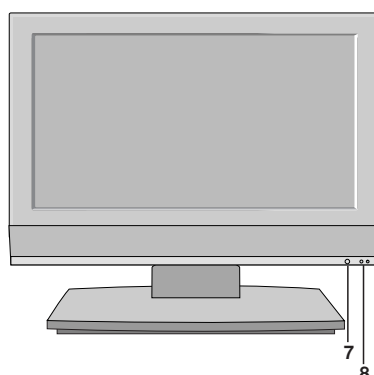

15LC1R*/ 20LC1R*

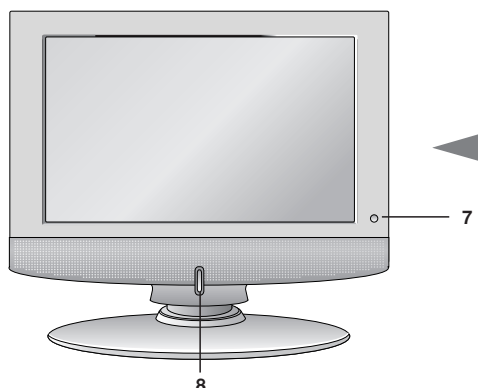

Top panel

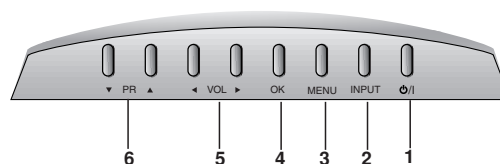

1. **ON/OFF (⏻ / I)**
switches the set on from standby or off to standby.
2. **INPUT**
selects the remote operating mode.
switches the set on from standby.
3. **MENU**
selects a menu.
4. **OK**
accepts your selection or displays the current mode.
5. **◀ / ▶ (Volume Down/Up)**
adjusts the volume.
adjusts menu settings.

6. **▼ / ▲ (Programme Down/Up)**
selects a programme or a menu item.
switches the set on from standby.
7. **REMOTE CONTROL SENSOR**
8. **POWER/STANDBY INDICATOR**
 - 15LS1R*/ 20LS1R*/ 20LS2R*/ 23LS2R*
illuminates red in standby mode.
illuminates green when the set is switched on.
 - 15LC1R*/ 20LC1R*
illuminates orange in standby mode.
illuminates blue when the set is switched on.

Location and function of controls

Rear

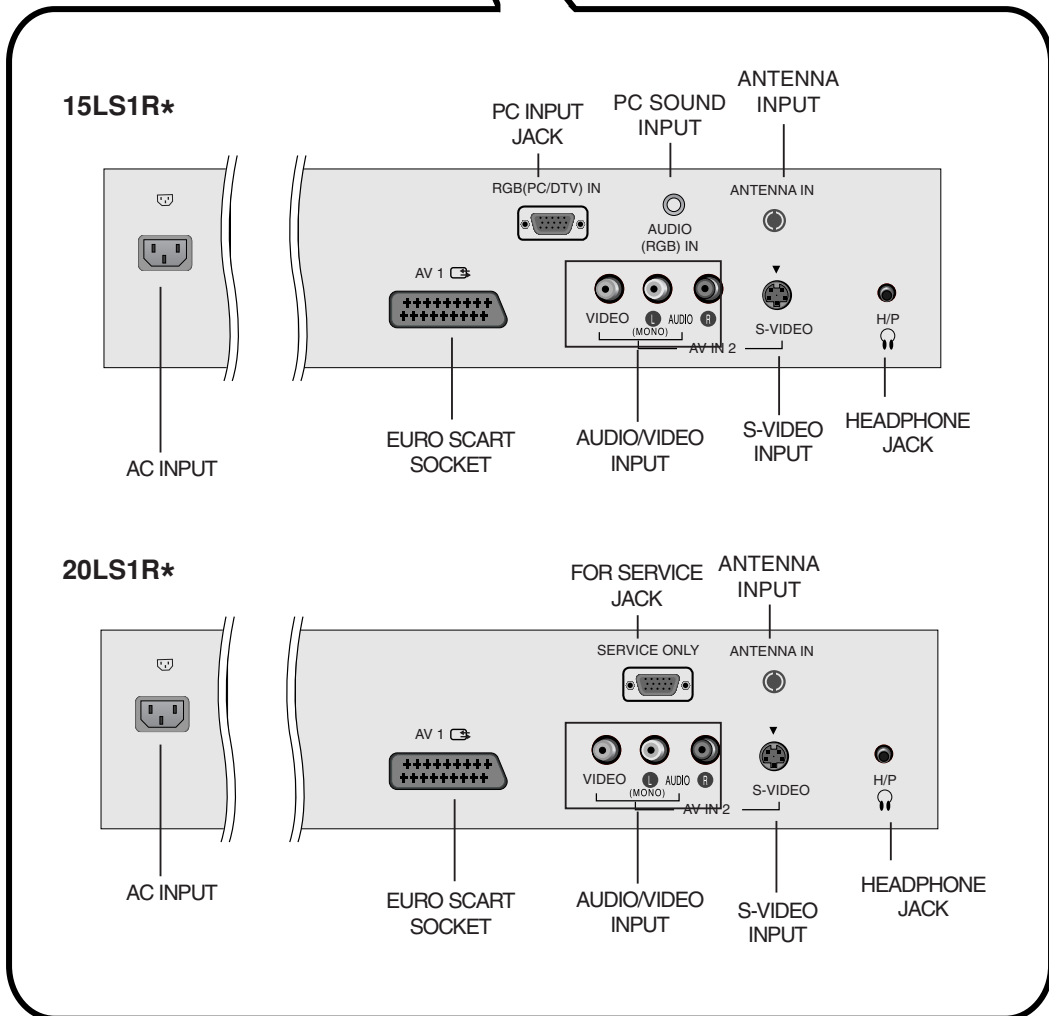
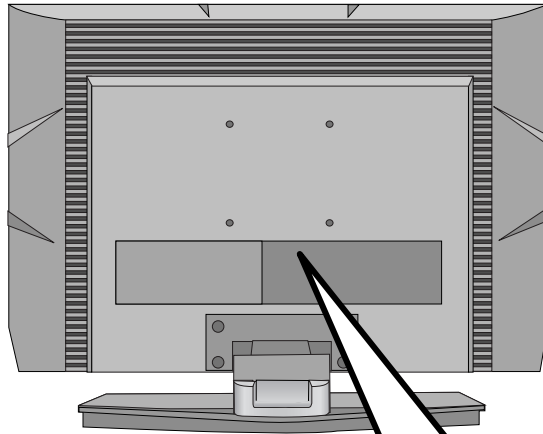

Location and function of controls

Rear

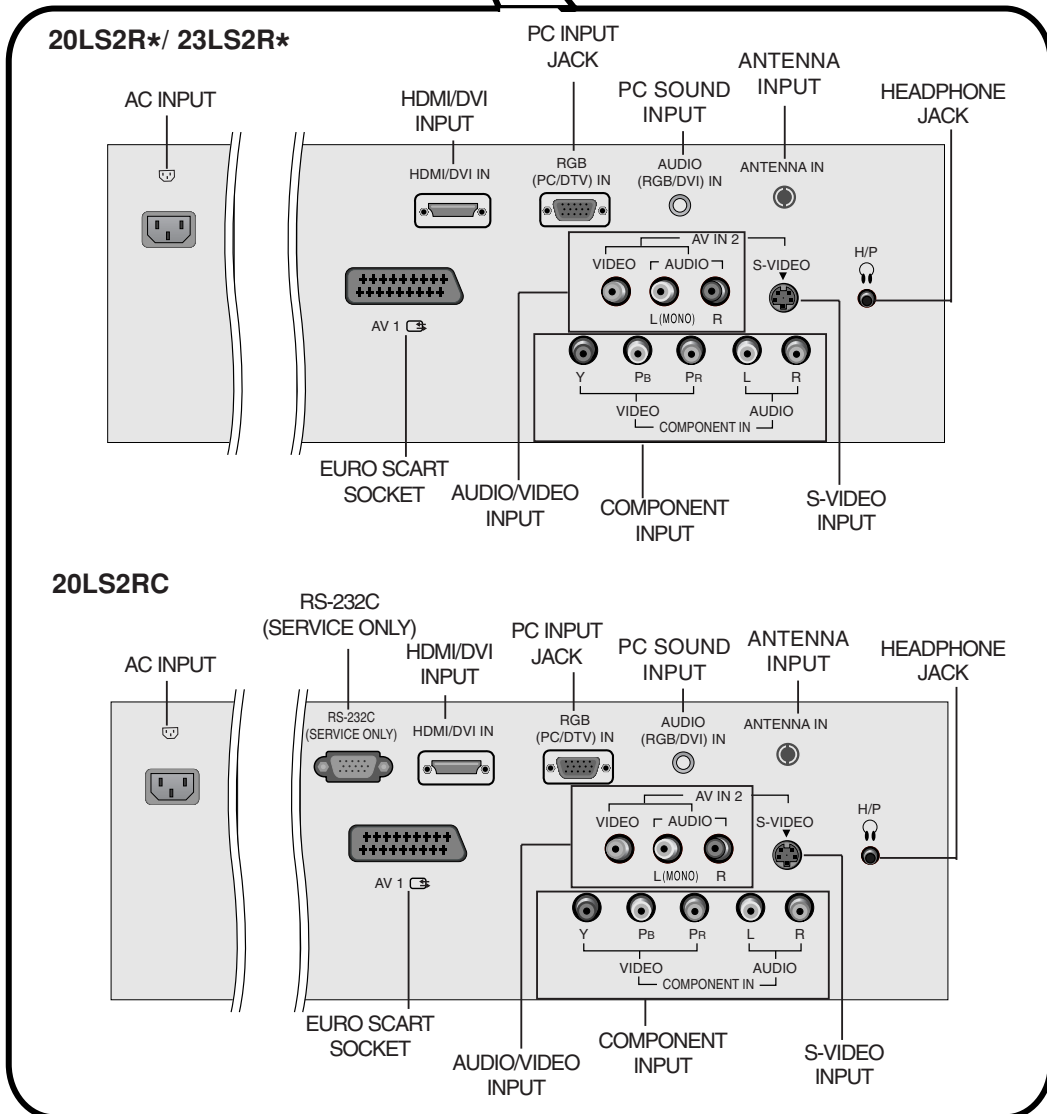
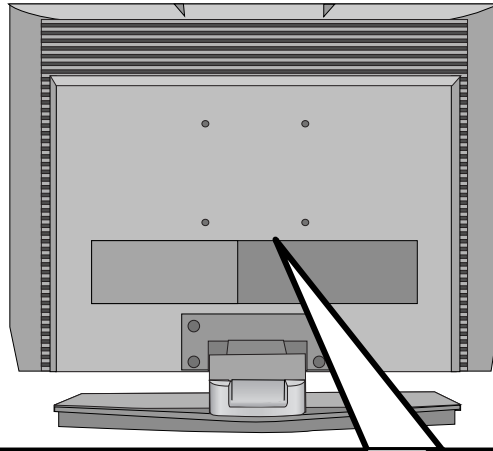

Location and function of controls

Rear

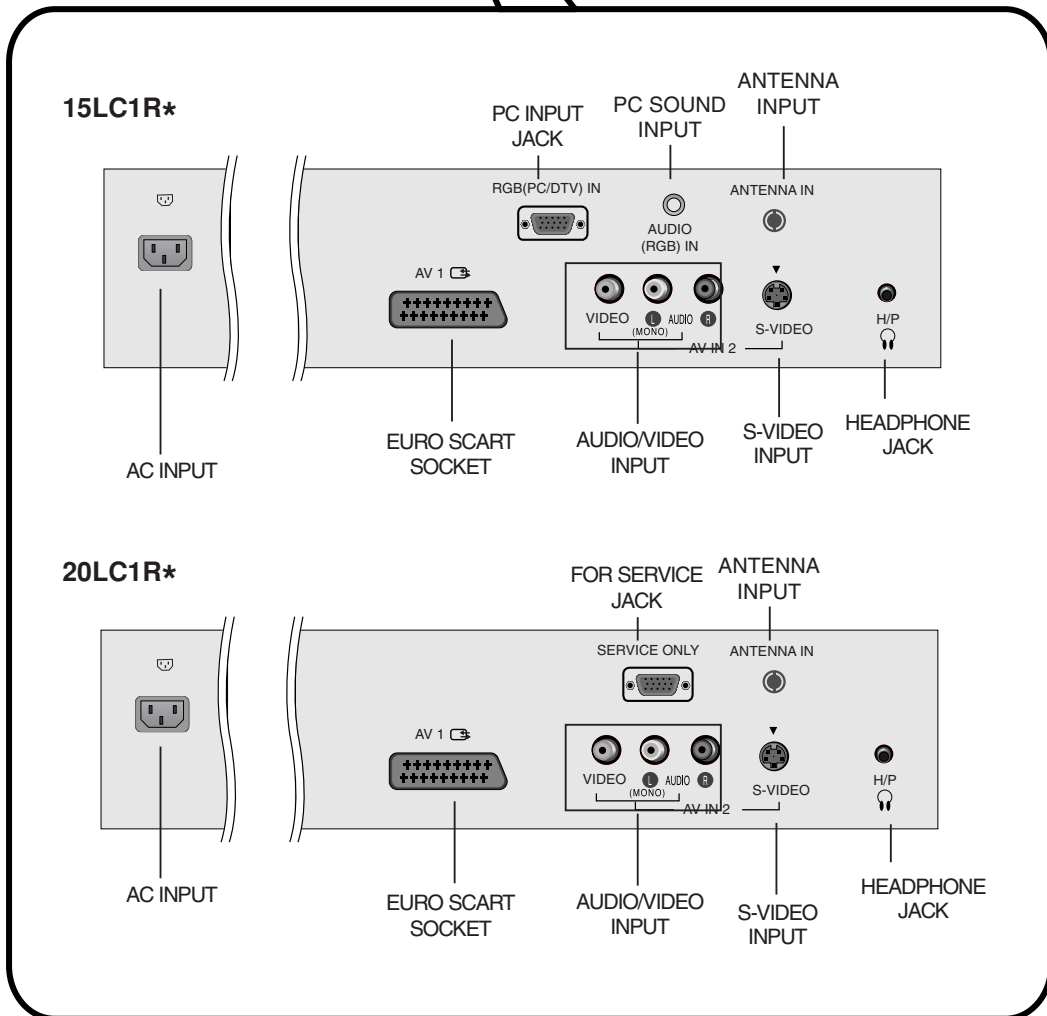
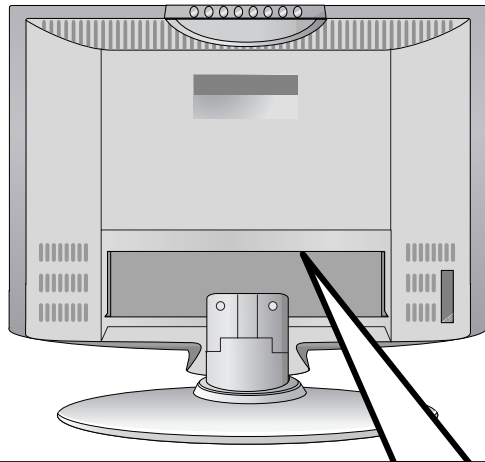

Basic operation

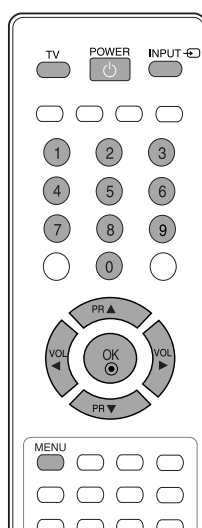
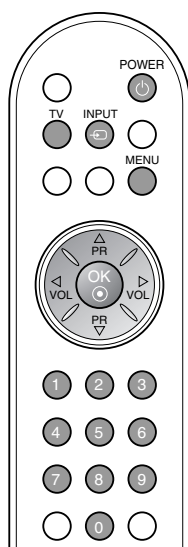
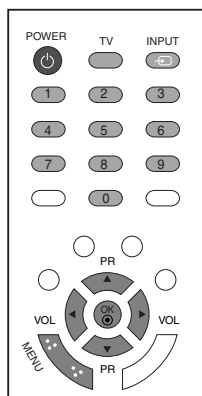

On and off

1. Press the **POWER**, **▲ / ▼**, **TV**, **INPUT** or **NUMBER** buttons to switch it on fully.
2. Press the **POWER** button. The set reverts to standby mode.
3. Pull out mains plugs to switch the set off.

Note : If, while the set is switched on, the mains plug is disconnected the set will switch to standby or power on when the mains plug is replaced in the mains power socket.

On-Screen Menu Language / Country Selection

Installation guide menu appears on TV screen when it is turned on for the first time.

1. Press the **▲ / ▼ / ◀ / ▶** button and then, **OK** button to select your desired language.
2. Press the **▲ / ▼ / ◀ / ▶** button and then, **OK** button to select your country.

* If you want to change Language/ Country selection

1. Press the **MENU** button and then **▲ / ▼** button to select the **SPECIAL** menu.
2. Press the **▶** button and then **▲ / ▼** button to select **Language**. The menus can be shown on the screen in the selected language.
Or, Press the **▶** button and then **▲ / ▼** button to select **Country**.
3. Press the **▶** button and then **▲ / ▼ / ◀ / ▶** button to select your desired language or country.
4. Press the **OK** button.
5. Repeatedly press the **MENU** button to return to normal TV viewing.

Note:

- a. If you don't finish set up **Installation Guide** by pressing **MENU** button or time out of **OSD (On Screen Display)** display, it will continuously appear until completing set up whenever the set is turned on.
- b. If you select wrong local country, the teletext may not appear correctly on the screen and some problem may happen during teletext operation.
- c. Hebrew is added to **Country of Installation Guide** according to the countries which using Hebrew languages.

On screen menus

Menu selection

1. Press the **MENU** button and then ▲ / ▼ button to display each menu.
 2. Press the ► button and then ▲ / ▼ button to select a menu item.
 3. Change the setting of an item in the sub or pull-down menu with ◀ / ▶ button.
- You can move to the higher level menu by pressing the **OK** button and to move to the lower level menu by pressing the **MENU** button.

Note :

- a. The **SCREEN** (20LS1R*/20LC1R*) menu is not displayed.
- b. In the teletext mode, menus are not displayed.
- c. On some models, the **Language** will not be displayed.

Programme selection

You can select a programme number with the ▲ / ▼ or NUMBER buttons.

Volume adjustment

Press the ◀ / ▶ button to adjust the volume.

* : 20LS2R*, 23LS2R

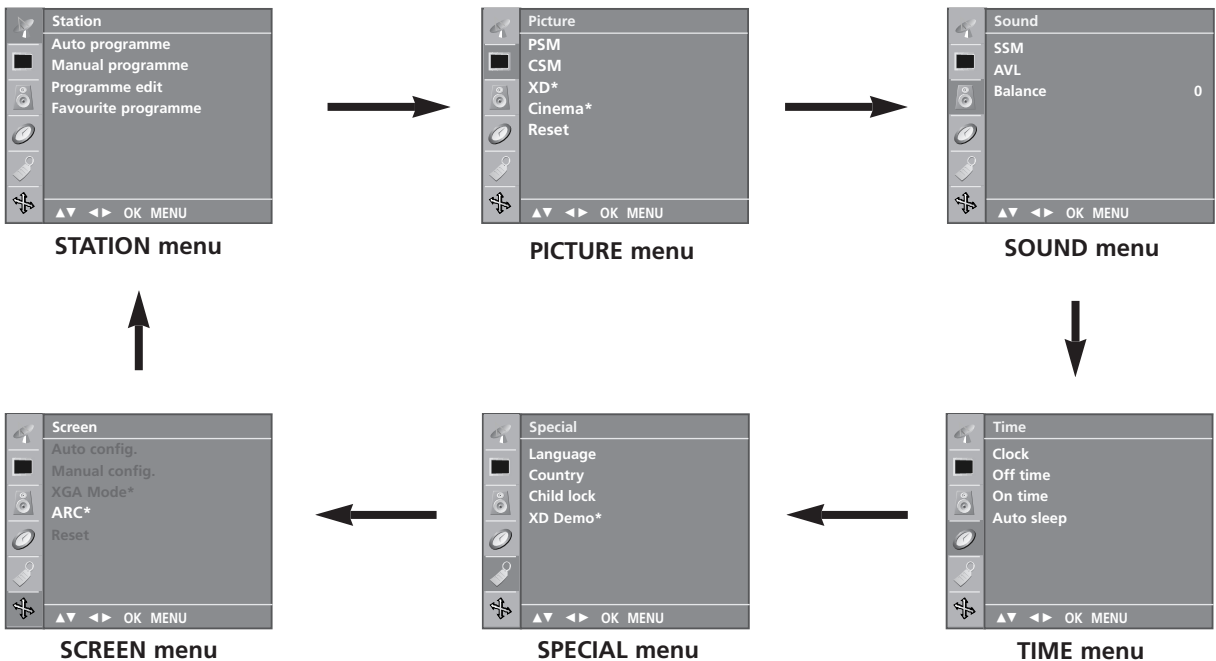
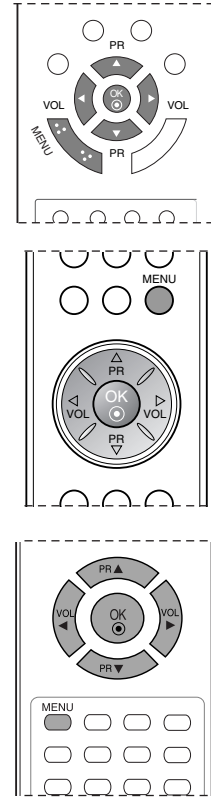

Setting up TV stations



Up to 100 TV stations can be stored by programme numbers (0 to 99). Once you have preset the stations, you will be able to use the ▲ / ▼ or NUMBER buttons to scan the stations you have programmed. Stations can be tuned using automatic or manual modes.

Auto programme tuning

All stations that can be received are stored by this method. It is recommended that you use auto programme during installation of this set.

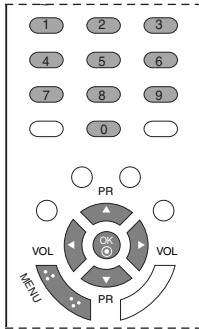

1. Press the **MENU** button and then ▲ / ▼ button to select the **Station** menu.
2. Press the ► button and then ▲ / ▼ button to select **Auto programme**.

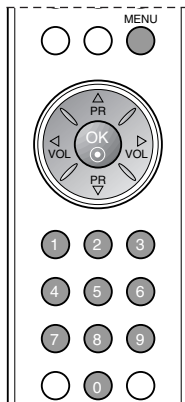

3. Press the ► button. Select a TV system with the ► button and then ▲ / ▼ button on the **System** menu;
 - BG** : PAL B/G, SECAM B/G (Europe/East Europe)
 - I** : PAL I/II (U.K./Ireland)
 - DK** : PAL D/K, SECAM D/K (East Europe)
 - L** : SECAM L/L' (France)
4. Press the **OK** button.
5. Press the ▲ / ▼ button to select **Storage from**.
6. Select the beginning programme number with the ◀ / ▶ button or NUMBER buttons on the **Storage from** pull-down menu. Any number under 10 is entered with a numeric '0' in front of it, i.e. '05' for 5.
7. Press the **OK** button.
8. Press the ▲ / ▼ button to select **Search**.

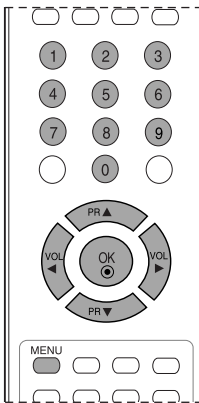
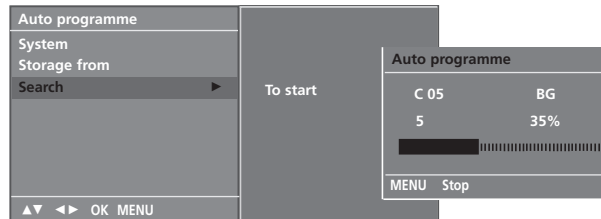

9. Press the ► button to begin auto programming. All receivable stations are stored. To stop auto programming, press the **MENU** button. When auto programming is completed, the **Programme edit** menu appears on the screen. See the 'Programme edit' section to edit the stored programme.
10. Repeatedly press the **MENU** button to return to normal TV viewing.

Setting up TV stations

Manual programme tuning

Manual programme lets you manually tune and arrange the stations in whatever order you desire. Also you can assign a station name with five characters to each programme number.

1. Press the **MENU** button and then **▲ / ▼** button to select the **Station** menu.
2. Press the **▶** button and then **▲ / ▼** button to select **Manual programme**.
3. Press the **▶** button and then **▲ / ▼** button to select **Storage**.



4. Select the desired programme number (0 to 99) with the **◀ / ▶** button or **NUMBER** buttons on the **Storage** menu. Any number under 10 is entered with a numeric '0' in front of it, i.e. '05' for 5.
5. Press the **OK** button.
6. Press the **▲ / ▼** button to select **System**.
7. Select a TV system with the **▶** button and then **◀ / ▶** button on the **System** menu;
 - BG** : PAL B/G, SECAM B/G (Europe/East Europe)
 - I** : PAL I/II (U.K./Ireland)
 - DK** : PAL D/K, SECAM D/K (East Europe)
 - L** : SECAM L/L' (France)
8. Press the **OK** button.
9. Press the **▲ / ▼** button to select **Band**.
10. Press the **▶** button and then **▲ / ▼** button to select **VHF/UHF** or **Cable** on the **Band** menu.
11. Press the **OK** button.
12. Press the **▲ / ▼** button to select **Channel**.
13. Select the desired programme with **◀ / ▶** button or **NUMBER** buttons.
14. Press the **OK** button.
15. Press the **▲ / ▼** button to select **Search**.
16. Press the **▶** button and then **◀ / ▶** button to commence searching on the **Search** pull-down menu. If a station is found the search will stop.
17. Press the **OK** button to store it.
18. To store another station, repeat steps 3 to 17.



19. Repeatedly press the **MENU** button to return to normal TV viewing.

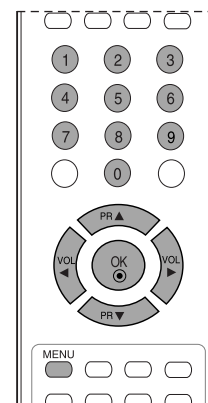
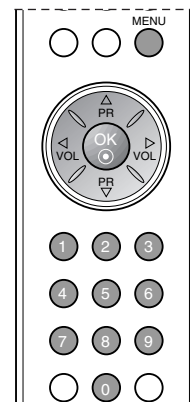
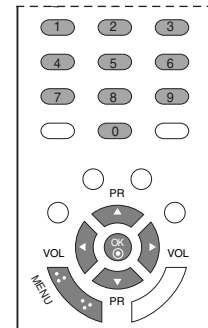

Setting up TV stations



Assigning a station name

1. Repeat the 'Manual programme tuning' steps 1 to 2.
2. Press the ► button and then ▲ / ▼ button to select **Name**.
3. Press the ► button and then use the ▲ / ▼. You can use a blank, +, -, the number 0 to 9 and the alphabet A to Z. It can be saved 5 digits for name.

With the ◀ button you can select in the opposite direction.

4. Select the position by pressing the ◀ / ► button and then make your choice of the second character, and so on.
5. Press the **OK** button to store it.
6. Repeatedly press the **MENU** button to return to normal TV viewing.

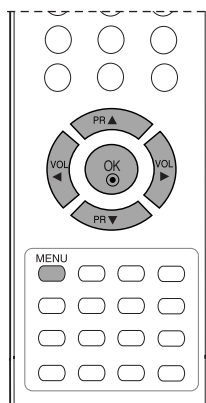
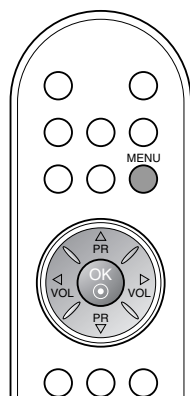
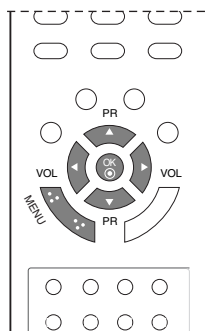

Fine tuning

Normally fine tuning is only necessary if reception is poor.

1. Repeat the 'Manual programme tuning' steps 1 to 2.
2. Press the ► button and then ▲ / ▼ button to select **Fine**.
3. Press the ► button
4. Press the ◀ / ► button to fine tune for the best picture and sound on the **Fine** pull-down menu.
5. Press the **OK** button.
6. Repeatedly press the **MENU** button to return to normal TV viewing.

The finely tuned programme will be indicated by orange number during programme selection.



Setting up TV stations

Programme edit

This function enables you to delete or skip the stored programmes. Also you can move some stations to other programme numbers or insert a blank station data into the selected programme number.

1. Press the **MENU** button and then **▲ / ▼** button to select the **Station** menu.
2. Press the **►** button and then **▲ / ▼** button to select **Programme edit**.
3. Press the **►** button to display the **Programme edit** menu.

Programme edit			
0	C	03	5 S 69
1	BLN	03	6 S 17
2	C	12	7 S 22
3	S	66	8 C 09
4	S	67	9 C 11
<input type="radio"/> Delete <input type="radio"/> Copy <input type="radio"/> Move <input type="radio"/> Skip			
▲▼ ◀▶ OK MENU			

Deleting a programme

1. Select a programme to be deleted with the **▲ / ▼** or **◀ / ▶** button.
2. Press the **RED** button twice.
The selected programme is deleted, all the following programmes are shifted up one position.

Programme edit			
0	C	03	5 S 69
1	BLN	03	6 S 17
2	C	12	7 S 22
3	S	66	8 C 09
4	S	67	9 C 11
<input type="radio"/> Delete			
MENU			

Copying a programme

1. Select a programme to be copied with the **▲ / ▼** or **◀ / ▶** button.
2. Press the **GREEN** button.
All the following programmes are shifted down one position.

Moving a programme

1. Select a programme to be moved with the **▲ / ▼** or **◀ / ▶** button.
2. Press the **YELLOW** button.
3. Move the programme to the desired programme number with the **▲ / ▼** or **◀ / ▶** button.
4. Press the **YELLOW** button again to release this function.

Skipping a programme number

1. Select a programme number to be skipped with the **▲ / ▼** or **◀ / ▶** button.
2. Press the **BLUE** button. The skipped programme turns to blue.
3. Press the **BLUE** button again to release the skipped programme.
When a programme number is skipped it means that you will be unable to select it using the **▲ / ▼** button during normal TV viewing. If you want to select the skipped programme, directly enter the programme number with the **NUMBER** buttons or select it in the programme edit or table menu.

Repeatedly press the **MENU** button to return to normal TV viewing.

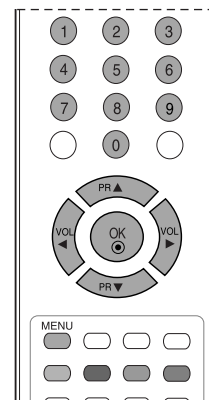
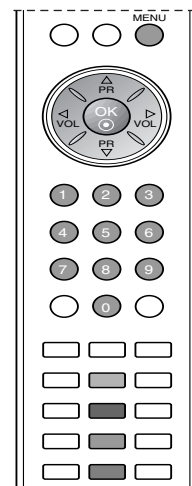
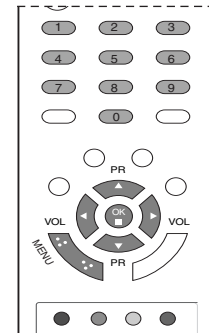

Setting up TV stations



Favourite programme

This function lets you select your favourite programmes directly.

1. Press the **MENU** button and then **▲ / ▼** button to select the **Station** menu.
2. Press the **▶** button and then **▲ / ▼** to select **Favourite programme**.

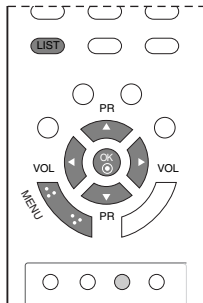

3. Press the **▶** button and then **◀ / ▶** button to select **On** or **Off**.
4. Press the **▲ / ▼** button to select -- -----.
5. Select a desired programme with the **◀ / ▶** button.
6. To store another programme, repeat steps 4 to 5. You can store up to 8 programmes.
7. Repeatedly press the **MENU** button to return to normal TV viewing.

Repeatedly press the **YELLOW** button to select stored favourite programmes while it is selected **On**. Repeatedly press the **YELLOW** button to select previous programmes while it is selected **Off**.

Calling the programme table

You can check the programmes stored in the memory by displaying the programme table.

Displaying programme table

Press the **LIST** button to display the **Programme table** menu. The programme table appears on the screen. One programme table contains ten programmes as below.

0	C	03	5	S	69
1	BLN	03	6	S	17
2	C	12	7	S	22
3	S	66	8	C	09
4	S	67	9	C	11

Note :

- a. You may find some blue programmes. They have been set up to be skipped by auto programming or in the programme edit mode.
- b. Some programmes with the channel number shown in the programme table indicate there is no station name assigned.

Selecting a programme in the programme table

Select a programme with the **▲ / ▼** or **◀ / ▶** button. Then press the **OK** button.

The set switches to the chosen programme number.

Paging through a programme table

There are 10 programme table pages in which contain 100 programmes.

Pressing the **▲ / ▼** or **◀ / ▶** button repeatedly turns the pages.

Press the **MENU** button to return to normal TV viewing.

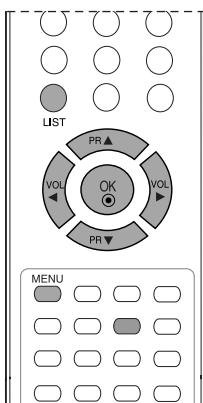
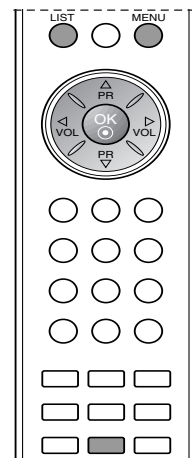

Picture adjustment

PSM (Picture Status Memory)

1. Press the **MENU** button and then **▲ / ▼** button to select the **Picture** menu.
2. Press the **▶** button and then **▲ / ▼** button to select **PSM**.
3. Press the **▶** button and then **▲ / ▼** button to select a picture setting on the **PSM** menu.
4. Press the **OK** button.

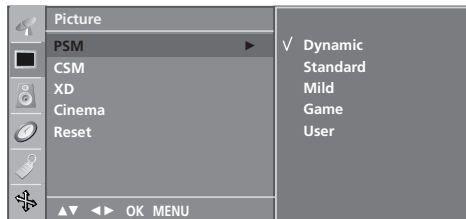

5. Repeatedly press the **MENU** button to return to normal TV viewing.

You can also recall a desired picture (**Dynamic, Standard, Mild, Game** or **User**) with **PSM** button on the remote control. The picture **Dynamic, Standard, Mild** and **Game** are programmed for optimum picture reproduction at the factory and cannot be changed.

Picture adjustment

You can adjust picture contrast, brightness, colour intensity, sharpness, tint to the levels you prefer.

1. Press the **MENU** button and then **▲ / ▼** button to select the **Picture** menu.
2. Press the **▶** button and then **▲ / ▼** button to select **PSM**.
3. Press the **▶** button and then **▲ / ▼** button to select **User**.
4. Press the **▶** button and then **▲ / ▼** button to select the desired picture item.
5. Press the **▶** button and then **◀ / ▶** button to make appropriate adjustments.

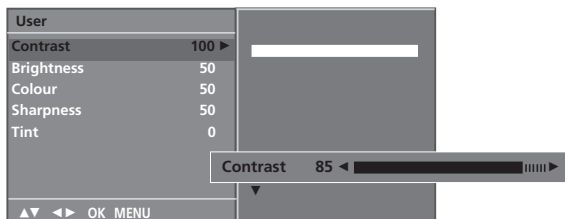

6. Repeatedly press the **MENU** button to return to normal TV viewing.

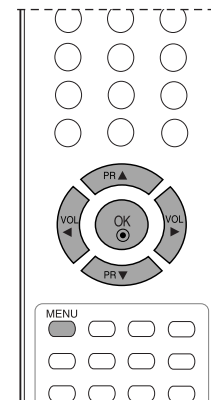
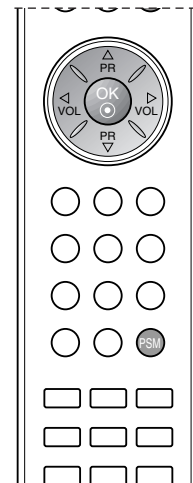
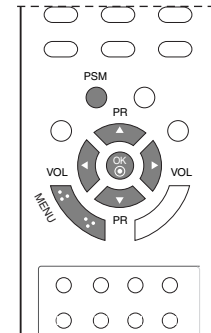
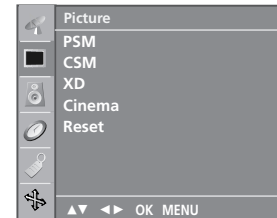

Picture adjustment

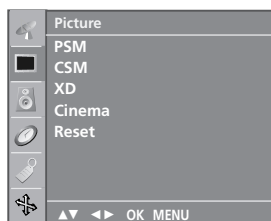

CSM (Colour Status Memory)

Selecting a factory setting colour set.

1. Press the **MENU** button and then **▲** / **▼** button to select the **Picture** menu.
2. Press the **▶** button and then **▲** / **▼** button to select **CSM**.

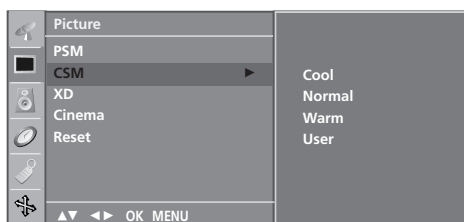

3. Press the **▶** button and then **▲** / **▼** button to select a color setting on the **CSM** menu: **Cool**, **Normal**, **Warm** or **User (Red, Green, Blue)**.
4. Press the **OK** button.
5. Repeatedly press the **MENU** button to return to normal TV viewing.

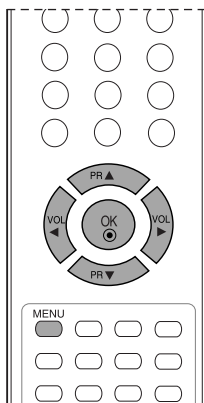
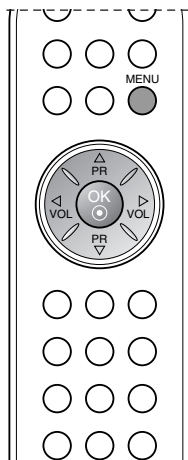
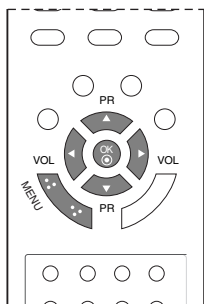

Picture adjustment

XD function

XD is LG electronic's unique picture improving technology to display a real HD source through an advanced digital signal processing algorithm.

1. Press the **MENU** button and then **▲** / **▼** button to select the **Picture** menu.
2. Press the **▶** button and then **▲** / **▼** button to select **XD**.
3. Press the **▶** button and then **▲** / **▼** button to select **Auto** or **Manual**.

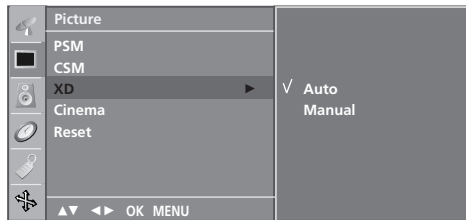

4. Press the **OK** button.
5. Repeatedly press the **MENU** button to return to normal TV viewing.

Selecting the Manual

This menu is activated after selecting the **User** of **PSM**.

1. Press the **▶** button and then **▲** / **▼** button to select **XD Contrast**, **XD Colour** or **XD NR**.
2. Press the **▶** button and then **▲** / **▼** button to select **On** or **Off**.
3. Repeatedly press the **MENU** button to return to normal TV viewing.

XD Contrast : Optimizing the contrast automatically according to the brightness of the reflection.

XD Colour : Adjusting the colors of the reflection automatically to reproduce as closely as possible to the natural colors.

XD NR : Removing the noise up to the point where it does not damage the original picture.



Note: It's not available to use this function in **RGB[PC]**, **HDMI[PC]** mode. This feature is not available for all models.

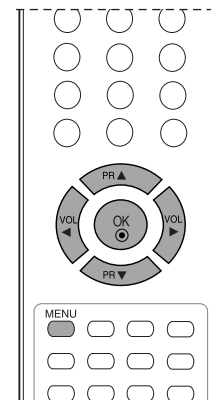
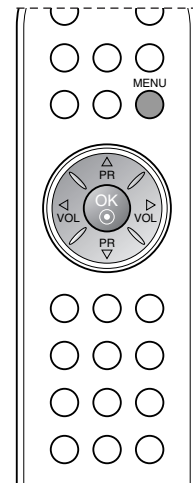
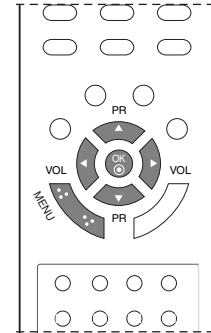
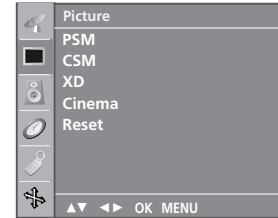

Picture adjustment

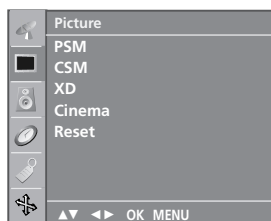

Cinema

Set up the TV for the best picture appearance for viewing movies.

1. Press the **MENU** button and then **▲** / **▼** button to select the **Picture** menu.
2. Press the **▶** button and then **▲** / **▼** button to select **Cinema**.
3. Press the **▶** button and then **▲** / **▼** button to select **On** or **Off**.



4. Repeatedly press the **MENU** button to return to normal TV viewing.

Note: This feature is not available for all models.

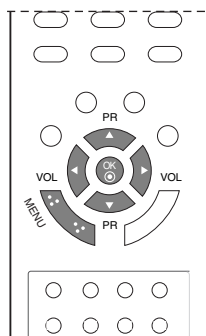

Reset

Returns to the default settings **PSM**, **CSM**, **XD**, **Cinema** at the factory.

1. Press the **MENU** button and then **▲** / **▼** button to select the **Picture** menu.
2. Press the **▶** button and then **▲** / **▼** button to select **Reset**.
3. Press the **▶** button to initialize the adjusted value.

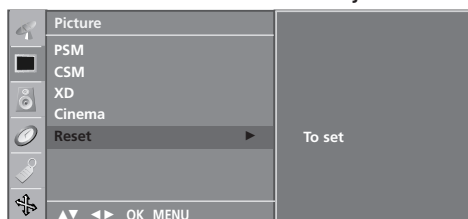

4. Repeatedly press the **MENU** button to return to normal TV viewing.

Note: This feature is not available for all models.

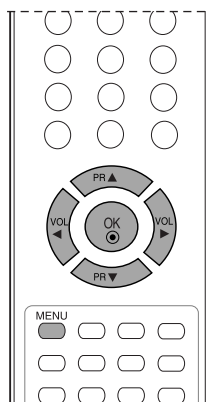
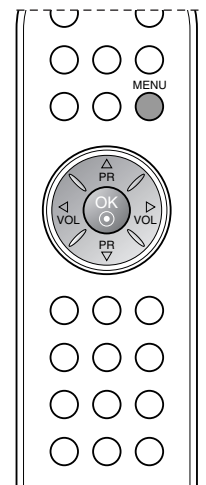

Sound adjustment

SSM (Sound Status Memory)

You can select your preferred sound setting; Flat, Music, Movie or Sports and you can also adjust the sound frequency of the equalizer.

1. Press the **MENU** button and then \blacktriangle / \blacktriangledown button to select the **Sound** menu.

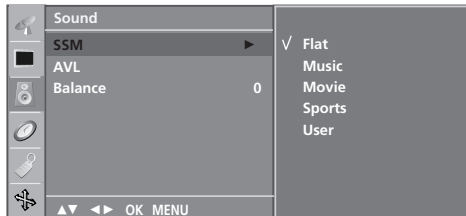

2. Press the \blacktriangleright button and then \blacktriangle / \blacktriangledown button to select **SSM**.
3. Press the \blacktriangleright button and then \blacktriangle / \blacktriangledown button to select a sound setting on the **SSM** menu.

Sound Frequency Adjustment

- a. Press the **OK** button in **User**.
- b. Select a sound band by pressing the \blacktriangleleft / \blacktriangleright button.
- c. Make appropriate sound level with the \blacktriangle / \blacktriangledown button.
- d. Press the **OK** button to store it for the sound **User**.

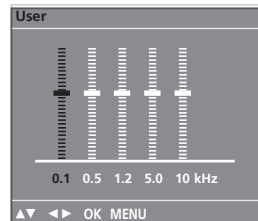

4. Repeatedly press the **MENU** button to return to normal TV viewing.

You can also recall a desired sound setting (**Flat**, **Music**, **Movie**, **Sports** or **User**) with **SSM** button on the remote control. The sound settings **Flat**, **Music**, **Movie** and **Sports** are programmed for optimum sound reproduction at the factory and cannot be changed.

Note : If you press the **SSM** button after making appropriate adjustment on the **User** sub menu, the display **User** automatically appears even though you have already set a factory preset setting; **Flat**, **Music**, **Movie** or **Sports**.

Sound adjustment

You can adjust balance, **AVL (Auto Volume Leveler)**. **AVL** automatically keeps on an equal volume level even if you change programmes.

1. Press the **MENU** button and then \blacktriangle / \blacktriangledown button to select the **Sound** menu.
2. Press the \blacktriangleright button and then \blacktriangle / \blacktriangledown button to select the desired sound item; **AVL** or **Balance**.

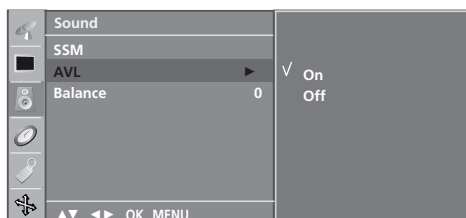

3. Make desired adjustment with the \blacktriangle / \blacktriangledown , \blacktriangleleft / \blacktriangleright and then press the **OK** button.
4. Repeatedly press the **MENU** button to return to normal TV viewing.

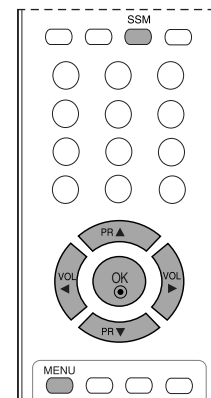
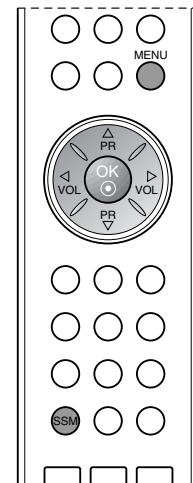
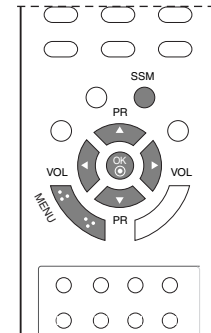
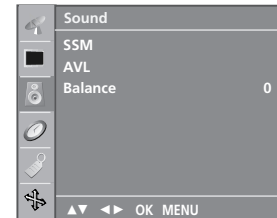

Sound adjustment

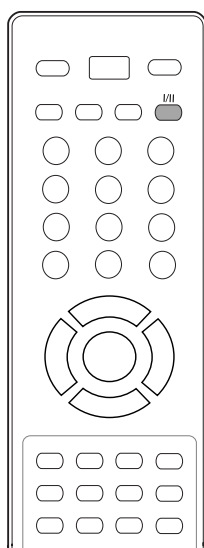
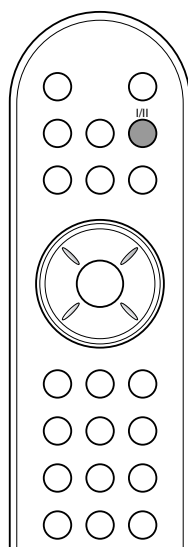
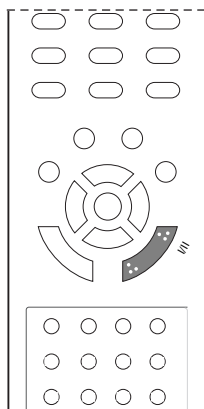

Stereo/Dual reception

When a programme is selected, the sound information for the station appears after the programme number and station name disappear.

Broadcast	On Screen Display
Mono	MONO
Stereo	STEREO
Dual	DUAL I

Mono sound selection

In stereo reception if the stereo signal is weak, you can switch to mono by pressing the I/II button twice. In mono reception the depth of sound is improved. To switch back to stereo, press the I/II button twice again.

Language selection for dual language broadcast

If a programme is received in two languages (dual language), you can switch to **DUAL I**, **DUAL II** or **DUAL I+II** by pressing the I/II button repeatedly.

DUAL I sends the primary broadcast language to the loudspeakers.

DUAL II sends the secondary broadcast language to the loudspeakers.

DUAL I+II sends a separate language to each loudspeaker.

NICAM reception

If your set is equipped with the receiver for NICAM reception, the high quality NICAM (Near Instantaneous Companding Audio Multiplex) digital sound can be received.

Sound output can be selected according to the type of received broadcast as follows by pressing the I/II button repeatedly.

1. When NICAM mono is received, you can select **NICAM MONO** or **FM MONO**.
2. When NICAM stereo is received, you can select **NICAM STEREO** or **FM MONO**. If the stereo signal is weak, switch to **FM mono**.
3. When NICAM dual is received, you can select **NICAM DUAL I**, **NICAM DUAL II** or **NICAM DUAL I+II** or **MONO**. When **FM mono** is selected the display **MONO** appears on the screen.

Sound output selection

In AV mode, you can select output sound for the left and right loudspeakers.

Repeatedly press the I/II button to select the sound output.

L+R : Audio signal from audio L input is sent to left loud-speaker and audio signal from audio R input is sent to right loud-speaker.

L+L : Audio signal from audio L input is sent to left and right loudspeakers.

R+R : Audio signal from audio R input is sent to left and right loudspeakers.

TIME Menu

Clock

You must set the time correctly before using on/off time function.

1. Press the **MENU** button and then ▲ / ▼ button to select the **Time** menu.
2. Press the ► button and then ▲ / ▼ button to select **Clock**.



3. Press the ► button and then ▲ / ▼ button to adjust the hour.
4. Press the ► button and then ▲ / ▼ button to adjust the minute.
5. Press the **MENU** button to save.

On/Off time

The off timer automatically switches the set to standby at the preset time.

1. Press the **MENU** button and then ▲ / ▼ button to select the **Time** menu.
2. Press the ► button and then ▲ / ▼ button to select **Off time** or **On time**.
3. Press the ► button and then ▲ / ▼ button to select **On**.
To cancel **On/Off time** function, press the ▲ / ▼ button to select **Off**.



4. Press the ► button and then ▲ / ▼ button to adjust the hour.
5. Press the ► button and then ▲ / ▼ button to adjust the minute.
6. **Only On time function;** Press the ► button and then ▲ / ▼ button to adjust volume level and programme number.
7. Press the **MENU** button to save.

Note :

- a. In the event of power interruption (disconnection or power failure), the clock must be reset.
- b. Two hours after the set is switched on by the on time function it will automatically switch back to standby mode unless a button has been pressed.
- c. Once the on or off time is set, these functions operate daily at the preset time.
- d. Off Timer function overrides On Timer function if they are set to the same time.
- e. The set must be in standby mode for the On Timer to work.

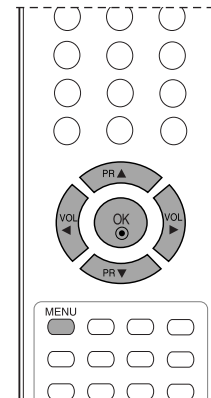
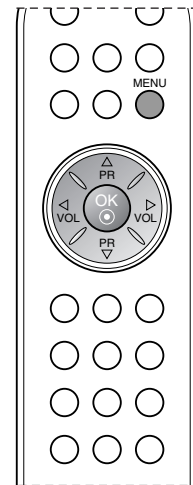
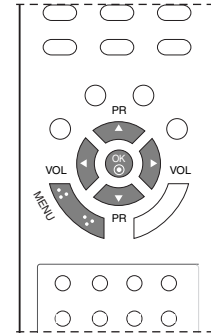

TIME Menu

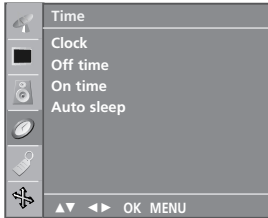

Auto sleep

If you select **On** on the **Auto sleep** menu, the set will automatically switch itself to standby mode approximately ten minutes after a TV station stops broadcasting.

1. Press the **MENU** button and then **▲ / ▼** button to select the **Time** menu.
2. Press the **▶** button and then **▲ / ▼** button to select **Auto sleep**.
3. Press the **▶** button and then **▲ / ▼** button to select **On** or **Off**.



4. Press the **MENU** button to save.

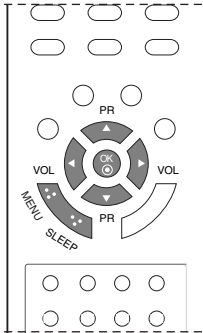

Sleep timer

You don't have to remember to switch the set off before you go to sleep. The sleep timer automatically switches the set to standby after the preset time has elapsed.

Press the **SLEEP** button to select the number of minutes.

The display '⌚ ---' will appear on the screen, followed by **10, 20, 30, 60, 90, 120, 180** and **240**. The timer begins to count down from the number of minutes selected.

Note :

- a. To view the remaining sleep time, press the **SLEEP** button once.
- b. To cancel the sleep time, repeatedly press the **SLEEP** button until the display '⌚ ---' appears.
- c. When you switch the set off, the set releases the preset sleep time.

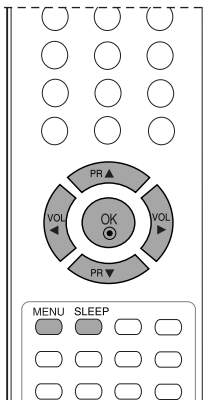
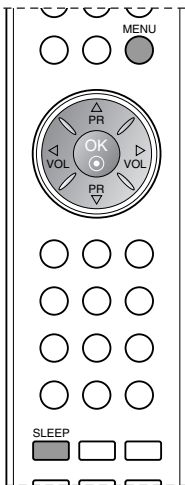

Other functions

Child lock

The TV can be set so that the remote control handset is needed to control it. This feature can be used to prevent unauthorized viewing.

1. Press the **MENU** button and then ▲ / ▼ button to select the **Special** menu.
2. Press the ► button and then ▲ / ▼ button to select **Child lock**.
3. Press the ► button and then ▲ / ▼ button to select **On** or **Off** on the **Child lock** menu.

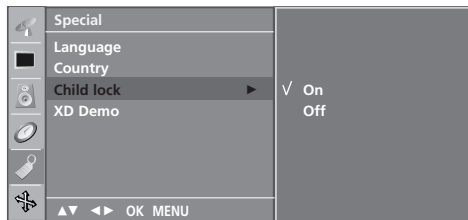

4. Press the **MENU** button to save.
5. Repeatedly press the **MENU** button to return to normal TV viewing.

With the lock on, the display **Child lock on** appears on the screen if any button on the top panel is pressed while viewing the TV.

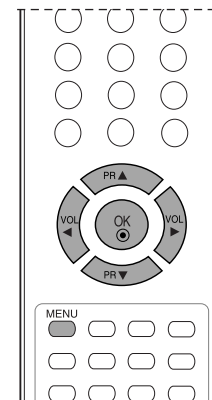
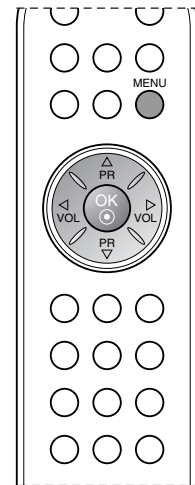
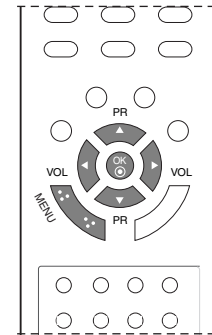

Other functions



XD Demo

Use it to see the difference between XD Demo on and XD Demo off.

1. Press the **MENU** button and then ▲ / ▼ button to select the **Special** menu.
2. Press the ► button and then ▲ / ▼ button to select **XD Demo**.
3. Press the ► button to begin XD Demo.

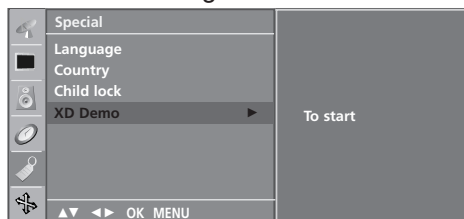

4. Press the **MENU** button to return to normal TV viewing.

Note:

- a. It's not available to use this function in RGB[PC], HDMI[PC] mode.
- b. This feature is not available for all models.

• XD Demo

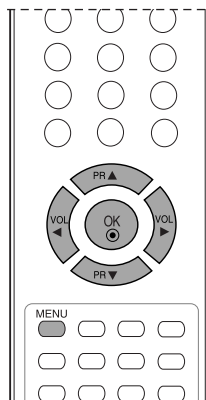
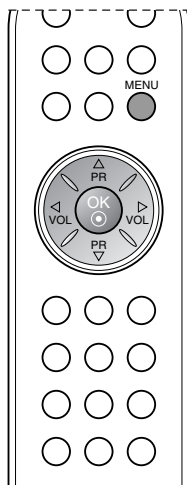
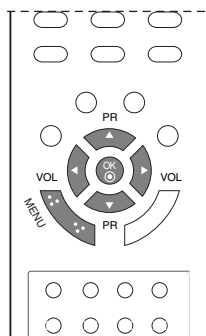

Other functions

TV, AV and PC modes

Press the **INPUT** button and then **▲** / **▼** button to select desired mode.

Inputs can be set for TV, AV or PC mode. AV mode is used when a video cassette recorder (VCR), or other equipment is connected to the set.

Note : When a VCR is connected via the aerial socket the set is used in TV mode. See the 'Connection of external equipment' section.

15LS1R*/15LC1R* : TV, AV1, AV2, RGB (RGB [DTV], RGB [PC]).

20LS1R*/20LC1R* : TV, AV1, AV2.

20LS2R*/ 23LS2R* : TV, AV1, AV2, Component, RGB (RGB [DTV], RGB [PC]), HDMI/DVI (HDMI/DVI [DTV], HDMI/DVI [PC]).

<15LS1R*/ 20LS1R*>
<15LC1R*/ 20LC1R*>

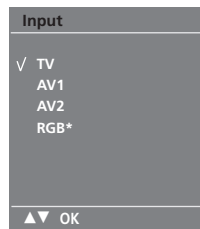

* : 15LS1R/15LC1R

<20LS2R*/ 23LS2R*>

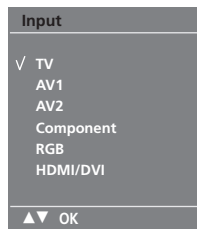

The AV and PC modes are :

- AV 1 : VCR connected to the Euro scart socket of the set.
- AV 2 : VCR connected to the **AV IN 2** or **S-Video** of the set.
- RGB-DTV : SET TOP connected to the PC INPUT and PC SOUND socket.
- RGB-PC : PERSONAL COMPUTER connected to the PC socket.
- Component : DVD connected to the COMPONENT sockets on the back of set.
- HDMI-DTV : DVD connected to the HDMI sockets on the back of set.
- HDMI-PC : PERSONAL COMPUTER connected to the HDMI sockets on the back of set.

Auto AV switching

If your VCR outputs an AV switching voltage when connected to the Euro scart socket, the set will switch to **AV1** mode automatically. But if you want to keep on watching TV mode, press the **▲** / **▼** or **NUMBER** buttons.

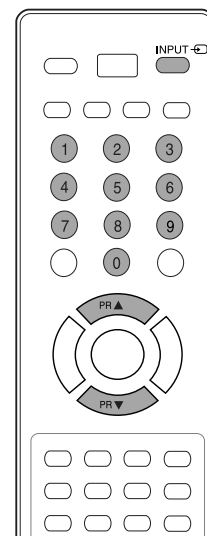
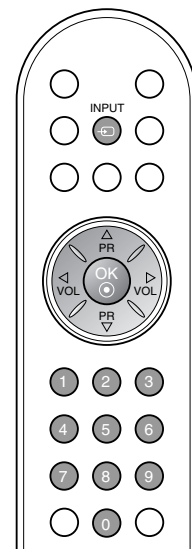
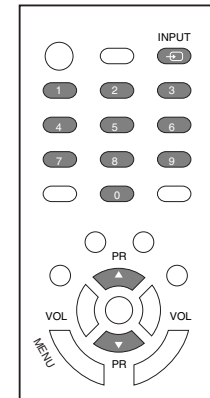

Teletext

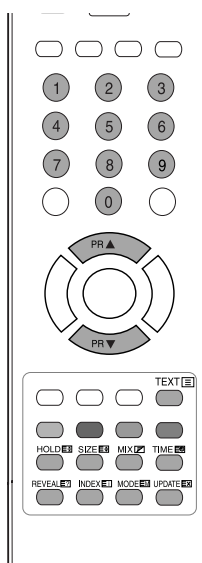
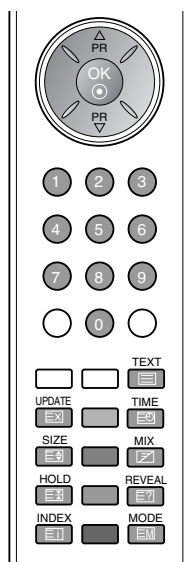
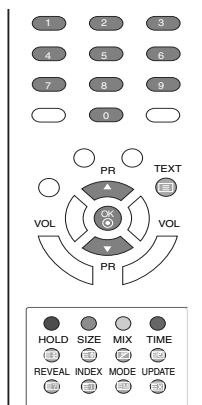

- This feature is not available in all countries.

Teletext (or TOP text) is an optional function, therefore only a set with the teletext system can receive the teletext broadcast.

Teletext is a free service broadcast by most TV stations which gives up-to-the-minute information on news, weather, television programmes, share prices and many other topics.

The teletext decoder of this TV can support the SIMPLE, TOP and FASTEXT systems. SIMPLE (standard teletext) consists of a number of pages which are selected by directly entering the corresponding page number. TOP and FASTEXT are more modern methods allowing quick and easy selection of teletext information.

Switch on/off

Press the **TEXT** button to switch to teletext. The initial page or last page appears on the screen.

Two page numbers, TV station name, date and time are displayed on the screen headline. The first page number indicates your selection, while the second shows the current page displayed. Press the **TEXT** button to switch off teletext. The previous mode reappears.

SIMPLE text

Page selection

1. Enter the desired page number as a three digit number with the **NUMBER** buttons. If during selection you press a wrong number, you must complete the three digit number and then re-enter the correct page number.
2. The **▲ / ▼** button can be used to select the preceding or following page.

Programming a colour button in LIST mode

If the TV is in SIMPLE text, TOP text or FASTEXT mode, press the **EM** button to switch to LIST mode.

Four teletext page numbers of your choice can be colour coded and easily selected by pressing the corresponding coloured button on the remote control handset.

1. Press a coloured button.
2. Using the **NUMBER** buttons, select the page you wish to programme.
3. Press the **OK** button. Then the selected page is stored as the selected page number by blinking once. From now on, you can select this page with the same coloured button.
4. The three other coloured buttons are programmed in this way.

Teletext

TOP text

The user guide displays four fields-red, green, yellow and blue at the bottom of the screen. The yellow field denotes the next group and the blue field indicates the next block.

Block / group / page selection

1. With the blue button you can progress from block to block.
2. Use the yellow button to proceed to the next group with automatic overflow to the next block.
3. With the green button you can proceed to the next existing page with automatic overflow to the next group. Alternatively the ▲ button can be used.
4. The red button permits to return to previous selection. Alternatively the ▼ button can be used.

Direct page selection

Corresponding to the SIMPLE teletext mode, you can select a page by entering it as a three digit number using the NUMBER buttons in TOP mode.

FASTEXT

The teletext pages are colour coded along the bottom of the screen and are selected by pressing the corresponding coloured button.

Page selection

1. Press the  button to select the index page.
2. You can select the pages which are colour coded along the bottom line with the same coloured buttons.
3. Corresponding to the SIMPLE teletext mode, you can select a page by entering its three digit page number with the NUMBER buttons in FASTEXT mode.
4. The ▲ / ▼ button can be used to select the preceding or following page.

Special teletext functions



REVEAL

Press this button to display concealed information, such as solutions of riddles or puzzles. Press this button again to remove the information from the display.





SIZE

Selects double height text.
Press this button to enlarge the top half of the page.
Press this button again to enlarge the bottom half of the page.
Press this button again to return to the normal display.



UPDATE

Displays the TV picture on the screen while waiting for the new teletext page. The display  will appear at the top left hand corner of the screen. When the updated page is available then display  will change to the page number. Press this button to view the updated teletext page.



HOLD

Stops the automatic page change which will occur if a teletext page consists of 2 or more sub pages. The number of sub pages and the sub page displayed is, usually, shown on the screen below the time. When this button is pressed the stop symbol is displayed at the top left-hand corner of the screen and the automatic page change is inhibited. To continue press this button again.



MIX

Displays the teletext pages superimposed on the TV picture. To switch the TV picture off press this button again.



TIME

When viewing a TV programme, press this button to display the time at the top right hand corner of the screen. Press this button again to remove the display. In the teletext mode, press this button to select a sub page number. The sub page number is displayed at the top left hand corner of the screen. To hold or change the sub page, press the NUMBER buttons. Press again to exit this function.

Connection of external equipment

You can connect additional equipment, such as VCRs, camcorders etc. to your set. Examples are shown below.

Note: Here shown may be somewhat different from your set.

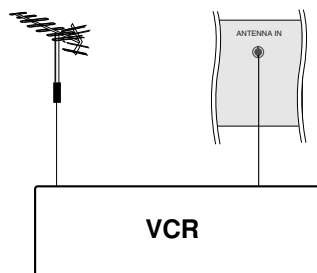

Aerial socket

1. Connect the RF out socket of the VCR to the aerial socket of the set.
2. Connect the aerial cable to the RF aerial in socket of the VCR.
3. Store the VCR channel on a desired programme number using the 'Manual programme tuning' section.
4. Select the programme number where the VCR channel is stored.
5. Press the **PLAY** button on the VCR.

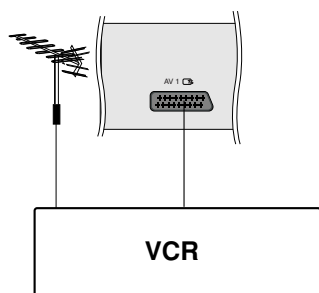

Euro scart socket (VCR)

1. Connect the Euro scart socket of the VCR to the Euro scart socket of the set.
2. Press the **PLAY** button on the VCR.
If your VCR outputs an AV switching signal via the Scart lead the set will auto switch to **AV 1** mode on start of playback, but if you want to keep on watching in TV mode, press the **▲ / ▼** or **NUMBER** buttons.

Otherwise press the **INPUT** button on the remote control handset to select **AV1**. The VCR play back picture appears on the screen.

You can also record programmes received by the TV on video tape.

Note :

- a. Signal type RGB, i.e. the signals red, green and blue can only be selected for the Euro scart and the **AV1** can be received. These signals are transmitted, for example, by a pay TV decoder, game machine or photo CD unit, etc.
- b. Please use shielded scart cable.

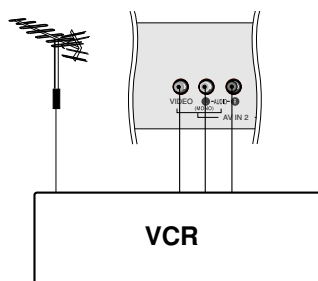

Audio/Video in sockets

1. Connect the audio/video out sockets of the VCR to audio/video in sockets of the set.
2. Press the **INPUT** button to select **AV 2**.
3. Press the **PLAY** button on the VCR.
The VCR playback picture appears on the screen.

Note : If you have a mono VCR, connect the audio cable from the VCR to the **AUDIO L/MONO** socket of the set.

Connection of external equipment

S-Video/Audio in sockets (S-Video)

When connecting an S-VIDEO VCR to the **S-VIDEO** socket, the picture quality will be further improved.

1. Connect the S-Video socket of the VCR to the **S-VIDEO** socket of the set.
2. Connect the audio cable from the S-VIDEO VCR to the **AUDIO** sockets of the set.
3. Press the **INPUT** button to select **AV 2**.
4. Press the **PLAY** button on the VCR.
The VCR playback picture appears on the screen.

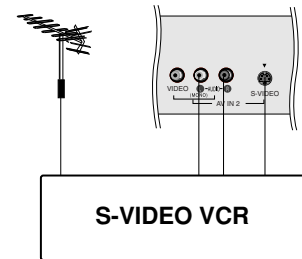

DVD input sockets

Euro scart socket

1. Connect the Euro scart socket of the DVD to the Euro scart socket of the set.
2. Press the **INPUT** button to select **AV1**.
3. Press the **PLAY** button on the DVD.
The DVD playback picture appears on the screen.

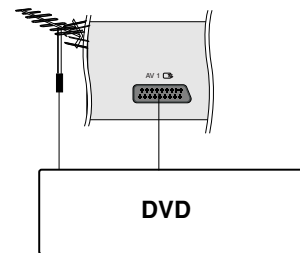

Component sockets (20LS2R*/ 23LS2R*)

1. Connect the video output sockets (Y Cb Cr, Y Pb Pr, Y B-Y R-Y or Y P_B P_R) of the DVD to the **COMPONENT** sockets (Y P_B P_R) of the set.
2. Connect the audio cable from the DVD to **COMPONENT/AUDIO** sockets of the set.
3. Press the **INPUT** button to select **Component** (480i/576i/480p/576p/720p/1080i).
4. Press the **PLAY** button on the DVD.
The DVD playback picture appears on the screen.

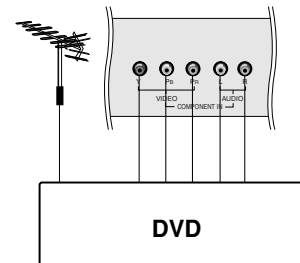

HDMI sockets (20LS2R*/ 23LS2R*)

1. Connect the HDMI output of the DVD to the **HDMI/DVI IN** jack on the set.
2. Select **HDMI/DVI** (480p/576p/720p/1080i) input source with using the **INPUT** button on the remote control.

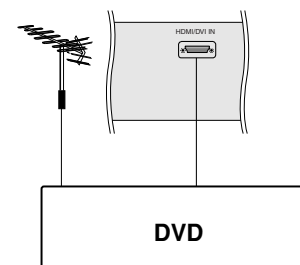

Connection of external equipment

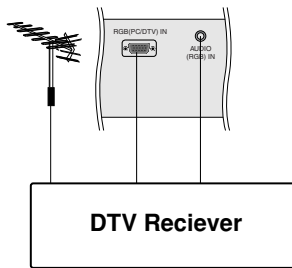

DTV in sockets

RGB in socket (15LS1R*/15LC1R*/ 20LS2R*/ 23LS2R*)

1. Connect the SET TOP with the D-Sub output socket to **RGB (PC/DTV) IN** socket on the set and audio cable of the SET TOP to the **AUDIO (RGB) IN** (15LS1R*/15LC1R*) or **AUDIO (RGB/DVI) IN** (20LS2R*/ 23LS2R*).
2. Press the **INPUT** button to select **RGB** (or **RGB [DTV]**) (576p/480p) - 15LS1R*/15LC1R*, (480p/576p/720p/1080i) - 20LS2R*/ 23LS2R*.

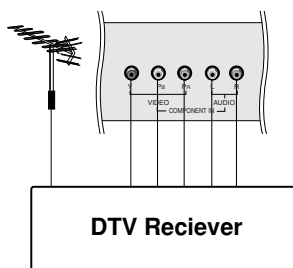

Component sockets (20LS2R*/ 23LS2R*)

1. Connect the SET TOP outputs to the **COMPONENT (DVD/DTV)** sockets (Y P_B P_R) on the set.
2. Connect the audio cable from the SET TOP to **COMPONENT/AUDIO** sockets of the set.
3. Press the **INPUT** button to select **Component** (480i/576i/480p/576p/720p/1080i).

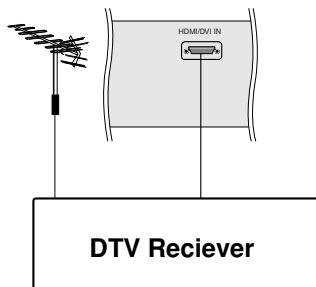

HDMI sockets (20LS2R*/ 23LS2R*)

1. Connect the HDMI output of the digital set-top box to the **HDMI/DVI IN** jack on the set.
2. Select **HDMI/DVI** (480p/576p/720p/1080i) input source with using the **INPUT** button on the remote control.

Headphone socket

Insert the headphone plug to the headphone socket of the set. You can listen to the sound through the headphone. To adjust the headphone volume, press the ◀ / ▶ button. If you press the **MUTE** button, the sound from the headphone is switched off.

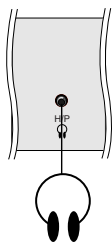

Connection of PC

PC in socket

RGB in socket (15LS1R*/15LC1R*/ 20LS2R*/ 23LS2R*)

1. Connect the signal cable from the monitor output socket of the PERSONAL COMPUTER to the PC input socket of the set.
2. Connect the audio cable from the PC to the **AUDIO (RGB) IN** (15LS1R*/15LC1R*) or **AUDIO (RGB/DVI) IN** (20LS2R*/23LS2R*) sockets of the set.
3. Press the **INPUT** button to select **RGB** (or **RGB [PC]**).
4. Switch on the PC, and the PC screen appears on the set.
The set can be operated as the PC monitor.

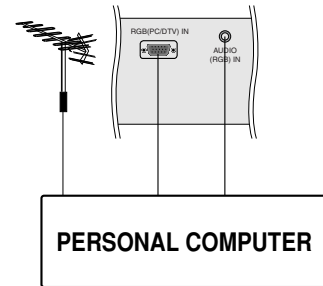

HDMI sockets (20LS2R*/ 23LS2R*)

1. Connect the DVI output of the PC to the **HDMI/DVI IN** jack on the set.
2. Connect the audio cable from the PC to the **AUDIO (RGB/DVI) IN** (20LS2R*/ 23LS2R*) sockets of the set.
3. Select **HDMI/DVI [PC]** input source with using the **INPUT** button on the remote control.

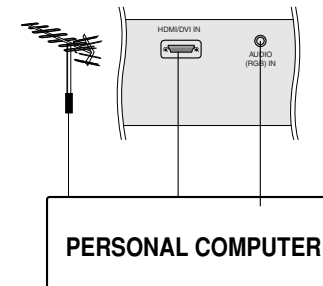

Displayable Monitor Specification

<15LS1R*/15LC1R*>

MODE	Resolution	Horizontal Frequency(kHz)	Vertical Frequency(Hz)
VGA	640x480	31.4	60
SVGA	800x600	35.1	56
	800x600	37.8	60
XGA	1024x768	48.3	60

<20LS2R*, 23LS2R*>

MODE	Resolution	Horizontal Frequency(kHz)	Vertical Frequency(Hz)
VGA	640x480	31.4	60
SVGA	800x600	37.8	60
	800x600	37.8	60
XGA	1024x768	48.3	60
	1280x768	47.7	60
WXGA	1360x768	47.7	60

(Synchronization input form : separate)

Note :

- a. If the set is cold, there may be a small "flicker" when the set is switched on. This is normal, there is nothing wrong with the set.
- b. If possible, use the VESA 1024x768@60Hz (15LS1R*/15LC1R*), 1360x768@60Hz (20LS2R*/23LS2R*) video mode to obtain the best image quality for your LCD monitor. If used under the other resolutions, some scaled or processed pictures may appear on the screen. The set has been pre-adjusted to the mode VESA 1024x768@60Hz (15LS1R*/15LC1R*), 1360x768@60Hz (20LS2R*/23LS2R*).
- c. Some dot defects may appear on the screen, like Red, Green or Blue spots. However, this will have no impact or effect on the monitor performance.
- d. Do not press the LCD screen with your finger for a long time as this may produce some temporary distortion effects on the screen.
- e. When the PC screen appears on the set, a message may appear on the screen, and the message will differ according to the Window system version. If a message appears click "Next" until the message finishes.
- f. If the message "**No signal**" appears on the screen, adjust the PC as in the 'Displayable Monitor Specification' section.

Connection of PC

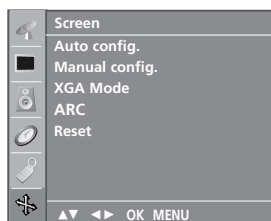

PC Setup

You can adjust auto configure, manual configure and reset as you prefer.

1. Press the **INPUT** button and then **▲ / ▼** button to select the **RGB [PC]**.
2. Press the **MENU** button and then **▲ / ▼** button to select the **Screen** menu.
3. Press the **▶** button and then **▲ / ▼** button to select the desired screen function.

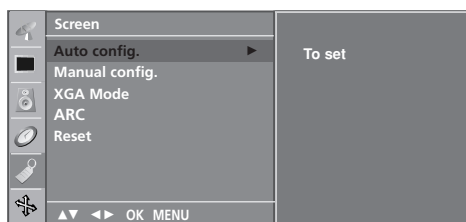

4. Make appropriate adjustments.

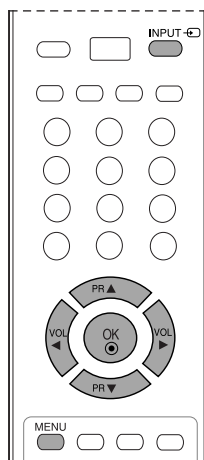
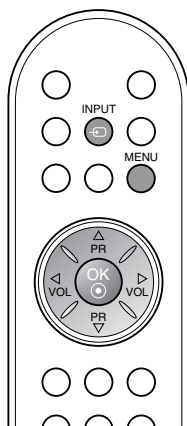
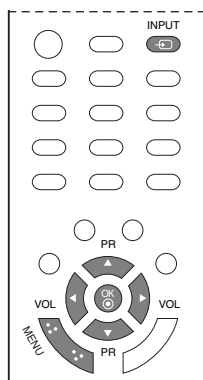

Auto configure

This function is for the automatic adjustment of the screen position, clock and phase. The displayed image will disappear for a few seconds while the Auto-configuration is in progress.

Manual configure

This function is for the manual adjustment of the screen position, clock and phase. Press the **◀ / ▶** button to make appropriate adjustments.

• H-Position / V-Position

This function is to adjust picture to left/right and up/down as you prefer.

• Clock

This function is to minimize any vertical bars or stripes visible on the screen background. And the horizontal screen size will also change.

• Phase

This function allows you to remove any horizontal noise and clear or sharpen the image of characters.

Reset

This function allows you to return to the good picture reproduction programmed at the factory and cannot be changed.

Note : Some signal from some graphics boards may not function properly. If the results are unsatisfactory, adjust your monitor's position, clock and phase manually.

5. Press the **OK** button to store it for the PC monitor picture.

Connection of PC

Selecting wide XGA mode

To see a normal picture, match the resolution of RGB mode and selection of XGA mode.

1. Press the **MENU** button and then ▲ / ▼ button to select the **Screen** menu.
2. Press the ► button and then ▲ / ▼ button to select **XGA mode**.
3. Press the ► button and then ▲ / ▼ button to select the desired XGA resolution.

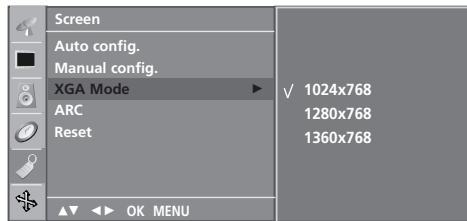

4. Repeatedly press the **MENU** button to return to normal TV viewing.

Note: This feature is not available for all models.

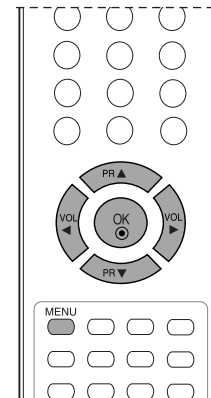
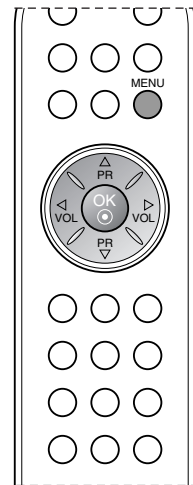
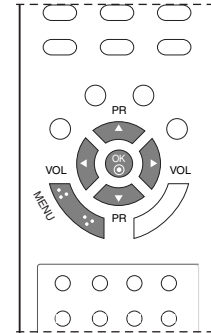

Picture format

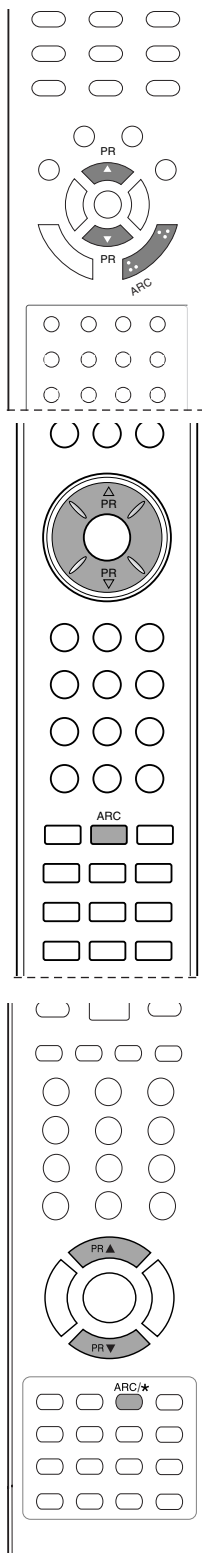

You can watch TV in various picture formats; **Spectacle, Original, 4:3, 16:9, 14:9, Zoom1, Zoom2.**

Repeatedly press the **ARC** button to select your desired picture format.

Spectacle

When your TV receives the wide screen signal, it will lead you to adjust the picture horizontally, in a nonlinear proportion, to fill the entire screen.

Original

When your TV receives the wide screen signal, it will be automatically changed to the picture format to be sent. (Not available in all countries)

4:3

This picture format is 4 to 3 of general TV.

16:9

You can enjoy the cinema (the picture format of 16:9) or general TV programme through the 16:9 mode.

The screen 16:9 is viewed just like that but the screen 4:3 is magnified to the left and right so that the screen 16:9 is full.

14:9

You can enjoy the picture format of 14:9 or general TV programme through the 14:9 mode.

The screen 14:9 is viewed just like that the screen 4:3 is magnified to the upper / lower and left / right.

Zoom1

Following selection will lead you to view the picture without any alternation, while filling the entire screen. However, the top and bottom portions of the picture will be cropped.

Zoom2

Choose **Zoom2** when you want the picture to be altered, both horizontally extended and vertically cropped. The picture taking a halfway trade off between alteration and screen coverage.

Note :

- ARC menu is not available in RGB, HDMI, Component mode except 4:3, 16:9. You can adjust the enlarge proportion using ▲ / ▼ button.*
- This feature is not available for all models.*

Troubleshooting Checklist

The operation does not work normally.

The remote control doesn't work	<ul style="list-style-type: none"> • Check to see if there is any object between the product and the remote control causing obstruction. • Are batteries installed with correct polarity (+ to +, - to -)? • Correct remote operating mode set: TV, VCR etc.? • Install new batteries.
Power is suddenly turned off	<ul style="list-style-type: none"> • Is the sleep timer set? • Check the power control settings. Power interrupted • No broadcast on station tuned with Auto off activated.

The video function does not work.

No picture & No sound	<ul style="list-style-type: none"> • Check whether the product is turned on. • Try another channel. The problem may be with the broadcast. • Is the power cord inserted into wall power outlet? • Check your antenna direction and/or location. • Test the wall power outlet, plug another product's power cord into the outlet where the product's power cord was plugged in.
Picture appears slowly after switching on	<ul style="list-style-type: none"> • This is normal, the image is muted during the product startup process. Please contact your service center, if the picture has not appeared after five minutes.
No or poor color or poor picture	<ul style="list-style-type: none"> • Adjust Color in menu option. • Keep a sufficient distance between the product and the VCR. • Try another channel. The problem may be with the broadcast. • Are the video cables installed properly? • Activate any function to restore the brightness of the picture.
Horizontal/vertical bars or picture shaking	<ul style="list-style-type: none"> • Check for local interference such as an electrical appliance or power tool.
Poor reception on some channels	<ul style="list-style-type: none"> • Station or cable product experiencing problems, tune to another station. • Station signal is weak, reorient antenna to receive weaker station. • Check for sources of possible interference.
Lines or streaks in pictures	<ul style="list-style-type: none"> • Check antenna (Change the direction of the antenna).

Troubleshooting Checklist

The audio function does not work.	
Picture OK & No sound	<ul style="list-style-type: none"> • Press the VOL (or Volume) button. • Sound muted? Press MUTE button. • Try another channel. The problem may be with the broadcast. • Are the audio cables installed properly?
No output from one of the speakers	<ul style="list-style-type: none"> • Adjust Balance in menu option.
Unusual sound from inside the product	<ul style="list-style-type: none"> • A change in ambient humidity or temperature may result in an unusual noise when the product is turned on or off and does not indicate a fault with the product.

There is a problem in PC mode. (Only PC mode applied)	
The signal is out of range.	<ul style="list-style-type: none"> • Adjust resolution, horizontal frequency, or vertical frequency. • Check the input source.
Vertical bar or stripe on back- ground & Horizontal Noise & Incorrect position	<ul style="list-style-type: none"> • Work the Auto configure or adjust clock, phase, or H/V position.
Screen color is unstable or single color	<ul style="list-style-type: none"> • Check the signal cable. • Reinstall the PC video card.

Product Specifications

Power Requirement/ Power Consumption	15LS1R* : AC100-240V~ 50/60Hz 0.7A / 40W 20LS1R* : AC100-240V~ 50/60Hz 1.0A / 60W 20LS2R* : AC100-240V~ 50/60Hz 1.0A / 60W 23LS2R* : AC100-240V~ 50/60Hz 0.9A / 85W
Dimensions (Width x Depth x Height)	15LS1R* : 463.3mm x 166.3mm x 353.5mm 18.2inches x 6.5inches x 13.9inches 20LS1R* : 573.2mm x 189.7mm x 435.5mm 22.6inches x 7.5inches x 17.1inches 20LS2R* : 518.9mm x 177.7mm x 415.5mm 20.4inches x 7.0inches x 16.4inches 23LS2R* : 589.2mm x 189.7mm x 464.9mm 24.0inches x 7.5inches x 18.3inches
Weight (Net)	15LS1R* : 3.9kg (8.7lbs) 20LS1R* : 6.9kg (15.3lbs) 20LS2R* : 6.2kg (13.6lbs) 23LS2R* : 7.9kg (17.4lbs)
Television System	PAL/SECAM B/G/D/K, PAL I/II, SECAM L/L'
Programme Coverage	VHF: E2 ~ E12, UHF: E21 ~ E69, CATV: S1 ~ S20, HYPER: S21 ~ S47
External Antenna Impedance	75 Ω

* The specifications shown above may be changed without prior notice for quality improvement.

Power Requirement/ Power Consumption	15LC1R* : AC100-240V~ 50/60Hz 0.7A / 40W 20LC1R* : AC100-240V~ 50/60Hz 1.0A / 60W
Dimensions (Width x Depth x Height)	15LC1R* : 377.6mm x 242.8mm x 394.5mm 14.9inches x 9.6inches x 15.5inches 20LC1R* : 492.4mm x 272.8mm x 483.3mm 19.4inches x 10.7inches x 19.0inches
Weight (Net)	15LC1R* : 5.6kg (12.3lbs) 20LC1R* : 9.1kg (20.1lbs)
Television System	PAL/SECAM B/G/D/K, PAL I/II, SECAM L/L'
Programme Coverage	VHF: E2 ~ E12, UHF: E21 ~ E69, CATV: S1 ~ S20, HYPER: S21 ~ S47
External Antenna Impedance	75 Ω

* The specifications shown above may be changed without prior notice for quality improvement.



Free Manuals Download Website

<http://myh66.com>

<http://usermanuals.us>

<http://www.somanuals.com>

<http://www.4manuals.cc>

<http://www.manual-lib.com>

<http://www.404manual.com>

<http://www.luxmanual.com>

<http://aubethermostatmanual.com>

Golf course search by state

<http://golfingnear.com>

Email search by domain

<http://emailbydomain.com>

Auto manuals search

<http://auto.somanuals.com>

TV manuals search

<http://tv.somanuals.com>