



# LCD TV OWNER'S MANUAL

## LCD TV MODELS

19LS4D*	32LG30**
22LS4D*	32LG32**
32LG20**	37LG30**
37LG20**	42LG30**
42LG20**	42LG32**
19LG30**	32LG5***
22LG30**	37LG50**
26LG30**	42LG50**
	47LG50**
	52LG50**

Please read this manual carefully before operating your TV.

Retain it for future reference.

Record model number and serial number of the TV. Refer to the label on the back cover and quote this information.

To your dealer when requiring service.

Extended Owner's Manual that contains advanced features of these LG TV-sets is located on CD-ROM in electronic version.

To read it You need to open chosen files by using Personal Computer (PC) equipped with CD-ROM drive.

**DVB**  
Digital Video  
Broadcasting

Trade Mark of the DVB Digital Video  
Broadcasting Project (1991 to 1996)

<b>ID Number(s):</b> 5499: 22LS4D-ZD	5507: 19LS4D-ZD
5629: 32LG2000-ZA	5721: 26LG3050-ZA
5630: 37LG2000-ZA	5631: 42LG2000-ZA
5088: 19LG3000-ZA	5090: 22LG3000-ZA
5080: 26LG3000-ZA	5089: 32LG3000-ZA
5087: 37LG3000-ZA	5086: 42LG3000-ZA
5085: 32LG5000-ZA	5084: 37LG5000-ZA
5083: 42LG5000-ZA	5082: 47LG5000-ZA
5081: 52LG5000-ZA	5385: 52LG5010-ZD
5386: 47LG5010-ZD	5387: 42LG5010-ZD
5388: 37LG5010-ZD	5389: 32LG5010-ZD
5390: 52LG5020-ZB	5391: 47LG5020-ZB
5392: 42LG5020-ZB	5393: 37LG5020-ZB
5394: 32LG5020-ZB	5395: 52LG5030-ZE
5396: 47LG5030-ZE	5397: 42LG5030-ZE
5398: 37LG5030-ZE	5399: 32LG5030-ZE
5671: 32LG5700-ZF	5820: 19LG3050-ZA
5818: 22LG3050-ZA	5879: 19LG3060-ZB
5880: 22LG3060-ZB	5878: 32LG5600-ZB
6507: 32LG3200-ZA	6511: 42LG3200-ZA

P/NO: MFL34441652 (0901-REV01)  
Printed in Korea

# CONNECTING YOUR UNIT

▪ Image shown may differ from your TV.

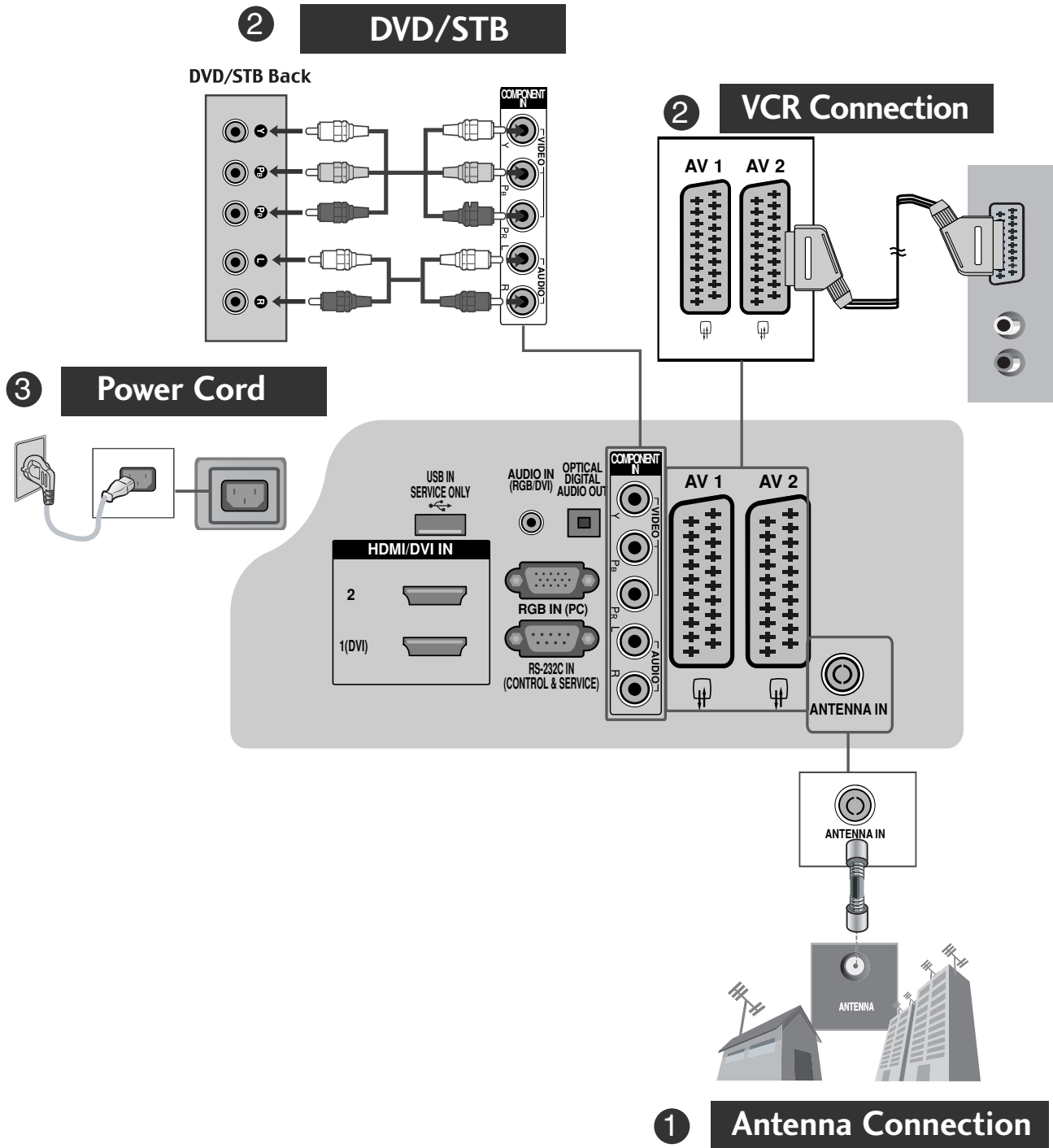

\* To connect an additional equipment, see the External equipment Setup section in CD Manual.

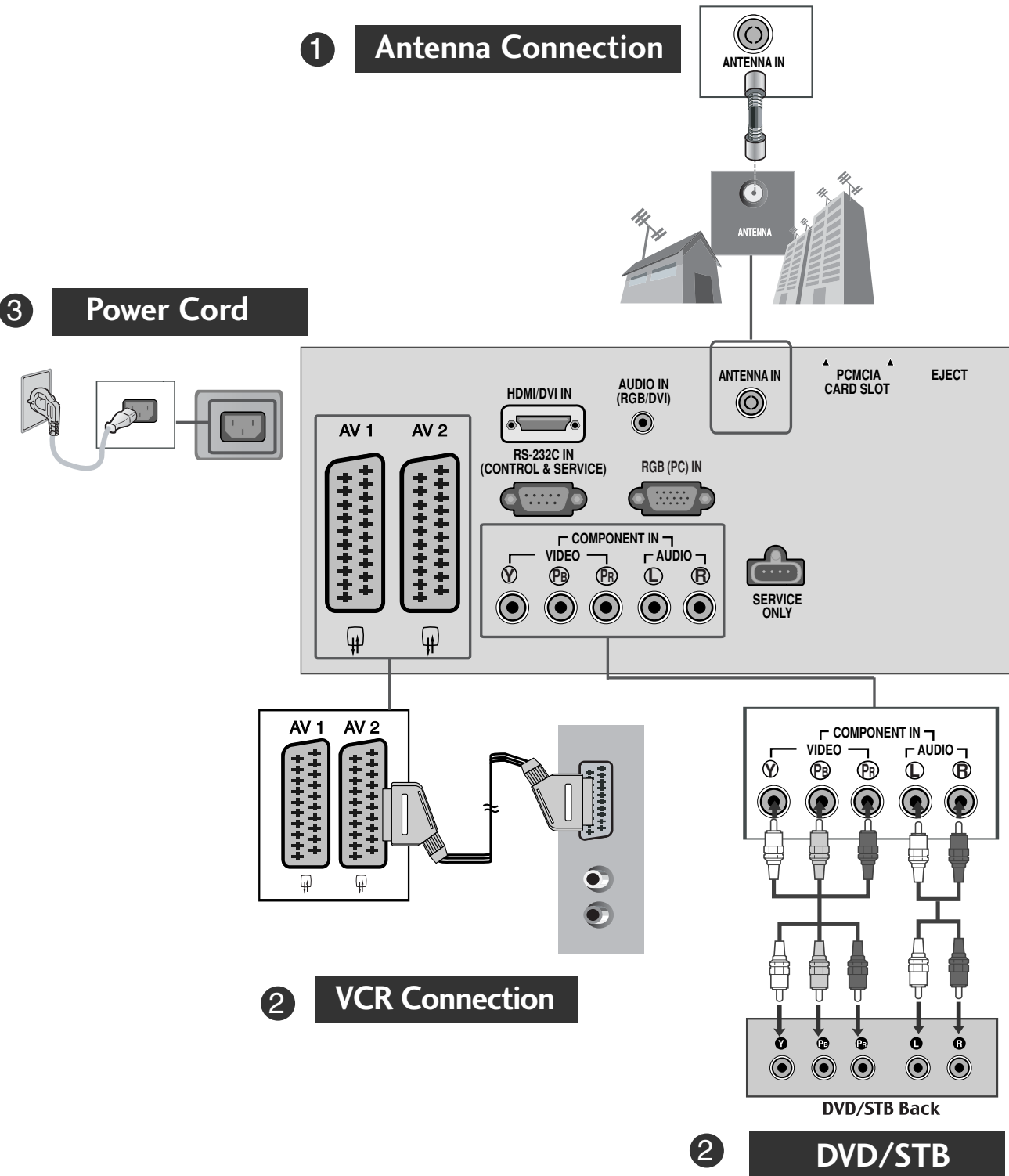

Image shown may differ from your TV.



\* To connect an additional equipment, see the **External equipment Setup** section in CD Manual.

# SAFETY INSTRUCTIONS

- Please read these safety precautions carefully before using the product.
- In this manual, the illustration may be somewhat different from your product because it is just example to help the instruction.

-  **WARNING** If you ignore the warning message, you may be seriously injured or there is a possibility of accident or death.
-  **CAUTION** If you ignore the caution message, you may be slightly injured or the product may be damaged.

## Precaution in Installing the Product

### **WARNING**



Keep away from heat sources like electrical heaters.  
- Electrical shock, fire, malfunction or deformation may occur.



Do not use the product in damp place such as a bathroom or any place where it is likely to get wet.  
- This may cause a fire or could give an electric shock.



If you can smell smoke or other odors or hear a strange sound unplug the power cord and contact the service center.  
- If you continue to use without taking proper measures, electrical shock or fire can occur.

### **CAUTION**



Install the product on a flat and stable place that has no risk of dropping the product.  
- If the product is dropped, you may be injured or the product may be broken.



Keep the product away from direct sunlight.  
- The product can be damaged.



Do not place the product in a built-in installation such as bookcase or rack.  
- Ventilation required.

## Electrical Power Related Precautions

### **WARNING**



Make sure to connect the power cable to the ground-ed current.  
- You may be electrocuted or injured.



Do not touch the power plug with wet hands. Additionally, if the cord pin is wet or covered with dust, dry the power plug completely or wipe dust off.  
- You may be electrocuted due to excess moisture.



During a thunder or lightning storm, unplug the power cable or signal cable.  
- You may be electrocuted or a fire can break out.

### **CAUTION**

Protect the power cord from physical or mechanical abuse, such as being twisted, kinked, pinched, closed in a door, or walked upon. Pay particular attention to plugs, wall outlets, and the point where the cord exits the appliance.



## Precautions in Moving the Product

### **WARNING**

Make sure to turn off the product.  
Make sure to remove all cables before moving the product.  
- You may be electrocuted or the product can be damaged.



### **CAUTION**

Do not shock the product when moving it.  
- You may be electrocuted or the product can be damaged.  
Make the panel face forward and hold it with both hands to move.  
- If you drop the product, the damaged product can cause electric shock or fire. Contact with the service center for repair.



## Precautions in Using the Product

### **WARNING**

Do not disassemble, repair or modify the product at your own discretion.  
- Fire or electric shock accident can occur.  
- Contact the service center for check, calibration or repair.



To reduce the risk of fire or electric shock, do not expose this apparatus to rain or moisture. Apparatus shall not be exposed to dripping or splashing and no objects filled with liquids, such as vases, shall be placed on the apparatus.



### **CAUTION**

Refer all servicing to qualified service personnel. Servicing is required when the apparatus has been damaged in any way, such as power supply cord or plug is damaged, liquid has been spilled or objects have fallen into the apparatus, the apparatus has been exposed to rain or moisture, does not operate normally, or has been dropped.



Do not keep a still image on the screen for an extended period (e.g. by pausing a video) as the fixed image may remain visible on the screen. This is known as image burn. Image burn is not covered under the manufacturer's warranty.



# PREPARATION

## FRONT PANEL CONTROLS

- Image shown may differ from your TV.
- If your TV has a protection film attached, remove the film and then wipe the TV with a polishing cloth.

### LCD TV Models :

**32/37/42LG20\*\*, 26/32/37/42LG30\*\*, 32/42LG32\*\*, 32/37/42/47/52LG5\*\*\***

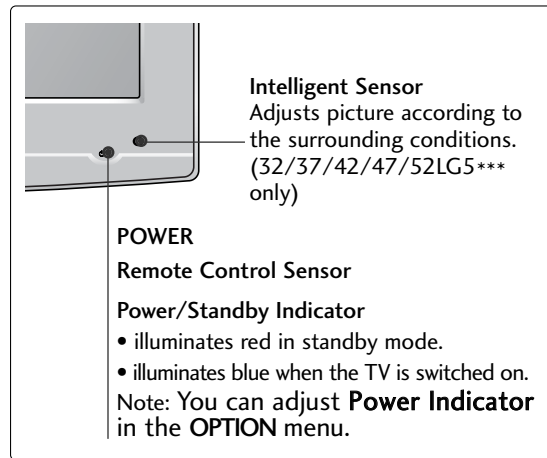
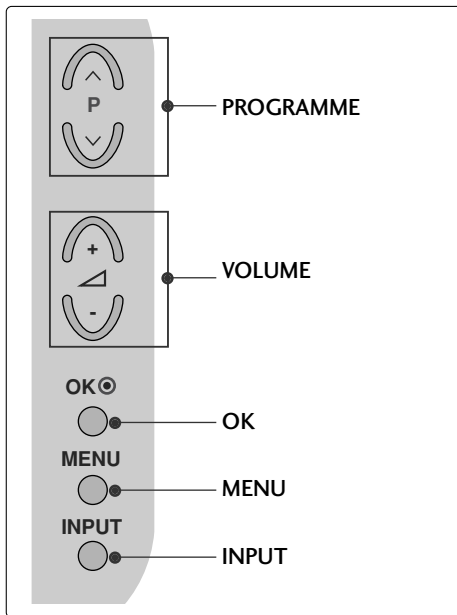

### LCD TV Models : 19/22LG30\*\*

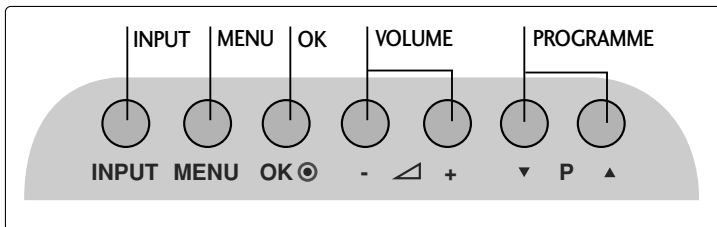

### LCD TV Models : 19/22LS4D\*

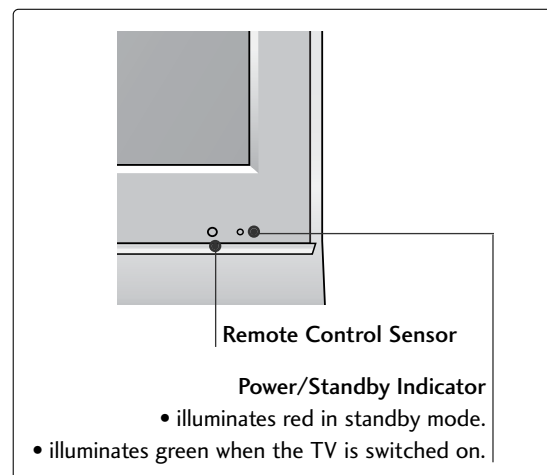
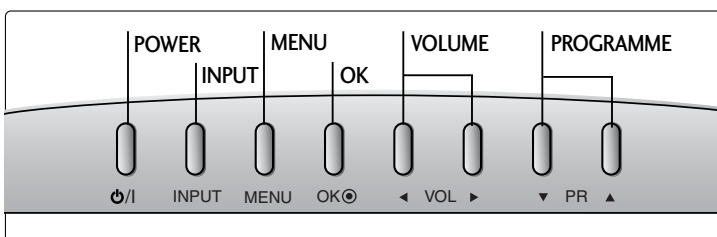

# PREPARATION

ENGLISH

## BACK PANEL INFORMATION

■ Image shown may differ from your TV.

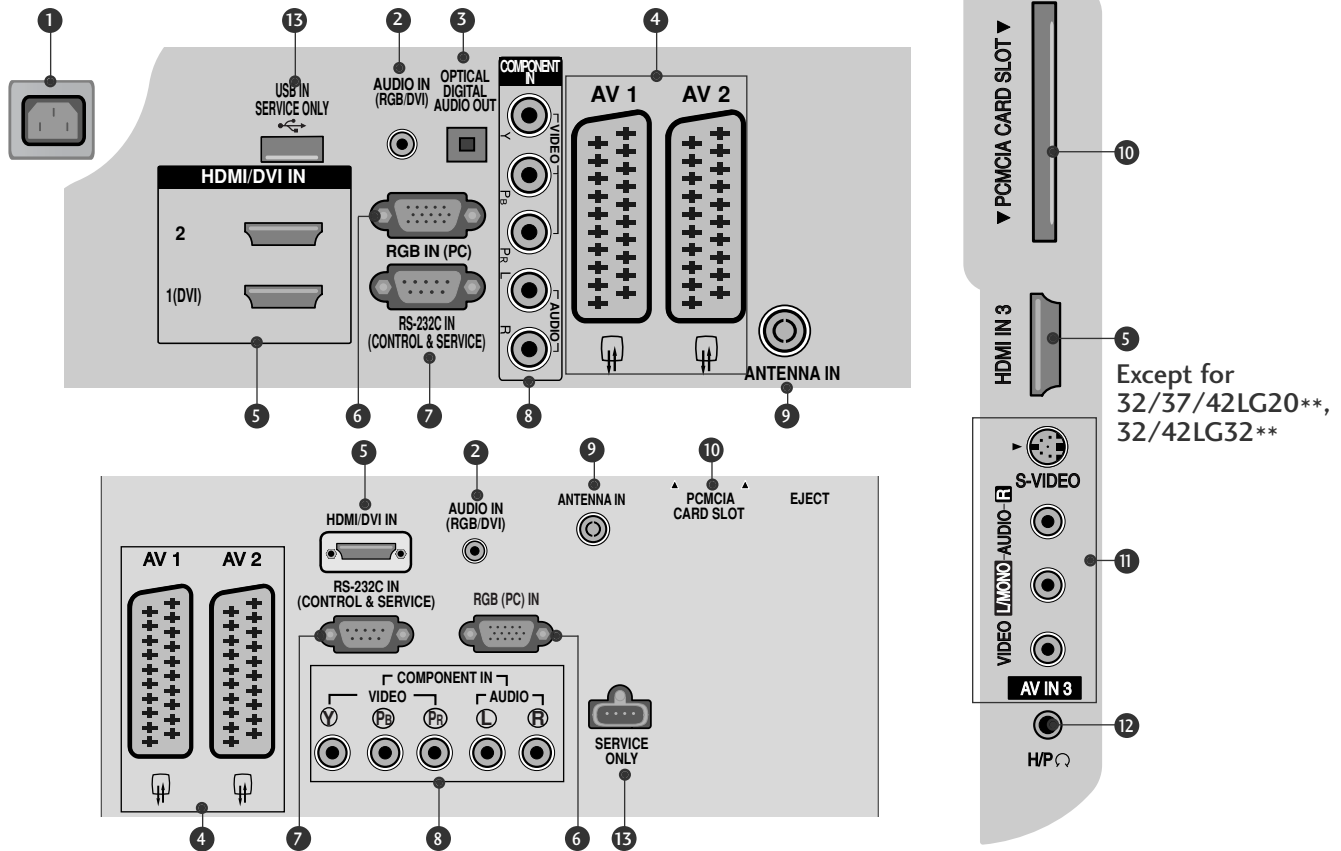

- 1 Power Cord Socket**  
This TV operates on an AC power. The voltage is indicated on the Specifications page. Never attempt to operate the TV on DC power.
- 2 RGB/DVI Audio Input**  
Connect the audio from a PC or DTV.
- 3 DIGITAL AUDIO OUT OPTICAL (Except for 19/22LS4D\*)**  
Connect digital audio from various types of equipment. Note: In standby mode, these ports do not work.
- 4 Euro Scart Socket (AV1/AV2)**  
Connect scart socket input or output from an external device to these jacks.
- 5 HDMI Input**  
Connect a HDMI signal to HDMI IN. Or DVI (VIDEO) signal to HDMI/DVI port with DVI to HDMI cable.
- 6 RGB IN (PC)**  
Connect the output from a PC.
- 7 RS-232C IN (CONTROL & SERVICE) PORT**  
Connect to the RS-232C port on a PC.
- 8 Component Input**  
Connect a component video/audio device to these jacks.
- 9 Antenna Input**  
Connect RF antenna to this jack.
- 10 PCMCIA (Personal Computer Memory Card International Association) Card Slot**  
(This feature is not available in all countries.)
- 11 Audio/Video Input (Except for 19/22LS4D\*)**  
Connect audio/video output from an external device to these jacks.  
S-VIDEO (Except for 19/22LS4D\*, 32/37/42LG20\*\*, 32/42LG32\*\*)  
Connect S-Video out from an S-VIDEO device.
- 12 Headphone Socket (Except for 19/22LS4D\*, 32/37/42LG20\*\*, 32/42LG32\*\*)**  
Connect the headphone plug to this socket.
- 13 SERVICE ONLY PORT**

# STAND INSTALLATION

(LCD TV Models: 32/37/42LG20\*\*, 26/32/37/42LG30\*\*, 32/42LG32\*\*, 32/37/42LG5\*\*\*)

- When assembling the desk type stand, check whether the bolt is fully tightened. (If not tightened fully, the product can tilt forward after the product installation.) If you tighten the bolt with excessive force, the bolt can deviate from abrasion of the tightening part of the bolt.

- 1 Carefully place the TV screen side down on a cushioned surface to protect the screen from damage.

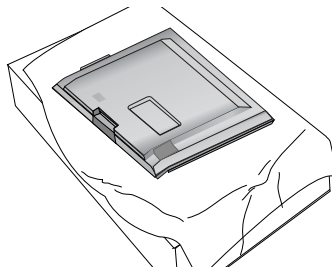

- 3 Assemble the TV as shown.

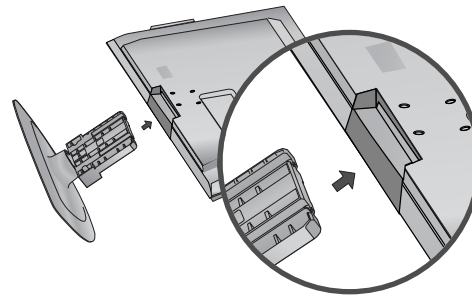

- 2 Assemble the parts of the **Stand Body** with the **Cover Base** of the TV.

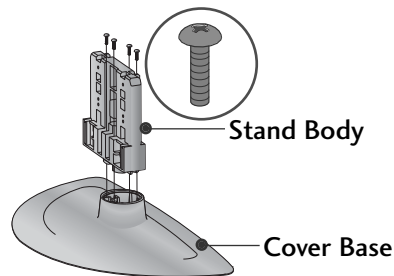

- 4 Fix the 4 bolts securely using the holes in the back of the TV.

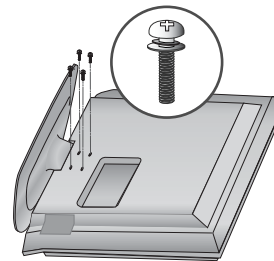

(Only 19/22LG30\*\*)

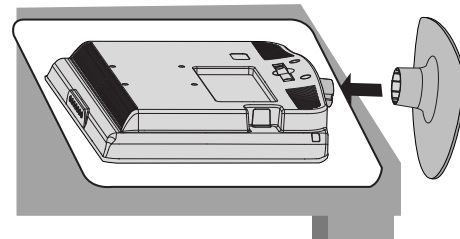
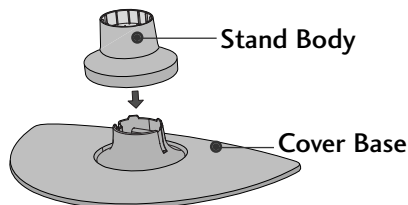
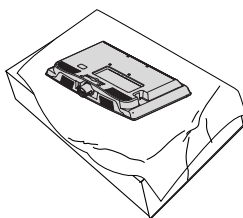

- 1 Carefully place the TV screen side down on a cushioned surface to protect the screen from damage.

- 2 Assemble the parts of the **STAND BODY** with **COVER BASE** of the TV. Insert the **STAND BODY** into a **COVER BASE** until clicking sound.

- 3 Assemble the TV as shown.

# PREPARATION

ENGLISH

## STAND INSTALLATION (Only 19/22LS4D\*)

■ Image shown may differ from your TV.

- 1 Carefully place the TV screen side down on a cushioned surface to protect the screen from damage.

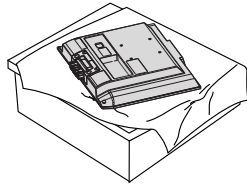

- 2 Hold the **Hinge Body** and bend it upward.

**Hinge Body**

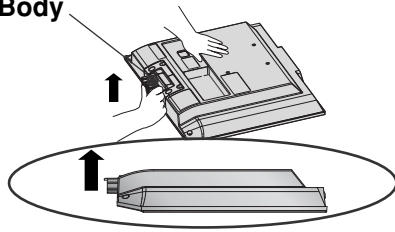

- 3 Insert the **Stand Body** into the TV until clicking sound.

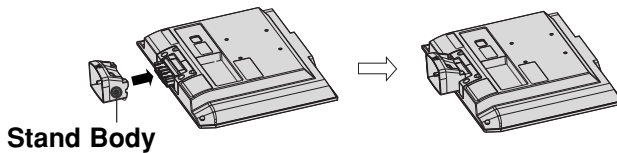

- 4 Assemble the parts of the **Stand Body** with the **Cover Base** of the TV.

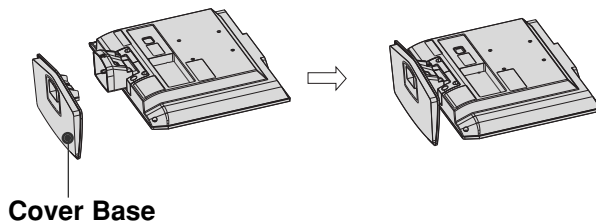

## DETACHING STAND (Only 19/22LS4D\*)

- 1 Place the tv with its front facing downward on a cushion or soft cloth.

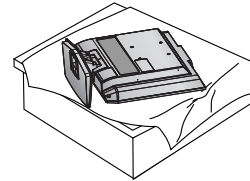

- 2 Pull the **Cover Base** backward during pressing a button on the **Stand Body**.

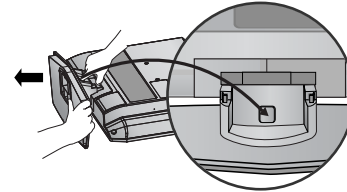

- 3 Hold the **Cover Base** and pull with shake it backward to separate from the **Stand Body**.

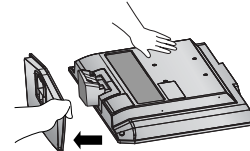

- 4 Hold the **Stand Body** and bend it upward.

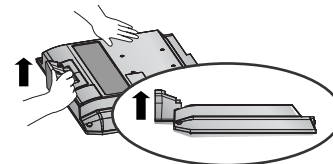

- 5 Pull stand body to separate from the TV during pressing 2 latches.

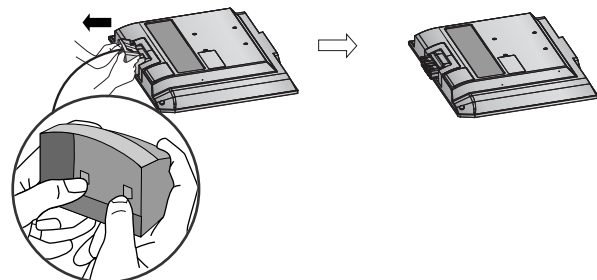



## BACK COVER FOR WIRE ARRANGEMENT

### LCD TV Models:

32/37/42LG20\*\*, 26/32/37/ 42LG30\*\*,  
32/42LG32\*\*, 32/37/42/47/52LG5\*\*\*

- 1** Connect the cables as necessary.

To connect additional equipment, see the **External Equipment Setup** section of the manual.

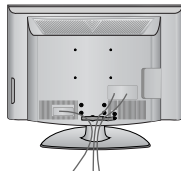

- 2** Open the **CABLE MANAGEMENT CLIP** as shown and manage the cables.

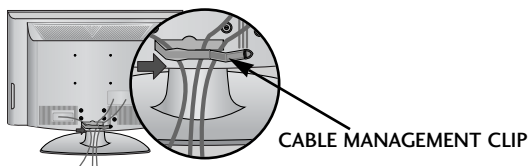

- 3** Fit the **CABLE MANAGEMENT CLIP** as shown.

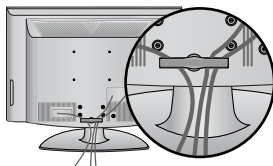

### LCD TV Models :

19/22LS4D\*, 19/22LG30\*\*

- 1** Connect the cables as necessary.

To connect additional equipment, see the External Equipment Setup section.

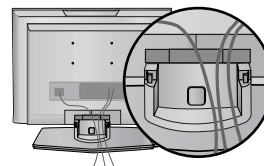

- 2** Install the **CABLE MANAGEMENT CLIP** as shown.

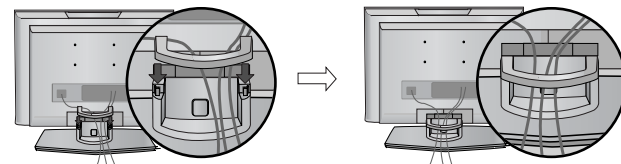

(Only 19/22LS4D\*)

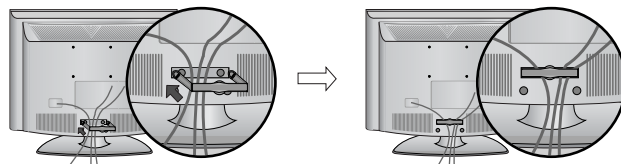

(Only 19/22LG30\*\*)

### How to remove the cable management clip

First, press the cable management. Hold the **CABLE MANAGEMENT CLIP** with both hands and pull it upward.

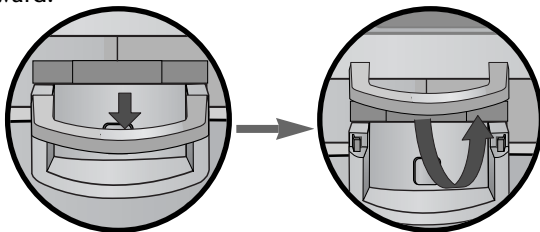

(Only 19/22LS4D\*)

Hold the **CABLE MANAGEMENT CLIP** with both hands and pull it backward.

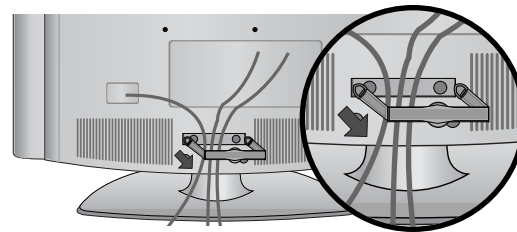

(Only 19/22LG30\*\*)

### ! NOTE

- ▶ Do not use the **CABLE MANAGEMENT CLIP** to lift the TV.
- If the TV is dropped, you may be injured or the TV may be damaged.

# PREPARATION

ENGLISH

## PLEASE SET IT UP CAREFULLY SO THE PRODUCT DOES NOT FALL OVER.

- You should purchase necessary components to fix the TV to the wall on the market.
- Position the TV close to the wall to avoid the possibility of it falling when pushed.
- The instructions shown below are a safer way to set up the TV, which is to fix it to the wall, avoiding the possibility of it falling forwards if pulled. This will prevent the TV from falling forward and causing injury. This will also prevent the TV from damage. Ensure that children do not climb or hang from the TV.

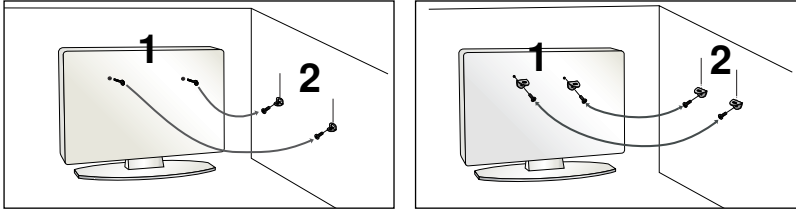

- 1 Use the eye-bolts or TV brackets/bolts to fix the TV to the wall as shown in the picture.  
(If your TV has bolts in the eyebolts, loosen these bolts.)  
\* Insert the eye-bolts or TV brackets/bolts and tighten them securely in the upper holes.
- 2 Secure the wall brackets with the bolts on the wall. Match the height of the bracket that is mounted on the wall.

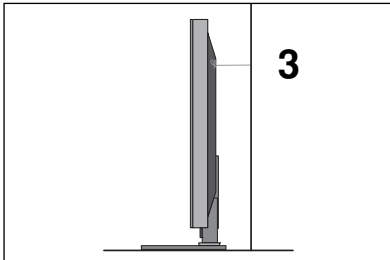

- 3 Use a sturdy rope to tie the TV. It is safer to tie the rope so it becomes horizontal between the wall and the TV.

### ! NOTE

- ▶ When moving the TV undo the cords first.
- ▶ Use a platform or cabinet strong and large enough to support the size and weight of the TV.
- ▶ To use the TV safely make sure that the height of the bracket on the wall and on the TV is the same.

- The TV can be installed in various ways such as on a wall, or on a desktop etc.
- The TV is designed to be mounted horizontally.

## EARTHING

Ensure that you connect the earth wire to prevent possible electric shock. If grounding methods are not possible, have a qualified electrician install a separate circuit breaker.

Do not try to earth the TV by connecting it to telephone wires, lightening rods or gas pipes.

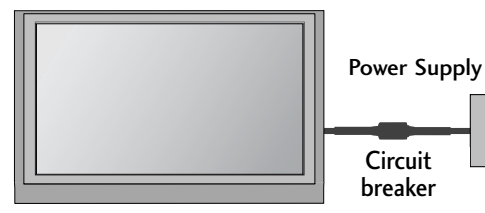

## DESKTOP PEDESTAL INSTALLATION

For adequate ventilation allow a clearance of 4" (10cm) all around the TV.

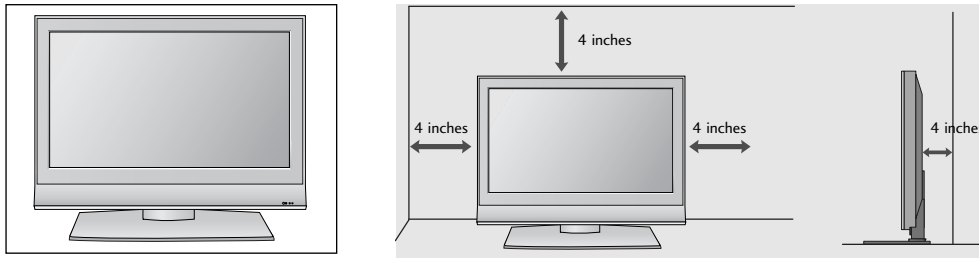

### Attaching the TV to a desk (Only 32/37/42LG20\*\*, 26/32/37/42LG30\*\*, 32/42LG32\*\*, 32/37/42LG5\*\*\*)

The TV must be attached to desk so it cannot be pulled in a forward/backward direction, potentially causing injury or damaging the product. Use only an attached screw.

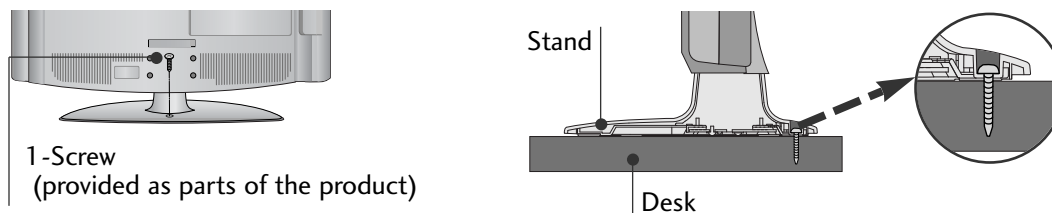

#### ! WARNING

- ▶ To prevent TV from falling over, the TV should be securely attached to the floor/wall per installation instructions. Tipping, shaking, or rocking the machine may cause injury.

## WALL MOUNT: HORIZONTAL INSTALLATION

For adequate ventilation allow a clearance of 4" (10cm) all around the TV. We recommend that you use a wall mounting bracket of LG brand when mounting the TV to a wall.

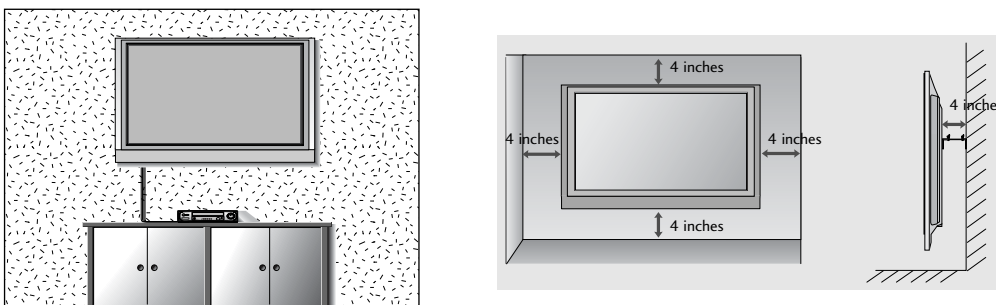

### Not using the desk-type stand (Except for 19/22LS4D\*)

- Image shown may differ from your TV.

When installing the wall-mounted unit, use the protection cover for desk-type stand installation. Insert the **PROTECTION COVER** into the TV until clicking sound.

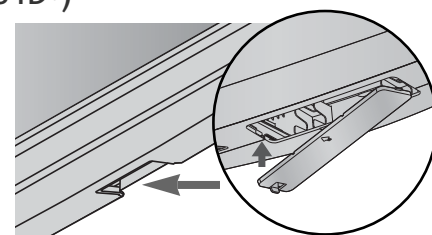

# PREPARATION

- To prevent damage do not connect to the mains outlet until all connections are made between the devices.

ENGLISH

## ANTENNA CONNECTION

- For optimum picture quality, adjust antenna direction.
- An antenna cable and converter are not supplied.

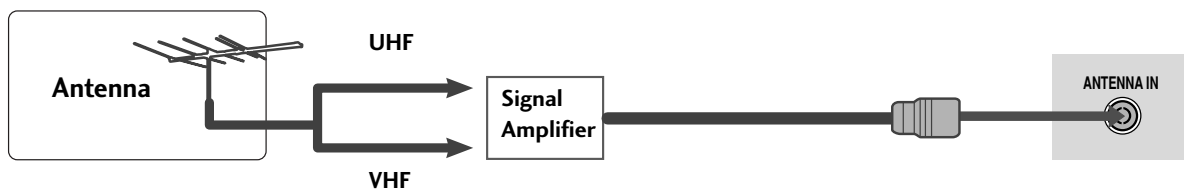
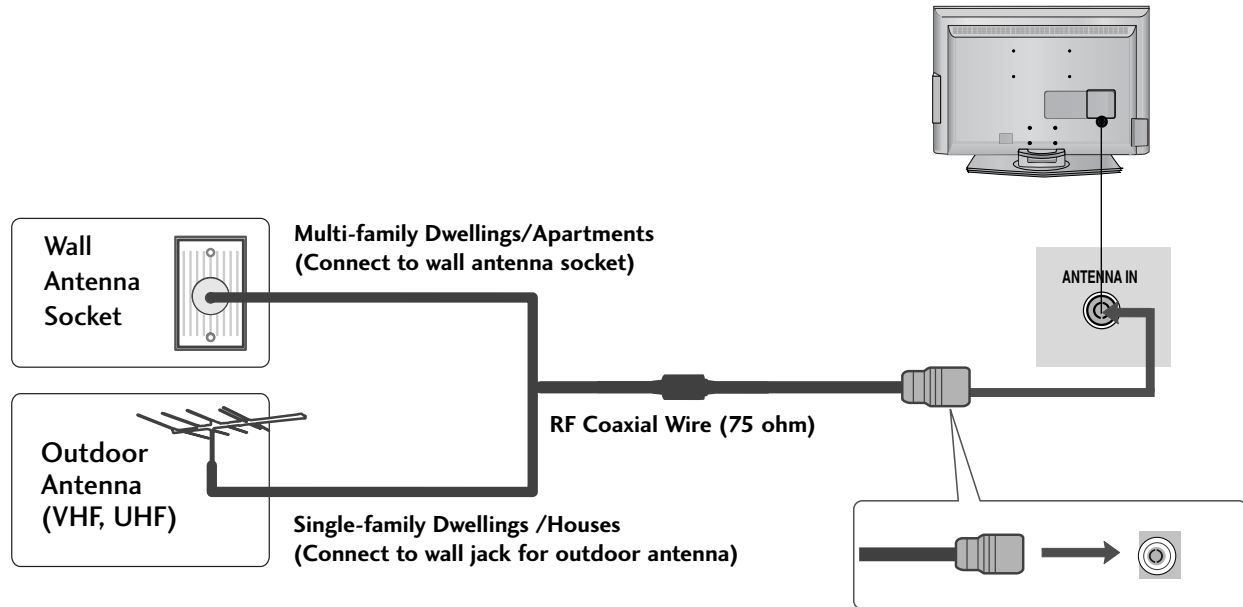

- In poor signal areas, to achieve better picture quality it may be necessary to install a signal amplifier to the antenna as shown above.
- If signal needs to be split for two TVs, use an antenna signal splitter for connection.

# WATCHING TV /PROGRAMME CONTROL

## REMOTE CONTROL KEY FUNCTIONS

When using the remote control, aim it at the remote control sensor on the TV.

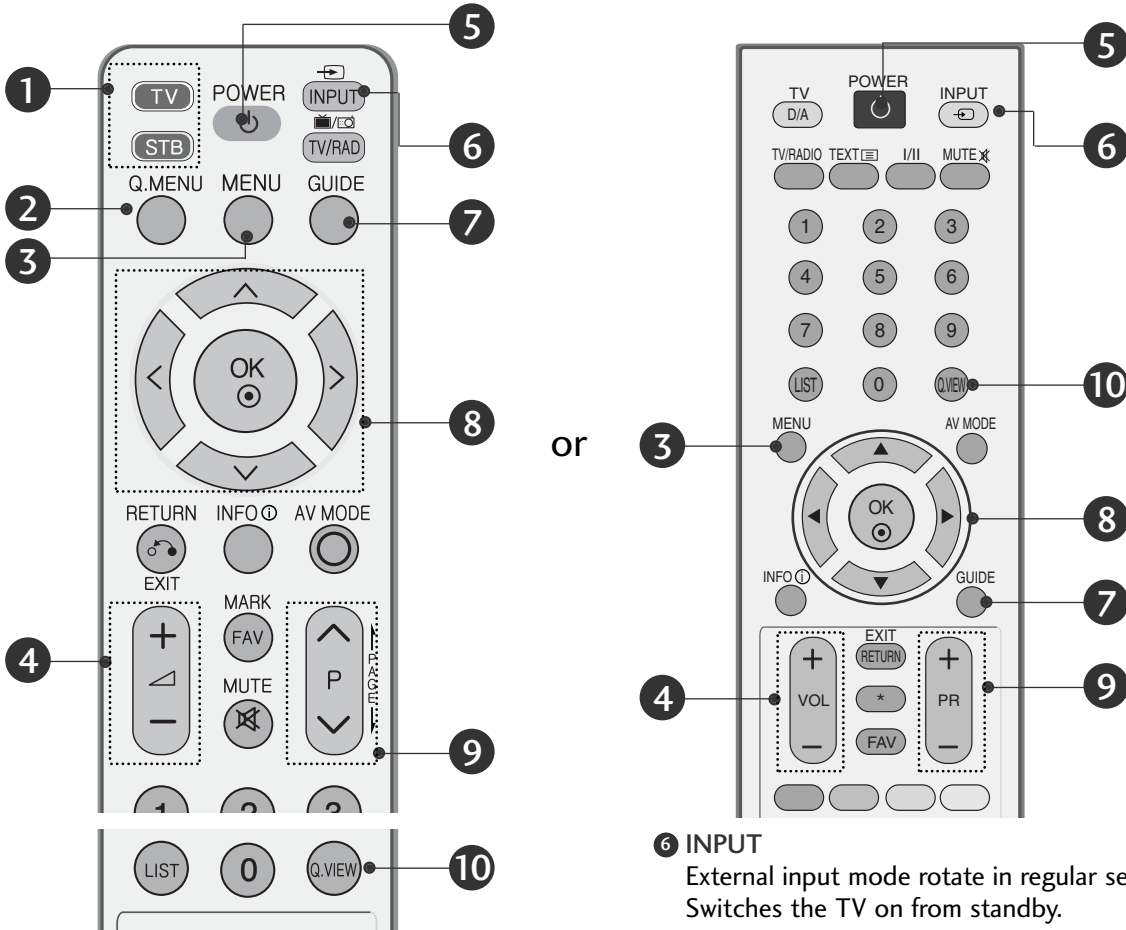

- 1 MODE**  
Selects the remote operating modes.
- 2 Q. MENU**  
Select the desired quick menu source.
- 3 MENU**  
Selects a menu.  
Clears all on-screen displays and returns to TV viewing from any menu.
- 4 VOLUME UP /DOWN**  
Adjusts the volume.
- 5 POWER**  
Switches the TV on from standby or off to standby.

- or
- 6 INPUT**  
External input mode rotate in regular sequence.  
Switches the TV on from standby.
  - 7 GUIDE**  
Shows programme schedule.
  - 8 THUMBSTICK(Up/Down/Left/Right)**  
Allows you to navigate the on-screen menus and adjust the system settings to your preference.  
OK  
Accepts your selection or displays the current mode.
  - 9 Programme UP/DOWN**  
Selects a programme.
  - 10 Q.VIEW**  
Returns to the previously viewed programme.

### Installing Batteries

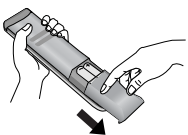

- Open the battery compartment cover on the back and install the batteries matching correct polarity (+with +,-with -).
- Install two 1.5V AAA batteries. Do not mix old or used batteries with new ones.
- Close cover.

# WATCHING TV /PROGRAMME CONTROL

ENGLISH

## TURNING ON THE TV

- When your TV is turned on, you will be able to use its features.

- 1 Firstly, connect the power cord correctly.  
At this stage, the TV switches to standby mode.
- 2 In standby mode to turn TV on, press the  $\phi$  / I, INPUT or P  $\wedge$   $\vee$  (or PR  $\blacktriangle$   $\blacktriangledown$ ) button on the TV or press the POWER, INPUT, D/A, P  $\wedge$   $\vee$  (or PR + -) or NUMBER button on the remote control and the TV will switch on.

### Initializing setup

If the OSD (On Screen Display) is displayed on the screen after turning on the TV, you can adjust the Language, Select Mode, Country, Time Zone, Auto programme tuning.

#### Note:

- a. It will automatically disappear after approx. 40 seconds unless a button is pressed.
- b. Press the **BACK** or **RETURN** button to change the current OSD to the previous OSD.
- c. For those countries without confirmed DTV broadcasting standards, some DTV features might not work, depending on the DTV broadcasting environment.
- d. "Home" mode is the optimal setting for home environments, and is the TV's default mode.
- e. "In Store" mode is the optimal setting for store environments." If a user modifies image quality data, "In Store" mode initializes the product to the image quality set by us after a certain period of time.
- f. The mode (Home, In Store) can be changed by executing Factory Reset in the **OPTION** menu.

## ON-SCREEN MENU LANGUAGE / COUNTRY SELECTION

The installation guide menu appears on the TV screen when it is switched on for the first time.

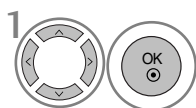

Select your desired language.

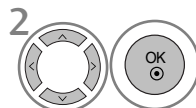

Select your country.

\* If you want to change Language/ Country selection

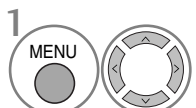

Select **OPTION**.

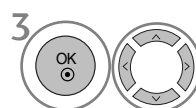

Select your desired language or country.

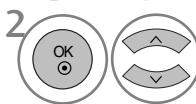

Select **Menu Language** or **Country**.

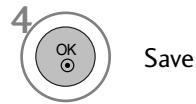

Save it.





### ! NOTE

- ▶ If you do not finish the set-up Installation Guide by pressing **RETURN** or if you time out on the OSD (On Screen Display) the installation menu will continuously appear until the set up is completed whenever the TV is switched on
- ▶ If you select the wrong local country, teletext may not appear correctly on the screen and some problems may occur during teletext operation.
- ▶ The CI (Common Interface) function may not be applied based on country broadcasting circumstances.
- ▶ DTV mode control buttons may not function based on country broadcasting circumstances.
- ▶ In country that Digital broadcasting regulation isn't fixed, some DTV function may not work depending on digital broadcasting circumstances.
- ▶ The Country Setting "UK" should only be activated UK.

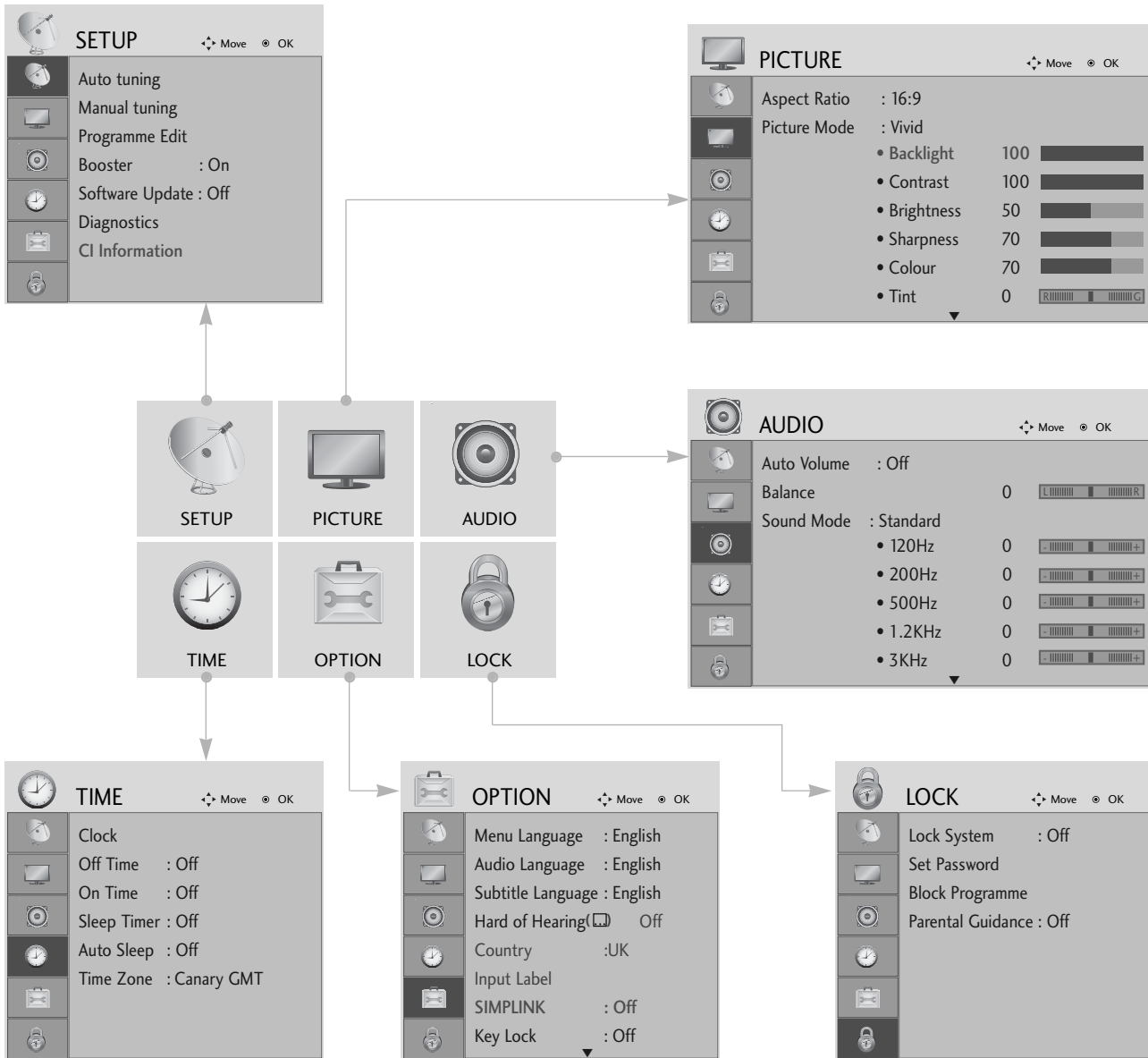
# ON SCREEN MENUS SELECTION AND ADJUSTMENT

Your TV's OSD (On Screen Display) may differ slightly from what is shown in this manual.



- 1   Display each menu.
- 2   Select a menu item.
- 3  Move to the pop up menu.

- Press the **MENU** button to return to normal TV viewing.
- Press the **RETURN** button to move to the previous menu screen.

# WATCHING TV /PROGRAMME CONTROL

ENGLISH

## AUTO PROGRAMME TUNING

Use this to automatically find and store all available programmes.

When you start auto programming in digital mode, all previously stored service information will be deleted.

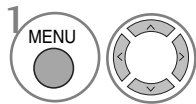
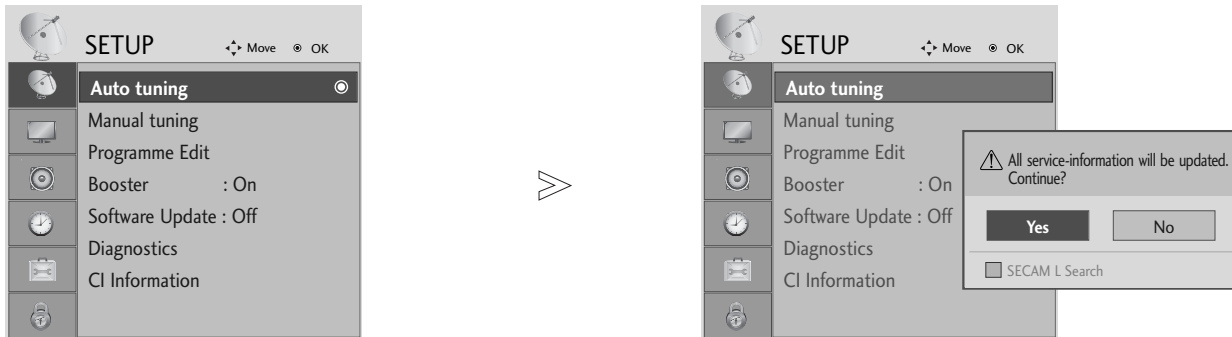

Select **SETUP**.

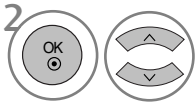

Select **Auto Tuning**.

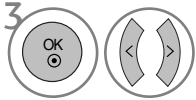

Select **Yes**.



Run **Auto tuning**.

- Use **NUMBER** buttons to input a 4-digit password in **Lock System 'On'**.
- If you wish to keep on auto tuning select **YES** using the **< >** button. Then, press the **OK** button. Otherwise select **NO**.

- Press the **MENU** button to return to normal TV viewing.
- Press the **RETURN** button to move to the previous menu screen.



# APPENDIX

## MAINTENANCE

Early malfunctions can be prevented. Careful and regular cleaning can prolong the life of your new TV.  
Caution: Be sure to switch the power off and unplug the power cord before you begin any cleaning.

### Cleaning the Screen

- 1 A good way to keep the dust off your screen for a while is to wet a soft cloth in a mixture of lukewarm water and a little fabric softener or dish washing detergent. Wring the cloth until it is almost dry, and then use it to wipe the screen.
- 2 Ensure there is no excess water on the screen. Allow any water or dampness to evaporate before switching on.

### Cleaning the Cabinet

- To remove dirt or dust, wipe the cabinet with a soft, dry, lint-free cloth.
- Do not to use a wet cloth.

### Extended Absence

#### ⚠ CAUTION

- ▶ If you expect to leave your TV dormant for prolonged periods (such as a holiday), unplug the power cord to protect against possible damage from lightning or power surges.

## TO VIEW THE USER'S GUIDE ON THE CD-ROM

To view the User's guide on the CD-ROM, Adobe Acrobat Reader must be installed on your PC. The "ACRORD" folder on the CD-ROM contains the installation program for Acrobat Reader. If you want to install Acrobat Reader, Open "My Computer" → Open the folder "LG" → Open the folder "ACRORD" → double-click your language.

#### To view the User's guide

The User's guide files are included in the supplied CD-ROM. Load the supplied CD-ROM into the CD-ROM drive of your PC. After a while, the web page of the CD-ROM will open automatically. (Windows users only) If the web page does not appear automatically, open the User's guide file directly. Open "My computer" → Open the folder "LG" → Double click the "index.htm" file.

## TROUBLESHOOTING

### The TV does not operate properly.

The remote control does not work

- Check to see if there is any object between the TV and the remote control causing an obstruction. Ensure you are pointing the remote control directly at the TV.
- Ensure that the batteries are installed with correct polarity (+ to +, - to -).
- Ensure that the correct remote operating mode is set: TV, VCR etc.
- Install new batteries.

Power is suddenly turned off

- Is the sleep timer set?
- Check the power control settings. Has the Power supply been interrupted.
- Is Auto sleep activated on this station?

# APPENDIX

ENGLISH

The video function does not work.	
No picture & No sound	<ul style="list-style-type: none"> <li>■ Check whether the TV is switched on.</li> <li>■ Try another channel. The problem may be with the broadcast.</li> <li>■ Is the power cord inserted correctly into the mains?</li> <li>■ Check your antenna direction and/or location.</li> <li>■ Test the mains outlet by plugging another TV into the same outlet.</li> </ul>
Picture appears slowly after switching on	<ul style="list-style-type: none"> <li>■ This is normal, the image is muted during the TV startup process. Please contact your service centre, if the picture has not appeared after five minutes.</li> </ul>
No or poor colour or poor picture	<ul style="list-style-type: none"> <li>■ Adjust Colour in menu option.</li> <li>■ Allow a sufficient distance between the TV and the VCR.</li> <li>■ Try another channel. The problem may be with the broadcast.</li> <li>■ Are the video cables installed properly?</li> <li>■ Activate any function to restore the brightness of the picture.</li> </ul>
Horizontal/vertical bars or picture shaking	<ul style="list-style-type: none"> <li>■ Check for local interference such as an electrical appliance or power tool.</li> </ul>
Poor reception on some channels	<ul style="list-style-type: none"> <li>■ Station or cable channel experiencing problems, tune to another station.</li> <li>■ Station signal is weak, reposition the antenna to receive weaker stations.</li> <li>■ Check for sources of possible interference.</li> </ul>
Lines or streaks in pictures	<ul style="list-style-type: none"> <li>■ Check antenna (Change the position of the antenna).</li> </ul>
No picture when connecting HDMI	<ul style="list-style-type: none"> <li>■ Check HDMI cable over version 1.3. If the HDMI cables don't support HDMI version 1.3, it can cause flickers or no screen display. In this case use the latest cables that support HDMI version 1.3.</li> </ul>

The audio function does not work.	
Picture OK & No sound	<ul style="list-style-type: none"> <li>■ Press the <b>VOLUME</b> button.</li> <li>■ Sound muted? Press <b>MUTE</b> button.</li> <li>■ Try another channel. The problem may be with the broadcast.</li> <li>■ Are the audio cables installed properly?</li> </ul>
No output from one of the speakers	<ul style="list-style-type: none"> <li>■ Adjust <b>Balance</b> in menu option.</li> </ul>
Unusual sound from inside the TV	<ul style="list-style-type: none"> <li>■ A change in ambient humidity or temperature may result in an unusual noise when the TV is switched on or off and does not indicate a fault with the TV.</li> </ul>
No sound when connecting HDMI or USB	<ul style="list-style-type: none"> <li>■ Check HDMI cable over version 1.3.</li> <li>■ Check USB cable over version 2.0.</li> </ul> <p style="text-align: right;">*This feature is not available for all models.</p>

**There is a problem with PICTURE settings.**

When the user changes the picture settings, the TV automatically converts back to the initial settings after a certain period of time.

- It means that the TV is currently set to **In Store** mode.  
To switch to **Home** mode you should do the followings:  
From the TV Menu, choose **OPTION** -> **Factory Reset** -> **Yes** (wait for a few seconds for the TV to download again) -> OSD "**WELCOME**" appears -> Press **OK** button -> Choose **Language** -> Choose **Home** -> Select your **Country** and **Time Zone** -> Press **OK** button. Program search will begin automatically (You can stop the search by pressing the **OK** button). Now, you have completed switching to the **Home** mode.

## WEIGHT

MODELS		19LS4D*	22LS4D*	19LG30**	
		19LS4D-ZD	22LS4D-ZD	19LG3000-ZA 19LG3050-ZA 19LG3060-ZB	
Weight	with stand	5.1 kg / 11.3 lbs 4.6 kg / 10.2 lbs	6.1 kg / 13.5 lbs 5.7 kg / 12.6 lbs	5.02 kg / 11.1 lbs 4.76 kg / 10.5 lbs	
	without stand				
MODELS		22LG30**	26LG30**	32LG30**	
		22LG3000-ZA 22LG3050-ZA 22LG3060-ZB	26LG3000-ZA 26LG3050-ZA	32LG3000-ZA 32LG3030-ZA	
Weight	with stand	5.6 kg / 12.4 lbs 5.34 kg / 11.8 lbs	10.1 kg / 22.3 lbs 8.6 kg / 19.0 lbs	13.4 kg / 29.6 lbs 11.9 kg / 26.3 lbs	
	without stand				
MODELS		37LG30**	42LG30**	32LG20**	37LG20**
		37LG3000-ZA 37LG3030-ZA	42LG3000-ZA 42LG3030-ZA	32LG2000-ZA	37LG2000-ZA
Weight	with stand	18.8 kg / 41.5 lbs 16.2 kg / 35.7 lbs	23.6 kg / 52.1 lbs 21.0 kg / 46.3 lbs	13.4 kg / 29.6 lbs 11.9 kg / 26.3 lbs	
	without stand				
MODELS		42LG20**	32LG32**	42LG32**	32LG5***
		42LG2000-ZA	32LG3200-ZA	42LG3200-ZA	32LG5000-ZA 32LG5010-ZD 32LG5020-ZB 32LG5030-ZE 32LG5600-ZB 32LG5700-ZF
Weight	with stand	23.6 kg / 52.1 lbs 21.0 kg / 46.3 lbs	13.4 kg / 29.6 lbs 11.9 kg / 26.3 lbs	23.6 kg / 52.1 lbs 21.0 kg / 46.3 lbs	
	without stand				
MODELS		37LG50**	42LG50**	47LG50**	52LG50**
		37LG5000-ZA 37LG5010-ZD 37LG5020-ZB 37LG5030-ZE	42LG5000-ZA 42LG5010-ZD 42LG5020-ZB 42LG5030-ZE	47LG5000-ZA 47LG5010-ZD 47LG5020-ZB 47LG5030-ZE	52LG5000-ZA 52LG5010-ZD 52LG5020-ZB 52LG5030-ZE
Weight	with stand	18.3 kg / 40.4 lbs 15.6 kg / 34.4 lbs	26.2 kg / 57.8 lbs 23.5 kg / 51.8 lbs	29.2 kg / 64.4 lbs 24.6 kg / 54.3 lbs	
	without stand				

■ The specifications shown above may be changed without prior notice for quality improvement.

(UK only)

Keep this important information about how to re-tune your TV during the digital TV switchover

Keep this leaflet and your instruction manual safe – you'll need them



get set for digital

Television in the UK is going digital, bringing us all more choice and new services. Starting in late 2007 and ending in 2012, television services in the UK will go completely digital, TV region by TV region.

Please see overleaf to find out when your area switches to digital.

Digital UK is the independent, non-profit organisation leading the process of digital TV switchover in the UK. Digital UK provides impartial information on what people need to do to prepare for the move to digital, and when they need to do it.

### How the switchover affects your TV equipment:

Your new TV has a digital tuner built in, which means it is ready to receive the Freeview signal by simply plugging it into your aerial socket (check if you can get digital TV through your aerial now, or whether you'll have to wait until switchover, at [www.digitaluk.co.uk](http://www.digitaluk.co.uk)).

When the TV switchover happens in your area, there are at least two occasions when you will need to re-tune your TV in order to continue receiving your existing TV channels, and also to pick up new ones. Digital UK, the body leading the digital TV switchover, will advise you when you need to re-tune during the switchover.

If you choose to connect your TV to satellite or cable with a digital box then it will not be affected by switchover, and you won't need to re-tune.

### When does switchover happen?

\*Copeland switches on October 17, 2007

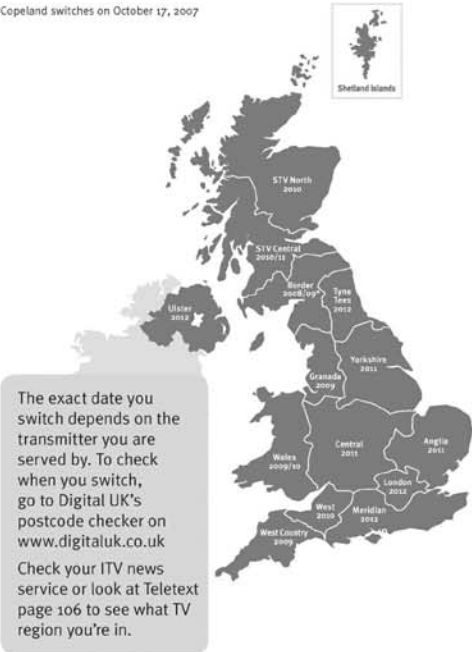

The exact date you switch depends on the transmitter you are served by. To check when you switch, go to Digital UK's postcode checker on [www.digitaluk.co.uk](http://www.digitaluk.co.uk). Check your ITV news service or look at Teletext page 106 to see what TV region you're in.

Visit us at [digitaluk.co.uk](http://digitaluk.co.uk) call us on 0845 6 50 50 50\*

\*Calls charged at BT rate of 3p per minute daytime and 1p per minute evenings and weekends. Rates may vary for calls from non-BT lines.

### How to re-tune:

To find out how to re-tune your TV, check your manufacturer's instructions for details. Or see below for a typical sequence:

1. With your TV in digital TV mode, press 'Menu' on your remote control. (Some TVs will ask you for a code. If you have not already changed it, the default code is usually 0000, or check your instruction book.)
2. From the Menu options on screen, select 'SETUP'. Select 'Auto Tuning'\* to re-tune your digital TV (not 'add channels'). You may have to wait a couple of minutes for the re-tune to complete.
3. If you do not re-tune your channels when advised to do so by Digital UK, you may lose some or all of your channels until you do re-tune. You should re-tune your TV every few months to check for any new channels.

If you are missing any channels, it may be that they are not available in your area, or that your aerial needs upgrading.

If you have any questions, please contact your equipment supplier or call Digital UK on 0845 6 50 50 50 or visit [www.digitaluk.co.uk](http://www.digitaluk.co.uk)

## Free Manuals Download Website

<http://myh66.com>

<http://usermanuals.us>

<http://www.somanuals.com>

<http://www.4manuals.cc>

<http://www.manual-lib.com>

<http://www.404manual.com>

<http://www.luxmanual.com>

<http://aubethermostatmanual.com>

Golf course search by state

<http://golfingnear.com>

Email search by domain

<http://emailbydomain.com>

Auto manuals search

<http://auto.somanuals.com>

TV manuals search

<http://tv.somanuals.com>