



22LQ630H
26LQ630H
32LQ630H
42CQ610H

Hospital TVs

Commercial Mode Setup Guide

Note: Selected features shown within this guide may not be available on all models.

EXPERIENCED INSTALLER

Express Script Installer Menu Wizard
pages 11 – 14

Custom Master TV Setup
pages 15 – 18

FTG Mode of Operation
pages 42 – 53

For Customer Support/Service, please call:

1-888-865-3026

The latest product information and documentation is available online at:

www.LGSolutions.com

MODEL and SERIAL NUMBER

The model and serial numbers of this TV are located on the back of the cabinet. For future reference, LG suggests that you record those numbers here:

Model No. _____ Serial No. _____



WARNING:

TO REDUCE THE RISK OF ELECTRIC SHOCK DO NOT REMOVE COVER (OR BACK). NO USER-SERVICEABLE PARTS INSIDE. REFER TO QUALIFIED SERVICE PERSONNEL.



The lightning flash with arrowhead symbol, within an equilateral triangle, is intended to alert the user to the presence of uninsulated “dangerous voltage” within the product’s enclosure that may be of sufficient magnitude to constitute a risk of electric shock to persons.



The exclamation point within an equilateral triangle is intended to alert the user to the presence of important operating and maintenance (servicing) instructions in the literature accompanying the appliance.

WARNING:

TO PREVENT FIRE OR SHOCK HAZARDS, DO NOT EXPOSE THIS PRODUCT TO RAIN OR MOISTURE.

POWER CORD POLARIZATION:

This product is equipped with a 3-wire grounding-type alternating current power plug. This plug will fit into the power outlet only one way. This is a safety feature. If you are unable to insert the plug fully into the outlet, contact your electrician to replace your obsolete outlet. Do not defeat the safety purpose of the 3-wire grounding-type plug.

NOTE TO CABLE/TV INSTALLER:

This reminder is provided to call the cable TV system installer’s attention to Article 820-40 of the National Electrical Code (U.S.A.). The code provides guidelines for proper grounding and, in particular, specifies that the cable ground shall be connected to the grounding system of the building, as close to the point of the cable entry as practical.

REGULATORY INFORMATION:

This equipment has been tested and found to comply with the limits for a Class B digital device, pursuant to Part 15 of the FCC Rules. These limits are designed to provide reasonable protection against harmful interference when the equipment is operated in a residential installation. This equipment generates, uses and can radiate radio frequency energy and, if not installed and used in accordance with the instruction manual, may cause harmful interference to radio communications. However, there is no guarantee that interference will not occur in a particular installation. If this equipment does cause harmful interference to radio or television reception, which can be determined by turning the equipment off and on, the user is encouraged to try to correct the interference by one or more of the following measures:

- Reorient or relocate the receiving antenna.
- Increase the separation between the equipment and receiver.
- Connect the equipment to an outlet on a circuit different from that to which the receiver is connected.
- Consult the dealer or an experienced radio/TV technician for help.

CAUTION:

Do not attempt to modify this product in any way without written authorization from LG Electronics U.S.A., Inc. Unauthorized modification could void the user’s authority to operate this product.

COMPLIANCE:

The responsible party for this product’s compliance is: LG Electronics U.S.A., Inc.
1000 Sylvan Avenue, Englewood Cliffs, NJ 07632, USA • Phone: 1-201-816-2000

Marketed and Distributed in the United States by LG Electronics U.S.A., Inc.
1000 Sylvan Avenue, Englewood Cliffs, NJ 07632

IMPORTANT SAFETY INSTRUCTIONS

1. Read these instructions.
2. Keep these instructions.
3. Heed all warnings.
4. Follow all instructions.
5. Do not use this apparatus near water.
6. Clean only with dry cloth.
7. Do not block any ventilation openings. Install in accordance with the manufacturer's instructions.
8. Do not install near any heat sources, such as radiators, heat registers, stoves, or other apparatus (including amplifiers) that produce heat.
9. Do not defeat the safety purpose of the polarized or grounding-type plug. A polarized plug has two blades with one wider than the other. A grounding-type plug has two blades and a third grounding prong. The wide blade or the third prong are provided for your safety. If the provided plug does not fit into your outlet, consult an electrician for replacement of the obsolete outlet.
10. Protect the power cord from being walked on or pinched, particularly at plugs, convenience receptacles, and the point where it exits from the apparatus.
11. Only use attachments/accessories specified by the manufacturer.
12. Use only with the cart, stand, tripod, bracket, or table specified by the manufacturer or sold with the apparatus. When a cart is used, use caution when moving the cart/apparatus combination in order to avoid injury from tip-over.



PORTABLE CART WARNING

13. Refer all servicing to qualified service personnel. Servicing is required when the apparatus has been damaged in any way, such as power-supply cord or plug is damaged, liquid has been spilled or objects have fallen into the apparatus, the apparatus has been exposed to rain or moisture, does not operate normally, or has been dropped.
14. Never touch this apparatus or antenna during a thunder or lightning storm.
15. When mounting a TV on the wall, make sure not to install the TV by the hanging power and signal cables on the back of the TV.
16. Do not allow an impact shock or any objects to fall into the product, and do not drop objects onto the screen.

17. Power Cord

Caution: It is recommended that appliances be placed upon a dedicated circuit; that is, a single outlet circuit which powers only that appliance and has no additional outlets or branch circuits. Check the specification page in the Owner's Manual to be certain.

Periodically examine the cord of your appliance, and if its appearance indicates damage or deterioration, unplug it, discontinue use of the appliance, and have the cord replaced with an exact replacement part by an authorized servicer. Protect the power cord from physical or mechanical abuse, such as twisting, kinking, or pinching or being closed in a door or walked upon. Pay particular attention to plugs, wall outlets, and the point where the cord exits the appliance.

Do not use a damaged or loose power cord. Be sure to grasp the plug when unplugging the power cord. Do not pull on the power cord to unplug the TV.

18. Overloading

Do not connect too many appliances to the same AC power outlet as this could result in fire or electric shock. Do not overload wall outlets. Overloaded wall outlets, loose or damaged wall outlets, extension cords, frayed power cords, or damaged or cracked wire insulation are dangerous. Any of these conditions could result in fire or electric shock.

19. Outdoor Use/Wet Location



Warning: To reduce the risk of fire or electrical shock, do not expose this product to rain, moisture or other liquids.

Do not touch the TV with wet hands. Do not install this product near flammable objects such as gasoline or candles or expose the TV to direct air conditioning.

Do not expose to dripping or splashing and do not place objects filled with liquids, such as vases, cups, etc., on or over the apparatus (e.g., on shelves above the unit).

20. Grounding

Ensure that you connect the earth ground wire to prevent possible electric shock (i.e., a TV with a three-prong grounded AC plug must be connected to a three-prong grounded AC outlet). If grounding methods are not possible, have a qualified electrician install a separate circuit breaker. Do not try to ground the unit by connecting it to telephone wires, lightning rods, or gas pipes.

21. Disconnect Device

The mains plug is the disconnecting device. The plug must remain readily operable.

As long as this unit is connected to the AC wall outlet, it is not disconnected from the AC power source even if you turn off this unit by SWITCH.

(Continued on next page)

IMPORTANT SAFETY INSTRUCTIONS

(Continued from previous page)

22. Outdoor Antenna Grounding

If an outside antenna or cable system is connected to the product, follow the precautions below.

An outdoor antenna system should not be located in the vicinity of overhead power lines or other electric light or power circuits or where it can come into contact with such power lines or circuits as death or serious injury can occur.

Be sure the antenna system is grounded so as to provide some protection against voltage surges and built-up static charges.

Article 810 of the National Electrical Code (NEC) in the U.S.A. provides information with respect to proper grounding of the mast and supporting structure, grounding of the lead-in wire to an antenna-discharge unit, size of grounding conductors, location of antenna-discharge unit, connection to grounding electrodes, and requirements for the grounding electrode.

Antenna Grounding According to NEC, ANSI/NFPA 70

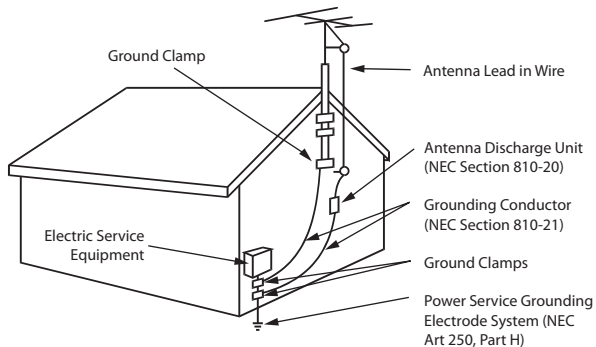

23. Cleaning

When cleaning, unplug the power cord and wipe gently with a soft cloth to prevent scratching. Do not spray water or other liquids directly on the TV as electric shock may occur. Do not clean with chemicals such as alcohol, thinners or benzene.

24. Transporting Product

Make sure the TV is turned Off and unplugged and that all cables have been removed. It may take two or more people to carry larger TVs. Do not press against or put stress on the front panel of the TV during transport.

25. Ventilation

Install the TV where there is proper ventilation. Do not install in a confined space such as a bookcase. Do not cover the TV with cloth or other materials (e.g., plastic) while it is plugged in. Do not install in excessively dusty places.

26. Do not touch the ventilation openings, as they may become hot while the TV is operating.
27. If you smell smoke or other odors coming from the TV or hear strange sounds, unplug the power cord, and contact an authorized service center.

28. Do not press against the front panel of the TV with your hand or a sharp object (e.g., a nail, pencil, or pen) or make a scratch on it.

29. Keep the product away from direct sunlight.

30. Dot Defect

The LCD panel is a high technology product with resolution of two million to six million pixels. In a very few cases, you could see fine dots on the screen while you are viewing the TV. Those dots are deactivated pixels and do not affect the performance and reliability of the TV.

31. Generated Sound

“Cracking”: A cracking noise that occurs while the TV is On or when it is turned Off is generated by plastic thermal contraction due to temperature and humidity. This noise is common for products where thermal deformation is required.

Electrical circuit humming/panel buzzing: A low level noise is generated from a high-speed switching circuit, which supplies a large amount of current to operate a product. It varies depending on the product. This generated sound does not affect the performance and reliability of the product.

32. For LCD TV

If the TV feels cold to the touch, there may be a small “flicker” when it is turned On. This is normal; there is nothing wrong with the TV. Some minute dot defects may be visible on the screen, appearing as tiny red, green, or blue spots. However, they have no adverse effect on the TV’s performance. Avoid touching the LCD screen or holding your finger(s) against it for long periods of time. Doing so may produce some temporary distortion effects on the screen.

Table of Contents

Safety Warnings	2	Creating an FTG Configuration File using the FTG File Manager	44
Important Safety Instructions	3–4	Teaching FTG Configuration to a TV	46
Table of Contents	5	Learning FTG Configuration from a TV	47
Commercial Mode Overview	6–8	Optional Manual Configuration / TV Setup	48
Setup Checklist	6	FTG Mode via EBL (Local Configuration)	49
Pass-through Mode	6	FTG File Manager Utilities Overview	50–53
FTG Mode	8	FTG File Manager Main Screen	50
Remote Management in FTG Mode	8	FTG Channel Map Configuration Utility	51
Pro:Centric Operation	9–10	FTG Channel Map Editor	52
Pro:Centric TV Interactive Menu Features	9	FTG Installer Menu Configuration Utility	53
Pro:Centric Interactive Menu Navigation	9	References	
Pro:Centric Setup	10	Upgrading TV/PTC Software using a USB Memory Device	54
Express Script Installer Menu Wizard	11–14	Downloading a Splash Screen using a USB Memory Device	55
Custom Master TV Setup	15–18	Power Consumption Settings	56
Before You Begin	15	TV Aux Input Configuration	57
Cloning Methods	15	<i>b</i> -LAN Setup & Overview	58
Clonable TV Setup Menu Features	15	LQ630H/CQ610H Hospital Operations	59–60
Custom Master TV Setup Procedure	16	Restoring Factory Defaults on the TV(s)	61
Installer Menu	19–27	TV Zone Restrictions	62
Accessing the Installer Menu	19	22LQ630H Rear and Side Jack Panels	63
Using the Installer Menu	20	26/32LQ630H Rear and Side Jack Panels	64
Exiting the Installer Menu and Activating Settings	20	42CQ610H Rear and Side Jack Panels	65
Channel Icons / Custom Text Labels (2-5-4 + MENU Mode)	28	External Mono Speaker Setup	66
Channel Banks Setup	29–31	Installer Remote Control Typical Key Functions	67
Channel Banks Worksheet	32	Pillow Speaker Setup	68
Cloning Overview	33	USB Media Navigation using Pro:Centric Pillow Speaker	69
USB Cloning Procedures	34–37	VESA Standard TV Mounts	70
Learning / Teaching a Master TV Setup using a USB Memory Device / .tlx File	34	Troubleshooting	71–75
Learning / Teaching a Master TV Setup using a USB Memory Device / .tll File	36	General Troubleshooting	71
Clone Programmer Cloning Procedures	38–41	Troubleshooting Flow Chart (No Power)	72
Learning / Teaching a Master TV Setup using a TLL-1100A Clone Programmer	38	Commercial Mode Check / FTG Operation Troubleshooting	73
Learning / Teaching a Master TV Setup using an LT2002 Clone Programmer	40	Clone Programmer Troubleshooting	74
FTG Mode of Operation Overview	42–43	Channel Banks Setup Troubleshooting	75
FTG Mode via CPU or EBL	42	Glossary of Terms	76
Determining the TV Operating Mode	43	Document Revision History / Open Source Software Notice	77
FTG Mode via CPU	44–48	Back Cover	78

Notes

- Installer Menu content is intended for use primarily by qualified TV electronics technicians.
- Refer to the Owner's Manual for additional information on TV installation, features, specifications, maintenance, and safety instructions.
- Design and specifications subject to change without prior notice. This document provides examples of typical TV displays. Your displays may vary from those shown in this document.

Commercial Mode Overview

This document describes how to set up LQ630H and CQ610H Pro:Centric® TVs for Commercial Mode operation. LG commercial TV functionality is based on “ownership” of the Channel Map; that is, the Channel Map resides in the TV’s CPU, Protocol Translator Card (PTC), or embedded *b*-LAN™ (EBL) module, or it resides externally from the TV (i.e., in a device from the solution provider).

Each of these TV models is capable of Free-To-Guest (FTG) Mode operation via the TV CPU. Alternatively, the EBL module can be configured either for Pass-through Mode (default) or FTG Mode. When neither the CPU nor EBL is in FTG Mode, these TV models also allow external control via the TV’s MPI port.

Setup Checklist

Note: This document provides information specific to Commercial Mode operation. Refer to the Owner’s Manual for detailed information on TV installation and hardware and cable connections.

Installation

- Unpack TV and all accessories.
 - Install batteries in the Installer Remote.
 - Install TV on VESA mount or stand.
- Note:** It may be advisable to make all cable connections before installing on VESA mount or stand, as appropriate.

Cable Connections

- Make all rear jack panel and MPI card slot connections, as appropriate.

Commercial Mode Setup

- Complete appropriate procedures as described in this document for Commercial Mode operation.

Hardware Connections

- Install any additional hardware as appropriate to your institution, LAN, etc.

Pass-through Mode

This mode allows you to configure stand-alone TVs and/or create a Master TV Setup for cloning purposes for TVs that are to remain in Pass-through Mode. This mode also allows external control via the GAME CONTROL/MPI port on the TV rear jack panel.

There are two methods for configuring stand-alone TVs in Pass-through Mode: either using the Express Script Installer Menu Wizard or the Custom Master TV Setup procedure as described in this document.

Express Script Installer Menu Wizard

The Express Script Installer Menu Wizard guides you through the process of setting up the TVs, limiting the customization of TV features and Installer Menu items to those that are essential to most hospital TV viewing applications. See “Express Script Installer Menu Wizard” on pages 11 to 14 for detailed information.

Note: While the Express Script Installer Menu Wizard enables you to set up TVs in lieu of cloning, you can also use an Express Script TV Setup for cloning purposes, if desired. However, note that TV setup menu customization via the Express Script Installer Menu Wizard is limited to Channel Menu options.

Custom Master TV Setup

Unlike the guided process above, the Custom Master TV Setup procedure enables you to create a customized Master TV Setup for cloning purposes. Configure Installer Menu items as required for TV operation and set up TV features (Channel, Picture, Audio, etc.). See “Custom Master TV Setup” on pages 15 to 18 for detailed information.

Installer Menu

To create a customized Master TV Setup, you will need to know how to access the commercial controller (PTC) Installer Menu and make changes to the default values as required. If necessary, familiarize yourself with the Installer Menu and how to make and save changes. Refer to pages 19 to 27 for information on accessing the Installer Menu and for detailed descriptions of the Installer Menu items.

TV Setup Menus

On-screen setup menus control the features of the TV. Use the Installer Remote to access the TV setup menus, and set the TV features to the desired configuration for the end user. Refer to the Owner's Manual for detailed information on the TV setup menus.

Cloning

Cloning refers to the process of capturing a Master TV Setup and transferring it to a Target TV. Both TVs must be in Pass-through Mode and both TVs must be identical models. The Master TV's clonable setup menu features should be configured as part of the Master TV Setup. If there are features in the Master TV's setup—channel icons or labels, digital font options, etc.—that are not set or that are set incorrectly, those features also will not be set or will be set incorrectly in the Target TVs. Refer to pages 33 to 41 for detailed information on cloning requirements and procedures.

Note: If desired, an Express Script TV Setup also may be used for cloning purposes.

External MPI Control

To control the TV using an external MPI control device, you must use the TV's GAME CONTROL/MPI port for communication purposes. In these TVs, Installer Menu item 118 POWER SAVINGS controls the power circuitry for both the embedded *b*-LAN module and the GAME CONTROL/MPI port; therefore, to ensure that the GAME CONTROL/MPI port circuitry is powered, thus enabling MPI communication, Installer Menu item 118 POWER SAVINGS must be set appropriately. See Installer Menu item descriptions as well as Reference section, "*b*-LAN Setup & Overview," for further information.

Note: These TV series are not equipped with MPI card slots.

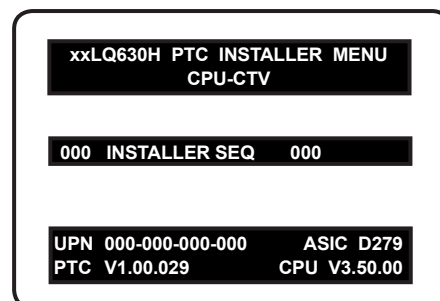

Typical Installer Menu

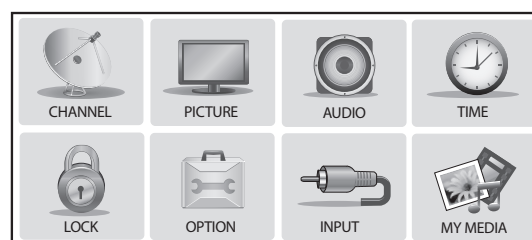

TV Setup Menus

Commercial Mode Overview (Cont.)

FTG Mode

This mode enables Pro:Idiom® decryption and also allows logical channel mapping of physical channels to remove the need for dash tuning. TV operation in FTG Mode is based on which element of the TV owns the FTG Logical Channel Map—the CPU or the EBL. Understanding the application in which the TV will be used is vital in determining the owner.

FTG Mode via CPU and FTG Mode via EBL are two separate and distinct FTG Modes of operation, each with its own unique advantages and requirements as described later in this document. When the TV CPU is configured with an FTG Channel Map, the CPU controls the operation of the TV, and when the EBL is configured with an FTG Channel Map, the EBL controls the operation of the TV.

Once it is determined whether the TV CPU or the EBL will own the FTG Channel Map, configuration can begin. Configuration of either requires a PC application—the LG FTG File Manager for the TV CPU or the LG FTG Device Configuration Application for the EBL. Each application provides utilities that enable you to create/edit an FTG Channel Map and configure Installer Menu settings. See pages 42 to 53 for further information on FTG Mode operation and configuration.

Remote Management in FTG Mode

When the TV is configured for FTG Mode via CPU, remote management of the FTG Channel Map and FTG Installer Menu settings is provided by a Pro:Centric server. Refer to the **Pro:Centric Server Admin Client User Guide** for further information.

When the TV is configured for FTG Mode via EBL, the *b*-LAN module, which is internal to the TV, allows hospital/institution head end equipment (for example, an FMA-LG101) with *b*-LAN technology to communicate with the TV to provide remote management of the FTG Channel Map and FTG Installer Menu settings. See Reference section, “*b*-LAN Setup & Overview,” for further information.

Pro:Centric TV Interactive Menu Features

When running the Pro:Centric application, the interactive Pro:Centric TV enables patients and visitors to locate and select television entertainment using an interactive channel guide, check the daily weather, and view hospital and surrounding amenities via custom billboards and points-of-interest maps.

Pro:Centric application features include:

- Portal and information screens/pages (including a “Welcome” page) that include branding logos.
- An optional customized user interface (custom “skins”).
- Billboards and points-of-interest maps, which can be customized to focus on hospital amenities, local attractions and businesses, hotels, restaurants, news, events, etc.
- An optional Weather billboard that includes a local radar map, current conditions, and a four day forecast.
- An interactive channel guide that provides a channel list with channel icons. An electronic program guide (EPG) is an optional feature that displays up to three days of programming information viewable by channel and time.
- Video spooling that enables the hospital to deliver a video file to patient and visitor TVs for promotion and information purposes.

The Pro:Centric server Admin Client web editor/content wizard is provided for customer configuration of portal messages and billboards/maps.

Note: Customized content is typically defined by the service integrator and/or hospital administrators. LG does not provide hospital-specific content.

Pro:Centric Interactive Menu Navigation

Use the Pro:Centric pillow speaker to operate both interactive menus and regular TV features. Press **PORTAL** on the Pro:Centric pillow speaker to access the interactive menus.

Note: Interactive menu options may vary, depending on Pro:Centric features enabled for the site. The following are default interactive menus.



Channel Guide

Shows available TV networks and logical channels. When available, EPG data provides additional channel and program information.

Information

Typically displays information on hospital and nearby amenities, for example, restaurants, cafeterias, facilities, etc., as well as information on local weather.

Help

Provides help for navigating the interactive menus.

Watch TV

Removes the interactive menu from the screen and returns to the previously tuned TV channel.

Pro:Centric Operation (Cont.)

Pro:Centric Setup

Administration and management options for the Pro:Centric server are described in detail in the **Pro:Centric Server Admin Client User Guide**. This document describes only those settings that must be specified on the TVs.

On the TVs, the Data Channel must be set appropriately to enable Pro:Centric remote management/administration facilities, while the Pro:Centric Application Mode must be set appropriately to enable the Pro:Centric application.

- Remote management/administration (TV E-Z Installation): The Pro:Centric server Admin Client provides remote management/administration facilities for downloading splash screens and software/firmware updates as well as facilities for downloading the FTG Channel Map and FTG Installer Menu settings for TVs that are in FTG Mode via CPU.
- Pro:Centric application: The application, which operates in conjunction with FTG and PPV Modes, comprises the Pro:Centric interactive menus/features described on the previous page. Pro:Centric application settings are managed via the Pro:Centric server Admin Client.

The Data Channel and Pro:Centric Application Mode can be set using one of the following methods:

- If the TV is in Pass-through Mode, set Installer Menu items 098 PRO:CENTRIC and 119 DATA CHANNEL to the appropriate values. Refer to “Installer Menu” information on pages 19 to 27 for further details. Also, as necessary, refer to “Custom Master TV Setup” information on pages 15 to 18 and/or cloning information on pages 33 to 41.
- If the TV is in FTG Mode (via CPU or EBL), use the appropriate software to update the Pro:Centric and Data Channel Installer Menu items, and then transfer the FTG Installer Menu settings to the TV in accordance with the FTG Mode of configuration. Refer to FTG Mode information on pages 42 to 53 for further details.

Note: If using a Pro:Centric pillow speaker, also set Installer Menu item 027 HOSPITAL MODE to the required value.

Express Script Installer Menu Wizard

The Express Script Installer Menu Wizard guides you through the process of setting up the essential items for most hospital TV viewing applications. The wizard will appear on the screen each time the TV is turned ON, until configuration is completed or the wizard is exited. Use the Installer Remote to make selections and complete each step.

Note: If previously completed or exited, the Express Script Installer Menu Wizard can be re-activated from the Installer Menu—set Installer Menu item **117 FACT DEFAULT** to **1** to initiate the Express Script Installer Menu Wizard. See the “Installer Menu” section of this document for further information.

Note: If you plan to create a customized Master TV Setup using the procedure described on pages 15 to 18, transfer (Teach) a Master TV Setup to a Target TV, or configure a TV for FTG Mode of operation, be sure to exit the Express Script in order to avoid setup conflicts that may cause the TV to malfunction.

 **Note: If you bypass the Express Script, pillow speaker functionality will not be enabled unless you set Installer Menu item 027 HOSPITAL MODE appropriately. See the “Installer Menu” section of this document for further information.**

 **Note: If you opt to exit the Express Script Installer Menu Wizard at any time while it is in progress, any settings made will not be retained.**

Upon launching, the Express Script Installer Menu Wizard prompts you to select a menu mode. Use the Up/Down arrow keys on the Installer Remote to select the appropriate option:

- Select/highlight **Express Script** in order to proceed with the wizard. Then, press **OK (Enter)** on the Installer Remote.
- Select/highlight **Exit Express Script** to exit the wizard. Then, press **OK (Enter)** on the Installer Remote.

The following procedure describes the Express Script Installer Menu Wizard steps. You can select the “Back” button, where available, to check previous settings, as necessary.

1. Select the tuning band.

Use the Left/Right arrow keys on the Installer Remote to select the appropriate tuning band: Cable Standard (default), Cable HRC, Cable IRC, or Air. When you have made your selection, use the arrow keys to select **Next**, and then press **OK (Enter)**.

2. Select the Aux inputs.

If you simply select **Next** and press **OK (Enter)** in this step, default values will be used. Otherwise, use the Up/Down arrow keys to select the desired Aux input option(s).

- To customize settings, select **Customize inputs** and press **OK (Enter)**. Aux input options are displayed in a pop-up window. Use the arrow keys to select the input(s) to enable or disable. When you are finished, press **OK (Enter)** or **MENU** on the Installer Remote. Then, continue with step 3.
- To use default values, select **Use default values** and press **OK (Enter)**. Then, continue with step 3.

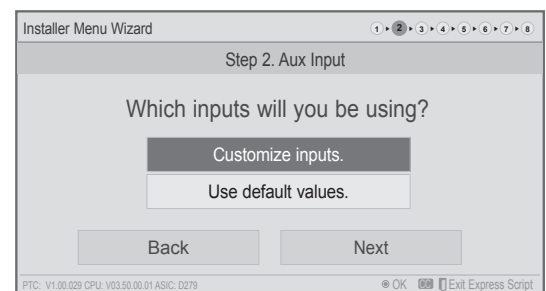
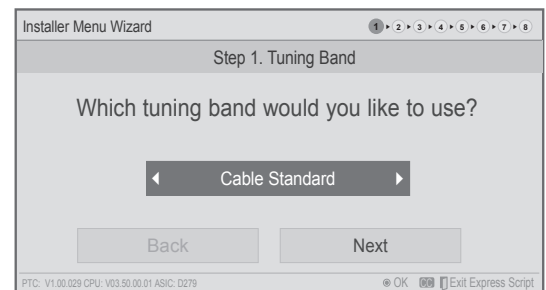
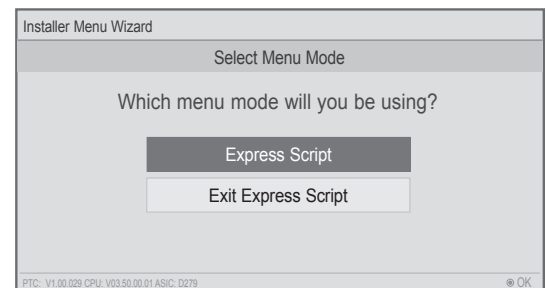

(Continued on next page)

Express Script Installer Menu Wizard (Cont.)

(Continued from previous page)

3. Select the speaker configuration.

Use the Left/Right arrow keys on the Installer Remote to select the appropriate speaker: Pillow Only (default), TV Only, or Pillow & TV. When you have made your selection, use the arrow keys to select **Next**, and then press **OK (Enter)**.

4. Select the pillow speaker code.

If using a Pro:Centric pillow speaker (LG IR codes) or a pillow speaker with Zenith IR codes, you can simply select **Next** and press **OK (Enter)** to accept the Zenith pillow speaker code default.

Otherwise, use the Up/Down arrow on the Installer Remote to select the pillow speaker code field, and use the Left/Right arrow keys to select the appropriate option. When you have made your selection, use the arrow keys to select **Next**, and then press **OK (Enter)**.

5. Choose whether to allow access to channels outside the channel lineup.

To allow direct access to channels outside the channel lineup (default: Yes), you can simply select **Next** and press **OK (Enter)** on the Installer Remote. To limit access to only the channel lineup (after the Express Script is complete) and restrict access to the TV setup menus, use the Up/Down arrow keys on the Installer Remote to select the channel access field, and use the Left/Right arrow keys to select "No."

When you have made your selection, use the arrow keys to select **Next**, and then press **OK (Enter)**.

Note: It is recommended that you select "No" to limit access to the channel lineup and prevent end users from accessing channel settings; i.e., the Channel Menu will be inaccessible/grayed out.

6. Run the Auto Search (Auto Tuning).

Select **Execute Auto Search** and press **OK (Enter)** on the Installer Remote to start the channel scan (searches for all available analog and digital channels). The system will display progress of the channel scan in a pop-up window. The scan typically takes a few minutes.

When the channel scan is complete, press **OK (Enter)** on the Installer Remote to close the pop-up window. Then, continue with step 7.

Note: If you do not want to run the Auto Search (for example, if you intend to manually add only a small number of channels), use the arrow keys on the Installer Remote to select **Next**, and then press **OK (Enter)**. Then, continue with step 7.



Note: You MUST select Execute Auto Search and press OK (Enter) in order to run the channel scan. If you move on to the next step without running the Auto Search, there will be no channels in the channel lineup (Channel Map).

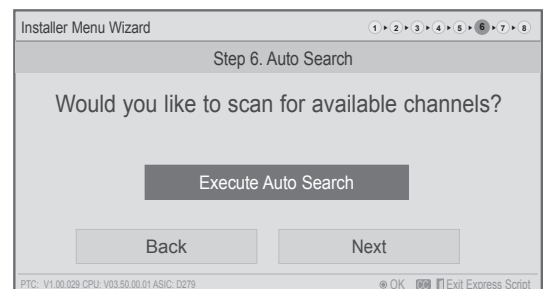
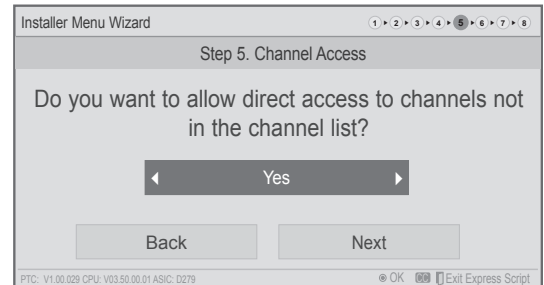
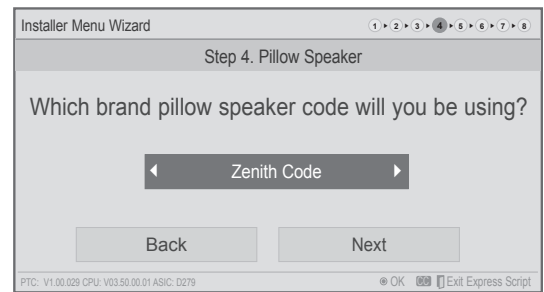
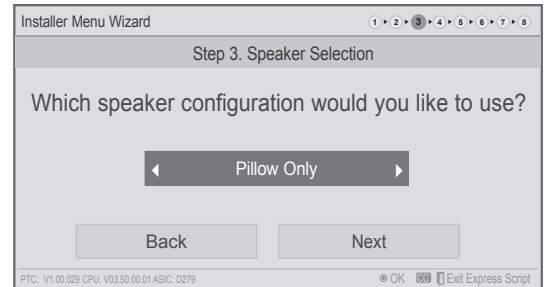

(Continued on next page)

Express Script Installer Menu Wizard (Cont.)

(Continued from previous page)

7. Edit the Channel Map.

This option enables you to add/delete channels, select channel icons, add channel labels, and/or set up channel banks before the Channel Map is transferred to the PTC (see step 8).

 **Note: The maximum number of channels (analog, digital, and Aux inputs) that can be transferred to the PTC is 141. An attempt to transfer more than 141 channels of any combination will result in a PTC Channel Map of exactly 141 channels; any extra channels will not be available in the PTC Channel Map. For example, if you enabled three Aux inputs in step 2 and the Auto Search found 141 channels, you must edit the Channel Map to decrease the number of analog/digital channels to (at most) 138 in order to accommodate the Aux inputs in the PTC Channel Map.**

Select **Edit Channel Map** and press **OK (Enter)** on the Installer Remote to edit the Channel Map, as necessary. Channel edit options will be displayed in a pop-up window (see example at right). Use the Up/Down arrow keys to navigate between fields:

- **Input & CH:** Edit the channel lineup, as necessary, to include only free to guest (non-encrypted) channels. Use the Left/Right arrow keys to select channels, and press **OK (Enter)** to add/delete channels per your system requirements.
- **Icon:** Use the Left/Right arrow keys or key in the icon number to select the appropriate trademark/icon for each channel's Channel-Time on-screen display. Icons are available for familiar channels, such as ABC, CBS, NBC, etc. Identifiable icons should enable the end user to readily know what common networks are available.
- **Label:** Press **OK (Enter)** to display the alphanumeric keypad, and add custom text labels for each channel, as desired. Added custom labels will be displayed above the Label/Keypad field for each channel, as applicable.
- **Bank:** Use the arrow keys to define channel banks, as desired. See pages 29 to 32 for further information on channel banks.

When you are finished, press **MENU** to close the pop-up window. Use the arrow keys to select **Next**, and then press **OK (Enter)**.

Note: You can also edit/add channel icons and/or custom text labels in 2-5-4 + MENU Mode after the Express Script is completed, if necessary. See page 28 for further information.

Note: If access to the channel lineup will be limited at the completion of the Express Script (see step 5) and you would like to set up channel banks at a later time, you will need to set Installer Menu item 028 CH. OVERRIDE to 1 to enable access to the Channel Preview/Banks Setup Menu.

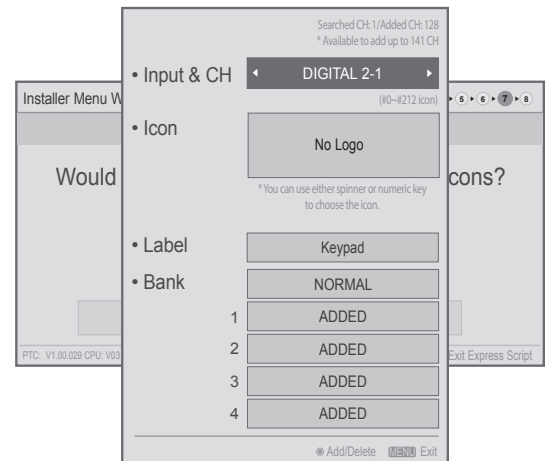
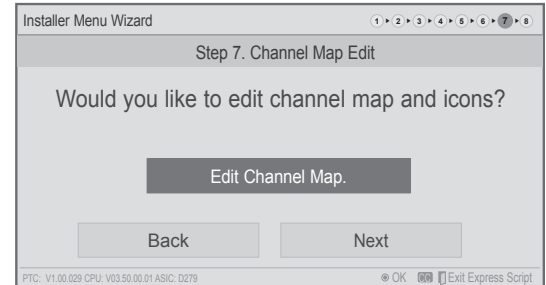

(Continued on next page)

Express Script Installer Menu Wizard (Cont.)

(Continued from previous page)

8. Completion.

In the final step, the TV saves your settings and transfer the setup to the commercial controller (PTC) (similar to 2-5-5 + MENU Mode during Custom Master TV Setup). When this step is complete, the Express Script Installer Menu Wizard closes.

Note: If desired, you can copy the Express Script TV setup created using the Express Script to a cloning tool—a USB memory device or a clone programmer—for transfer to Target TVs. See cloning procedures in this document.

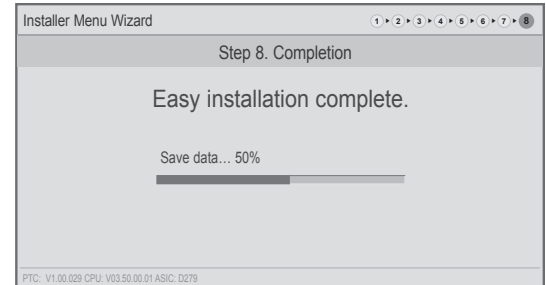

This section describes how to create a customized Master TV Setup for cloning purposes when the TV is in Pass-through Mode.

Note: Cloning requirements and procedures are described in detail on pages 33 to 41. Refer to FTG Mode information on pages 42 to 53 for details on entering FTG Mode and configuring/editing the FTG Channel Map and FTG Installer Menu settings.

Before You Begin

- It is recommended that you disconnect all Aux inputs if you intend to run Auto Tuning (Channel Search). Under certain conditions, Auto Tuning is disabled if there is an Aux input active.
- If not disabled in the Installer Menu, Aux sources will appear in the channel scan between analog and digital channels after the TV setup is transferred to the commercial controller (PTC).
- Determine which cloning tool—USB memory device or clone programmer—is appropriate for your application; several of the Master TV Setup procedure steps are dependent on the cloning tool to be used. See “Cloning Methods” at right for further information.
- If you intend to use a USB memory device, determine the type of file—either the new “.tlx” file format or the legacy “.tll” file format—to use for cloning purposes; several of the Master TV Setup procedure steps are dependent on the desired file type. See “Cloning Methods” at right for further information.
- If the Express Script Installer Menu Wizard appears on the screen, exit the Express Script before beginning/continuing the Custom Master TV Setup procedure.

Cloning Methods

See also “Clonable TV Setup Menu Features” list below.

Using a USB Memory Device / .tlx File

- The .tlx file format clones Installer Menu settings and all TV sources’ (analog, digital, AV1, HDMI, etc.) clonable setup menu settings.
- Not intended for cloning an auto-tuned/edited Channel Map, as the channel lineup is converted to a logical FTG Channel Map when saved (Learned) from a TV to a .tlx file. If the .tlx file with the FTG Channel Map is then used for Teaching purposes, all Target TVs will be configured for FTG Mode via CPU.

Using a USB Memory Device / .tll File

The .tll file format clones the contents of the commercial controller (PTC) memory, including an auto-tuned/edited Channel Map, Installer Menu settings, and one TV source’s (analog, digital, or Aux) clonable setup menu settings.

Using a Clone Programmer (TLL-1100A or LT2002)

Both the TLL-1100A and LT2002 clone the contents of the commercial controller (PTC) memory, including an auto-tuned/edited Channel Map, Installer Menu settings, and one TV source’s (analog or Aux) clonable setup menu settings.

Clonable TV Setup Menu Features

Channel Auto Tuning (Channel Lineup) Manual Tuning Channel Edit Channel Label	Audio Auto Volume Clear Voice Sound Mode Balance TV Speaker	Time Auto Clock Auto Off (Sleep Timer)
Picture Picture Mode		Option Language Caption Power Indicator

Notes:

- Some menu options vary between analog and digital channels and Aux inputs.
- The end user only has access to features that are available on the pillow speaker or the user remote control if provided by the institution.

Custom Master TV Setup (Cont.)

Custom Master TV Setup Procedure

1. Turn ON the TV.

If the Express Script Installer Menu Wizard appears on the screen when you turn ON the TV, use the Up/Down arrow keys on the Installer Remote to select **Exit Express Script**, and press **OK (Enter)**.

2. Set Installer Menu items.

This step provides specific instruction only on the Installer Menu items that should be set on a Master TV. Refer to pages 19 to 27 for detailed information on all Installer Menu items.

- a) Use the Installer Remote to access the PTC Installer Menu (see “Accessing the Installer Menu” on page 19 for further information).

The next step depends on whether the Express Script Installer Menu Wizard appeared when you turned ON the TV:

- If the wizard did appear, the TV is in a factory default state, and you can proceed to set Installer Menu items. Go to step (c).
- If the wizard did not appear, go to step (b).

- b) Set Installer Menu item **117 FACT DEFAULT** to **1** and press **OK (Enter)** on the Installer Remote.

This clears all Installer Menu custom settings, channel lineup, etc. and restores the factory default settings. The value will change back to 0 after the PTC has been restored to factory default condition. This step ensures that the TV Channel Memory will be the active channel lineup.

- c) Set Installer Menu item **003 BAND/AFC**, as appropriate.
- Broadcast: Set to 0.
 - CATV: Set to 1 (default).
 - HRC: Set to 2.
 - IRC: Set to 3.
- d) Set Installer Menu item **027 HOSPITAL MODE**, as appropriate, to select the speaker configuration.
- e) Set any other Installer Menu items that affect your TV programming network to the required configuration. For example, enable/disable Aux inputs, set a Start Channel, etc.
- f) After you have adjusted all Installer Menu item settings as required, press **OK (Enter)** once on the Installer Remote to save your changes; then, press **OK (Enter)** again to exit the menu.

Note: If you performed step (b) above to restore factory defaults, the Express Script Installer Menu Wizard will re-activate as soon as you exit the Installer Menu. Exit the wizard (see step 1), and then continue with step 3.

3. Set up TV features.

On-screen setup menus control the features of the TV. Press **MENU** on the Installer Remote to access the TV setup menus, and then set Channel, Picture, Audio, Time, etc. options to the desired configurations. See “Clonable TV Setup Menu Features” list on previous page and also notes on the following page.

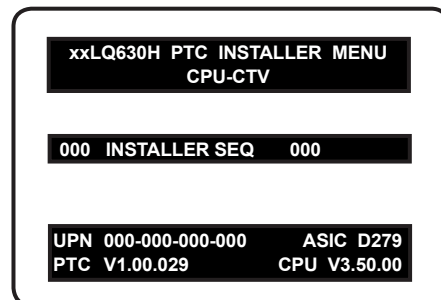

Typical Installer Menu

Note: The Installer Menu header will vary depending on the TV you are setting up.

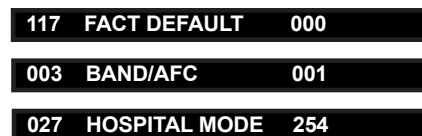

Adjust the values for these Installer Menu items.

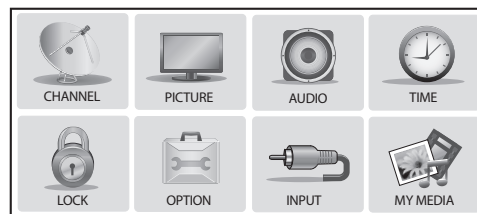

Use the TV setup menus to set the TV features to the desired configuration for the end user.

Audio Menu Note: Audio Menu options are inaccessible (grayed out) if TV Speaker is not selected (i.e., Pillow Only is selected).

(Continued on next page)

(Continued from previous page)

Note: If you intend to clone the PTC, remember that only one TV source's clonable setup menu settings will be cloned. Thus, for a clone programmer, the TV setup menu settings should be applicable to either an analog channel or Aux input, while for a USB device / .tll file, the TV setup menu settings should be applicable to the analog or digital channel or Aux input to which the Target TV will be set during the Teaching process.

Note: If desired and if appropriate depending on the cloning method to be used (see "Cloning Methods" on page 15), you can run Auto Tuning (see step 3) prior to completing this step.



Note: The next three steps (4 to 6) are applicable for PTC cloning only (i.e., cloning using a USB memory device / .tll file or clone programmer). If you intend to use a USB memory device / .tll file for cloning purposes, proceed directly to step 7 to verify the TV setup.

4. (PTC cloning only / Optional) Run Auto Tuning.

Note: If you run Auto Tuning with the intention to clone the resulting Channel Map, you MUST use a USB memory device / .tll file or a clone programmer for this cloning purpose. If you Teach a .tll file with an auto-tuned/edited Channel Map to a Target TV, this will put the Target TV in FTG Mode via CPU.

- a) To search for all available analog and digital channels, go to the Channel Menu, select the **Auto Tuning** option, and follow the on-screen instructions.
- b) Use the **Channel Edit** option in the Channel Menu to edit the channel lineup, as necessary, to include only free to guest (non-encrypted) channels.
 - Add/delete channels per your system requirements.
 - Use the **Channel Label** option in the Channel Menu to select the appropriate trademark/icon for each channel's Channel-Time on-screen display. Icons are available for familiar channels, such as ABC, CBS, NBC, etc. Identifiable labels (icons) should enable the end user to readily know what common networks are available.

Note: If Installer Menu item 103 ATSC TUNE MODE is set for Physical Channel tuning (default and recommended setting), channels with minor channel numbers higher than 255 will not transfer correctly in step 5. If item 103 is set for Virtual Channel tuning and either the major or minor channel numbers are higher than 255, the channel(s) will not transfer correctly in step 5.

Note: You can add the channel icons in this step or as described in step 6. Also in step 6, you can add custom text labels for channels without icons.

5. (PTC cloning only) Transfer the TV setup menu settings to the commercial controller (PTC): 2-5-5 + MENU Mode



Note: This step is essential for successful cloning using a USB memory device / .tll file or a clone programmer. Without this step, the PTC will not contain any of the TV setup menu settings.



Use Channel Menu options to run Auto Tuning, edit channels, and select channel icons.

(Continued on next page)

Custom Master TV Setup (Cont.)

(Continued from previous page)



Note: The maximum number of channels (analog, digital, and Aux inputs) that can be transferred to the PTC is 141. An attempt to transfer more than 141 channels of any combination will result in a PTC Channel Map of exactly 141 channels; any extra channels will not be available in the PTC Channel Map. For example, if you enabled three Aux inputs in the Installer Menu and Auto Tuning found 141 channels, you must edit the TV channel lineup to decrease the number of analog/digital channels to (at most) 138 in order to accommodate the Aux inputs in the PTC Channel Map.

- a) After the TV channel lineup has been edited and channel label icons added, tune to the channel (source) for which you wish to transfer TV setup menu settings.
Note: If you intend to use a clone programmer for cloning purposes, this must be either an analog channel or Aux input.
- b) Access the Installer Menu, and press **2-5-5 + MENU** on the Installer Remote to initiate the transfer of the Master TV Setup to the PTC. The TV exits the Installer Menu and then tunes through the channels in the channel lineup during the transfer. When the transfer is complete, the TV tunes back to the channel that was tuned before the transfer began.

Note: Scan Mode is not functional until the TV setup is transferred.

6. (PTC cloning only / Optional) Add Custom Channel and Aux Input

Labels: 2-5-4 + MENU Mode

Note: 2-5-4 + MENU Mode enables you to add/edit channel icons and custom text labels in the PTC once the Master TV Setup has been transferred as described in the previous step.

Access the Installer Menu, and press **2-5-4 + MENU** on the Installer Remote. Add/edit custom text labels and/or change icons for the Channel-Time on-screen displays (see 2-5-4 + MENU procedural information on page 28). Note that broadcast digital channels often already have a broadcaster generated label. When you are finished, press **MENU** to exit 2-5-4 + MENU Mode.

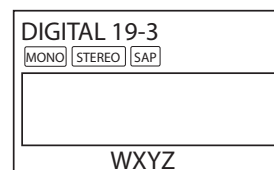

Custom Text Label "WXYZ" created in 2-5-4 + MENU Mode.

7. Verify the TV setup.

Make sure the TV features are set per your requirements. Also, if cloning the PTC, verify that the channel lineup, channel icons, and custom text labels are correct.

8. Set up channel banks.

Set up channel banks, as desired (see pages 29 to 32).

Note: When you lock the channel lineup (see next step), the Channel Preview/Banks Setup Menu is no longer accessible via the Installer Remote. If you wish to set up channel banks at a later time, you will need to set Installer Menu item 028 CH. OVERRIDE to 1 to enable access to the Channel Preview/Banks Setup Menu.

9. (Recommended) Lock the channel lineup.

Access the Installer Menu. Set item **028 CH. OVERRIDE** to **0** and press **OK (Enter)** to lock the channel lineup and restrict access to the TV setup menus. Press **OK (Enter)** again to save your changes and exit the Installer Menu. *

The Master TV Setup is now ready to be copied to the predetermined cloning tool—a USB memory device or a clone programmer. See cloning procedures in this document.

028 CH. OVERRIDE 000

After verifying the TV Setup, set Installer Menu item 028 CH. OVERRIDE to 0.*

* This step prevents end users from accessing channel settings (i.e., the Channel Menu will be inaccessible/grayed out).

Use the Installer Menu to set up, change, or view operational settings. This section describes how to access, use, and exit the Installer Menu from the TV itself; however, you should also refer to the Installer Menu descriptions in this document if you are configuring the TV using LG's FTG configuration software.

Refer to the table on pages 21 and 22 for brief descriptions of Installer Menu items. More detailed descriptions follow the table listing.

Accessing the Installer Menu

1. Turn ON the TV.

If the Express Script Installer Menu Wizard appears on the screen when you turn ON the TV, use the Up/Down arrow keys on the Installer Remote to select **Exit Express Script**, and press **OK (Enter)** to exit the wizard.

2. Using an Installer Remote, press **MENU** repeatedly until the on-screen display of the TV setup menus (if the TV is in Pass-through Mode) or the Function Menu (if the TV is not in Pass-through Mode) no longer toggles, and then press the Installer Menu entry sequence (e.g., **9-8-7-6**) + **OK (Enter)** to access the Installer Menu.

Note: The default Installer Menu entry sequence is "9876;" however, if Installer Menu item 000 INSTALLER SEQUENCE has been modified, the entry sequence may be one of three additional options. See Installer Menu detailed descriptions for further information.

The Installer Menu opens with item 000 INSTALLER SEQ 000.

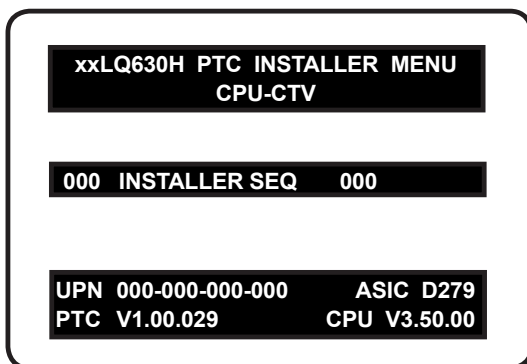

Typical Installer Menu

Note: The Installer Menu header will vary depending on the TV you are setting up.

Note: If the password (entry sequence) is not entered or registered correctly, you will see the message "ENTER PASSWORD 0000" at the top of the screen instead of the Installer Menu header. Once you re-enter the correct password (e.g., press 9-8-7-6 + OK [Enter]), the Installer Menu will display.

Note: If the TV is not in Pass-through Mode, the Installer Menu is accessible as read-only.

Installer Menu (Cont.)

As part of the Installer Menu header (in all modes), two 3-character acronyms are displayed to indicate the TV's current configuration mode. The table below lists all possible mode identifiers for these TV models.

Acronym	Description
CPU-CTV	Pass-through Mode with Channel Map in CPU
CPU-FTG	FTG Mode via CPU
CPU-P:C	Application Tuning Mode via CPU
EBL-FTG	FTG Mode via EBL
EBL-LNT	LodgeNet PPV Mode
MPI-EXT	External MPI Control
PTC-CTV	Pass-through Mode with Channel Map in PTC

Using the Installer Menu

Refer to the table starting on the next page for an overview of the available Installer Menu items, including their item numbers, functions, value ranges, and default values.

Installer Menu items not relevant to these TV series are not present in the Installer Menu; therefore, some numbers are missing. For example, item 006 will not appear. In addition, items that are dependent on other Installer Menu item settings will not be initially accessible. For example, item 046 STRT AUX SRCE will not display in the Installer Menu unless item 004 STRT CHANNEL is set to 0.

Navigation within the Installer Menu

Use the Up/Down arrow keys on the Installer Remote to sequence through the available menu items, or access an item directly by keying in the item number and then pressing **MENU**. For example, to access the SLEEP TIMER option, which is item 015, press 0-1-5 + MENU.

Changing Installer Menu Settings

To change an Installer Menu item value, use the Left/Right arrow keys on the Installer Remote, or enter a valid value directly. To save the new setting, press **OK (Enter)**, or use the Up/Down arrow keys to navigate to a new Installer Menu item if you have additional items to edit. Note that invalid values will not be saved.

Exiting the Installer Menu and Activating Settings

After you have adjusted all Installer Menu item settings as required, press **OK (Enter)** once on the Installer Remote to save your changes; then, press **OK (Enter)** again to exit the Installer Menu. Any changes you make will be stored in non-volatile memory.

Note: Each time you exit the Installer Menu in Pass-through Mode, all V-Chip (Parental Control) settings in the TV are reset to their default values; that is, the Lock System, if previously enabled from the Lock setup menu (see the Owner's Manual for additional information), will now be disabled, and the individual Parental Control settings will be restored to default values.



Caution: Installer Menu settings may affect options available from the TV setup menus or the Function Menu.

Installer Menu (Cont.)

Installer Menu Items 000 through 070

Menu Item	Function	Value Range	Default Value	Brief Description of Function
000	INSTALLER SEQ	0 ~ 3	0	Leave default set to 0.
001	POWER MANAGE	0 ~ 7	0	Sets number of hours of no activity before automatic shutoff.
002	AC ON	0 / 1	0	Set to 1 to enable TV to turn ON when AC power is applied.
003	BAND/AFC	0 ~ 3	1	Selects Tuning Band: 0=Broadcast, 1=CATV, 2=HRC, 3=IRC
004	STRT CHANNEL	0 ~ 127, 255	255	Channel tuned when TV is turned ON. (Set to 255 to tune to channel tuned before TV turned OFF.)
005	CHAN LOCK	0 / 1	0	If set to 1, cannot tune from current channel.
007	STRT VOLUME	0 ~ 63, 255	255	Volume level when TV is turned ON. (Set to 255 to use volume level before TV turned OFF.)
008	MIN VOLUME	0 ~ 63	0	Sets minimum allowable volume setting.
009	MAX VOLUME	0 ~ 63	63	Sets maximum allowable volume setting.
010	MUTE DISABLE	0 / 1	0	Set to 1 to disable Mute Function.
011	KEY DEFEAT	0 / 1	1	If set to 1, menu navigation buttons on display panel are not functional.
012	IR BANKS EN.	0 / 1	0	Set to 1 to enable TV to respond to bank discrete IR codes.
013	SCAN MODE	0 / 1	1	Set to 1 to allow Channel Up/Down to turn ON TV. (See detailed descriptions.)
014	STRT CH IN SM	0 / 1	0	Set to 1 to use the Start Channel for the Channel Map pivot point in Scan Mode.
015	SLEEP TIMER	0 / 1	1	Set to 1 to enable Sleep Timer.
016	EN TIMER	0 / 1	1	Set to 1 to enable On/Off Timers.
017	ALARM	0 / 1	1	Set to 1 to enable Alarm.
020	FEATURE LEVEL	0 ~ 1, 16 ~ 24, 64 ~ 65	1	Determines an additional IR code scheme to which the TV will respond.
021	V-CHIP	0 / 1	1	Set to 1 to enable V-Chip (Parental Control) functions.
022	MAX BLK HRS	0 ~ 99	12	Sets number of V-Chip blocking hours.
023	CAPTION LOCK	0 / 1	0	Set to 1 to retain caption setting before TV turned Off.
025	FUNCTION PRE.	0 ~ 1	1	Set to 1 to allow Channel Preview/Banks Setup Menu access via CH PREVIEW key on Installer Remote.
027	HOSPITAL MODE	0 ~ 162, 254	254	Set according to the speaker selection, the pillow speaker code/supply voltage, and the hospital IR code. See detailed instructions.
028	CH. OVERRIDE	0 / 1	1	If set to 0, limits direct access to favorite channels.
029	OLD OCV	0 / 1	0	Set to 1 to change MPI operation to OCV.
030	ACK MASK	0 / 1	0	If set to 1, enables ACK feature of MPI.
031	POLL RATE	20 ~ 169	94	Selects poll rate for MPI.
032	TIMING PULSE	186 ~ 227	207	Sets baud rate for MPI.
035	COMPPOINT EN. *	0 / 1	1	Set to 0 to disable HDMI 1. Set to 1 enable HDMI 1.
039	REAR AUX EN	0 / 1	1	Set to 1 to enable display panel Video 1 input jack.
046	STRT AUX SRCE	1, 3 ~ 5, 255	255	Sets the starting Aux source (if item 004 STRT CHANNEL is set to 0).
047	AUX STATUS	0 / 1	0	Set to 1 for MPI Aux source to be reported as a channel number instead of Channel 0.
053	DIS. CH-TIME	0 / 1	0	Set to 1 to disable Channel-Time display.
069	EN. CH-T COL.	0 / 1	1	Set to 1 to enable custom color for the Channel-Time display.
070	FOR. CH-TIME	0 ~ 7	2	Chooses custom foreground color for the Channel-Time display.

* HDMI1 ENABLE for LQ630H/CQ610H TVs with PTC v1.00.029 or later.

Installer Menu (Cont.)

Installer Menu Items 071 through 122

Menu Item	Function	Value Range	Default Value	Brief Description of Function
071	BCK. CH-TIME	0 ~ 7	2	Chooses custom background color for the Channel-Time display.
073	CH NOT AVBLE	0 / 1	0	If set to 1 and item 028 CH. OVERRIDE is set to 0, "NOT AVAILABLE" message is displayed if user direct tunes a channel that is not in the favorite channel list.
075	REVERT CH	0 / 1	0	If set to 1 and loss of MPI communication occurs, TV tunes to Start Channel.
077	QUICK SHUTOFF	0 ~ 17	0	Allows TV to be turned OFF with press and hold of pillow speaker channel buttons. Set to 0 to disable. Set from 1 to 17 to define hold time. (See detailed descriptions.)
078	UPN MSB	0 ~ 255	255	User programmable number, most significant byte.
079	UPN MSB-1	0 ~ 255	255	User programmable number, most significant byte - 1.
080	UPN MSB-2	0 ~ 255	255	User programmable number, most significant byte - 2.
081	UPN LSB	0 ~ 255	255	User programmable number, least significant byte.
082	CHKSM ERROR	0 / 1	1	If set to 1, enforces rigid MPI checksum.
083	HANDSHK TIME	0 ~ 5	5	Relaxes MPI timing to be compatible with PC-based Windows-controlled systems.
084	PERMANENT BLK	0 / 1	0	Removes block hours setting for Parental Control and makes block permanent.
087	REAR RGB EN.	0/1/17	1	Set to 0 to disable RGB input. Set to 1 to enable RGB input. Set to 17 for Auto Configure.
088	EN NOISE MUTE	0 / 1	1	If set to 1, audio is muted if no signal is present.
090	KEY LOCK	0 / 1	0	If set to 1, display panel buttons are locked. IR is still functional.
091	YPrPb2 EN. *	0 / 1	1	Set to 0 to disable HDMI 2. Set to 1 to enable HDMI 2.
094	SAP MENU EN	0 / 1	1	Set to 0 to disable feature on Function Menu. Set to 1 to enable feature on Function Menu.
096	DEF. ASP. RATIO	0 ~ 4	2	Sets default aspect ratio at power up. See detailed descriptions and item 106.
097	AUDIO OUTPUT **	0 ~ 8	0	Set as required in accordance with external audio equipment connected to the TV. See detailed descriptions.
098	PRO:CENTRIC	0 ~ 2	0	Set to 0 to disable Pro:Centric operation. Set to 1 for Flash Mode. Set to 2 for GEM (Java Application) Mode.
099	BACK LIGHTING	1 ~ 202, 255 ***	255 (LQ630H) 100 (CQ610H)	Sets the level of the TV picture back lighting. (See detailed descriptions.)
102	ATSC BAND	0 ~ 4	4	Selects ATSC band.
103	ATSC TUNE MODE	0 / 1	1	Set to 1 (default) for Physical Channel scan. Set to 0 for Virtual Channel scan.
104	START MINOR CH	0 ~ 255	0	Selects Minor Start Channel. Set to 0 for NTSC.
106	ASP RATIO LOCK	0 / 1	0	To retain set aspect ratio on power cycle, set to 1. Set to 0 for default ratio on power cycle.
116	VIDEO MUTE EN	0 / 1	0	Set to 0 for Normal. Set to 1 for Blank.
117	FACT DEFAULT	0 / 1	0	Set to 0 for Normal. Set to 1 to load presets for all Installer Menu settings.
118	POWER SAVINGS	1, 3, 7	3	Determines the powered status of the embedded b-LAN module and the GAME CONTROL/MPI port. (See detailed descriptions.)
119	DATA CHANNEL	0 ~ 135	0	Set to 0 to disable. Set from 1 to 135 to match the RF channel number used by the Pro:Centric server as its data channel. (See detailed descriptions.)
121	P:C RF WAKE HR	0 ~ 23, 128	128	Sets the hour for Wake On RF. The value "128" is displayed as "OFF." Directly entering 128 turns the Wake On RF feature OFF.
122	P:C RF WAKE MN	0 ~ 59	0	Sets the minute for Wake On RF.

* HDMI2 ENABLE for LQ630H/CQ610H TVs with PTC v1.00.029 or later.

** Applicable for LQ630H/CQ610H TVs with CPU v3.50.00 and PTC v1.00.029 or later. *** 201, 202, 255 applicable for LQ630H TVs only.

Detailed Descriptions of Installer Menu Items

000 - INSTALLER SEQUENCE

Specifies entry sequence to the Installer Menu.

0 = 9876 1 = 4321
2 = 1478 3 = 3698

001 - POWER MANAGE (Power Management)

Determines hours of no activity before automatic shutoff. The Power Management function is for saving energy. If set to 0, Power Management is Off. Settings range from 0 ~ 7, with 1 ~ 7 representing the hours that the unit will remain ON, unless there has been activity from either the control panel or remote control.

002 - AC ON (AC Power Switchable)

If set to 1, this allows the TV to turn ON when AC power is applied. Pressing the POWER button is not necessary. This is desirable if the TV is plugged into a switched AC outlet (i.e., a set-top box). Set to 0 (default) for standard TV turn ON/OFF operation.

Note: If set to 1, the TV does not respond to ON/OFF commands from either the remote or the display panel, and the SLEEP TIMER is also nonfunctional.

003 - BAND/AFC (Band/Automatic Frequency Control)

There are four possible settings for this option:

0 = Broadcast 1 = CATV (default)
2 = HRC 3 = IRC

If some channels were not found by Auto Tuning (Channel Search), select the appropriate Band setting here, and add the channels using the Channel Edit option in the Channel Menu.

004 - STRT CHANNEL (Start Channel)

If active, this function allows you to determine the initial Major Start Channel number when the TV is turned ON. This feature is useful for an in-house information channel, since the TV would always select that channel when it is turned ON. If set to 255, the last channel tuned before the TV was turned OFF will be the channel tuned when the TV is turned ON again.

0 = Aux 127 = Map to Major CH 4
1 ~ 125 = Major CH # 255 = Last Channel
126 = Map to Major CH 3

Note: For a digital Start Channel, always remember to set item 104 to the Minor Start Channel number.

Note: 126 and 127 are mapped only in LodgeNet PPV Mode.

005 - CHAN LOCK (Channel Lock)

Channel Lock is ideal if the system must always be on the same channel. Changing channels with the Channel Up/Down or keypad numbers is impossible. Channel Lock is inactive if set to 0 (default).

Generally, this feature is used in connection with item 004 STRT CHANNEL where the Start Channel may, for example, be set to 3 or 4. If the Start Channel is 3, then the TV will remain locked on channel 3.

NOTE: For items 007, 008, and 009

For legacy reasons, the scale used is 0 - 63. The PTC software will translate this to the 0 - 100 scale used by the TV.

To translate a TV volume level to the Installer Menu value, use the following formula:

$$\text{Installer Value} = \frac{\text{TV Value} \times 63}{100}$$

Enter only the whole number (disregard fractions).

007 - STRT VOLUME (Start Volume)

This function allows the Installer to determine the initial volume level setting when the TV is turned ON. This feature is useful for an in-house information channel, since the TV will always select that volume level when it is turned ON. The range of values is 0 to 63, 255. If set to 255, the last volume level before the TV was turned OFF will be the current volume level when the TV is turned ON again.

008 - MIN VOLUME (Minimum Volume)

This function determines the minimum volume level allowable with the Volume (VOL) Up/Down control. In this way, for example, someone cannot set the volume too low to hear. The value range is from 0 to 63. The factory default is 0, which provides the full range of volume control, if item 009 MAX VOLUME is set to 63. It is recommended to set the same value on every TV.

Note: The minimum volume level cannot have a value setting higher than the maximum volume level (described below).

009 - MAX VOLUME (Maximum Volume)

This function determines the maximum volume level allowable with the Volume (VOL) Up/Down controls. In this way, for example, someone cannot set the volume level high enough to disturb others. The value range is 0 to 63, with 63 as the default, which gives the user the full range of volume control, if item 008 MIN VOLUME is set to 0. It is recommended to set the same value on every TV.

Note: The maximum volume level cannot have a value setting lower than the minimum volume level (described above).

010 - MUTE DISABLE

Enables or disables sound mute function. If set to 1, sound cannot be muted. If set to 0, sound can be muted.

011 - KEY DEFEAT

If set to 1, Key Defeat is enabled, which means that end users cannot access or navigate within the on-screen menu(s) from the display front panel, i.e., MENU, OK/ENTER, and menu navigation buttons on the display panel will not function. Set to 0 to disable Key Defeat. Note that all IR features remain functional regardless of this setting.

Installer Menu (Cont.)

012 - IR BANKS EN (IR Banks Enable)

For direct access to a particular channel bank. When enabled, you can access a channel bank by inputting the discrete IR code for that bank.

Note: This item is not available in the Installer Menu when item 027 HOSPITAL MODE is set to 0.

013 - SCAN MODE (Functional after 2-5-5 + MENU transfer of Channel Map)

When set to 1 (default), allows TV to be turned ON when Channel Up/Down buttons are pressed on pillow speaker. Also, TV will turn OFF when Channel Up/Down key is used to tune above or below Channel Map pivot point. By default, Channel Map pivot point is between the highest and lowest channel in the Channel Map (also see item 014 STRT CH IN SM). Set to 0 to disable.

014 - STRT CH IN SM (Start Channel in Scan Mode)

Only valid when item 013 SCAN MODE is set to 1 (enabled). When set to 1, forces Channel Map pivot point to be between the RF channel designated in item 004 STRT CHANNEL and next lower channel in the Channel Map. Set to 0 to disable (default).

Note: This item is not available in the Installer Menu when item 013 SCAN MODE is set to 0.

015 - SLEEP TIMER

If set to 1, the Sleep Timer feature may be used. If set to 0, the Sleep Timer is not available.

016 - EN TIMER (Enable On/Off Timers)

If set to 1, the Timer function is available to the end user and enabled continuously. Set to 0 to disable On/Off timers.

Note: The TV clock must be set in order for timers to be used.

017 - ALARM

Gives the installer the option of making the Alarm function available to the end user. If set to 1, the Alarm function is available to the end user. Set to 0 to disable the Alarm function.

Note: The TV clock must be set before the Alarm function will work.

020 - FEATURE LEVEL

This function determines an additional IR code scheme to which the TV will respond, allowing for the use of unique IR codes based on "bed number" in a multi-TV single room installation. First determine the IR mode; then select the bed number.

Note: Item 027 HOSPITAL MODE must be set to 0 to enable Legacy Zenith Bed 1 or Bed 2 IR codes and Speaker selections.

Values	IR Mode	Bed #	Speaker
0–1	Legacy Zenith (Hospital)	1–2	TV
16–24	Multi-code Remote	1–9	TV
64–65	Legacy Zenith (Hospital)	1–2	Pillow

Note: For further information, see documentation for the accessory package that includes the multi-code remote.

021 - V-CHIP (Parental Control)

Set to 1 to activate V-Chip (Parental Control) and have it available to the end user to filter and control or otherwise restrict programming content that can appear. Set to 0 to turn the V-Chip feature Off (not available to user); no programming restrictions can be set.

022 - MAX BLK HRS (Maximum Block Hours)

Sets hours from 0 to 99 for the maximum V-Chip (Parental Control) block hours. Default setting is for 12 blocking hours.

Note: This item is not available in the Installer Menu when item 084 PERMANENT BLK is set to 1.

023 - CAPTION LOCK

If set to 0, captions are OFF when the TV is turned ON. Set to 1 to use the caption setting configured before the TV was turned OFF when the TV is turned ON.

025 - FUNCTION PRE (Function Preview)

Set to 1 to allow access to the Channel Preview/Banks Setup Menu via the CH PREVIEW key on Installer Remote. Set to 0 to disable access to the Channel Preview/Banks Setup Menu.

027 - HOSPITAL MODE

Set according to the speaker selection, the pillow speaker code/ supply voltage and the hospital IR code. If using a Pro:Centric pillow speaker, select one of the Zenith codes in accordance with the desired speaker selection. See table below.

Value	Speaker	Pillow Speaker Code/Voltage	Hospital IR Code
000	Determined by item 020 setting	Zenith (+12v)	Determined by item 020 setting
001	Pillow Only	Zenith (+12v)	Zenith Bed #1
002	Pillow Only	Zenith (+12v)	Zenith Bed #2
017	Pillow Only	Philips (+5v)	Zenith Bed #1
018	Pillow Only	Philips (+5v)	Zenith Bed #2
033	Pillow Only	RCA (-5v)	Zenith Bed #1
034	Pillow Only	RCA (-5v)	Zenith Bed #2
065	TV Only	Zenith (+12v)	Zenith Bed #1
066	TV Only	Zenith (+12v)	Zenith Bed #2
081	TV Only	Philips (+5v)	Zenith Bed #1
082	TV Only	Philips (+5v)	Zenith Bed #2
097	TV Only	RCA (-5v)	Zenith Bed #1
098	TV Only	RCA (-5v)	Zenith Bed #2
129	Both Pillow & TV	Zenith (+12v)	Zenith Bed #1
130	Both Pillow & TV	Zenith (+12v)	Zenith Bed #2
145	Both Pillow & TV	Philips (+5v)	Zenith Bed #1
146	Both Pillow & TV	Philips (+5v)	Zenith Bed #2
161	Both Pillow & TV	RCA (-5v)	Zenith Bed #1
162	Both Pillow & TV	RCA (-5v)	Zenith Bed #2
254	TV Only	Disabled (0v)	Zenith Bed #2

When Hospital Mode is enabled and the TV is in Pass-through Mode, channel banks are also available. Refer to channel banks information in this document for further details.

Channel banks are not supported if Hospital Mode is set to 0 or on TVs that are configured for FTG Mode operation.

When Hospital Mode is set to 0 (disabled), both the IR code that will control the TV and the speaker selection depend on the Installer Menu item 020 FEATURE LEVEL setting.

Note: The default setting (254) is not selectable in the Installer Menu. If you ever need to restore the default setting, you must set item 117 FACT DEFAULT to 1 to reload the factory default settings. See item 117 description for further information.

Note: In the Installer Menu, an informational code is displayed at the right of each Hospital Mode value. Each code consists of three characters. The first character—T, P, or B—identifies the speaker: TV, Pillow, or Both. The second character—Z, P, R, or D—identifies the pillow speaker code: Zenith, Philips, RCA, or Disabled. The third character—1 or 2—identifies the bed number. In the table on the previous page, each bolded character represents an element of the Hospital Mode code.

028 - CH. OVERRIDE (Channel Override)

If set to 1, the user can select channels with either Channel Up/Down or by direct keypad entry. If set to 0, only those channels that are active in the TV's memory can be selected.

029 - OLD OCV (On Command Video™)

Set to 1 to remap the PTC's direct tune channels for Aux inputs from 13x to 9x. This allows 2-digit only tuning systems (i.e., legacy OCV) to direct tune Aux inputs. See also Reference section, "TV Aux Input Configuration."

030 - ACK MASK

MPI Communication Parameter. When set to 1, enables ACK feature of MPI.

031 - POLL RATE

MPI Communication Parameter. Selects poll rate for MPI. Step size of 16 ms. Changing from default may affect communication via MPI.

032 - TIMING PULSE

MPI Communication Parameter. Sets baud rate for MPI. Step size of 4.3 uS. Changing from default may affect communication via MPI.

035 - COMPPORT EN. (HDMI1 ENABLE)

Set to 1 to enable display panel HDMI 1 input. Set to 0 to disable display panel HDMI 1 input.

039 - REAR AUX EN. (Rear Aux Enable)

Set to 1 to enable display panel rear Aux (Video 1) input. Set to 0 to disable display panel rear Aux (Video 1) input.

046 - STRT AUX SRCE (Start Aux Source)

Sets the starting Aux source. When turned ON, the TV will tune to starting Aux source if item 004 STRT CHANNEL is set to 0.

1 = Video 1 4 = RGB 255 = Last Aux
3 = HDMI 1 5 = HDMI 2

Note: Above is applicable only if all Aux sources are enabled.

Note: This item is not available in the Installer Menu unless item 004 STRT CHANNEL is set to 0.

047 - AUX STATUS

Set to 1 for MPI Aux source to be reported as a channel number instead of channel 0. Set to 0 to disable Aux identification change. Controls MPI status channel response for Aux inputs.

053 - DIS. CH-TIME (Disable Channel-Time)

Set to 1 to disable the Channel-Time display; Channel-Time display will not appear. Set to 0 to enable the Channel-Time display.

069 - EN. CH-T COL. (Enable Channel-Time Custom Color)

Set to 1 to enable custom color for the Channel-Time display. Set to 0 to disable custom color for the Channel-Time display.

070 - FOR. CH-TIME (Channel-Time Display Foreground Color)

Set according to Color Chart:

0 = Black 3 = Cyan 6 = Yellow
1 = Blue 4 = Red 7 = White
2 = Green 5 = Violet

Note: If foreground color and background color are the same, the menu background will be transparent.

Note: Applies only to "Channel Not Available" message if item 073 CH NOT AVBLE is set to 1 (enabled). Also, items 070 FOR. CH-TIME and 071 BCK. CH-TIME are not available in the Installer Menu when item 069 EN. CH-T COL. is set to 0.

071 - BCK. CH-TIME (Channel-Time Display Background Color)

See description for item 070 FOR. CH-TIME above. The color chart is the same for both items.

073 - CH NOT AVBLE (Channel Not Available)

If set to 1 and item 028 CH. OVERRIDE is set to 0, a "NOT AVAILABLE" message is displayed when a user direct tunes a channel that is not in the channel scan list available in memory.

Note: This item is not available in the Installer Menu when item 028 CH. OVERRIDE is set to 1.

075 - REVERT CH (Revert to Start Channel)

If set to 1 and loss of MPI communication occurs, TV automatically tunes to the specified Start Channel.

Note: This item is not available in the Installer Menu when item 004 STRT CHANNEL is set to 255.

Installer Menu (Cont.)

077 - QUICK SHUTOFF

Allows end user (patient) to turn OFF TV using mechanical (analog) Pillow Speaker Channel Up/Down buttons. Patient needs to press and hold either channel button for time determined by value set. Set to 0 to disable. Set from 1 to 17 to establish required hold time of button—from 2 seconds to 10 seconds in half-second increments.

Note: This item is not available in the Installer Menu when item 013 SCAN MODE is set to 0.

078 - UPN MSB (UPN Most Significant Byte)

User programmable number, most significant byte readable by MPI command. Note: Not linked to serial number.

079 - UPN MSB-1 (UPN Most Significant Byte-1)

User programmable number, most significant byte-1 readable by MPI command. Note: Not linked to serial number.

080 - UPN MSB-2 (UPN Most Significant Byte-2)

User programmable number, most significant byte-2 readable by MPI command. Note: Not linked to serial number.

081 - UPN LSB (UPN Least Significant Byte)

User programmable number, least significant byte readable by MPI command. Note: Not linked to serial number.

082 - CHKSM ERROR (Checksum Error)

Enforces rigid MPI checksum validation. Set to 1 for validation. Set to 0 to disable (does not check checksum on MPI async port). SPI is always checked.

083 - HANDSHK TIME (Handshake Time)

Adds an additional delay to the handshake time which is 64 msec, thus relaxing MPI timing requirements to be compatible with PC-based Windows controlled systems. Range is 0 - 5. (Timeout = 25.5MS + [25.5 MS* Handshake time].)

084 - PERMANENT BLK (Permanent Block)

Allows Lock (Parental Control) blocking schemes to be permanent by disabling the blocking hours function. Set to 1 to install Parental Control restrictions permanently. Set to 0 for user-specified hours control of blocking schemes.

087 - REAR RGB EN. (Rear RGB Enable)

Controls access to rear RGB input on TV. Set to 0 to disable RGB input. Set to 1 to enable RGB input. Set to 17 to initiate a one-time automatic configuration after an AC power cycle; otherwise, automatic adjustment will be performed each time the RGB input is accessed.

088 - EN NOISE MUTE (Enable Noise Mute)

If set to 1, audio mutes when no signal is present.

090 - KEY LOCK

If set to 1, Key Lock is enabled, which means that all display panel buttons will be locked, i.e., non-functional. Set to 0 to disable Key Lock. Note that all IR features remain functional regardless of this setting.

091 - YPrPb2 EN. (HDMI2 ENABLE)

Set to 1 to enable display panel HDMI 2 input. Set to 0 to disable display panel HDMI 2 input.

094 - SAP MENU EN (2nd Audio Program)

Set to 1 to enable SAP feature on Function menu, if Function Menu is available (i.e., the TV is not in Pass-through Mode). Set to 0 to disable SAP feature on Function Menu, if Function Menu is available.

096 - DEF. ASP. RATIO (Default Aspect Ratio)

Selects default aspect ratio at power up.

- Set to 0 for Set By System.
- Set to 1 for 4:3.
- Set to 2 for 16:9 (default).
- Set to 3 for Just Scan.
- Set to 4 for Zoom.

Note: This item is not available in the Installer Menu unless item 106 ASP RATIO LOCK is set to 0.

097 - AUDIO OUTPUT

Determines availability and level (fixed speaker or variable speaker) of the mono audio output intended to drive a single 8 ohm speaker connected to the Speaker Out jack on the TV. Set to 0 to disable audio output. Otherwise, see the table below and set as application requires.

Value	Status
1	Fixed 0.01 Watts
2	Fixed 0.03 Watts
3	Fixed 0.05 Watts
4	Fixed 0.10 Watts
5	Fixed 0.20 Watts
6	Fixed 0.50 Watts
7	Fixed 1.00 Watt (default)
8	Control with volume

See also Reference section, "External Mono Speaker Setup."

Note: This item is applicable for LQ630H/CQ610H TVs with CPU v3.50.00 and PTC v1.00.029 or later.

098 - PRO:CENTRIC

Selects the Pro:Centric Application Mode. Set to 0 (default) to disable Pro:Centric operation. Set to 1 for Flash Mode. Set to 2 for GEM (Java Application) Mode.

The TV must be turned OFF for a few seconds to initiate the Pro:Centric application download. When it is turned OFF for a second time, the TV will load the Pro:Centric application.

Note: This item is not available in the Installer Menu when item 119 DATA CHANNEL is set to 0.

099 - BACK LIGHTING

Sets the TV screen brightness at power up. Default setting is 255 for LQ630H TVs and 100 for CQ610H TVs.

- 1 (dimpest picture)– 100 (brightest picture) Static Back Lighting
- 101 (dimpest picture)– 200 (brightest picture) Dynamic Back Lighting: The TV automatically controls back lighting depending upon the picture level of the current program.
- 201 Automatic Static Back Lighting: The TV automatically controls back lighting by using Intelligent Sensor to detect the level of ambient lighting.
- 202 Automatic Dynamic Back Lighting: The TV automatically controls back lighting by using Intelligent Sensor to detect the level of ambient lighting and depending upon the picture level of the current program.

If set to 201 or 202, back lighting can be controlled via the Picture settings in the TV setup menus. However, each time the TV is turned ON, Picture Mode (set in Picture Menu) is defaulted to Intelligent Sensor. If Picture Mode is manually set to a static option (Vivid, Standard, etc.) during a viewing session, Intelligent Sensor is temporarily disabled.

If set to 255, back lighting is controlled via the Picture settings in the TV setup menus.

102 - ATSC BAND

Sets up TV to receive different types of incoming signals:
0 = Broadcast, 1 = CATV, 2 = HRC, 3 = IRC, 4 = Same as NTSC.

103 - ATSC TUNE MODE

Sets ATSC tuning mode: Default set to 1 for Physical Channel scan. Set to 0 for Virtual Channel scan.

104 - START MINOR CHANNEL

Sets Minor Start Channel number at power up. 0 = NTSC. If not 0, number selected is the digital channel's Minor Start Channel number.

Note: This item is not available in the Installer Menu when item 004 STRT CHANNEL is set to 0 or 255.

106 - ASP RATIO LOCK (Aspect Ratio Lock)

Set to 1 to retain previous aspect ratio with power off. Set to 0 to retain default aspect ratio with power off. See item 096 DEF. ASP. RATIO above.

116 - VIDEO MUTE EN (Video Mute Enable)

Set to 0 for Normal. Set to 1 for Blank.

117 - FACT DEFAULT (Factory Default)

Set to 0 for normal. Set to 1 to restore the factory default settings of all Installer Menu items. The restoring of factory defaults will also re-activate the Express Script Installer Menu Wizard (see pages 11 to 14).



Caution: If set to 1, this will restore the factory defaults and clear the channel lineup, including any assigned channel icons and custom text labels.

Note: See also Reference section, "Restoring Factory Defaults on the TV(s)," for further information.

118 - POWER SAVINGS

Default set to 3—the power circuitry for both the embedded *b*-LAN module and the GAME CONTROL/MPI port is only powered when the TV is turned ON. When the TV is in Standby Mode, the embedded *b*-LAN and the GAME CONTROL/MPI port are not powered.

Note that the TV must be turned ON in order to communicate with the embedded *b*-LAN module for configuration and control when POWER SAVINGS is set to 3. If POWER SAVINGS is set to 1, the *b*-LAN module is always powered.

Similarly, if MPI communication is required for external MPI control, POWER SAVINGS should be set to 1 so that the GAME CONTROL/MPI port circuitry is always powered.

Note: See Reference section, "*b*-LAN Setup & Overview," for further information.



Caution: POWER SAVINGS should NEVER be set to 7. This setting is intended for factory use only.

119 - DATA CHANNEL

Set to 0 (default) to disable. Set from 1 to 135 to match the RF channel number that will be used by the Pro:Centric server as its data channel.*

Note: Pro:Centric updates are downloaded from the Pro:Centric server to the TV when the TV is turned OFF. While Pro:Centric updates are in progress, it is not possible to turn ON the TV.

121 - P:C RF WAKE HR

Set the Wake On RF hour from 0 to 23. This item uses the 24-hour clock format. The value "128" is displayed as "OFF." Directly entering 128 turns the Wake On RF feature OFF.

Note: This item is not available in the Installer Menu when item 119 DATA CHANNEL is set to 0.

Note: The TV clock must be set in order for a Wake On RF event to occur at the precise time of day in accordance with item 121 and item 122 settings.

122 - P:C RF WAKE MN

Set the Wake On RF minute from 0 to 59. See also description for item 121 P:C RF WAKE HR above.

Note: This item is not available in the Installer Menu unless item 121 P:C RF WAKE HR is set from 0 to 23.

Note: The TV clock must be set in order for a Wake On RF event to occur at the precise time of day in accordance with item 121 and item 122 settings.

* PCS150R and later Pro:Centric servers do not support HRC or IRC cable channel frequencies.

Channel Icons / Custom Text Labels (2-5-4 + MENU Mode)

Changing Channel Icons and/or Adding or Editing Custom Text Labels in the Channel-Time Display

If there is no pre-assigned icon for a channel, you can add a custom text label of up to seven (7) characters to help identify the channel or network. Also, if desired, a custom text label can be added to the Channel-Time display in addition to a pre-assigned icon. You may also add text labels for the Aux input sources to clearly identify the devices that are connected to the Aux inputs.

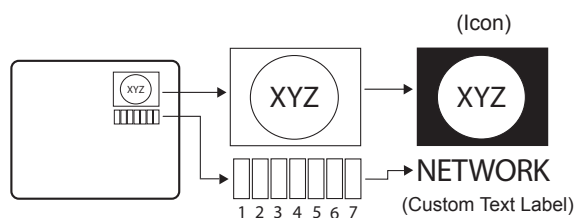

Changing icons and/or adding or editing custom text labels can only be done if there are channels that have been transferred to the TV's PTC either during the Express Script/Custom Master TV Setup (see pages 11 to 14 or pages 15 to 18, respectively) or by cloning (USB memory device / .tll file or clone programmer only).

Note: A blank letter space is available between “Z” and “!”.

To perform channel editing/labeling:

1. Use the Installer Remote to access the TV Installer Menu (see “Accessing the Installer Menu” on page 19 for further information).
2. Press **2-5-4 + MENU** on the Installer Remote to access the Channel Label Editing Menu.
3. Change channel icons and/or add or edit custom text labels as described in the procedures below. (You can do this more than once.)
4. To exit the menu when you are done, press **MENU**.

Changing a Channel's Icon on the Master TV

1. Use Channel Up/Down to select the desired channel.
2. Use the Left/Right arrow keys to select the thin letter “I” on the Channel-Time display.
3. Use the Up/Down arrow keys to select the icon with which you want to identify the channel. (If you know the icon number, enter the number, and press **OK [Enter]**.)
4. Proceed to add/edit custom text labels, or go to the next channel.

Adding/Editing Channel Labels on the Master TV

1. Use Channel Up/Down to select the desired channel.
2. Press the Left or Right arrow repeatedly until the numbers 1 to 7 appear on the display. The number shows the position of the character that can be changed. Number 1 is the first character, number 2 the second character, etc.
3. Use the Up/Down arrow keys to select the desired character.
4. Proceed to the next number position, or go to the next channel.

Adding/Editing Source Labels on the Master TV

1. Press **BANK** to select the desired Aux input source: AV1, RGB, HDMI1, or HDMI2.
2. Press the Left or Right arrow repeatedly until the numbers 0 to 9 appear on the display. The number shows the position of the character that can be changed.
3. Use the Up/Down arrow keys to select the desired character.
4. Press **BANK** for the next Aux input, or use Channel Up/Down to return to channels.

Installer Remote Control Key Functions for Master TV Channel Label Editing Menu

- **Channel Up/Down:** Tunes to the next channel in scan.
- **Left/Right Arrows:** Select the item to change. If “I” is shown, the icon can be changed. If a number is shown, it indicates the position of the character that can be changed.
- **Up/Down Arrows:** Select the icon or the character to be displayed. Tip: Arrows can be held down for fast scrolling.
- **0 – 9:** Use to enter the index number of the icon, if known.
- **OK:** Changes the icon after the icon number has been entered.
- **BANK:** Use to select Aux inputs.
- **MENU:** Exits the editing process.

Channel Banks Overview

Channel Banks enable institution administrators to create tiered channel programming on patient in-room TVs. Each channel bank may offer a custom channel lineup for a pre-determined fee. LQ630H and CQ610H TVs are configured with four channel banks, i.e., Channel Banks 1, 2, 3, and 4. The top tier generally contains the most programming (premium, etc.), 2nd tier = lesser programming, 3rd tier = basic programming, etc. It is also possible to create an Inactive TV display with Channel Bank 4, so that an “Inactive TV Call Attendant” message appears when the TV is turned ON. In this case, an administrator can then select another channel bank on the patient’s in-room TV depending on the programming tier requested by the patient.

All channels found during Auto Tuning automatically will be “ADDED” to all four channel banks, and the default is for all channels to be active (NORMAL) in Channel Banks 1, 2, 3, and 4.

 **Note:** Channel banks are not supported on TVs that are configured for FTG Mode operation.

Before You Begin

- Run the Express Script Installer Menu Wizard or complete the Custom Master TV Setup procedure (see pages 11 to 14 or pages 15 to 18, respectively).

Note: Channel banks can be defined as part of the Express Script Installer Menu Wizard, if desired. However, if you are setting up channel banks after completing the Express Script or if you are creating a customized Master TV Setup, use the Channel Preview/Banks Setup Menu as described below.

- Installer Menu item 028 CH. OVERRIDE must be set to 1 to allow access for channel banks setup.

Accessing the Channel Preview/Banks Setup Menu

1. To select a channel bank, press **BANK** on the Installer Remote. The first time you press the BANK key, the TV display will show the currently active channel bank. Press **BANK** repeatedly until the desired channel bank is selected.
2. After the desired channel bank is selected, press **CH PREVIEW** on the Installer Remote to display the Channel Preview/Banks Setup Menu (see below).

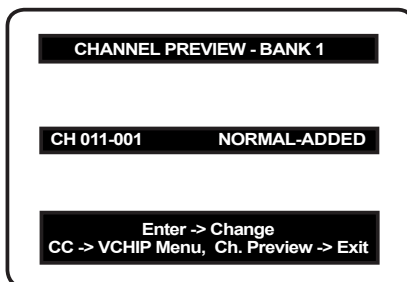

Typical Channel
Preview/Banks Setup
Menu

Note: In the Installer Menu, all available Aux inputs are enabled by default. The Aux inputs will appear between the highest analog and lowest digital channel number in the channel lineup when Channel Up/Down is used on the Installer Remote. If an Aux input will not be used, it is advisable to disable it. If using the Express Script, customize the Aux inputs as appropriate in the Aux Input screen (step 2). If performing the Custom Master TV Setup procedure, ensure Installer Menu items 035, 039, 087, and 091 are set as required before performing the 2-5-5 + MENU operation (step 5). After the TV setup is transferred to the PTC, the only way to remove Aux inputs from the channel lineup, is to go to the Channel Preview/Banks Setup Menu and select NORMAL-DELETED.

Channel Banks Setup (Cont.)

Channel Status Options for Channel Banks

In the Channel Preview/Banks Setup Menu, use the Channel Up/Down arrows on the Installer Remote to navigate to a channel and the Left/Right arrows to select the channel status.

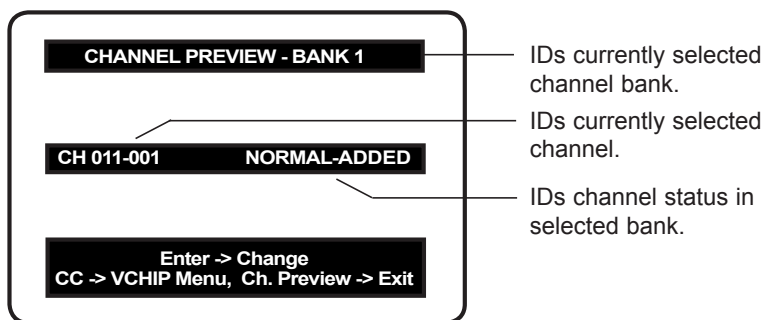

Typical Channel Preview/Banks Setup Menu

Channel Status Options

- **NORMAL-ADDED:** Channel will appear in channel lineup of currently selected channel bank.
- **NORMAL-DELETED:** Channel will not appear in channel lineup of currently selected channel bank.
- **BLANK-ADDED:** Channel will appear in all channel banks, with standard audible audio; however, video will be black (no picture).
- **BLANK-DELETED:** Channel will not appear in channel lineup of currently selected channel bank, and in all other channel banks, channel will be assigned BLANK-ADDED status.

Adding / Deleting / Blanking Channels

It is best to complete ADD / DELETE customization before assigning BLANK status. All channels found during Auto Tuning are automatically assigned NORMAL-ADDED status in Channel Banks 1, 2, 3, and 4. NORMAL-ADDED and NORMAL-DELETED status can be assigned independently for Channel Banks 1, 2, 3, and 4. However, a channel blanked, is blanked in all channel banks.

Note: Auto Tuning removes any channels previously customized with ADD / DELETE / BLANK.

Note: On individual TVs, if a channel was not found during Auto Tuning (and was not added during Express Script/Custom Master TV Setup procedures), it can be added using the Manual Tuning option in the Channel Menu.

Selecting Deleted Channels

To tune to a NORMAL-DELETED channel:

1. Select a channel bank where the channel's status is NORMAL-ADDED.
2. Navigate to or direct enter the channel number.
3. Select the channel bank where the channel's status is "NORMAL-DELETED," and reconfigure the channel status in the Channel Preview/Banks Setup Menu.

Inactive TV Setup

There are two options for creating an inactive TV display on Channel Bank 4. Either:

- Select **NORMAL-DELETED** for each channel in Channel Bank 4, or
- Press **BANK** on the Installer Remote until Channel Bank 4 is selected, and then press **CH PREVIEW** to display the Channel Preview/Banks Setup Menu. Then, press the **SAP** key on the Installer Remote to automatically delete all channels in Channel Bank 4.

When the TV is turned ON by the patient, an “Inactive TV Call Attendant” message will appear on the screen, and after a few moments the TV will turn itself OFF. This will prompt the patient to arrange for an available programming package on Channel Bank 1, 2, or 3. Using the Installer Remote, the administrator can select Channel Bank 1, 2, or 3 depending on the entertainment programming tier selected by the patient. When the patient leaves the hospital, the administrator can then select Channel Bank 4 to reinstate the “Inactive TV” message.

Channel Banks Worksheets

Use Channel Banks Worksheets (see following page) to create channel status charts as part of the setup process. On the channel status charts, show the status for each channel in all channel banks. This then becomes the patient entertainment programming offerings plan.

The following examples show “before-and-after-customization” portions of channel status charts with analog channels, Aux inputs, and digital channels.

Example: Channel Banks After Auto Tuning

BANK	Analog			Aux			Digital													
	2	5	7	AVI	RGB	HDM1	4-1	6-1	13-1	20-5	20-6	30-1	32-1	40-1	40-11	44-1	44-11	45-1	45-11	
1	A	A	A	A	A	A	A	A	A	A	A	A	A	A	A	A	A	A	A	A
2	A	A	A	A	A	A	A	A	A	A	A	A	A	A	A	A	A	A	A	A
3	A	A	A	A	A	A	A	A	A	A	A	A	A	A	A	A	A	A	A	A
4	A	A	A	A	A	A	A	A	A	A	A	A	A	A	A	A	A	A	A	A

A = Active (channel found during Auto Tuning and automatically assigned NORMAL-ADDED status)

Example: Channel Banks After Auto Tuning and Customization with Add/Del/Blk Options

BANK	Analog			Aux			Digital													
	2	5	7	AVI	RGB	HDM1	4-1	6-1	13-1	20-5	20-6	30-1	32-1	40-1	40-11	44-1	44-11	45-1	45-11	
1	BA	A	A	A	A	A	A	A	A	A	A	A	A	A	A	A	A	A	A	A
2	BA	A	A	A	A	A	A	D	D	A	A	A	A	A	A	D	D	D	D	D
3	BD	D	D	A	A	D	A	A	D	D	A	A	A	D	D	D	D	D	D	D
4	D	D	D	D	D	D	D	D	D	D	D	D	D	D	D	D	D	D	D	D

A = Active channel (channel found during Auto Tuning and retains NORMAL-ADDED status)

D = Deleted channel (channel assigned NORMAL-DELETED status in the Channel Preview/Banks Setup Menu)

BA = Channel assigned BLANK-ADDED status in the Channel Preview/Banks Setup Menu

BD = Channel assigned BLANK-DELETED status in the Channel Preview/Banks Setup Menu

Channel Banks Worksheet

Use this worksheet to plan your program packages. (Photocopy additional worksheets as needed.)

B A N K	Channel Number																			
1																				
2																				
3																				
4																				

B A N K	Channel Number																			
1																				
2																				
3																				
4																				

B A N K	Channel Number																			
1																				
2																				
3																				
4																				

B A N K	Channel Number																			
1																				
2																				
3																				
4																				

B A N K	Channel Number																			
1																				
2																				
3																				
4																				

Date _____ Installer _____ Page ___ of ___
 Location _____

IMPORTANT CLONING INFORMATION

There are four different procedures for cloning a Master TV Setup (including a TV that has been set up using the Express Script Installer Menu Wizard), each with its own advantages and limitations (see also “Cloning Methods” on page 15):

- Using a USB memory device / .tlx file
- Using a USB memory device / .tll file
- Using a TLL-1100A clone programmer
- Using a LT2002 clone programmer

Each cloning method is described in further detail on the pages that follow. As you perform cloning procedures, be sure to complete each task as indicated. If a procedure or step is omitted or not performed completely, cloning may not work. At each step, pay attention to ensure the TV screen shows the proper message when cloning. If the message indicated does not appear, there is a problem with that step, and cloning may not be successful.



Caution: Copying a blank or incorrect memory into a TV from a clone programmer will cause the TV to operate erratically or become inoperable.



Caution: If the TV is in LodgeNet PPV Mode or FTG Mode via EBL (check with the site administrator if you are not certain), do not connect a clone programmer to the GAME CONTROL/MPI port, as this will damage the clone programmer.

Before you begin cloning:

- Complete the Custom Master TV Setup procedure or run the Express Script Installer Menu Wizard (see pages 15 to 18 or pages 11 to 14, respectively).
- All equipment should be connected to power and turned ON.
- Both the Master and Target TVs must be in Pass-through Mode (i.e., the TV setup menus should be displayed when you press **MENU** on the Installer Remote).
- Learning and Teaching is only possible between identical model TVs.
- If using a USB memory device, ensure the USB device has been formatted with FAT format.
- If using a USB memory device / .tlx file, ensure that the Master TV Setup does not contain a Channel Map; otherwise, Teaching will result in the Target TV(s) being configured for FTG Mode via CPU.
- For both Master and Target TVs—If using a clone programmer, ensure the TV is tuned to either an Aux input or an analog (not a digital) channel.
- LT2002 only—Make sure the batteries in the clone programmer are fresh. If batteries are removed, the clone programmer clock time (if set) will be lost (see page 41 for information on the clone programmer clock).



Caution: Do not unplug the TV power cord or remove/disconnect the USB memory device/clone programmer while Learning or Teaching, as doing so may cause the TV to malfunction or harm the USB device/clone programmer, respectively.

USB Cloning Procedures

Learning / Teaching a Master TV Setup using a USB Memory Device / .tlx File

USB Cloning Notes

- Read the IMPORTANT CLONING INFORMATION on page 33 before beginning any cloning procedures. In particular, ensure that the Master TV Setup does not contain a Channel Map; otherwise, Teaching will result in the Target TV(s) being configured for FTG Mode via CPU.
- You may edit the filename as part of the Learning procedure; however, a file with edited contents will not be recognized.
- It is not possible to clone a Master TV's clock using a USB memory device. Either set a Target TV's clock manually, or use the Auto Clock setting in the TV setup menus.

Learn Setup from Master TV

1. Ensure the Master TV is set up completely and in Pass-through Mode.
2. Insert the USB memory device into the USB IN port on the Master TV.
3. Press **MENU** on the Installer Remote to display the TV setup menus. Use the arrow navigation keys to select/highlight the **Option** menu icon, and then press the number "7" key a total of seven times to display the USB Download Menu.
4. To gain access to the "Learn From TV" option in the USB Download Menu, key in the password used to access the Installer Menu (Example: Press **9-8-7-6**).
5. Use the Up/Down arrow keys to select **Learn From TV (TLX)**, and then press **OK (Enter)**.
6. To differentiate this .tlx file from others, you can use the Up/Down arrow keys to change the last five digits of the filename. Press **OK (Enter)** when you are ready to initiate Learning.
Learning status will be shown on a progress bar in a new window. When the Learning process is complete, the USB Download Menu will reappear on the screen.
7. When Learning is done, press **CC** on the Installer Remote to exit the USB Download Menu, and remove the USB memory device from the Master TV.

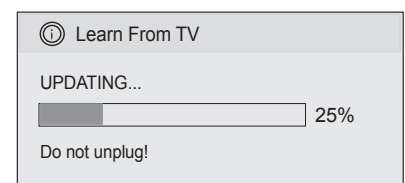
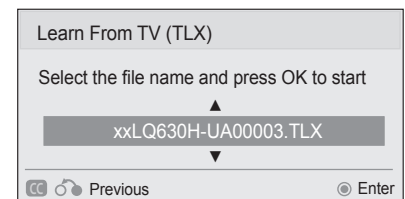
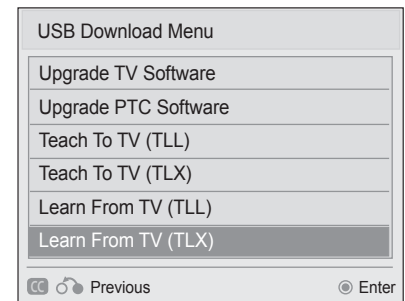

Teach Master TV Setup to Target TV

1. Turn ON the Target TV.

The next step depends on whether the Express Script Installer Menu Wizard appears on the screen when you turn ON the TV:

- If the Express Script is displayed, the TV is already in the required factory default state. Use the Up/Down arrow keys on the Installer Remote to select **Exit Express Script**, and press **OK (Enter)**. Then, go to step 3.
- Otherwise, ensure the Target TV is in Pass-through Mode. Then, continue with step 2.

2. Use the Installer Remote to access the Target TV Installer Menu (see “Accessing the Installer Menu” on page 19 for further information). Set Installer Menu item **117 FACT DEFAULT** to **1**, and press **OK (Enter)**. When the value changes back to 0, press **OK (Enter)** again to exit the Installer Menu.

Note: This step restores factory default settings on the TV, which will in turn re-activate the Express Script. Use the Up/Down arrow keys on the Installer Remote to select **Exit Express Script**, and press **OK (Enter)**.

3. Insert the USB memory device with the .tlx file into the Target TV USB IN port.
4. Press **MENU** on the Installer Remote to display the TV setup menus. Use the arrow navigation keys to select/highlight the **Option** menu icon, and then press the number “**7**” key a total of seven times to display the USB Download Menu.
5. Use the Up/Down arrow keys to select **Teach To TV (TLX)**, and then press **OK (Enter)**.
6. Use the Up/Down arrow keys to select the Master TV Setup you want to install, and then press **OK (Enter)**. Note: Filenames identify the TV and the TLX version (see example at right).

Teaching status will be shown on a progress bar in a new window. When the Teaching process is complete, the USB Download Menu will reappear on the screen.

7. When Teaching is done, press **CC** on the Installer Remote to exit the USB Download Menu, remove the USB memory device from the Target TV, and turn OFF the TV.
8. After a few seconds, turn ON the TV, and verify that the Master TV Setup is now resident on the Target TV.

Note: When you turn it back ON, the TV will tune according to the setting of Installer Menu item 004 STRT CHANNEL (Start Channel). If a Start Channel is specified, the TV will tune to that channel; otherwise, the TV will return to the last channel tuned.

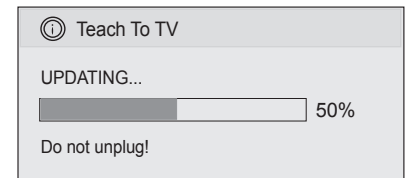
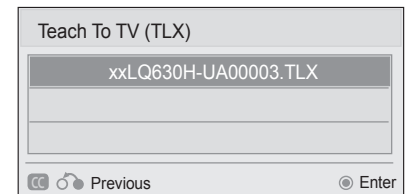
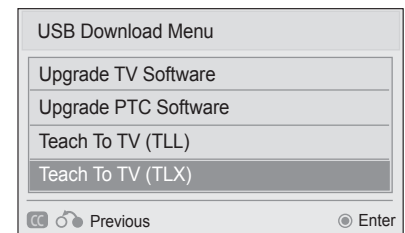

USB Cloning Procedures (Cont.)

Learning / Teaching a Master TV Setup using a USB Memory Device / .tll File

USB Cloning Notes

- Read the IMPORTANT CLONING INFORMATION on page 33 before beginning any cloning procedures.
- You may edit a filename as part of the Learning procedure; however, a file with edited contents will not be recognized.
- It is not possible to clone a Master TV's clock using a USB memory device. Either set a Target TV's clock manually or use the Auto Clock setting in the TV setup menus.

Learn Setup from Master TV

1. Ensure the Master TV is set up completely and in Pass-through Mode.
2. Insert the USB memory device into the USB IN port on the Master TV.
3. Press **MENU** on the Installer Remote to display the TV setup menus, use the arrow navigation keys to select/highlight the **Option** menu icon, and then press the number "7" key a total of seven times to display the USB Download Menu.
4. To gain access to the "Learn From TV" option in the USB Download Menu, key in the password used to access the Installer Menu (Example: Press **9-8-7-6**).
5. Use the Up/Down arrow keys to select **Learn From TV (TLL)**, and then press **OK (Enter)**.
6. To differentiate this .tll file from others, you can use the Up/Down arrow keys to change the last five digits of the filename. Press **OK (Enter)** when you are ready to initiate Learning.
Learning status will be shown on a progress bar in a new window. When the Learning process is complete, the USB Download Menu will reappear on the screen.
7. When Learning is done, press **CC** on the Installer Remote to exit the USB Download Menu, and remove the USB memory device from the Master TV.

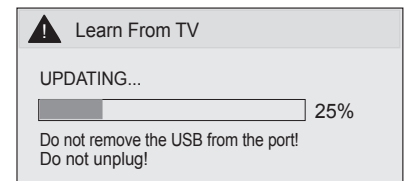
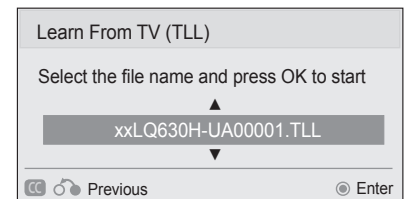
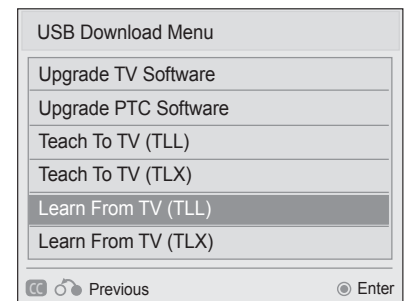

Teach Master TV Setup to Target TV

1. Turn ON the Target TV.

The next step depends on whether the Express Script Installer Menu Wizard appears on the screen when you turn ON the TV:

- If the Express Script is displayed, the TV is already in the required factory default state. Use the Up/Down arrow keys on the Installer Remote to select **Exit Express Script**, and press **OK (Enter)**. Then, go to step 3.
- Otherwise, ensure the Target TV is in Pass-through Mode. Then, continue with step 2.

2. Use the Installer Remote to access the Target TV Installer Menu (see “Accessing the Installer Menu” on page 19 for further information). Set Installer Menu item **117 FACT DEFAULT** to **1**, and press **OK (Enter)**. When the value changes back to 0, press **OK (Enter)** again to exit the Installer Menu.

Note: This step restores factory default settings on the TV, which will in turn re-activate the Express Script. Use the Up/Down arrow keys on the Installer Remote to select **Exit Express Script**, and press **OK (Enter)**.

3. Tune/set the TV to an analog or digital channel or Aux input (ideally the same source tuned for 2-5-5 + MENU Mode during the Custom Master TV Setup procedure, if applicable).
4. Insert the USB memory device with the .tll file into the Target TV USB IN port.
5. Press **MENU** on the Installer Remote to display the TV setup menus, use the arrow navigation keys to select/highlight the **Option** menu icon, and then press the number “7” key a total of seven times to display the USB Download Menu.
6. Use the Up/Down arrow keys to select **Teach To TV (TLL)**, and then press **OK (Enter)**.
7. Use the Up/Down arrow keys to select the Master TV Setup you want to install, and then press **OK (Enter)**. Note: Filenames identify the TV and the TLL version (see example at right).

Teaching status will be shown on a progress bar in a new window. When the Teaching process is complete, the USB Download Menu will reappear on the screen.

8. When Teaching is done, press **CC** on the Installer Remote to exit the USB Download Menu, remove the USB memory device from the Target TV, and turn OFF the TV.
9. After a few seconds, turn ON the TV, and verify that the Master TV Setup is now resident on the Target TV.

Note: When you turn it back ON, the TV will tune according to the setting of Installer Menu item 004 STRT CHANNEL (Start Channel). If a Start Channel is specified, the TV will tune to that channel; otherwise, the TV will return to the last channel tuned.

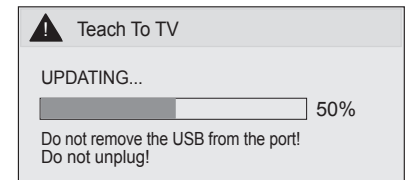
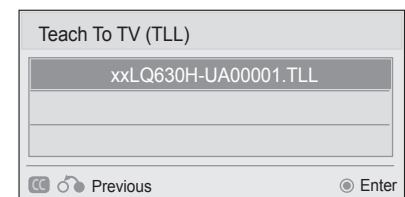
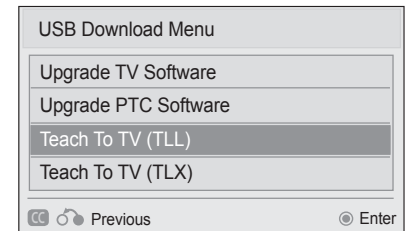

Clone Programmer Cloning Procedures

Learning / Teaching a Master TV Setup using a TLL-1100A Clone Programmer



Caution: If the TV is in LodgeNet PPV Mode or FTG Mode via EBL (check with the site administrator if you are not certain), do not connect a clone programmer to the GAME CONTROL/MPI port, as this will damage the clone programmer.

Cloning is accomplished using the TV/clone programmer MPI ports for communication (see figure).

TLL-1100A Cloning Notes

- Read the IMPORTANT CLONING INFORMATION on page 33 before beginning any cloning procedures.
- Ensure the TLL-1100A is either fully charged or connected to AC power.
- Learning and Teaching is only possible between identical model TVs; however, the TLL-1100A can store up to eight different Master TV Setups.

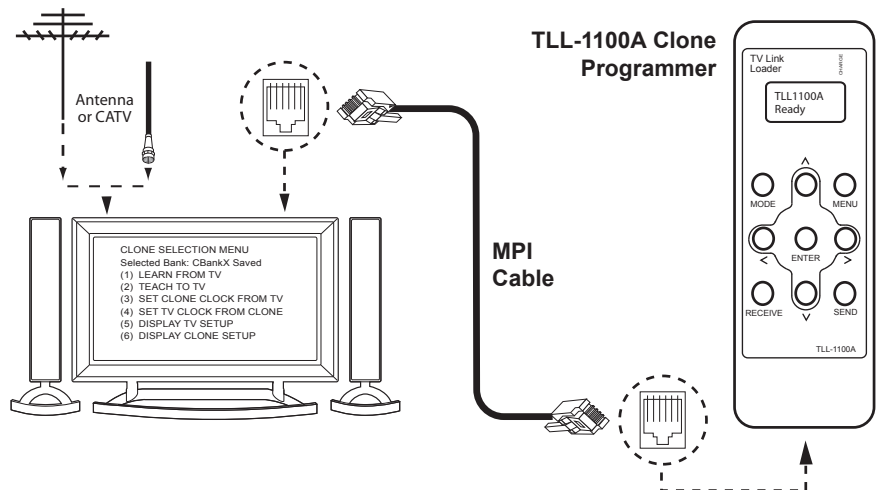

Learn Setup from Master TV

1. Ensure the Master TV is set up completely and in Pass-through Mode.
2. Tune/set the TV to an analog channel or Aux input, and then plug one end of the MPI cable into the TV MPI port.
3. Turn ON the TLL-1100A.
4. Use the **MODE** button on the TLL-1100A to select **Clone Mode**.
5. Use the Left/Right arrows on the TLL-1100A to select the Memory CBank (1 to 8) in which to store the Master TV Setup.
6. Plug the other end of the MPI cable into the MPI port on the bottom of the TLL-1100A. The Clone Selection Menu will display on the TV screen.

7. Press **1** on the Installer Remote to select **LEARN FROM TV** from the Clone Selection Menu. Then, press **OK (Enter)** to transfer the Master TV Setup into CBankX on the TLL-1100A.

Learning usually takes about 90 seconds. "LEARNING IN PROGRESS" will be displayed on the screen while the TLL-1100A copies the Master Setup. When the Learning process is complete, a "LEARNING COMPLETE" message will be displayed.

8. When Learning is complete, disconnect the MPI cable from the Master TV.

CLONE SELECTION MENU
Selected Bank: CBankX Saved
(1) LEARN FROM TV
(2) TEACH TO TV
(3) SET CLONE CLOCK FROM TV
(4) SET TV CLOCK FROM CLONE
(5) DISPLAY TV SETUP
(6) DISPLAY CLONE SETUP

CLONE CLOCK = XX:XX
TV CLOCK = XX:XX
THE CLONE IS VERSION VX.X.X
- To change menu items, press channel keys or digits.
- To execute item, press Enter.

Clone Programmer Cloning Procedures (Cont.)

(Optional) Set the Clock

Set the time on a Master TV's clock. (If the time has already been copied from a TV into the TLL-1100A clone programmer, you can set the Master TV's clock by copying the time from the clone programmer.) The TLL-1100A can copy the current time to both a Master TV and to the clone's internal clock—accurate to within one minute.

Since the TLL-1100A's time cannot be set directly, the current time needs to be copied from an LG TV equipped with an enabled MPI port.

After the time is copied to the TLL-1100A clone programmer, the current time will be maintained and can then be transferred to another TV. (This can be a Master TV or another TV which has already had the features set up.)

Teach Master TV Setup to Target TV

1. Turn ON the Target TV.

The next step depends on whether the Express Script Installer Menu Wizard appears on the screen when you turn ON the TV:

- If the Express Script is displayed, the TV is already in the required factory default state. Use the Up/Down arrow keys on the Installer Remote to select **Exit Express Script**, and press **OK (Enter)**. Then, go to step 3.
- Otherwise, ensure the Target TV is in Pass-through Mode. Then, continue with step 2.

2. Use the Installer Remote to access the Target TV Installer Menu (see "Accessing the Installer Menu" on page 19 for further information). Set Installer Menu item **117 FACT DEFAULT** to **1**, and press **OK (Enter)**. When the value changes back to 0, press **OK (Enter)** again to exit the Installer Menu.

Note: This step restores factory default settings on the TV, which will in turn re-activate the Express Script. Use the Up/Down arrow keys on the Installer Remote to select **Exit Express Script**, and press **OK (Enter)**.

3. Tune/set the TV to an analog channel or Aux input (ideally the same source tuned for 2-5-5 + MENU Mode during the Custom Master TV Setup procedure, if applicable), and then connect the MPI cable to the MPI port on the Target TV. The Clone Selection Menu will display on the TV screen.
4. Ensure the correct Memory CBank(X) is selected on the TLL-1100A.
5. Press **2** on the Installer Remote to select **TEACH TO TV** from the Clone Selection Menu. Then, press **OK (Enter)** to transfer the Master TV Setup to the Target TV.
Teaching usually takes 3 to 4 minutes. "TEACHING IN PROGRESS" will be displayed on the screen during Teaching. When the Teaching process is complete, a "TEACHING COMPLETE" message will be displayed.
6. When Teaching is done, disconnect the MPI cable from the Target TV, and turn OFF the TV.
7. After a few seconds, turn ON the TV, and verify that the Master TV Setup is now resident on the Target TV.

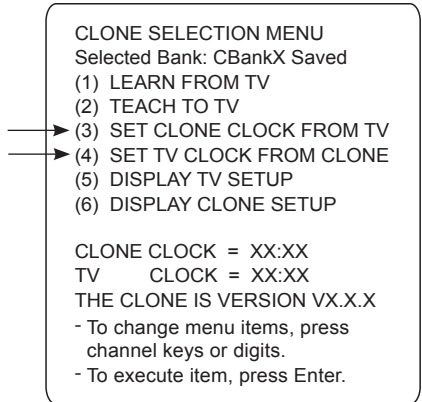

```
CLONE SELECTION MENU
Selected Bank: CBankX Saved
(1) LEARN FROM TV
(2) TEACH TO TV
(3) SET CLONE CLOCK FROM TV
(4) SET TV CLOCK FROM CLONE
(5) DISPLAY TV SETUP
(6) DISPLAY CLONE SETUP
```

```
CLONE CLOCK = XX:XX
TV    CLOCK = XX:XX
THE CLONE IS VERSION VX.X.X
- To change menu items, press
  channel keys or digits.
- To execute item, press Enter.
```

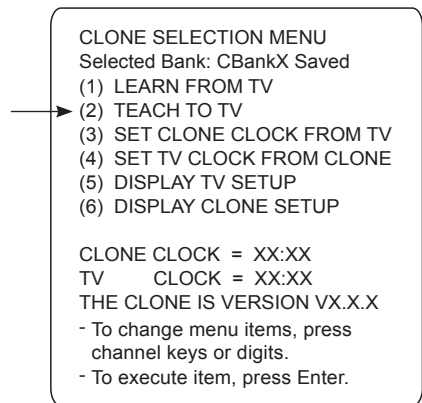

```
CLONE SELECTION MENU
Selected Bank: CBankX Saved
(1) LEARN FROM TV
(2) TEACH TO TV
(3) SET CLONE CLOCK FROM TV
(4) SET TV CLOCK FROM CLONE
(5) DISPLAY TV SETUP
(6) DISPLAY CLONE SETUP
```

```
CLONE CLOCK = XX:XX
TV    CLOCK = XX:XX
THE CLONE IS VERSION VX.X.X
- To change menu items, press
  channel keys or digits.
- To execute item, press Enter.
```

Clone Programmer Cloning Procedures (Cont.)

Learning / Teaching a Master TV Setup using an LT2002 Clone Programmer



Caution: If the TV is in LodgeNet PPV Mode or FTG Mode via EBL (check with the site administrator if you are not certain), do not connect a clone programmer to the GAME CONTROL/MPI port, as this will damage the clone programmer.

Cloning is accomplished using the TV/clone programmer MPI ports for communication (see figure).

LT2002 Cloning Notes

- Read the IMPORTANT CLONING INFORMATION on page 33 before beginning any cloning procedures.
- A slow flashing green light indicates that there are communication problems between the TV and the LT2002. If this is the case, check for a damaged cable, poor contacts, or other connection troubles.
- If the status indicator is red, the LT2002 batteries are low and should be replaced. Install four (4) high-quality alkaline AA batteries.
- Learning and Teaching is only possible between identical model TVs; however, the LT2002 can store up to three different Master TV Setups.

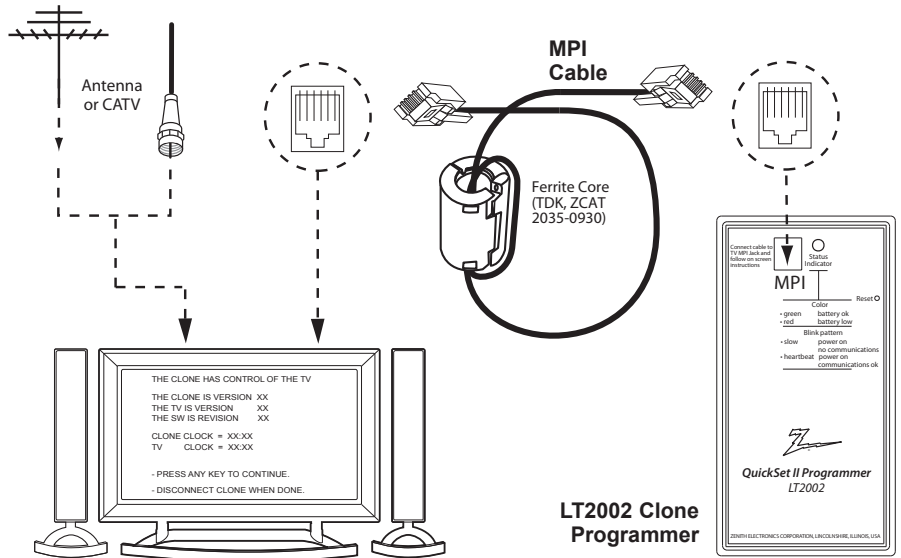

Learn Setup from Master TV

1. Ensure the Master TV is set up completely and in Pass-through Mode.
2. Tune/set the TV to an analog channel or Aux input, and then plug one end of the MPI cable into the TV MPI port.
3. If there is a good connection after the LT2002 is connected to the TV MPI port, "THE CLONE HAS CONTROL OF THE TV" message will appear on the TV screen. Press any key on the Installer Remote to access the LT2002 Clone Selection Menu.
4. Press **1** on the Installer Remote to select **LEARN FROM TV** from the Clone Selection Menu; then press **OK (Enter)** to proceed to the Memory Bank Selection Menu.
5. Press 1, 2, or 3 on the Installer Remote to select the clone Memory Bank in which to store the Master Setup. Then, press **OK (Enter)**.

CLONE SELECTION MENU

→ (1) LEARN FROM TV
 (2) TEACH TO TV
 (3) SET CLONE CLOCK FROM TV
 (4) SET TV CLOCK FROM CLONE
 (5) DISPLAY TV SETUP
 (6) DISPLAY CLONE SETUP

- TO CHANGE MENU ITEMS, PRESS CHANNEL KEYS OR DIGITS.

- TO EXECUTE ITEM, PRESS ON/OFF, POWER, OR ENTER.

Note: If you choose a Memory Bank that already has a Master device's setup programmed into it, that setup will be overwritten by the new Master TV Setup.

6. Verify the Learning setup information on the next screen, and then press **POWER** to transfer the Master TV Setup into the selected Memory Bank on the LT2002.

SAVE TV SETUP IN SELECTED CLONE MEMORY

→ (1) MEMORY 1 VER XX REV XX
 (2) MEMORY 2 VER XX REV XX
 (3) MEMORY 3 VER XX REV XX
 (4) RETURN TO CLONE MENU

- TO CHANGE MENU ITEMS, PRESS CHANNEL KEYS OR DIGITS.

- TO EXECUTE ITEM, PRESS ON/OFF, POWER, OR ENTER.

Learning usually takes about 90 seconds. "LEARNING IN PROGRESS" will be displayed on the screen while the LT2002 copies the Master Setup. When the Learning process is complete, a "LEARNING COMPLETE" message will be displayed.

7. When Learning is complete, disconnect the MPI cable from the Master TV.

Clone Programmer Cloning Procedures (Cont.)

(Optional) Set the Clock

Set the time on a Master TV's clock. (If the time has already been copied from a TV into the LT2002 clone programmer, you can set the Master TV's clock by copying the time from the clone programmer.) The LT2002 can copy the current time to both a Master TV and to the clone's internal clock—accurate to within one minute. (Another reason that the LT2002 should be equipped with fresh, high-quality alkaline batteries, is for it to keep the time as accurately as possible.)

Since the LT2002's time cannot be set directly, the current time needs to be copied from an LG TV equipped with an enabled MPI port.

After the time is copied to the LT2002 clone programmer, the current time will be maintained and can then be transferred to another TV. (This can be a Master TV or another TV which has already had the features set up.)

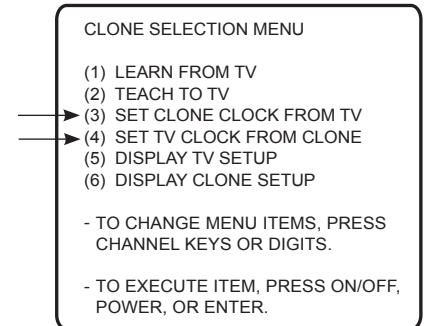

Teach Master TV Setup to Target TV

1. Turn ON the Target TV.

The next step depends on whether the Express Script Installer Menu Wizard appears on the screen when you turn ON the TV:

- If the Express Script is displayed, the TV is already in the required factory default state. Use the Up/Down arrow keys on the Installer Remote to select **Exit Express Script**, and press **OK (Enter)**. Then, go to step 3.
- Otherwise, ensure the Target TV is in Pass-through Mode. Then, continue with step 2.

2. Use the Installer Remote to access the Target TV Installer Menu (see “Accessing the Installer Menu” on page 19 for further information). Set Installer Menu item **117 FACT DEFAULT** to **1**, and press **OK (Enter)**. When the value changes back to 0, press **OK (Enter)** again to exit the Installer Menu.

Note: This step restores factory default settings on the TV, which will in turn re-activate the Express Script. Use the Up/Down arrow keys on the Installer Remote to select **Exit Express Script**, and press **OK (Enter)**.

3. Tune/set the TV to an analog channel or Aux input (ideally the same source tuned for 2-5-5 + MENU Mode during the Custom Master TV Setup procedure, if applicable), and then connect the MPI cable to the MPI port on the Target TV.
4. With “THE CLONE HAS CONTROL OF TV” message on display, press **2** on the Installer Remote to select **TEACH TO TV** from the LT2002 Clone Selection Menu. Then, press **OK (Enter)**.

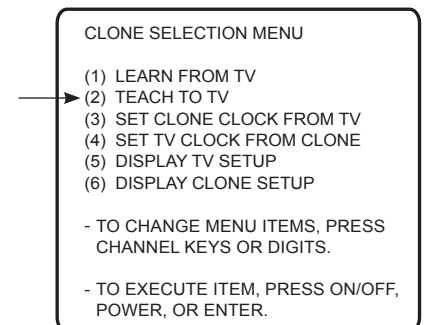

5. Select the LT2002 Memory Bank in which the new Master TV Setup is located, and press **OK (Enter)**.

6. Verify the Teaching setup information on the next screen, and then press **POWER** to transfer the Master TV Setup to the Target TV.

Teaching usually takes 3 to 4 minutes. “TEACHING IN PROGRESS” will be displayed on the screen during Teaching. When the Teaching process is complete, a “TEACHING COMPLETE” message will be displayed.

7. When Teaching is done, disconnect the MPI cable from the Target TV, and turn OFF the TV.
8. After a few seconds, turn ON the TV, and verify that the Master TV Setup is now resident on the Target TV.

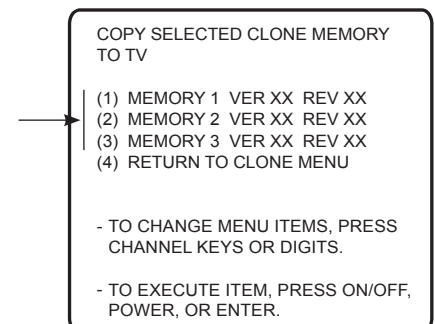

FTG Mode of Operation Overview

FTG Mode via CPU or EBL

FTG Mode enables Pro:Idiom decryption and also allows logical channel mapping of physical channels.

As indicated in the introduction to this document, there are two separate and distinct methods for configuring LQ630H and CQ610H TVs for FTG Mode of operation: one (new) method is to configure the TV CPU for FTG Mode operation, while the other is to configure the TV EBL for FTG Mode operation. FROM A LOCAL CONFIGURATION STANDPOINT, EACH OF THESE METHODS IS MUTUALLY EXCLUSIVE. IF THE CPU IS IN FTG MODE, THE EBL CANNOT BE SWITCHED TO FTG MODE. LIKEWISE, IF THE EBL IS IN FTG MODE, THE CPU CANNOT BE SWITCHED TO FTG MODE.

FTG Mode via CPU

This mode provides the following features:

- Logical channels mapped to RF delivered content.
- Digital RF channel minor (program) numbers up to 999.
- FTG Channel Map of up to 600 logical channels.
- Start Channel set for RF or Aux input delivered content.
- Pro:Centric data delivery over RF.

FTG Mode via CPU requires that you use LG FTG File Manager PC software to create an FTG Configuration (.tlx) file, which will in turn be used to configure the CPU. In this mode, the CPU is the owner of the FTG Channel Map and must be configured with an FTG Channel Map and FTG Installer Menu settings using one of the following processes:

- Local: Configure an individual LQ630H/CQ610H TV via USB port using an FTG Configuration (.tlx) file on a USB memory device. The “Teach to TV (TLX)” process and associated procedures are described on pages 44 to 48.
- Remote: Configure all LQ630H/CQ610H TVs at the site using a Pro:Centric server head end device (Example: PCS150R). Load an FTG Configuration (.tlx) file on the Pro:Centric server using the TV E-Z Installation “Configuration” option in the Pro:Centric server Admin Client. Refer to the ***Pro:Centric Server Admin Client User Guide*** for further information.

FTG Mode via EBL

This mode provides the following features:

- Logical channels mapped to RF delivered content.
- Digital RF channel minor (program) numbers up to 255.
- FTG Channel Map of up to 141 logical channels.
- Start Channel set for RF or Aux input delivered content.
- Pro:Centric data delivery over RF.

FTG Mode via EBL requires that you use LG FTG Device Configuration Application PC software to configure the EBL. In this mode, the EBL is the owner of the FTG Channel Map and must be configured with an FTG Channel Map and FTG Installer Menu settings using one of the following processes:

- Local: Configure an individual LQ630H/CQ610H TV’s EBL via its TV-LINK CFG jack using a direct PC-to-TV connection and the FTG Device Configuration Application. The “Write” process for an FTG Channel Map and FTG Installer Menu settings is described on page 49.
- Remote: Configure all LQ630H/CQ610H TV EBLs at the site using a Free-To-Guest Management Appliance (FMA) head end device (Example: FMA-LG101). Refer to the ***Free-To-Guest (FTG) Device Configuration Application User Guide*** and/or the Installation & Configuration Guide for the FMA device for further information.

FTG Mode of Operation Overview (Cont.)

While the TV is in FTG Mode:

- Users can still access the Installer Menu using an LG Installer Remote; however, all Installer Menu items will be read-only.
- Any FTG configuration changes must be made using either the FTG File Manager (FTG Mode via CPU) or the FTG Device Configuration Application (FTG Mode via EBL). FTG Channel Map Configuration and FTG Installer Menu Configuration Utilities enable you to make changes, respectively, to the FTG Channel Map and FTG Installer Menu settings as necessary. Based on the initial method used to configure the TV for FTG Mode operation (via CPU or EBL), all subsequent changes must be transferred to either the TV CPU or the EBL via a process that is in accordance or compatible with that method (see information on local configuration in this document or refer to documentation for the head end device/server for information on remote management).
- If it becomes necessary to restore the TV to Pass-through Mode, there are several options that will enable you to do so. Refer to Reference section, "Restoring Factory Defaults on the TV(s)," for further information.

Pages 50 to 53 provide overviews of the utilities that comprise the FTG File Manager. Refer to the **Free-To-Guest (FTG) File Manager User Guide** for further information on the FTG File Manager. Refer to the **Free-To-Guest (FTG) Device Configuration Application User Guide** for information on the FTG Device Configuration Application.

Determining the TV Operating Mode

To determine the operating mode of the TV, press **MENU** on the Installer Remote. The menu displayed depends on the operating mode. See examples below.

If the Function Menu appears, the TV is in a mode (FTG, PPV, etc.) that does not allow the end user to change the fundamental TV setup. If the TV setup menus appear, the TV is in Pass-through Mode.

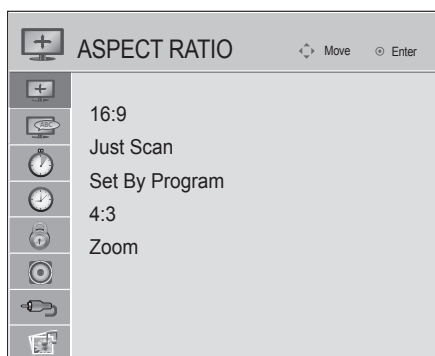

Function Menu

Indicates the TV is not in Pass-through Mode. While the TV is in this mode, Installer Menu settings can be accessed as read-only.

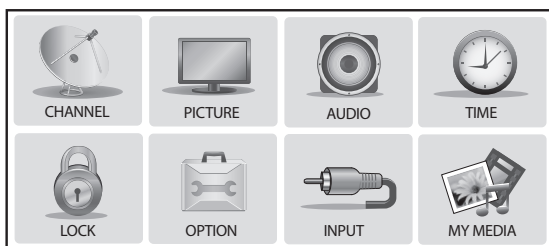

TV Setup Menus

Shows that the TV is in Pass-through Mode.

FTG Mode via CPU

Creating an FTG Configuration File using the FTG File Manager

This section describes how to create an FTG Configuration (.tlx) file that can be saved to a USB memory device. In order to enable Pro:Idiom decryption, it is recommended that you create an FTG Configuration file using the FTG File Manager.

Before you begin, note the following:

- FTG File Manager software is available online at: www.LGolutions.com/ftgsoftware.
- There is also an option to save (Learn) an FTG Configuration file from a TV, which may be desirable or required in either of the following situations:
 - If you want to save customized TV setup menu settings to the FTG Configuration file (in addition to the FTG Channel Map and FTG Installer Menu settings).
 - If you do not know the RF channels at the site.

See “Learning FTG Configuration from a TV” on page 47 for further information. However, if you use this option to save an FTG Configuration file, it is still highly recommended that you open the saved FTG Configuration file in the FTG File Manager to verify the file contents/settings and to enable Pro:Idiom decryption by marking Encrypted channels using the FTG Channel Map Editor.

The procedure below provides an overview of the steps required to create an FTG Configuration (.tlx) file. Refer to the **Free-To-Guest (FTG) File Manager User Guide** for further information. See also FTG File Manager sample screens on pages 50 to 53.

1. Install (if necessary) and launch the FTG File Manager (v1.1.2 or higher) on the PC that will be used to create the FTG Configuration (.tlx) file.

2. You have several options at this time:

- To view and/or base a new FTG Configuration file on an existing FTG Configuration (.tlx) file, click the **Open** button in the TLX File command section of the FTG File Manager main screen, and select the desired (.tlx) file.

A list of the file’s contents will be displayed in the TLX File Contents window. Either double-click on an individual item to copy it or click the **Copy All** button directly above the TLX File Contents window to automatically copy all the contents of the opened .tlx file to the FTG Configuration List and, if applicable, TV Setup Menu List. Note, though, that while TV setup menu settings can be included in the new FTG Configuration file, the TV setup menu settings are not available for editing.

Edit the configuration of the items in the FTG Configuration List as well as the FTG Configuration List itself and/or the TV Setup Menu List, as necessary, to create a new file. Then, proceed to step 3 when you are ready to continue.

- To open an existing FTG Configuration (.rml) file created in the FTG Device Configuration Application to use its FTG Channel Map and/or FTG Installer Menu settings, click **File** and then **Open** from the FTG File Manager menu bar, and select/double-click on the desired “.rml” file.

Edit channels and/or settings as necessary, and then proceed to step 3 when you are ready to continue.

(Continued on next page)

(Continued from previous page)

- Create a new FTG Channel Map using the FTG Channel Map Editor in the FTG Channel Map Configuration Utility. Up to 600 logical channels can be defined in the FTG Channel Map.

When you are ready to continue, click **Configure** and then **FTG File Manager** from the FTG File Manager menu bar to return to the FTG File Manager main screen, and then proceed to step 3.

Note: To remove an individual item from the FTG Configuration List or the TV Setup Menu List, click on/highlight the item to be removed, and then click the **Remove Item** button directly above the applicable “List” window. To clear both the current FTG Configuration List and TV Setup Menu List contents, click the **Clear** button in the List command section of the FTG File Manager main screen.

Note: To clear the current TLX File Contents, click the **New** button in the TLX File command section of the FTG File Manager main screen (above the TLX File Contents window).

3. To add an FTG Channel Map to the FTG Configuration List, click **>>** under FTG Channel Map. This will copy the current mapped channels to the FTG Configuration List.

Note: If you make any change(s) in the FTG Channel Map Configuration Utility to the current data to be included in the FTG Configuration List, you will need to recopy the FTG Channel Map to the FTG Configuration List.

4. (Optional) Load default FTG Installer Menu settings for the TV:

- Click the down arrow at the right of the Chassis field in the Installer Menu Templates section of the FTG File Manager main screen, and select the appropriate chassis (22LQ630H or 26/32LQ630H or 42CQ610H) from the drop-down list of available models.
- Click the **Load** button.
- Use the FTG Installer Menu Configuration Utility to modify settings, if necessary. Then, return to the FTG File Manager main screen.

5. To add FTG Installer Menu settings to the FTG Configuration List, click **>>** under FTG Installer Menu Settings. This will copy the selected model’s settings to the FTG Configuration List.

Note: If you make any change(s) in the FTG Installer Menu Configuration Utility to the current data to be included in the FTG Configuration List, you will need to recopy the FTG Installer Menu settings to the FTG Configuration List.

6. Click the **Save** button in the List command section of the FTG File Manager main screen to save the FTG Configuration List and, if present, TV Setup Menu List contents to an FTG Configuration (.tlx) file on the PC’s hard drive for later use.

In the Save As pop-up window, name the file, and click **Save**. The default folder path is C:\Program Files\Zenith\FTG\TLX. Note that the FTG Configuration file will have a “.tlx” extension.

Note: To remove an individual item from the FTG Configuration List or the TV Setup Menu List before saving the new file, click on/highlight the item to be removed, and then click the **Remove Item** button directly above the applicable window. To clear both the current FTG Configuration List and TV Setup Menu List contents, click the **Clear** button in the List command section of the FTG File Manager main screen.

7. Transfer the FTG Configuration (.tlx) file to a USB memory device, and proceed to “Teaching FTG Configuration to a TV” on the following page to transfer the FTG Configuration file to an LQ630H or CQ610H TV, as applicable.

FTG Mode via CPU (Cont.)

Teaching FTG Configuration to a TV

This procedure describes how to “Teach” an FTG Configuration file from a USB memory device to a TV. Ensure you have completed the procedure on the previous page to create the FTG Configuration file before proceeding with the steps below.

Note: If the TV EBL is already in FTG Mode, you cannot use this procedure to make changes to the FTG Channel Map and FTG Installer Menu settings. You must use a direct PC-to-TV connection as described on page 49 or an FMA head end device to reconfigure the EBL.

Note: If the preceding condition applies, but you wish to switch the TV to FTG mode via CPU, refer to Reference section, “Restoring Factory Defaults on the TV(s),” for further information before proceeding.

1. Turn ON the Target LQ630H or CQ610H TV.
If the Express Script Installer Menu Wizard appears on the screen when you turn ON the TV, use the Up/Down arrow keys on the Installer Remote to select **Exit Express Script**, and press **OK (Enter)**.
2. Insert the USB memory device that contains the FTG Configuration file into the TV’s USB IN port.
3. Press **MENU** on the Installer Remote to display the TV setup menus (TV is in Pass-through Mode) or the Function Menu (TV is already in FTG Mode).
4. Use the arrow navigation keys to select/highlight either the **Option** menu icon from the TV setup menus or the **Lock** menu icon from the Function Menu. Then, press the number “7” key a total of seven times to display the USB Download Menu.
5. Use the Up/Down arrow keys to select **Teach To TV (TLX)**, and then press **OK (Enter)**.
6. Use the Up/Down arrow keys to select the FTG Configuration file you want to install, and then press **OK (Enter)**.
Teaching status will be shown on a progress bar in a new window. Do NOT remove the USB device until Teaching is complete. When the Teaching process is complete, the USB Download Menu will reappear on the screen.
7. When Teaching is done, press **CC** on the Installer Remote to exit the USB Download Menu, remove the USB memory device from the Target TV, and turn OFF the TV.
8. After a few seconds, turn ON the TV, and verify that the FTG Configuration is now resident on the Target TV.

The Target TV CPU is now in FTG Mode (if it was previously in Pass-through Mode).

Note: When you turn it back ON, the TV will tune according to the Start Channel setting in the Installer Menu. If a Start Channel is specified, the TV will tune to that channel; otherwise, the TV will tune to the lowest logical channel in the FTG Channel Map.

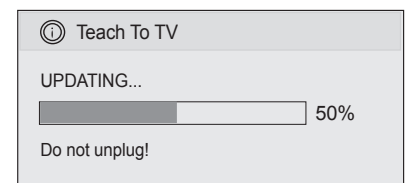
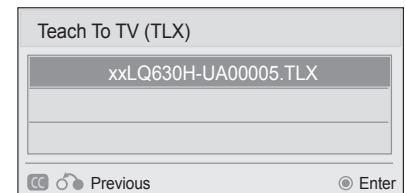
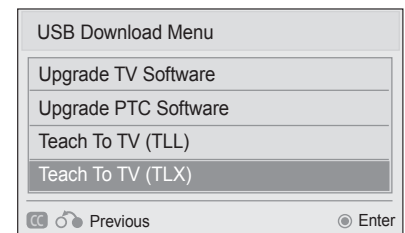

Learning FTG Configuration from a TV

To ensure that Pro:Idiom decryption is enabled, it is recommended that you create an FTG Configuration file using the FTG File Manager as described on pages 44 to 45. However, if necessary, this option enables you to save (Learn) an FTG Configuration file from an LQ630H or CQ610H TV to a USB memory device.

The option to save (Learn) an FTG Configuration file from a TV may be desirable or required in either of the following situations:

- If you want to save customized TV setup menu settings to the FTG Configuration file (in addition to the FTG Channel Map and FTG Installer Menu settings).
- If you do not know the RF channels at the site.

Note: If the TV is NOT already in FTG Mode, you may need to perform some manual configuration on the TV before you start this procedure (see “Optional Manual Configuration / TV Setup” on next page).

1. Turn ON the TV, and then insert a USB memory device into the USB IN port on the TV.
2. Press **MENU** on the Installer Remote to display the TV setup menus (TV is in Pass-through Mode) or the Function Menu (TV is already in FTG Mode).
3. Use the arrow navigation keys to select/highlight either the **Option** menu icon from the TV setup menus or the **Lock** menu icon from the Function Menu. Then, press the number “7” key a total of seven times to display the USB Download Menu.
4. To gain access to the Learn From TV options in the USB Download Menu, key in the password used to access the Installer Menu (Example: Press 9-8-7-6).
5. Use the Up/Down arrow keys to select **Learn From TV (TLX)**, and then press **OK (Enter)**.
6. To differentiate this .tlx file from others, you can use the Up/Down arrow keys to change the last five digits of the filename. Press **OK (Enter)** when you are ready to initiate Learning.
Learning status will be shown on a progress bar in a new window. Do NOT remove the USB device until Learning is complete. When the Learning process is complete, the USB Download Menu will reappear on the screen.
7. When Learning is done, press **CC** on the Installer Remote to exit the USB Download Menu, and remove the USB memory device.

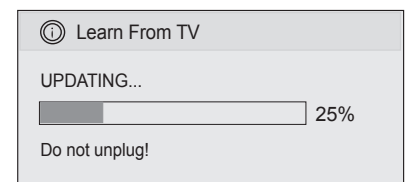
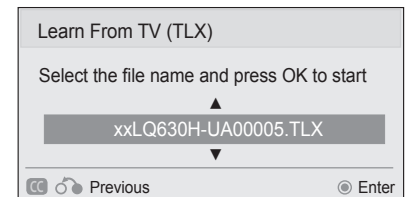
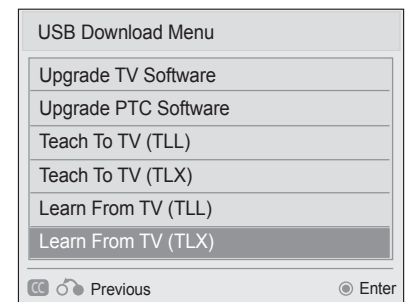

Note: It is highly recommended that you open this FTG Configuration file in the FTG File Manager—BEFORE transferring (Teaching) the file to any TVs—to verify FTG Channel Map and FTG Installer Menu settings and enable Pro:Idiom decryption by marking Encrypted channels. This will also enable you to confirm channels and add channel attributes, labels, etc.

FTG Mode via CPU (Cont.)

Optional Manual Configuration / TV Setup

The manual configuration procedures below should only be performed if you do not know the RF channels at the site and need to “Learn” an FTG Configuration file from an LQ630H or CQ610H TV as described on the previous page. Ensure the TV is in Pass-through Mode before you begin.

Note: These configuration procedures parallel the initial steps required for creating a custom Master TV Setup. See also screen examples on pages 16 to 17.

Set Installer Menu Items

These steps provide specific instruction only on the Installer Menu items that should be set on an LQ630H or CQ610H TV. Refer to pages 19 to 27 for detailed information on all Installer Menu items.

1. Turn ON the TV.* Then, use the Installer Remote to access the Installer Menu (see “Accessing the Installer Menu” on page 19 for further information).
2. Set Installer Menu item **117 FACT DEFAULT** to **1** and press **OK (Enter)** on the Installer Remote.
This clears all Installer Menu custom settings, the channel lineup, etc. and restores the factory default settings. The value will change back to 0 after the commercial controller (PTC) has been restored to factory default condition. This step ensures that the TV Channel Memory will be the active channel lineup.
3. Set Installer Menu item **003 BAND/AFC**, as appropriate.
 - Broadcast: Set to 0.
 - CATV: Set to 1 (default).
 - HRC: Set to 2.
 - IRC: Set to 3.
4. Set Installer Menu item **027 HOSPITAL MODE**, as appropriate, to select the speaker configuration. Also, set any other Installer Menu items that affect your TV programming network to the required configuration. For example, enable/disable Aux inputs, set a Start Channel, etc.
5. After you have adjusted all Installer Menu item settings as required, press **OK (Enter)** once on the Installer Remote to save your changes; then, press **OK (Enter)** again to exit the menu.

Set Up TV Features

On-screen setup menus control the features of the TV. Press **MENU** on the Installer Remote to access the TV setup menus, and then set Channel, Picture, Audio, Time, etc. options to the desired configurations.

Run Auto Tuning (Channel Search)

Note: In the FTG Configuration file, Logical Channel numbers will automatically be assigned in ascending order, starting with 0 (zero), to the Physical Channels from the TV Channel Map.

Note: Pro:Idiom decryption for encrypted channels will not be enabled unless you use the FTG File Manager to set the channel attributes.

1. Search for all available analog and digital channels: Use the Installer Remote to go to the Channel Menu, select the **Auto Tuning** option, and follow the on-screen instructions.
2. Use the **Channel Edit** option in the Channel Menu to edit the channel lineup, as necessary, to include free to guest channels only. Add/delete channels per your system requirements.

Once you have completed these procedures, return to “Learning FTG Configuration from a TV” on the previous page to complete the Learn sequence.

* If the Express Script Installer Menu Wizard appears on the screen when you turn ON the TV, use the Up/Down arrow keys on the Installer Remote to select **Exit Express Script**, and press **OK (Enter)**. Note that in this case, you will not need to perform step 2 because the TV is already in a factory default state.

FTG Mode via EBL (Local Configuration)

The following steps outline local FTG configuration of individual TV EBLs using a direct PC-to-TV connection. Refer to the **Free-To-Guest (FTG) Device Configuration Application User Guide** for further information.

FTG Device Configuration Application software is available online at: www.LGolutions.com/ftgsoftware.

Note: If the TV CPU is already in FTG Mode, you cannot use this procedure to make changes to the FTG Channel Map and FTG Installer Menu settings. Instead, refer to and use the processes described on pages 44 to 48 to reconfigure the TV CPU.

Note: If the preceding condition applies, but you wish to switch the TV to FTG Mode via EBL, refer to Reference section, "Restoring Factory Defaults on the TV(s)," for further information before proceeding.

1. Install (if necessary) and launch the FTG Device Configuration Application (v5.4.1 or higher) on the PC that will be used to configure the EBL.
2. Build an FTG Channel Map using the FTG Channel Map Editor in the FTG Channel Map Configuration Utility (or, if applicable, open an existing FTG Configuration [.rml] file).

Note: Up to 141 logical channels can be defined in the FTG Channel Map.

3. Connect the PC to the TV-LINK CFG jack on the TV's rear jack panel using a USB-to-TTL serial cable (TTL-232R-5V-AJ). If necessary, install the device driver on the PC.

4. Turn ON the TV.

Note: If Installer Menu item 118 POWER SAVINGS is set to 3 (default), the TV must be ON in order for steps 5 and 6 below to be successful.

5. "Write" the FTG Channel Map to the EBL (switches the EBL from Pass-through Mode to FTG Mode).

Note: After a "Write" of new data, the TV will briefly display a green text banner that shows the EBL firmware version and release date.

6. "Read" the current FTG Installer Menu settings from the EBL using the FTG Installer Menu Configuration Utility. If necessary to make changes to Installer Menu items, "Write" them back to the EBL in FTG Mode.

7. Save the FTG Channel Map and FTG Installer Menu settings to an FTG Configuration (.rml) file for future use.

8. Tune the TV to a logical channel in the FTG Channel Map.

22LQ630H Jack Panel

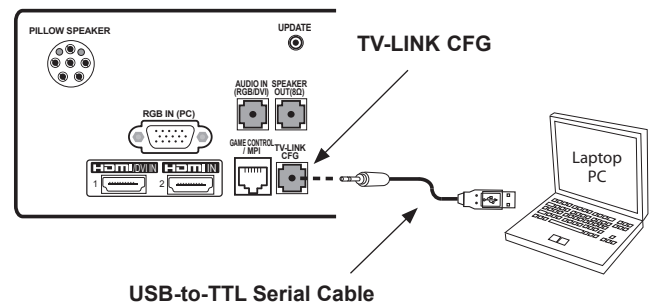

26/32LQ630H Jack Panel

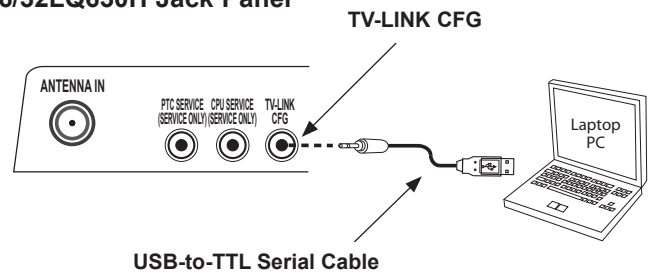

42CQ610H Jack Panel

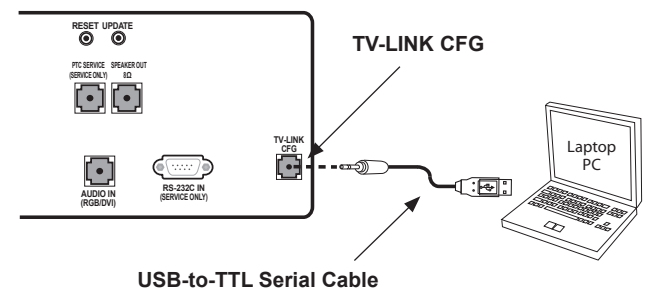

FTG File Manager Utilities Overview

FTG File Manager Main Screen

The FTG File Manager main screen enables you to compile, modify, and save FTG Configuration (.tlx) files.

The screenshot shows the FTG File Manager application window with the following components and annotations:

- FTG File:** A text input field for the filename of the opened FTG Configuration (.rml) file.
- FTG Channel Map:** Two sections for channel mapping: "21 Mapped RF Channels" and "0 Mapped IP Channels", each with a copy button.
- FTG Installer Menu Settings:** A section for installer menu settings, including a "Zone" dropdown menu and a copy button.
- Installer Menu Templates:** A section for loading default installer menu templates, including a "Chassis" dropdown menu and a "Load" button.
- FTG Configuration List:** A list view showing "21 Mapped RF Channels" and "20 IMS (Items Default) 26/32LQ630H". It includes "Clear" and "Save" buttons.
- TV Setup Menu List:** A list view for TV setup menu items, including an "Edit Zone" dropdown and a "Remove Item" button.
- TLX File:** A section for opening a TLX file, including a "New" button and an "Open" button.
- TLX File Contents:** A list view showing the contents of the opened TLX file, including a "Copy All" button.

Annotations on the left side of the screenshot:

- Filename of opened FTG Configuration (.rml) file created using FTG Device Configuration Application.
- Copy FTG Channel Map to and from FTG Configuration List.
- Copy FTG Installer Menu settings to and from FTG Configuration List.
- Load default FTG Installer Menu for appropriate LQ630H chassis or 42CQ610H chassis.

Annotations on the right side of the screenshot:

- FTG CONFIGURATION LIST**
Data to be saved in FTG Configuration (.tlx) file.
- CLEAR/SAVE**
FTG Configuration and TV Setup Menu List options.
- NEW/OPEN**
TLX File options.
- TV SETUP MENU LIST**
Data to be saved in FTG Configuration file.
- TLX FILE CONTENTS**
Data contained in opened FTG Configuration (.tlx) file.



Note: The data referenced in the FTG Configuration List is only a snapshot of the current FTG Channel Map and FTG Installer Menu settings when copied to the list. If you make any change(s) to the current data to be included in the FTG Configuration List, you will need to recopy Channel Map and Installer Menu settings to the FTG Configuration List.

FTG Channel Map Configuration Utility

The FTG Channel Map Configuration Utility enables you to create, view, edit, and print a Logical Channel Map.

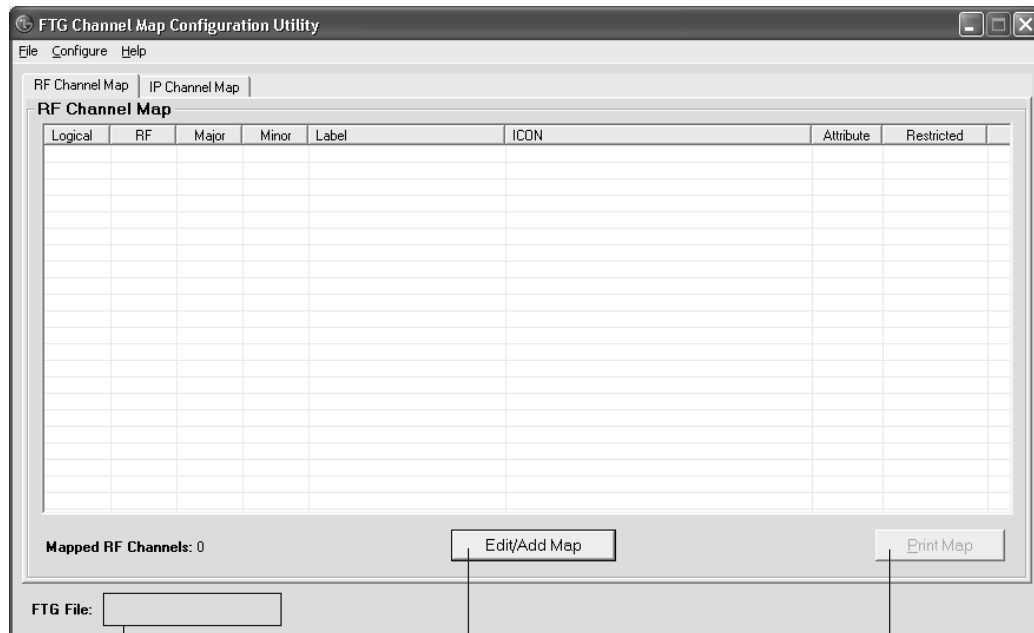

Filename of opened FTG Configuration (.rml) file created using FTG Device Configuration Application.

EDIT/ADD MAP
 Click to open the FTG Channel Map Editor to create or edit an FTG Channel Map (see next page).

PRINT MAP
 Click to display a printable FTG Channel Map Report. The report can also be exported as an HTML or Text file.

FTG File Manager Utilities Overview (Cont.)

FTG Channel Map Editor

The FTG Channel Map Editor shows a single Logical Channel's data and the FTG Channel Map.

LOGICAL CHANNEL MAPPING

Select a Logical Channel number. Then, assign it the RF, Major, and Minor channel numbers to complete the mapping.

CUSTOM CHANNEL LABELS/ICONS

Enter custom labels and select icons by name on menu or by number.

SET CHANNEL ATTRIBUTES

Check/select Encrypted, OSD, or Blank Video.

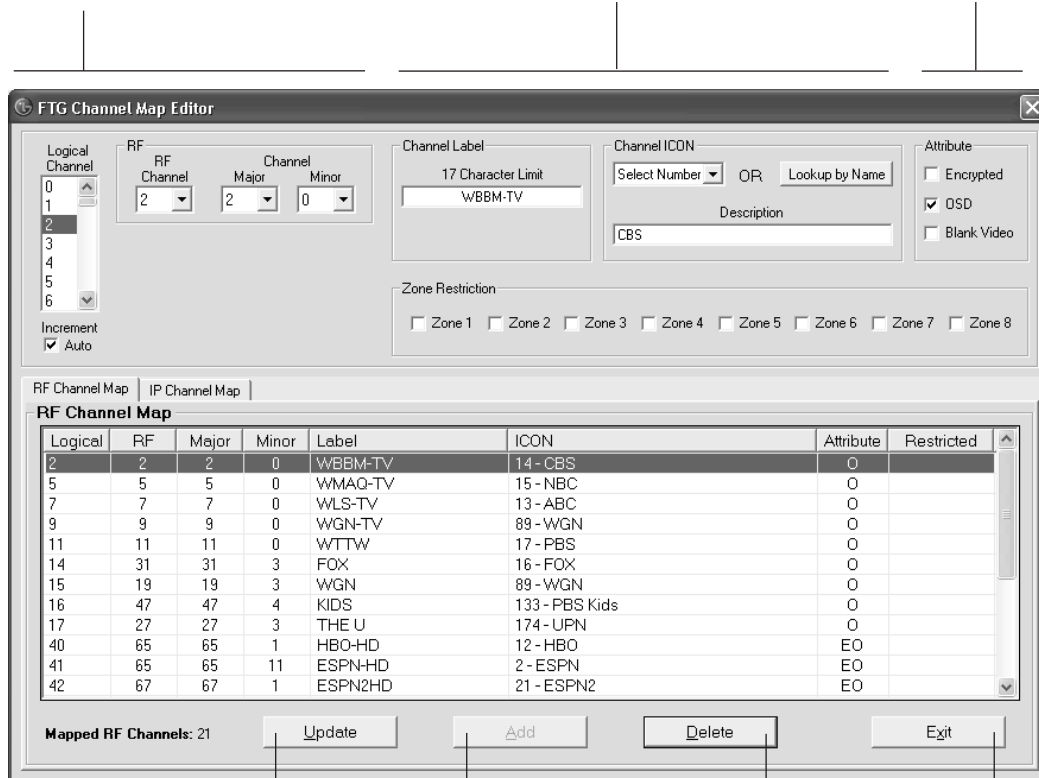

ZONE RESTRICTION

Select Zone restriction for channel. See Reference section, "TV Zone Restrictions," for further information.

ADD

After defining a new Logical Channel, click to add channel to the FTG Channel Map.

EXIT

Click to exit editor and return to FTG Channel Map Configuration Utility.

UPDATE

After editing an existing Logical Channel's data, click to commit the changes in the FTG Channel Map.

DELETE

Click to remove highlighted channel from FTG Channel Map.

FTG Installer Menu Configuration Utility

CONFIGURATION SETTINGS

Select tabs for categories of Installer Menu items to set up TV.

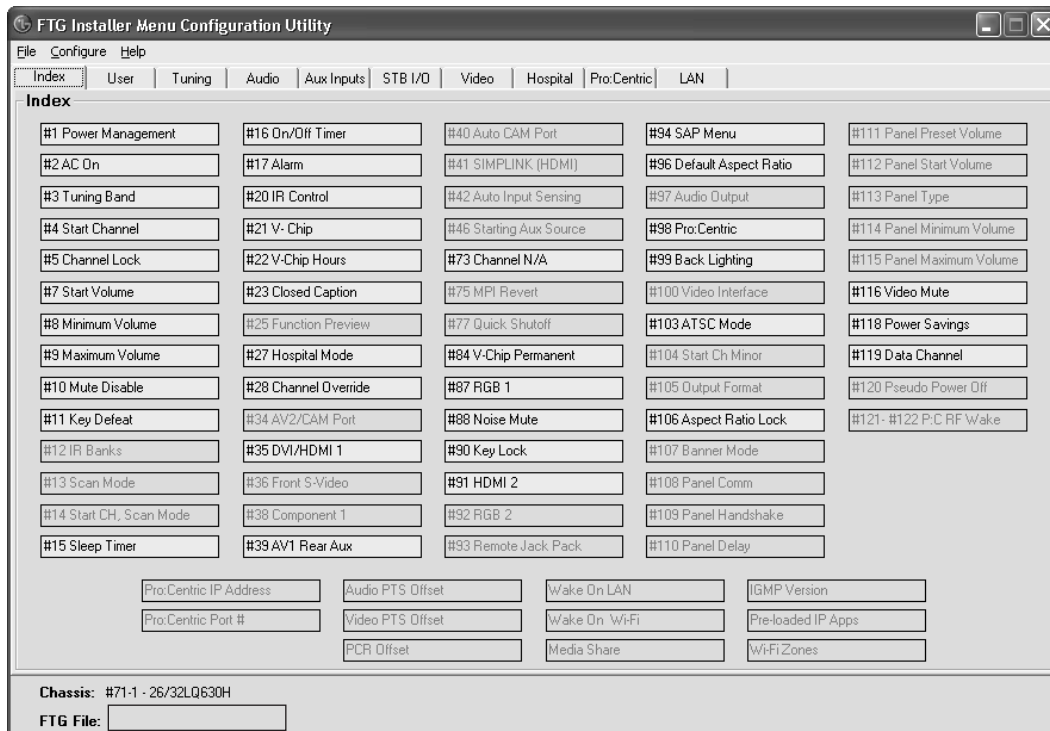

Filename of opened FTG Configuration (.rml) file created using FTG Device Configuration Application.

Note: The Pro:Centric tab enables you to set up Pro:Centric-specific parameters. Refer to the *Free-To-Guest (FTG) File Manager User Guide* for further information.

Reference: Upgrading TV/PTC Software using a USB Memory Device

Checking the Software Versions

You can check the software versions of the TV by accessing the Installer Menu with the Installer Remote (see “Accessing the Installer Menu” on page 19 for further information).

When you are finished, press **OK (Enter)** again to exit the Installer Menu.

Typical Installer Menu Footer

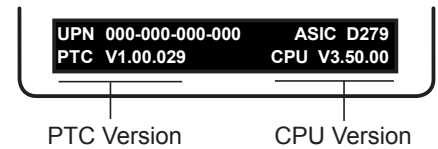

Upgrading TV/PTC Software

Before you begin, note that the software upgrade files must be stored in a folder named “LG_DTV” in the root directory of the USB memory device. Also, ensure the USB device has been formatted with FAT format.

Note for TV Software Upgrade only: If the TV detects a later version of software on the USB device, it will automatically display a dialog from which you can start the software upgrade immediately. Otherwise, you can close the dialog, and access the USB Download Menu as described below.

1. Turn ON the TV, and then insert the USB memory device into the USB IN port on the TV.
2. Press **MENU** on the Installer Remote to display the TV setup menus (TV is in Pass-through Mode) or the Function Menu (TV is not in Pass-through Mode).
3. Use the arrow navigation keys to select/highlight either the **Option** menu icon from the TV setup menus or the **Lock** menu icon from the Function Menu. Then, press the number “7” key a total of seven times to display the USB Download Menu.
4. Use the Up/Down arrow keys to select **Upgrade TV Software** or **Upgrade PTC Software**, as applicable, and then press **OK (Enter)**.
5. Select the appropriate option(s), depending on the type of upgrade:
 - TV Software Upgrade: (See screen samples at right.) Select **TV Software Update** from the first TV Software Update window. In the second TV Software Update window, select/highlight the update file to install and press **OK (Enter)**.
Note: Do not select Forced Update options unless you have been specifically instructed to do so or have previous experience with Expert Software Updates.
 - PTC Software Upgrade: In the PTC Software Update window, select/highlight the update file to install and press **OK (Enter)**.
Note: The PTC Software Update window is similar to the second TV Software Update window. Current software version information is shown at the top and update files on the USB device are listed at the bottom of the window.

The TV will show update completion progress in a new window. Do NOT remove the USB device until the software upgrade is complete. When a TV software upgrade is complete, the TV will reset itself with an automatic restart. When a PTC upgrade is complete, the TV will turn OFF.

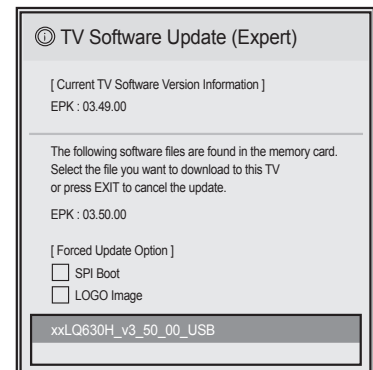
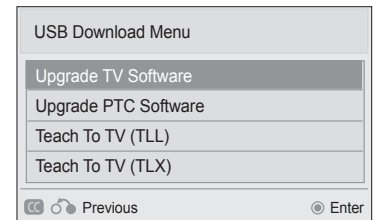

Reference: Downloading a Splash Screen using a USB Memory Device

Splash Screen Image File Guidelines

- The splash screen image must be a baseline (not progressive) 24-bit JPEG.
- The image should be no larger than 1 MB.
- The maximum resolution allowed for a 26/32LQ630H splash screen image is 1366 x 768 pixels (HD)
- The maximum resolution allowed for a 22LQ630H or 42CQ610H splash screen image is 1920 x 1080 pixels (FHD).
- Avoid using special characters, such as ?, -, etc., in the splash screen image file name.

Downloading a Splash Screen Image

Before you begin this procedure, note that the splash screen image file must be stored in a folder named “LG_DTV” in the root directory of the USB memory device. Also, ensure the USB device has been formatted with FAT format.

1. Turn ON the TV, and then insert the USB memory device into the USB IN port on the TV.
2. Press **MENU** on the Installer Remote to display the TV setup menus (TV is in Pass-through Mode) or the Function Menu (TV is not in Pass-through Mode).
3. Use the arrow navigation keys to select/highlight either the **Option** menu icon from the TV setup menus or the **Lock** menu icon from the Function Menu. Then, press the number “7” key a total of seven times to display the USB Download Menu.
4. Use the Up/Down arrow keys to select **Upgrade TV Software**, and then press **OK (Enter)**.
5. Select **LOGO Image Download** from the first TV Software Update window.
6. In the second TV Software Update window, use the Up/Down arrow keys to select the image file to download, and then press **OK (Enter)**.

The TV will show download completion progress in a new window. Do NOT remove the USB device until the image download is complete. When the image download is complete, the TV will reset itself with an automatic restart. Upon the restart, you should see the new splash screen.

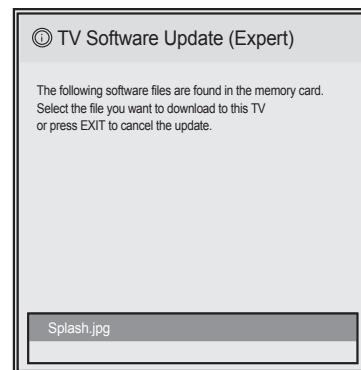
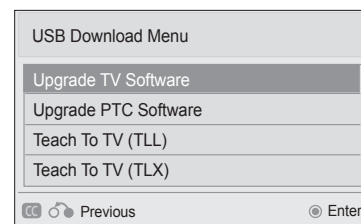

Reference: Power Consumption Settings

The following tables assume that Installer Menu item 118 POWER SAVINGS is set to 3 (default) and Installer Menu item 099 BACK LIGHTING is set as shown below (default value for LQ630H TVs is 255; default value for CQ610H TVs is 100).

Item 099 Back Lighting (Static)	22LQ630H		26LQ630H		32LQ630H		42CQ610H	
	Power Consumption (Watts)	Percent Savings	Power Consumption (Watts)	Percent Savings	Power Consumption (Watts)	Percent Savings	Power Consumption (Watts)	Percent Savings
100	23.0	0.0%	35.1	0.0%	50.0	0.0%	111.6	0.0%
90	22.4	3.5%	33.2	5.4%	46.8	6.4%	105.8	5.2%
80	21.6	6.5%	31.5	10.3%	44.0	12.0%	95.0	14.9%
70	21.0	8.7%	29.7	15.4%	40.7	18.6%	89.0	20.3%
60	20.3	11.7%	27.9	20.5%	37.7	24.6%	84.5	24.3%
50	19.5	15.2%	26.2	25.4%	34.6	30.8%	75.0	32.8%
40	18.8	18.3%	24.5	30.2%	31.5	37.0%	67.0	40.0%
30	18.1	21.7%	22.7	35.3%	28.7	42.6%	60.1	46.1%
20	17.4	24.8%	20.9	40.5%	25.5	49.0%	53.1	52.4%
10	16.7	27.4%	19.2	45.3%	22.4	55.2%	45.8	59.0%
1	16.0	30.4%	17.7	49.6%	19.5	61.0%	39.4	64.7%

Item 099 Back Lighting (Dynamic)	22LQ630H		26LQ630H		32LQ630H		42CQ610H	
	Power Consumption (Watts)	Percent Savings	Power Consumption (Watts)	Percent Savings	Power Consumption (Watts)	Percent Savings	Power Consumption (Watts)	Percent Savings
200	22.3	0.0%	34.0	0.0%	47.0	0.0%	107.0	0.0%
190	21.6	3.1%	32.3	5.0%	44.1	6.2%	102.0	4.7%
180	20.9	6.3%	30.6	10.0%	41.7	11.3%	92.0	14.0%
170	20.2	9.4%	29.5	13.2%	38.7	17.7%	87.0	18.7%
160	19.6	12.1%	27.7	18.5%	35.9	23.6%	83.0	22.4%
150	18.9	15.2%	26.1	23.2%	33.0	29.8%	75.0	29.9%
140	18.2	18.4%	24.3	28.5%	30.3	35.5%	67.4	37.0%
130	17.4	22.0%	22.5	33.8%	27.9	40.6%	60.1	43.8%
120	17.1	23.3%	20.8	38.8%	25.2	46.4%	53.2	50.3%
110	16.5	26.0%	19.1	43.8%	22.3	52.6%	45.7	57.3%
101	16.0	28.3%	17.6	48.2%	19.3	58.9%	39.0	63.6%

Note: Values are results of controlled experiments under laboratory conditions.

Reference: TV Aux Input Configuration

DIRECT ACCESS Tuning *		TV		ENABLE					MPI DATA				Installer Menu Item 046 START AUX SRCE (Start Aux Source) Value
				Installer Menu			MPI DATA STATUS TYPE 0x41 SOURCES ENABLED (R/W)		DATA STATUS TYPE 0xD2 CURRENT AV SOURCE (R)		DATA STATUS TYPE 0x0D AUX SOURCE (R)		
Installer Menu Item 029 OLD OCV = 0	Installer Menu Item 029 OLD OCV = 1	Aux Input	Input Mode	Item	Function	Value	Enable Bit	Label	Value	Value	Description		
131	91	Video1 (Rear)	CV/ SVIDEO	39	REAR AUX EN	1	1	Rear Video (Aux)	1	0	VIDEO	1	
132	92	HDMI2	DTV/ PC	91	YPrPb2 EN. (HDMI2 ENABLE)	1	2	S-Video Rear	2	0	VIDEO	5	
133	93	HDMI1/ DVI	DTV/ PC	35	COMP- PORT EN. (HDMI1 ENABLE)	1	3	Front Computer	3	0	VIDEO	3	
134	94	RGB	PC	87	REAR RGB EN	1	5	SVGA Rear Computer	4	2	COMPUTER	4	

* Use Installer Remote to enter channel number indicated based on OLD OCV Installer Menu setting.

Reference: *b*-LAN Setup & Overview

The *b*-LAN module is internal to the TV. It allows hospital/institution head end equipment with *b*-LAN technology to communicate, via the institution's RF distribution system, with the TV for configuration and control.

Installer Menu item 118 POWER SAVINGS controls the power circuitry for both the embedded *b*-LAN module and the GAME CONTROL/MPI port. The default value is 3—the *b*-LAN module as well as the GAME CONTROL/MPI port circuitry is only powered when the TV is turned ON. See chart below.

POWER SAVINGS	TV OFF	TV ON
	<i>b</i> -LAN & GAME CONTROL/MPI Port Power	<i>b</i> -LAN & GAME CONTROL/MPI Port Power
1	On	On
3 (default)	Off	On

A *b*-LAN enabled head end device, such as an LG FMA-LG101, broadcasts over the RF distribution system to communicate to multiple TVs. When the TV is first installed, it must be turned ON in order for its embedded *b*-LAN module to receive communication from the head end device. At this point, if it is desired for the *b*-LAN module to always be powered, including while the TV is in Standby, set Installer Menu item 118 POWER SAVINGS to 1.

Also, if MPI communication is required for external MPI control, set Installer Menu item 118 POWER SAVINGS to 1 so that the GAME CONTROL/MPI port circuitry is always powered.

 **Caution: POWER SAVINGS should NEVER be set to 7. This setting is intended for factory use only.**

Reference: LQ630H/CQ610H Hospital Operations

Hospital Features

The following table identifies when and how the LQ630H and CQ610H hospital features are supported in three different TV configurations. As indicated in the introduction to this document, LG commercial TV functionality is based on “ownership” of the Channel Map. For the purposes of this table, “CPU” indicates that the TV is in Pass-through Mode with the Channel Map in the CPU (i.e., auto-tuned/edited Channel Map) and “PTC” indicates that the TV is in Pass-through Mode with the Channel Map in the PTC (i.e., after 2-5-5 + MENU).

Hospital Mode State	Item	CPU		PTC		FTG/PPV Mode	
		Disabled	Enabled	Disabled	Enabled	Disabled	Enabled
Installer Menu	Item						
IR Banks Enable	012				X		
Scan Mode	013	(a)	(a)	X	X		
Start Channel in Scan Mode	014			X	X		
Feature Level	020						
Bed 1/Bed 2	020	X		X		X	
Multi-code IR	020	X	X	X	X	X	X
Speaker	020			X		X	
Function Preview	025			X	X		
Hospital Mode	027						
Bed 1/Bed 2	027		X		X		X
Pillow Speaker Voltage	027	(b)	X	(b)	X	(b)	X
Speaker	027	X	X		X		X
Quick Shutoff	077	(c)	(c)	(c)	(c)		
Channel Banks							
Number of Banks Enabled				1	4		
Channel Preview/Banks Setup Menu				X	X		
Blanked Channel				X	X	X	X
Inactive TV					X		
SAP Key					X		
Aux Input Sources							
Input List Menu		X	X	X		X	X
Aux in Scan List				X	X	(d)	(d)
TV Setup Menus							
Audio (TV Speaker)		(e)	(e)	(e)	(e)		
Option (Power Indicator)		X	X	X	X		

X = feature supported

- a) Turn ON function only. Always goes to channel 2-0.
- b) Defaults to Zenith pillow speaker code/(+12v) supply voltage.
- c) Quick Shutoff feature only functions when Scan Mode is enabled and if you are using an analog pillow speaker.
- d) Dependent upon installer-defined Logical Channel Map.
- e) Audio Menu is only accessible when the speaker selected is TV Only or both TV & Pillow.

Reference: LQ630H/CQ610H Hospital Operations (Cont.)

Note: Even if Scan Mode is enabled, the front panel channel keys cannot be used to turn ON the TV.

Note: The power indicator on the front panel of the TV has two different settings: one for when the TV is in standby and one for when the TV is turned ON. The Power Indicator option in the Option Menu enables you to define the behavior of the power indicator. For LQ630H TVs, the Standby Light default is OFF, while the Power Light default is ON. Note, however, if an LQ630H TV is in the default Hospital Mode, it is not possible to change the Power Indicator settings. This means that for LQ630H TVs, when Installer Menu Item 027 HOSPITAL MODE is set to 254, the power indicator will retain its default settings regardless of any changes made via the Power Indicator option in the Option Menu. For CQ610H TVs, both the Standby Light and Power Light defaults are ON, and the Power Indicator settings are not affected by the Hospital Mode.

Speaker Selection

The following table outlines speaker settings as determined by Installer Menu items 027 HOSPITAL MODE and 020 FEATURE LEVEL.

Item 027 HOSPITAL MODE Value	Item 020 FEATURE LEVEL Value	Audio Menu TV Speaker	Speaker
0	0 ~ 24	OFF	None
0	0 ~ 24	ON	TV Only
0	64 ~ 65	N/A	Pillow Only
1 ~ 34	N/A	N/A	Pillow Only
65 ~ 98	N/A	OFF	None
65 ~ 98	N/A	ON	TV Only
129 ~ 162	N/A	OFF	Pillow Only
129 ~ 162	N/A	ON	Pillow & TV

Note: If the TV is in FTG Mode, the Audio Menu is no longer accessible.

Reference: Restoring Factory Defaults on the TV(s)

This section describes how to restore factory defaults either on a single TV that is currently in Pass-through or FTG Mode or on multiple TVs that are currently in FTG Mode.

Note: If the TV(s) is/are currently in FTG Mode, restoring the factory defaults also resets the TV to Pass-through Mode.

Installer Menu Item 117 FACT DEFAULT

If the TV is currently in Pass-through Mode, you can set Installer Menu item 117 FACT DEFAULT to 1 to restore the factory defaults and clear the channel lineup, including any assigned channel icons and custom text labels.

Factory “IN-STOP”

If the TV is currently in FTG Mode, a predefined value for Installer Menu item 117 FACT DEFAULT enables access to initiate a factory “IN-STOP” process that will restore the TV to Pass-through Mode in addition to restoring all factory defaults. Contact technical support for the required value for Installer Menu item 117 and for additional information on performing the IN-STOP from the Installer Menu.

Additional FTG Mode via CPU Options

There are two additional options for restoring Pass-through Mode/factory defaults on TVs that are in FTG Mode via the CPU. The first enables you to restore a single TV to Pass-through Mode, while the second enables you to restore multiple TVs to Pass-through Mode at one time. However, both options require that you create a “Zero Mapped Channels” FTG Configuration (.tlx) file, i.e., an FTG Configuration file with no data. Refer to the *Free-To-Guest (FTG) File Manager User Guide* for further information.

- Using a USB memory device, “Teach” a “Zero Mapped Channels” FTG Configuration (.tlx) file to the TV. Refer to “Teaching FTG Configuration to a TV” on page 46 of this document for further information on the Teaching process.
- If your system uses a Pro:Centric server for remote management/administration, use the Pro:Centric Admin Client to load a “Zero Mapped Channels” FTG Configuration (.tlx) file on the Pro:Centric server. Refer to the *Pro:Centric Server Admin Client User Guide* for further information.

Additional FTG Mode via EBL Options

There are two additional options for restoring Pass-through Mode/factory defaults on TVs that are in FTG Mode via the EBL. The first enables you to restore a single TV to Pass-through Mode, while the second enables you to restore multiple TVs to Pass-through Mode at one time.

 **Note:** While the IN-STOP process described above will clear both the PTC and the CPU, both options below only clear the PTC. Thus, the current Channel Map and TV setup menu settings will remain in the CPU after the reset is completed.

- Using a direct PC-to-TV connection, “Write” an unpopulated Channel Map—that is, a Channel Map with 0 (zero) channels—to the TV. Refer to the “FTG Mode via EBL” procedure on page 49 and/or the *Free-To-Guest (FTG) Device Configuration Application User Guide* for further information.
- If your system uses an FMA for remote management/broadcast configuration, configure the FMA device with an FMA Configuration (.fma) file that only contains a “0 Mapped Channels” FTG Channel Map to broadcast to the TV EBL(s). Refer to the *Free-To-Guest (FTG) Device Configuration Application User Guide* and/or the Installation & Configuration Guide for the FMA device for further information.

Reference: TV Zone Restrictions

The FTG Channel Map Editor in the FTG File Manager's FTG Channel Map Configuration Utility enables you to assign Zone restrictions to individual channels that may be prohibited or deemed unsuitable for certain locations, for example, a hospital lobby. In the FTG Channel Map Editor, one or more Zone restrictions (1–8) may be placed on each channel that is to be restricted. For example, if you wish to restrict a channel from Zones 2 and 4, select both “Zone 2” and “Zone 4” in the Zone Restriction section of the FTG Channel Map Editor screen when defining or editing that channel.

On location, set the Zone # in all the TVs in a select area, or “Zone,” so that the TVs can omit channels that have been restricted in the FTG Channel Map. However, note that while a channel can be restricted from up to eight Zones, a TV can only ever be in (set for) one Zone. TV Zone 0 is the default TV Zone #. When the TV Zone # is set to 0, the TV will ignore any Zone restrictions (1–8) that may be placed on channels in the FTG Channel Map. However, when the TV Zone # is set to 1, during configuration, the TV will omit any channels that have been restricted from Zone 1 in the FTG Channel Map.

See the FTG Channel Map Editor overview on page 52. Also, see the **Free-To-Guest (FTG) File Manager User Guide** for further information on assigning Zone restrictions.

Use the following procedure to set a Zone # in the TV. Note that the procedure below can only be performed while the TV is in Pass-through Mode.

1. Turn ON the TV.
2. Press **MENU** on the Installer Remote, and use the arrow navigation keys to select/highlight the **OPTION** menu option. Then, press **OK (Enter)**.
3. Use the Up/Down arrows to select **Zone**, and then press **OK (Enter)**.
4. In the Zone pop-up window, you can set the Zone #, which allows the TV to omit channels that have been restricted in the FTG Channel Map. Use the Left/Right arrow keys to select the Zone # (1–8) for this TV. Then, press **OK (Enter)**.
5. Press **MENU** to return to TV viewing.

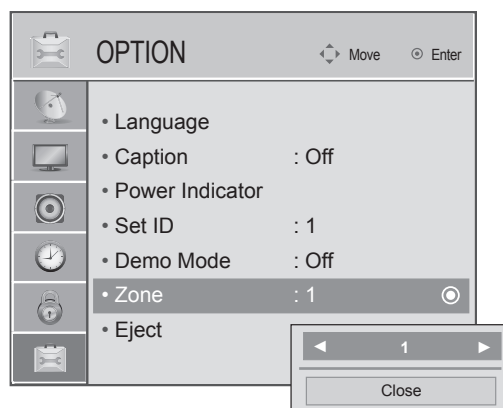

Reference: 22LQ630H Rear and Side Jack Panels

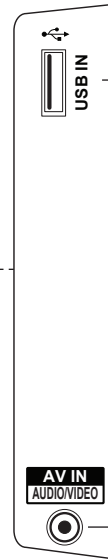
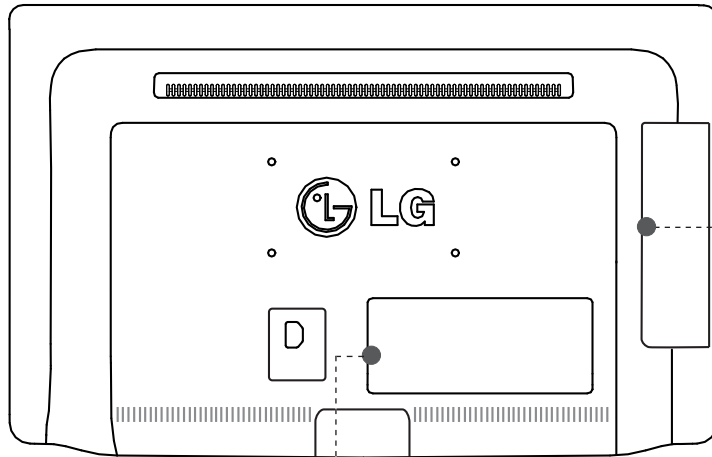

USB IN
Insert USB memory device for software updates, cloning purposes, FTG Mode via CPU configuration, picture/music entertainment, etc., as applicable.

AUDIO/VIDEO IN
(3.5 mm jack) Connect to video/audio output port on external device (use A/V adapter cable provided with TV).

AUDIO IN (RGB/DVI)
(3.5 mm jack) Audio connection for RGB or DVI device.

PILLOW SPEAKER
Connect pillow speaker here.

UPDATE
Restricted to software updates.

RESET
Initiates a hardware reset and turns the TV OFF.

SPEAKER OUT (8Ω)
(3.5 mm jack) Connect to 8 ohm speaker input. In its initial release, this stereo jack provides a mono speaker fixed-level, 1 watt output (audio -, audio +, w/ground shield) and is intended for special applications, such as a bathroom speaker with volume control. Later CPU & PTC software versions provide a selectable speaker output. See Reference section, "External Mono Speaker Setup," for further information.

CPU SERVICE (SERVICE ONLY)
Restricted to CPU service updates.

ANTENNA IN
Connect to Antenna/CATV.

PTC SERVICE (SERVICE ONLY)
Restricted to PTC service updates.

TV-LINK CFG
(3.5 mm jack) Use for direct PC-to-TV FTG configuration.

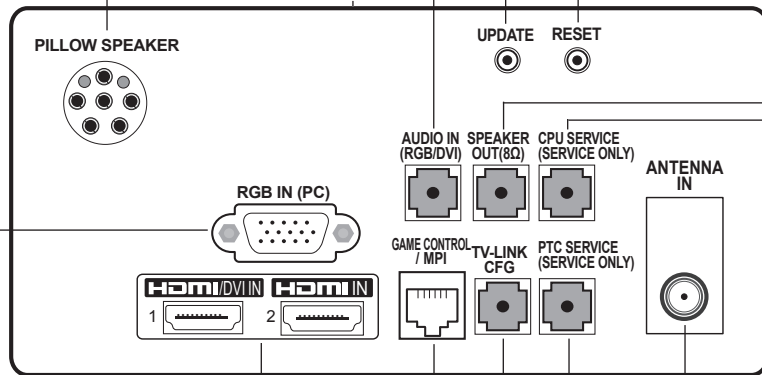

HDMI/DVI IN
Connection for HDMI/DVI output from external device.

RGB IN (PC)
Connection for RGB output from PC.

GAME CONTROL/MPI

When the TV/EBL is in Pass-through Mode, the MPI function enables an external MPI control device (i.e., clone programmer, VOD/PPV STB, etc.) to control the TV. Game Control—EBL in LodgeNet PPV Mode only.

Reference: 26/32LQ630H Rear and Side Jack Panels

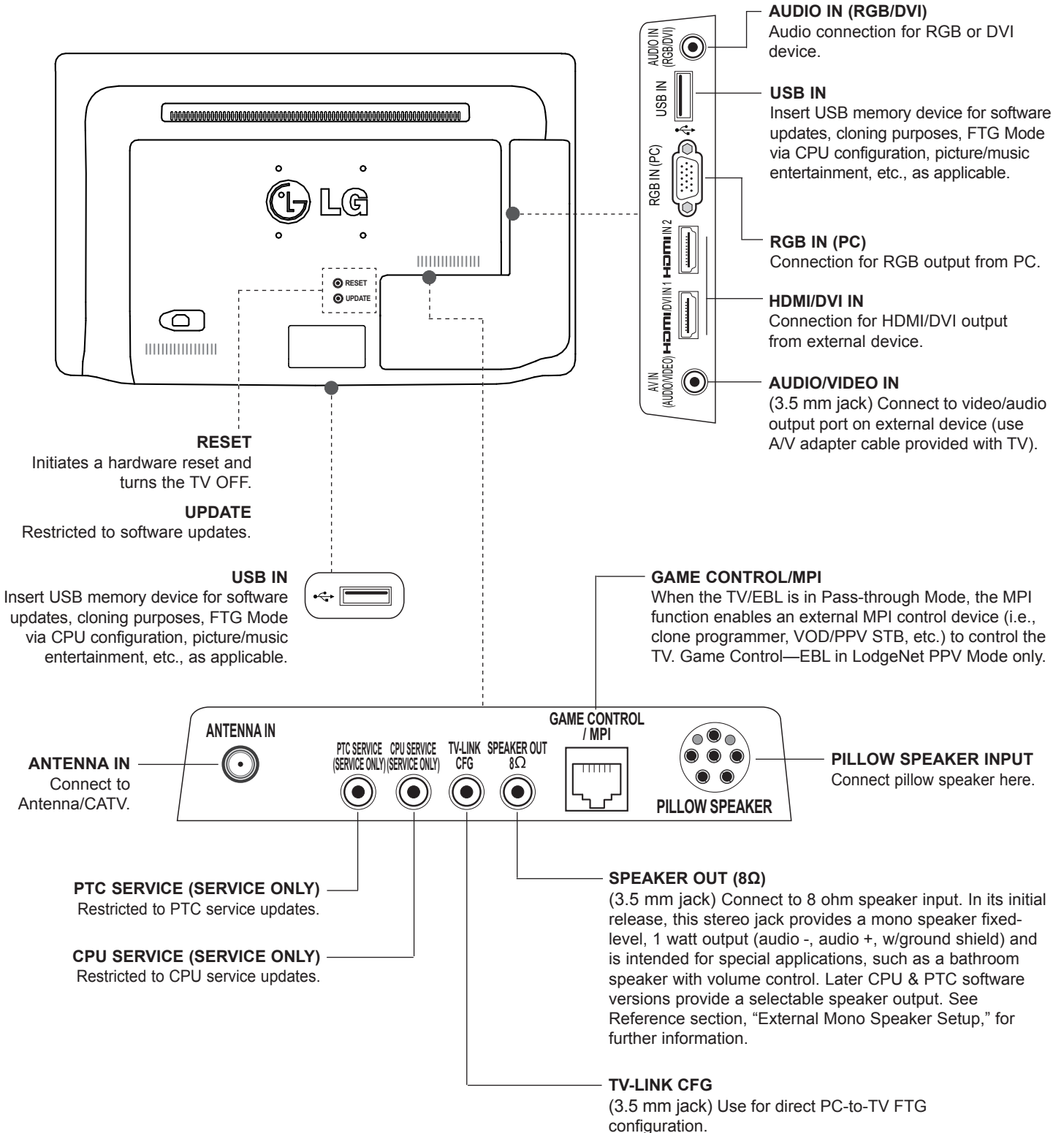

Reference: 42CQ610H Rear and Side Jack Panels

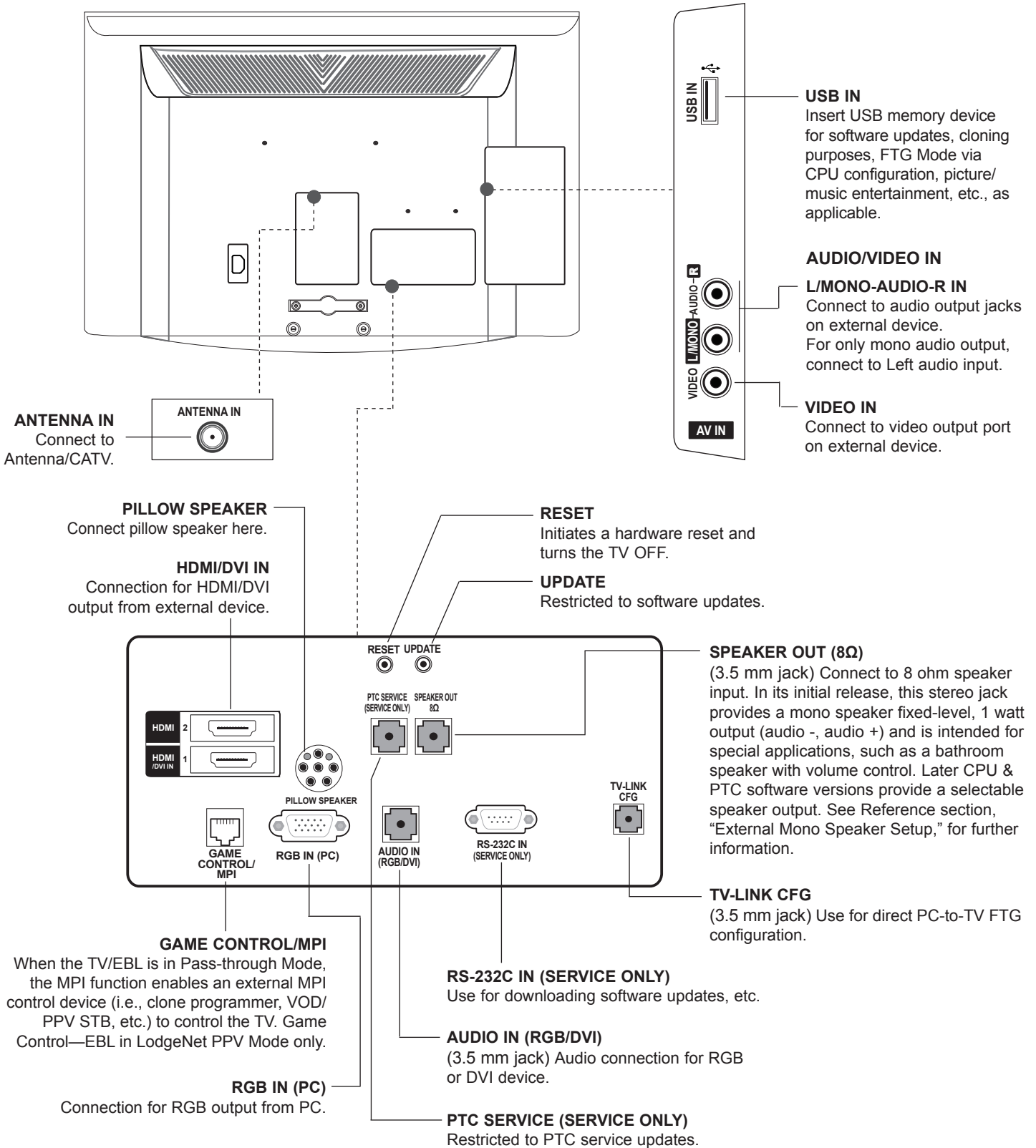

Reference: External Mono Speaker Setup

The three-contact SPEAKER OUT 3.5 mm jack on the LQ630H and CQ610H rear panels provides mono speaker level signal outputs (audio -, audio +) for a single 8 ohm external speaker. Refer to the following diagram for pinout details.

On LQ630H or CQ610H TVs with software earlier than CPU v3.50.00 and PTC v1.00.029, this stereo jack provides a fixed-level 1 watt output. On LQ630H or CQ610H TVs with CPU v3.50.00 and PTC v1.00.029 or later, you can set Installer Menu item 097 AUDIO OUTPUT as the application requires for different fixed speaker levels or variable speaker output.

⚠ Caution: Do NOT plug in a mono connector, as this may damage the TV.

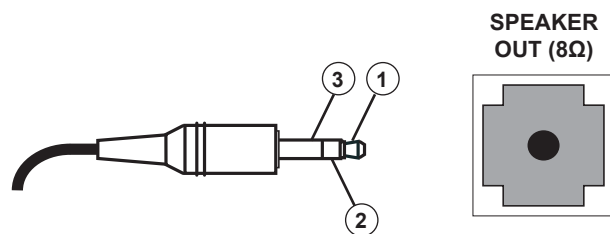

-
- | | |
|---|------------------------------|
| 1 | EXTERNAL SPEAKER - (Tip) |
| 2 | EXTERNAL SPEAKER + (Ring 1) |
| 3 | GND (LQ630H) / NC (42CQ610H) |
-

Reference: Installer Remote Control Typical Key Functions

An LG Installer Remote (p/n: 124-213-07) is required to set up and operate the TV. The LG Installer Remote illustrated below shows typical remote control functions and is provided for reference only. This Installer Remote may vary from the Installer Remote supplied with the TV.

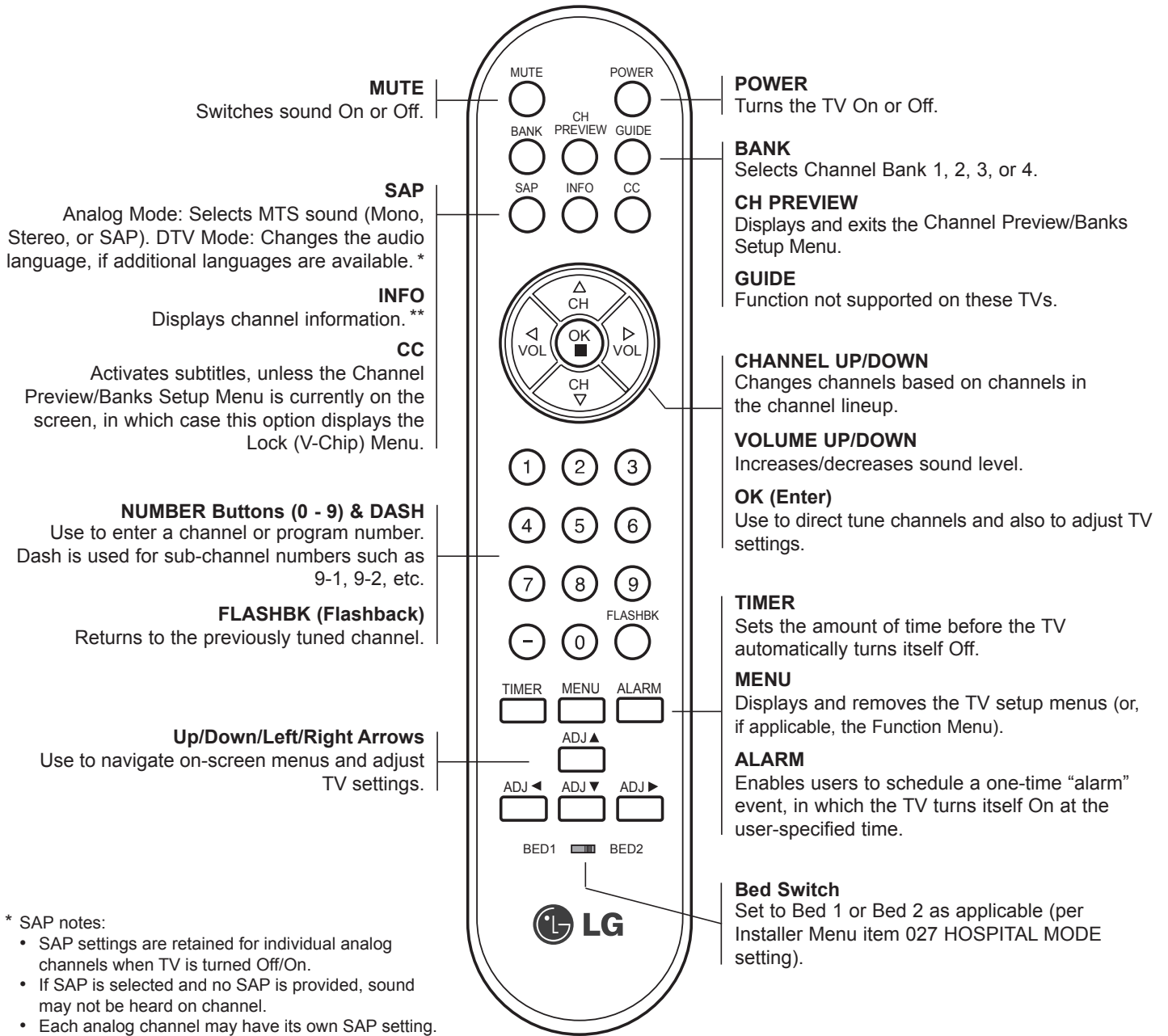

* SAP notes:

- SAP settings are retained for individual analog channels when TV is turned Off/On.
- If SAP is selected and no SAP is provided, sound may not be heard on channel.
- Each analog channel may have its own SAP setting.
- Digital channels will reset to default audio language when TV is turned Off/On.

** The INFO feature is only applicable if the TV is configured for Pro:Centric operation.

Reference: Pillow Speaker Setup

The pillow speaker will only be functional after the Express Script/Custom Master TV Setup and/or cloning procedures are complete.

Note: When Installer Menu item 027 HOSPITAL MODE is set to 254 (factory default value), there is no power (voltage) supplied to the pillow speaker.

Connect a Pillow Speaker to the LCD TV

Connect the pillow speaker (see example at right) to the PILLOW SPEAKER interface on the rear jack panel of the TV.

Caution: Use a pillow speaker that is a UL recognized pendant control bearing the warning: “Risk of fire if used in oxygen enriched atmosphere. Keep pendant control away from oxygen equipment.”

Controlling the TV with Serial Data

These TV models are capable of being controlled by a single-wire, serial data signal. This is an LG patented technology and is being implemented by certain brands of “smart” pillow speakers.

Pillow Speaker Interface

This connector provides an interface for patient-pendant remote control or entertainment audio and nurse call systems. All lines are isolated from the AC power line. (Optoisolators isolate the control lines, and a transformer isolates the audio.) Earth ground is provided on pin 4 (Common) in the default configuration (e.g., for Zenith/Philips pillow speakers). For negative voltage configuration (e.g., for RCA pillow speakers), +5 volts is provided on pin 4 (Common), with pin 3 (Channel Up/Data In) referenced to ground.

The following table describes the pillow speaker interface pinout (see also diagram at right).

Pin No.	Description
1	Analog external control for TV ON/OFF.
2	No connection
3	Analog external control for Channel Up or Serial Data In.
4	Common connection for control, data, and audio output.
5	Isolated Audio Output. Nominal 14 ohm source impedance with short circuit protection. Intended for a pillow speaker with a low-impedance, pad-type volume control.
6	Analog external control for Channel Down.

Controlling the TV with Mechanical Switches

A typical analog pillow speaker with mechanical switches will momentarily connect pin 1, 3, or 6 to pin 4 (Common) to control Power ON/OFF, Channel Up, or Channel Down (see schematic at right). These pins are at +13 volts DC (when measured from pin 4) with the switches open. Typical current draw is 8 mA when a switch is closed. (This operation is identical to previous models using the 5-wire interface, except that only +7 volts DC was supplied and current draw was only 2.5 mA.)

Typical Pillow Speaker (Serial Data Control)

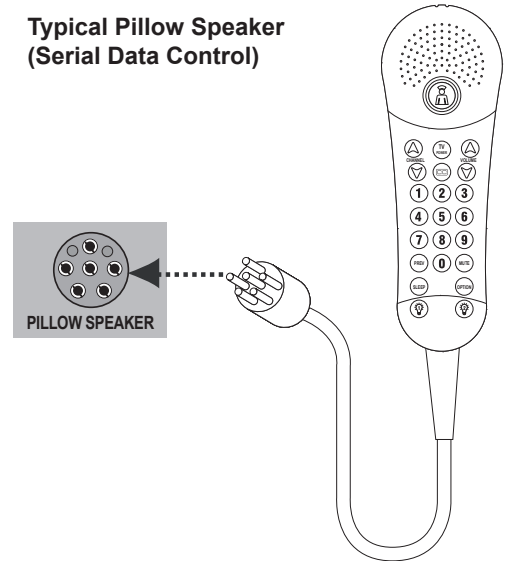

Pillow Speaker Interface Pinout

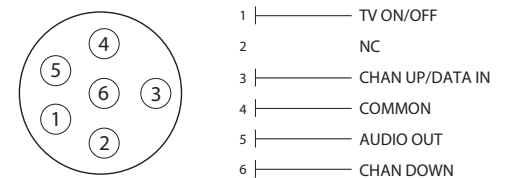

Typical Schematic for Analog Pillow Speaker

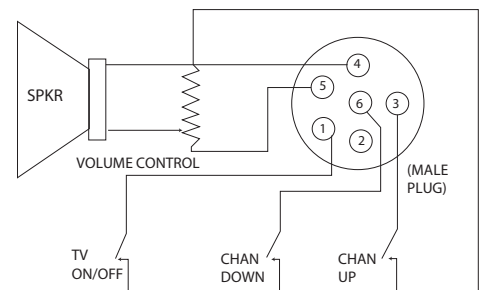

Reference: USB Media Navigation using Pro:Centric Pillow Speaker

The Pro:Centric pillow speaker is currently the only pillow speaker that enables users to navigate and play/view USB media files (videos, music, photos, etc.). This section provides a brief overview of the Pro:Centric pillow speaker navigation tools.

Note: Refer to the Owner's Manual for detailed information on USB memory device requirements and the types of media supported by the LQ630H and CQ610H TVs.

1. Insert the USB memory device into the TV's USB IN port.

Once the TV detects the USB device, the Media Menu will be displayed on the TV screen. (The actual menu header shown on the TV screen will reflect the name of your USB device.)

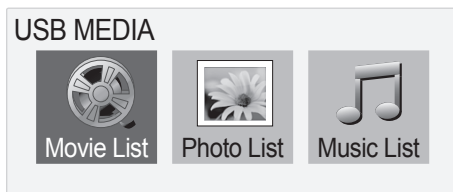

Note: If you press the Return button on the pillow speaker, this will exit the Media Menu. If you wish to redisplay the menu, you must physically remove and then reinsert the USB memory device. It is not possible to display the Media Menu using the pillow speaker alone.

2. Use the arrow keys on the pillow speaker to select/highlight the desired menu option, and then press **Enter**.
 3. Within each USB media directory (Movie List, Photo List, or Music List):
 - Use the arrow keys on the pillow speaker to navigate from one folder or file to another, and press **Enter** to open or play a selected folder or file.
 - If there are multiple pages of folders and/or files, use Channel Up/Down on the pillow speaker to move between the pages. At the top right corner of the display, a "Page" indicator will identify the number of pages available in the current directory.
 - Additional menu options are listed at the bottom of the display (each corresponds to a number button on the pillow speaker). These typically enable you to change directories, change the number of thumbnails shown at one time, mark files (to add to play lists), etc.
- Note:** To exit the Media Menu from any of the three USB media directories, press **0** on the pillow speaker. If you wish to redisplay the Media Menu, you must physically remove and then reinsert the USB memory device.
- In View and Play modes, you typically can use the pillow speaker to navigate to another directory level (without exiting the Media Menu).
 - To exit the directory/Media Menu entirely, either press **0** or **Return** on the pillow speaker.

Refer to the Owner's Manual for additional information on the Media Menu and directory options.

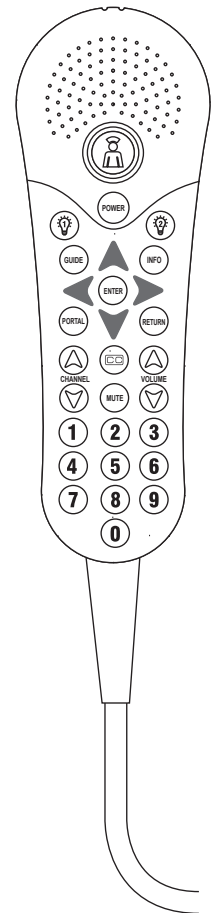

**Typical Pro:Centric
Pillow Speaker**

Reference: VESA Standard TV Mounts

General Guidelines: Choosing a Location for Installing a VESA Standard Mount

To the right are some examples of VESA standard mounts. Since there are numerous types of stands and mounts available, only a few are shown here. Refer to the instructions provided with the TV stand that will be used to mount the TV. Be sure the style of stand selected is capable of supporting the weight of the TV and is appropriate for the application.

Wall Mounts

If the mount will be on a wall, a typical wooden stud behind the wall board would be the preferred choice for a location to attach the wall mount. The wall mount location chosen should be appropriate for drilling holes and have available the required power source as well as antenna/cable and any other equipment leads as necessary.

Pedestal Mounts and Stands

A sturdy surface on a desk or other similar flat table-like furniture would be the appropriate location for mounting a pedestal-style TV stand.

Most stands are designed so that the wiring is threaded through the stand itself or a loop-through style clamp so that the wiring is neatly bunched and not strung in such a way as to create a potential hazard to the user. (Some stands are portable and can be moved from one location to another.) Be sure all safety considerations are followed.

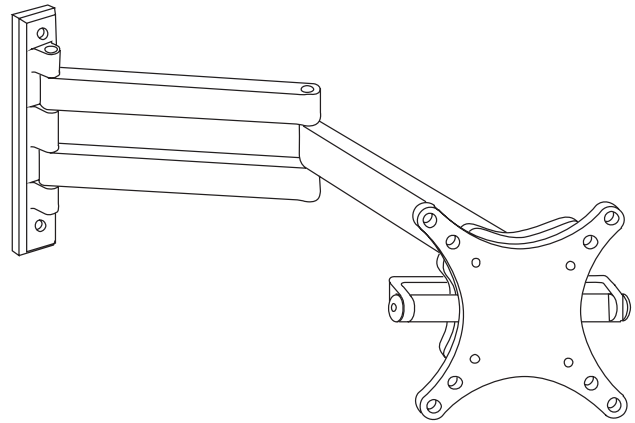

Typical Wall Stud Type Mount with Swivel Bracket

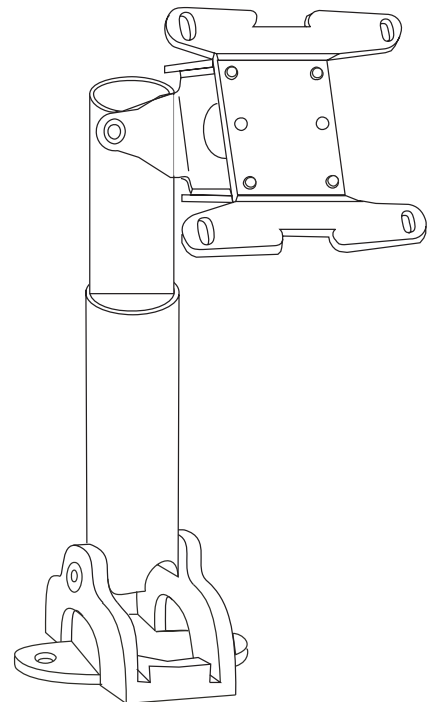

Typical Pedestal Type Mount with Swivel Bracket

General Troubleshooting (Some Quick and Easy Tips for Resolving Problems)

Installation

Symptom	Possible Cause(s)	Possible Solution(s)
Cannot direct enter channel number.	(TV in Pass-through Mode) Installer Menu item 028 CH. OVERRIDE is set to 0, i.e., disabled and/or Channel Access was denied in Express Script.	If the channel lineup is locked (recommended setting), only channels that are active in the TV's channel lineup can be selected. Set 028 CH. OVERRIDE to 1 to allow access for direct keypad entry to all channels.
	(TV in FTG Mode) The channel entered is not part of the FTG Channel Map.	Channel access is restricted to channels included in the FTG Channel Map. If necessary, make changes to the FTG Channel Map using the FTG File Manager or the FTG Device Configuration Application, as appropriate.
No channels present after setup.	Auto Tuning (Channel Search) not run.	Refer to Express Script or Custom Master TV Setup procedure, as appropriate. Auto Tuning must be run in order for the channel lineup to be populated. Note for Express Script: You must select "Execute Auto Search" in the Auto Search screen to run search (see page 12). To re-activate the Express Script, set Installer Menu item 117 FACT DEFAULT to 1.

Picture Reception and Sound

Symptom	Possible Cause(s)	Possible Solution(s)
No picture.	TV is turned OFF.	<ul style="list-style-type: none"> • Turn TV ON. • Power failure?
	Antenna/cable not connected.	Connect antenna/cable signal to TV.
	Connections incorrect.	Check connections on TV.
	MPI not connected.	If applicable, connect MPI cable to MPI device.
	Encrypted program.	Try another channel.
Normal picture, poor or no sound.	Wrong tuning band.	Adjust Installer Menu settings.
	Broadcast problem.	Try a different channel.
	Audio muted.	Press MUTE or use Volume Up key to increase sound level.
	Pillow/TV speaker not configured properly.	Check that Installer Menu items 020 FEATURE LEVEL and 027 HOSPITAL MODE are set as required. Also, if applicable, select TV Speaker in the Audio Menu.

Erratic Operation

Symptom	Possible Cause(s)	Possible Solution(s)
Installer Menu setup.	Wrong Installer Menu settings.	Adjust Installer Menu settings as required.

Installer Remote

Symptom	Possible Cause(s)	Possible Solution(s)
Remote doesn't work.	Remote not in TV Mode.	Use MODE key to select "TV"; puts remote into TV Mode.
	Not aimed at IR remote sensor.	Point remote at TV's IR receiver on TV.
	Remote too far from IR sensor.	Move remote closer to TV's IR receiver or darken room.
	MPI not connected.	If applicable, connect MPI cable to MPI device.
	IR path to TV's receiver obstructed.	Remove obstructions.
	Weak batteries.	Replace batteries.
	Wrong battery polarity.	Check that "+" and "-" match in battery compartment.
	Too much light in room.	Dim room light.
	Bed Switch set to wrong bed.	Set switch to Bed #2 unless TV has been configured for Bed #1 setting.
Wrong Installer Remote.	Requires compatible Installer Remote. Contact your LG dealer.	

Troubleshooting (Cont.)

Troubleshooting Flow Chart (No Power)

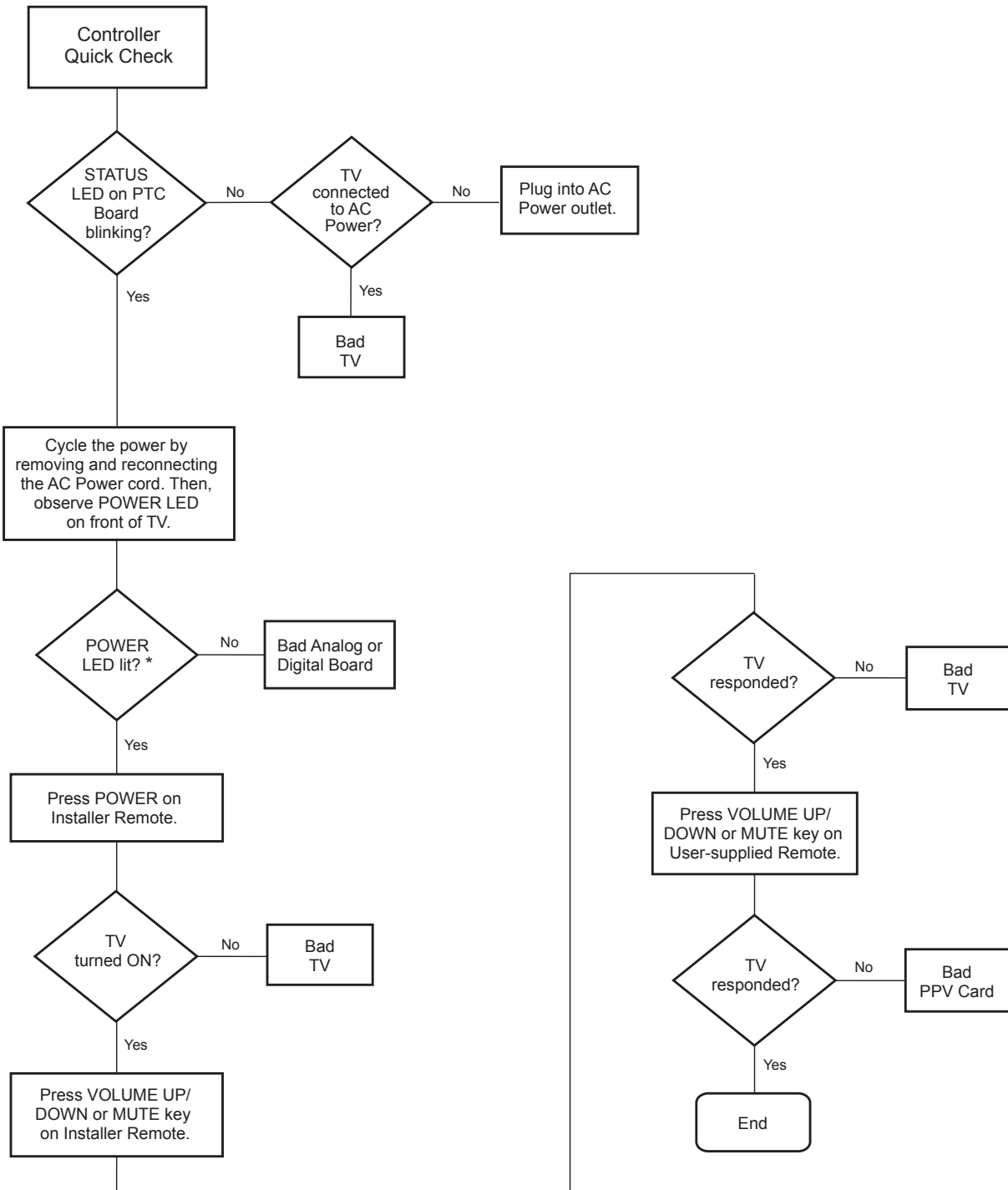

* If the Power Indicator/Standby Light option in the Option Menu is set to OFF, the POWER LED will not remain lit. Continue to the next step. (See also note regarding power indicator on page 60.)

Commercial Mode Check / FTG Operation Troubleshooting

Commercial Mode Check

Use this flowchart to determine whether the TV is currently in Commercial Mode.

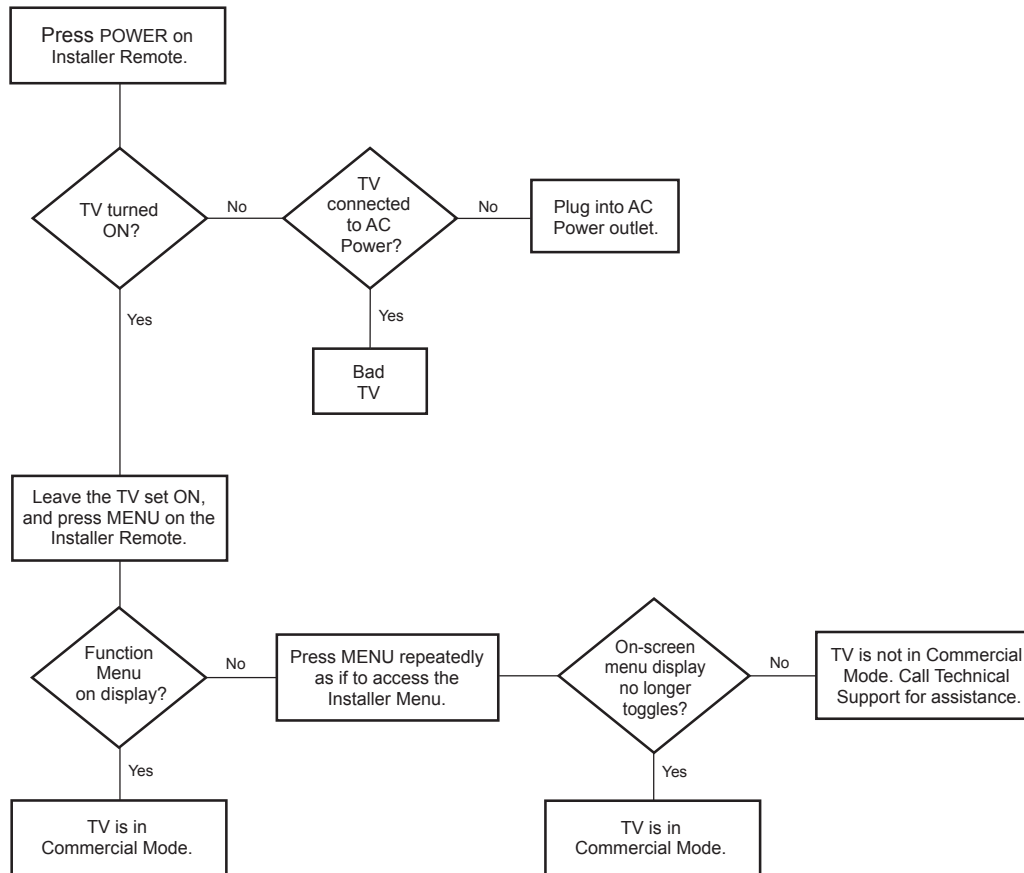

FTG Operation Troubleshooting

The following table provides troubleshooting information for when the EBL is configured in the FTG Mode of operation.

Symptom	Possible Cause(s)	Solution(s)
Communication Error ("Communications Timeout")	Cable(s) not connected.	Check and connect communication cables.
	TV not powered.	Check/connect the TV power cord.
	TV not turned ON.	TV needs to be turned ON (default setting of Installer Menu item 118 POWER SAVINGS).
	Wrong COM (communication) port.	In the FTG Device Configuration Application, select the correct COM port for the cable being used.

Troubleshooting (Cont.)

Clone Programmer Troubleshooting

 **Caution:** If the TV is in LodgeNet PPV Mode or FTG Mode via EBL (check with the site administrator if you are not certain), do not connect a clone programmer to the GAME CONTROL/MPI port, as this will damage the clone programmer.

Reset Clone Programmer After Static Shock

After replacing exhausted batteries (LT2002 only), or if the clone programmer behaves strangely after a static shock:

- TLL-1100A: Turn the TLL-1100A OFF and then ON.
- LT2002: Use a paper clip or similar instrument inserted through the small hole marked RESET to activate the internal reset switch and restore normal operation.

After a reset, check the real-time clock setting. It may be necessary to reset the clone programmer clock from a TV containing the correct time.

Note: See also IMPORTANT CLONING INFORMATION on page 33.

Clone Programmer

Symptom	Possible Cause(s)	Possible Solution(s)
Clone copies setup in less than 30 seconds.	Not enough time to copy entire TV setup.	TLL-1100A: Turn the TLL-1100A OFF and then ON. LT2002: Press RESET on clone programmer. Then redo Learn/Teach. (Learning usually takes about 90 seconds; Teaching usually takes 3 to 4 minutes.)
Remote does not operate clone programmer.	Wrong Installer Remote.	Only use an LG Installer Remote to operate clone programmer with TV.
Clone menu does not display on TV screen, TLL-1100A shows error message, or LT2002 LED does not blink.	MPI cable not connected.	Connect MPI cable properly, and ensure good connection.
	TV not turned ON.	TV must be turned ON for clone programmer to work.
	(LT2002 only) Weak batteries. (TLL-1100A only) No charge.	Install four (4) fresh AA high-quality alkaline batteries. Ensure the TLL-1100A is fully charged or connected to AC power.
Clone menu hard to read.	Weak signal.	Connect TV to a reliable analog channel signal source.
No time set.	Time not available.	Set time on a TV, and copy time to clone programmer.
Clone not working.	Clone programmer problem.	<ul style="list-style-type: none"> • Try a different clone programmer. • Reset the clone programmer.
Clone scans channels more than once.	Clone should only scan channels once.	Ensure TV is set up correctly, and try cloning again.

Master and Target TVs

Symptom	Possible Cause(s)	Possible Solution(s)
Cloning did not work.	Procedure interrupted.	Wait until procedure complete message is displayed.
	Different TV models.	Cloning is only possible with identical model TVs.
	Step(s) omitted or not performed.	Refer to the applicable cloning procedure(s), and make sure all tasks were performed.
(LT2002 only) Clone time disappeared.	Batteries were removed.	Batteries must remain installed to retain time settings.
New setup not present.	Target TV not reset.	Disconnect Target TV from AC power for 15 seconds.

- After cloning operations are complete, unplug the TLL-1100A/LT2002 from the TV.
- If the TV does not display a picture (blank screen) after a few seconds, just change channels.

Channel Banks Setup Troubleshooting

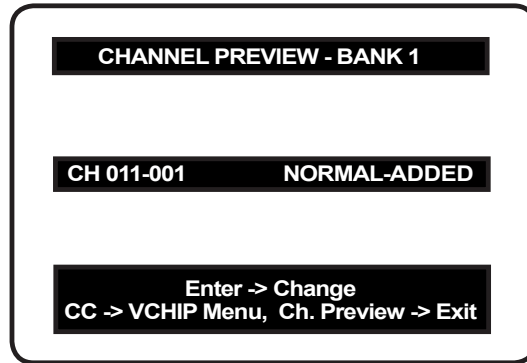

Channel Preview/Banks Setup Menu

Symptom	Possible Cause	Possible Solution
Cannot change channel status in menu.	Channel Access was denied in Express Script and/or Installer Menu item 028 CH. OVERRIDE is set to 0.	Set CH. OVERRIDE to 1 to allow access for channel status change.
Channel Preview/Banks Setup Menu does not appear.	Express Script Installer Menu Wizard/ 2-5-5 + MENU (Custom Master TV Setup) not completed/performed.	The Channel Preview/Banks Setup Menu will not be available until the TV setup is transferred to the PTC. Also, set Installer Menu item 028 CH. OVERRIDE to 1 to allow access for channel status changes.
Channel is blanked in all channel banks.	Blanking a channel in one channel bank will make it blank in all channel banks.	
Cannot tune in deleted channel on Channel Preview/Banks Setup Menu.		Select a channel bank where the deleted channel number is set to NORMAL-ADDED. Direct enter the deleted channel number. Change to the bank in which you want to activate the channel. Select "NORMAL-ADDED" on the Channel Preview/Banks Setup Menu.
"Inactive TV" message appears and then TV turns OFF.	TV is set up to display "Inactive TV" message if all channels are "NORMAL-DELETED" from Channel Bank 4.	Select another channel bank (1, 2, or 3) to return TV to normal operation.
Channel found during Auto Tuning does not tune in with Channel Up/Down.	Channel was deleted in currently selected channel bank.	If banks were set up, premium channels may only be available on another channel bank. Select the channel bank where the channel is set to NORMAL-ADDED. Or, direct enter channel number; then go to Channel Preview/Banks Setup Menu and select "NORMAL-ADDED."
When BANK on Installer Remote is pressed, TV shows Input List Menu.	Installer Menu item 027 HOSPITAL MODE is set to 0.	Set item 027 to appropriate setting for channel banks to appear with BANK key presses.

Glossary of Terms

b-LAN

LodgeNet Interactive Corporation proprietary RF communication system used to configure/control TV via RF distribution system.

Channel Map

Typically refers to a logical channel mapping of physical channels. This allows digital channels, like analog channels, to be tuned without requiring the dash key. Also, channels (analog or digital) can be arranged in any order that seems logical for customer tuning/viewing.

Channel Lineup

Channels set in the TV memory, via Auto Tuning/manual editing or FTG configuration.

Channel Banks

Enables tiered channel programming options for hospital models. Each channel bank may offer a custom channel lineup.

Cloning

The process of capturing a Master TV Setup and transferring it to a Target TV. May be accomplished using either a USB memory device (available on select models) or clone programmer.

Clone Programmer

An accessory device (sold separately), such as the TLL-1100A or LT2002, used to transfer the Master TV Setup from the Master TV to the Target TV.

Commercial Mode

A mode of operation that provides a broad range of commercial TV features based on control (settings) provided by the PTC and/or an MPI control device.

CPU

The TV's Central Processing Unit. Responsible for the presentation of video and audio from content received via the TV's tuner or Aux inputs.

EBL

Embedded *b-LAN* module. See also *b-LAN*.

Express Script Installer Menu Wizard

Hospital model TV configuration wizard that guides the installer through the process of setting up essential hospital model features for a typical viewing application.

E-Z Installation

Enables splash screen image and TV configuration and firmware file downloads to selected TV models from a Pro:Centric server. Managed and administered via the Pro:Centric Admin Client.

FTG Mode

LG commercial TV mode that enables Pro:Idiom decryption and logical channel mapping. Implementation and TV operation is based on the "owner" of the FTG Logical Channel Map—the CPU or the EBL. LG's proprietary PC software is required for configuration.

Function Menu

Available via Installer Remote "MENU" key. Indicates the TV is not in Pass-through Mode. Restricts menu options to a subset of the TV setup menus, allowing users to retain functional control, while disabling setup options.

Installer Menu

Defines commercial TV functionality based on the parameters set.

LG Free-To-Guest (FTG)

Refers to a particular commercial mode of operation within an LG TV. See also FTG Mode.

Logical Channel Number

A number assigned to either a physical or virtual channel number in a Logical Channel Map.

Major Channel Number

Typically, the RF channel number assigned to a digital video stream.

Master TV

A TV whose Channel Map and Installer Menu and TV setup menu settings have been configured as a Master TV Setup for cloning purposes.

Minor Channel Number

A sub-channel or program number assigned to the content embedded in the digital video stream.

MPI

Multiple Protocol Interface. An MPI port or, for some TV models, an MPI card slot provides external control options for solution providers.

Pass-through Mode

The TV's factory default mode of operation. TVs can be configured for stand-alone use or as Master TVs for cloning purposes, and/or TVs may be controlled externally in this mode.

Physical Channel Number

The major channel number assigned to represent a specific 6 MHz RF band as specified by either the broadcast or CATV channel plan. See CEA (formerly EIA) or NCTA specifications for further information.

Pillow Speaker

A wired remote control for patient in-room hospital model TVs. The pillow speaker also may be connected through a nurse call system providing two way communication between the patient and the nurses' station. TV audio can be configured to originate from the pillow speaker or the TV main speakers or both.

Pro:Centric Application

LG content delivery and communication interface that provides interactive entertainment, weather, amenities, etc. information for end users. (Powered by Pro:Centric server.)

Pro:Centric Admin Client

Web editor/content wizard provided for service provider and customer configuration of Pro:Centric application elements.

Pro:Idiom

Zenith proprietary security software that unlocks access to premium content to help assure rapid, broad deployment of HDTV and other high-value digital content.

PTC

Protocol Translator Card. The commercial controller (microprocessor) of the commercial TV.

Target TV

A TV to which a Master TV Setup will be transferred.

TV Setup Menus

Available via Installer Remote "MENU" key in Pass-through Mode only. Menus provide access to setup and functional features of the TV.

USB Memory Device

A USB flash drive or USB storage device, etc. that can be used for TV configuration purposes (typically cloning or FTG Mode via CPU configuration) or for updating TV software.

Virtual Channel Number

An alias (virtual) channel number provided in the data stream, by the broadcaster, of a digital broadcast channel to be displayed by consumer TVs in place of the physical channel number. The major number is the same as the original analog channel number and the minor number is the nth program available in that digital video stream.

Document Revision History / Open Source Software Notice

Document Revision History

Date	Description
February 2012	Revision A: New document
February 2012	Revision B: Additional USB port for 26/32LQ630H
March 2012	Revision C: CQ610H information added
July 2012	Revision D: Pro:Centric operation, Express Script, and Installer Menu updates
August 2013	Revision E: Updates in conjunction with CPU v3.50.00 and PTC v1.00.029

Product documentation is available online at: www.LGolutions.com.

Open Source Software Notice

To obtain the source code under GPL, LGPL, MPL and other open source licenses that are contained in this product, please visit <http://opensource.lge.com>. In addition to the source code, all referenced license terms, warranty disclaimers and copyright notices are available for download. LG Electronics will also provide open source code to you on CD-ROM for a charge covering the cost of performing such distribution (such as the cost of media, shipping and handling) upon e-mail request to opensource@lge.com. This offer is valid for three (3) years from the date on which you purchased the product.



For Customer Support/Service, please call:

1-888-865-3026

www.LGsolutions.com

Pro:Idiom is a registered trademark of Zenith Electronics LLC. Pro:Centric is a registered trademark of LG Electronics Inc. *b-LAN* is a trademark of LodgeNet Interactive Corporation. All other trademarks or registered trademarks are the property of their respective owners.

Free Manuals Download Website

<http://myh66.com>

<http://usermanuals.us>

<http://www.somanuals.com>

<http://www.4manuals.cc>

<http://www.manual-lib.com>

<http://www.404manual.com>

<http://www.luxmanual.com>

<http://aubethermostatmanual.com>

Golf course search by state

<http://golfingnear.com>

Email search by domain

<http://emailbydomain.com>

Auto manuals search

<http://auto.somanuals.com>

TV manuals search

<http://tv.somanuals.com>