



# Mini Home Theater OWNER'S MANUAL

MODEL: LFD750

LFD750  
FBS162V



Before connecting, operating or adjusting this product,  
please read this instruction booklet carefully and completely.





**CAUTION: TO REDUCE THE RISK OF ELECTRIC SHOCK DO NOT REMOVE COVER (OR BACK) NO USER-SERVICEABLE PARTS INSIDE REFER SERVICING TO QUALIFIED SERVICE PERSONNEL.**



This lightning flash with arrowhead symbol within an equilateral triangle is intended to alert the user to the presence of uninsulated dangerous voltage within the product's enclosure that may be of sufficient magnitude to constitute a risk of electric shock to persons.



The exclamation point within an equilateral triangle is intended to alert the user to the presence of important operating and maintenance (servicing) instructions in the literature accompanying the product.

**WARNING: TO PREVENT FIRE OR ELECTRIC SHOCK HAZARD, DO NOT EXPOSE THIS PRODUCT TO RAIN OR MOISTURE.**

**WARNING:** Do not install this equipment in a confined space such as a bookcase or similar unit.

**CAUTION:** Do not block any ventilation openings. Install in accordance with the manufacturer's instructions.

Slots and openings in the cabinet are provided for ventilation and to ensure reliable operation of the product and to protect it from over heating.

The openings should never be blocked by placing the product on a bed, sofa, rug or other similar surface. This product should not be placed in a built-in installation such as a bookcase or rack unless proper ventilation is provided or the manufacturer's instruction have been adhered to.

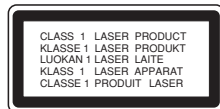

**CAUTION:**

This product employs a Laser System.

To ensure proper use of this product, please read this owner's manual carefully and retain it for future reference. Should the unit require maintenance, contact an authorized service center.

Use of controls, adjustments or the performance of procedures other than those specified herein may result in hazardous radiation exposure.

To prevent direct exposure to laser beam, do not try to open the enclosure. Visible laser radiation when open. **DO NOT STARE INTO BEAM.**

**CAUTION:** The apparatus should not be exposed to water (dripping or splashing) and no objects filled with liquids, such as vases, should be placed on the apparatus.

**FCC WARNING:** This equipment may generate or use radio frequency energy. Changes or modifications to this equipment may cause harmful interference unless the modifications are expressly approved in the instruction manual. The user could lose the authority to operate this equipment if an unauthorized change or modification is made.

**REGULATORY INFORMATION: FCC Part 15**

This equipment has been tested and found to comply with the limits for a Class B digital device, pursuant to Part 15 of the FCC Rules.

These limits are designed to provide reasonable protection against harmful interference in a residential installation. This equipment generates, uses and can radiate radio frequency energy and, if not installed and used in accordance with the instructions, may cause harmful interference to radio communications.

However, there is no guarantee that interference will not occur in a particular installation. If this equipment does cause harmful interference to radio or television reception, which can be determined by turning the equipment off and on, the user is encouraged to try to correct the interference by one or more of the following measures:

- Reorient or relocate the receiving antenna.
- Increase the separation between the equipment and receiver.
- Connect the equipment into an outlet on a circuit different from that to which the receiver is connected.
- Consult the dealer or an experienced radio/TV technician for help.

**FCC COMPLIANCE:** The responsible party for this product's compliance is:

Marketed and Distributed by LG Electronics U.S.A., Inc.,  
1000 Sylvan Avenue, Englewood Cliffs, NJ.  
Phone: 1-201-816-2000.

**CAUTION concerning the Power Cord**

**Most devices are should be placed on a dedicated circuit;**

That is, a single outlet circuit which powers only that electronic device and has no additional outlets or branch circuits. Check the specification page of this owner's manual to be certain.

Do not overload wall outlets. Overloaded wall outlets, loose or damaged wall outlets, extension cords, frayed power cords, or damaged or cracked wire insulation are dangerous. Any of these conditions could result in electric shock or fire. Periodically examine the cord of your appliance, and if its appearance indicates damage or deterioration, unplug it, discontinue use of the appliance, and have the cord replaced with an exact replacement part by an authorized servicer.

Protect the power cord from physical or mechanical abuse, such as being twisted, kinked, pinched, closed in a door, or walked upon. Pay particular attention to plugs, wall outlets, and the point where the cord exits the appliance.

To disconnect power from the mains, pull out the mains cord plug. When installing the product, ensure that the plug is easily accessible.

# IMPORTANT SAFETY INSTRUCTIONS

**CAUTION: PLEASE READ AND OBSERVE ALL WARNINGS AND INSTRUCTIONS IN THIS OWNER'S MANUAL. AND THOSE MARKED ON THE PRODUCT. RETAIN THIS BOOKLET FOR FUTURE REFERENCE.**

This product has been designed and manufactured to assure personal safety. Improper use can result in electric shock or fire hazard. The safeguards incorporated in this product will protect you if you observe the following procedures for installation, use, and servicing.

This product does not contain any parts that can be repaired by the user.

**DO NOT REMOVE THE CABINET COVER, OR YOU MAY BE EXPOSED TO DANGEROUS VOLTAGE. REFER SERVICING TO QUALIFIED SERVICE PERSONNEL ONLY.**

- 1. Read these instructions.** - All these safety and operating instructions should be read before the product is operated.
- 2. Keep these instructions.** - The safety, operating and use instructions should be retained for future reference.
- 3. Heed all warnings.** - All warnings on the product and in the operating instructions should be adhered to.
- 4. Follow all instructions.** - All operating and use instructions should be followed.
- 5. Do not use this apparatus near water.** - For example: near a bath tub, wash bowl, kitchen sink, laundry tub, in a wet basement; or near a swimming pool; and other areas located near water.
- 6. Clean only with dry cloth.** - Unplug this product from the wall outlet before cleaning. Do not use liquid cleaners.
- 7. Do not block any ventilation openings. Install in accordance with the manufacturer's instructions.** - Slots and openings in the cabinet are provided for ventilation and to ensure reliable operation of the product and to protect it from over-heating. The openings should never be blocked by placing the product on a bed, sofa, rug or other similar surface. This product should not be placed in a built-in installation such as a bookcase or rack unless proper ventilation is provided or the manufacturer's instructions have been adhered to.
- 8. Do not install near any heat sources such as radiators, heat registers, stoves, or other apparatus (including amplifiers) that produce heat.**
- 9. Do not defeat the safety purpose of the polarized or grounding-type plug. A polarized plug has two blades with one wider than the other. A grounding type plug has two blades and a third grounding prong. The wide blade or the third prong are provided for your safety. If the provided plug does not fit into your outlet, consult an electrician for replacement of the obsolete outlet.**
- 10. Protect the power cord from being walked on or pinched particularly at plugs, convenience receptacles, and the point where they exit from the apparatus.**
- 11. Only use attachments/accessories specified by the manufacturer.**
- 12. Use only with the cart, stand, tripod, bracket, or table specified by the manufacturer, or sold with the apparatus. When a cart is used, use caution when moving the cart/apparatus combination to avoid injury from tip-over.**
- 13. Unplug this apparatus during lightning storms or when unused for long periods of time.**
- 14. Refer all servicing to qualified service personnel. Servicing is required when the apparatus has been damaged in any way, such as power-supply cord or plug is damaged, liquid has been spilled or objects have fallen into the apparatus, the apparatus has been exposed to rain or moisture, does not operate normally, or has been dropped.**



<b>Introduction</b>	
Maintenance and Service	4
Before use	5
Front Panel/Back Panel	6
Remote Control	7
<b>Installation and Setup</b>	
TV Connection	8
Antenna (Aerial) Connections	8
Auxiliary Function	9
Headphone Jack	9
To Adjust ECHO Volume	9
Using Microphone	9
iPod connection	9
USB Function	10
Compatible Devices	10
Speaker System Connection	10
Setting the Clock	11
Timer Function	11
Sleep Timer Function	11
Displaying Disc Information on-screen	12
Initial Settings	12
General Operation	12
Language	12
Display	13
Audio	14
Lock (Parental Control)	14
Others	15
<b>Operation</b>	
General features	16
Additional features	17
Playing an Audio CD or MP3/WMA file	18
Programmed Playback	18
Viewing a JPEG file	19
Playing a DivX Movie file	20
Using iPod	21-22
Presetting the Radio Stations	23
Listening to the Radio	23
Dimmer	24
Mute	24
Sound Mode	24
EQUALIZER Effect	24
DEMO	24
DISPLAY MODE	24
XDSS	24
MP3 Optimizer	24
XTS Pro	24
VIRTUAL sound	24
<b>REFERENCE</b>	
Language Codes	25
Area Codes	25
Troubleshooting	26-27
Specifications	28

## Maintenance and Service

Refer to the information in this chapter before contacting a service technician.

### Handling the unit

#### When shipping the unit

Please save the original shipping carton and packing materials. If you need to ship the unit, for maximum protection, re-pack the unit as it was originally packed at the factory.

#### Keeping the exterior surfaces clean

- Do not use volatile liquids such as insecticide spray near the unit.
- Do not leave rubber or plastic products in contact with the unit for a long period of time, since they leave marks on the surface.

#### Cleaning the unit

To clean the player, use a soft, dry cloth. If the surfaces are extremely dirty, use a soft cloth lightly moistened with a mild detergent solution.

Do not use strong solvents such as alcohol, benzene, or thinner, as these might damage the surface of the unit.

#### Maintaining the Unit

The unit is a high-tech, precision device. If the optical pick-up lens and disc drive parts are dirty or worn, the picture quality could be diminished.

Depending on the operating environment, regular inspection and maintenance are recommended after every 1,000 hours of use.

For details, please contact your nearest authorized service center.

**The manual largely contains detailed explanation items about how to operate the unit with the Remote Control.**

#### Precautions in using the touch buttons

- Use the touch buttons with clean and dry hands.
  - In a humid environment, wipe out any moisture on the touch buttons before using.
- Do not press the touch buttons hard to make it work.
  - If you apply too much strength, it can damage the sensor of the touch buttons.
- Touch the button that you want to work in order to operate the function correctly.
- Be careful not to have any conductive material such as metallic object on the touch buttons. It can cause malfunctions.

## Before use

To ensure proper use of this product, please read this owner's manual carefully and retain it for future reference.

This manual provides information on the operation and maintenance of your unit. Should the unit require service, contact an authorized service location.

### About the Symbol Display

"" may appear on your TV display during operation and indicates that the function explained in this owner's manual is not available on that specific DVD video disc.

### Symbol Used in this Manual

#### Note:

Indicates special notes and operating features.







#### Tip:

Indicates tips and hints for making the task easier.

A section whose title has one of the following symbols is applicable only to the disc represented by the symbol.





Indicates hazards likely to cause harm to the unit itself or other material damage.

	DVD and finalized DVD±R/RW
	Audio CDs
	MP3 files
	WMA files
	JPEG files
	DivX files

*Manufactured under license from Dolby Laboratories. "Dolby", "Pro Logic", and the double-D symbol are trademarks of Dolby Laboratories. Confidential Unpublished works. Copyright 1992-1997 Dolby Laboratories. All rights reserved.*

### Types of Playable Discs

	DVD (8 cm / 12 cm disc)
	Audio CD (8 cm / 12 cm disc)

In addition, this unit can play a DVD±R/RW, and CD-R or CD-RW that contains audio titles, MP3, WMA, JPEG or DivX files.

#### Note:

- Depending on the conditions of the recording equipment or the CD-R/RW (or DVD±R/RW) disc itself, some CD-R/RW (or DVD±R/RW) discs may not be played on the unit.
- Do not attach any seal or label to either side (the labeled side or the recorded side) of a disc.
- Do not use irregularly shaped CDs (e.g., heart-shaped or octagonal). It may result in malfunctions.

#### Regional Code

This unit has a regional code printed on the bottom of the unit. This unit can play only DVD discs labelled as the same as the rear of the unit or "ALL".

#### Note on Regional Codes

- Most DVD discs have a globe with one or more numbers in it clearly visible on the cover. This number must match your DVD player's regional code or the disc cannot play.
- If you try to play a DVD with a different regional code from your player, the message "Check Regional Code" appears on the TV screen.

#### POWER SAVE MODE

You can set up the unit into an economic power save mode.

In power-on status, press and hold  (POWER) button for about 3 seconds.

- Nothing is displayed in the display window when the unit goes into the power save mode.

To cancel power save mode, press  (POWER).

## Front Panel/ Back Panel

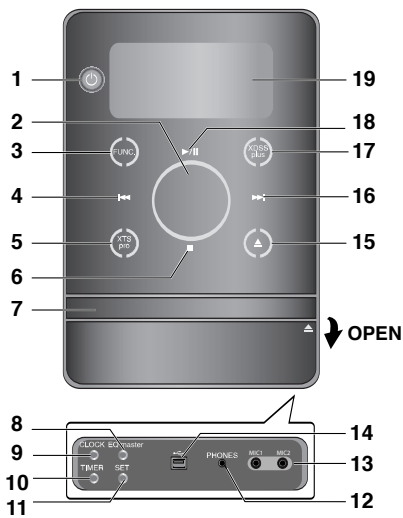

1. ⏻ (POWER)
2. VOLUME\*
3. FUNC. (FUNCTION)  
(FM, AM, DVD/CD, USB, AUX, OSD iPod)
4. ⏮ (SKIP)  
TUN. (-) (TUNER)
5. XTS pro
6. ■ (STOP)  
MO./ ST. (MONO/ STEREO)
7. DISC TRAY
8. EQ master/ DEMO button
9. CLOCK button
10. TIMER button
11. SET button
12. PHONES  
(Headphone jack :  $\varnothing$  3.5mm)
13. MIC1/ MIC2 (MIC Jacks)
14. USB connector
15. ▲ (OPEN/CLOSE)
16. ⏭ (SKIP)  
TUN. (+) (TUNER)
17. XDSS plus / (MP3 Optimizer)
18. ▶|| (PLAY/PAUSE)
19. Display window
20. Power cord

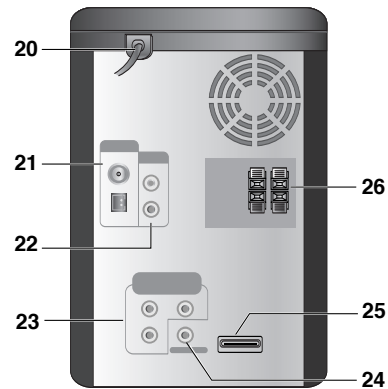

21. Antenna terminal
22. AUX IN (Auxiliary input) connector
23. COMPONENT VIDEO OUT  
(PROGRESSIVE SCAN) connector (Y Pb Pr)
24. VIDEO OUT Jack
25. iPod connector
26. Speaker terminal



### \*VOLUME Adjustment

Move your finger around the touch wheel.

## Remote Control

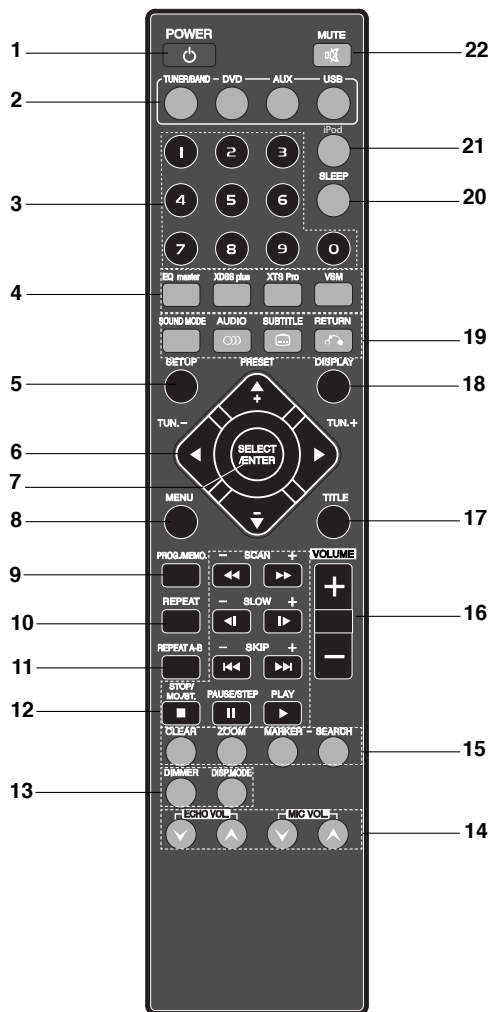

1. POWER button
2. FUNCTION SELECT buttons (TUNER/ BAND,DVD, AUX, USB)
3. NUMERIC buttons (0-9)
4. EQ master, XDSS plus, XTS Pro, VSM buttons
5. SETUP button
6. • ARROW buttons (▲ / ▼ / ◀ / ▶)  
(Selects an option in the menu.)
- PRESET (-/+) buttons (▲ / ▼)
- TUN. (-/+) buttons (◀ / ▶)
7. SELECT/ ENTER button
8. MENU button  
(Use the MENU button to display the menu screen included on DVD video discs.)
9. PROG./MEMO. button
10. REPEAT button
11. REPEAT A-B button
12. • SCAN (◀◀/▶▶) buttons
- SLOW (◀|/|▶) buttons
- SKIP (◀◀|/|▶▶) buttons
- STOP (■)/MO.ST. button
- PAUSE(⏸)/ STEP button
- PLAY (▶) button
13. DIMMER button
- DISP.MODE button
14. ECHO VOL. (⊙/⊙), MIC VOL. (⊙/⊙) buttons
15. • CLEAR button
- ZOOM button
- MARKER, SEARCH buttons
16. VOLUME +/- buttons
17. TITLE button  
(Use the TITLE button to display the title screen included on DVD video discs.)
18. DISPLAY button
19. • SOUND MODE button
- AUDIO (⊞) button
- SUBTITLE (⊞) button
- RETURN (⊞) button - optional
20. SLEEP button
21. iPod button
22. MUTE (⊞)button

### Remote Control Operation Range

Point the Remote Control at the Remote Sensor and press the buttons.

- **Distance:** About 23 ft (7 m) from the front of the Remote Sensor
- **Angle:** About 30° in each direction in front of the Remote Sensor

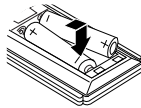

### Remote Control battery installation

Remove the battery cover on the rear of the Remote Control, and insert two R03 (size AAA) batteries with ⊕ and ⊖ aligned correctly.



### Caution

Do not mix old and new batteries. Never mix different types of batteries (standard, alkaline, etc.).

# Installation and Setup

## TV Connection

Make one of the following connections, depending on the capabilities of your existing equipment.

### Tip:

- Depending on your TV and other equipment you wish to connect, there are various ways you could connect the unit. Use one of the connections described below.
- Please refer to the manuals of your TV, VCR, Stereo System or other devices as necessary to make the best connections.

### Caution:

- Make sure the unit is connected directly to the TV. Select the correct AV input on your TV.
- Do not connect your unit to the TV via your VCR. The DVD image could be distorted by the copy protection system.

## Video connection

Connect the VIDEO OUT jack from the unit to the VIDEO IN jack on the TV using the video cable supplied (V).

## Component Video connection

Connect the COMPONENT VIDEO OUT jacks from the unit to the corresponding jacks on the TV using a Y Pb Pr cable (C).

### Rear of TV

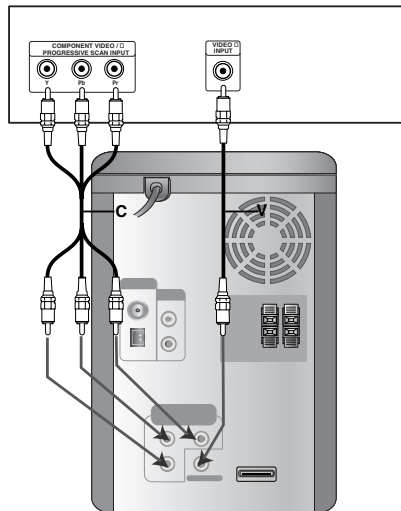

## Antenna (Aerial) Connections

Connect the supplied FM/AM antennas for listening to the radio.

### Note:

- To prevent noise pickup, keep the AM loop antenna away from the unit and other components.
- Be sure to fully extend the FM wire antenna.
- After connecting the FM wire antenna, keep it as horizontal as possible.

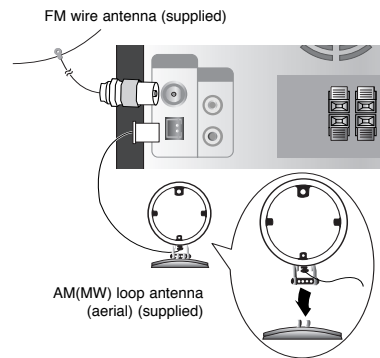

For AM(MW) reception, connect the loop antenna (aerial) to the terminal marked AM



## Auxiliary Function

Connect an auxiliary device such as a TV or VCR via the rear mounted AUX connector and press **AUX** [Refer to the example image(1) shown below].

When you connect each end of the bundled portable in cable with both the AUX connector and the headphone jack of a portable device (like MP3 player, cassette tape player, CD player, etc.), you can hear the sound of the device through the speakers [Refer to the example image(2) shown below].

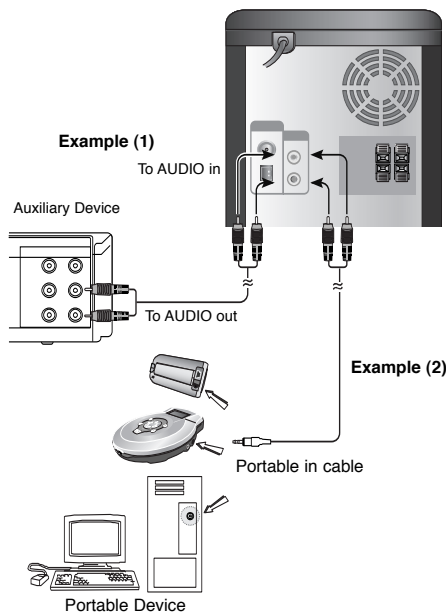

### Note:

Turn the unit off and then connect an auxiliary device before you connect an auxiliary device. Because it may be made a noise.

## Headphone Jack

Connect a stereo headphone plug (ø3.5mm) into the headphone jack.

The speakers are automatically disconnected when you plug in the headphones (not supplied).

## To Adjust ECHO Volume

You can give an echo effect to the sound from the microphones.

Press **ECHO VOL.** (⊕/⊖) on the Remote Control to increase the echo volume or decrease it. (MIN,1 - 14, MAX steps)

## Using Microphone

You can sing to a music source by connecting a microphone to the unit.

1. Connect your microphone to the MIC1/ MIC 2 Jacks.  
“🎤” will be shown in the display window.
2. Play a music you want.
3. Sing along with the accompaniment.  
Adjust the microphone volume by pressing **MIC VOL.** button. (MIN,1 - 14, MAX steps)

### Note:

- When not using the microphone, set the **MIC VOL.** to minimum or turn off the MICs and remove the microphone from the MIC Jacks.
- If the microphone is set too near the speaker, a howling sound may be produced. In this case, move the microphone away from the speaker or decrease the sound level by using **MIC VOL.**
- If sound through the microphone is extremely loud, it may be distorted. In this case, decrease MIC volume.

## iPod connection

Connect the iPod connector on the rear of the unit to the dock connector of iPod using an iPod cable (I).

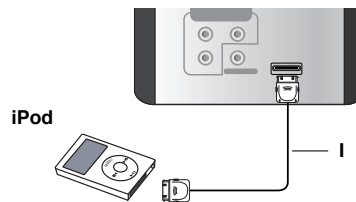

### Note:

- Depending on the type of iPod, you may need to insert one of the dock adapters into the dock slot before you station your iPod.
- Adjust the volume to a moderate level before you connect your iPod and this unit.

## USB Function

You can enjoy the media files such as tunes (MP3/WMA/PHOTO/VIDEO file) saved in an MP3 player or USB memory by connecting the storage device to the USB port of this unit.

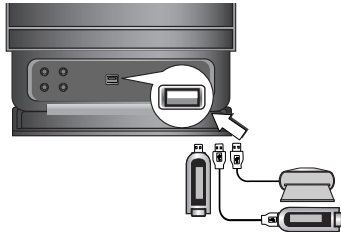

## Compatible Devices

1. Devices which require additional program installation when you have connected it to a computer, are not supported.
2. MP3 Player : Flash type MP3 player.
  - The MP3 player requiring installation of a driver is not supported.
3. USB Flash Drive : Devices that support USB2.0 or USB1.1.

### To Remove the USB from the unit

1. Choose the other functions except USB function in order to remove the USB.
2. Remove the USB from the unit.

### Note:

If you want to operate other functions, see the CD Playback section. Refer to the page 16, 17, and 18.

### Note:

- Do not extract the USB device in operating.
- A back up demands to prevent a data damage.
- If you use a USB extension cable or USB hub, the USB device might not be recognized.
- A device using NTFS file system is not supported. (Only FAT (16/32) file system is supported.)
- The USB function of this unit does not support all USB devices.
- Digital camera and mobile phone are not supported.
- This unit is not supported when the total number of files is 1000 or more.

## Speaker System Connection

Connect the speaker wires cables to the speaker terminals.

### Note:

- Be sure to match the speaker wire to the appropriate terminal on the components: + to + and - to -. If the cords are reversed, the sound will be distorted and will lack bass.
- Connect the Left/ Right speaker correctly. If it reversed, the sound may be distorted.

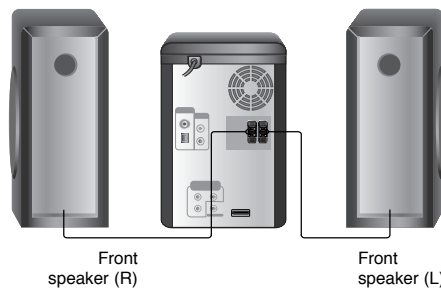

## Setting the Clock

1. Press **CLOCK**.
2. Select a 24 hour time system or a 12 hour time system by tapping **◀▶**.

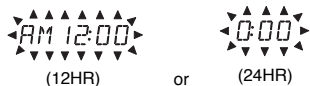

3. Press **SET** to confirm the selected hour time system.
4. Tap **◀▶** on the front panel to set the correct hours.
5. Press **SET**.
6. Tap **◀▶** on the front panel to set the correct minutes.
7. Press **SET** and the correct time is shown on the display window.
8. Press **CLOCK** at any time to display the time for about 5 seconds.

### Note:

If you want to reset the clock, press and hold **CLOCK** for more than 2 seconds.

## Timer Function

With the **TIMER** function, you can have the radio reception, CD play and USB play turned on and off at the desired time.

1. Press **CLOCK** to check the current time.  
(If you don't set clock, the timer function doesn't work.)
2. Press **TIMER** to enter the timer setting mode. If you want to correct the previous memorized **TIMER** setting, press and hold the **TIMER** for more than 2 seconds.  
- The previously memorized timer on the time and "⊙" indicator appears in the display window.
3. Each function (TUNER → DVD/CD → USB) flashes in the display window in turn. Press **SET** when the desired function is flashing.
4. a. When you select the **TUNER** function, select the previously memorized preset number by tapping **◀▶** on the front panel and press **SET**.  
- "ON TIME" indicator appears for about 0.5 seconds in the display window and then disappears.  
b. When you select the DVD/CD or USB function,  
- "ON TIME" indicator appears for about 0.5 seconds in the display window and then disappears.
5. Set the hour to switch on by tapping **◀▶** on the front panel.
6. Press **SET**.
7. Set the minute to switch on by tapping **◀▶** on the front panel.

8. Press **SET**.  
- "OFF TIME" indicator appears for about 0.5 seconds in the display window and then disappears.
9. Set the hour to switch off by tapping **◀▶** on the front panel.
10. Press **SET**.
11. Set the minute to switch off by tapping **◀▶** on the front panel.
12. Press **SET**.
13. Adjust the volume level by tapping **◀▶** on the front panel.
14. Press **SET**.  
"⊙" appears in the display window and the timer setting has been completed.
15. Switch the system off.  
The selected function is automatically switched on and off at the time set.

### Note:

If you insert the DVD, VCD or DivX except audio CD/MP3/WMA on the unit, the timer function will be operated to the **TUNER**.

### To cancel or check the timer

Each time the **TIMER** is pressed you can select the timer set or cancel. You can also check the timer setting status.

To activate or check the timer, press the **TIMER** that "⊙" appears in the display window.

To cancel the **TIMER**, press the **TIMER** that "⊙" disappears in the display window.

## Sleep Timer Function

When the sleep timer is used, the power is automatically turned off after the specified time has elapsed.

1. Press **SLEEP** to set the desired sleep time.  
The **SLEEP** indicator and sleep time appears in the display window.
2. Each time you press **SLEEP** the setting changes in the following order.  
SLEEP 180 → 150 → 120 → 90 → 80 → 70 → 60 → 50 → 40 → 30 → 20 → 10 → OFF (No display)

### Note:

If you press **SLEEP** while the sleep time is displayed, the **SLEEP** time is reset.

### To cancel the sleep timer mode

If you have to stop the function, press the **SLEEP** repeatedly until "SLEEP 10" appears, and then press **SLEEP** once again while "SLEEP 10" is displayed.

## Displaying Disc Information On - screen

You can display various information about the disc loaded on-screen.

1. Press **DISPLAY** to show various playback information.  
The displayed items differ depending on the disc type or playing status.
2. You can select an item by pressing **▲ / ▼** and change or select the setting by pressing **◀ / ▶**.
  - Title (Track) – Current title (or track) number/ total number of titles (or tracks).
  - Chapter – Current chapter number/total number of chapters.
  - Time – Elapsed playing time.
  - Audio – Selected audio language or channel.
  - Subtitle – Selected subtitle.
  - Angle – Selected angle/ total number of angles.
  - Sound – Selected sound mode.

### Note:

If any button is not pressed for a few seconds, the on-screen display disappears.

## Initial Settings

By using the Setup menu, you can make various adjustments to items such as picture and sound. You can also set a language for the subtitles and the Setup menu, among other things. For details on each Setup menu item, see the pages 12 to 15.

### To display and exit the Menu:

Press **SETUP** to display the menu. A second press of **SETUP** will take you back to initial screen.

**To go to the next level:** Press **▶**.

**To go back to the previous level:** Press **◀**.

## GENERAL OPERATION

1. Press **SETUP**. The Setup menu appears.
2. Use **▲ / ▼** to select the desired option then press **▶** to move to the second level. The screen shows the current setting for the selected item, as well as alternate setting(s).
3. Use **▲ / ▼** to select the second desired option and then press **▶** to move to the third level.
4. Use **▲ / ▼** to select the desired setting then press **SELECT/ENTER** to confirm your selection. Some items require additional steps.
5. Press **SETUP** or **PLAY** to exit the Setup menu.

## LANGUAGE



### OSD

Select a language for the Setup menu and the on-screen display.

### Disc Audio / Subtitle / Menu

Select the language you prefer for the audio track (disc audio), subtitles, and the disc menu.

**Original** – Refers to the original language in which the disc was recorded.

**Other** – To select another language, press numeric buttons and then **SELECT/ENTER** to enter the corresponding 4-digit number according to the language code list on the page 25. If you enter the wrong language code, press **CLEAR**.

## DISPLAY



### TV Aspect

- 4:3** – Select when a standard 4:3 TV is connected.
- 16:9** – Select when a 16:9 wide TV is connected.

### Display Mode

The display Mode setting works only when the TV Aspect mode is set to "4:3".

- Letterbox** – Displays a wide picture with bands on the upper and lower portions of the screen.
- Panscan** – Automatically displays the wide picture on the entire screen and cuts off the portions that do not fit.

### Progressive Scan

Progressive Scan Video provides the highest quality pictures with less flickering.

If you are using the COMPONENT VIDEO OUT jacks, but are connecting the unit to a standard (analog) television, set Progressive Scan to Off.

If you are using the Component Video jacks for connection to a TV or monitor that is compatible with a progressive scan signal, set Progressive Scan to On.

#### To Turn ON progressive scan:

Connect component out of the unit to the input of your monitor/television, set your television or monitor to Component Input.

1. Select "Progressive Scan" on the DISPLAY menu then press ►.
2. Select "On" using ▲ / ▼.
3. Pressing **SELECT/ENTER** will set the player to Progressive scan mode.

#### Caution:

Once the setting for progressive scan output is entered, an image will only be visible on a progressive scan compatible TV or monitor. If you set Progressive Scan to On in error, you must reset the unit. First, remove the disc in the unit. Next, press **STOP** (■) and hold it for five seconds before releasing it. The video output will be restored to the standard setting, and a picture will once again be visible on a conventional analog TV or monitor.

## AUDIO

Each DVD disc has a variety of audio output options. Set the unit's AUDIO options according to the type of audio system you use.

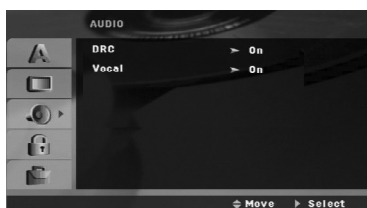

### Dynamic Range Control (DRC)

With the DVD\*1 format, you can hear a program's soundtrack in the most accurate and realistic presentation, thanks to digital audio technology. However, you may wish to compress the dynamic range of the audio output (the difference between the loudest sounds and the quietest ones). Then, you may listen to a movie at a lower volume without losing clarity of sound. Set DRC to On for this effect.

\*1: Dolby Digital only

### Vocal

Set Vocal to On only when a multi-channel karaoke DVD is playing. The karaoke channels on the disc will mix into normal stereo sound.

## LOCK (Parental Control)

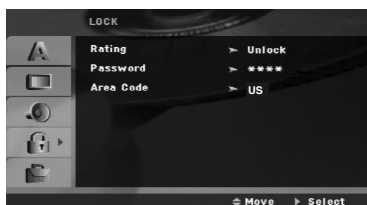

### Rating

Blocks playback of rated DVDs based on their contents. Not all discs are rated.

1. Select "Rating" on the LOCK menu then press ►.
2. To access the LOCK options, you must input the password you have created. If you have not yet entered password, you are prompted to do so. Input a password and press **SELECT/ENTER**. Enter it again and press **SELECT/ENTER** to verify. If you make a mistake before pressing **SELECT/ENTER**, press **CLEAR**.

3. Select a rating from 1 to 8 using ▲ / ▼.

**Rating 1-8:** Rating one (1) has the most restrictions and rating eight (8) is the least restrictive.

**Unlock:** If you select unlock, parental control is not active and the disc plays in full.

4. Press **SELECT/ENTER** to confirm your rating selection, then press **SETUP** to exit the menu.

### Password

You can enter or change password.

1. Select "Password" on the LOCK menu and then press ►.
2. Follow the step 2 as shown above (Rating). To change the password, press **SELECT/ENTER** when the "Change" option is highlighted. Input a password and press **SELECT/ENTER**. Enter it again and press **SELECT/ENTER** to verify.
3. Press **SETUP** to exit the menu.

*If you forget your password*

If you forget your password, you can clear it using the following steps:

1. Press **SETUP** to display the Setup menu.
2. Input the 6-digit number "210499" and press **SELECT/ENTER**. The password is cleared.

### Area Code

Enter the code of the area whose standards were used to rate the DVD video disc, based on the list on page 25.

1. Select "Area Code" on the LOCK menu then press ►.
2. Follow step 2 as shown in rating section.
3. Select the first character using ▲ / ▼.
4. Press ► and select the second character using ▲ / ▼.
5. Press **SELECT/ENTER** to confirm your Area code selection.

## OTHERS

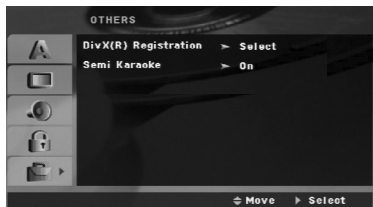

### DivX(R) Registration

We provide you the DivX® VOD (Video On Demand) registration code that allows you to rent and purchase videos based on the DivX® VOD service. For more information, visit [www.divx.com/vod](http://www.divx.com/vod).

1. Select "DivX(R) Registration" option and then press ►.
2. Press **SELECT/ENTER** while "Select" is selected and the registration code will appear.  
Use the registration code to purchase or rent the videos from DivX® VOD service at [www.divx.com/vod](http://www.divx.com/vod). Follow the instructions and download the video onto a disc for playback on this unit.
3. Press **SELECT/ENTER** to exit.

### Note:

All the downloaded videos from DivX® VOD can only be played back on this unit.

### Semi Karaoke

When a chapter/ title / track is fully finished ,this function shows the score in the screen with a fanfare sound.

- on** : Turn the "Semi Karaoke"function on.  
When you finished singing a score will appear on the screen.
- off** : Turn the " Semi Karaoke" function off.  
Fanfare and score do not appears on the screen

Available discs for the Semi Karaoke function:

- DVD discs
- DVD Karaoke Discs

### Note:

- This function operate on the DVD/CD mode.
- The Semi Karaoke function is available only when a microphone is connected.
- Watching movies, "off" the Semi Karaoke or enjoy it without connecting the MIC at the SET UP menu if the fanfare or score appears during changing a chapter.

# Operation

## General features

Buttons	Operations	Discs
▲ (OPEN / CLOSE)	Opens or closes the disc tray.	ALL
⏸ (PAUSE)	During playback, press <b>⏸</b> to pause playback. Press <b>⏸</b> repeatedly to play Frame-by-Frame.	ALL DVD DivX
SKIP (⏮ / ⏭)	During playback, press <b>SKIP</b> (⏮ or ⏭) to go to the next chapter/track or to return to the beginning of the current chapter/track.  Press <b>SKIP</b> ⏮ twice briefly to step back to the previous chapter/track.	ALL
SCAN (⏪ / ⏩)	During playback, press <b>SCAN</b> (⏪ or ⏩) repeatedly to select the required scan speed. DVD : ⏪, ⏪⏪, ⏪⏪⏪, ⏪⏪⏪⏪, ⏪⏪⏪⏪⏪ or ▶, ▶▶, ▶▶▶, ▶▶▶▶, ▶▶▶▶▶ DivX disc : ⏪, ⏪⏪, ⏪⏪⏪, ⏪⏪⏪⏪ or ▶, ▶▶, ▶▶▶, ▶▶▶▶ WMAMP3, Audio CD : ⏪⏪(X2, X4, X8) or ▶▶(X2, X4, X8)	DVD DivX ACD MP3 WMA
REPEAT	During playback, press <b>REPEAT</b> repeatedly to select a desired repeat mode. DVD Video discs: Chapter/Title/Off Audio CD, DivX/MP3/WMA discs: Track/All/Off	DVD DivX ACD MP3 WMA
REPEAT A-B	During playback, press <b>REPEAT A-B</b> to select a point A and a point B and repeats a sequence from point A (Starting point) to point B (End point). Press <b>REPEAT A-B</b> to exit.	DVD
ZOOM	During playback or in the pause mode, press <b>ZOOM</b> to the video image (3 steps). You can move through the zoomed picture using ◀ ▶ ▲ ▼.	DVD
TITLE	If the current DVD title has a menu, the title menu appears on the screen. Otherwise, the disc menu may appear.	DVD
MENU	The disc menu appears on the screen.	DVD
⌨ (SUBTITLE)	During playback, press <b>SUBTITLE</b> repeatedly to select a desired subtitle language.	DVD DivX
🔊 (AUDIO language)	During playback, press <b>AUDIO</b> repeatedly to hear a different audio language or audio track.	DVD DivX
🔊 SLOW	In the pause mode, press <b>SLOW</b> (◀ or ▶) to select required speed. DVD : ◀ (1/2, 1/4, 1/8, 1/16) or ▶ (1/2, 1/4, 1/8, 1/16)	DVD

### Note on general features:

- Zoom may not work on some DVDs.
- The A-B repeat function is available only in the current title.



## Additional features

### Time Search **DVD** **DivX**

To start playing at any chosen time on the disc:

1. Press **DISPLAY** during playback.
2. Press **▲** / **▼** to select the time clock icon and "--:--:--" appears.
3. Input the required start time in hours, minutes, and seconds from left to right. If you enter the wrong numbers, press **CLEAR** to remove the numbers you entered. Then input the correct numbers.
4. Press **SELECT/ENTER** to confirm. Playback starts from the selected time.

### Marker Search **DVD** **DivX**

#### To enter a Marker

You can start playback from up to nine memorized points. To enter a marker, press **MARKER** at the desired point on the disc. The Marker icon appears on the TV screen briefly. Repeat to enter up to nine markers.

#### To Recall or Clear a Marked Scene

1. During disc playback, press **SEARCH**. The marker search menu appears on the screen.
2. Within 10 seconds, press **◀** / **▶** to select a marker number that you want to recall or clear.
3. Press **SELECT/ENTER** and playback starts from the marked scene. Or press **CLEAR** and the marker number is erased from the list.
4. You can play any marker by inputting its number on the marker search menu.

#### Screen Saver

The screen saver appears when you leave the unit in Stop mode for about five minutes.

### Last Scene Memory **DVD**

This unit memorizes the last scene from the last disc that is viewed. The last scene remains in the memory even if you remove the disc from the unit or switch off the unit. If you load a disc that has the scene memorized, the scene is automatically recalled.

#### Note:

This unit does not memorize the scene of a disc if you switch off the unit before commencing to play the disc.

### 1.5 speed playback

#### **DVD** **MP3** **WMA** **ACD**

You can quickly enjoy a movie and music.

The 1.5 speed allows you to watch the pictures and listen to the sound quicker than playing at a normal speed on the disc.

1. Press **PLAY** during the normal playback. The screen will appear at 1.5 speed with sound .
2. To return to normal **PLAY**, press **PLAY**.

## Playing an Audio CD or MP3/WMA file

This unit can play Audio CDs or MP3/WMA files.

### MP3/ WMA/ Audio CD

Once you insert a cd with MP3/WMA files or Audio, a menu appears on the TV screen.

Press ▲ / ▼ to select a track/file and then press **PLAY** or **SELECT/ENTER**, and playback starts. You can use variable playback functions. Refer to the page 16, 17.

### ID3 TAG

When playing a file containing information such as track titles, you can see the information by pressing **DISPLAY** repeatedly. The information [ Folder and file name, Song, Artist, Album, Genre, Comment, Time information ] of the MP3/WMA file will be shown in the display window and TV screen.

To move next or previous files, press the **SKIP** (◀◀ / ▶▶) button.

### Tip:

- Press **MENU** to move to the next page.
- On a CD with MP3/WMA and JPEG, you can switch MP3/WMA and JPEG. Press **TITLE**, and **MUSIC** or **PHOTO** top of the menu is highlighted.

### MP3 / WMA disc compatibility with this player is limited as follows:

- Sampling frequency: within 32 - 48 kHz (MP3), within 24 - 48kHz (WMA)
- Bit rate: within 32 - 320kbps (MP3), 40 - 192kbps (WMA)
- The unit cannot read an MP3/WMA file that has a file extension other than ".mp3" / ".wma".
- CD-R physical format should be ISO 9660
- If you record MP3 / WMA files using software that cannot create a file system (eg. Direct-CD) it is impossible to playback MP3 / WMA files. We recommend that you use Easy-CD Creator, which creates an ISO 9660 file system.
- File names should have a maximum of 8 letters and must incorporate an .mp3 or .wma extension.
- They should not contain special letters such as / ? \* : " < > | etc.
- The total number of files on the disc should be less than 999.

This unit requires discs and recordings to meet certain technical standards in order to achieve optimal playback quality. Pre-recorded DVDs are automatically set to these standards. There are many different types of recordable disc formats (including CD-R containing MP3 or WMA files) and these require certain pre-existing conditions (see above) to ensure compatible playback.

**Customers should note that permission is required in order to download MP3 / WMA files and music from the Internet. Our company has no right to grant such permission. Permission should always be sought from the copyright owner.**

## Programmed Playback

The program function enables you to store your favorite tracks from any disc in the unit memory. A program can contain 300 tracks.

1. Insert a disc.  
Audio CD and MP3/WMA discs:
2. Select a track on the "List", and then press **PROG.MEMO.** or select "➕" (Add)" icon and then press **SELECT/ENTER** to place the selected track on the "Program" list. Repeat to place additional tracks on the list.

### Note:

You can add all tracks in the disc. Select "➕" (Add All)" icon then press **SELECT/ENTER**.

3. Select the track you want to start playing on the "Program" list. Press **MENU** to move to the next page.
4. Press **PLAY** or **SELECT/ENTER** to start. Playback begins in the order in which you programmed the tracks. Playback stops after all of the tracks on the "Program" list have played once.
5. To resume normal playback from programmed playback, select a track of **AUDIO CD** (or **MP3/WMA**) list and then press **PLAY**.

### Repeat Programmed Tracks

1. Press **REPEAT** when playing a disc. The repeat icon appears.
2. Press **REPEAT** to select a desired repeat mode.
  - **TRACK**: repeats the current track
  - **ALL**: repeats all the tracks on programmed list.
  - **Off**(No display): does not play repeatedly.

### Erasing a Track from "Program" List

1. Use ▲ ▼ to select the track that you wish to erase from the Program list.
2. Press **CLEAR**. Alternatively, select "⊖" (Delete)" icon then press **SELECT/ENTER** to place the selected track on the Program list. Repeat to erase additional tracks on the list.

### Erasing the Complete Program List

Use ▲ / ▼ to select "⊖" (Del all)" and then press **SELECT/ENTER**.

### Note:

The programs are also cleared when the disc is removed.

## Viewing a JPEG file

This unit can play discs with JPEG files.  
Before playing JPEG recordings, read the note on JPEG Recordings on the right.

1. Insert a disc and close the tray.  
The PHOTO menu appears on the TV screen.

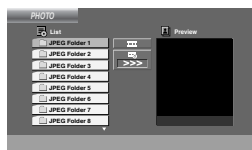

2. Press **▲ / ▼** to select a folder, and then press **SELECT/ENTER**. A list of files in the folder appears.  
If you are in a file list and want to return to the previous Folder list, use **▲ / ▼** to highlight **⏪** and press **SELECT/ENTER** or **PLAY**.
3. If you want to view a particular file, press **▲ / ▼** to highlight a file and press **SELECT/ENTER** or **PLAY**. While viewing a file, you can press **STOP** to move to the previous menu (JPEG menu).

### Slide Show

Use **▲ ▼ ◀ ▶** to highlight the **Slide Show** icon then press **SELECT/ENTER** or **PLAY**.

#### Tip:

- There are four Slide Speed options **☐** :  
> (Slow), >> (Normal), >>> (Fast) and II (off).  
Use **▲ / ▼ / ◀ / ▶** to highlight the Speed. Then, use **◀ / ▶** to select the option you want to use and then press **SELECT/ENTER**.
- If you set Speed option to Off, the slide is not active.

### Still Picture

1. Press **PAUSE/STEP** during the slide show.  
The unit will now go into the PAUSE mode.
2. To return to the slide show, press **PLAY** or press **PAUSE/STEP** again.

### Moving to another File

Press **SKIP** (**◀◀** or **▶▶**) once during viewing a picture to advance to the next or previous file.

### Rotating the picture

Press **▲ / ▼ / ◀ / ▶** during showing a picture to rotate the picture clockwise or counter-clockwise.

## Zoom

Each time ZOOM is pressed the setting changes in the following order.

Zoom on ↔ Zoom off

Press **▲, ▶** or **▶▶** to enlarge the video image.  
Press **▼, ◀** or **◀◀** to reduce the video image.

### JPEG file compatibility with this player is limited as follows:

- Depending upon the size and the number of JPEG files, it could take a long time for the unit to read the disc's contents. If you don't see an on-screen display after several minutes, some of the files may be too large — reduce the resolution of the JPEG files to less than 2M pixels as 2760 x 2048 pixels and burn another disc.
- The total number of files and folders on the disc should be less than 999.
- Some discs may not operate due to a different recording format or the condition of disc.
- Ensure that all the selected files have the ".jpg" extensions when copying into the CD layout.
- If the files have ".jpe" or ".jpeg" extensions, please rename them as ".jpg" file.
- File names without ".jpg" extension will not be able to be read by this unit. Even though the files are shown as JPEG image files in Windows Explorer.

## Playing a DivX Movie file

Using this unit you can play DivX file.

1. Insert a disc and close the tray. The MOVIE menu appears on the TV screen.

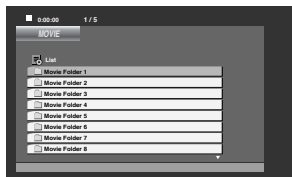

2. Press ▲ / ▼ to select a folder and then press **SELECT/ENTER**. A list of files in the folder appears. If you are in a file list and want to return to the Folder list, use ▲ / ▼ to highlight **⏪** and press **SELECT/ENTER** or **PLAY**.
3. If you want to view a particular file, press ▲ / ▼ to highlight a file and press **SELECT/ENTER** or **PLAY**.
4. Press **STOP** to exit.

### Tip:

- Press **MENU** to move to the next page.
- On a CD with MP3/WMA, JPEG and MOVIE file, you can switch MUSIC, PHOTO and MOVIE menu. Press **TITLE** and MUSIC, PHOTO and MOVIE word on top of the menu is highlighted.

### Note:

- Be sure to select "SUBTITLE ON" mode by pressing the subtitle file every time before playing a DivX file.
- When the subtitle has more than two languages in the file, original subtitle is only available.
- You can not adjust sound mode and VIRTUAL sound during the DivX file playing.
- The DivX subtitle file name has to be identified with the DivX file name to display by this unit.

### Notice for displaying the Divx subtitle

If the subtitle does not display properly during playback, press and hold **SUBTITLE** for about 3 seconds then press **SUBTITLE** to select another language code until the subtitle is displayed properly

### DivX file compatibility with this player is limited as follows:

- Available resolution size of the DivX file is under 800x600 (W x H) pixel.
- The file name of the DivX subtitle is available by 45 characters.
- If there is impossible code to express in the DivX file, it may be displayed as " \_ " mark on the display.
- **If the number of the screen frame is over 30 per 1 second, this unit may not operate normally.**
- **If the video and audio structure of recorded files is not interleaved, either video or audio is outputted.**

### Playable DivX file

- ".avi ", ".mpg ", ".mpeg ", ".divx"

### Playable Subtitle format

SubRip(\*.srt/\*.txt)  
SAMI(\*.smi)  
SubStation Alpha(\*.ssa/\*.txt)  
MicroDVD(\*.sub/\*.txt)  
SubViewer 2.0(\*.sub/\*.txt)  
VobSub(\*.sub)

### Playable Codec format

- "DIVX3.xx ", "DIVX4.xx ", "DIVX5.xx ", "MP43 ", "3IVX "

### Playable Audio format

- "AC3 ", "PCM ", "MP3 ", "WMA ".
  - Sampling frequency: within 32 - 48 kHz (MP3), within 24 - 48kHz (WMA)
  - Bit rate: within 32 - 320kbps (MP3), 40 - 192kbps (WMA)

## Using iPod

You can enjoy playback of your iPod using the supplied remote control.

iPod is a trademark of Apple Computer, Inc, registered in the U.S. and other countries.

### General operation

1. Connect your iPod and the unit with iPod cable. Refer to the page 9. Your iPod is automatically turned on.
2. Turn the unit on.
3. Press iPod on the remote control to enter the iPod mode. The iPod menu appears on the TV screen. The initial screen of iPod menu is the OSD iPod mode.
4. Use ▲ / ▼ and ENTER on the Remote Control to display the list of menu.
5. Press ENTER to play.

### General features

Remote Control buttons	iPod buttons	Operations
▶ (PLAY)	▶	During pause, press ▶ to resume playback.
(PAUSE)	▶	During playback, press    to pause playback.
■ (STOP)	-	During playback, press ■ to stop playback. Press ENTER to resume playback.
SKIP (I◀◀/▶▶I)	I◀◀/▶▶I	During playback, press SKIP (I◀◀ or ▶▶I) to go to the next track or to return to the beginning of the current track. Press SKIP I◀◀ twice briefly to step back to the previous track. Music file: During playback, press and hold SCAN (◀◀ or ▶▶) and then release at a point you want. Video file: During playback, press and hold SKIP (I◀◀ or ▶▶I) and then release at a point you want.
REPEAT	REPEAT	During playback, press REPEAT repeatedly to select a desired repeat mode. (Track/All/Off)
MENU	MENU	Moves to the previous menu.

#### Note:

- It works with all iPod models that have a dock connector.
- Compatibility with your iPod may vary depending on the type of your iPod.
- Depending on your iPod's software version, it may not be possible to control your iPod from the unit. We recommend installing the latest software version.
- Adjust the volume to a moderate level before you connect your iPod and this unit.
- MIC function is not supported on the IPOD mode.

### Playing the iPod in the Remote iPod mode

You can operate your iPod by using the supplied remote control and controls on your iPod.

1. Press iPod on the Remote Control until "IPOD" appears in the display window.

#### Note:

You can select the Remote iPod mode or OSD iPod mode by pressing repeatedly iPod on the remote control.

2. Use ▲ / ▼ and ENTER on the Remote Control or controls on your iPod to display the list of menu by viewing your iPod.
3. Press ENTER to play.

#### Note:

- When you connect the unit and TV to VIDEO IN/OUT, TV screen is turned off temporarily.
- Connect the VIDEO OUT jack on the rear of the unit to the VIDEO IN jack on the TV using the video cable if you want to view the video or photo file.
- The images of video or photo files are outputted only when you connect the unit to the VIDEO OUT connector.

## Playing the iPod in the OSD iPod mode

You can operate your iPod by controlling OSD menu on the TV screen with the supplied remote control. The controls on your iPod are not operational in the OSD iPod mode.

1. Press iPod on the Remote Control until "OSD IPOD" appears in the display window.
2. Use ▲ / ▼ and ENTER on the Remote Control to display the list of menu.
3. Press ENTER to play.



### Music

Classifies and plays the files by Playlists, Artists, Albums, Genres, Songs, and Composers.

### Photos / Videos

The video or photo file is not played in the OSD iPod mode.

If you want to play the video or photo file, change to the Remote iPod mode.

### Now Playing

Displays and plays the last played music file.

## iPod message



When you connect the unit and TV to COMPONENT VIDEO IN/OUT in the Remote iPod mode, the screen on the left appears. Connect the unit and TV to VIDEO IN/OUT.



When you select the Photos or Videos menu in the OSD iPod mode, the screen on the left appears. Change the unit to the Remote iPod mode.



When you connect the iPod that is not supported on this unit, the screen on the left appears. Depending on your iPod's software version, it may not be possible to control your iPod from the unit. We recommend installing the latest software version.



If the power of your iPod is insufficient or the iPod is misconnected or unknown device, the screen on the left appears.

## Presetting the Radio Stations

You can preset 50 stations for FM and AM. Before tuning, make sure that you have turned down the volume to the minimum.

1. Press **TUNER/BAND** to select the frequency (AM or FM) you want.
2. Select a station you want by pressing **TUN.** (-/+).

### Tuning in automatically

- Press **TUN.** (-/+) for more than 0.5 second. Scanning stops when the unit tunes in a station.

### Tuning in manually

- Press **TUN.** (-/+) briefly and repeatedly.

3. Press **PROG./MEMO.**  
A preset number will flash in the display window.
4. Press **PRESET (▲/▼)** to select the preset number you want.
5. Press **PROG./ MEMO.** again.  
The station is stored.
6. Repeat the steps 1 (or 2) to 5 to store other stations.

### To delete all the memorized stations

Press and hold **PROG./ MEMO.** for about two seconds, "ERASE ALL" appears in the display window and then **PROG./ MEMO.** again, the stations are deleted.

### For your reference

If all stations have already been entered, "FULL" message will appear in the display window for a moment and then a preset number will flash. To change the preset number, follow steps 4-5.

### To recall presets

Press and hold **PRESET (▲/▼)** until the desired preset number appears or press it repeatedly.

## Listening to the Radio

1. Press **TUNER/BAND** to select the frequency (AM or FM) you want.  
The last received station is tuned in.
2. Press **PRESET (▲/▼)** repeatedly to select the preset station you want.
  - Each time you press the button, the unit tunes in one preset station at a time.
3. Adjust the volume by pressing **VOLUME (-/+)** repeatedly.

### To listen to non-preset radio stations

- For manual tuning, see "Tuning in manually" in the step 2 on left.
- For automatic tuning, see "Tuning in automatically" in the step 2 on left.

### To turn off the radio

Press **(POWER)** to turn the unit off or select another function mode (DVD/CD, USB, AUX, OSD iPod).

### For your reference

- If an FM program is noisy;  
Press **MO/ ST.** that "MONO" appears in the display window. There will be no stereo effect, but the reception will be improved.  
Press **MO/ ST.** again to restore the stereo effect.
- To improve reception;  
Reposition the supplied antennas.

## Dimmer

This function will change the brightness of the display window on the front panel during in power-on status. Press the **DIMMER** repeatedly.

## Mute

Press **MUTE** to mute your unit. You can mute your unit in order, for example, to answer the telephone.

## Sound Mode

You can enjoy surround sound simply by selecting one of the pre-programmed sound fields according to the program you want to listen to (2 ch. sound only).

Press **SOUND MODE** repeatedly.  
BYPASS → ON STAGE → STUDIO → CLUB → HALL  
→ THEATER 1 → CHURCH → BYPASS...

### Note:

Initial sound mode is BYPASS.

## EQUALIZER Effect

You can choose 7 fixed sound impressions and adjust the BASS, MIDDLE and TREBLE.

- You can select a desired sound mode by using **EQ master**.

NORMAL → USER EQ → POP → CLASSIC  
↑ ↓  
JAZZ ← DRAMA ← ROCK

- Press **EQ master** to select USER EQ.
1. When USER EQ is displayed, press **SET**. "BASS 0" will appear the display window.
  2. Tap the **◀◀/▶▶** on the front panel to select the setting you want (MIN, -4 ~ +4, MAX steps).
  3. Select the BASS, MIDDLE or TREBLE you want by tapping **▶/||** or **■** on the front panel.
  4. Adjust the MIDDLE and TREBLE as shown above.

## DEMO

Press **EQ master** on the front panel in power off state to demonstrate the function in the display window. To cancel it, press **POWER** or **EQ master** again.

## DISPLAY MODE

Whenever you press **DISP. MODE** (DISPLAY MODE), you can enjoy the spectrum change with 6 types in the display window.

## XDSS (Extreme Dynamic Sound System)

Press **XDSS plus** to reinforce treble, bass and the surround effect. The "XDSS ON" or "NORMAL" indicator lights.

DVD/DivX/Audio CD : XDSS ON ↔ NORMAL  
MP3/WMA : XDSS ON → MP3 -- OPT ON  
→ NORMAL → XDSS ON ...

## MP3 Optimizer

This function is an optimizer for compressible MP3 files. It improves the bass sound to make sweet sound.

Each time you press **XDSS Plus**.  
The setting changes in the following order.  
XDSS ON → MP3 -- OPT ON → NORMAL

## XTS Pro

This unique sound quality developed by our technology creates the optimum sound for you to play the perfect playback of the original sound and to feel the living sound source.

Each time you press **XTS Pro** the setting changes in the following order.  
XTS -- P ON ↔ NORMAL

### Note:

The XTS Pro function will not be operated when a headphone has been connected.

## VIRTUAL sound

Press **VSM** to set the VIRTUAL sound.

Source	Display	Effect
2.1 ch.	VIRTUAL	3D STEREO
5.1 ch	VIRTUAL	VIRTUAL sound

### ● 3D STEREO

Realtime 3D positioned sound rendering technology with stereo sources, optimized for stereo speakers. Listeners may experience amazing virtual surround effects with their own multimedia players.

### ● VIRTUAL sound

A pending downmix technology converts 5.1 channel to 2 channel sound having directional information of audio. And it makes a 2 channel or 2.1 channel feel 5.1 channel sound.



# Reference

## Language Codes

Use this list to input your desired language for the following initial settings:  
Disc Audio, Disc Subtitle, Disc Menu.

Language	Code	Language	Code	Language	Code	Language	Code
Abkhazian	6566	Fiji	7074	Lingala	7678	Singhalese	8373
Afar	6565	Finnish	7073	Lithuanian	7684	Slovak	8375
Afrikaans	6570	French	7082	Macedonian	7775	Slovenian	8376
Albanian	8381	Frisian	7089	Malagasy	7771	Somali	8379
Ameharic	6577	Galician	7176	Malay	7783	Spanish	6983
Arabic	6582	Georgian	7565	Malayalam	7776	Sudanese	8385
Armenian	7289	German	6869	Maltese	7784	Swahili	8387
Assamese	6583	Greek	6976	Maori	7773	Swedish	8386
Aymara	6588	Greenlandic	7576	Marathi	7782	Tagalog	8476
Azerbaijani	6590	Guarani	7178	Moldavian	7779	Tajik	8471
Bashkir	6665	Gujarati	7185	Mongolian	7778	Tamil	8465
Basque	6985	Hausa	7265	Nauru	7865	Tatar	8484
Bengali; Bangla	6678	Hebrew	7387	Nepali	7869	Telugu	8469
Bhutani	6890	Hindi	7273	Norwegian	7879	Thai	8472
Bihari	6672	Hungarian	7285	Oriya	7982	Tibetan	6679
Breton	6682	Icelandic	7383	Panjabi	8065	Tigrinya	8473
Bulgarian	6671	Indonesian	7378	Pashto, Pushto	8083	Tonga	8479
Burmese	7789	Interlingua	7365	Persian	7065	Turkish	8482
Byelorussian	6669	Irish	7165	Polish	8076	Turkmen	8475
Cambodian	7577	Italian	7384	Portuguese	8084	Twi	8487
Catalan	6765	Japanese	7465	Quechua	8185	Ukrainian	8575
Chinese	9072	Javanese	7487	Rhaeto-Romance	8277	Urdu	8582
Corsican	6779	Kannada	7578	Rumanian	8279	Uzbek	8590
Croatian	7282	Kashmiri	7583	Russian	8285	Vietnamese	8673
Czech	6783	Kazakh	7575	Samoan	8377	Volapük	8679
Danish	6865	Kirghiz	7589	Sanskrit	8365	Welsh	6789
Dutch	7876	Korean	7579	Scots Gaelic	7168	Wolof	8779
English	6978	Kurdish	7585	Serbian	8382	Xhosa	8872
Esperanto	6979	Laothian	7679	Serbo-Croatian	8372	Yiddish	7473
Estonian	6984	Latin	7665	Shona	8378	Yoruba	8979
Faroese	7079	Latvian, Lettish	7686	Sindhi	8368	Zulu	9085

## Area Codes

Choose a area code from this list.

Area	Code	Area	Code	Area	Code	Area	Code
Afghanistan	AF	Ethiopia	ET	Malaysia	MY	Saudi Arabia	SA
Argentina	AR	Fiji	FJ	Maldives	MV	Senegal	SN
Australia	AU	Finland	FI	Mexico	MX	Singapore	SG
Austria	AT	France	FR	Monaco	MC	Slovak Republic	SK
Belgium	BE	Germany	DE	Mongolia	MN	Slovenia	SI
Bhutan	BT	Great Britain	GB	Morocco	MA	South Africa	ZA
Bolivia	BO	Greece	GR	Nepal	NP	South Korea	KR
Brazil	BR	Greenland	GL	Netherlands	NL	Spain	ES
Cambodia	KH	Heard and McDonald Islands	HM	Netherlands Antilles	AN	Sri Lanka	LK
Canada	CA	Hong Kong	HK	New Zealand	NZ	Sweden	SE
Chile	CL	Hungary	HU	Nigeria	NG	Switzerland	CH
China	CN	India	IN	Norway	NO	Taiwan	TW
Colombia	CO	Indonesia	ID	Oman	OM	Thailand	TH
Congo	CG	Israel	IL	Pakistan	PK	Turkey	TR
Costa Rica	CR	Italy	IT	Panama	PA	Uganda	UG
Croatia	HR	Jamaica	JM	Paraguay	PY	Ukraine	UA
Czech Republic	CZ	Japan	JP	Philippines	PH	United States	US
Denmark	DK	Kenya	KE	Poland	PL	Uruguay	UY
Ecuador	EC	Kuwait	KW	Portugal	PT	Uzbekistan	UZ
Egypt	EG	Libya	LY	Romania	RO	Vietnam	VN
El Salvador	SV	Luxembourg	LU	Russian Federation	RU	Zimbabwe	ZW

## Troubleshooting

Check the following guide for the possible cause of a problem before contacting service.

Symptom	Cause	Correction
No power.	<ul style="list-style-type: none"> <li>The power cord is disconnected.</li> </ul>	<ul style="list-style-type: none"> <li>Plug the power cord securely into the wall outlet.</li> </ul>
The power is on, but the unit does not work.	<ul style="list-style-type: none"> <li>No disc is inserted.</li> </ul>	<ul style="list-style-type: none"> <li>Insert a disc. (Check that the DVD or audio CD indicator in the DVD display is lit.)</li> </ul>
No picture.	<ul style="list-style-type: none"> <li>The TV is not set to receive DVD signal output.</li> </ul>	<ul style="list-style-type: none"> <li>Select the appropriate video input mode on the TV so the picture from the unit appears on the TV screen.</li> </ul>
	<ul style="list-style-type: none"> <li>The video cable is not connected securely.</li> </ul>	<ul style="list-style-type: none"> <li>Connect the video cable into the jacks securely.</li> </ul>
	<ul style="list-style-type: none"> <li>The connected TV power is turned off.</li> </ul>	<ul style="list-style-type: none"> <li>Turn on the TV.</li> </ul>
There is no sound or only a very low-level sound is heard.	<ul style="list-style-type: none"> <li>The equipment connected with the audio cable is not set to receive DVD signal output.</li> </ul>	<ul style="list-style-type: none"> <li>Select the correct input mode of the audio receiver so you can hear the sound from the unit.</li> </ul>
	<ul style="list-style-type: none"> <li>The audio cables are not connected securely.</li> </ul>	<ul style="list-style-type: none"> <li>Connect the audio cable into the jacks securely.</li> </ul>
	<ul style="list-style-type: none"> <li>The power of the equipment connected with the audio cable is turned off.</li> </ul>	<ul style="list-style-type: none"> <li>Turn on the equipment connected with the audio cable.</li> </ul>
	<ul style="list-style-type: none"> <li>The audio connecting cable is damaged.</li> </ul>	<ul style="list-style-type: none"> <li>Replace it with new one.</li> </ul>
The playback picture is poor.	<ul style="list-style-type: none"> <li>The disc is dirty.</li> </ul>	<ul style="list-style-type: none"> <li>Clean the disc.</li> </ul>
The unit does not start playback.	<ul style="list-style-type: none"> <li>No disc is inserted.</li> </ul>	<ul style="list-style-type: none"> <li>Insert a disc. (Check that the DVD, or audio CD indicator in the DVD display is lit.)</li> </ul>
	<ul style="list-style-type: none"> <li>An unplayable disc is inserted.</li> </ul>	<ul style="list-style-type: none"> <li>Insert a playable disc. (Check the disc type, color system and Regional code.)</li> </ul>
	<ul style="list-style-type: none"> <li>The disc is placed upside down.</li> </ul>	<ul style="list-style-type: none"> <li>Place the disc with the playback side down.</li> </ul>
	<ul style="list-style-type: none"> <li>The disc is not placed within the guide.</li> </ul>	<ul style="list-style-type: none"> <li>Place the disc on the disc tray correctly inside the guide.</li> </ul>
	<ul style="list-style-type: none"> <li>The disc is dirty.</li> </ul>	<ul style="list-style-type: none"> <li>Clean the disc.</li> </ul>
	<ul style="list-style-type: none"> <li>A menu is on the TV screen.</li> </ul>	<ul style="list-style-type: none"> <li>Press the SETUP button to turn off the menu screen.</li> </ul>
	<ul style="list-style-type: none"> <li>The Rating level is set.</li> </ul>	<ul style="list-style-type: none"> <li>Cancel the Rating function or change the rating level.</li> </ul>
Loud hum or noise is heard.	<ul style="list-style-type: none"> <li>The disc is dirty.</li> </ul>	<ul style="list-style-type: none"> <li>Clean the disc.</li> </ul>
	<ul style="list-style-type: none"> <li>The speakers and components are connected poorly.</li> </ul>	<ul style="list-style-type: none"> <li>Connect the speakers and components securely.</li> </ul>
	<ul style="list-style-type: none"> <li>The unit is located too close to the TV.</li> </ul>	<ul style="list-style-type: none"> <li>Move your TV away from the audio components.</li> </ul>

Symptom	Cause	Correction
Radio stations cannot be tuned in.	• The antenna is positioned or connected poorly.	• Connect the antenna securely. • Adjust the antennas and connect an external antenna if necessary.
	• The signal strength of the stations is too weak (when tuning in with automatic tuning).	• Tune in the station manually.
	• No stations have been preset or preset stations have been cleared (when tuning by scanning preset stations).	• Preset the stations (page 23).
The Remote Control does not work properly.	• The Remote Control is not pointed at the Remote Sensor of the unit.	• Point the Remote Control at the Remote Sensor of the unit.
	• The Remote Control is too far from the unit.	• Use the Remote Control within about 23 ft (7 m).
	• There is an obstacle in the path of the Remote Control and the unit.	• Remove the obstacle.
	• The batteries in the Remote Control are flat.	• Replace the batteries with new ones.
The front panel display is too dim.	• Nothing is displayed on the front panel display.	• Press <b>DIMMER</b> .

## Specifications

<b>General</b>	Power supply	Refer to main label	
	Power consumption	Refer to main label	
	Net Weight	3.31 kg	
	External dimensions (W x H x D)	170 x 253 x 265 mm	
	Operating conditions	Temperature: 5°C to 35°C, Operation status: Horizontal	
<b>CD/DVD</b>	Operating humidity	5% to 85%	
	Laser	Semiconductor laser, wavelength 650 nm	
	Signal system	NTSC 525/60	
	Frequency response (audio)	40 Hz to 2 kHz	
	Signal-to-noise ratio (audio)	More than 75 dB (1 kHz, NOP -3 dB, 20 kHz LPF/A-Filter)	
	Dynamic range (audio)	More than 75 dB	
<b>Video</b>	Harmonic distortion (audio)	0.5 % (1 kHz, at 1W position) (20 kHz LPF)	
	Video output	1.0 V (p-p), 75 Ω, negative sync./ RCA jack x 1	
	COMPONENT VIDEO OUT	(Y) 1.0 V (p-p), 75 ohms, negative sync, RCA jack x 1 (Pb)/(Pr) 0.7 V (p-p), 75 ohms, RCA jack x 1	
<b>Tuner</b>	<b>FM</b>	Tuning Range	87.5 - 108.0 MHz or 65.0 - 74.0 MHz, 87.5 - 108.0 MHz
		Intermediate Frequency	10.7 MHz
		Signal-to Noise Ratio	60/55 dB (Mono)
		Frequency Response	50 - 10,000 Hz
	<b>AM [MW]</b>	Tuning Range	522 - 1,620 kHz or 520 - 1,720 kHz
		Intermediate Frequency	450 kHz
		Stereo mode	80 W + 80 W
		Output Power	80 W + 80 W
<b>Amplifier</b>	T.H.D	0.5 %	
	Frequency Response	40 - 20000 Hz	
	Signal-to-noise ratio	75 dB	
	Type	3 Way 3 Speaker	
<b>Speakers</b>	Impedance	4 Ω	
	Frequency Response	70 - 20,000 Hz	
	Sound Pressure Level	83 dB/W (1m)	
	Rated Input Power	80 W	
	Max. Input Power	160 W	
	Net Dimensions (W x H x D)	128 x 295 x 240 mm	
	Net Weight	4.1kg	

\* Designs and specifications are subject to change without notice.



**LG Electronics, Inc.  
Limited Warranty - USA**

This LG Electronics product, will be repaired or replaced, at LG's option, if it proves to be defective in material or workmanship, under normal use, during the warranty period ("Warranty Period") listed below, effective from the date ("Date of Purchase") of original consumer purchase of the product. This warranty is good only to the original purchaser of the product and effective only when used in the United States, excluding U.S. Territories.

**THIS WARRANTY IS IN LIEU OF ANY OTHER WARRANTIES, EXPRESS OR IMPLIED, INCLUDING WITHOUT LIMITATION, ANY WARRANTY OF MERCHANTABILITY OR FITNESS FOR A PARTICULAR PURPOSE. TO THE EXTENT ANY IMPLIED WARRANTY IS REQUIRED BY LAW, IT IS LIMITED IN DURATION TO THE EXPRESS WARRANTY PERIOD ABOVE. LG ELECTRONICS WILL NOT BE LIABLE FOR ANY INCIDENTAL, CONSEQUENTIAL, INDIRECT, SPECIAL OR PUNITIVE DAMAGES OF ANY NATURE, EVEN IF ADVISED OF THE POSSIBILITY OF SUCH DAMAGES, INCLUDING WITHOUT LIMITATION, LOST REVENUES OR PROFITS, LOST OR CORRUPTED PROGRAMMING OR DATA, OR ANY OTHER DAMAGE WHETHER BASED IN CONTRACT, TORT OR OTHERWISE.** Some states do not allow the exclusion or limitation of incidental or consequential damages or limitation on how long an implied warranty lasts, so the above exclusion or limitation may not apply to you. This warranty gives you specific legal rights and you may also have other rights that may vary from state to state.

**THIS LIMITED WARRANTY DOES NOT APPLY TO:**

- Damages or operating problems that result from shipping, installation, adjustment of user controls, calibration, maintenance or failure to maintain, or separate system components; and
- Damages or operating problems that result from normal wear and tear, misuse, abuse, operation outside environmental specifications or contrary to the requirements or precautions in the Operating Guide, accident, lightning strikes or other natural causes, unauthorized modification or alteration, incorrect electrical current or voltage, signal reception or input, software not licensed directly by LG, software errors that do not disable functionality, operating and software protocols adopted after the date of manufacture or for outside the US, institutional or commercial use, or other causes not arising out of defect in material or workmanship.

The cost of repair or replacement under these excluded circumstances shall be borne by the consumer.

**CUSTOMER INTER-ACTIVE CENTER NUMBERS:**

<b>For Warranty Service, Where to buy, Product Assistance, or Customer Assistance</b>	<b>Call 1-800-243-0000</b> (24 hours a day, 365 days per year) and select appropriate options from the menu. Or visit our website at <a href="http://www.lgservice.com">http://www.lgservice.com</a>
---	---

LG ELECTRONICS U.S.A., INC.  
1000 SYLVAN AVENUE  
ENGLEWOOD CLIFFS, NJ

P/N : MFL35424727  
Printed in China  
Issue O

## Free Manuals Download Website

<http://myh66.com>

<http://usermanuals.us>

<http://www.somanuals.com>

<http://www.4manuals.cc>

<http://www.manual-lib.com>

<http://www.404manual.com>

<http://www.luxmanual.com>

<http://aubethermostatmanual.com>

Golf course search by state

<http://golfingnear.com>

Email search by domain

<http://emailbydomain.com>

Auto manuals search

<http://auto.somanuals.com>

TV manuals search

<http://tv.somanuals.com>