



**LG**

website:<http://us.lgservice.com>



# MICROWAVE OVEN

## OWNER'S MANUAL & COOKING GUIDE

PLEASE READ THIS OWNER'S MANUAL THOROUGHLY BEFORE OPERATING.

**LCRM1240SW/SB/ST**

# TABLE OF CONTENTS

<b>SAFETY</b> .....	<b>3-4</b>
Precautions to Avoid Possible Exposure to Excessive Microwave Energy.....	3
Grounding Instructions.....	3
Important Safety Instructions .....	4
<b>SAFETY - COFFEE MAKER</b> .....	<b>5</b>
<b>UNDERSTANDING YOUR COFFEE COMBO</b> .....	<b>6-10</b>
Specifications.....	6
Installation.....	6
Parts and Accessories .....	7
Control Panel .....	8
Cookware Guide .....	9
Tips for Microwave Cooking .....	10
Cleaning.....	10
<b>USING YOUR MICROWAVE OVEN</b> .....	<b>11-20</b>
Kitchen Timer .....	11
Child Lock .....	11
Sensor Touch Operation Instruction .....	12
Sensor Touch Table .....	12
Reheat .....	13
Reheat Table .....	13
Auto Cook .....	14
Auto cook Table .....	14
EZ On .....	14
Custom Set .....	15
Custom Set Table .....	15
Auto Defrost .....	16
EZ Defrost .....	16
Auto Defrost Table .....	17
Timed Cooking .....	17
Multi-stage Cooking .....	18
Microwave Power Levels .....	18
Cooking Tips .....	19-20
<b>USING YOUR COFFEE MAKER</b> .....	<b>21-27</b>
Preparing Coffee .....	21
Brew Strength Control .....	22
Cleaning The Coffee Maker .....	22
Self-cleaning .....	23
Brew .....	24
Small Batch .....	24
How To Set The Brew Timer For Auto-on Mode .....	25
Adjust Warming Plate Temp .....	26
Adjust Warming Plate Time .....	26
Other Functions .....	27
<b>TROUBLESHOOTING</b> .....	<b>28-29</b>
Questions and Answers.....	<b>28-29</b>
<b>WARRANTY</b> .....	<b>Inside back cover</b>

## ***Thank you for purchasing a LG microwave oven.***

Please record the model number and serial number of this unit for future reference. We also suggest you record the details of your contact with LG (LG Electronics U.S.A., Inc.) concerning this unit.

Model No: \_\_\_\_\_

Serial No: \_\_\_\_\_

Dealer: \_\_\_\_\_

\_\_\_\_\_

\_\_\_\_\_

Dealer Phone No: \_\_\_\_\_

Customer Relations  
 LG Electronics U.S.A., Inc.  
 Service Division Bldg. #3  
 201 James Record Rd.  
 Huntsville, AL 35824-0126

Staple your receipt here for proof of purchase.

# SAFETY

## PRECAUTIONS TO AVOID POSSIBLE EXPOSURE TO EXCESSIVE MICROWAVE ENERGY

- DO NOT attempt to operate this oven with the door open, since open-door operation can result in harmful exposure to microwave energy. **It is important not to defeat or tamper with the safety interlocks.**
- DO NOT operate the oven if it is damaged. It is particularly important that the oven door close properly and that there is no damage to the:
  1. door (bent)
  2. hinges and latches (broken or loosened)
  3. door seals and sealing surfaces.
- DO NOT place any object between the oven front face and the door, or allow soil or cleaner residue to accumulate on sealing surfaces.
- THE OVEN should not be adjusted or repaired by anyone except properly qualified service personnel.

## GROUNDING INSTRUCTIONS

This appliance must be grounded! If an electrical short circuit occurs, grounding reduces the risk of electric shock by providing an escape wire for the electric current. This appliance is equipped with a

cord having a grounding wire with a grounding plug. Put the plug into an outlet that is properly installed and grounded.

### **WARNING**

**If you use the grounding plug improperly, you risk electric shock.**

Ask a qualified electrician or the Sears Service Department if you do not understand the grounding instructions or if you wonder whether the appliance is properly grounded.

This appliance has a short power supply cord to reduce the risk of anyone's tripping over or becoming entangled in the cord. You may use an extension cord if you are careful.

**If you use an extension cord, be sure that:**

- The extension cord has the same electrical rating as the appliance.
- The marked rating of the extension cord shall be equal to or greater than the electrical rating of the appliance.
- The extension cord is a grounding-type 3-wire cord.
- The extension cord does not drape over a countertop or tabletop, where it can be pulled on by children or tripped over accidentally.
- The electrical cord is dry and not pinched or crushed in any way.

**NOTE: This oven draws 13.8 amperes at 120 Volts, 60 Hz.**

# SAFETY

## IMPORTANT SAFETY INSTRUCTIONS

The safety instructions below will tell you how to use your microwave oven to avoid harm to yourself or damage to your oven.

**WARNING** — To reduce the risk of burns, electric shock, fire, injury to persons, or exposure to excessive microwave energy:

1. Read all the instructions before using your microwave oven.
2. Do not allow children to use this oven without close supervision!
3. Read and follow the specific **PRECAUTIONS TO AVOID POSSIBLE EXPOSURE TO EXCESSIVE MICROWAVE ENERGY** found on page 3.
4. Do not tamper with the built – in safety switches on the oven door! The oven has several built-insafety switches to make sure the power is off when the door is open.
5. When cleaning the door and the surfaces that touch the door, use only mild, nonabrasive soaps or detergents and a sponge or soft cloth.
6. If your oven is dropped or damaged, have it thoroughly checked by a qualified service technician before using it again.
7. To avoid a fire hazard:
  - a) Do not severely overcook foods. It can cause a fire in the oven.
  - b) Do not use recycled paper products in your oven. They can contain particles that can cause arcing or may ignite.
  - c) Do not overcook potatoes. Overcooking could cause a fire.
  - d) Do not store combustible items (bread, cookies, etc.) in the oven, because if lightning strikes the power lines, it may cause the oven to turn ON.
  - e) Do not use wire twist-ties in the oven. Be sure to remove them before placing the item in the oven.
  - f) Do not use the cavity for storage purposes. Do not leave paper products, cooking utensils, or food in the cavity when not in use.
8. If a fire should start:
  - a) Keep the oven door closed.
  - b) Turn the oven off.
  - c) Disconnect the power cord or shut off the power at the fuse or circuit breaker panel.
9. Do not use this oven for commercial purposes. This microwave is made for household use only.
10. Install or locate this appliance in accordance with the provided installation instructions.
11. To avoid electric shock:
  - a) This appliance must be grounded! Connect it only to a properly grounded outlet. (See the **Grounding instructions** on page 3.)
  - b) Do not operate this appliance if it has a damaged cord or plug, if it is not working properly, or if it has been damaged or dropped.
  - c) Do not immerse the electrical cord or plug in water.
  - d) Keep the cord away from heated surfaces.
  - e) This appliance should be serviced only by qualified service personnel.
12. Liquids such as water, coffee, or tea are able to be overheated beyond the boiling point without appearing to be boiling due to surface tension of the liquid. Visible bubbling or boiling when the container is removed from the microwave oven is not always present. This could result in very hot liquids suddenly boiling over when the container is disturbed or when a spoon or other utensil is inserted into the liquid. To reduce the risk of injury to persons;
  - 1) Do not overheat the liquid.
  - 2) Stir the liquid both before and halfway through heating it.
  - 3) Use extreme care when inserting a spoon or other utensil into the container once heating has begun.
  - 4) Do not use straight-sided containers with narrow necks.
  - 5) After heating, allow the container to stand in the microwave oven for a short time before removing the container.
13. Keep the glass tray and the turntable roller rest in the oven when you are cooking.
14. Do not use the oven outdoors. Do not store the oven outdoors. Do not use this product near water. – for example, near a kitchen sink, in a wet basement, near a swimming pool, or similar location.
15. Do not cover or block any openings in the oven.
16. Do not run the microwave oven empty.
17. Do not let the cord hang over the edge of a table or counter.
18. Do not heat glass turntable excessively.
  - Do not cook bacon directly on the glass turntable.
  - Do not allow the grey film on special microwave cooking packages to touch the glass turntable. Put the package on a microwave-safe dish.
  - Keep a browning dish at least  $\frac{3}{16}$  inch above the glass turntable. If you use the browning dish incorrectly, you could break the glass turntable.
19. Be careful not to chip or scratch the edges of the turntable. Chips or scratches may cause the turntable to break during use.
20. Some produce such as whole eggs and sealed containers, for example, closed glass jars, are able to explode and should not be heated in this oven.

**SAVE THESE INSTRUCTIONS!**

# SAFETY - COFFEE MAKER

## IMPORTANT SAFETY INSTRUCTIONS

When using electrical appliances, basic safety precautions should always be followed to reduce the risk of fire, electric shock and/or injury to person, including the following:

1. Read all instructions.
2. Do not touch hot surfaces. Use handles and knobs.
3. To protect against fire, electric shock and injury to persons, do not immerse cord, plugs or appliance in water or other liquid.
4. Close supervision is necessary when any appliance is used by or near children.
5. Unplug from outlet when not in use and before cleaning. Allow to cool before putting on or taking off parts, and before cleaning the appliance.
6. Do not operate any appliance with a damaged cord or plug or after the appliance malfunctions or has been dropped or damaged in any manner. Return appliance to the nearest authorized service center for examination, repair or electrical or mechanical adjustment.
7. The use of attachments not recommended by the manufacturer may cause hazards.
8. Do not use outdoors.
9. Do not let cord hang over edge of table or counter, or touch hot surface.
10. Do not place on or near a hot gas or electric burner, or in a heated oven.
11. Always attach plug to appliance first, then plug cord into the wall outlet. To disconnect, turn any control to "off", then remove plug from wall outlet.
12. Do not use appliance for other than intended use.
13. Snap lid securely onto carafe before serving any beverages.
14. Scalding may occur if the lid is removed during the brewing cycle.
15. The glass carafe is designed for use with this appliance only. It must never be used on the range top.
16. Do not set a hot carafe on a wet or cold surface.
17. Do not use cracked carafe or a carafe having a loose or weakened handle.
18. Do not clean carafe or warming plate with cleansers, steel wool pads, or other abrasive materials.
19. **WARNING** : To reduce the risk of fire of electric shock, do not remove the base plate. No user serviceable parts are inside. Repair should be done only by authorized personnel.
20. Avoid contact with moving parts.
21. Do not pull out the water reservoir while brewing coffee.

**SAVE THESE INSTRUCTIONS!  
FOR HOUSEHOLD USE ONLY**

# UNDERSTANDING YOUR COFFEE COMBO

## SPECIFICATIONS

Power Supply	120V AC, 60 Hz	
Rated Power Consumption	1650W	
Microwave Output	Microwave	*1200W
	Coffee Maker	750W / 90W (Dual)
Rated Current	13.8A(Microwave Oven) / 14.5A(Microwave Oven with Coffee Maker)	
Overall Dimensions (WxHxD)"	23" x 12 <sup>1</sup> / <sub>2</sub> " x 17 <sup>1</sup> / <sub>8</sub> "	
Oven Cavity Dimensions (WxHxD)"	14 <sup>11</sup> / <sub>16</sub> " x 9 <sup>5</sup> / <sub>8</sub> " x 15 <sup>5</sup> / <sub>8</sub> "	
Capacity of Oven Cavity	1.2 cu.ft	

\*IEC 60705 RATING STANDARD

Specifications subject to change without prior notice.

## INSTALLATION

1. Remove your LG Coffee Combo and all packing materials from the shipping carton.
2. Place the oven on a level surface that provides at least 4 inches of space at the left, right, top, and rear sides for proper ventilation.
3. Slide the turntable support onto the pin in the center opening of the oven floor, making sure it seats properly on the pin. Then place the glass turntable on the turntable support.

**NOTE:** Never place the glass turntable in the oven upside down. Blocking the inlet and/or outlet openings can damage the oven.

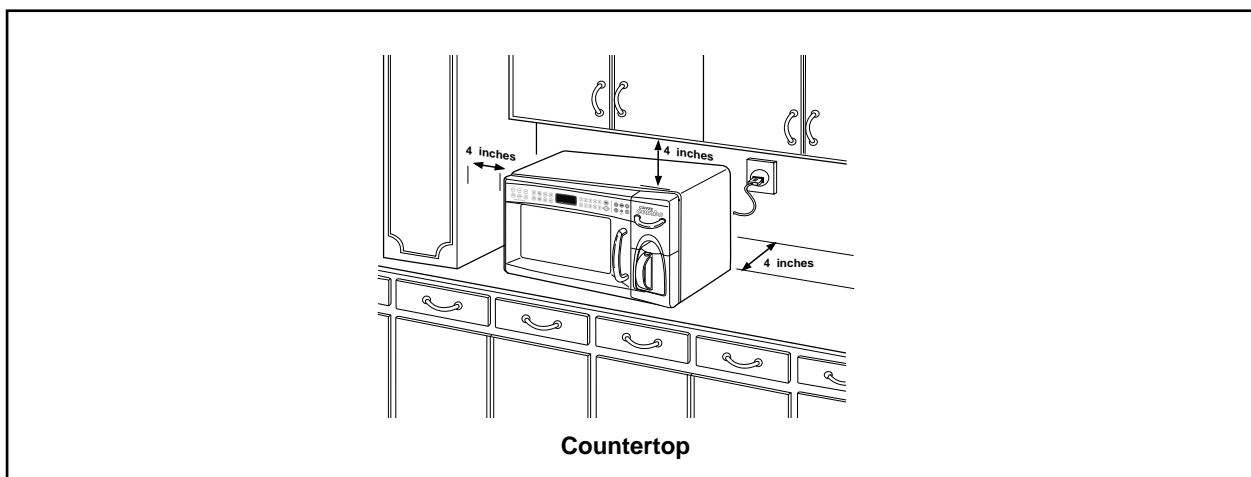

### **WARNING**

To reduce the risk of fire or electric shock, do not install closer than 4 inches to side and back wall.

# UNDERSTANDING YOUR COFFEE COMBO

## PARTS AND ACCESSORIES

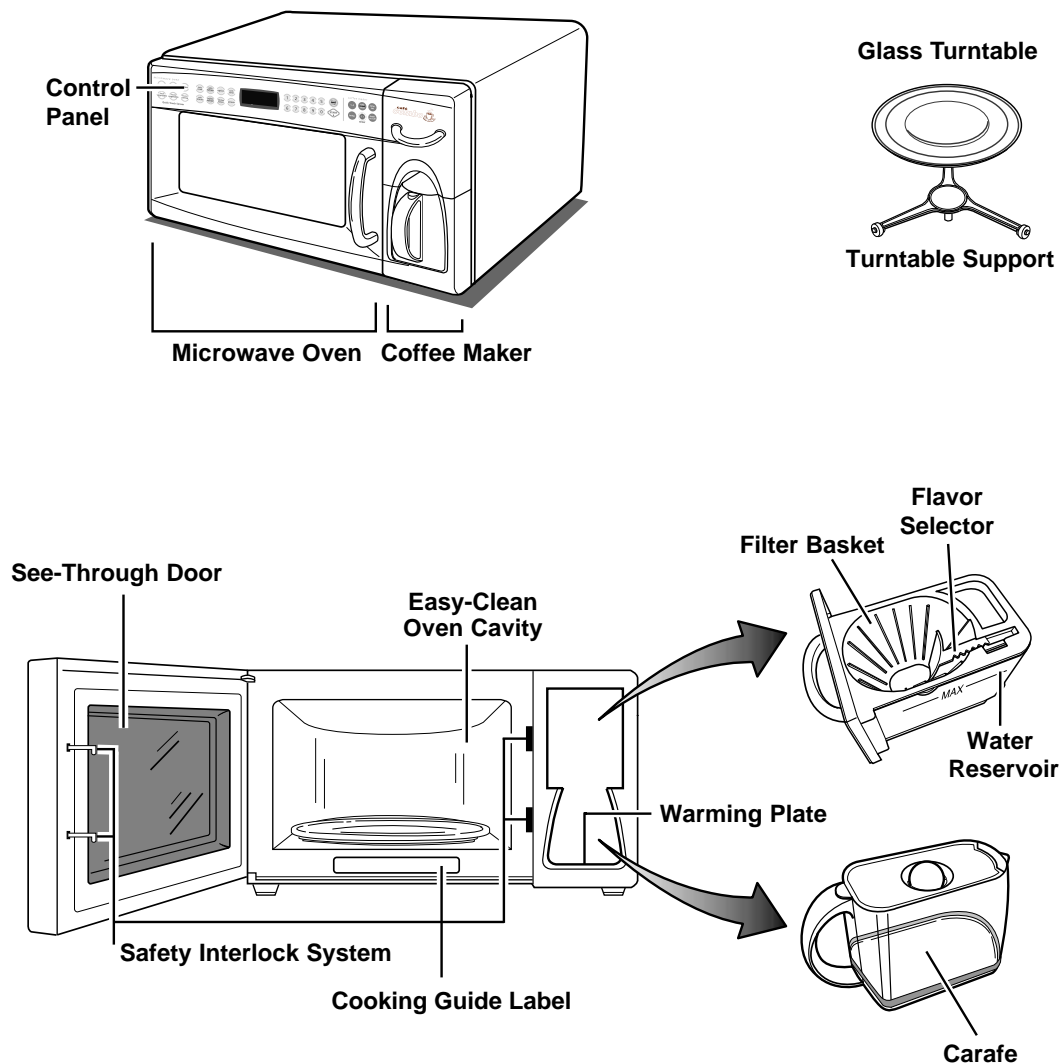

Your oven comes with the following accessories:

- 1 Use and Care Guide
- 1 Glass Turntable
- 1 Turntable Support
- 1 7 cup Water Reservoir
- 1 7 cup Carafe with lid

# UNDERSTANDING YOUR COFFEE COMBO

## CONTROL PANEL

### MICROWAVE CONTROL AREA

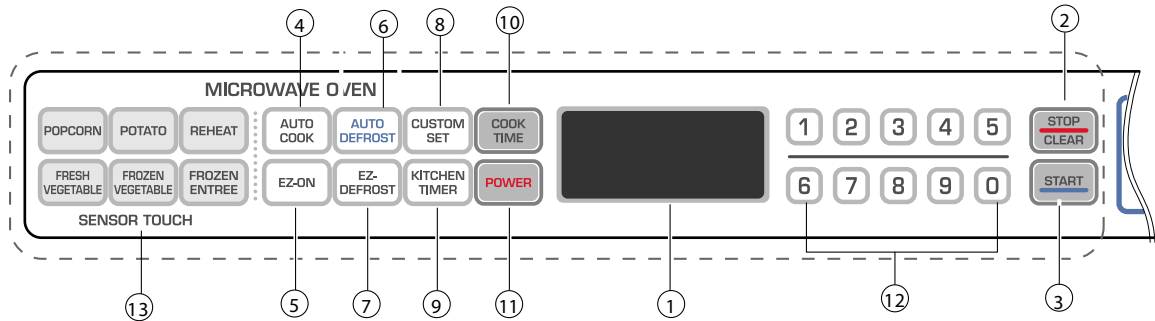

- 1. DISPLAY.** The Display includes a clock and indicators that tell you time of day, cooking time settings, and cooking functions selected.
- 2. STOP/CLEAR.** Touch this pad to stop the oven or clear entries. (microwave oven only)
- 3. START.** Touch this pad to start all entries (except the Auto Cook and Add Minute function which start automatically) and to turn Child Lock on or off.
- 4. AUTO COOK.** Touch this pad to select programmed food items.
- 5. EZ-ON.** Touch this pad to cook at 100% cooking power for 1 minute to 99 minutes 59 seconds.
- 6. AUTO DEFROST.** This pad is an accurate defrosting method for frozen meat, poultry and fish up to 6.0 lbs.
- 7. EZ DEFROST.** This pad provides you with the quick defrosting method for 1.0 pound of frozen foods.
- 8. CUSTOM SET.** Touch this pad to change the oven's default settings for clock, sound, scroll speed and Lbs/Kg.
- 9. KITCHEN TIMER.** Touch this pad to use your microwave oven as a kitchen timer.
- 10. COOK TIME.** Touch this pad to set the cooking time.
- 11. POWER.** Touch this pad to set the cooking power.
- 12. NUMBER PADS.** Touch Number Pads to enter cooking time, power level, quantities, or weights.
- 13. SENSOR TOUCH.** This pad allows you to cook most of your favorite foods without having to select cooking times and power levels.

### COFFEE MAKER CONTROL AREA

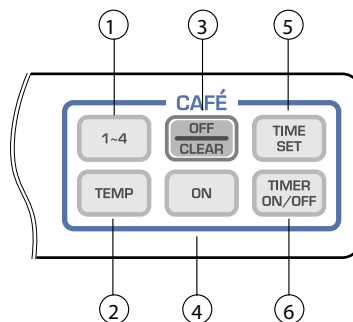

- 1. 1-4.** This pad is small batch function. This pad is used when you want to brew a small amount (1~4 cups) of coffee.
- 2. TEMP.** This pad is used when you want to adjust the warming plate temperature of the coffee.
- 3. OFF/CLEAR.** Touch this pad to stop the coffee maker or clear entries. (coffee maker only)
- 4. ON.** This pad is used when you want to brew more than 4 cups of coffee.
- 5. TIME SET.** Touch this pad to change the default setting of the coffee maker for brew timer or warming plate timer.
- 6. TIMER ON/OFF.** This pad is used when you want to turn the brew timer function On or Off.



# USING YOUR MICROWAVE OVEN

## COOKWARE GUIDE

Most heat-resistant, non-metallic cookware is safe for use in your microwave oven. However, to test cookware before using, follow these steps:

1. Place the empty cookware in the microwave oven.
2. Measure 1 cup of water in a glass measuring cup and place it in the oven beside the cookware.
3. Microwave on 100% power for 1 minute. If the dish is warm, it **should not** be used for microwave cooking.

USE	DO NOT USE
<p><b>Ovenproof Glass</b></p> <ul style="list-style-type: none"> <li>• Glass treated for use in high-intensity heat includes utility dishes, bread dishes, pie plates, cake plates, liquid measuring cups, casseroles, and bowls without metallic trim.</li> </ul> <p><b>China</b></p> <ul style="list-style-type: none"> <li>• Bowls, cups, serving plates, and platters without metallic trim can be used in your oven.</li> </ul> <p><b>Plastic</b></p> <ul style="list-style-type: none"> <li>• When using plastic wrap as a cover, make sure that the dish is deep enough so the plastic wrap does not touch the food. As the food heats, it may melt the plastic wrap wherever the wrap touches the food.</li> <li>• Place plastic wrap loosely over the top of the dish and secure it by pressing the wrap to the sides of the dish.</li> <li>• Vent by turning back one corner of the plastic wrap. This will allow excess steam to escape.</li> <li>• Use plastic dishes, cups, semi-rigid freezer containers, and plastic bags <b>only for short time cooking. Use these with care because the plastic may soften from the heat of the food.</b></li> </ul> <p><b>Paper</b></p> <ul style="list-style-type: none"> <li>• Microwave-safe paper towels, waxed paper, paper napkins, and paper plates with no metallic trim or design can be used in your oven.</li> <li>• Refer to the paper manufacturer's label for use of any paper product in the microwave oven.</li> </ul>	<p><b>Metal Utensils</b></p> <ul style="list-style-type: none"> <li>• Metal shields food from microwave energy and produces uneven cooking. Avoid metal skewers, thermometers, or foil trays.</li> <li>• Metal utensils can cause arcing, which is a discharge of electric current. Arcing can damage your microwave oven.</li> </ul> <p><b>Metal Decoration</b></p> <ul style="list-style-type: none"> <li>• Do not use metal-trimmed or metal-banded dinnerware, casserole dishes, etc.</li> </ul> <p><b>Centura™ Tableware</b></p> <ul style="list-style-type: none"> <li>• The Corning Company recommends that you <b>do not use</b> Centura tableware and some Corelle™ closed-handle cups for microwave cooking.</li> </ul> <p><b>Aluminum Foil</b></p> <ul style="list-style-type: none"> <li>• <b>Do not use</b> large sheets of aluminum foil because they hinder cooking and may cause arcing. You may use small pieces of foil to shield poultry legs and wings.</li> <li>• Keep <b>all</b> aluminum foil at least 1 inch from the walls and door of the oven.</li> </ul> <p><b>Wood</b></p> <ul style="list-style-type: none"> <li>• Wooden bowls, boards, and baskets will dry out and may split or crack when you use them in the microwave oven.</li> </ul> <p><b>Tightly Closed Containers</b></p> <ul style="list-style-type: none"> <li>• Tightly closed cookware can explode. Be sure to leave an opening for steam to escape from covered cookware.</li> </ul> <p><b>Brown Paper</b></p> <ul style="list-style-type: none"> <li>• <b>Do not use</b> brown paper bags. They absorb heat and could burn.</li> </ul> <p><b>Metal Twist-Ties</b></p> <ul style="list-style-type: none"> <li>• Always remove metal twist-ties as they can become hot and cause a fire.</li> </ul>

# USING YOUR MICROWAVE OVEN

## TIPS FOR MICROWAVE COOKING

### BROWNING

Meat and poultry with high fat content that are cooked for 10 or 15 minutes or longer will brown lightly. Foods cooked a shorter time can be brushed with a browning agent, such as Worcestershire sauce, soy sauce, or barbecue sauce.

### COVERING

A cover traps heat and steam and causes the food to cook more quickly. Use a lid or microwave-safe plastic wrap with one corner folded back to vent the excess steam. Lids on glass casseroles can become hot during cooking. Handle carefully. Waxed paper will prevent the food from splattering in the oven and help retain heat. When warming bread items, use waxed paper, napkins, or paper towels. To absorb extra moisture, wrap sandwiches and fatty foods in paper towels.

### SPACING

Arrange individual foods, such as baked potatoes, cupcakes, and hors d'oeuvres in a circle and at least 1 inch apart. This will help the food cook more evenly.

### STIRRING

Stirring blends flavors and redistributes the heat in foods. Always stir from the outside toward the center of the dish. Food at the outside of the dish heats first.

### TURNING

Large foods, such as roasts and whole poultry, should be turned so that the top and bottom cook evenly. Also turn over chicken pieces and chops.

## CLEANING

Wipe the oven inside and outside with a soft cloth and a mild detergent solution. Then rinse and wipe dry. This should be done weekly or more often, if needed. Never use cleaning powders or rough pads. Excessive oil splatters on the inside top will be difficult to remove if left for many days. Wipe splatters with a wet paper towel, especially after cooking chicken or bacon.

### REMOVABLE PARTS

The turntable and turntable support are removable. They should be hand-washed in warm (not hot) water with a mild detergent and a soft cloth. Once they are clean, rinse well and dry with a soft cloth. Never use cleaning powders, steel wool, or rough pads.

### ARRANGEMENT

Do not stack food. Arrange in a single layer in the dish for more even cooking. Because dense foods cook more slowly, place thicker portions of meat, poultry, fish, and vegetables toward the outside of the dish.

### TESTING FOR DONENESS

Because foods cook quickly in a microwave oven, you need to test frequently for doneness.

### STANDING TIME IN OVEN

Depending on density, food often needs to stand from 2 to 15 minutes either in or outside of the oven after cooking power shuts off. Outside of the oven, you usually need to cover food during standing time to retain heat. Remove most foods when they are slightly undercooked and they will finish cooking during standing time. The internal temperature of food will rise about 10°F during standing time.

### SHIELDING

To prevent some portions of rectangular or square dishes from overcooking, you may need to shield them with small strips of aluminum foil to block the microwaves. You can also cover poultry legs and wing tips with foil to keep them from overcooking. **Always keep foil at least 1 inch from oven walls** to prevent arcing.

### PIERCING

Pierce the shell, skin, or membrane of foods before cooking to prevent them from bursting. Foods that require piercing include yolks and whites of eggs, hot dogs, clams, oysters, and whole vegetables, such as potatoes and squash.

- The turntable may be cleaned at the sink. Be careful not to chip or scratch the edges as this may cause the turntable to break during use. Oven turntable may also be cleaned in a dishwasher.
- The turntable support rest should be cleaned regularly.

### SPECIAL CARE

For best performance and safety, the inner door panel and the oven front frame should be free of food or grease buildup. Wipe often with a mild detergent; then rinse and wipe dry. Never use cleaning powders or rough pads.





After cleaning the control panel, touch STOP/CLEAR to clear any entries that might have been entered accidentally while cleaning the panel.

# USING YOUR MICROWAVE OVEN

## KITCHEN TIMER

Your microwave oven can be used as a kitchen timer. You can set up to 99 minutes, 99 seconds.



**Example: To set 3 minutes.**

- | <b>Touch:</b>  | <b>Display Shows:</b>  |
|--|--|
| 1.    | <i>: ENTER TIME IN MIN<br/>AND SEC</i>   |
| 2.    | <i>3 : 00 TOUCH START</i>  |
| 3.    | <div style="border: 1px solid black; padding: 5px; display: inline-block;"><i>3 : 00</i></div><br><b>TIMER</b> and time counting down. |

## CHILD LOCK

You can use this safety feature to lock the control panel so that children cannot use the oven and coffee maker when you do not want them to and when you are cleaning the oven and coffee maker.

**To set CHILD LOCK:**

- | <b>Touch:</b>  | <b>Display Shows:</b>   |
|--|---|
| 1.  | Time of day.  |
| 2.  | Touch and hold until <b>LOCKED</b> appears in the display (approximately 4 seconds). <span style="float: right;"><i>LOCKED</i></span> |

**To cancel CHILD LOCK:**

- | <b>Touch:</b>  | <b>Display Shows:</b>   |
|--|---|
| 1.  | Touch and hold until <b>LOCKED</b> disappears from the display (approximately 4 seconds). <span style="float: right;">Time of day.</span> |

# USING YOUR MICROWAVE OVEN

## SENSOR TOUCH

### OPERATION INSTRUCTION

Sensor touch cooking provides exciting new features to make microwaving easier. The Sensor Menu is preprogrammed with many popular food choices and helps you heat or reheat perfectly.

#### Sensor Menu:

**Reheat, Potato**  
**Popcorn, Fresh Vegetable**  
**Frozen Vegetable, Frozen Entree**

For most Sensor Touch Cooking programs, a table with specific food examples and cooking instructions is provided in the next few pages.

- The Sensor Touch system works by detecting a build-up of vapor.
- Make sure the door remains closed.
- Once the vapor is detected, two beeps will sound.
- Opening the door or touching the STOP/CLEAR pad before the vapor is detected will abort the process. The oven will stop.
- Before using Sensor Touch, make sure the exterior of the reheating container and the interior of the oven are dry, to assure the best results.
- Room temperature should not exceed 95°F.
- Oven should be plugged in at least 5 minutes before sensor cooking.

## POTATO (EXAMPLE)

SENSOR COOK allows you to cook most of your favorite foods without having to select cooking times and power levels. This oven automatically determines required cooking times for each food item.

**Example: To cook potato**

**Touch:**

**Display Shows:**

1.



Time of day.

2.



*POTATO*

## SENSOR TOUCH TABLE

CATEGORY	DIRECTION	AMOUNT
Potato	Pierce each potato with a fork and place on the oven tray around the edge, at least one inch apart.	1~4 medium approx. 10 oz. each
Popcorn	Place bag of prepackaged microwave popcorn on the center of turntable	Regular sizes Use one fresh bag of popcorn
Fresh Vegetable	Prepare as desired, wash, and leave residual water on the vegetables. Place in an appropriately-sized microwave container, cover with plastic wrap and vent.	1~4 cups
Frozen Vegetable	Remove from package, rinse off frost under running water. Place in an appropriately-sized microwave container, cover with plastic wrap and vent.	1~4 cups
Frozen Entree	Remove from outer display package. Slit cover. If not in microwave-safe container, place on plate, cover with plastic wrap, and vent.	10~21 oz.

**NOTE:** If you open the door or press STOP during sensing, the process will be canceled.

# USING YOUR MICROWAVE OVEN

## REHEAT

This feature allows you to reheat precooked room-temperature or refrigerated foods without selecting cooking times and power levels. This feature has 3 categories: dinner plate, soup/sauce, casserole. See Reheat Table for more information.

**Example: To reheat casserole.**

### Touch:



### Display Shows:

Time of day.

*SELECT MENU 1 TO 3 -  
-SEE COOKING GUIDE*

*CASSEROLE*

The oven will reheat food automatically using the sensor system.

## REHEAT TABLE

Code	Category	Direction	Amount
1	<b>Dinner plate</b>	Place foods to be heated on dinner plate or similar dish. Cover with plastic wrap.	Approx. 8~16 oz.
2	<b>Soup/Sauce</b>	Place foods to be heated in an appropriately sized microwave container. Cover with plastic wrap.	1~4 cups
3	<b>Casserole</b>	Cover dish containing the casserole with plastic wrap.	1~4 cups



**NOTE:** Refer to the Cooking Guide located on the front of oven cavity for Reheat information.

# USING YOUR MICROWAVE OVEN

## AUTO COOK

Use this function to cook food without entering a cook time or power. Refer to the "Auto Cook Table" below for more information.

**Example: To cook 4 slices of bacon.**



- | Touch:   | Display Shows:  |
|--|---|
| 1.  | <i>SELECT MENU 1 TO 6 -<br/>-SEE COOKING GUIDE</i>                  |
| 2.  | <i>BACON<br/>TOUCH 2 TO 6 SLICES</i>                                |
| 3.  | Time counts down<br>after <i>4 SLICES</i> scrolls<br>in the display |

**NOTE:** Refer to the Cooking Guide located on the front of oven cavity for Auto Cook information.

## EZ-ON







A time-saving pad, this simplified control lets you quickly set and start microwave cooking at 100% power without the need to touch START.

**Example: To cook for 2 minutes.**

- | Touch:   | Display Shows:                            |
|--|---|
| 1.  | Time of day.                              |
| 2.  | Twice Time counting down<br>and power 100 |

**NOTE:** Each time you touch EZ-ON, it will add 1 minute up to 99 minutes 59 seconds.

## AUTO COOK TABLE

CODE	CATEGORY	DIRECTION	AMOUNT
	Bacon	Place bacon strips on microwave bacon rack for best results. (Use dinner plate lined with paper towels if rack is not available).	2 to 6 slices
	Frozen Roll/Muffin	Remove from display package and place on plate. (If muffins are over 3 oz. each, count as two when entering quantity, heat no more than 3 at a time.)	1 to 6 pieces (2-3 oz. each)
	Fresh Roll/Muffin	Remove from display package and place on plate. (If muffins are over 3 oz. each, count as two when entering quantity, heat no more than 3 at a time.)	1 to 6 pieces (2-3 oz. each)
	Beverage	Remove from display package and place on plate. (Be careful! The beverage will be very hot! Sometimes liquids heated in cylindrical containers will splash out when the container is moved.)	1 to 2 cups
	Chicken Pieces	Place the chicken pieces in an appropriately sized microwaveable container, cover with plastic wrap, and vent.	0.5 to 2 lbs. (0.2 to 1.0 kg)
	Hot Cereal	Prepare as directed on package and cook. Stir and allow standing time before eating. Use only instant hot cereal.	1 to 6 servings





# USING YOUR MICROWAVE OVEN

## CUSTOM SET

CUSTOM SET provides four modes which make using your microwave oven quite handy. You can select CLOCK, SOUND ON/OFF, SCROLL SPEED and LBS/KG.









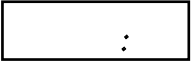

The clock must be set to program or set "Auto-On" brewing of coffee.

**Example: To turn off sound of beeper**

Touch:	Display Shows:
1. 	Time of day.
2. 	Four modes show in the display.
3. 	<i>SOUND ON TOUCH 1 OFF TOUCH 2</i>
4. 	<i>SOUND OFF</i>



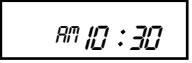

**NOTE:** To turn beep sound back on, repeat steps 1~3 then touch number 1.

**Example: To set the clock for 10:30(AM).**

Touch:	Display Shows:
1. 	
2. 	Four modes show in the display.
3. 	<i>:ENTER TIME OF DAY</i>
4.    	<i>10 : 30 TOUCH START</i>
5. 	<i>10 : 30 AM TOUCH 1 PM TOUCH 2</i>
6. 	<i>AM 10 : 30 TOUCH START</i>
7. 	

**NOTE:** This is a 12 hour clock. You can switch between AM and PM by touching 1 or 2 after step 5.

## CUSTOM SET TABLE

NUMBER	OPTION	NUMBER	RESULT
	CLOCK		
	SOUND ON / OFF	1	Sound On
		2	Sound Off
	SCROLL SPEED	1	Slow speed
		2	Normal speed
		3	Fast speed
	LBS / KG	1	Lbs
		2	Kg

**NOTE:** When the power cord is first plugged in, the default settings are Sound On, Clock On, Normal Speed and LBS.

# USING YOUR MICROWAVE OVEN





## AUTO DEFROST

Three defrost sequences are preset in the oven. The auto defrost feature provides you with the best defrosting method for frozen foods. The Cooking Guide on the front of the oven cavity will show you which defrost sequence is recommended for the food you are defrosting.

For added convenience, the Auto Defrost includes a built-in beep mechanism that reminds you to check, turn over, separate, or rearrange the food to get best defrost results. Three different defrosting options are provided.

- 1 MEAT
- 2 POULTRY
- 3 FISH

\*Available weight is 0.1~6.0 lbs. (0.1 ~ 4.0 kg)

Touch:	Display Shows:
1. 	<i>MEAT TOUCH 1 POULTRY TOUCH 2 FISH TOUCH 3</i>
2. 	<i>0.0 Lbs ENTER WEIGHT</i>
3.  and  to enter the weight	<i>1.2 Lbs TOUCH START</i>
4. 	Time counting down and DEFROST.

### NOTE:

When you touch the START pad, the display changes to defrost time count down. The oven will beep during the DEFROST cycle. At this time, open the door and turn, separate, or rearrange the food. Remove any portions that have thawed. Return frozen portions to the oven and touch START to resume the defrost cycle.

### OPERATING TIPS

- For best results, remove fish, shellfish, meat, and poultry from its original closed paper or plastic package (wrapper). Otherwise, the wrap will hold steam and juice close to the foods, which can cause the outer surface of the foods to cook.
- For best results, shape your ground meat into the form of a doughnut before freezing. When defrosting, scrape off thawed meat when the beep sounds and continue defrosting.
- Place foods in a shallow container or on a microwave roasting rack to catch drippings.
- Food should still be somewhat icy in the center when removed from the oven.

## EZ DEFROST

This feature should be used only when you defrost 1 pound of frozen ground beef.

**Example: To defrost 1 lb ground beef.**

Touch:	Display Shows:
1. 	Time of day.
2. 	Time counting down and EXPRESS DEFROST.



# USING YOUR MICROWAVE OVEN

## AUTO DEFROST TABLE

Category	Food to be Defrosted
<b>1</b> <b>MEAT</b>	<b>Beef</b> Ground beef, Round steak, Cubes for stew, Tenderloin steak, Pot roast, Rib roast, Rump roast, Chuck roast, Hamburger patty <b>Lamb</b> Chops (1-inch thick), Rolled roast <b>Pork</b> Chops ( 1/2-inch thick), Hot dogs, Spareribs, Country-style ribs. Rolled roast, Sausage <b>Veal</b> Cutlets (1 lb., 1/2-inch thick)
<b>2</b> <b>POULTRY</b>	<b>Poultry</b> Whole (under 4 lbs.), Cut-up, Breasts (boneless) <b>Cornish Hens</b> Whole <b>Turkey</b> Breast
<b>3</b> <b>FISH</b>	<b>Steaks/Chops</b> Round beef steak, Tenderloin steak Lamb chops (1-inch thick) Pork chops (1/2-inch thick) Veal cutlets (1 lb., 1/2-inch thick) <b>Fish</b> Fillets, Whole Steaks <b>Shellfish</b> Crab meat, Lobster tails, Shrimp, Scallops

## TIMED COOKING







This feature lets you program a specific cook time and power. For best results, there are 10 power level settings in addition to HIGH power (100%). Refer to the "Microwave Power Level Table" on page 18 for more information.

**NOTE:** If you do not select a power level, the oven will automatically cook at HIGH (100%) power.

**Example: To cook for 5 minutes, 30 seconds at 80% power.**

**Touch:**

**Display Shows:**

1.  : ENTER COOKING TIME
2.    5 : 30 TOUCH START OR POWER
3.  ENTER POWER LEVEL 1 TO 10
4.  5 : 30 POWER 80 TOUCH START
5.  Time counting down and POWER 80.

# USING YOUR MICROWAVE OVEN

## MULTI-STAGE COOKING



For best results, some recipes call for different cook powers during different stages of a cook cycle. You can program your oven for 2 stages, so that it will switch from one power level to another during the cook cycle.

**Example: To set a 2-stage cook cycle.**

**Touch:**

**Display Shows:**

1.  : ENTER COOKING TIME

2.    3 : 00 TOUCH START OR POWER

to set a 3 minute cook time for first stage.

3.  3 : 00 ENTER POWER LEVEL 1 TO 10

4.  to set an 80% cook power for the first stage. 3 : 00 POWER 80 TOUCH START

5.  : ENTER COOKING TIME

6.    7 : 00 TOUCH START OR POWER

to set a 7 minute cook time for second stage.

7.  7 : 00 ENTER POWER LEVEL 1 TO 10

8.  to set a 50% cook power for the second stage. 7 : 00 POWER 50 TOUCH START

9.  Time counting down and POWER 80.

10. When the first stage is over, you will hear two short tones as the oven begins the second cook stage.

## MICROWAVE POWER LEVELS

Your microwave oven has 10 cook power levels to let you cook or heat a wide variety of foods. Refer to the table below for suggestions:

**Microwave Power Level Table**

Power Level	Use
10 (High)	<ul style="list-style-type: none"> <li>Boiling water.</li> <li>Making candy.</li> <li>Cooking poultry pieces, fish, and vegetables.</li> <li>Cooking tender cuts of meat.</li> <li>Whole poultry.</li> </ul>
9	<ul style="list-style-type: none"> <li>Reheating rice, pasta, and vegetables.</li> </ul>
8	<ul style="list-style-type: none"> <li>Reheating prepared foods quickly.</li> <li>Reheating sandwiches.</li> </ul>
7	<ul style="list-style-type: none"> <li>Cooking egg, milk, and cheese dishes.</li> <li>Cooking cakes, breads.</li> <li>Melting chocolate.</li> </ul>
6	<ul style="list-style-type: none"> <li>Cooking veal.</li> <li>Cooking whole fish.</li> <li>Cooking puddings and custard.</li> </ul>
5	<ul style="list-style-type: none"> <li>Cooking ham, whole poultry, and lamb.</li> <li>Cooking rib roast, sirloin tip.</li> </ul>
4	<ul style="list-style-type: none"> <li>Thawing meat, poultry, and seafood.</li> </ul>
3	<ul style="list-style-type: none"> <li>Cooking less tender cuts of meat.</li> <li>Cooking pork chops, roast.</li> </ul>
2	<ul style="list-style-type: none"> <li>Taking chill out of fruit.</li> <li>Softening butter.</li> </ul>
1	<ul style="list-style-type: none"> <li>Keeping casseroles and main dishes warm.</li> <li>Softening butter and cream cheese.</li> </ul>
0	<ul style="list-style-type: none"> <li>Standing time.</li> </ul>

**NOTE:** You may program standing time as the second stage in multi-stage cooking.

# USING YOUR MICROWAVE OVEN

**WARNING:** Do not use large sheets of aluminum foil because they hinder cooking and may cause arcing. You may use small pieces of foil to shield poultry legs and wings. Keep all aluminum foil at least 1 inch from the walls and door of the oven.

## COOKING TIPS

### Meat

1. No special techniques are required. Meat should be prepared as with conventional cooking. Season if desired. Always thoroughly defrost meat before cooking.
2. Place the meat on a microwave roasting rack or microwave-proof plate and place on the turntable.
3. Cook according to the Meat Cooking Table (below). Use the longer time for large cuts of meats and the shorter time for small cuts of meats. For thicker chops, use the longer time.
4. Turn the meat over once halfway through the cooking time.
5. After cook time has finished, allow for 5~10 minutes of standing time to complete the cooking process. If you remove meat for standing time, wrap it in foil.
6. Make sure meat, especially pork, is thoroughly cooked before eating.

### Meat Cooking Table

Meat	Microwave Power	Cooking Time Per Pound
<b>BEEF</b> Standing/Rolled Rib – Medium – Well-done Ground Beef (to brown for casserole) Hamburgers, Fresh or defrosted (4 oz. each) – 2 patties – 4 patties	8 8 HIGH (100%)  HIGH (100%) HIGH (100%)	9½ to 11½ minutes 11½ to 14 minutes 6½ to 9½ minutes  2½ to 4½ minutes 3½ to 5½ minutes
<b>PORK</b> Loin, Leg Bacon – 4 slices – 6 slices	8  HIGH (100%) HIGH (100%)	12½ to 16½ minutes  2½ to 3½ minutes 3½ to 4½ minutes

**NOTE:** The times listed above are only a guide. Allow for difference in individual tastes and preferences. The times may also vary due to the shape, cut, and composition of the food.

### Poultry

1. No special techniques are required. Poultry should be prepared as with conventional cooking. Season if desired.
2. Poultry should be thoroughly defrosted. Remove giblets and any metal clamps.
3. Prick the skin and brush lightly with vegetable oil unless the poultry is self-basting.
4. All poultry should be placed on a microwave roasting rack or a microwave-proof plate and placed on the turntable.
5. Cook according to the instructions in the Poultry Cooking Table below. Turn over halfway through the cooking time. Because of its shape, poultry has a tendency to cook unevenly, especially in very bony parts. Turning food over helps to cook these areas evenly.
6. After cook time has finished, allow for 5~10 minutes of standing time to complete the cooking process. If you remove poultry for standing time, wrap it in foil.
7. Make sure poultry is thoroughly cooked before eating. Whole poultry is completely cooked when the juices run clear from the inside thigh when it is pierced with a sharp knife. Poultry pieces should be pierced with a sharp knife through the thickest part to ensure that the juices are clear and the flesh is firm.

### Poultry Cooking Table

Poultry	Microwave Power	Cooking Time Per Pound
<b>CHICKEN</b> Whole Breast (boned) Portions	8 8 8	11 to 15 minutes 10 to 14 minutes 11 to 17 minutes
<b>TURKEY</b> Whole	8	11 to 15 minutes

#### NOTES:

- The times listed above are only a guide. Allow for difference in individual tastes and preferences. The times may also vary due to the shape, cut, and composition of the food.
- If whole poultry is stuffed, the weight of the stuffed bird should be used when calculating the cooking time.

# USING YOUR MICROWAVE OVEN

## COOKING TIPS (continued)

### Fish

1. Arrange fish in a large shallow non-metallic dish or casserole.
2. Cover with pierced microwave plastic wrap or casserole lid.
3. Place the dish on the turntable.
4. Cook according to the instructions in the Fresh Fish Cooking Table below. Flakes of butter can be added to the fish if desired.
5. Let stand as directed in the Cooking Table before serving.
6. After standing time, check to see that the fish is thoroughly cooked. The fish should be opaque and flake easily.

### Fresh Fish Cooking Table

Fish	Microwave Power	Cooking Time Per Pound	Butter	Standing Time
Fish Fillets	HIGH	4½ to 8 minutes	Add 15 to 30 ml (1 to 2 tbsp lemon juice)	2 to 3 minutes
Whole Mackerel, Cleaned and Prepared	HIGH	4½ to 8 minutes	–	3 to 4 minutes
Whole Trout, Cleaned and Prepared	HIGH	5½ to 9 minutes	–	3 to 4 minutes
Salmon Steaks	HIGH	5½ to 8 minutes	Add 15 to 30 ml (1 to 2 tbsp lemon juice)	3 to 4 minutes

# USING YOUR COFFEE MAKER

## PREPARING COFFEE

1. Pull out the water reservoir. (Remove the water reservoir, lift it slightly)

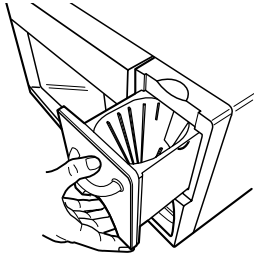

<Fig. 1>

2. Place a #2 size paper coffee filter in the filter basket (Fig. 2, 3). Add coffee for the amount to be brewed (Fig. 4) (usually one heaping tablespoon (6g) for every two coffee cups; adjust to suit your taste).

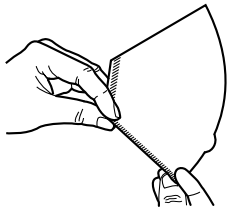

<Fig. 2>

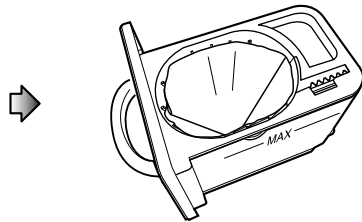

<Fig. 3>

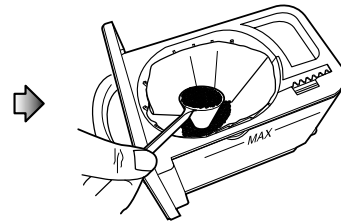

<Fig. 4>

3. Fill the Water Reservoir.

Fill with the water through the hole of the reservoir to the desired cup level. (Fig. 5, 6)

Do not exceed the MAX line. (Maximum : 7 coffee cups, 1 coffee cup is approximately 5 oz, or 140 cc)

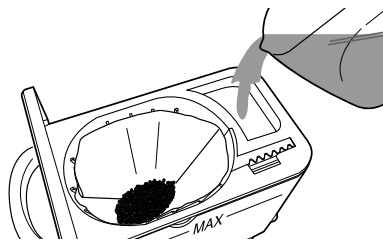

<Fig. 5>

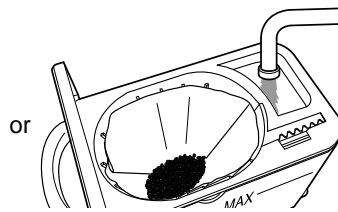

<Fig. 6>

4. Push the filled Reservoir back into the Coffee maker to the end.

Make sure you have replaced the Carafe in its position on the warming plate. (Fig. 7, 8)

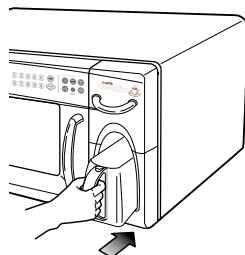

<Fig. 7>

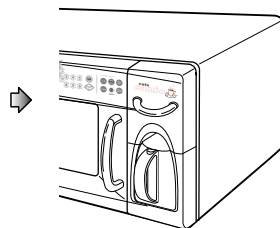

<Fig. 8>

# USING YOUR COFFEE MAKER

## BREW STRENGTH CONTROL

### Pre-selecting the taste (flavor selector)

The flavor selector (Fig. 9) allows you to adjust the flavor of your coffee to suit your personal tastes. It helps ensure a full, rich flavor, while allowing you to select a milder flavor without bitter aftertaste, or a strong, robust taste.

If you prefer a milder coffee, without bitter aftertaste, pull the flavor selector toward the center of the filter basket (Fig. 10).

If you prefer a strong, robust flavor, push the flavor selector in to the side of the filter basket (Fig. 11).

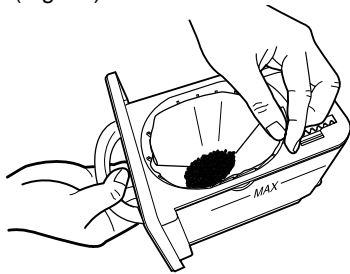

<Fig. 9>

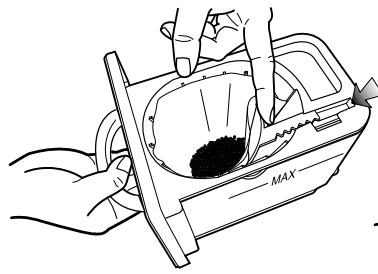

<Fig. 10>

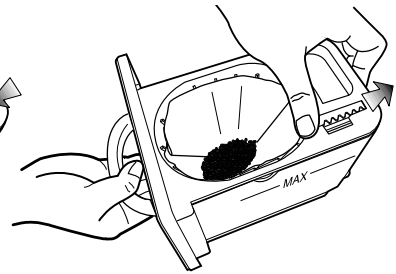

<Fig. 11>

## CLEANING THE COFFEE MAKER

To clean the coffee maker after brewing, be sure the unit is OFF and has cooled. Discard the paper filter and grounds, and clean as follows:

The water reservoir, filter basket, carafe, and carafe lid are all top-rack dishwasher safe. They may also be hand-washed.

Warming plate may be cleaned with a soft damp cloth.

Do not use abrasive cleansers or scouring pads. Never immerse the Coffee Maker.

If you want to remove carafe lid, open and tilt the lid to one side.

If you want to separate filter basket from water reservoir, refer to Fig.12, 13.

Reassemble the filter basket and reservoir with opposite motion being careful to properly engage the reservoir's seal. Ensure the filter basket is fully seated to the reservoir to prevent leakage.

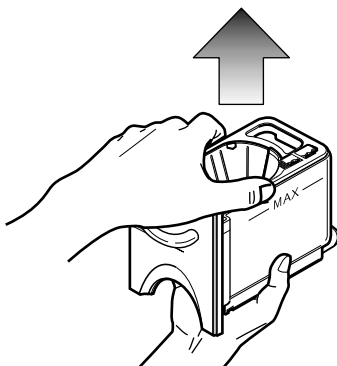

<Fig. 12>

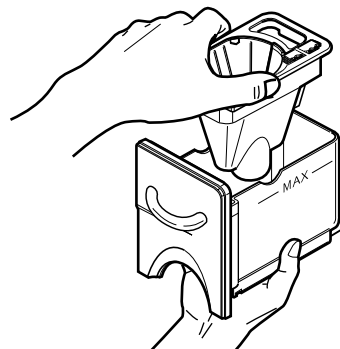

<Fig. 13>

# USING YOUR COFFEE MAKER

## SELF-CLEANING (HOT WATER TUBE)

1. To clean, fill the water reservoir to capacity with a mixture of  $\frac{1}{3}$  white vinegar and  $\frac{2}{3}$  water
2. Press the **“BREW”** button.  
One cycle should be sufficient to adequately clean the coffee maker.
3. Run at least two cycles of fresh cold water through the unit before using the unit again to brew coffee.

## IMPORTANT

1. Always use cold water to make coffee.  
Warm water or other liquids could cause damage to the coffee maker.
2. Before using the first time, or when the coffee maker has not been used for some time, fill the water reservoir to the maximum with cold water and without coffee grounds and without a paper filter.  
Turn on and allow the water to flow through, then discard and fill with clean water.
3. Never pull out the water reservoir during the brewing cycle.  
Extremely hot water or steam can cause injury.  
Always wait 5 minutes after coffee is brewed, before pulling out the water reservoir.
4. Do not detach the filter basket from the water reservoir when it is filled with water.
5. When you remove the water reservoir, lift it slightly.

# USING YOUR COFFEE MAKER

## Brew

This pad is used when you want to brew more than 4 cups of coffee.

**Touch:**



**Display Shows:**

Time of the day.

 BREW/WARM-MED

(Scroll)



 BREW END

(Scroll 3 times &  
Beep 5 times)



After scrolling stops.

 COFFEE/WARM-MED

(Scroll)



WARM END

(Scroll 3 times &  
Beep 3 times)



After scrolling stops.

Time of the day.

## SMALL BATCH

This pad is used when you want to brew a small amount (1~4 cups) of coffee.

**Touch:**



**Display Shows:**

Time of the day.

 SMALL/BATCH/WARM-MED

(Scroll)



 SMALL/BATCH/END

(Scroll 3 times &  
Beep 5 times)



After scrolling stops.

 COFFEE/WARM-MED



WARM END

(Scroll 3 times &  
Beep 3 times)



After scrolling stops.

Time of the day.

**NOTE:** When the brewing is completed, coffee maker enters KEEP WARM mode automatically.

- Warming temperature is set at medium when the unit is plugged in.  
User can adjust the temperature using temp touch pad. (See page 26)
- Warming time is set to 1 hour when the unit is plugged in.  
User can adjust warming time on the program touch pad. (See page 26)



# USING YOUR COFFEE MAKER









## HOW TO SET THE BREW TIMER FOR AUTO-ON MODE

This pad enables you to enjoy freshly brewed coffee at any pre-set time within a 24-hour period.

**NOTE:** Time of Day must be set before setting Auto-On time.



**Example program: Auto-On, 7:20 A.M., Brew**

### Touch: Display Shows:

- |   |   |
|---|---|
|   | Time of the day.  |
| 1.   | <i>BREW TIMER / TOUCH 1 /<br/>WARM / TIME / TOUCH 2</i><br>(Scroll)         |
|   | ↓   |
| 2.   | <i>: ENTER / AUTO ON /<br/>TIME OF DAY</i><br>(Scroll)                      |
|   | ↓   |
| 3.    | <i>7:20<br/>TOUCH / TIME SET</i><br>(Scroll)                                |
|   | ↓   |
| 4.   | <i>7:20<br/>AM / TOUCH 1 / PM / TOUCH 2</i><br>(Scroll)                     |
|   | ↓   |
| 5.   | <i>AM 7:20<br/>TOUCH / TIME SET</i><br>(Scroll)                             |
|   | ↓   |
| 6.   | <i>AM 7:20<br/>BREW / TOUCH 1 /<br/>SMALL / BATCH / TOUCH 2</i><br>(Scroll) |
|   | ↓ After scrolling stops.  |

### Touch:

### Display Shows:

- |  |  |
|--|--|
| 7.  | <i>AM 7:20<br/>BREW / TOUCH / TIME SET</i><br>(Scroll) |
|  | ↓  |
| 8.  | <i>SET / BREW / TIMER</i><br>(Scroll once)             |
|  | ↓ After scrolling stops.                               |
|  | Time of the day.                                       |
|  | ↓  |
| 9.  | <i>AM 7:20<br/>SET / AUTO ON</i>                       |
|  | ↓ After scrolling stops.                               |
|  | Time of the day.                                       |
|  | <i>Auto BREW</i>                                       |

### NOTE:

1. If "Auto-On" mode is set once, Coffee Maker can be activated everyday at that time you already pre-set .
2. To deactivate "Auto-On", touch "Timer On/Off". (Disappear 'Auto BREW')
3. If you activate "Auto-On" mode, touch "Timer On/Off" again.

# USING YOUR COFFEE MAKER

## ADJUST WARMING PLATE TEMP

Use this pad when you want to adjust the warming plate temperature of coffee after brewing (including small batches).

This pad can be used during brewing (including small batches), or warming.

**Example: Setting to high during brewing**

**Touch:**

**Display Shows:**

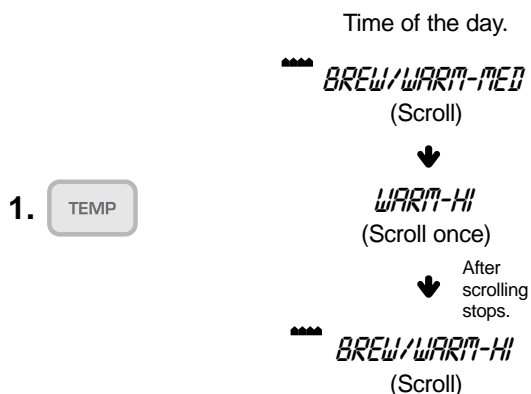

**NOTE:**

1. Temperature of the coffee after brewing has choice of 3 levels - "HIGH", "MEDIUM", and "LOW".
2. Whenever you touch "Temp." key, the warm temperature level will be changed in sequence. ("LOW" → "MEDIUM" → "HIGH" → "LOW"...)
3. Warming plate temperature is set at MEDIUM when the unit is plugged in.

## ADJUST WARMING PLATE TIME

Use this pad when you want to change the warming time.

**Example : To set warm time for 1 hour 30 minutes.**

**Touch:**

**Display Shows:**

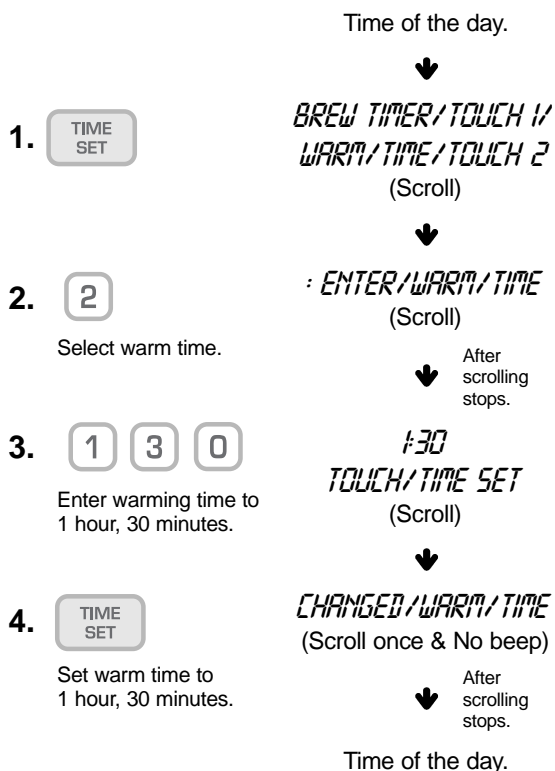

**NOTE:**

1. Warming time can be set from 10 min. up to 2 hrs.
2. Warming time is set to 1 hr. when you plug in.

# **USING YOUR COFFEE MAKER**

## **OTHER FUNCTIONS**

### **■ “Auto-On” operation when other functions are in use.**

- 1) Microwave cooking or programmed microwave cooking.
  - Will delay “Auto-on” brewing until 5 minutes after microwave cooking is finished.  
Auto-On start will not occur if the microwave is still operating for 30 minutes after the programmed Auto-On time is set to start.
- 2) Brewing or Small Batch Brewing is in use
  - “Auto-On” will not occur.
- 3) Warming plate function is in use
  - “Auto-On” will operate normally and warm function will be cancelled.

### **■ Simultaneous Operation**

- 1) Basically, you can not use the Microwave Oven while the brew functions, such as ‘Brew’, ‘1-4’ are activated.  
Otherwise you can use all other Microwave functions, such as timer and clock.
- 2) You cannot operate Coffee Maker functions while Microwave Oven is operating.

# TROUBLESHOOTING

## Questions and Answers

### Operation

Question	Answer
Why is the oven light not on during cooking?	There may be several reasons why the oven light is not on. Have you: <ul style="list-style-type: none"> <li>• Set a cooking time?</li> <li>• Touched START?</li> </ul>
Why does steam come out of the air exhaust vent?	Steam is normally produced during cooking. The microwave oven has been designed to vent this steam.
Will the microwave oven be damaged if it operates empty?	Yes. Never operate the oven empty or without the glass turntable.
Does microwave energy pass through the viewing screen in the door?	No. The metal screen bounces the energy back to the oven cavity. The holes (or ports) allow only light to pass through. They do not let microwave energy pass through.
Why does a tone sound when a pad on the control panel is touched?	The tone tells you that the setting has been entered.
Can my microwave oven be damaged if food is cooked for too long?	Like any other cooking appliance, it is possible to overcook food to the point that the food creates smoke, and even possibly fire and damage to the inside of the oven. It is always best to be near the oven while you are cooking.
When the oven is plugged into a wall outlet for the first time, it does not work properly. What is wrong?	The microcomputer controlling your oven may temporarily become scrambled and fail to function as programmed when you plug it in for the first time or when power resumes after a power interruption. Unplug the oven from the ~120 volt household outlet and then plug it back in to reset the microcomputer.
Why do I see light reflection around the outer case?	This light is from the oven light which is located between the oven cavity and the outer wall of the oven.
What are the various sounds I hear when the microwave oven is operating?	The clicking sound is caused by a mechanical switch turning the microwave oven's magnetron ON and OFF. The heavy hum and clunk is from the change in power the magnetron draws as it is turned ON and OFF by a mechanical switch. The change in blower speed is from the change in line voltage caused by the magnetron being turned ON and OFF.
What does "F-1" and "F-2" code on the display mean?	That means failure mode. Contact the nearest Authorized Service Center.

# TROUBLESHOOTING

## Questions and Answers (continued)

### Food

Question	Answer
Why are scrambled eggs sometimes a little dry after cooking?	Eggs will dry out when they are overcooked, even if the same recipe is used each time. The cooking time may need to be varied for one of these reasons: <ul style="list-style-type: none"> <li>• Eggs vary in size.</li> <li>• Eggs are at room temperature one time and at refrigerator temperature another time.</li> <li>• Eggs continue cooking during standing time.</li> </ul>
Why do baked apples sometimes burst during cooking?	The peel has not been removed from the top half of each apple to allow for expansion of the interior of the apple during cooking. As in conventional cooking methods, the interior of the apple expands during the cooking process.
Why do baked potatoes sometimes burn during cooking?	If the cooking time is too long, fire could result. At the end of the recommended cooking time, potatoes should be slightly firm. <b>CAUTION: Do not overcook.</b>
Why is a standing time recommended after microwave cooking time is over?	Standing time allows foods to continue cooking evenly for a few minutes after the actual microwave oven cooking cycle ends. The amount of standing time depends upon the density of the foods.
Why is additional time required for cooking food stored in the refrigerator?	As in conventional cooking, the initial temperature of food affects total cooking time. You need more time to cook food taken out of a refrigerator than for food at room temperature.
What is wrong when baked foods have a hard, dry, brown spot?	A hard, dry, brown spot indicates overcooking. Shorten the cooking or reheating time.
Why do eggs sometimes pop?	When baking, frying, or poaching eggs, the yolk may pop due to steam buildup inside the yolk membrane. To prevent this, simply pierce the yolk with a wooden toothpick before cooking. <b>CAUTION: Never microwave eggs in the shell.</b>

### Brewing coffee

Question	Answer
Brewing or 1~4 will not operate	Is microwave oven in use?
Coffee is weak or strong	Amount of coffee or water setting Adjustment of the Flavor selector bar
Coffee is cold	Adjustment of warming plate timer
Coffee is bitter	Overheated or too long on warming plate (Most coffees best consumed within 20 minutes of brewing.)
Coffee Maker malfunctions (No water flow)	<ul style="list-style-type: none"> <li>• Is "Water Reservoir" installed properly?</li> <li>• Is "Water Reservoir" empty?</li> </ul>

# LG MICROWAVE OVEN LIMITED WARRANTY & USA

LG Electronics Inc. will repair or replace your product, at LG's option, if it proves to be defective in material or workmanship under normal use, during the warranty period set forth below, effective from the date of original consumer purchase of the product. This limited warranty is good only to the original purchaser of the product and effective only when used in the United States, including U.S. Territories.

<p><b><u>WARRANTY PERIOD:</u></b></p> <p><b>Model: LCRM1240SW/SB/ST</b></p> <p><b>Labor: 1 Year</b> from the Date of Purchase.</p> <p><b>Parts: 1 Year</b> from the Date of Purchase.</p> <p><b>Magnetron: 10 Years</b> from the Date of Purchase.</p>	<p><b><u>HOW SERVICE IS HANDLED:</u></b></p> <p>Call 1-877-714-7486 and choose the appropriate prompt. Please have product type (Microwave) and ZIP code ready.</p>
--	---

**THIS WARRANTY IS IN LIEU OF ANY OTHER WARRANTIES, EXPRESS OR IMPLIED, INCLUDING WITHOUT LIMITATION, ANY WARRANTY OF MERCHANTABILITY OR FITNESS FOR A PARTICULAR PURPOSE. TO THE EXTENT ANY IMPLIED WARRANTY IS REQUIRED BY LAW, IT IS LIMITED IN DURATION TO THE EXPRESS WARRANTY PERIOD ABOVE. LG WILL NOT BE LIABLE FOR ANY CONSEQUENTIAL, INDIRECT, OR INCIDENTAL DAMAGES OF ANY KIND, INCLUDING LOST REVENUES OR PROFITS, IN CONNECTION WITH THE PRODUCT. SOME STATES DO NOT ALLOW LIMITATION ON HOW LONG AN IMPLIED WARRANTY LASTS OR THE EXCLUSION OF INCIDENTAL OR CONSEQUENTIAL DAMAGES, SO THE ABOVE LIMITATIONS OR EXCLUSIONS MAY NOT APPLY TO YOU.**

**THIS LIMITED WARRANTY DOES NOT APPLY TO:**

1. Service trips to your home to deliver, pick up, and/or install the product, instruct, or replace house fuses or correct wiring, or correction of unauthorized repairs; and
2. Damages or operating problems that result from misuse, abuse, operation outside environmental specifications or contrary to the requirements or precautions in the Operating Guide, accident, vermin, fire, flood, improper installation, acts of God, unauthorized modification or alteration, incorrect electrical current or voltage, or commercial use, or use for other than intended purpose.
3. Therefore, the cost of repair or replacement of such a defective product shall be borne by the consumer.

**CUSTOMER INTER-ACTIVE CENTER NUMBERS:**

<p><b>To Prove Warranty Coverage</b></p>	<p><b>Retain your Sales Receipt to prove date of purchase.</b> A copy of your Sales Receipt must be submitted at the time warranty service is provided.</p>
<p><b>To Obtain Nearest Authorized Service Center or Sales Dealer, or to Obtain Product, Customer, or Service Assistance</b></p>	<p><b>Call 1-877-714-7486</b> (Monday ~ Friday, 7 AM ~ 8 PM CT; and Saturday, 8 AM ~ 5 PM CT) and choose the appropriate prompt from the menu; or visit our website at <a href="http://us.lgservice.com">http://us.lgservice.com</a>.</p>



**LG Electronics Inc.**

P/NO.: 3828W5A4205

Printed in China

## Free Manuals Download Website

<http://myh66.com>

<http://usermanuals.us>

<http://www.somanuals.com>

<http://www.4manuals.cc>

<http://www.manual-lib.com>

<http://www.404manual.com>

<http://www.luxmanual.com>

<http://aubethermostatmanual.com>

Golf course search by state

<http://golfingnear.com>

Email search by domain

<http://emailbydomain.com>

Auto manuals search

<http://auto.somanuals.com>

TV manuals search

<http://tv.somanuals.com>