



OWNER'S MANUAL

MICROWAVE OVEN

PLEASE READ THIS OWNER'S MANUAL THOROUGHLY
BEFORE OPERATING.

LCRT2010ST



MFL07529603

www.lg.com

TABLE OF CONTENTS

SAFETY	3-4
Precautions to Avoid Possible Exposure To Excessive Microwave Energy	3
Grounding Instructions	3
Important Safety Instructions	4
UNDERSTANDING YOUR MICROWAVE OVEN	5-9
Specifications	5
Installation	5
Parts and Accessories	6
Control Panel	7
Cookware Guide	8
Tips for Microwave Cooking	9
Cleaning	9
HOW TO USE TrueCookPlus™	10-11
USING YOUR MICROWAVE OVEN	12-22
Clock	12
Child Lock	12
Kitchen Timer	12
EZ-on	12
Sensor Touch Operation Instruction	13
Potato (Example)	13
Quick Sensor Touch Table	13
Sensor Touch Reheat	14
Sensor Touch Popcorn	14
Custom Set	15
Auto Cook	16
More / Less	16
Auto Defrost	17
Express Defrost	18
Multi-stage Cooking	18
Soften	19
Melt	19
Time Cook	20
Microwave Power Levels	20
Cooking Tips	21-22
MEAT	21
Meat Cooking Table	21
POULTRY	21
Poultry Cooking Table	21
FISH	22
Fresh Fish Cooking Table	22
TROUBLESHOOTING	23-25
Questions and Answers	23-24
Before Calling for Service	25
WARRANTY	Inside back cover

Thank you for purchasing a LG microwave oven.

Please record the model number and serial number of this unit for future reference. We also suggest you record the details of your contact with LG (LG Electronics U.S.A., Inc.) concerning this unit.

Staple your receipt here for proof of purchase.

Model No: _____

Serial No: _____

Dealer: _____

Dealer Phone No: _____

Customer Relations
 LG Electronics U.S.A., Inc.
 Service Division Bldg. #3
 201 James Record Rd.
 Huntsville, AL 35824-0126

SAFETY

PRECAUTIONS TO AVOID POSSIBLE EXPOSURE TO EXCESSIVE MICROWAVE ENERGY

- Do not attempt to operate this oven with the door open, since open-door operation can result in harmful exposure to microwave energy. It is important not to defeat or tamper with the safety interlocks.
- Do not place any object between the oven front face and the door, or allow soil or cleaner residue to accumulate on sealing surfaces.
- Do not operate the oven if it is damaged. It is particularly important that the oven door close properly and that there is no damage to the:
 - door (bent),
 - hinges and latches (broken or loosened),
 - door seals and sealing surfaces.
- The oven should not be adjusted or repaired by anyone except properly qualified service personnel.

GROUNDING INSTRUCTIONS

This appliance must be grounded. In the event of an electrical short circuit, grounding reduces the risk of electric shock by providing an escape wire for the electric current. This appliance is equipped with a cord having a grounding wire and a grounding plug. The plug must be plugged into an outlet that is properly installed and grounded.

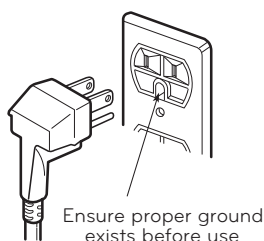

⚠ WARNING

Improper grounding can result in a risk of electric shock. Consult a qualified electrician if the grounding instructions are not completely understood, or if doubt exists as to whether the appliance is properly grounded, and either:

1. If it is necessary to use an extension cord, use only a 3-wire extension cord that has a 3-blade grounding plug, and a 3-slot receptacle that will accept the plug on the appliance. The marked rating of the extension cord shall

be equal to or greater than the electrical rating of the appliance, or. . . .

2. Do not use an extension cord. If the power supply cord is too short, have a qualified electrician or serviceman install an outlet near the appliance.

NOTES:

1. A short power-supply cord is provided to reduce the risks resulting from becoming entangled in or tripping over a longer cord.
2. Longer cord sets or extension cords are available and may be used if care is exercised in their use.
3. If a long cord or extension cord is used, (1) the marked electrical rating of the cord set or extension cord should be at least as great as the electrical rating of the appliance, (2) the extension cord must be a grounding-type 3-wire cord, and (3) the longer cord should be arranged so that it will not drape over the countertop or tabletop where it can be pulled on by children or tripped over accidentally.

SAFETY

IMPORTANT SAFETY INSTRUCTIONS

The safety instructions below will tell you how to use your oven to avoid harm to yourself or damage to your oven.

⚠ WARNING – To reduce the risk of burns, electric shock, fire, injury to persons, or exposure to excessive microwave energy:

1. Read all instructions before using the appliance.
2. Read and follow the specific **PRECAUTIONS TO AVOID POSSIBLE EXPOSURE TO EXCESSIVE MICROWAVE ENERGY** found on page 3 of this manual.
3. This appliance must be grounded. Connect only to properly grounded outlet.
See **GROUNDING INSTRUCTIONS** found on page 3 of this manual .
4. Install or locate this appliance only in accordance with the provided installation instructions.
5. Some products, such as whole eggs and sealed containers – for example, closed glass jars are able to explode and should not be heated in this oven.
6. Use this appliance only for its intended use as described in the manual. Do not use corrosive chemicals or vapors in this appliance. This type of oven is specifically designed to heat, cook, or dry food. It is not designed for industrial or laboratory use.
7. As with any appliance, close supervision is necessary when used by children.
8. Do not operate this appliance if it has a damaged cord or plug, if it is not working properly, or if it has been damaged or dropped.
9. This appliance should be serviced only by qualified service personnel. Contact the nearest authorized service facility for examination, repair, or adjustment.
10. Do not cover or block any openings on the appliance.
11. Do not store this appliance outdoors. Do not use this product near water – for example, near a kitchen sink, in a wet basement, near a swimming pool, or similar location.
12. Do not immerse cord or plug in water.
13. Keep cord away from heated surfaces.
14. Do not let cord hang over the edge of a table or counter.
15. When cleaning surfaces of door and oven that come together on closing the door, use only mild, nonabrasive soaps or detergents applied with a sponge or soft cloth.
16. To reduce the risk of fire in the oven cavity:
 - a. Do not overcook food. Carefully attend appliance when paper, plastic, or other combustible materials are placed inside the oven to facilitate cooking.
 - b. Remove wire twist-ties from paper or plastic bags before placing bag in oven.
 - c. If materials inside the oven ignite, **KEEP OVEN DOOR CLOSED**, turn oven off, and disconnect the power cord or shut off power at the fuse or circuit breaker panel.
 - d. Do not use the cavity for storage purposes. Do not leave paper products, cooking utensils, or food in the cavity when not in use.
17. Liquids such as water, coffee, or tea are able to be overheated beyond the boiling point without appearing to be boiling. Visible bubbling or boiling when the container is removed from the microwave oven is not always present. **THIS COULD RESULT IN VERY HOT LIQUIDS SUDDENLY BOILING OVER WHEN THE CONTAINER IS DISTURBED OR A SPOON OR OTHER UTENSIL IS INSERTED INTO THE LIQUID.** To reduce the risk of injury to persons; 1) Do not overheat the liquid. 2) Stir the liquid both before and halfway through heating it. 3) Do not use straight-sided containers with narrow necks. 4) After heating, allow the container to stand in the microwave oven for a short time before removing the container. 5) Use extreme care when inserting a spoon or other utensil into the container.
18. Avoid heating small-necked containers such as syrup bottles.
19. Avoid using corrosive and vapors, such as sulfide and chloride.
20. Liquids heated in certain shaped containers (especially cylindrical-shaped containers) may become overheated. The liquid may splash out with a loud noise during or after heating or when adding ingredients (instant coffee, etc.), resulting in harm to the oven and possible injury. In all containers, for best results, stir the liquid several times before heating. Always stir liquid several times between reheatings.

SAVE THESE INSTRUCTIONS

UNDERSTANDING YOUR MICROWAVE OVEN

SPECIFICATIONS

MODEL	LCRT2010ST
Power Supply	120 V AC, 60 Hz
Rated Power Consumption	1650 W
Microwave Output	*1200 W
Frequency	2450 MHz
Rated Current	14.0 A
Overall Dimensions (W×H×D)	23 ⁷ / ₁₆ " x 13 ⁹ / ₁₆ " x 19 ³ / ₁₆ "
Oven Cavity Dimensions (W×H×D)	16 ¹ / ₁₆ " x 11 ¹ / ₄ " x 18 ¹ / ₁₆ "
Capacity of Oven Cavity	2.0 Cu.ft.

*IEC 60705 RATING STANDARD

Specifications subject to change without prior notice.

INSTALLATION

A. Circuits

For safety purposes this oven must be plugged into a 15 or 20 Amp circuit. No other electrical appliances or lighting circuits should be on this line. If in doubt, consult a licensed electrician.

B. Voltage Warning

The voltage used at the wall receptacle must be the same as specified on the oven name plate located on the back or on the side of the control panel of the oven. Use of a higher voltage is dangerous and may result in a fire or other type of accident causing oven damage. Low voltage will cause slow cooking. In case your microwave oven does not perform normally in spite of proper voltage, remove and reinsert the plug.

C. Placement of the Oven

Your microwave oven can be placed easily in your kitchen, family room, or anywhere else in your home. Place the oven on a flat surface such as a kitchen countertop or a specially designed microwave oven cart. Do not place oven above a gas or electric range. Free air flow around the oven is important. Allow at least 4 inches of space at the top, sides, and back of the oven for proper ventilation.

D. Do not block the air vents

All air vents should be kept clear during cooking. If air vents are covered during oven operation the oven may overheat. In this case, a sensitive thermal safety device automatically turns the oven off. The oven will be inoperable until it has cooled sufficiently.

E. Radio interference

1. Microwave oven operation may interfere with TV or radio reception.
2. When there is interference, it may be reduced or eliminated by taking the following measures:
 - a. Clean the door and the sealing surfaces of the oven.
 - b. Reorient the receiving antenna of radio or television.
 - c. Relocate the microwave oven in relation to the TV or radio.
 - d. Move the microwave oven away from the receiver.
 - e. Plug the microwave oven into a different outlet so that microwave oven and receiver are on different branch circuits

⚠ WARNING: This product contains chemicals known to the State of California to cause cancer. ***Wash hands after handling.***

UNDERSTANDING YOUR MICROWAVE OVEN

PARTS AND ACCESSORIES

Your oven comes with the following accessories:

- 1 Use and Care Manual
- 1 Glass Turntable
- 1 Rotating Ring

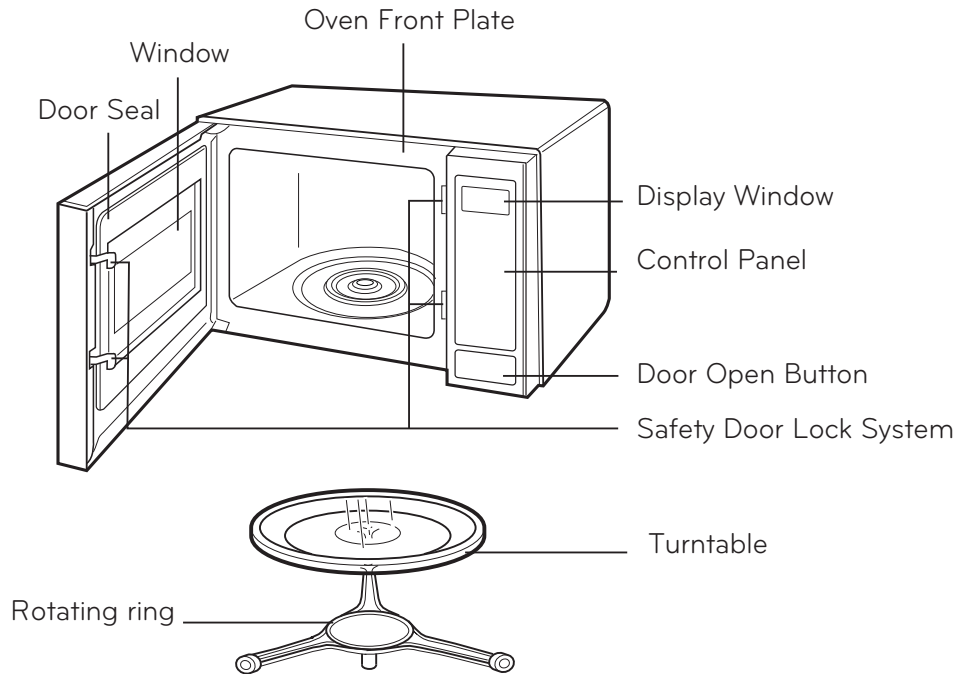

NOTE: This microwave oven is designed for household use only. It is not recommended for commercial use.

⚠️ WARNING:

Do not operate the oven when empty or without the glass tray. It is best to leave a glass water in the oven when not in use. The water will safely absorb all microwave energy, if the oven is accidentally started.

UNDERSTANDING YOUR MICROWAVE OVEN

CONTROL PANEL

- 1. DISPLAY.** The display includes a clock and indicators that tell you time of day cooking time settings, and cooking functions selected.
- 2. SENSOR TOUCH.** This pad allows you to cook most of your favorite foods without having to select cooking times and power levels.
- 3. CUSTOM SET.** Touch this pad to select sound(on/off), clock(on/off), scroll speed(slow, normal, fast) and unit(lbs./kg.).
- 4. AUTO COOK.** Touch this pad to select programming food items.
- 5. LESS.** Each time you touch this pad, you subtract 10 seconds from the cooking time.
- 6. MORE.** Each time you touch this pad, you add 10 seconds to the cooking time.
- 7. AUTO DEFROST.** This pad is an accurate defrosting method for meat, poultry and fish up to 6.0 lbs or 4.0 kg.
- 8. EXPRESS DEFROST.** Touch this pad to thaw only 1lb of food very quickly.
- 9. SOFTEN.** Touch this pad to soften butter, ice cream, cream cheese, or frozen juice.
- 10. MELT.** Touch this pads to melt butter, margarine, chocolate, cheese, or marshmallows.
- 11. NUMBER PADS** Touch number pads to enter cooking time, power level, quantities, or weights.
- 12. TIME COOK.** Touch this pad to set a cooking time.
- 13. POWER LEVEL** Touch this pad to set a cooking power.
- 14. KITCHEN TIMER.** Touch this pad to use your microwave oven as a kitchen timer.
- 15. TrueCookPlus™:** Touch this pad to cook food according to TrueCookPlus™ code.
- 16. CLOCK.** Touch this pad to enter the time of day.
- 17. EZ-ON.** Touch this pad to cook at 100% cook power for 30 seconds up to 3 minutes 30 seconds; after 3 minutes 30 seconds, every touch will add 1 minute up to 99 min 59 seconds.
- 18. START/ENTER.** This feature allows oven to begin functioning.
- 19. STOP/CLEAR.** Touch this pad to stop the oven or clear entries.

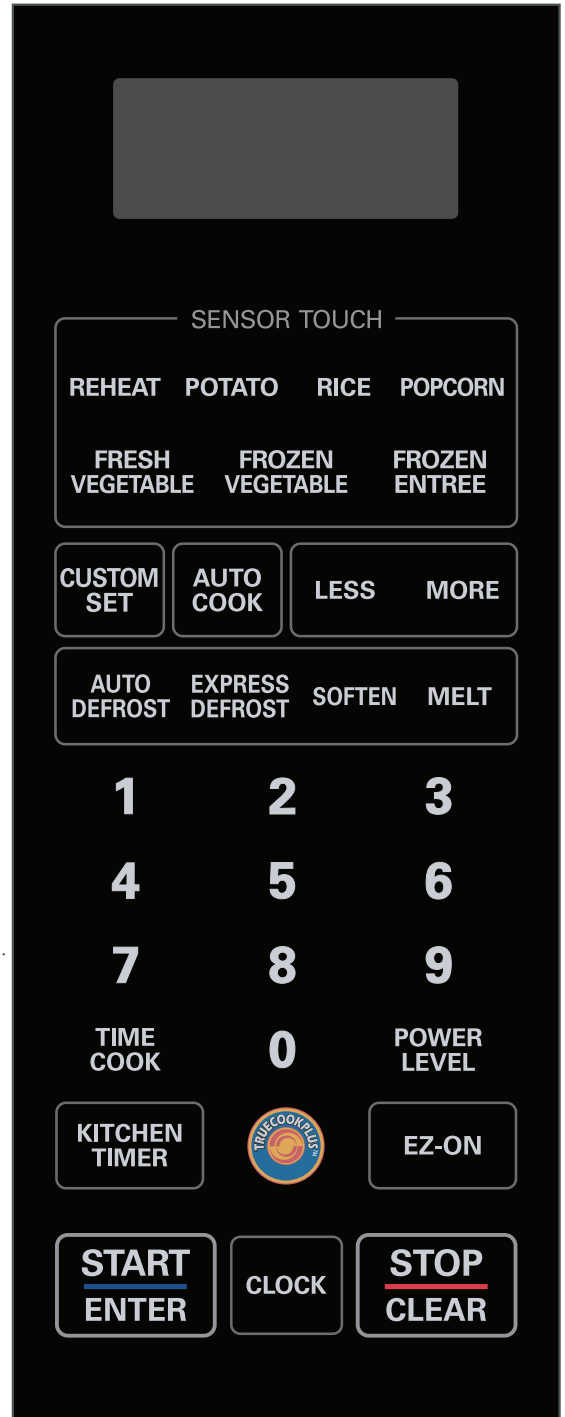

UNDERSTANDING YOUR MICROWAVE OVEN

COOKWARE GUIDE

Most heat-resistant, non-metallic cookware is safe for use in your microwave oven. However, to test cookware before using, follow these steps:

1. Place the empty cookware in the microwave oven.
2. Measure 1 cup of water in a glass measuring cup and place it in the oven beside the cookware.
3. Microwave on 100% power for 1 minute. If the dish is warm, it should not be used for microwave cooking.

USE	DO NOT USE
<p>Ovenproof Glass</p> <ul style="list-style-type: none"> • Glass treated for use in high-intensity heat includes utility dishes, bread dishes, pie plates, cake plates, liquid measuring cups, casseroles, and bowls without metallic trim. <p>China</p> <ul style="list-style-type: none"> • Bowls, cups, serving plates, and platters without metallic trim can be used in your oven. <p>Plastic</p> <ul style="list-style-type: none"> • When using plastic wrap as a cover, make sure that the dish is deep enough so the plastic wrap does not touch the food. As the food heats, it may melt the plastic wrap wherever the wrap touches the food. • Place plastic wrap loosely over the top of the dish and secure it by pressing the wrap to the sides of the dish. • Vent by turning back one corner of the plasticwrap. This will allow excess steam to escape. • Use plastic dishes, cups, semi-rigid freezer containers, and plastic bags only for short time cooking. Use these with care because the plastic may soften from the heat of the food. <p>Paper</p> <ul style="list-style-type: none"> • Microwave-safe paper towels, waxed paper, paper napkins, and paper plates with no metallic trim or design can be used in your oven. • Refer to the manufacturer's label for use of any paper product in the microwave oven. 	<p>Metal Utensil</p> <ul style="list-style-type: none"> • Metal shields food from microwave energy and produces uneven cooking. Avoid metal skewers, thermometers, or foil trays. • Metal utensils can cause arcing, which is a discharge of electric current. Arcing can damage your microwave oven. <p>Metal Decoration</p> <ul style="list-style-type: none"> • Do not use metal-trimmed or metal-banded dinnerware, casserole dishes, etc. <p>Centura™ Tableware</p> <ul style="list-style-type: none"> • The Corning Company recommends that you do not use Centura tableware and some Corelle™ closed-handle cups for microwave cooking. <p>Aluminum Foil</p> <ul style="list-style-type: none"> • Avoid large sheets of aluminum foil because they hinder cooking and may cause arcing. • Use small pieces of foil to shield poultry legs and wings. • Keep all aluminum foil at least 1 inch from the walls and door of the oven. <p>Wood</p> <ul style="list-style-type: none"> • Wooden bowls, boards, and baskets will dry out and may split or crack when you use them in the microwave oven. <p>Tightly Closed Containers</p> <ul style="list-style-type: none"> • Tightly closed cookware can explode. Be sure to leave an opening for steam to escape from covered cookware. <p>Brown Paper</p> <ul style="list-style-type: none"> • Avoid using brown paper bags. They absorb heat and could burn. <p>Metal Twist Ties</p> <ul style="list-style-type: none"> • Always remove metal twist ties as they can become hot and cause a fire.

UNDERSTANDING YOUR MICROWAVE OVEN

TIPS FOR MICROWAVE COOKING

BROWNING

Meat and poultry with high fat content that are cooked for 10 or 15 minutes or longer will brown lightly. Foods cooked a shorter time can be brushed with a browning agent, such as Worcestershire sauce, soy sauce, or barbecue sauce.

COVERING

A cover traps heat and steam and causes the food to cook more quickly. Use a lid or microwave-safe plastic wrap with one corner folded back to vent the excess steam. Lids on glass casseroles can become hot during cooking. Handle carefully. Waxed paper will prevent the food from splattering in the oven and help retain heat. When warming bread items, use waxed paper, napkins, or paper towels. To absorb extra moisture, wrap sandwiches and fatty foods in paper towels.

SPACING

Arrange individual foods, such as baked potatoes, cupcakes, and hors d'oeuvres in a circle and at least 1 inch apart. This will help the food cook more evenly.

STIRRING

Stirring blends flavors and redistributes the heat in foods. Always stir from the outside toward the center of the dish. Food at the outside of the dish heats first.

TURNING

Large foods, such as roasts and whole poultry, should be turned so that the top and bottom cook evenly. Also turn over chicken pieces and chops.

CLEANING

Wipe the oven inside and outside with a soft cloth and a mild detergent solution. Then rinse and wipe dry. This should be done weekly or more often, if needed. Never use cleaning powders or rough pads. Excessive oil splatters on the inside top will be difficult to remove if left for many days. Wipe splatters with a wet paper towel, especially after cooking chicken or bacon.

REMOVABLE PARTS

The turntable and turntable roller rest are removable. They should be hand-washed in warm (not hot) water with a mild detergent and a soft cloth. Once they are clean, rinse well and dry with a soft cloth. Never use cleaning powders, steel wool, or rough pads.

ARRANGEMENT

Do not stack food. Arrange in a single layer in the dish for more even cooking. Because dense foods cook more slowly, place thicker portions of meat, poultry, fish, and vegetables toward the outside of the dish.

TESTING FOR DONENESS

Because foods cook quickly in a microwave oven, you need to test frequently for doneness.

STANDING TIME

Depending on density, food often needs to stand from 2 to 15 minutes either in or outside of oven to finish cooking after cooking power shuts off. **Outside of oven**, you usually need to cover food during standing time to retain heat. Remove most foods when they are slightly undercooked and they will finish cooking during standing time. The internal temperature of food will rise about 10°F during standing time.

SHIELDING

To prevent some portions of rectangular or square dishes from overcooking, you may need to shield them with small strips of aluminum foil to block the microwaves. You can also cover poultry legs and wing tips with foil to keep them from overcooking. Always keep foil at least 1 inch from oven walls to prevent arcing.

PIERCING

Pierce the shell, skin, or membrane of foods before cooking to prevent them from bursting. Foods that require piercing include yolks and whites of eggs, hot dogs, clams, oysters, and whole vegetables, such as potatoes and squash.

- The glass turntable may be cleaned at the sink. Be careful not to chip or scratch the edges as this may cause the turntable to break during use.
- The turntable roller rest should be cleaned regularly.

SPECIALCARE

For best performance and safety, the inner door panel and the oven front frame should be free of food or grease buildup. Wipe often with a mild detergent; then rinse and wipe dry. Never use cleaning powders or rough pads.

After cleaning the control panel, touch STOP/CLEAR to clear any entries that might have been entered accidentally while cleaning the panel.

HOW TO USE TrueCookPlus™

HOW TO USE TrueCookPlus™

TrueCookPlus is a registered trademark of Microwave Science JV LLC. and used herein under license from Microwave Science JV LLC under US patents 5,812,393, 5,883, 801, 6,198,975, 6,249,710. Copyright 2008 Microwave Science JV LLC.

WHAT IS TrueCookPlus™ ?

TrueCookPlus™ is the first ever way to microwave cook your food to perfection. Every time, in any size or power microwave oven anywhere in the world.

EXAMPLE: USING TrueCookPlus™



STOP
CLEAR

1. Press the **STOP/CLEAR** Button.



2. Find the simple TrueCookPlus™ code on your favorite food package or at www.TrueCookPlus.com. On your food package, your TrueCookPlus™ code will look similar to this:



3. Press the **TrueCookPlus™** button on your microwave oven keypad.

4. You will hear a musical tone and your oven will ask you to enter your TrueCookPlus™ code.

1 2 3 4

5. Key in **1 2 3 4** (for example). The display shows :
⌈ 1 2 3 4 TOUCH START



START
ENTER

6. Press the **START / ENTER** button.
7. TrueCookPlus™ now manages your microwave cooking automatically -- adjusting power levels, cook times etc.
8. When TrueCookPlus™ is done, your oven will beep.
9. Your food will be cooked to perfection.

10. If you enter an invalid TrueCookPlus™ code, your oven will display 'CODE ERROR'

11. Your oven relies on you to enter the TrueCookPlus™ code exactly as it appears on the food package or at <http://www.TrueCookPlus.com>

If you make an error entering the simple numeric TrueCookPlus™, or enter a TrueCookPlus™ code other than the one specific to your food product, or fail to press the TrueCookPlus™ button before entering your TrueCookPlus™ code, your food may undercook, overcook or even burn.

HOW TO USE TrueCookPlus™

CUSTOMIZING TrueCookPlus™

You may find that you would prefer TrueCookPlus™ to cook your food more quickly or more slowly.

TrueCookPlus™ can adjust to your tastes—to cook your food more quickly or more slowly.

HERE'S HOW

STOP
CLEAR

1. Press the **STOP / CLEAR** button



2. Press the **TrueCookPlus™** button twice

3 4 5

3. If you want your food to cook more quickly when you enter a TrueCookPlus™ code, press a number between 3 and 5

1

4. If you want your food to cook more slowly when you enter a TrueCookPlus™ code, press 1.

2

5. If you wish to reset TrueCookPlus™ to its factory default, press 2

START
ENTER

6. Press the **START / ENTER** button

Note :

1 : Shorter (6%)

2 : Normal (Default)

3 or 4, 5 : Longer (3%, 6%, 9%)

TrueCookPlus™ SETUP

After you unpack and plug in your TrueCookPlus™ oven, take a few moments to tell TrueCookPlus™ your zip code.

Example : Setup your ZIP code

STOP
CLEAR

1. Press the **STOP / CLEAR** button



2. Press the **TrueCookPlus™** button three times

3. Enter your five digit U.S. Post Office zip code.

START
ENTER

4. Press the **START / ENTER** button





Once TrueCookPlus™ knows your zip code, every time you enter a TrueCookPlus™ code, TrueCookPlus™ will automatically adjust for your elevation above sea level.

TrueCookPlus™ is a registered trademark of Microwave Science JV LLC; and used herein under license from Microwave Science JV LLC under US patents 5,812,393, 5,883,801, 6,198,975, 6,249,710. Copyright 2008 Microwave Science JV LLC.

USING YOUR MICROWAVE OVEN

CLOCK

Example: To set the clock for 10:30(AM).

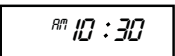

Touch:	Display Shows:
1. 	
2. CLOCK	:ENTER TIME OF DAY
3. 1030	10 : 30 TOUCH START
4. 	10 : 30 AM TOUCH 1 PM TOUCH 2
5. 1	AM 10 : 30 TOUCH START
6. 	

NOTE: This is a 12 hour clock. You can switch between AM and PM by touching 1 or 2 after step 4.

CHILD LOCK

You can use this safety feature to lock the control panel so that children cannot use the oven when you do not want them to and when you are cleaning the oven.

To set CHILD LOCK:

Touch:	Display Shows:
1. 	Time of day.
2. 	Touch and hold until LOCKED appears in the display. (approximately 4 seconds)

To cancel CHILD LOCK:

Touch:	Display Shows:
1. 	Time of day.
	Touch and hold until LOCKED from the the display. (approximately 4 seconds)

KITCHEN TIMER

Your microwave oven can be used as a kitchen timer. You can set up to 99 minutes, 99 seconds.



Example: To set 3 minutes.

Touch:	Display Shows:
1. KITCHEN TIMER	:ENTER TIME IN MIN AND SEC
2. 300	3 : 00 TOUCH START
3. 	3 : 00 TIMER Time counting down.

EZ-ON

A time-saving pad, this simplified control lets you quickly set and start microwave cooking without the need to touch START.

Example : To set Ez-ON cooking 2 minutes.

Touch:	Display Shows:
	Time of day.
 4 times	The oven begins cooking and display shows time counting down.

NOTE:

If you touch EZ-ON, it will add 30 seconds up to 3 minutes 30 seconds; after 3 minutes 30 seconds, every touch will add 1 minute up to 99 min 59 seconds.

USING YOUR MICROWAVE OVEN

SENSOR TOUCH OPERATION INSTRUCTION

Quick Sensor Touch cooking provides exciting new features to make microwave oven easier. Your new microwave oven will guide you, step by step, whether it be simply to reheat food or cook food and sensor menu with all the popular food choices helps you to cook perfectly because it has been pre-programmed and can tell how long to cook or reheat food items.

Categories :

1. Sensor Touch Reheat
 2. Sensor Touch Potato
 3. Sensor Touch Rice
 4. Sensor Touch Popcorn
 5. Sensor Touch Fresh Vegetable
 6. Sensor Touch Frozen Vegetable
 7. Sensor Touch Frozen Entree
1. The Sensor Touch system works by detecting a build-up of vapor.
 2. Make sure the door remains closed.
 3. Opening the door or touching the STOP/CLEAR pad before the vapor is detected will abort the process. The oven will stop.
 4. Before using Sensor Touch, make sure the exterior of the reheating container and the interior of the oven are dry, to assure the best results.

POTATO (EXAMPLE)

SENSOR COOK allows you to cook most of your favorite foods without having to select cooking times and power levels. This oven automatically determines required cooking times for each food item.

Example: To cook potato

Touch: **Display Shows:**

1.  Time of day.

2. **POTATO** *POTATO*

The oven will start automatically.

QUICK SENSOR TOUCH TABLE

CATEGORY	DIRECTION	AMOUNT
Potato	Pierce each potato with a fork and place on the oven tray around the edge, at least one inch apart.	1~4 medium approx. 10 oz. each
Rice	Place rice and twice as much liquid (water or chicken or vegetable stock) in a 2-quart microwavable dish. Cover with plastic wrap. When cooking is complete, allow 10 minutes standing time. Stir for fluffier rice.	1~2 cups Use medium or long grain rice. Cook instant rice according to directions on the package.
Popcorn	Place only bag of prepackaged microwave popcorn on the center of turntable.	Regular size Use one fresh bag of popcorn
Fresh Vegetable	Prepare as desired, wash, and leave residual water on the vegetables. Place in an appropriately-sized microwave container, cover with plastic wrap and vent.	1~4 cups
Frozen Vegetable	Remove from package, rinse off frost under running water. Place in an appropriately-sized microwave container, cover with plastic wrap and vent.	1~4 cups
Frozen Entree	Remove from outer display package. Slit cover. If not in microwave-safe container, place on plate, cover with plastic wrap, and vent.	10~21 oz.

NOTE: If you open the door or press STOP during sensing, the process will be canceled.

USING YOUR MICROWAVE OVEN

SENSOR TOUCH REHEAT

The feature reheats single servings of previously cooked foods or a plate of leftovers.

Food item in the Sensor Touch

Reheat menu include:

1. DINNER PLATE
2. SOUP/SAUCE
3. CASSEROLE
4. PIZZA

SENSOR TOUCH REHEAT TABLE

CATEGORY	DIRECTION	AMOUNT
Dinner plate	Place foods to be heated on a dinner plate or similar dish. Cover with plastic wrap.	Approx. 10.3 - 15.5 oz.
Soup/sauce	Place foods to be heated in an appropriately sized microwave container. Cover with plastic wrap.	1-4 cups
Casserole	Cover dish containing the casserole with plastic wrap.	1-4 cups
Pizza	Place foods to be heated on a dish.	1-3 slices

SENSOR TOUCH POPCORN

This feature makes preparation of microwave popcorn simple and quick... **one bag at a time.**

The automatic popcorn uses the HI power only.

The popping time counts down in the display.

When the popping time is over, two short and one long tones sound and End shows. Oven shuts off automatically.

Example: To reheat CASSEROLE simply follow the steps below.

Touch:

Display Shows:



Time of day.

REHEAT

*SELECT MENU 1 TO 4
-- SEE COOKING GUIDE*

3

CASSEROLE

The oven will start automatically

Place one bag only(50-100g) of prepackaged microwave popcorn on a microwave-safe / oven-safe dish on the turntable,The package should be at room temperature.

Touch:

Display Shows:



Time of day.

POPCORN

POPCORN

The oven will start automatically.

USING YOUR MICROWAVE OVEN

NOTE :

- If popcorn bag size is not known, follow manufacturers' instructions and do not use this feature.
- Do not use POPCORN key pad in combination with any other feature key pads.
- Do not attempt to reheat or cook any unpopped kernels.
- Do not reuse bag. Overcooking can result in an oven fire.
- Prepare one bag only at a time.
- Do not use popcorn popping devices in microwave oven with this feature.
- Do not leave microwave unattended while cooking popcorn.

CAUTION : Never use a brown paper bag for popping corn.



When popping prepackaged popcorn; Place carefully so the bag does not touch the oven walls. Fold each end of the bag in half toward the center top of the bag.

CUSTOM SET

CUSTOM SET provides four modes which make using your microwave oven quite handy. you can select SOUND ON/OFF, CLOCK ON/OFF, SCROLL SPEED and LBS/KG.

Example: To turn off Sound of beeper

Touch:

Display Shows:

1.

STOP
CLEAR

Time of day.

2.

CUSTOM
SET

Four modes show in the display.

3. 1

SOUND ON TOUCH 1
OFF TOUCH 2

4. 2

SOUND OFF
Time of day.

NOTE: To turn beep sound back on, repeat steps 1~3 then touch number 1.

CUSTOM SET FUNCTION CHART

NO.	FUNCTION	CHOICE
1	SOUND ON/OFF	Sound On or Sound Off
2	CLOCK ON/OFF	Clock On or Clock Off
3	SCROLL SPEED	Slow, Normal, or Fast
4	LBS/KG CHOICE	Lbs or Kg

NOTE: When the power cord is first plugged in, the default setting are Sound ON, Clock On, Normal Speed and LBS.

USING YOUR MICROWAVE OVEN

AUTO COOK

Auto Cook made easy! Your oven's menu has been preprogrammed to automatically cook food. Tell the oven what you want and how many items there are. Then let your microwave oven cook your selections.

Food items in the AUTO COOK menu include:

1. Bacon
2. Frozen Roll/Muffin
3. Fresh Roll/Muffin
4. Beverage
5. Chicken Pieces
6. Hot Cereal

AUTO COOK TABLE

CODE	CATEGORY	DIRECTION	AMOUNT
1	Bacon	Place bacon strips on microwave bacon rack for best results.(Use dinner plate lined with paper towels if rack is not available).	1 to 5 slices
2	Frozen Roll/Muffin	Remove from display package and place on plate.(If muffins are over 3 oz. each, count as two when entering quantity.)	1 to 6 pieces (2~3 oz. each)
3	Fresh Roll/Muffin	Remove from display package and place on plate.(If muffins are over 3 oz. each, count as two when entering quantity.)	1 to 6 pieces (2~3 oz. each)
4	Beverage	Remove from display package and place on plate.(Be careful! The beverage will be very hot! Sometimes liquids heated in cylindrical containers will splash out when the cup is moved.)	1 to 2 cups
5	Chicken Pieces	Place the chicken pieces in an appropriately sized microwaveable container ,cover with plastic wrap, and vent.	0.5 to 2 lbs.
6	Hot Cereal	Prepare as directed on package and cook. Stir and allow standing time before eating.Use only instant hot cereal.	1 to 6 servings

EXAMPLE: To cook 4 slices of bacon, simply follow the steps below.

- | Touch: | Display Shows: |
|--|---|
| 1.  | <i>SELECT MENU 1 TO 6</i> |
| 2. 1 | <i>BACON
TOUCH 1 TO 5</i> |
| 3. 3 | <i>4 SLICES TOUCH START</i>
Time counting down and
<i>BACON</i> |

MORE/LESS

By using the MORE or LESS key, TIMED COOK program can be adjusted to cook food for a longer or shorter time. Pressing MORE will add 10 seconds to the cooking time each time you press it. Pressing LESS will subtract 10 seconds of cooking time each time you press it.

To adjust the cooking time for a longer time, or for a shorter time.

- | Touch: | Display Shows: |
|---|---|
|  | Time of day. |
| 100 | <i>1:00
TOUCH START OR POWER</i> |
|  | The oven begins cooking and display shows time counting down. |
|  | The remaining time will increase or decrease by 10 seconds. |
|  | |

USING YOUR MICROWAVE OVEN

AUTO DEFROST

Three defrost sequences are preset in the oven. The auto defrost feature provides you with the best defrosting method for frozen foods. The cooking guide will show you which defrost sequence is recommended for the food you are defrosting.

For added convenience, the Auto Defrost includes a built-in beep mechanism that reminds you to check, turn over, separate, or rearrange to get best defrost results. Three different defrosting levels are provided.



- 1 MEAT
- 2 POULTRY
- 3 FISH

*Available weight is 0.1~6.0 lbs.

Example: To defrost 1.2 lbs of ground beef.

Touch:

Display Shows:

1.  *MEAT TOUCH 1
POULTRY TOUCH 2
FISH TOUCH 3*
2. **1** *MEAT ENTER WEIGHT*
3. **1** and **2**
to enter the weight *1.2^{Lbs}
TOUCH START*
4.  Time counting down and *DEFROST* will appear on display.

Note: *TURN FOOD OVER* will appear on display in middle of cycle.

NOTE:

When you touch the START pad, the display changes to defrost time count down. The oven will beep during the DEFROST cycle. At this time, open the door and turn, separate, or rearrange the food. Remove any portions that have thawed. Return frozen portions to the oven and touch START to resume the defrost cycle.

OPERATING TIPS:

- For best results, remove fish, shellfish, meat, and poultry from its original closed paper or plastic package (wrapper). Otherwise, the wrap will hold steam and juice close to the foods, which can cause the outer surface of the foods to cook.
- For best results, shape your ground meat into the form of a doughnut before freezing. When defrosting, scrape off thawed meat when the beep sounds and continue defrosting.
- Place foods in a shallow container or on a microwave roasting rack to catch drippings.
- Food should still be somewhat icy in the center when removed from the oven.

USING YOUR MICROWAVE OVEN

AUTO DEFROST TABLE

Category	Food to be Defrosted
1 MEAT	Beef Ground beef, Round steak, Cubes for stew, Tenderloin steak, Pot roast, Rib roast, Rump roast, Chuck roast, Hamburger patty
	Lamb Chops (1 inch thick), Rolled roast Pork Chops (1/2 inch thick), Hot dogs, Spareribs, Country-style ribs. Rolled roast, Sausage
2 POULTRY	Veal Cutlets (1 lb., 1/2 inch thick)
	Poultry Whole (under 4 lbs.), Cut-up, Breasts (boneless) Cornish Hens Whole Turkey Breast
3 FISH	Steaks/Chops Round beef steak, Tenderloin steak Lamb chops (1 inch thick) Pork chops (1/2 inch thick) Veal cutlets (1 lbs, 1/2 inch thick)
	Fish Filletts, Whole Steaks Shellfish Crab meat, Lobster tails, Shrimp, Scallops

EXPRESS DEFROST

This feature should be used only when you defrost 1 pound of frozen ground beef.

Example: To defrost 1 lb Ground beef.

Touch: **Display Shows:**

- STOP CLEAR** Time of day.
- EXPRESS DEFROST** Time counting down and **DEFROST** will appear on display.

Note: **TURN FOOD OVER** will appear on display in middle of cycle.

MULTI-STAGE COOKING

For best results, some recipes call for different cook powers during different stages of a cook cycle. You can program your oven to switch from one power level to another for up to 2 stages.

Example: To set a 2-stage cook cycle.

- Touch:** **Display Shows:**
- TIME COOK** : ENTER COOKING TIME
3 : 00
 - 3 0 0** TOUCH START OR POWER LEVEL
to set a 3 minute cook time for first stage.
 - POWER LEVEL** ENTER POWER LEVEL 0 TO 10
3 : 00
 - 8** to set an 80% cook power for the first stage. **POWER 80 TOUCH START**
3 : 00
 - TIME COOK** : ENTER COOKING TIME
 - 7 0 0** TOUCH START OR POWER LEVEL
to set a 7 minute cook time for second stage.
 - POWER LEVEL** ENTER POWER LEVEL 0 TO 10
7 : 00
 - 5** to set an 50% cook power for the second stage. **POWER 50 TOUCH START**
7 : 00
 - START ENTER** Time counting down and **POWER 80** will appear on display.
 - When the first stage is over, you will hear two short tones as the oven begins the second cook stage.

USING YOUR MICROWAVE OVEN

SOFTEN

The oven uses low power to soften foods (butter, ice cream, cream cheese, and frozen juice) See the following table.

Example: To Soften Quart Ice Cream.

Touch: **Display Shows:**

1.  Time of day.
2. **SOFTEN** *SELECT MENU 1 TO 4*
3. **2** *ICE CREAM TOUCH 1 TO 3*
4. **2** Touch number 2, then time counting down and *ICE CREAM* will appear on display.

MELT

The oven uses low power to melt foods (butter, margarine, chocolate, cheese and marshmallows). See the following table.

Example: To Melt 8 oz. Chocolate.

Touch: **Display Shows:**

1.  Time of day.
2. **MELT** *SELECT MENU 1 TO 4*
3. **2** *CHOCOLATE TOUCH 1 TO 2*
4. **2** Touch number 2, then time counting down and *CHOCOLATE* will appear on display.

SOFTEN TABLE

Code	Category	Direction	Amount
1	Butter	Unwrap and place in microwavable container. No need to cover butter. Butter will be at room temperature and ready for use in recipe.	1, 2 or 3 sticks
2	Ice Cream	Place container in oven. Ice cream will be soft enough to make scooping easier.	Pint, Quart, Half gallon
3	Cream Cheese	Unwrap and place in microwavable container. Cream cheese will be at room temperature and ready for use in recipe.	3 or 8 oz.
4	Frozen Juice	Remove top. Place in oven. Frozen juice will be soft enough to easily mix with water.	6, 12 or 16 oz.

MELT TABLE

Code	Category	Direction	Amount
1	Butter/ Margarine	Unwrap and place in microwavable container. No need to cover butter. Stir at the end of cooking to complete melting.	1, 2 or 3 sticks
2	Chocolate	Choose the 4 or 8 oz. (actual weight) selection to melt squares of baking chocolate. Unwrap squares and place them in a microwavable container. Stir at the end of cycle to complete melting. If using chocolate morsels always use the 4 oz. setting. Stir at the end of the cycle to complete melting. Add time as necessary if more than 4 oz. dry measure is being melted.	4 or 8 oz.
3	Cheese	Use processed cheese food only. Cut into cubes. Place in a single layer in microwavable container. Stir at the end of cooking to complete melting.	8 or 16 oz.
4	Marshmallows	Large or miniature marshmallows may be used. Place in microwavable container. Stir at the end of cycle to complete melting.	5 or 10 oz.

USING YOUR MICROWAVE OVEN

TIME COOK

This feature lets you program a specific cook time and power. For best results, there are 10 power level settings in addition to HIGH power (100%). Refer to the "Microwave Power Level Table" for more information.

NOTE: If you do not select a power level, the oven will automatically cook at HIGH (100%) power.

Example: To cook for 5 minutes, 30 seconds at 80% power.

- | Touch: | Display Shows: |
|--|--|
| 1. TIME COOK | : ENTER COOKING TIME |
| 2. 5 3 0 | <i>5 : 30</i>
TOUCH START OR POWER LEVEL |
| 3. POWER LEVEL | <i>5 : 30</i>
ENTER POWER LEVEL 0 TO 10 |
| 4. 8 | <i>5 : 30</i>
POWER 80 TOUCH START |
| 5. START
ENTER | Time counting down and <i>POWER 80</i> will appear on display. |

MICROWAVE POWER LEVELS

Your microwave oven has 10 cook power levels to let you cook or heat a wide variety of foods. Refer to the table below for suggestions:

Microwave Power Level Table

Power Level	Use
10 (High)	<ul style="list-style-type: none"> Boiling water. Making candy. Cooking poultry pieces, fish, & vegetables. Cooking tender cuts of meat. Whole poultry.
9	<ul style="list-style-type: none"> Reheating rice, pasta, & vegetables.
8	<ul style="list-style-type: none"> Reheating prepared foods quickly. Reheating sandwiches.
7	<ul style="list-style-type: none"> Cooking egg, milk, & cheese dishes. Cooking cakes, breads. Melting chocolate.
6	<ul style="list-style-type: none"> Cooking veal. Cooking whole fish. Cooking puddings & custard.
5	<ul style="list-style-type: none"> Cooking ham, whole poultry, & lamb. Cooking rib roast, sirloin tip.
4	<ul style="list-style-type: none"> Thawing meat, poultry, & seafood.
3	<ul style="list-style-type: none"> Cooking less tender cuts of meat. Cooking pork chops, roast.
2	<ul style="list-style-type: none"> Taking chill out of fruit. Softening butter.
1	<ul style="list-style-type: none"> Keeping casseroles & main dishes warm. Softening butter & cream cheese.
0	<ul style="list-style-type: none"> Standing time.

USING YOUR MICROWAVE OVEN

⚠ WARNING: Do not use aluminum foil during cooking cycle.

COOKING TIPS

Meat

1. No special techniques are required. Meat should be prepared as with conventional cooking. Season if desired. Always thoroughly defrost meat before cooking.
2. Place the meat on a microwave roasting rack or microwave-proof plate and place on the turntable.
3. Cook according to the Meat Cooking Table (below). Use the longer time for large cuts of meats and the shorter time for small cuts of meats. For thicker chops, use the longer time.
4. Turn the meat once halfway through the cooking time.
5. Let stand for 5-10 minutes in oven after cooking. The standing time is very important as it completes the cooking process.
6. Make sure meat, especially pork, is thoroughly cooked before eating.

Poultry

1. No special techniques are required. Poultry should be prepared as with conventional cooking. Season if desired.
2. Poultry should be thoroughly defrosted. Remove giblets and any metal clamps.
3. Prick the skin and brush lightly with vegetable oil unless the poultry is self-basting.
4. All poultry should be placed on a microwave roasting rack or a microwave-proof plate and placed on the turntable.
5. Cook according to the instructions in the Poultry Cooking Table below. Turn over halfway through the cooking time. Because of its shape, poultry has a tendency to cook unevenly, especially in very bony parts. Turning during roasting helps to cook these areas evenly.
6. Let stand for 5-10 minutes in oven after cooking before carving. The standing time is very important, as it completes the cooking process.
7. Make sure poultry is thoroughly cooked before eating. Whole poultry is completely cooked when the juices run clear from the inside thigh when it is pierced with a sharp knife. Poultry pieces should be pierced with a sharp knife through the thickest part to ensure that the juices are clear and the flesh is firm.

Meat Cooking Table

Meat	Microwave Power	Cooking Time Per Pound
BEEF		
Standing/Rolled Rib		
- Medium	8	9 1/2 to 11 1/2 minutes
- Well-done	8	11 1/2 to 14 minutes
Ground Beef (to brown for casserole)	HIGH(100%)	6 1/2 to 9 1/2 minutes
Hamburgers, Fresh or defrosted (4 oz. each)		
- 2 patties	HIGH(100%)	2 1/2 to 4 1/2 minutes
- 4 patties	HIGH(100%)	3 1/2 to 5 1/2 minutes
PORK		
Loin, Leg	8	12 1/2 to 16 1/2 minutes
Bacon		
- 4 slices	HIGH(100%)	2 1/2 to 3 1/2 minutes
- 6 slices	HIGH(100%)	3 1/2 to 4 1/2 minutes

NOTE: The times listed above are only a guide. Allow for difference in individual tastes and preferences. The times may also vary due to the shape, cut, and composition of the food.

Poultry Cooking Table

Poultry	Microwave Power	Cooking Time Per Pound
CHICKEN		
Whole	8	11 to 15 minutes
Breast (boned)	8	10 to 14 minutes
Portions	8	11 to 17 minutes
TURKEY		
Whole	8	11 to 15 minutes

NOTES:

- The times listed above are only a guide. Allow for difference in individual tastes and preferences. The times may also vary due to the shape, cut, and composition of the food.
- If whole poultry is stuffed, the weight of the stuffed bird should be used when calculating the cooking time.

USING YOUR MICROWAVE OVEN

COOKING TIPS (continued)

Fish

1. Arrange fish in a large shallow non-metallic dish or casserole.
2. Cover with pierced microwave plastic wrap or casserole lid.
3. Place the dish on the turntable.
4. Cook according to the instructions in the Fresh Fish Cooking Table below. Flakes of butter can be added to the fish if desired.
5. Let stand as directed in the Cooking Table before serving.
6. After standing time, check to see that the fish is thoroughly cooked. The fish should be opaque and flake easily.

Fresh Fish Cooking Table

Fish	Microwave Power	Cooking Time Per Pound	Butter	Standing Time
Fish Fillets	HIGH	4½ to 8 minutes	Add 15 to 30 ml (1 to 2 tbsp lemon juice)	2 to 3 minutes
Whole Mackerel, Cleaned and Prepared	HIGH	4½ to 8 minutes	–	3 to 4 minutes
Whole Trout, Cleaned and Prepared	HIGH	5½ to 9 minutes	–	3 to 4 minutes
Salmon Steaks	HIGH	5½ to 8 minutes	Add 15 to 30 ml (1 to 2 tbsp lemon juice)	3 to 4 minutes

TROUBLESHOOTING

QUESTIONS AND ANSWERS

Operation

Question	Answer
Why is the oven light not on during cooking?	There may be several reasons why the oven light is not on. Have you: <ul style="list-style-type: none"> • Set a cooking time? • Touched START?
Why does steam come out of the air exhaust vent?	Steam is normally produced during cooking. The microwave oven has been designed to vent this steam.
Will the microwave oven be damaged if it operates empty?	Yes. Never operate the oven empty or without the glass turntable.
Does microwave energy pass through the viewing screen in the door?	No. The metal screen bounces the energy back to the oven cavity. The holes (or ports) allow only light to pass through. They do not let microwave energy pass through.
Why does a tone sound when a pad on the control panel is touched?	The tone tells you that the setting has been entered.
Can my microwave oven be damaged if food is cooked for too long?	Like any other cooking appliance, it is possible to overcook food to the point that the food creates smoke and even possibly fire, and damage to the inside of the oven. It is always best to be near the oven while you are cooking.
When the oven is plugged into the wall outlet for the first time, and it does not work properly. What is wrong?	The microcomputer controlling your oven may temporarily become scrambled and fail to function as programmed when you plug in for the first time or when power resumes after a power interruption. Unplug the oven from the 120 volt household outlet and then plug it back in to reset the microcomputer.
Why do I see light reflection around the outer case?	This light is from the oven light which is located between the oven cavity and the outer wall of the oven.
What are the various sounds I hear when the microwave oven is operating?	The clicking sound is caused by a mechanical switch turning the microwave oven's magnetron ON and OFF. The heavy hum and clunk is from the change in power the magnetron draws as it is turned ON and OFF by a mechanical switch. The change in blower speed is from the change in line voltage caused by the magnetron being turned ON and OFF.

TROUBLESHOOTING

QUESTIONS AND ANSWERS (continued)

Food

Question	Answer
What is wrong when baked foods have a hard, dry, brown spot?	A hard, dry, brown spot indicates overcooking. Shorten the cooking or reheating time.
Why do eggs sometimes pop?	When baking, frying, or poaching eggs, the yolk may pop due to steam build-up inside the yolk membrane. To prevent this, simply pierce the yolk with a wooden toothpick before cooking. CAUTION: Never microwave eggs in the shell.
Why are scrambled eggs sometimes a little dry after cooking?	Eggs will dry out when they are overcooked, even if the same recipe is used each time. The cooking time may need to be varied for one of these reasons: <ul style="list-style-type: none"> • Eggs vary in size. • Eggs are at room temperature one time and at refrigerator temperature another time. • Eggs continue cooking during standing time.
Is it possible to pop popcorn in a microwave oven?	Yes, if using one of the two methods described below: (1) microwave-popping devices designed specifically for microwave cooking (2) prepackaged commercial microwave popcorn that is made for specific times and power output needed Follow exact directions given by each manufacturer for its popcorn popping product and do not leave the oven unattended while the corn is being popped. If corn fails to pop after the suggested time, discontinue cooking. Overcooking could result in an oven fire. CAUTION: <ul style="list-style-type: none"> • Never use a brown paper bag for popping corn or attempt to pop leftover kernels.
Why do baked apples sometimes burst during cooking?	The peel has not been removed from the top half of each apple to allow for expansion of the interior of the apple during cooking. As in conventional cooking methods, the interior of the apple expands during the cooking process.
Why do baked potatoes sometimes burn during cooking?	If the cooking time is too long, fire could result. At the end of the recommended cooking time, potatoes should be slightly firm. CAUTION: Do not overcook.
Why is a standing time recommended after microwave cooking time is over?	Standing time allows foods to continue cooking evenly for a few minutes after the actual microwave oven cooking cycle. The amount of standing time depends upon the density of the foods.
Why is additional time required for cooking food stored in the refrigerator?	As in conventional cooking, the initial temperature of food affects total cooking time. You need more time to cook food taken out of a refrigerator than for food at room temperature.

TROUBLESHOOTING

BEFORE CALLING FOR SERVICE

You can often correct operating problems yourself. If your microwave oven fails to work properly, locate the operating problem in the list below and try the solutions listed for each problem.

If the microwave oven still does not work properly, contact the nearest LG Authorized Service Center. LG Authorized Service Centers are fully equipped to handle your service requirements.

Problem	Possible Causes
Oven does not start	<ul style="list-style-type: none"> • Is the power cord plugged in? • Is the door closed? • Is the cooking time set?
Arcing or Sparking	<ul style="list-style-type: none"> • Are you using approved cookware? • Is the oven empty?
Incorrect time of day	<ul style="list-style-type: none"> • Have you tried to reset the time of day?
Unevenly Cooked Foods	<ul style="list-style-type: none"> • Are you using approved cookware? • Is the glass turntable in the oven? • Did you turn or stir the food while it was cooking? • Were the foods completely defrosted? • Was the time/cooking power level correct?
Overcooked Foods	<ul style="list-style-type: none"> • Was the time/cooking power level correct?
Undercooked Foods	<ul style="list-style-type: none"> • Are you using approved cookware? • Were the foods completely defrosted? • Was the time/cooking power level correct? • Are the ventilation ports clear?
Improper Defrosting	<ul style="list-style-type: none"> • Are you using approved cookware? • Was the time/cooking power level correct? • Did you turn or stir the food during the defrosting cycle?

FEDERAL COMMUNICATIONS COMMISSION RADIO FREQUENCY INTERFERENCE STATEMENT

WARNING:

This equipment generates and uses ISM frequency energy and if not installed and used properly, that is in strict accordance with the manufacturer's instructions, may cause interference to radio and television reception. It has been type tested and found to comply with limits for ISM Equipment pursuant to part 18 of FCC Rules, which are designed to provide reasonable protection against such interference in a residential installation.

However, there is no guarantee that interference will not occur in a particular installation. If this equipment does cause interference to radio or television reception, which can be determined by turning the equipment off and on, the user is encouraged to try to correct the interference by one or more of the following:

- Reorient the receiving antenna of the radio or television.
- Relocate the microwave oven with respect to the receiver.
- Move the microwave oven away from the receiver.
- Plug the microwave oven into a different outlet so that the microwave oven and the receiver are on different branch circuits.

The manufacturer is not responsible for any radio or TV interference caused by **unauthorized modification** to this microwave oven. It is the responsibility of the user to correct such interference.



LG MICROWAVE OVEN LIMITED WARRANTY – USA

Model LCRT2010ST

LG Electronics, Inc. will repair or replace your product, at LG's option, if it proves to be defective in material or workmanship under normal use, during the warranty period set forth below, effective from the date of original consumer purchase of the product. This warranty is good only to the original purchaser of the product and effective only when used in the United States, including U.S. Territories.

<p>WARRANTY PERIOD:</p> <p>LABOR: One Year from the Date of Purchase*.</p> <p>PARTS (except as listed below): One Year from the Date of Purchase*.</p> <p>MAGNETRON: Ten Years from the Date of Purchase*.</p> <p>Replacement Units and Repair Parts are warranted for the remaining portion of the original unit's warranty period.</p> <p>* Retain your Sales Receipt to prove the date of purchase. A copy of your Sales Receipt must be submitted at the time warranty service is provided.</p>	<p>HOW SERVICE IS HANDLED:</p> <p>Please call 1-800-243-0000 and choose the appropriate option. (Phones are answered 24 hours a day, 365 days per year.) Please have the product type (Microwave) and your ZIP code ready.</p> <p>Or visit our website at: www.lg.com</p>
--	---

THIS WARRANTY IS IN LIEU OF ANY OTHER WARRANTY, EXPRESS OR IMPLIED, INCLUDING WITHOUT LIMITATION, ANY WARRANTY OF MERCHANTABILITY OR FITNESS FOR A PARTICULAR PURPOSE. TO THE EXTENT ANY IMPLIED WARRANTY IS REQUIRED BY LAW, IT IS LIMITED IN DURATION TO THE EXPRESS WARRANTY PERIOD ABOVE. LG WILL NOT BE LIABLE FOR ANY INCIDENTAL, CONSEQUENTIAL, INDIRECT, SPECIAL, OR PUNITIVE DAMAGES OF ANY NATURE, INCLUDING WITHOUT LIMITATION, LOST REVENUES OR PROFITS, OR ANY OTHER DAMAGE WHETHER BASED IN CONTRACT, TORT, OR OTHERWISE. Some states do not allow the exclusion or limitation of incidental or consequential damages or limitations on how long an implied warranty lasts, so the above exclusion or limitation may not apply to you. This warranty gives you specific legal rights and you may also have other rights that vary from state to state.

THIS LIMITED WARRANTY DOES NOT APPLY TO:

- Service trips to your home to deliver, pick up, and/or install the product, instruct, or replace house fuses or correct wiring, or correction of unauthorized repairs.
- Damages or operating problems that result from misuse, abuse, operation outside environmental specifications or contrary to the requirements of precautions in the Operating Guide, accident, vermin, fire, flood, improper installation, acts of God, unauthorized modification or alteration, incorrect electrical current or voltage, or commercial use, or use for other than intended purpose.

The cost of repair or replacement under these excluded circumstances shall be borne by the consumer.

CUSTOMER INTERACTIVE CENTER NUMBERS

<p>To obtain Customer Assistance, Product Information, or Dealer or Authorized Service Center location:</p>	<p>Call 1-800-243-0000 (24 hours a day, 365 days per year) and select the appropriate option from the menu.</p> <p>Or visit our website at: www.lg.com</p>
--	--

TO CONTACT LG ELECTRONICS BY MAIL:

LG Customer Interactive Center
P. O. Box 240007
201 James Record Road
Huntsville, Alabama 35824
ATTN: CIC



Free Manuals Download Website

<http://myh66.com>

<http://usermanuals.us>

<http://www.somanuals.com>

<http://www.4manuals.cc>

<http://www.manual-lib.com>

<http://www.404manual.com>

<http://www.luxmanual.com>

<http://aubethermostatmanual.com>

Golf course search by state

<http://golfingnear.com>

Email search by domain

<http://emailbydomain.com>

Auto manuals search

<http://auto.somanuals.com>

TV manuals search

<http://tv.somanuals.com>