



website:<http://us.lgservice.com>



MICROWAVE OVEN

OWNER'S MANUAL & COOKING GUIDE

PLEASE READ THIS OWNER'S MANUAL THOROUGHLY BEFORE OPERATING.

LMB0960ST

TABLE OF CONTENTS

SAFETY	3-5
Precautions to Avoid Possible Exposure to Excessive Microwave Energy.....	3
Grounding Instructions.....	3
Important Safety Instructions	4-5
UNDERSTANDING YOUR MICROWAVE OVEN	6-11
Specifications.....	6
Installation.....	6
Parts and Accessories.....	7
Control Panel	8
Cooking Comparison Guide	9
Tips for Microwave Cooking	10
Precautions.....	11
Cleaning.....	11
USING YOUR MICROWAVE OVEN	12-22
Clock	12
Ez On	12
Timer	12
Custom Set	13
Auto Touch-Popcorn	14
Auto Touch-Reheat	14
Auto Touch-Cook	15
Convection	15-16
Combi. Cooking	17
Auto defrost	18
Broil Cooking	19
Speed Auto Cook-Broil	19
Speed Auto Cook-Bake	20
Speed Auto Cook-Roast	21
Microwave Power Levels	22
HEATING/REHEATING GUIDE	23
FRESH VEGETABLE GUIDE	24
TROUBLESHOOTING	25-27
Questions and Answers.....	25-26
Before Calling for Service.....	27
WARNING	27
WARRANTY	28

Thank you for purchasing a LG microwave oven.

Please record the model number and serial number of this unit for future reference. We also suggest you record the details of your contact with LG (LG Electronics U.S.A., Inc.) concerning this unit.

Model No: _____

Serial No: _____

Dealer: _____

Dealer Phone No: _____

Staple your receipt here for proof of purchase.

Customer Relations
 LG Electronics U.S.A., Inc.
 Service Division Bldg. #3
 201 James Record Rd.
 Huntsville, AL 35824-0126

SAFETY

PRECAUTIONS TO AVOID POSSIBLE EXPOSURE TO EXCESSIVE MICROWAVE ENERGY

- **Do not attempt to operate this oven with the door open**, since open-door operation can result in harmful exposure to microwave energy. It is important not to defeat or tamper with the safety interlocks.
- **Do not place any object between the oven front face and the door**, or allow soil or cleaner residue to accumulate on sealing surfaces.
- **Do not operate the oven if it is damaged.** It is particularly important that the oven door closes properly and that there is no damage to the:
 - door (bent),
 - hinges and latches (broken or loosened),
 - door seals and sealing surfaces.
- **The oven should not be adjusted or repaired** by anyone except properly qualified service personnel.

GROUNDING INSTRUCTIONS

This appliance must be grounded. In the event of an electrical short circuit, grounding reduces the risk of electric shock by providing an escape wire for the electric current. This appliance is equipped with a cord having a grounding wire and a grounding plug. The plug must be plugged into an outlet that is properly installed and grounded.

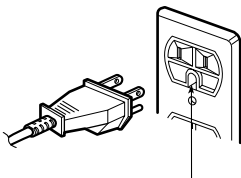

Ensure proper ground exists before use

⚠ WARNING ⚠

Improper grounding can result in a risk of electric shock. Consult a qualified electrician if the grounding instructions are not completely understood, or if doubt exists as to whether the appliance is properly grounded, and either:

1. If it is necessary to use an extension cord, use only a 3-wire extension cord that has a 3-blade grounding plug and a 3-slot receptacle that will accept the plug on the appliance.

The marked rating of the extension cord shall be equal to or greater than the electrical rating of the appliance

2. Do not use an extension cord. If the power supply cord is too short, have a qualified electrician or serviceman install an outlet near the appliance.

NOTES:

1. A short power-supply cord is provided to reduce the risks resulting from becoming entangled in or tripping over a longer cord.
2. Longer cord sets or extension cords are available and may be used if care is exercised in their use.
3. If a long cord or extension cord is used, (1) the marked electrical rating of the cord set or extension cord should be at least as great as the electrical rating of the appliance, (2) the extension cord must be a grounding-type 3-wire cord, and (3) the longer cord should be arranged so that it will not drape over the countertop or tabletop where it can be pulled on by children or tripped over accidentally.

SAFETY

IMPORTANT SAFETY INSTRUCTIONS

The safety instructions below will tell you how to use your oven to avoid harm to yourself or damage to your oven.

WARNING - To reduce the risk of burns, electric shock, fire, injury to persons, or exposure to excessive microwave energy:

1. Read all instructions before using the appliance.

2. Read and follow the specific **PRECAUTIONS TO AVOID POSSIBLE EXPOSURE TO EXCESSIVE MICROWAVE ENERGY** found on page 3 of this manual.

3. This appliance must be grounded. Connect only to properly grounded outlet.

See **GROUNDING INSTRUCTIONS** found on page 3 of this manual.

4. Install or locate this appliance only in accordance with the provided installation instructions.

5. Some products, such as whole eggs and sealed containers – for example, closed glass jars are able to explode and should not be heated in this oven.

6. Use this appliance only for its intended use as described in the manual. Do not use corrosive chemicals or vapors in this appliance. This type of oven is specifically designed to heat, cook, or dry food. It is not designed for industrial or laboratory use.

7. As with any appliance, close supervision is necessary when used by children.

8. Do not operate this appliance if it has a damaged cord or plug, if it is not working properly, or if it has been damaged or dropped.

9. This appliance should be serviced only by qualified service personnel. Contact the nearest authorized service facility for examination, repair, or adjustment.

10. Do not cover or block any openings on the appliance.

11. Do not store this appliance outdoors. Do not use this product near water – for example, near a kitchen sink, in a wet basement, near a swimming pool, or similar location.

12. Do not immerse cord or plug in water.

13. Keep cord away from heated surfaces.

14. Do not let cord hang over the edge of a table or counter.

15. When cleaning surfaces of door and oven that come together on closing the door, use only mild, nonabrasive soaps or detergents applied with a sponge or soft cloth.

16. To reduce the risk of fire in the oven cavity:

a. Do not overcook food. Carefully attend appliance when paper, plastic, or other combustible materials are placed inside the oven to facilitate cooking.

b. Remove wire twist-ties from paper or plastic bags before placing bag in oven.

c. If materials inside the oven ignite, **KEEP OVEN DOOR CLOSED**, turn oven off, and disconnect the power cord or shut off power at the fuse or circuit breaker panel.

d. Do not use the cavity for storage purposes. Do not leave paper products, cooking utensils, or food in the cavity when not in use.

SAFETY

- 17.** Liquids such as water, coffee, or tea are able to be overheated beyond the boiling point without appearing to be boiling. Visible bubbling or boiling when the container is removed from the microwave oven is not always present. THIS COULD RESULT IN VERY HOT LIQUIDS SUDDENLY BOILING OVER WHEN THE CONTAINER IS DISTURBED OR A SPOON OR OTHER UTENSIL IS INSERTED INTO THE LIQUID. To reduce the risk of injury to persons;
- 1) Do not overheat the liquid.
 - 2) Stir the liquid both before and halfway through heating it.
 - 3) Do not use straight-sided containers with narrow necks.
 - 4) After heating, allow the container to stand in the microwave oven for a short time before removing the container
 - 5) Use extreme care when inserting a spoon or other utensil into the container.
- 18.** Avoid heating small-necked containers such as syrup bottles.
- 19.** Avoid using corrosive and vapors, such as sulfide and chloride.
- 20.** Liquids heated in certain shaped containers (especially cylindrical-shaped containers) may become overheated. The liquid may splash out with a loud noise during or after heating or when adding ingredients (instant coffee, etc.), resulting in harm to the oven and possible injury. In all containers, for best results, stir the liquid several times before heating. Always stir liquid several times between reheatings.

SAVE THESE INSTRUCTIONS

UNDERSTANDING YOUR MICROWAVE OVEN

SPECIFICATIONS

MODEL	LMB0960ST
Power Supply	120 V AC, 60 Hz
Rated Power Consumption	1450 W
Microwave Output	*900 W
Convection Output	1350 W
Grill Output	1000 W
Frequency	2450 MHz
Rated Current	12.5 A
Overall Dimensions(WxHxD)	20 ³ / ₃₂ "X 11 ²⁵ / ₃₂ "X 15 ³ / ₃₂ "
Oven Cavity Dimensions(WxHxD)	13 ¹ / ₃₂ "X 8 ⁵ / ₁₆ "X14 ⁹ / ₁₆ "
Effective Capacity of Oven Cavity	0.9 Cu.ft.

*IEC 60705 RATING STANDARD

Specifications subject to change without prior notice.

INSTALLATION

A. Circuits

For safety purposes this oven must be plugged into a 20 Amp circuit. No other electrical appliances or lighting circuits should be on this line. If in doubt, consult a licensed electrician.

B. Voltage Warning

The voltage used at the wall receptacle must be the same as specified on the oven name plate located on the back or on the side of the control panel of the oven. Use of a higher voltage is dangerous and may result in a fire or other type of accident causing oven damage. Low voltage will cause slow cooking. In case your microwave oven does not perform normally in spite of proper voltage, remove and reinsert the plug.

C. Placement of the Oven

Your microwave oven can be placed easily in your kitchen, family room, or anywhere else in your home. Place the oven on a flat surface such as a kitchen countertop or a specially designed microwave oven cart at least 100cm (39.4 inches) from floor. Do not

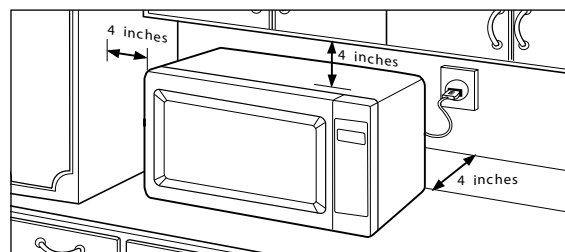

place oven above a gas range. Free air flow around the oven is important. Allow at least 4 inches of space at the top, sides, and back of the oven for proper ventilation.

NOTES:

- Never place the turntable in the oven upside down.

D. Do not block the air vents

All air vents should be kept clear during cooking. If air vents are covered during oven operation the oven may overheat. In this case, a sensitive thermal safety device automatically turns the oven off. The oven will be inoperable until it has cooled sufficiently.

E. Radio interference

1. Microwave oven operation may interfere with TV or radio reception.
2. When there is interference, it may be reduced or eliminated by taking the following measures:
 - a. Clean the door and the sealing surfaces of the oven.
 - b. Reorient the receiving antenna of radio or TV.
 - c. Relocate the microwave oven in relation to the TV or radio.
 - d. Move the microwave oven away from the receiver.
 - e. Plug the microwave oven into a different outlet so that microwave oven and receiver are on different branch circuits.

UNDERSTANDING YOUR MICROWAVE OVEN

PARTS AND ACCESSORIES

Your oven comes with the following accessories:

- Owner's Manual and Cooking Guide : 1 each
- Glass Turntable : 1 each
- Rotating Ring : 1 each
- High Rack : 1 each
- Low Rack : 1 each
- Metal Tray : 1 each

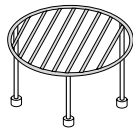
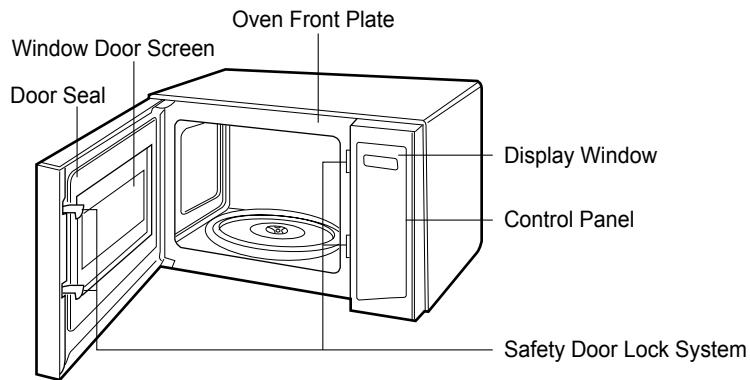

High Rack

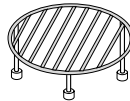

Low Rack

Turntable

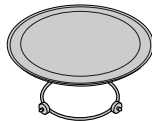

Rotating Ring

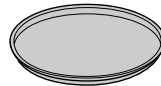

Metal Tray

NOTE: This microwave oven is designed for household use only.
It is not recommended for commercial use.

UNDERSTANDING YOUR MICROWAVE OVEN

CONTROL PANEL

- 1. DISPLAY.** The Display includes a clock and indicators that tell you time of day, cooking time settings, and cooking functions selected.
- 2. REHEAT.** Touch this pad to reheat food automatically.
- 3. COOK.** Touch this pad to select programming food items.
- 4. POPCORN .** Touch this pad to make popcorn on microwave mode.
- 5. CONVECTION.** Touch this pad to cook foods on convection mode.
- 6. COMBI.** This feature will allow you to cook food with microwave and grill function at the same time (or alternately).
- 7. BROIL.** The feature will allow you to brown and crisp food quickly.
- 8. BAKE.** Touch this button to bake foods on combination mode.
- 9 ROAST.** Touch this button to roast foods on combination mode.
- 10. AUTO DEFROST.** This pad is an accurate defrosting method for frozen meat, poultry and fish up to 6.0 lbs.
- 11. COOK POWER.** Touch this pad to set a cooking power.
- 12. COOK TIME.** Touch this pad to set a cooking time.
- 13. CUSTOM SET.** Touch this pad to select sound control, time of day, clock Off or On, scroll speed, lbs /kg choice.
- 14. Ez-ON.** You can extend cooking time in multiples of 30 seconds by repeatedly touching this pad during cooking.
- 15. NUMBER PADS.** Touch Number Pads to enter cooking time, power level, quantities, or weights.
- 16. START/ENTER.** Touch this button to start entries.
- 17. STOP/CLEAR.** It used to stop oven and clear all entries except time day.
- 18. CLOCK.** Touch this pad to enter the time of day.
- 19. TIMER .** Touch this pad to set timer.

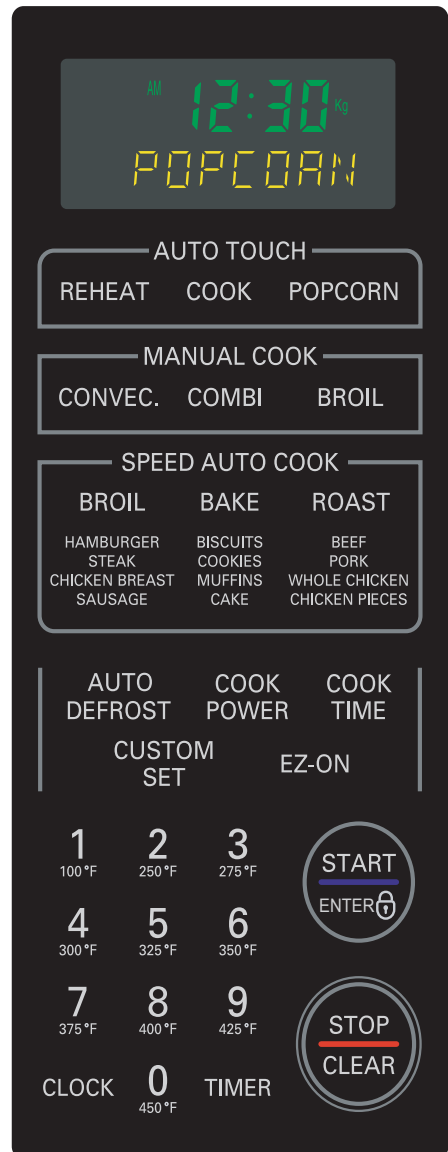

UNDERSTANDING YOUR MICROWAVE OVEN

COOKING COMPARISON GUIDE

Cooking with your new oven offers a wide variety of food preparation options: microwave cooking, convection cooking, and combination cooking.

Microwave cooking uses very short, high-frequency radio waves. The movement of the microwaves through the food generates heat and cooks most foods faster than regular methods while retaining their natural texture and moisture. Microwave cooking heats food directly, not the cookware or the interior of the oven.

Reheating is easy and defrosting is particularly convenient because less time is spent in food preparation.

Convection cooking constantly circulates heated air around the food, creating even browning and sealed in flavor by the constant motion of hot air over the food surfaces.

Combination cooking combines microwave energy with convection to cook with speed and accuracy, while browning and crisping to perfection.

You can use microwave cooking, convection cooking, or combination cooking to cook by time. Simply preset the length of cooking time desired and your oven turns off automatically.

The following guide shows at a glance the difference between microwave, convection, and combination cooking.

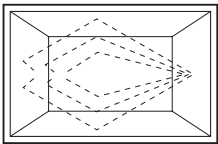
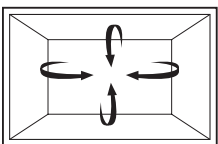
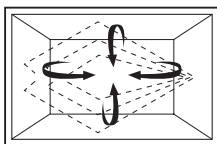
	MICROWAVE	CONVECTION	COMBINATION
COOKING METHOD	 <p>Microwave energy is distributed evenly throughout the oven for fast, thorough cooking of food.</p>	 <p>Hot air circulates around food to produce browned exteriors and sealed in juices.</p>	 <p>Microwave energy and convection heat combine to shorten the cooking time of regular ovens, while browning and sealing in juices.</p>
HEAT SOURCE	Microwave energy.	Circulating heated air.	Microwave energy and circulating heated air.
BENEFITS	<ul style="list-style-type: none"> • Fast, high efficiency cooking. • Oven and surroundings do not get hot. • Easy clean-up. 	<ul style="list-style-type: none"> • Aids in browning and seals in flavor. • Cooks some foods faster than regular ovens. 	<ul style="list-style-type: none"> • Shortened cooking time from microwave energy. • Browning and crisping from convection heat.
<p>Read this guide to learn the many different things your Microwave/Convection/Combination Oven can do. You will find a wide variety of cooking methods and programs designed to suit your lifestyle.</p>			

UNDERSTANDING YOUR MICROWAVE OVEN

TIPS FOR MICROWAVE COOKING

BROWNING

Meat and poultry with high fat content cooked for at least 10 to 15 minutes will brown lightly. Foods cooked a shorter time can be brushed with a browning agent, such as Worcestershire sauce, soy sauce, or barbecue sauce.

COVERING

A cover will trap heat and steam and cause the food to cook more quickly. Use a lid or microwave-safe plastic wrap with one corner folded back to vent the excess steam. Lids on glass casseroles can become hot during cooking; always handle carefully. Waxed paper will prevent the food from splattering in the oven and help retain heat. When warming bread items, use waxed paper, napkins, or paper towels. To absorb extra moisture, wrap sandwiches and fatty foods in paper towels.

SPACING

Arrange individual foods, such as baked potatoes, cupcakes, and hors d'oeuvres in a circle and at least 1 inch apart. This will help the food cook more evenly.

STIRRING

Stirring blends flavors and redistributes the heat in foods. Always stir from the outside toward the center of the dish. Food at the outside of the dish heats first.

TURNING

Large foods, such as roasts and whole poultry, should be turned so that the top and bottom cook evenly. Also turn over chicken pieces and chops.

ARRANGEMENT

Do not stack food. Arrange in a single layer in the dish for more even cooking. Because dense foods cook more slowly, place thicker portions of meat, poultry, fish, and vegetables toward the outside of the dish.

TESTING FOR DONENESS

Foods cook quickly in a microwave oven; test frequently for doneness.

STANDING TIME

Food often needs to stand from 2 to 15 minutes after being removed from the oven. Usually, you need to cover food during standing time to retain heat. Remove most foods when they are slightly undercooked and they will finish cooking during standing time. The internal temperature of food will rise about 10°F during standing time.

SHIELDING

To prevent some portions of rectangular or square dishes from overcooking, you may need to shield them with small strips of aluminum foil to block the microwaves. You can also cover poultry legs and wing tips with foil to keep them from overcooking.

Always keep foil at least 1 inch from oven walls to prevent arcing.

PIERCING

Pierce the shell, skin, or membrane of foods before cooking to prevent them from bursting. Foods that require piercing include yolks and whites of eggs, hot dogs, clams, oysters, and whole vegetables, such as potatoes and squash.

UNDERSTANDING YOUR MICROWAVE OVEN

PRECAUTIONS

- Place the front surface of the door three inches or more from the countertop edge to avoid accidental tipping of the microwave oven during normal use.
- To program the oven, make sure you touch the center of each pad firmly since the areas between the pads will not activate the oven. A tone will sound each time a pad is touched correctly. Do not touch several pads at once.
- Do not strike the control panel with silverware, cookware, etc. Breakage may occur.
- Always use caution when taking cookware out of the oven. Some dishes absorb heat from the cooked food and may be hot. See the “Cookware Guide” earlier in this section for more information.
- Do not rinse cookware immediately after cooking. This may cause breakage. Also, always allow the turntable to cool before removing it from the oven.
- Never operate the oven when it is empty. Food or water should always be in the oven during operation to absorb the microwave energy.
- Do not use the oven to dry newspapers or clothes. They may catch fire.
- Use thermometers that have been approved for microwave oven cooking.
- The turntable must always be in place when you operate the oven.
- Do not use your microwave oven to cook eggs in the shell. Pressure can build up inside the shell, causing it to burst.
- There are several precautions to follow when microwaving popcorn:
 - Do not pop popcorn, except in a microwave-safe container or commercial packages designed for microwave ovens.
 - Never try to pop popcorn in a paper bag that is not microwave-approved.
 - Overcooking may result in smoke and fire.
 - Do not repop unpopped kernels.
 - Do not reuse popcorn bags.
 - Listen while corn pops. Stop oven when popping slows to 2-3 seconds between pops.
 - Do not leave microwave unattended while popping corn.
 - Follow directions on bag.

CLEANING

NOTE: Before cleaning the oven, unplug the power cord. If this is impossible, open the oven door to prevent an accidental oven start.

INTERIOR

Wipe the oven inside and outside with a soft cloth and a mild detergent solution. Then rinse and wipe dry. This should be done weekly or more often, if needed. Never use cleaning powders or rough pads.

Excessive oil splatters on the inside top will be difficult to remove if left for many days. Wipe splatters with a wet paper towel, especially after cooking chicken or bacon.

REMOVABLE PARTS

The turntable and rotating ring are removable. They should be hand-washed in warm (not hot) water with a mild detergent and a soft cloth. Once they are clean, rinse well and dry with a soft cloth. Never use cleaning powders, steel wool, or rough pads.

- The turntable may be cleaned at the sink. Be careful not to chip or scratch the edges as this may cause the turntable to break during use.
- The rotating ring should be cleaned regularly.

DOOR

For best performance and safety, the inner door panel and the oven front frame should be free of food or grease buildup. Wipe often with a mild detergent; then rinse and wipe dry. Never use cleaning powders or rough pads.

After cleaning the control panel, touch CLEAR to clear any entries that might have been entered accidentally while cleaning the panel. Also make sure that the turntable and rotating ring are in the right position.

USING YOUR MICROWAVE OVEN

CLOCK

Example: To set the clock for 1:12(PM).



1. Touch **STOP/CLEAR**.

CLOCK

2. Touch **CLOCK**
ENTER TIME OF DAY
shows in the display.

1 1 2
100°F 100°F 250°F

3. Touch **1.1.2**
TOUCH ENTER
shows in the display.



4. Touch **START/ENTER**.
AM TOUCH 1 PM TOUCH 2
shows in the display.

2
250°F

5. Touch **2. PM 1:12**
shows in the display



6. Touch **START/ENTER**,
clock setting finishes.

NOTE: This is a 12 hour clock.

TIMER

You can use the **TIMER** of your oven for purposes other than food cooking.

Example : To set the timer 3 minutes.



1. Touch **STOP/CLEAR**.

TIMER

2. Touch **TIMER** pad.
:0 shows in the display.

3 0 0

3. Touch **[3],[0],[0]**.



4. Touch **START/ENTER** pad.

Ez-ON

A time-saving pad, this simplified control lets you quickly set and start microwave cooking without the need to touch **START**.

Example : To set Ez-ON cooking 2 minutes.



1. Touch **STOP/CLEAR**.

EZ-ON

2. Touch **Ez-ON** 4 times.
The oven begins cooking and display shows time counting down.

NOTE:

If you touch **Ez-ON**, it will add 30 seconds up to 3 minutes 30 seconds; after 3 minutes 30 seconds, every touch will add 1 minute up to 99 min 29 seconds.

USING YOUR MICROWAVE OVEN

CUSTOM SET

CUSTOM SET provides five modes which make using your microwave oven quite handy. You can select SOUND ON/OFF, CLOCK ON/OFF, SCROLL SPEED, LBS/KG CHOICE.

Example 1 : To turn off Sound of beeper.



1. Touch STOP/CLEAR.

CUSTOM SET

2. Touch CUSTOM SET.
Four modes show in the display repeatedly. You can set them according to your intention:

3. Touch 1. SOUND ON TOUCH 1 OFF TOUCH 2 shows in the display.

1
100 °F

4. Touch 2. SOUND OFF shows in the display and the current time will be displayed.

2
250 °F

NOTE: To turn beep sound back on, repeat steps 1 - 3 then touch number 1.

Example 2 : To set the units.



1. Touch STOP/CLEAR.

CUSTOM SET

2. Touch CUSTOM SET.
Five modes show in the display repeatedly. You can set them according to your intention:

3. Touch 4. LBS TOUCH 1 KG TOUCH 2 shows in the display.

4
300 °F

4. Touch 2. KG shows in the display and the current time will be displayed.

2
250 °F

CUSTOM SET FUNCTION TABLE

NUMBER	FUNCTION	CHOICE
1	SOUND ON / OFF	Sound On or Sound Off
2	CLOCK ON / OFF	Clock On or Clock Off
3	SCROLL SPEED	Slow, Normal, or Fast
4	LBS / KG CHOICE	Lbs or Kg

NOTE: 1. When the power cord is first plugged in, the default setting are Sound ON, Clock ON, Normal Speed, LBS.

2. When power on clock setting

Example : To set Clock

CLOCK

1. Power on, PLEASE SET TIME OF DAY shows in the display



2. Touch CLOCK. ENTER TIME OF DAY shows in the display

2
250 °F

3. Touch 1 1 2. 1:12 shows in the display Touch



4. Touch START/ENTER pad AM TOUCH 1 PM TOUCH 2 shows in the display

5. Touch 2. PM 1:12 shows in the display

6. Touch START/ENTER, clock setting finish

1 **1** **2**
100 °F 100 °F 250 °F

USING YOUR MICROWAVE OVEN

AUTO TOUCH-POPCORN

Use this function to cook food without entering a cook time or power. Refer to the Quick Touch Cooking Table below for more information.

Example: To cook a 3.5oz. bag of microwave popcorn.

Example : POPCORN (popcorn 3.5 oz.)



1. Touch **STOP/CLEAR**.

POPCORN

3.0 OZ TOUCH 1
3.5 OZ TOUCH 2
shows in the display.

2
250°F



2. Touch **POPCORN**.
3. Touch number **2**.
4. Touch **START/ENTER** pad.
The oven will start.

AUTO TOUCH-REHEAT

This feature allows you to reheat pre-cooked room-temperature or refrigerated foods without having to select the cooking time and power level. This feature has 4 categories: dinner plate, pizza, soup/sauce and casserole.

Example : To Reheat 3 cups of Casserole



1. Touch **STOP/CLEAR**.

REHEAT

3
275°F

3
275°F



2. Touch **REHEAT**.
The display scrolls:
SELECT MENU 1 TO 4
3. Touch number **3**.
CASSEROLE TOUCH 1 TO 4
shows in the display.
4. Touch number **3**.
5. Touch **START/ENTER** pad.
The oven will start.

AUTO TOUCH-POPCORN TABLE

Touch	Serving size	Directions
1	3.5 oz.	<ul style="list-style-type: none"> • Follow package instructions. • Do not try to pop unpopped kernels. • Heat only 1 package at a time.
2	3.0 oz.	

AUTO TOUCH-REHEAT TABLE

Category	Direction	Amount
Dinner Plate	Place foods to be heated on dinner plate or similar dish. Cover with plastic wrap and vent. After cooking, allow to stand for 3 minutes.	1 or 2 servings
Soup/ Sauce	Place foods to be heated in an appropriately sized microwave container. Cover with plastic wrap and vent. After cooking, allow to stand for 3 minutes.	1, 2, 3 or 4 cups
Casserole	Cover dish containing the casserole with plastic wrap and vent. After cooking, allow to stand for 3 minutes.	1, 2, 3 or 4 cups
Roll/Muffin	Cover dish containing the casserole with plastic wrap and vent. After cooking, allow to stand for 3 minutes.	1, 2, 3 or 4 pieces

USING YOUR MICROWAVE OVEN

AUTO TOUCH-COOK

This feature allows to cook foods that you select by touching COOK pad. It has 4 foods categories.

Example : To cook 2 Cups. of Rice



1. Touch **STOP/CLEAR**.

COOK

2. Touch **COOK**, then *SELECT MENU 1 TO 4* shows in the display.

4
300°F

3. Touch number **4**, *RICE TOUCH 1 TO 2* shows in the display.

2
250°F

4. Touch number **2**, *TOUCH ENTER* shows in the display.



2. Touch **START/ENTER** pad
The oven will start.

CONVECTION

During convection cooking, a heating element is used to raise the temperature of the air inside the oven. Convection cooking temperature ranges from 100°F to 450°F; and 100°F may be programmed. It is best to preheat the oven when convection cooking.

Example: To set the convection cooking at 375°F for 45 minutes



1. Touch **STOP/CLEAR**.

CONVEC.

2. Touch **CONVEC.** pad, *TOUCH TEMPERATURE OR TOUCH ENTER* shows in the display.

7
375°F

3. Touch number **7**, *375F TOUCH ENTER* shows in the display.



4. Touch **START/ENTER** pad, *ENTER COOKING TIME* shows in the display.

4 5 0 0
300°F 325°F 450°F 450°F

5. Touch number **4.5.0.0**, *TOUCH ENTER* shows in the display.



6. Touch **START/ENTER** pad.
The oven will start

AUTO TOUCH-COOK TABLE

• First, touch COOK pad, then select food and amount.

Category	Direction	Amount
Fresh Vegetable	Prepare as desired, wash, and leave residual water on the vegetables. Place in an appropriately-sized microwave container, cover with plastic wrap and vent.	1 - 4 cups
Frozen Vegetable	Remove from package, rinse off frost under running water. Place in an appropriately-sized microwave container, cover with plastic wrap and vent.	1 - 4 cups
Casserole	Place food in the casserole , Place the casserole into the oven. in an appropriately-sized microwave container, cover with plastic wrap and vent.	1 - 4 cups
Rice	Place rice and twice as much liquid (water or chicken or vegetable stock) in a 2-quart microwavable dish. Cover with plastic wrap. When cooking is complete, allow 10 minutes standing time. Stir for fluffier rice.	1 - 2 cups

USING YOUR CONVECTION OVEN

CONVECTION COOKING GUIDE

1. Always use the metal rack when convection baking. Place food directly on rack or place in metal tray and then place tray on rack. (See page 9.)
2. Aluminum pans conduct heat quickly. For most convection baking, light, shiny finishes give best results because they prevent overbrowning in the time it takes to cook the center areas. Pans with dull (satin-finish) bottoms are recommended for cake pans and pie pans for best bottom browning.
3. Dark or non-shiny finishes, and glass, absorb heat which may result in dry, crisp crusts.
4. Preheating the oven is recommended when baking foods by convection.
5. To prevent uneven heating and save energy, open the oven door to check food as little as possible.

FOOD		Oven Temp.	Time, Min.	Comments
Breads	Biscuits	375° F	14 to 16	Canned refrigerated biscuits take 2 to 4 minutes less time.
	Corn Bread	375° F	22 to 27	Remove from pans immediately and cool slightly on wire rack.
	Muffins	375° F	28 to 32	
	Popovers	325° F	45 to 55	Pierce each popover with a fork after removing from oven to allow steam to escape.
	Nut Bread or Fruit Bread	350° F	55 to 65	Interiors will be moist and tender.
	Yeast Bread	375° F	18 to 25	Lightly grease baking sheet.
	Plain or Sweet Rolls	350° F	13 to 16	
Cakes	Angel Food	325° F	53 to 63	Invert and cool in pan.
	Cheesecake	300° F	80 to 85	After cooking, turn oven off and let cheesecake stand in oven 30 minutes with door ajar.
	Coffee Cake	325° F	30 to 35	Interior will be moist and tender.
	Cup Cakes	325° F	20 to 25	
	Fruit Cake (loaf)	275° F	90 to 100	
	Gingerbread	325° F	42 to 47	
	Butter Cakes, Cake Mixes	325° F	35 to 45	Grease and flour pan. Cool in pan 10 minutes before inverting on wire rack.
	Fluted Tube Cake	325° F	30 to 40	
Pound Cake	325° F	45 to 55		
Cookies	Bar	325° F	40 to 50	Use same time for bar cookies from a mix.
	Drop or Sliced	350° F	15 to 19	Use same time for sliced cookies from a mix.

NOTES:

- The oven temperature indicated in the chart above is recommended over the package instruction temperature.
- The baking time in the chart above is only guidelines for your reference. You need to adjust time according to the food condition or your preference. Check doneness at the minimum time and then adjust time.

USING YOUR MICROWAVE OVEN

COMBI. COOKING

Your oven has a convection + micro cooking feature which allows you to cook food with heater and microwave at the same time (or alternately). This generally means it takes less time to cook your food. Before cooking, you can select one of three cooking modes. The grill rack can be used during cooking.



1. Touch **STOP/CLEAR**.

COMBI

2. Touch **COMBI** pad.
*375F ENTER TEMPERATURE
 OR TOUCH ENTER OR COMBI*
 shows in the display.

5
 325 °F

3. Touch number **5**.
325F TOUCH ENTER
 shows in the display.



4. Touch **START/ENTER** pad
*325F
 ENTER COOKING TIME*
 shows in the display.

4 0 0
 300 °F 450 °F 450 °F

5. Touch number **4.0.0**
325F TOUCH ENTER
 shows in the display.



6. Touch **START/ENTER** pad.
 The oven will start

COMBI. MODES TIME TABLE

TOUCH	CATEGORY	ALTERNATION TIME (s)	
		Mode	Percentage
1 time	[0 - 1]	Microwave	40%
		Convection	
2 times	[0 - 2]	Microwave	10%
		Convection	
3 times	[0 - 3]	Microwave	30%
		Grill	

NOTE: When the oven stops, use oven mitts to carefully remove the dish. It may be very hot.

NOTE: During and after use, do not touch, or let clothing, pot holders or other flammable materials contact the the cooking elements. These surface may be hot enough to burn. Allow sufficient time for cooling first.

NOTE: The circular rack is designed for grilling in the oven. Place the rack securely on a heat resistant plate and then onto the turntable. Position the food on the rack over the heat resistant plate. The heat resistant plate will make clean up easier.

CAUTION: If smoke is observed, turn off or disconnect the oven from the power supply and keep the oven door closed in order to stifle any flames.

USING YOUR MICROWAVE OVEN

AUTO DEFROST

Three defrost sequences are preset in the oven. The auto defrost feature provides you with the best defrosting method for frozen foods. The cooking guide will show you which defrost sequence is recommended for the food you are defrosting. For added convenience, the Auto Defrost includes a built-in beep mechanism that reminds you to check, turn over, separate, or rearrange to get the best defrost results. Three different defrosting levels are provided.

- 1 MEAT
- 2 POULTRY
- 3 FISH
- 4 BREAD

*Available weight is 0.1~6.0 lbs.

NOTE:

When you touch the START pad, the display changes to defrost time count down. The oven will beep during the DEFROST cycle. At this time, open the door and turn, separate, or rearrange the food. Remove any portions that have thawed. Return frozen portions to the oven and touch START to resume the defrost cycle.

OPERATING TIPS

- For best results, remove fish, shellfish, meat, and poultry from its original closed paper or plastic package (wrapper). Otherwise, the wrap will hold steam and juice close to the foods, which can cause the outer surface of the foods to cook.
- For best results, shape your ground meat into the form of a doughnut before freezing. When defrosting, scrape off thawed meat when the beep sounds and continue defrosting.
- Place foods in a shallow container or on a microwave roasting rack to catch drippings.
- Food should still be somewhat icy in the center when removed from the oven.

Example : To Defrost 2.3 lbs fish

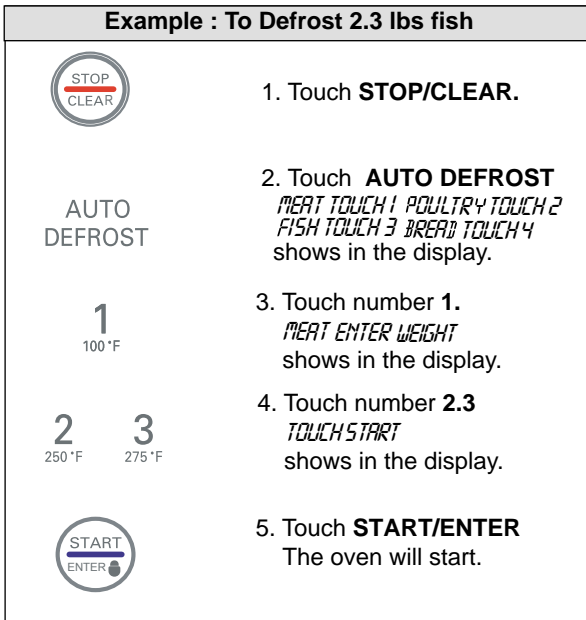

The diagram shows a microwave control panel with the following elements:

- STOP/CLEAR** button at the top left.
- AUTO DEFROST** button in the center.
- Temperature display showing **1** and **100 °F**.
- Temperature buttons **2** (250 °F) and **3** (275 °F).
- START/ENTER** button at the bottom left.

The steps to defrost 2.3 lbs of fish are:

1. Touch **STOP/CLEAR**.
2. Touch **AUTO DEFROST**. The display shows *MEAT TOUCH 1 POULTRY TOUCH 2 FISH TOUCH 3 BREAD TOUCH 4*.
3. Touch number **1**. The display shows *MEAT ENTER WEIGHT*.
4. Touch number **2.3**. The display shows *TOUCH START*.
5. Touch **START/ENTER**. The oven will start.

USING YOUR MICROWAVE OVEN

BROIL COOKING

This feature will allow you to brown and crisp food quickly.



1. Touch **STOP/CLEAR**.

BROIL

2. Touch **BROIL** pad.
ENTER COOKING TIME
shows in the display.

5
325 °F

3. Touch number **5.3.0**.
TOUCH ENTER
shows in the display.



4. Touch **START/ENTER** pad.
The oven will start

NOTE: The metal tray is placed between a glass tray and a grill rack at the grill mode.

NOTE: The grill rack (high rack) must be used during grill cooking.

SPEED AUTO COOK-BROIL

Use this function to cook food without entering cooking time or power level .AUTO COOK has 4 food categories.Refer to the following auto cook guide for more information.

Example : To Broil 1-3 Links Sausage



1. Touch **STOP/CLEAR**.

BROIL

HAMBURGER
STEAK
CHICKEN BREAST
SAUSAGE

2. Touch **SPEED AUTO COOK-BROIL**

The display scrolls:
SELECT MENU 1 TO 4

4
300 °F

3. Touch number **4**.
HSAUSAGE TOUCH 1 TO 4
shows in the display.

1
100 °F

4. Touch number **1**.
1-3 LINKS TOUCH START
shows in the display.



5. Touch **START/ENTER**
The oven will start.

SPEED AUTO COOK-BROIL TABLE

Category	Setting model	Cooking Time		AMOUNT
		STG1	STG2	
Hamburger	Grill	6:30	2:30	1/2 inch, 1-2 patties
		7:30	3:00	1/2 inch, 3-4 patties
		7:30	3:30	1 inch, 1-2 patties
		8:30	6:00	1 inch, 3-4 patties
Beef Steaks	Grill	6:00	3:00	1/2 inch, 1-2 pieces , medium
		6:40	3:20	1/2 inch, 3-4 pieces , well done
		12:00	6:00	1 inch, 1-2 pieces , medium
		13:20	6:40	1 inch, 3-4 pieces , well done
Chicken Breasts	Grill	8:00	4:00	1 - 4 pieces
		10:00	5:50	
		11:00	6:00	
		15:00	8:00	
Sausage	Grill	7:00	6:30	1 - 3 links
		7:00	6:40	4 - 6 links
		7:00	6:50	7 - 9 links
		7:00	7:00	10 - 12 links

Note: After STG1, **turn food over** shows in the display. Please open the door and turn your food.

USING YOUR MICROWAVE OVEN

SPEED AUTO COOK-BAKE

Use this function to cook food without entering cooking time or power level .AUTO COOK has 4 food categories. Refer to the following auto cook guide for more information.

Example : To Bake 12 muffins



1. Touch **STOP/CLEAR**.

BAKE
BISCUITS
COOKIES
MUFFINS
CAKE

2. Touch **SPEED AUTO COOK-BAKE**
The display scrolls:
SELECT MENU 1 TO 4

3
275 °F

3. Touch number **3**.
MUFFINS TOUCH 1 TO 2
shows in the display.

1
100 °F

4. Touch number **1**.
6 MUFFINS TOUCH START
shows in the display.



5. Touch **START/ENTER**
The oven will start.

Example : To Bake Large,5 biscuits



1. Touch **STOP/CLEAR**.

BAKE
BISCUITS
COOKIES
MUFFINS
CAKE

2. Touch **SPEED AUTO COOK-BAKE**
The display scrolls:
SELECT MENU 1 TO 4

1
100 °F

3. Touch number **1**.
BISCUITS TOUCH 1 TO 4
shows in the display.

2
250 °F

4. Touch number **2**.
LARGE 5 BISCUITS TOUCH START
shows in the display.



5. Touch **START/ENTER**
The oven will start.

SPEED AUTO COOK-BAKE TABLE



Category	Setting model	Cooking Time		AMOUNT
		STG1	STG2	
Biscuits	Convection 375 °F	Preheat	16:00	Large,8 biscuits
		Preheat	15:40	Large,5 biscuits
		Preheat	12:00	Small,10-12 biscuits
		Preheat	11:40	Small,5-6 biscuits
Cookies	Convection 375 °F	Preheat	10:00	1/2 inch,1-2 pieces , medium
		Preheat	10:00	1/2 inch,3-4 pieces , welldone
Muffins	Convection 400 °F	Preheat	17:00	6 muffins
		Preheat	20:00	12 muffins
Cake	Convection 325 °F	Preheat	35:00	8 inch pan
		Preheat	26:00	9 inch pan

Note:1.At STG1,**Preheat** shows in the display.
2.Place foot in the oven on low rack

USING YOUR MICROWAVE OVEN

SPEED AUTO COOK-ROAST

Use this function to cook food without entering cooking time or power level .AUTO COOK has 4 food categories. Refer to the following auto cook guide for more information.

Example : To Roast 2.3 lbs whole chicken	
	1. Touch STOP/CLEAR .
ROAST BEEF PORK WHOLE CHICKEN CHICKEN PIECES	2. Touch SPEED AUTO COOK-ROAST The display scrolls: <i>SELECT MENU 1 TO 4</i>
3 275 °F	3. Touch number 3 . <i>WHOLE CHICKEN ENTER WEIGHT</i> shows in the display.
2 250 °F 3 275 °F	4. Touch number 2.3 <i>TOUCH START</i> shows in the display.
	5. Touch START/ENTER The oven will start.

SPEED AUTO COOK-ROAST TABLE

Category	AMOUNT	STEP	ALGORITHM			
			STG	SETTING MODEL	DEFAULT TIME	INCREASE
Beef	2.0-4.0 lbs (0.9-1.8Kg)	0.1 lbs (0.1Kg)	STG1	Convection 400 °F + Microwave 30%	27:30(1633")	1:10(154")
			STG2	Convection 400 °F + Microwave 40%	13:30(801")	0:40(88")
pork	2.0-4.0 lbs (0.9-1.8Kg)	0.1 lbs (0.1Kg)	STG1	Convection 400 °F + Microwave 40%	28:00(1633")	1:10(154")
			STG2	Convection 400 °F + Microwave 30%	14:30(861")	0:40(88")
Whole Chicken	2.0-4.0 lbs (0.9-1.8Kg)	0.1 lbs (0.1Kg)	STG1	Convection 400 °F + Microwave 30%	28:40(1702")	0:50(110")
			STG2	Convection 400 °F + Microwave 10%	14:20(851")	0:30(66")
Chicken pieces	0.5-2.0 lbs (0.2-0.9Kg)	0.1 lbs (0.1Kg)	STG1	Grill + Microwave 30%	6:30(386")	0:10(22")
			STG2	Grill	4:00(237")	0:15(33")
			STG3	Grill	3:10(188")	0:50(110")

Note:After STG1,*turn food over* shows in the display.Please open the door and turn your food.

USING YOUR MICROWAVE OVEN

MICROWAVE POWER LEVELS

Your microwave oven is equipped with ten power levels (11 steps including 0) to give you maximum flexibility and control over cooking. When your cooking program is completed, a beep automatically sounds. The table below will give you some idea of which foods are prepared at each of the various power levels.

MICROWAVE POWER LEVEL CHART

Power Level	Output (of watts)	Use
10 (High)	100%	<ul style="list-style-type: none">● Boil water.● Brown ground beef.● Cook fresh fruits & vegetables.● Make candy.● Cook fish, meat & poultry.● Preheat browning dish.
9	90%	<ul style="list-style-type: none">● Heat precooked food.● Saute onions, celery & green pepper.
8	80%	<ul style="list-style-type: none">● All reheating
7	70%	<ul style="list-style-type: none">● Roast meat & poultry.● Cook mushrooms & shellfish.● Cook foods which contain cheese & eggs.
6	60%	<ul style="list-style-type: none">● Bake cakes, muffins.● Prepare eggs.
5	50%	<ul style="list-style-type: none">● Cook meat, poultry.● Cook custard● Prepare rice, soup.
4	40%	<ul style="list-style-type: none">● Melt butter & chocolate.● Cook less tender cuts of meat.
3	30%	<ul style="list-style-type: none">● All defrosting
2	20%	<ul style="list-style-type: none">● Soften butter & cheese.
1	10%	<ul style="list-style-type: none">● Soften ice cream.● Raise yeast dough.
0	0	<ul style="list-style-type: none">● Standing time.● Independent timer.

HEATING/REHEATING GUIDE

To heat or reheat successfully in the microwave, it is important to follow several guidelines. Measure the amount of food in order to determine the time needed to reheat. Arrange the food in a circular pattern for best results. Room temperature food will heat faster than refrigerated food. Canned foods should be taken out of the can and placed in a microwavable container. The food will be heated more evenly if covered with a microwavable lid or plastic wrap and vented. Remove cover carefully to prevent steam burns. Use the following chart as a guide for reheating cooked food.

Items	Cook time (at HIGH)	Special Instructions
Sliced meat 3 slices (1/4-inch thick)	1-2 minutes	Place sliced meat on microwavable plate. Cover with plastic wrap and vent. * Note: Gravy or sauce helps to keep meat juicy
Chicken pieces 1 breast 1 leg and thigh	2-3 1/2 minutes 1 1/2 -3 minutes	Place chicken pieces on microwavable plate. Cover with plastic wrap and vent.
Fish fillet (6-8 oz.)	2-4 minutes	Place fish on microwavable plate. Cover with plastic wrap and vent.
Lasagna 1 serving (10 1/2 oz.)	4-6 minutes	Place lasagna on microwavable plate. Cover with plastic wrap and vent.
Casserole 1 cup 4 cups	1-3 1/2 minutes 5-8 minutes	COOK covered in microwavable casserole. Stir once halfway through cooking.
Casserole – cream or cheese 1 cup 4 cups	1 1/2-3 minutes 3 1/2-5 1/2 minutes	COOK covered in microwavable casserole. Stir once halfway through cooking.
Sloppy Joe or Barbecued beef 1 sandwich (1/2 cup meat filling) without bun	1-2 1/2 minutes	Reheat filling and bun separately Cook filling covered in microwavable casserole. Stir once. Heat bun as directed in chart below.
Mashed potatoes 1 cup 4 cups	1-3 minutes 5-8 minutes	COOK covered in microwavable casserole. Stir once halfway through cooking.
Baked beans 1 cup	1 1/2-3 minutes	COOK covered in microwavable casserole. Stir once halfway through cooking.
Ravioli or pasta in sauce 1 cup 4 cups	2 1/2-4 minutes 7 1/2-11 minutes	COOK covered in microwavable casserole. Stir once halfway through cooking.
Rice 1 cup 4 cups	1 1/2-3 1/2 minutes 4-6 1/2 minutes	COOK covered in microwavable casserole. Stir once halfway through cooking.
Sandwich roll or bun 1 roll	15-30 seconds	Wrap in paper towel and place on glass microwavable rack
Vegetables 1 cup 4 cups	1 1/2-2 1/2 minutes 4-6 minutes	COOK covered in microwavable casserole. Stir once halfway through cooking.
Soup 1 serving (8 oz.)	1 1/2-2 1/2 minutes	COOK covered in microwavable casserole. Stir once halfway through cooking.

FRESH VEGETABLE GUIDE

Vegetable	Amount	Cook time at HIGH	Instructions	Standing Time
Artichokes (8oz. each)	2 medium 4 medium	5-8 minutes	Trim. Add 2 tsp water and 2 tsp juice. Cover.	2-3 minutes
Asparagus, Fresh, Spears	1lb.	3-6 minutes	Add ½ cup water. Cover.	2-3 minutes
Beans, Green & Wax	1 lb.	7-11 minutes	Add ½ cup water in 1½ qt. casserole. Stir halfway through cooking.	2-3 minutes
Beets, Fresh	1 lb.	12-16 minutes	Add ½ cup water in 1½ qt. covered casserole. Rearrange halfway through cooking.	2-3 minutes
Broccoli, Fresh, Spears	1lb.	4-8 minutes	Place broccoli in baking dish. Add ½ cup water.	2-3 minutes
Cabbage, Fresh, Chopped	1lb.	4-7 minutes	Add ½ cup water in 1½ qt. covered casserole. Stir halfway through cooking.	2-3 minutes
Carrots, Fresh, Sliced	2 cups	2-4 minutes	Add ¼ cup water in 1 qt. covered casserole. Stir halfway through cooking.	2-3 minutes
Cauliflower Fresh, Whole	1lb.	7-11 minutes	Trim. Add ¼ cup water in 1 qt. covered casserole. Stir halfway through cooking.	2-3 minutes
Flowerettes, Fresh	2 cups	2½-4½ minutes	Slice. Add ½ cup water in 1½ qt. covered casserole. Stir halfway through cooking.	2-3 minutes
Celery, Fresh, Sliced	4 cups	6-8 minutes		
Corn, Fresh	2 ears	5-9 minutes	Husk. Add 2 tbsp water in 1½ qt. baking dish. Cover.	2-3 minutes
Mushrooms, Fresh, Sliced	½ lb.	2-3½ minutes	Place mushrooms in 1½ qt. covered casserole. Stir halfway through cooking.	2-3 minutes
Parsnips, Fresh, Sliced	1lb.	4-8 minutes	Add ½ cup water in 1½ qt. covered casserole. Stir halfway through cooking.	2-3 minutes
Peas, Green, Fresh	4 cups	7-10 minutes	Add ½ cup water in 1½ qt. covered casserole. Stir halfway through cooking.	2-3 minutes
Sweet Potatoes Whole Baking (6-8 oz. each)	2 medium	5-10 minutes	Pierce potatoes several times with fork. Place on 2 paper towels. Turn over halfway through cooking.	2-3 minutes
	4 medium	7-13 minutes		2-3 minutes
White Potatoes, Whole Baking (6-8 oz. each)	2 potatoes	5-8 minutes	Pierce potatoes several times with fork. Place on 2 paper towels. Turn over halfway through cooking.	2-3 minutes
	4 potatoes	10-14 minutes		2-3 minutes
Spinach, Fresh, Leaf	1lb.	4-7 minutes	Add ½ cup water in 2 qt. covered casserole.	2-3 minutes
Squash, Acorn Butternut, Fresh	1 medium	6-8 minutes	Cut squash in half. Remove seeds. Place in 8 x 8-inch baking dish. Cover.	2-3 minutes
Zucchini, Fresh, Sliced	1lb.	4½-7½ minutes	Add ½ cup water in 1½ qt. covered casserole. Stir halfway through cooking.	2-3 minutes
Zucchini, Fresh, Whole	1lb.	6-9 minutes	Pierce. Place on 2 paper towels. Turn zucchini over and rearrange halfway through cooking.	2-3 minutes

TROUBLESHOOTING

Questions and Answers

Operation

Question	Answer
Why is the oven light not on during cooking?	There may be several reasons why the oven light is not on. Have you: <ul style="list-style-type: none"> • Set a cook time? • Touched START?
Why does steam come out of the air exhaust vent?	Steam is normally produced during cooking. The microwave oven has been designed to vent this steam.
Will the microwave oven be damaged if it operates empty?	Yes. Never operate the oven empty or without the glass turntable.
Does microwave energy pass through the viewing screen in the door?	No. The metal screen bounces the energy back to the oven cavity. The holes (or ports) allow only light to pass through. They do not let microwave energy pass through.
Why does a tone sound when a pad on the control panel is touched?	The tone tells you that the setting has been entered.
Can my microwave oven be damaged if food is cooked for too long?	Like any other cooking appliance, it is possible to overcook food to the point that the food creates smoke and even possibly fire and damage to the inside of the oven. It is always best to be near the oven while you are cooking.
When the oven is plugged into wall outlet for the first time, it might not work properly. What is wrong?	The microcomputer controlling your oven may temporarily become scrambled and fail to function as programmed when you plug in for the first time or when power resumes after a power interruption. Unplug the oven from the 120-volt household outlet and then plug it back in to reset the microcomputer.
Why do I see light reflection around the outer case?	This light is from the oven light which is located between the oven cavity and the outer wall of the oven.
What are the various sounds I hear when the microwave oven is operating?	The clicking sound is caused by a mechanical switch turning the microwave oven's magnetron ON and OFF. The heavy hum and clunk is from the change in power the magnetron draws as it is turned ON and OFF by a mechanical switch. The change in blower speed is from the change in line voltage caused by the magnetron being turned ON and OFF.

Food

Question	Answer
What is wrong when baked foods have a hard, dry, brown spot?	A hard, dry, brown spot indicates overcooking. Shorten the cooking or reheating time.
Why do eggs sometimes pop?	When baking, frying, or poaching eggs, the yolk may pop due to steam build-up inside the yolk membrane. To prevent this, simply pierce the yolk before cooking. CAUTION: Never microwave eggs in the shell.

TROUBLESHOOTING

Questions and Answers (continued)

Food

Question	Answer
Why are scrambled eggs sometimes a little dry after cooking?	Eggs will dry out when they are overcooked, even if the same recipe is used each time. The cooking time may need to be varied for one of these reasons: <ul style="list-style-type: none"> • Eggs vary in size. • Eggs are at room temperature one time and at refrigerator temperature another time. • Eggs continue cooking during standing time.
Is it possible to pop popcorn in a microwave oven?	Yes, if using one of the two methods described below: <ol style="list-style-type: none"> (1) microwave-popping devices designed specifically for microwave cooking (2) prepackaged commercial microwave popcorn that is made for specific times and power output needed <p>Follow exact directions given by each manufacturer for its popcorn popping product and do not leave the oven unattended while the corn is being popped. If corn fails to pop after the suggested time, discontinue cooking. Overcooking could result in an oven fire.</p> <p>CAUTION:</p> <ul style="list-style-type: none"> • Never use a brown paper bag for popping corn or attempt to pop leftover kernels. • Do not pop prepackaged commercial microwave popcorn directly on the glass turntable. To avoid excessive heating of the glass turntable, place the popcorn bag on a plate. • Listen while corn pops. Stop oven when popping slows to 2-3 seconds between pops. • Do not leave microwave unattended while popping corn. • Follow directions on bag.
Why do baked apples sometimes burst during cooking?	The peel has not been removed from the top half of each apple to allow for expansion of the interior of the apple during cooking. As in conventional cooking methods, the interior of the apple expands during the cooking process.
Why do baked potatoes sometimes burn during cooking?	If the cooking time is too long, fire could result. At the end of the recommended cooking time, potatoes should be slightly firm. <p>CAUTION: Do not overcook.</p>
Why is a standing time recommended after microwave cooking time is over?	Standing time allows foods to continue cooking evenly for a few minutes after the actual microwave oven cooking cycle. The amount of standing time depends upon the density of the foods.
Why is additional time required for cooking food stored in the refrigerator?	As in conventional cooking, the initial temperature of food affects total cooking time. You need more time to cook food taken out of a refrigerator than for food at room temperature.

TROUBLESHOOTING

Before Calling for Service

You can often correct operating problems yourself. If your microwave oven fails to work properly, locate the operating problem in the list below and try the solutions listed for each problem.

If the microwave oven still does not work properly, contact the nearest LG Authorized Service Center. LG Authorized Service Centers are fully equipped to handle your service requirements.

Problem	Possible Causes
Oven does not start	<ul style="list-style-type: none"> • Is the power cord plugged in? • Is the door closed? • Is the cooking time set?
Arcing or Sparking	<ul style="list-style-type: none"> • Are you using approved cookware? • Is the oven empty?
Incorrect time of day	<ul style="list-style-type: none"> • Have you tried to reset the time of day?
Unevenly Cooked Foods	<ul style="list-style-type: none"> • Are you using approved cookware? • Is the glass turntable in the oven? • Did you turn or stir the food while it was cooking? • Were the foods completely defrosted? • Was the time/cooking power level correct?
Overcooked Foods	<ul style="list-style-type: none"> • Was the time/cooking power level correct?
Undercooked Foods	<ul style="list-style-type: none"> • Are you using approved cookware? • Were the foods completely defrosted? • Was the time/cooking power level correct? • Are the ventilation ports clear?
Improper Defrosting	<ul style="list-style-type: none"> • Are you using approved cookware? • Was the time/cooking power level correct? • Did you turn or stir the food during the defrosting cycle?

FEDERAL COMMUNICATIONS COMMISSION RADIO FREQUENCY INTERFERENCE STATEMENT

WARNING:

This equipment generates and uses ISM frequency energy and if not installed and used properly, that is in strict accordance with the manufacturer's instructions, may cause interference to radio and television reception. It has been type tested and found to comply with limits for ISM Equipment pursuant to part 18 of FCC Rules, which are designed to provide reasonable protection against such interference in a residential installation.

However, there is no guarantee that interference will not occur in a particular installation. If this equipment does cause interference to radio or television reception, which can be determined by turning the equipment off and on, the user is encouraged to try to correct the interference by one or more of the following:

- Reorient the receiving antenna of the radio or television.
- Relocate the microwave oven with respect to the receiver.
- Move the microwave oven away from the receiver.
- Plug the microwave oven into a different outlet so that the microwave oven and the receiver are on different branch circuits.

The manufacturer is not responsible for any radio or TV interference caused by **unauthorized modification** to this microwave oven. It is the responsibility of the user to correct such interference.



LG MICROWAVE OVEN LIMITED WARRANTY – USA

Model LMB0960ST

LG Electronics, Inc. will repair or replace your product, at LG's option, if it proves to be defective in material or workmanship under normal use, during the warranty period set forth below, effective from the date of original consumer purchase of the product. This warranty is good only to the original purchaser of the product and effective only when used in the United States, including U.S. Territories.

<p><u>WARRANTY PERIOD:</u></p> <p>LABOR: One Year from the Date of Purchase*.</p> <p>PARTS (except as listed below): One Year from the Date of Purchase*.</p> <p>MAGNETRON: Ten Years from the Date of Purchase*.</p> <p>Replacement Units and Repair Parts are warranted for the remaining portion of the original unit's warranty period.</p> <p>* Retain your Sales Receipt to prove the date of purchase. A copy of your Sales Receipt must be submitted at the time warranty service is provided.</p>	<p><u>HOW SERVICE IS HANDLED:</u></p> <p>Please call 1-800-243-0000 and choose the appropriate option. (Phones are answered 24 hours a day, 365 days per year.) Please have the product type (Microwave) and your ZIP code ready.</p> <p>Or visit our website at: http://us.lgservice.com</p>
---	---

THIS WARRANTY IS IN LIEU OF ANY OTHER WARRANTY, EXPRESS OR IMPLIED, INCLUDING WITHOUT LIMITATION, ANY WARRANTY OF MERCHANTABILITY OR FITNESS FOR A PARTICULAR PURPOSE. TO THE EXTENT ANY IMPLIED WARRANTY IS REQUIRED BY LAW, IT IS LIMITED IN DURATION TO THE EXPRESS WARRANTY PERIOD ABOVE. LG WILL NOT BE LIABLE FOR ANY INCIDENTAL, CONSEQUENTIAL, INDIRECT, SPECIAL, OR PUNITIVE DAMAGES OF ANY NATURE, INCLUDING WITHOUT LIMITATION, LOST REVENUES OR PROFITS, OR ANY OTHER DAMAGE WHETHER BASED IN CONTRACT, TORT, OR OTHERWISE. Some states do not allow the exclusion or limitation of incidental or consequential damages or limitations on how long an implied warranty lasts, so the above exclusion or limitation may not apply to you. This warranty gives you specific legal rights and you may also have other rights that vary from state to state.

THIS LIMITED WARRANTY DOES NOT APPLY TO:

- Service trips to your home to deliver, pick up, and/or install the product, instruct, or replace house fuses or correct wiring, or correction of unauthorized repairs.
- Damages or operating problems that result from misuse, abuse, operation outside environmental specifications or contrary to the requirements of precautions in the Operating Guide, accident, vermin, fire, flood, improper installation, acts of God, unauthorized modification or alteration, incorrect electrical current or voltage, or commercial use, or use for other than intended purpose.

The cost of repair or replacement under these excluded circumstances shall be borne by the consumer.

CUSTOMER INTERACTIVE CENTER NUMBERS

<p>To obtain Customer Assistance, Product Information, or Dealer or Authorized Service Center location:</p>	<p>Call 1-800-243-0000 (24 hours a day, 365 days per year) and select the appropriate option from the menu.</p> <p>Or visit our website at: http://us.lgservice.com</p>
--	---

TO CONTACT LG ELECTRONICS BY MAIL:

LG Customer Interactive Center
P. O. Box 240007
201 James Record Road
Huntsville, Alabama 35824
ATTN: CIC



LG Electronics Inc.

P/NO.: 382885A0051

Printed in China

Free Manuals Download Website

<http://myh66.com>

<http://usermanuals.us>

<http://www.somanuals.com>

<http://www.4manuals.cc>

<http://www.manual-lib.com>

<http://www.404manual.com>

<http://www.luxmanual.com>

<http://aubethermostatmanual.com>

Golf course search by state

<http://golfingnear.com>

Email search by domain

<http://emailbydomain.com>

Auto manuals search

<http://auto.somanuals.com>

TV manuals search

<http://tv.somanuals.com>