



website: <http://www.lgservice.com>



# MICROWAVE OVEN

## OWNER'S MANUAL & COOKING GUIDE

PLEASE READ THIS OWNER'S MANUAL  
THOROUGHLY BEFORE OPERATING.

**LMV1635SW**  
**LMV1635SB**  
**LMV1635SBQ**

P/NO. 3828W5A3450

## ***Thank you for purchasing a LG microwave oven.***

Please record the model number and serial number of this unit for future reference. We also suggest you record the details of your contact with LG (LG Electronics U.S.A., Inc.) concerning this unit.

Model No: \_\_\_\_\_

Serial No: \_\_\_\_\_

Dealer: \_\_\_\_\_

\_\_\_\_\_

\_\_\_\_\_

Dealer Phone No: \_\_\_\_\_

Staple your receipt here to prove your retail purchase.

Customer Relations  
LG Electronics U.S.A., Inc.  
Service Division Bldg. #3  
201 James Record Rd.  
Huntsville, AL 35824-0126

## **PRECAUTIONS TO AVOID POSSIBLE EXPOSURE TO EXCESSIVE MICROWAVE ENERGY...**

- (a) Do not attempt to operate this oven with the door open since open-door operation can result in harmful exposure to microwave energy. It is important not to defeat or tamper with the safety interlocks.
- (b) Do not place any object between the oven front face and the door or allow soil or cleaner residue to accumulate on sealing surfaces.
- (c) Do not operate the oven if it is damaged. It is particularly important that the oven door closes properly and that there is no damage to the:
  - (1) Door (bent),
  - (2) Hinges and latches (broken or loosened),
  - (3) Door seals and sealing surfaces.
- (d) The oven should not be adjusted or repaired by anyone except properly qualified service personnel.

# TABLE OF CONTENTS

|  |                          |
|--|--------------------------|
| <b>PRECAUTIONS TO AVOID POSSIBLE EXPOSURE TO EXCESSIVE MICROWAVE ENERGY.....</b> | <b>2</b>                 |
| <b>TABLE OF CONTENTS.....</b>  | <b>3</b>                 |
| <b>SAFETY.....</b>   | <b>4</b>                 |
| Important Safety Instructions.....   | 4                        |
| <b>INFORMATION.....</b>  | <b>6</b>                 |
| Location of Model Number.....  | 6                        |
| Oven Specifications.....   | 6                        |
| Electrical Rating.....   | 6                        |
| Electrical Requirements.....   | 6                        |
| Grounding Instructions.....  | 6                        |
| Microwave Oven Features.....   | 7                        |
| Oven Control Panel.....  | 8                        |
| <b>OPERATION.....</b>  | <b>10</b>                |
| <b>LEARN ABOUT YOUR MICROWAVE OVEN.....</b>                                      | <b>10</b>                |
| Clock.....   | 10                       |
| Kitchen Timer.....   | 10                       |
| Light Timer.....   | 10                       |
| FAN Hi/Low/Off.....  | 11                       |
| LIGHT Hi/Low/Off.....  | 11                       |
| TURNABLE On/Off.....   | 11                       |
| Child Lock.....  | 11                       |
| Help.....  | 11                       |
| Hold Warm.....   | 11                       |
| Custom Set.....  | 12                       |
| Ez On.....   | 12                       |
| Custom Cook.....   | 12                       |
| More / Less.....   | 13                       |
| Cooking at High Cook Power.....  | 13                       |
| Cooking at Lower Power Levels.....   | 13                       |
| Cooking Guide for “Lower Power Levels”.....                                      | 14                       |
| <b>SENSOR OPERATING INSTRUCTIONS.....</b>  | <b>15</b>                |
| Sensor Cooking Guide.....  | 15                       |
| Adding or Subtracting Cook time.....   | 16                       |
| Popcorn.....   | 16                       |
| Vegetable.....   | 16                       |
| Potato.....  | 17                       |
| Pizza.....   | 17                       |
| Cook.....  | 17                       |
| Reheat.....  | 17                       |
| <b>AUTO DEFROST.....</b>   | <b>18</b>                |
| <b>AUTO DEFROST CHART.....</b>   | <b>19</b>                |
| <b>COOKING.....</b>  | <b>21</b>                |
| <b>GETTING THE BEST COOKING RESULTS.....</b>                                     | <b>21</b>                |
| <b>FISH &amp; SHELLFISH.....</b>   | <b>21</b>                |
| Cooking Fish and Shellfish: General Directions.....                              | 21                       |
| Fish And Shellfish Cooking Table.....  | 21                       |
| <b>APPETIZERS / SAUCES / SOUPS.....</b>  | <b>22</b>                |
| Cooking Appetizers: Tips and Techniques.....                                     | 22                       |
| <b>MEAT.....</b>   | <b>22</b>                |
| Cooking Meat: General Directions.....  | 22                       |
| Meat Cooking Table.....  | 23                       |
| <b>POULTRY.....</b>  | <b>24</b>                |
| Cooking Poultry: General Directions.....   | 24                       |
| Poultry Cooking Table.....   | 24                       |
| <b>PASTA AND RICE.....</b>   | <b>25</b>                |
| Cooking Pasta and Rice: Tips and Techniques.....                                 | 25                       |
| Pasta Cooking Table.....   | 25                       |
| Rice Cooking Table.....  | 25                       |
| <b>MAINTENANCE.....</b>  | <b>26</b>                |
| <b>CARE AND CLEANING.....</b>  | <b>26</b>                |
| Cleaning the Grease Filters.....   | 26                       |
| Charcoal Filter(Optional) Replacement.....                                       | 26                       |
| Cooktop/Night Light Replacement.....   | 27                       |
| Oven Light Replacement.....  | 27                       |
| <b>QUESTIONS AND ANSWERS.....</b>  | <b>27</b>                |
| <b>MICROWAVE UTENSIL GUIDE.....</b>  | <b>28</b>                |
| <b>BEFORE CALLING FOR SERVICE.....</b>   | <b>29</b>                |
| <b>WARRANTY.....</b>   | <b>Inside back cover</b> |

# SAFETY

## IMPORTANT SAFETY INSTRUCTIONS

The safety instructions below will tell you how to use your oven and avoid harm to yourself or damage to your oven.

**⚠ WARNING** - To reduce the risk of burns, electric shock, fire, injury to persons, or exposure to excessive microwave energy.

- **Read all the instructions before using your oven.**
- **Do not allow children to use this oven without close supervision.**
- Read and follow the specific **PRECAUTIONS TO AVOID POSSIBLE EXPOSURE TO EXCESSIVE MICROWAVE ENERGY** found on page 2.
- **Do not use** corrosive chemicals or vapors, such as sulfide and chloride, in this appliance. This type of oven is specifically designed to heat, cook, or dry food. It is not designed for industrial or laboratory use.
- **Do not use or store** this appliance outdoors. Do not use this product near water - for example, near a kitchen sink, in a wet basement, or near a swimming pool, and the like.
- **Do not use** the cavity for storage purposes. Do not leave paper products, cooking utensils, or food in the cavity when not in use.
- **Clean the ventilating hood frequently.** Do not allow grease to accumulate on the hood or the filters.
- Use care when cleaning the vent hood filters. Corrosive cleaning agents such as lye-based oven cleaners may damage the filters.
- **Do not tamper with the built-in safety switches on the oven door.** The oven has several built-in safety switches to make sure the power is off when the door is open.
- When food flames under the hood, turn the fan on.
- Suitable for use above both gas and electric cooking equipment 36 inches wide or less.
- **Do not use this oven for commercial purposes.** It is made for household use only.
- **When cleaning the door and the surfaces that touch the door, use only mild, non-abrasive soaps or detergents and a sponge or soft cloth.**
- **If your oven is dropped or damaged,** have it thoroughly checked by a qualified service technician before using it again.
- **To avoid a fire hazard:**
  - **Do not severely overcook food.** Severely overcooked foods can start a fire in the oven. Watch the oven carefully, especially if you have paper, plastic, or other combustibles in the oven.
  - **Do not store combustible items (bread, cookies, etc.) in the oven,** because if lightning strikes the power lines it may cause the oven to turn on.
  - **Do not use wire twist-ties in the oven.** Be sure to inspect purchased items for wire twist-ties and remove them before placing the item in the oven.
- **If a fire should start:**
  - **Keep the oven door closed.**
  - **Turn the oven off.**
  - **Disconnect the power cord or shut off the power at the fuse or circuit breaker panel.**
- **To avoid electric shock:**
  - **This appliance must be grounded.** Connect it only to a properly grounded outlet. See the electrical **GROUNDING INSTRUCTIONS** on page 6.
  - **Do not operate this appliance if it has a damaged cord or plug,** if it is not working properly or if it has been damaged or dropped.
  - **Do not immerse the electrical cord or plug in water.**
  - **Keep the cord away from heated surfaces.**

# SAFETY

- **To avoid improperly cooking some foods.**
  - **Do not heat any types of baby bottles or baby food.** Uneven heating may occur and possibly cause personal injury.
  - **Do not heat small-necked containers**, such as syrup bottles.
  - **Do not deep-fat fry in your microwave oven.**
  - **Do not attempt home canning in your microwave oven.**
  - **Do not heat the following items in the microwave oven:** whole eggs in the shell, water with oil or fat, sealed containers, or closed glass jars. These items may explode.
- Do not cover or block any openings in the oven.
- Use your oven only for the operations described in this manual.
- Do not run the oven empty, without food in it.
- Do not let cord hang over edge of table or counter.
- **Preserve the oven floor:**
  - **Do not heat the oven floor excessively.**
  - **Do not** allow the gray film on special microwave-cooking packages to touch the oven floor. Put the package on a microwavable dish.
  - **Do not** cook anything directly on the oven floor or turntable. Use a microwavable dish.
  - Keep a browning dish at least 3/16 inch above floor. Carefully read and follow the instructions for the browning dish. If you use a browning dish incorrectly, you could damage the oven floor.
- Install or locate this appliance only in accordance with the provided installation instructions.
- This appliance should be serviced only by qualified service personnel. Contact the nearest authorized service facility for examination, repair, or adjustment.
- Liquids, such as water, coffee, or tea are able to be overheated beyond the boiling point without appearing to be boiling. Visible bubbling or boiling when the container is removed from the microwave oven is not always present.

**THIS COULD RESULT IN VERY HOT LIQUIDS SUDDENLY BOILING OVER WHEN THE CONTAINER IS DISTURBED OR A SPOON OR OTHER UTENSIL IS INSERTED INTO THE LIQUID.** To reduce the risk of injury to persons;

  - Do not overheat the liquid.
  - Stir the liquid both before and halfway through heating it.
  - Do not use straight-sided containers with narrow necks.
  - After heating, allow the container to stand in the microwave oven for a short time before removing the container.
  - Use extreme care when inserting a spoon or other utensil into the container.

## SAVE THESE INSTRUCTIONS

### FEDERAL COMMUNICATIONS COMMISSION RADIO FREQUENCY INTERFERENCE STATEMENT ( U.S.A. ONLY)

#### **WARNING:**

This equipment generates and uses ISM frequency energy and if not installed and used properly, that is in strict accordance with the manufacturer's instructions, may cause interference to radio and television reception. It has been type tested and found to comply with limits for ISM Equipment pursuant to part 18 of FCC Rules, which are designed to provide reasonable protection against such interference in a residential installation.

However, there is no guarantee that interference will not occur in a particular installation. If this equipment does cause interference to radio or television reception, which can be determined by turning the equipment off and on, the user is encouraged to try to correct the interference by one or more of the following:

- Reorient the receiving antenna of the radio or television.
- Relocate the Microwave Oven with respect to the receiver.
- Move the microwave oven away from the receiver.
- Plug the microwave oven into a different outlet so that the microwave oven and the receiver are on different branch circuits.

**The manufacturer** is not responsible for any radio or TV interference caused by **unauthorized modification** to this microwave oven. It is the responsibility of the user to correct such interference.

# INFORMATION

Please read this owner's manual. It will tell you how to use all the fine features of this microwave oven.

## LOCATION OF MODEL NUMBER

To request service information or replacement parts, the service center will require the complete model number of your microwave oven. The number is on the left side of control panel as shown in the illustration below.

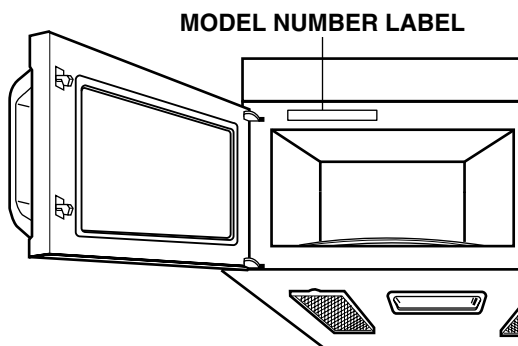

## OVEN SPECIFICATIONS

Output Power 1,000W (IEC 60705 Standard)  
Outer Dimensions 29-15/16" x 16-7/16" x 15-3/8"  
Cavity Volume 1.6 Cu.ft  
Net Weight 52 lbs.

## ELECTRICAL RATING

\* Electrical Rating of the Oven: 120V AC 60Hz  
\* 13 Amps / 1500 Watts (MWO + Cooktop Lamp + Ventilation Fan)

## ELECTRICAL REQUIREMENTS

The oven is designed to operate on a Standard 120V/60Hz household outlet. Be sure the circuit is at least 15A or 20A and the microwave oven is the **only appliance on the circuit**. It is not designed for 50Hz or any circuit other than a 120V/60Hz circuit.

## GROUNDING INSTRUCTIONS

**This appliance must be grounded.** If an electrical short circuit occurs, grounding reduces the risk of electric shock by providing an escape wire for the electric current. The cord for this appliance has a grounding wire with a grounding plug. Put the plug into an outlet that is properly installed and grounded.

**WARNING - If you use the grounding plug improperly, you risk electric shock.**

Ask a qualified electrician if you do not understand the grounding instructions or if you wonder whether the appliance is properly grounded.

Because this appliance fits under the cabinet, it has a short power-supply cord. See the separate Installation Instructions for directions on properly placing the cord. Keep the electrical power cord dry and do not pinch or crush it in any way.

If it is necessary to use an extension cord, use only a 3-wire extension cord that has a 3-blade grounding plug, and a 3-slot receptacle that will accept the plug on the appliance. The marked rating of the extension cord shall be equal to or greater than the electrical rating of the appliance.

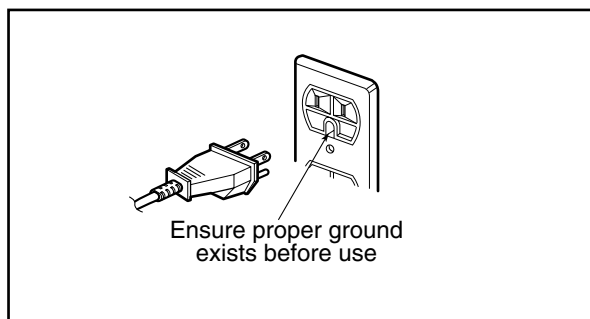

For a permanently connected appliance: This appliance must be connected to a grounded, metallic, permanent wiring system, or an equipment grounding conductor should be run with the circuit conductors and connected to the equipment grounding terminal or lead on the appliance.

# INFORMATION

## MICROWAVE OVEN FEATURES

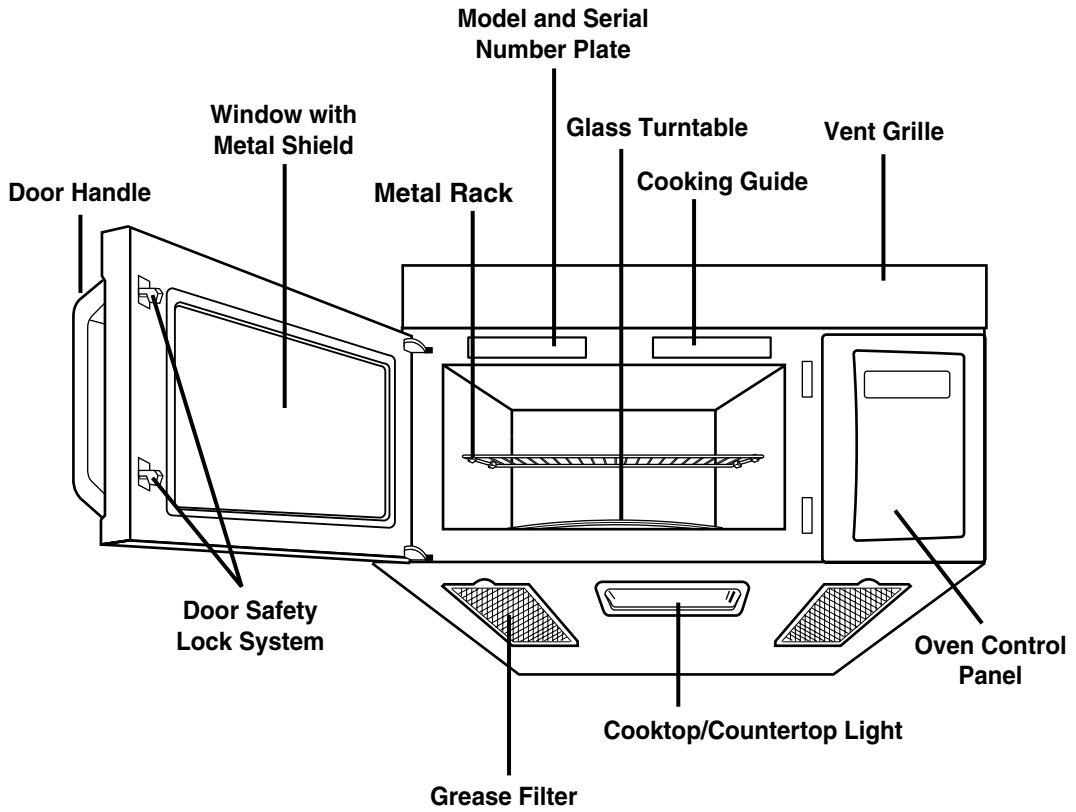

# INFORMATION

## OVEN CONTROL PANEL

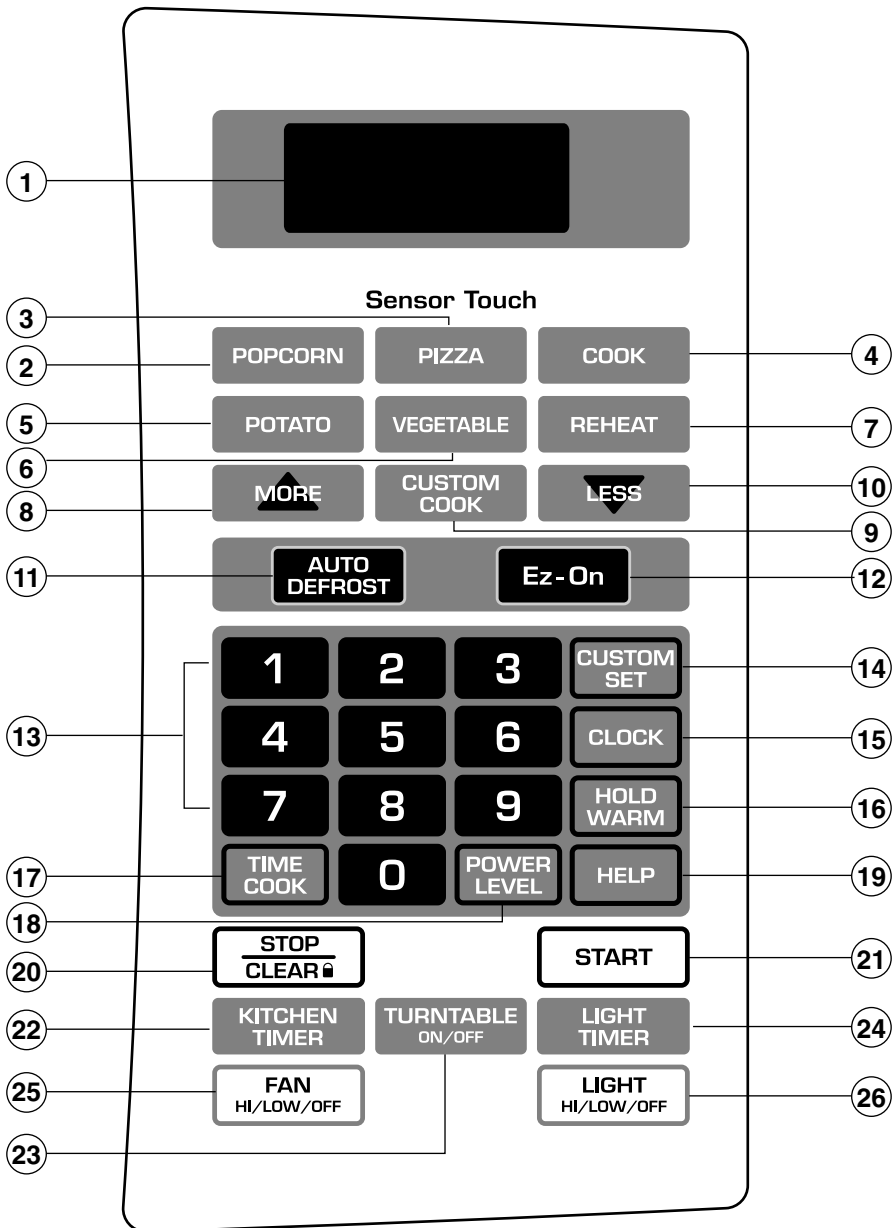



# INFORMATION

- 1. DISPLAY:** The Display includes a clock and indicators to tell you time of day, cooking time settings and cooking functions selected.
- 2. POPCORN:** Touch this pad when popping popcorn in your microwave oven.
- 3. PIZZA:** Touch this pad to reheat 1 to 3 slices.
- 4. COOK:** Touch this pad to cook vegetables, rice, or casseroles.
- 5. POTATO:** Touch this pad to cook potatoes from 1 to 4ea.
- 6. VEGETABLE:** Touch this pad to cook vegetables. The oven's sensor will tell the oven how long to cook depending on the amount of humidity it detects from the vegetables.
- 7. REHEAT:** Touch this pad to reheat casserole, dinnerplate, soup/sauce.
- 8. MORE:** Touch this pad to add ten seconds of cooking time each time you press it.
- 9. CUSTOM COOK:** Touch this pad to recall one cooking instruction previously programmed into memory.
- 10. LESS:** Touch this pad to subtract ten seconds of cooking time each time you press.
- 11. AUTO DEFROST:** Meat, poultry, fish. Touch on pad to select food type and defrost food by weight.
- 12. EZ ON:** Touch this pad to set and start quickly at 100% power level.
- 13. NUMBER:** Touch number pads to enter cooking time, power level, quantities or weights.
- 14. CUSTOM SET:** Touch this pad to change the oven's default settings for sound, clock, display speed and defrost weight.
- 15. CLOCK:** Touch this pad to enter the time of day.
- 16. HOLD WARM:** Touch this pad to keep hot, cooked foods safety warm in your microwave oven for up to 99 minutes 99 seconds.
- 17. TIME COOK:** Touch this pad to set a cooking time.
- 18. POWER LEVEL:** Touch this pad to select a cooking power level.
- 19. HELP:** Touch this pad to learn how to use each oven function.
- 20. STOP/CLEAR:** Touch this pad to stop the oven or clear all entries.
- 21. START:** Touch this pad to start a function. If you open the door after oven begins to cook, retouch start.
- 22. KITCHEN TIMER:** Touch this pad to set the kitchen timer.
- 23. TURNTABLE ON/OFF:** Touch this pad to turn off the turntable. "OFF" will appear in the display.
- 24. LIGHT TIMER:** Touch this pad to set the light timer.
- 25. FAN HI/LOW/OFF:** Touch this pad to turn the fan on or off.
- 26. LIGHT HI/LOW/OFF:** Touch this pad to turn on the cooktop/countertop light.

# OPERATION

## LEARN ABOUT YOUR MICROWAVE OVEN

This section discusses the concepts behind microwave cooking and introduces you to the basics you need to know to operate your microwave oven. Please read this information before use.

### CLOCK

This oven includes a 24 hour clock.

**Example: To set 8:00 AM.**

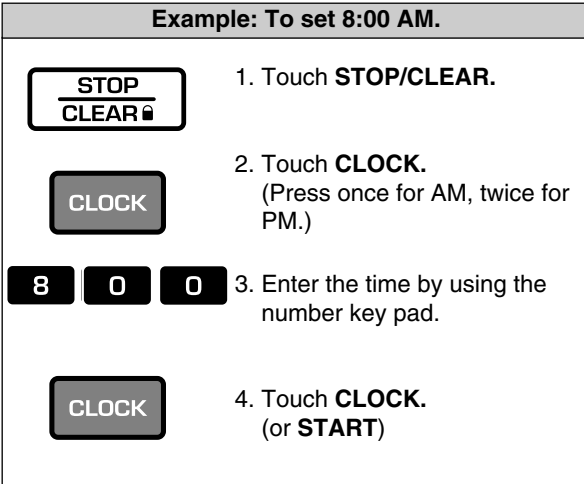

1. Touch **STOP/CLEAR**.

2. Touch **CLOCK**.  
(Press once for AM, twice for PM.)

3. Enter the time by using the number key pad.

4. Touch **CLOCK**.  
(or **START**)

### KITCHEN TIMER

You can use your microwave oven as a timer. Use the Timer for timing up to 99 minutes, 99 seconds.

**Example: To count 3 minutes.**

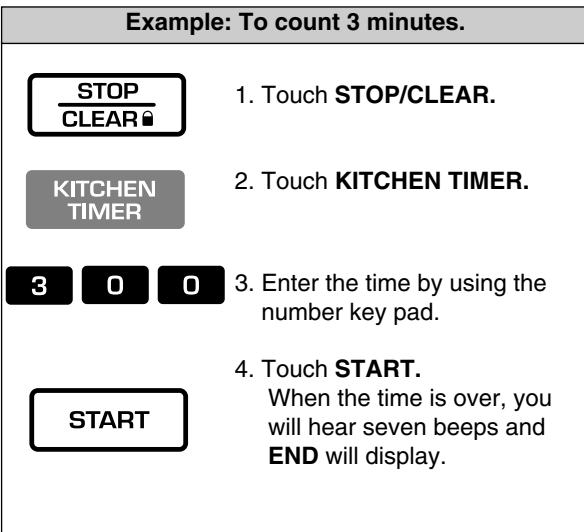

1. Touch **STOP/CLEAR**.

2. Touch **KITCHEN TIMER**.

3. Enter the time by using the number key pad.

4. Touch **START**.  
When the time is over, you will hear seven beeps and **END** will display.

### LIGHT TIMER

You can set the LIGHT to turn on and off automatically at any time you want. The light comes on at the same time every day until reset.

**Example: Turn on 2:00 AM, turn off 7:00 AM.**

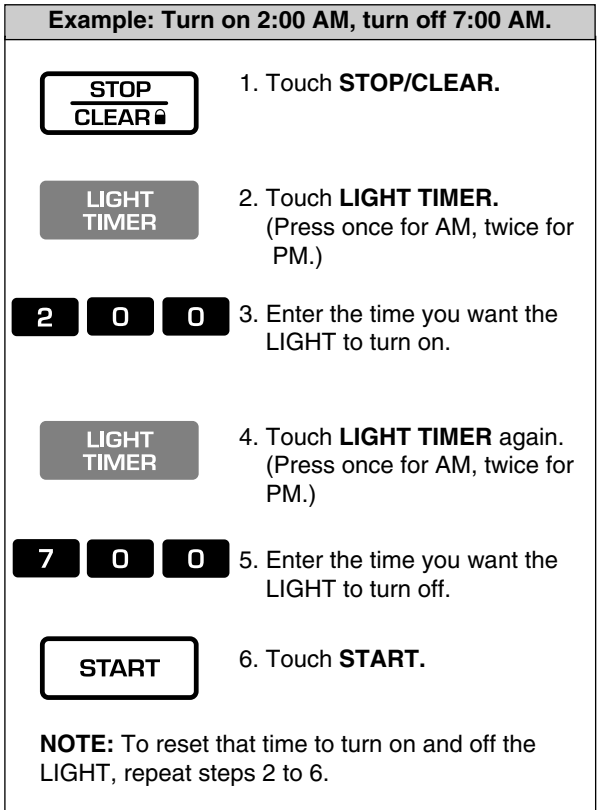

1. Touch **STOP/CLEAR**.

2. Touch **LIGHT TIMER**.  
(Press once for AM, twice for PM.)

3. Enter the time you want the LIGHT to turn on.

4. Touch **LIGHT TIMER** again.  
(Press once for AM, twice for PM.)

5. Enter the time you want the LIGHT to turn off.

6. Touch **START**.

**NOTE:** To reset that time to turn on and off the LIGHT, repeat steps 2 to 6.

**Example: To cancel the LIGHT TIMER.**

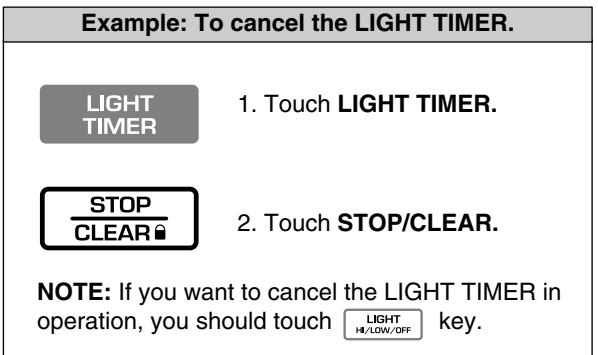

1. Touch **LIGHT TIMER**.

2. Touch **STOP/CLEAR**.

**NOTE:** If you want to cancel the LIGHT TIMER in operation, you should touch **LIGHT H/Low/OFF** key.

# OPERATION

## FAN HI / LOW / OFF



The FAN moves steam and other vapors from the surface cooking. Touch  once for High fan speed, twice for Low fan speed, or a three times to turn the fan off.

**NOTE:** If the temperature gets too hot around the microwave oven, the fan in the vent hood will automatically turn on at the LOW setting to cool the oven. It may stay on up to an hour to cool the oven. When this occurs, **you can not turn the fan off manually.**

## LIGHT HI / LOW / OFF



Touch  once for bright light, twice for the night light or three times to turn the light off.

## TURNTABLE ON / OFF



For best cooking results, leave the turntable on. It can be turned off for large dishes. Press  to turn the turntable on or off.

**NOTE:**

- Sometimes the turntable can become hot to touch. Be careful touching the turntable during and after cooking.
- Do not run the empty without food in it.

## CHILD LOCK

You may lock the control panel to prevent the microwave from being accidentally started or used by children.

### Example: To set the child lock.



1. Touch **STOP/CLEAR**.



2. Touch and hold **STOP/CLEAR** more than 4 seconds. **LOCKED** will appear in the display window with two beeps.

### Example: To cancel the child lock.



1. Touch and hold **STOP/CLEAR** more than 4 seconds. **LOCKED** will disappear and you hear two beeps. At this time the oven is ready.

## HELP

The HELP pad display feature information and helpful hints. Press HELP, then select a key pad.

### Example: To learn about POPCORN.



1. Touch **STOP/CLEAR**.



2. Touch **HELP**.



3. Touch **POPCORN**.

## HOLD WARM

You can safely keep hot, cooked food warm in your microwave oven for up to 99 minutes 99 seconds. You can use HOLD WARM by itself, or to automatically follow a cooking cycle.

### Example: To use the hold warm.



1. Touch **STOP/CLEAR**.



2. Touch **HOLD WARM**.



3. Touch **START**.

## NOTES:

- HOLD WARM operates for up to 99 minutes 99 seconds.
- Food cooked covered should be covered during HOLD WARM.
- Pastry items (pies, turnovers, etc.) should be uncovered during HOLD WARM.
- Complete meals kept warm on a dinner plate could be covered during HOLD WARM.

## To make HOLD WARM automatically follow another cycle:

- While you are programming the cooking instructions, touch HOLD WARM before touching START.
- When the last cooking cycle is over, you will hear two tones and "WARM" will appear in the oven display.
- You can set HOLD WARM to follow AUTO DEFROST, or multi-cycle cooking.

# OPERATION

## CUSTOM SET

You can change the default values for beep sound, clock, display speed and defrost weight. See following chart for more information.

| NUMBER | CUSTOM SET                 | NUMBER | RESULT       |
|--------|----------------------------|--------|--------------|
| 1      | Sound ON/OFF control       | 1      | Sound ON     |
|        |                            | 2      | Sound OFF    |
| 2      | Clock display control      | 1      | Clock ON     |
|        |                            | 2      | Clock OFF    |
| 3      | Display                    | 1      | Slow speed   |
|        |                            | 2      | Normal speed |
|        |                            | 3      | Fast speed   |
| 4      | Defrost weight mode select | 1      | Lbs          |
|        |                            | 2      | Kg           |

### Example: To change defrost weight mode. (from lbs to kg)

1. Touch **STOP/CLEAR**.
2. Touch **CUSTOM SET**.
3. Touch number **4**.
4. Touch number **2**.

## Ez On

A time-saving pad, this simplified control lets you quickly set and start microwave cooking without the need to touch **START**.

### Example: To set Ez On for 2 minutes.

**Ez-On**

Touch **Ez On** 4 times. The oven begins cooking and display shows time counting down.

### NOTE:

If you touch **Ez On**, it will add 30 seconds up to 3 minutes ; after 3 minutes every touch will add 1 minutes up to 99 min 59 seconds.

## CUSTOM COOK

CUSTOM COOK lets you to recall one cooking instruction previously placed in memory and begin cooking quickly.

### Example: To memorize for 2 minutes.

**STOP/CLEAR**

1. Touch **STOP/CLEAR**.

**CUSTOM COOK**

2. Touch **CUSTOM COOK**.

**2 0 0**

3. Enter the cook time.

**START**

4. Touch **START**.

### Example: To recall the memory.

**STOP/CLEAR**

1. Touch **STOP/CLEAR**.

**CUSTOM COOK**

2. Touch **CUSTOM COOK**.

**START**

3. Touch **START**.  
When the cook time is over, you will hear four beeps and **END** will display.

# OPERATION

## MORE / LESS

By using the MORE or LESS Keys, all of the pre-programmed cook and time cook and etc. can be adjusted to cook food for a longer or shorter time.

Pressing MORE will add 10 seconds of the cooking time each time you press it. Pressing LESS will subtract 10 seconds of cooking time each time you press it.

## COOKING AT HIGH COOK POWER

**Example: To cook food for 8 minutes 30 seconds.**



1. Touch **STOP/CLEAR**.



2. Enter the cook time.



3. Touch **START**.  
When the cook time is over, you will hear four beeps and **END** will display.

## COOKING AT LOWER POWER LEVELS

HIGH power cooking does not always give you the best results with foods that need slower cooking, such as roasts, baked goods, or custards. Your oven has 9 power settings in addition to "HIGH".

**Example: To cook food for 7 minutes 30 seconds at 70% power.**



1. Touch **STOP/CLEAR**.



2. Enter the cook time.



3. Touch **POWER LEVEL**.



4. Enter the power level.



5. Touch **START**.  
When the cook time is over, you will hear four beeps and **END** will display.

# OPERATION

## COOKING GUIDE FOR “LOWER POWER LEVELS”

The nine power levels in addition to “HIGH” allow you to choose the best power level for the food you are cooking. Below are listed all the power levels,

examples of foods best cooked at each level, and the amount of microwave power you are using.

| POWER LEVEL  | MICROWAVE OUTPUT | USE   |
|--------------|------------------|---|
| 10<br>“HIGH” | 100%             | <ul style="list-style-type: none"> <li>• Boil water.</li> <li>• Cook ground beef.</li> <li>• Make candy.</li> <li>• Cook fresh fruits and vegetables.</li> <li>• Cook fish, and poultry.</li> <li>• Preheat browning dish.</li> </ul> |
| 9            | 90%              | <ul style="list-style-type: none"> <li>• Reheat meat slices quickly.</li> <li>• Saute onions, celery, and green pepper.</li> </ul>  |
| 8            | 80%              | <ul style="list-style-type: none"> <li>• All reheating.</li> <li>• Cook scrambled eggs.</li> </ul>  |
| 7            | 70%              | <ul style="list-style-type: none"> <li>• Cook breads and cereal products.</li> <li>• Cook cheese dishes, veal.</li> <li>• Cook cakes, muffins, brownies, cup cakes.</li> </ul>  |
| 6            | 60%              | <ul style="list-style-type: none"> <li>• Cook pasta.</li> </ul>   |
| 5            | 50%              | <ul style="list-style-type: none"> <li>• Cook meats, whole poultry.</li> <li>• Cook custard.</li> <li>• Cook whole chicken, turkey, spare ribs, rib roast, sirloin roast.</li> </ul>  |
| 4            | 40%              | <ul style="list-style-type: none"> <li>• Cook less tender cuts of meat.</li> <li>• Reheat frozen convenience foods.</li> </ul>  |
| 3            | 30%              | <ul style="list-style-type: none"> <li>• Thawing meat, poultry, and seafood.</li> <li>• Cooking small quantities of food.</li> <li>• Finish cooking casserole, stew, and some sauces.</li> </ul>                                      |
| 2            | 20%              | <ul style="list-style-type: none"> <li>• Soften butter and cream cheese.</li> <li>• Heating small amounts of food.</li> </ul>   |
| 1            | 10%              | <ul style="list-style-type: none"> <li>• Soften ice cream.</li> <li>• Raise yeast dough.</li> </ul>   |
| 0            |                  | <ul style="list-style-type: none"> <li>• Standing time.</li> </ul>  |

# OPERATION

## SENSOR OPERATING INSTRUCTIONS

Sensor touch allows you to cook most of your favorite foods without selecting cooking times and power levels. The display will indicate "SENSING" during the initial sensing period. The oven automatically determines required cooking time for each food item. When the internal sensor detects a certain amount of humidity coming from the food, it will tell the oven how much longer to heat. The display will show the remaining heating time. For best results by Sensor, following these recommendation.

1. Food cooked with the sensor system should be at normal storage temperature.
2. Glass Tray and outside of container should be dry to assure best cooking results.
3. Foods should always be covered loosely with microwavable plastic wrap, waxed paper or a lid.
4. Do not open the door or touch the "STOP/CLEAR" key during the sensing time. When sensing time is over, the oven beeps twice and the remaining cooking time will appear in the display window. At this time you can open the door to stir, turn or rearrange the food.

## SENSOR COOKING GUIDE

Appropriate containers and coverings help assure good Sensor cooking results.

1. Always use microwavable containers and cover them with lids or vented plastic wrap.
2. Never use tight-sealing plastic covers. They can prevent steam from escaping and cause food to overcook.
3. Match the amount of the size of the container. Fill containers at least half full for best results.
4. Be sure the outside of the cooking container and the inside of the microwave oven are dry before placing food in the oven. Beads of moisture turning into steam can mislead the sensor.

# OPERATION

## ADDING OR SUBTRACTING COOK TIME

If the **SENSOR** function is too long or too short, you can increase or decrease the cook time by 10% after choosing the function.

**Example: If you want to adjust the Sensor Cook (casserole) cooking time for longer time.**

**STOP  
CLEAR**

1. Touch **STOP/CLEAR**.

**COOK**

2. Touch **COOK**.

**2**

3. Choose food category.

**9**

4. Touch number **9**.

| Cook time | Touch pad number |
|-----------|------------------|
| Less      | 7                |
| Normal    | 8                |
| More      | 9                |

When popping commercially packaged popcorn, **Remove the rack from the oven**; Do not place the bag of microwave popcorn on the rack or under the rack.

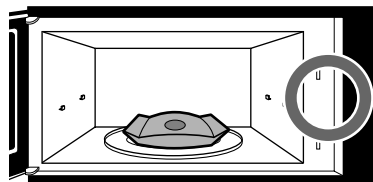
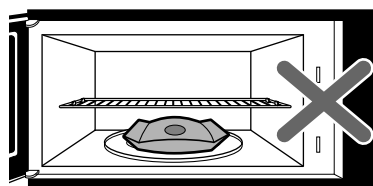
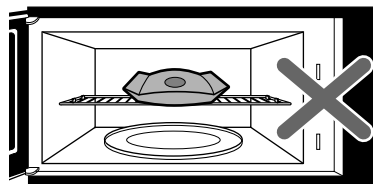

## POPCORN

**POPCORN** lets you pop commercially packaged microwave popcorn. Pop only one package at a time. For best results, use fresh bags of popcorn.

**Example: To pop 3.5 oz.**

**STOP  
CLEAR**

1. Touch **STOP/CLEAR**.

**POPCORN**

2. Touch **POPCORN**.  
When the cook time is over, you will hear four beeps and **END** will display.

**CAUTION:** Do not leave microwave unattended while popcorn.

## VEGETABLE

**VEGETABLE** has preset cook powers for 3 food categories: **Fresh, Frozen and Canned**.

**Example: To Cook Frozen Vegetable.**

**STOP  
CLEAR**

1. Touch **STOP/CLEAR**.

**VEGETABLE**

2. Touch **VEGETABLE**.

**2**

3. Choose food category.

| Category | Touch pad number |
|----------|------------------|
| Fresh    | 1                |
| Frozen   | 2                |
| Canned   | 3                |

When the cook time is over, you will hear four beeps and **END** will display.



# OPERATION

## POTATO

Cooking with POTATO lets you bake one or several potatoes without selecting cooking times and power levels.

### NOTE:

- **Before baking**, pierce potato with fork several times.
- **After baking**, let stand for 5 minutes wrapped.

### Example: To cook 2 potatoes.



1. Touch **STOP/CLEAR**.



2. Touch **POTATO**.  
When the cook time is over, you will hear four beeps and **END** will display.

## PIZZA

Reheating pizza with PIZZA lets you reheat one or several slices of pizza without selecting cooking times and power levels.

### Example: To reheat 2 slices of pizza.



1. Touch **STOP/CLEAR**.



2. Touch **PIZZA**.  
When the cook time is over, you will hear four beeps and **END** will display.

## COOK

Using COOK lets you heat common microwave-prepared foods without needing to program times and Cook Powers. Sensor Cook has preset Cook Power for 3 food categories: **Frozen Entree, Casserole and Rice**.

### Example: To cook Rice.



1. Touch **STOP/CLEAR**.



2. Touch **COOK**.



3. Choose food category.

| Category      | Touch pad number |
|---------------|------------------|
| Frozen Entree | 1                |
| Casserole     | 2                |
| Rice          | 3                |

When the cook time is over, you will hear four beeps and **END** will display.

## REHEAT

REHEAT lets you heat foods without needing to program times and Cook Powers.

REHEAT has preset Cook Powers for 3 categories: **Casserole, Dinner Plate and Soup/Sauce**.

### Example: To reheat Casserole.



1. Touch **STOP/CLEAR**.



2. Touch **REHEAT**.



3. Choose food category.

| Category     | Touch pad number |
|--------------|------------------|
| Casserole    | 1                |
| Dinner Plate | 2                |
| Soup/Sauce   | 3                |

When the cook time is over, you will hear four beeps and **END** will display.

# OPERATION

## AUTO DEFROST

Your microwave oven is preset with three defrost sequences. Using AUTO DEFROST is the best way to defrost frozen foods. The Auto Defrost Sequence Table below provides some basic guidelines for using the three defrost sequences.

### Example: To defrost 1.2 lbs of ground beef.

**STOP  
CLEAR**

1. Touch **STOP/CLEAR**.

**AUTO  
DEFROST**

2. Touch **AUTO DEFROST**.

**1**

3. Choose food category.

| Category | Touch pad number |
|----------|------------------|
| Meat     | 1                |
| Poultry  | 2                |
| Fish     | 3                |

**1**

**2**

4. Enter the weight.

**START**

5. Touch **START**.

6. After 1/3 of the defrost time is over, The display will prompt you to turn over food. Open door, turn over food, and shield any warm portions.

**START**

7. Close the door and restart.

8. After 2/3 of the defrost time is over, the display will prompt you to turn over food. Repeat steps 6 and 7. When the defrost time is over, you will hear four beeps and **END** will display.

**NOTE:** If you do not open the door, the display will resume the countdown.

## Weight conversion chart

You are probably used to food weights as being in pounds and ounces that are fractions of a pound (for example 4 ounces equals 1/4 pound).

However, in order to enter food weight in AUTO DEFROST, you must specify pounds and tenths of a pound. If the weight on the food package is in fractions of a pound, you can use the following chart to convert the weight to decimals.

| EQUIVALENT<br>OUNCE WEIGHT | NUMBER AFTER<br>DECIMAL  |
|----------------------------|--------------------------|
| 1.6                        | .10                      |
| 3.2                        | .20                      |
| 4.0                        | .25 One-Quarter Pound    |
| 4.8                        | .30                      |
| 6.4                        | .40                      |
| 8.0                        | .50 One- Half Pound      |
| 9.6                        | .60                      |
| 11.2                       | .70                      |
| 12.0                       | .75 Three-Quarters Pound |
| 12.8                       | .80                      |
| 14.4                       | .90                      |
| 16.0                       | 1.00 One Pound           |

## DEFROSTING TIPS

- When using AUTO DEFROST, the weight to be entered is the net weight in pounds and tenths of pounds (the weight of the food minus the container).
- Only use AUTO DEFROST for raw food. AUTO DEFROST gives best results when food to be thawed is a minimum of 0°F (taken directly from a "true" freezer). If food has been stored in a refrigerator-freezer that does not maintain a temperature of 5°F or below, always program a lower food weight (for a shorter defrosting time) to prevent cooking the food.
- If the food is stored outside the freezer for up to 20 minutes, enter a lower food weight.
- The shape of the package alters the defrosting time. Shallow rectangular packets defrost more quickly than a deep block.
- Separate pieces as they begin to defrost. Separated pieces defrost more easily.
- You can use small pieces of aluminum foil to shield foods like chicken wings, leg tips, and fish tails, but the foil must not touch the side of the oven. Foil can damage the oven lining.
- Shield areas of food with small pieces of foil if they start to become warm.
- For better results, a preset standing time is included in the defrosting time.

# OPERATION

## AUTO DEFROST CHART

### Meat setting

| FOOD                            | SETTING | AT BEEP   | SPECIAL INSTRUCTIONS   |
|---------------------------------|---------|---|--|
| <b>BEEF</b>                     |         |   | Meat of irregular shape and large, fatty cuts of meat should have the narrow or fatty areas shielded with foil at the beginning of a defrost sequence. |
| Ground beef (bulk)              | MEAT    | Remove thawed portions with fork. Turn over. Return remainder to oven.          | Do not defrost less than 1/4 lb. Freeze in doughnut shape.   |
| Ground beef (patties)           | MEAT    | Separate and rearrange.   | Do not defrost less than two oz.patties. Depress center when freezing.   |
| Round steak                     | MEAT    | Turn over. Cover warm areas with aluminum foil.                                 | Place on a microwavable roasting rack.   |
| Tenderloin steak                | MEAT    | Turn over. Cover warm areas with aluminum foil.                                 | Place on a microwavable roasting rack.   |
| Stew beef                       | MEAT    | Remove thawed portions with fork. Separate remainder. Return remainder to oven. | Place in a microwavable baking dish.   |
| Pot roast, chuck roast          | MEAT    | Turn over. Cover warm areas with aluminum foil.                                 | Place on a microwavable roasting rack.   |
| Rib roast                       | MEAT    | Turn over. Cover warm areas with aluminum foil.                                 | Place on a microwavable roasting rack.   |
| Rolled rump roast               | MEAT    | Turn over. Cover warm areas with aluminum foil.                                 | Place on a microwavable roasting rack.   |
| <b>LAMB</b>                     |         |   |  |
| Cubes for stew                  | MEAT    | Remove thawed portions with fork. Return remainder to oven.                     | Place in a microwavable baking dish.   |
| Chops (1 inch thick)            | MEAT    | Separate and rearrange.   | Place on a microwavable roasting rack.   |
| <b>PORK</b>                     |         |   |  |
| Chops (1 inch thick)            | MEAT    | Separate and rearrange.   | Place on a microwavable roasting rack.   |
| Hot dogs                        | MEAT    | Separate and rearrange.   | Place on a microwavable roasting rack.   |
| Spareribs<br>Country style ribs | MEAT    | Turn over. Cover warm areas with aluminum foil.                                 | Place on a microwavable roasting rack.   |
| Sausage, links                  | MEAT    | Separate and rearrange.   | Place on a microwavable roasting rack.   |
| Sausage, bulk                   | MEAT    | Remove thawed portions with fork. Turn over. Return remainder to oven.          | Place in a microwavable baking dish.   |
| Loin roast, boneless            | MEAT    | Turn over. Cover warm areas with aluminum foil.                                 | Place on a microwavable roasting rack.   |

# OPERATION

## AUTO DEFROST CHART (continued)

### Poultry setting

| FOOD                         | SETTING | AT BEEP  | SPECIAL INSTRUCTIONS   |
|------------------------------|---------|--|--|
| <b>CHICKEN</b><br>Whole      | POULTRY | Turn over (finish defrosting breast-side down). Cover warm areas with aluminum foil. | Place chicken breast-side-up on a microwavable roast rack. Finish defrosting by immersing in cold water. Remove giblets when chicken is partially defrosted. |
| Cut-up                       |         | Turn over. Cover warm areas with aluminum foil. Separate pieces and rearrange.       | Place on a microwavable roasting rack. Finish defrosting by immersing in cold water.   |
| <b>CORNISH HENS</b><br>Whole | POULTRY | Turn over. Cover warm areas with aluminum foil.                                      | Place on a microwavable roasting rack. Finish defrosting by immersing in cold water.   |
| <b>TURKEY</b><br>Breast      | POULTRY | Turn over. Cover warm areas with aluminum foil.                                      | Place on a microwavable roasting rack. Finish defrosting by immersing in cold water.   |

### Fish setting

| FOOD                         | SETTING | AT BEEP  | SPECIAL INSTRUCTIONS  |
|------------------------------|---------|--|---|
| <b>FISH</b><br>Fillets       | FISH    | Turn over. Separate fillets when partially thawed if possible. | Place in a microwavable baking dish. Carefully separate fillets under cold water.   |
| Steaks                       | FISH    | Separate and rearrange.  | Place in a microwavable baking dish. Run cold water over to finish defrosting.  |
| Whole                        | FISH    |  | Place in a microwavable baking dish. Cover head and tail with foil; do not let foil touch sides of microwave. Finish defrosting by immersing in cold water. |
| <b>SHELLFISH</b><br>Crabmeat | FISH    | Break apart.   | Place in a microwavable baking dish.  |
| Lobster tails                | FISH    | Rearrange.   | Place in a microwavable baking dish.  |
| Shrimp                       | FISH    | Separate and rearrange.  | Place in a microwavable baking dish.  |
| Scallops                     | FISH    | Separate and rearrange.  | Place in a microwavable baking dish.  |

**NOTE :** Food to be defrosted must be not more than 6.0 lbs.

\* Available weight is 0.1~6.0 lbs.

# COOKING

## GETTING THE BEST COOKING RESULTS

To get the best results from your microwave oven, read and follow the guidelines below.

- **Storage Temperature:** Foods taken from the freezer or refrigerator take longer to cook than the same foods at room temperature. The time for recipes in this book is based on the normal storage temperature of the food.
- **Size:** Small pieces of food cook faster than large ones, pieces similar in size and shape cook more evenly. For even cooking, reduce the power when cooking large pieces of food.
- **Natural Moisture:** Very moist foods cook more evenly because microwave energy is attracted to water molecules.
- **Stir** foods such as casseroles and vegetables from the outside to the center to distribute the heat evenly and speed cooking. Constant stirring is not necessary.
- **Turn over** foods like pork chops, baking potatoes, roasts, or whole cauliflower halfway through the cooking time to expose all sides equally to microwave energy.
- **Place** delicate areas of foods, such as asparagus tips, toward the center of the dish.
- **Arrange** unevenly shaped foods, such as chicken pieces or salmon steaks, with the thicker, meatier parts toward the outside of the dish.
- **Shield**, with **Small** pieces of aluminum foil, parts of food that may cook quickly, such as wing tips and leg ends of poultry.
- **Let It Stand:** After you remove the food from the microwave, cover food with foil or casserole lid and let it stand to finish cooking in the center and avoid overcooking the outer edges. The length of standing time depends on the density and surface area of the food.
- **Wrapping in waxed paper or paper towel:** Sandwiches and many other foods containing prebaked bread should be wrapped prior to microwaving to prevent drying out.

## Fish & Shellfish

### Cooking Fish and Shellfish: General Directions

- Prepare the fish for cooking.
  - Completely defrost the fish or shellfish.
  - Arrange unevenly shaped pieces with thicker parts toward the outside of the dish. Arrange shellfish in a single layer for even cooking.
  - The type of cover you use depends on how you cook. Poached fish needs a microwavable lid or **vented** plastic wrap.
  - Baked fish, coated fish, or fish in sauce needs to be covered lightly with waxed paper to keep the coating crisp and sauce from getting watery.
- Always set the shortest cooking time. Fish is done when it turns opaque and the thickest part begins to flake. Shellfish is done when the shell turns from pink to red and the flesh is opaque and firm.
- The Fish and Shellfish Cooking Table below provides specific directions with Power Level and Cooking Time settings for most types of fish and shellfish.

### Fish And Shellfish Cooking Table

| FISH            | POWER LEVEL | COOKING TIME        | DIRECTIONS  |
|-----------------|-------------|---------------------|---|
| Fish fillets    | HI          | 3 1/2-4 1/2 minutes | Arrange fish in a single layer with thickest portion toward outside edge of 1 1/2 quart microwavable baking dish. Brush with melted butter and season, if desired. Cook covered with vented plastic wrap. Let stand covered 2 minutes. If you are cooking more than 1 lb. of fish, turn the fish halfway through cooking. |
| Fish steaks     | HI          | 4 1/2-5 1/2 minutes |   |
| Whole fish      | 7           | 4 1/2-6 minutes     |   |
| Scallops        | HI          | 3 1/2-5 minutes     | Arrange in a single layer. Prepare as directed above, except stir instead of turning the shellfish.   |
| Shrimp, shelled | HI          | 3 1/2-5 minutes     |   |

# COOKING

## Appetizers / Sauces / Soups

### Cooking Appetizers: Tips and Techniques

#### Recommended

- crackers, such as melba toast, shredded wheat, and crisp rye crackers are best for microwave use. Wait until party time to add the spreads. Place a paper towel under the crackers while they cook in the microwave oven to absorb extra moisture.
- Arrange individual appetizers in a circle for even cooking.
- Stir dips to distribute heat and shorten cooking time.

### Cooking Sauces: Tips and Techniques

- Use a microwavable casserole or glass measuring cup that is at least 2 or 3 times the volume of the sauce.
- Sauces made with cornstarch thicken more rapidly than those made with flour.

### Cooking Soups: Tips and Techniques

- Cook soups in a microwavable dish which holds double the volume of the recipe ingredients to prevent boil-over, especially if you use cream or milk in the soup.
- Generally, cover microwaved soups with VENTED plastic wrap or a microwavable lid.
- Cover foods to retain moisture. Uncover foods to retain crispness.
- Avoid overcooking by using the minimum suggested time. Add more time, if necessary, only after checking the food.

### Not Recommended

- Appetizers with a crisp coating or puff pastry are best done in a conventional oven with dry heat.
- Breaded products can be warmed in the microwave oven but will not come out crisp.
- Cook sauces made with cornstarch or flour uncovered so you may stir them 2 or 3 times during cooking for a smooth consistency.
- To adapt a conventional sauce or gravy recipe, reduce the amount of liquid slightly.
- Stirring occasionally will help blend flavors, distribute heat evenly, and may even shorten the cooking time.
- When converting a conventional soup recipe to cook in the microwave, reduce the liquid, salt, and strong seasonings.

## Meat

### Cooking Meat: General Directions

- Prepare the meat for cooking.
  - Defrost completely.
  - Trim off excess fat to avoid splattering.
  - Place the meat, fat side down, on a microwavable rack in a microwavable dish.
  - Use oven cooking bag for less tender cuts of meat.
  - Arrange the meat so that thicker portions are toward the outside of the dish.
  - Cover the meat with waxed paper to prevent splattering.
- Tend the meat as it cooks.
  - Drain juices as they accumulate to reduce splattering and keep from overcooking the bottom of the meat.
  - Shield thin or bony portions with strips of foil to prevent overcooking.

**NOTE:** Keep the foil **at least 1 inch** from the oven walls, and do not cover more than one-third of the meat with foil at any one time.

- Let the meat stand covered with foil 10-15 minutes after you remove it from the oven. The internal temperature of the meat may rise from 5-10°F during standing time.

The Meat Cooking Table on the next page provides detailed directions, Power Level, and Cooking Time settings for most cuts of meat.

# COOKING

## Meat Cooking Table

| MEAT   | POWER LEVEL | COOKING TIME   | DIRECTIONS  |
|--|-------------|--|---|
| Beef Hamburgers, Fresh or defrosted (4 oz. each)<br>1 patty<br>2 patties<br>4 patties                              | HI          | 1-1½ minutes<br>1½-2 minutes<br>2½-3½ minutes  | Form patties with depression in center of each. Place on microwavable roast rack. Brush with browning agent, if desired. Cover with waxed paper. Turn over halfway through cooking. Let stand covered 1 minute.   |
| Sirloin tip roast (3-4 lbs.)   | 5           | 8-10 minutes per pound<br>RARE(135°F)<br>11-13 minutes per pound<br>MEDIUM(155°F)  | Place roast fat side down on microwavable roast rack. Add desired seasonings and cover with waxed paper. Turn meat over halfway through cooking and shield if necessary. Remove roast from microwave oven when desired temperature is reached. Let stand covered with foil 15 minutes.(Temperature may rise about 10°F).  |
| Lamb Lamb roast, rolled boneless (3-4 lbs.)  | 5           | 11-12 minutes per pound<br>RARE(135°F)<br>12-13 minutes per pound<br>MEDIUM(145°F)<br>13-14 minutes per pound<br>WELL(155°F) | Place roast fat side down on microwavable roast rack. Brush lamb with marinade or desired seasonings such as rosemary, thyme or marjoram. Cover with waxed paper. Turn roast over after 15 minutes, and again after 30 minutes. Shield if necessary. Remove roast from microwave when desired temperature is reached. Let stand covered with foil 15 minutes (Temperature may rise about 10°F). |
| Pork Bacon slices<br>2 slices<br>4 slices<br>6 slices  | HI          | 1½-2 minutes<br>2½ -3 minutes<br>3½-4½ minutes   | Place bacon slices on microwavable roast rack. Cover with paper towels. After cooking, let stand 1 minute.  |
| Chops (5-7 oz. each)<br>2 chops<br>4 chops   | 3           | 18-20 minutes per pound<br>15-17 minutes per pound   | Place chops in microwavable baking dish. Add desired seasonings and cover with vented plastic wrap. Cook until no longer pink or until internal temperature reaches 170°F. Turn chops over halfway through cooking. Let stand covered 5 minutes. (Temperature may rise about 10°F).   |
| Loin Roast, rolled, boneless (3 ½- 4 ½ lbs.)   | 3           | 25-27 minutes per pound (165°F)  | Place roast in cooking bag in microwavable dish. Add seasonings and browning agent if desired. Close bag loosely with microwavable closure or string. After cooking, let stand in bag 15 minutes. (Temperature may rise about 10°F.) Internal temperature of pork should reach 170°F before serving.  |
| Sausage links, Fresh or Frozen, defrosted (1-2 oz. each)<br>2 links<br>4 links<br>6 links<br>10 links (8 oz. pkg.) | HI          | 45-60 seconds<br>1-1½ minutes<br>1½-2 minutes<br>1¾-2 minutes  | Pierce links and place on microwavable roast rack. Cover with waxed paper or paper towel. Turn over halfway through cooking. After cooking, let stand covered 1 minute.   |

# COOKING

## Poultry

### Cooking Poultry: General Directions

- Prepare the poultry for cooking.
  - Defrost completely.
  - Arrange poultry pieces with thicker pieces at the outside edge of the baking dish. When cooking legs, arrange them like the spokes of a wheel.
  - Cover the baking dish with waxed paper to reduce splattering.
  - Use a browning agent or cook with a sauce to give a browned appearance.
- Tend the poultry as it cooks.
  - Drain and discard juices as they accumulate.
  - Shield thin or bony pieces with small strips of aluminum foil to prevent overcooking. Keep foil **at least 1 inch** from the oven walls and other pieces of foil.
- The poultry is done when it is no longer pink and the juices run clear. When done, the temperature in the thigh meat should be 180-185°F.
- Let the poultry stand after cooking covered with foil for 10 minutes.

The Poultry Cooking Table below provides detailed directions, Power Level, and Cooking Time settings for most cuts and types of poultry.

### Poultry Cooking Table

| POULTRY  | POWER LEVEL | COOKING TIME   | DIRECTIONS  |
|--|-------------|--|---|
| Chicken pieces (2 <sup>1</sup> / <sub>2</sub> -3 lbs).         | HI          | 4 <sup>1</sup> / <sub>2</sub> -5 <sup>1</sup> / <sub>2</sub> minutes per pound | Wash, shake the water off, and go on with cooking. Place pieces in a single layer in a microwavable baking dish with thicker pieces to the outside. Brush with butter or browning agent and seasonings if desired. Cover with waxed paper. Cook until no longer pink and juices run clear. Let stand covered 5 minutes.   |
| Chicken whole (3-3 <sup>1</sup> / <sub>2</sub> lbs)            | HI          | 12-13 minutes per pound  | Wash, shake the water off, and go on with cooking. Place breast side down on a microwavable roast rack. Brush with butter, or browning agent and seasoning if desired. Cover with waxed paper. Cook 1/3 of estimated time. Turn breast side up, brush with butter, or browning agent. Replace waxed paper. Cook 1/3 of estimated time again. Shield if necessary. Cook remaining 1/3 of estimated time or until no longer pink and juices run clear. Let stand covered with foil 10 minutes. (The temperature may rise about 10°F.) The temperature in the high should be 180°F-185°F when the poultry is done. |
| Cornish Hens Whole (1-1 <sup>1</sup> / <sub>2</sub> lbs. each) | HI          | 6-7 minutes per pound  | Wash, shake the water off, and go on with cooking. Tie wings to body of hen and the legs to tail. Place hens breast side down on microwavable rack. Cover with waxed paper. Turn breast side up halfway through cooking. Shield bone ends of drumsticks with foil. Remove and discard drippings. Brush with butter or browning agent and seasonings if desired. Cook until no longer pink and juices run clear. Remove hens from microwave when they reach desired temperature. Let stand covered with foil 5 minutes. (Temperature may rise about 10°F). Temperature in breast should be 170°F before serving. |



# COOKING

## Pasta And Rice

Microwave cooking and conventional cooking of pasta, rice, and cereal require about the same amount of time, but the microwave is a more convenient method because you can cook and serve in the same dish.

There is no stirring needed and leftover pasta tastes just like fresh cooked when reheated in the microwave oven.

### Cooking Pasta and Rice: Tips and Techniques

- If you are planning to use rice or pasta in a casserole, undercook it so it is still firm.
- Allow for standing time with rice, but not for pasta.
- The Pasta and Rice Cooking Tables below provide specific directions, with Power Level and Cooking Time settings for most common types of pasta and rice.

### Pasta Cooking Table

| TYPE OF PASTA  | POWER LEVEL | COOKING TIME                              | DIRECTIONS   |
|--|-------------|---|--|
| Spaghetti<br>4 cups water.<br>Add 8 oz. spaghetti.             | HI<br>5     | 9 to 10 minutes<br>7 1/2 to 8 1/2 minutes | Combine hot tap water and salt, if desired. Use a 2-quart microwavable baking dish and cover with vented plastic wrap for spaghetti and lasagna noodles. Use microwavable lid or vented plastic wrap for macaroni and egg noodles. Cook at Power Level HI as directed in chart or until water boils. Stir in pasta; cook covered at Power Level 5 as directed in chart or until tender. Drain in a colander. |
| Macaroni<br>3 cups water.<br>Add 2 cups macaroni.              | HI<br>5     | 6 to 7 minutes<br>5 1/2 to 6 1/2 minutes  |  |
| Lasagna noodles<br>4 cups water.<br>Add 8 oz. lasagna noodles. | HI<br>5     | 7 to 8 minutes<br>11 to 12 1/2 minutes    |  |
| Egg noodles<br>6 cups water.<br>Add 4 cups noodles.            | HI<br>5     | 8 to 10 minutes<br>5 1/2 to 6 1/2 minutes |  |

### Rice Cooking Table

| TYPE OF RICE  | POWER LEVEL | COOKING TIME                         | DIRECTIONS  |
|---|-------------|--------------------------------------|---|
| Long grain<br>2 1/4 cups water.<br>Add 1 cup rice.                  | HI<br>5     | 4 1/2 to 5 1/2 minutes<br>14 minutes | Combine hot tap water and salt, if desired, in 2 quart microwavable casserole. Cover with microwavable lid or vented plastic wrap. Cook as directed in chart at Power Level HI or until water boils. Stir in rice and any seasonings. Cook covered as directed in chart at Power Level 5 or until water is absorbed and rice is tender. Let stand covered 5 to 10 minutes. Fluff with fork. |
| Brown<br>2 1/2 cups water.<br>Add 1 cup rice.                       | HI<br>5     | 4 1/2 to 5 1/2 minutes<br>28 minutes |   |
| Long grain and wild rice mix<br>2 1/3 cups water.<br>Add 6 oz. pkg. | Hi<br>5     | 4 to 5 minutes<br>24 minutes         |   |
| Quick cooking<br>1 cup water.<br>Add 1 cup rice.                    | HI          | 2 to 3 minutes                       | Cook water until it boils. Stir rice into boiling water and let stand, covered 5 to 10 minutes or until water is absorbed and rice is tender. Fluff with fork.  |

# MAINTENANCE

## CARE AND CLEANING

For best performance and safety, keep the oven clean inside and outside. Take special care to keep the inner door panel and the oven front frame free of food or grease build-up.

**Never use rough powder or pads.** Wipe the microwave oven inside and out, including the hood bottom cover, with a soft cloth and a warm(not hot) mild detergent solution. Then rinse and wipe dry. Use a chrome cleaner and polish on chrome, metal and aluminum surfaces. Wipe spatters immediately with a wet paper towel, especially after cooking chicken or bacon. Clean your oven weekly or more often, if needed.

## METAL RACK

Wash the metal rack with a mild soap and a soft or nylon scrub brush. Dry completely. Do not use abrasive scrubbers or cleaners to clean rack.

## CLEANING THE GREASE FILTERS

The grease filters should be removed and cleaned often, at least once a month.

1. To remove grease filters, slide each filter to the side. Pull filters downward and push to the other side. The filter will drop out.

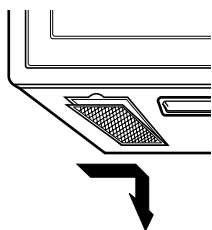

2. Soak grease filters in hot water and a mild detergent. Rinse well and shake to dry. **Do not use ammonia or place in a dishwasher. The aluminum will darken.**

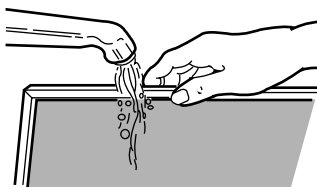

3. To reinstall the filters, slide it into the side slot, then push up and toward oven center to lock.

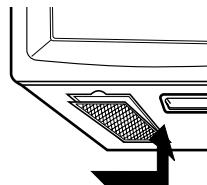

NOTE: **Do not** operate the hood without the filters in place.

## CHARCOAL FILTER REPLACEMENT

If your oven is vented inside, the charcoal filter should be replaced every 6 to 12 months, and more often if necessary. The charcoal filter cannot be cleaned. To order a new charcoal filter, contact the Service Center.

1. Remove the two vent grille mounting screws.  
(2 middle screws)
2. Tip the grille forward, then lift it out

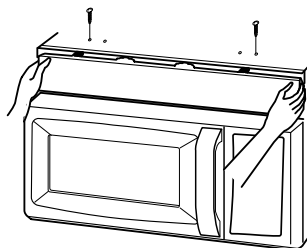

3. Open the door.
4. Push the hook and remove old filter.

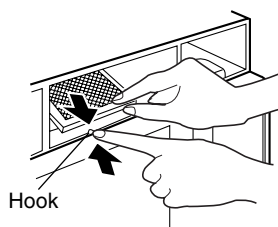

5. Slide a new charcoal filter into place and close the door. The filter should rest at the angle shown and set the clock.

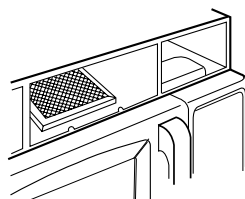

6. Slide the bottom of the vent cover into place. Push the top until it snaps into place. Replace the mounting screws. Turn the power back on at the main power supply and set the clock.

# MAINTENANCE

## COOKTOP/NIGHT LIGHT REPLACEMENT

1. Unplug oven or turn off power at the main power supply.
2. Remove the bulb cover mounting screws.

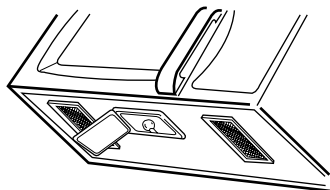

3. Replace bulb with 30 watt appliance bulb.
4. Replace bulb cover, and mount screw.
5. Turn the power back on at the main power supply.

## OVEN LIGHT REPLACEMENT

1. Unplug oven or turn off power at the main power supply.
2. Remove the vent cover mounting screws. (2 middle screws)
3. Tip the cover forward, then lift out to remove.

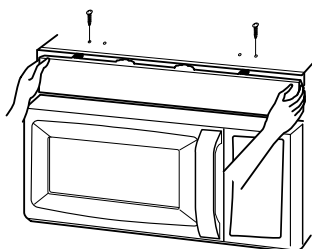

4. Lift up the bulb holder.

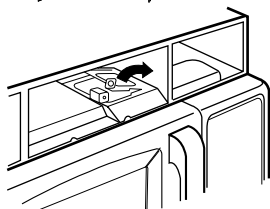
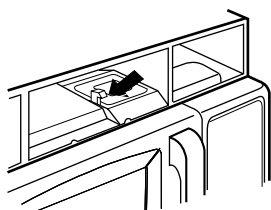

5. Replace bulb with a 30 watt appliance bulb.
6. Replace the bulb holder.
7. Slide the top of the vent cover into place. Push the bottom until it snaps into place. Replace the mounting screws. Turn the power back on at the main power supply.

## QUESTIONS AND ANSWERS

### Q. Can I use a rack in my microwave oven so that I may reheat or cook in two levels at a time?

- A. Only use the rack that is supplied with your microwave oven. Use of any other rack can result in poor cooking performance and/or arcing and may damage your oven.

### Q. Can I use either metal or aluminum pans in my microwave oven?

- A. Usable metal includes aluminum foil for shielding (use small, flat pieces), and shallow foil trays (if tray is 3/4 inch deep and filled with food to absorb microwave energy). Never allow metal to touch walls or door.

### Q. Sometimes the door of my microwave oven appears wavy. Is this normal?

- A. This appearance is normal and does not affect the operation of your oven.

### Q. What are the humming noises that I hear when my microwave oven is operating?

- A. You hear the sound of the transformer when the magnetron tube cycles on and off.

### Q. Why does the dish become hot when I microwave food in it? I thought that this should not happen.

- A. As the food becomes hot it will conduct the heat to the dish. Use hot pads to remove food after cooking.

### Q. What does "standing time" mean?

- A. "Standing time" means that food should be taken out of the oven and covered for additional time after cooking. This process allows the cooking to finish, saves energy and frees the oven for other purpose.

### Q. Can I pop popcorn in my microwave oven? How do I get the best results?

- A. Yes. Pop packaged microwave popcorn following manufacturer's guidelines or use the preprogrammed Popcorn pad. Do not use regular paper bags. Use the "listening test" by stopping the oven as soon as the popping slows to a "pop" every one or two seconds. Do not try to repop unpopped kernels. You can also use special microwave poppers. When using a popper, be sure to follow manufacturer's directions. Do not pop popcorn in glass utensils.

### Q. Why does steam come out of the air exhaust vent?

- A. Steam is normally produced during cooking. The microwave oven has been designed to vent this steam out the top vent.

# MAINTENANCE

## MICROWAVE UTENSIL GUIDE

| USE   | DO NOT USE   |
|---|--|
| <p><b>OVENPROOF GLASS</b> (treated for high intensity heat):<br/>utility dishes, loaf dishes, pie plates, cake plates, liquid measuring cups, casseroles and bowls without metallic trim.</p> <p><b>CHINA:</b><br/>bowls, cups, serving plates and platters without metallic trim.</p> <p><b>PLASTIC:</b><br/>Plastic wrap (as a cover)-- lay the plastic wrap loosely over the dish and press it to the sides.<br/>Vent plastic wrap by turning back one edge slightly to allow excess steam to escape. The dish should be deep enough so that the plastic wrap will not touch the food. As the food heats it may melt the plastic wrap wherever the wrap touches the food.<br/>Use plastic dishes, cups, semirigid freezer containers, and plastic bags <b>only for short cooking time. Use these with care because the plastic may soften from the heat of the food.</b></p> <p><b>PAPER:</b><br/>Paper towels, waxed paper, paper napkins, and paper plates with no metallic trim or design. Look for the manufacturer's label for use in the microwave oven.</p> | <p><b>METAL UTENSILS:</b><br/>Metal shields the food from microwave energy and produces uneven cooking. Also avoid metal skewers, thermometers, or foil trays. Metal utensils can cause arcing, which can damage your microwave oven.</p> <p><b>METAL DECORATION:</b><br/>Metal-trimmed or metal-banded dinnerware, casserole dishes, etc. The metal trim interferes with normal cooking and may damage the oven.</p> <p><b>ALUMINUM FOIL:</b><br/>Avoid large sheets of aluminum foil because they hinder cooking and may cause harmful arcing. Use small pieces of foil to shield poultry legs and wings. Keep ALL aluminum foil at least 1 inch from the side walls and door of the oven.</p> <p><b>WOOD:</b><br/>Wooden bowls and boards will dry out and may split or crack when you use them in the microwave oven. Baskets react in the same way.</p> <p><b>TIGHTLY COVERED UTENSILS:</b><br/>Be sure to leave openings for steam to escape from covered utensils. Pierce plastic pouches of vegetables or other food items before cooking. Tightly closed pouches could explode.</p> <p><b>BROWN PAPER:</b><br/>Avoid using brown paper bags.<br/>They absorb too much heat and could burn.</p> <p><b>FLAWED OR CHIPPED UTENSILS:</b><br/>Any utensil that is cracked, flawed, or chipped may break in the oven.</p> <p><b>METAL TWIST TIES:</b><br/>Remove metal twist ties from plastic or paper bags.<br/>They become hot and could cause a fire.</p> |

# MAINTENANCE

## BEFORE CALLING FOR SERVICE

Check the following list to be sure a service call is really necessary. A quick reference of this manual as well as reviewing additional information on items to check may prevent an unneeded service call.

### **If nothing on the oven operates:**

- check for a blown circuit fuse or a tripped main circuit breaker.
- check if oven is properly connected to electric circuit in house.
- check that controls are set properly.

### **If the oven interior light does not work:**

- the light bulb is loose or defective.

### **If oven will not cook:**

- check that control panel was programmed correctly.
- check that door is firmly closed.
- check that Start Pad was pressed.
- check that probe was inserted correctly into receptacle.
- check that timer wasn't started instead of a cook function.

### **If oven takes longer than normal to cook or cooks too rapidly:**

- be sure the Power Level is programmed properly.

### **If the time of day clock does not always keep correct time:**

- check that the power cord is fully inserted into the outlet receptacle.
- be sure the oven is the only appliance on the electrical circuit.

### **If food cooks unevenly:**

- be sure food is evenly shaped.
- be sure food is completely defrosted before cooking.
- check placement of aluminum foil strips used to prevent overcooking.

### **If food is undercooked:**

- check recipe to be sure all directions (amount, time, & power levels) were correctly followed.
- be sure microwave oven is on a separate circuit.
- be sure food is completely defrosted before cooking.

### **If food is overcooked:**

- check recipe to be sure all directions (amount, power level, time, size of dish) were followed.

### **If arcing (sparks) occur:**

- be sure microwavable dishes were used.
- be sure wire twist ties weren't used.
- be sure oven wasn't operated when empty.
- make sure metal rack (if used) is properly installed on 4 supports.

### **If the Display shows a time counting down but the oven is not cooking:**

- check that door is firmly closed.
- check that timer wasn't started instead of a cooking function.

# LG MICROWAVE OVEN LIMITED WARRANTY – USA

LG Electronics Inc. will repair or replace your product, at LG's option, if it proves to be defective in material or workmanship under normal use, during the warranty period set forth below, effective from the date of original consumer purchase of the product. This limited warranty is good only to the original purchaser of the product and effective only when used in the United States, including U.S. Territories.

|  |   |
|--|---|
| <p><b><u>WARRANTY PERIOD:</u></b></p> <p><b>Model: LMV1635SW</b><br/> <b>LMV1635SB</b><br/> <b>LMV1635SBQ</b></p> <p><b>Labor: 1 Year</b> from the Date of Purchase.<br/> <b>Parts: 1 Year</b> from the Date of Purchase.<br/> <b>Magnetron: 10 Years</b> from the Date of Purchase.</p> | <p><b><u>HOW SERVICE IS HANDLED:</u></b></p> <p>Call 1-877-714-7486 and choose the appropriate prompt. Please have product type (Microwave) and ZIP code ready.</p> |
|--|---|

**THIS WARRANTY IS IN LIEU OF ANY OTHER WARRANTIES, EXPRESS OR IMPLIED, INCLUDING WITHOUT LIMITATION, ANY WARRANTY OF MERCHANTABILITY OR FITNESS FOR A PARTICULAR PURPOSE. TO THE EXTENT ANY IMPLIED WARRANTY IS REQUIRED BY LAW, IT IS LIMITED IN DURATION TO THE EXPRESS WARRANTY PERIOD ABOVE. LG WILL NOT BE LIABLE FOR ANY CONSEQUENTIAL, INDIRECT, OR INCIDENTAL DAMAGES OF ANY KIND, INCLUDING LOST REVENUES OR PROFITS, IN CONNECTION WITH THE PRODUCT. SOME STATES DO NOT ALLOW LIMITATION ON HOW LONG AN IMPLIED WARRANTY LASTS OR THE EXCLUSION OF INCIDENTAL OR CONSEQUENTIAL DAMAGES, SO THE ABOVE LIMITATIONS OR EXCLUSIONS MAY NOT APPLY TO YOU.**

**THIS LIMITED WARRANTY DOES NOT APPLY TO:**

1. Service trips to your home to deliver, pick up, and/or install the product, instruct, or replace house fuses or correct wiring, or correction of unauthorized repairs; and
2. Damages or operating problems that result from misuse, abuse, operation outside environmental specifications or contrary to the requirements or precautions in the Operating Guide, accident, vermin, fire, flood, improper installation, acts of God, unauthorized modification or alteration, incorrect electrical current or voltage, or commercial use, or use for other than intended purpose.
3. Therefore, the cost of repair or replacement of such a defective product shall be borne by the consumer.

**CUSTOMER INTER-ACTIVE CENTER NUMBERS:**

|  |   |
|--|---|
| <p><b>To Prove Warranty Coverage</b></p>   | <p><b>Retain your Sales Receipt to prove date of purchase.</b> A copy of your Sales Receipt must be submitted at the time warranty service is provided.</p>   |
| <p><b>To Obtain Nearest Authorized Service Center or Sales Dealer, or to Obtain Product, Customer, or Service Assistance</b></p> | <p><b>Call 1-877-714-7486</b> (Monday ~ Friday, 7 AM ~ 8 PM CT; and Saturday, 8 AM ~ 5 PM CT) and choose the appropriate prompt from the menu; or visit our website at <a href="http://www.lgservice.com">http://www.lgservice.com</a>.</p> |



## Free Manuals Download Website

<http://myh66.com>

<http://usermanuals.us>

<http://www.somanuals.com>

<http://www.4manuals.cc>

<http://www.manual-lib.com>

<http://www.404manual.com>

<http://www.luxmanual.com>

<http://aubethermostatmanual.com>

Golf course search by state

<http://golfingnear.com>

Email search by domain

<http://emailbydomain.com>

Auto manuals search

<http://auto.somanuals.com>

TV manuals search

<http://tv.somanuals.com>