



Website: <http://us.lgservice.com>



# MICROWAVE OVEN

## OWNER'S MANUAL & COOKING GUIDE

PLEASE READ THIS OWNER'S MANUAL  
THOROUGHLY BEFORE OPERATING.

**LMV1650SB**  
**LMV1650SW**

P/NO.: 3828W5A8378

## ***Thank you for purchasing an LG microwave oven.***

Please record the model number and serial number of this unit for future reference. We also suggest you record the details of your contact with LG (LG Electronics U.S.A., Inc.) concerning this unit.

Model No: \_\_\_\_\_

Serial No: \_\_\_\_\_

Dealer: \_\_\_\_\_

\_\_\_\_\_  
Dealer Phone No: \_\_\_\_\_

Staple your receipt here to prove your retail purchase.

Customer Relations  
LG Electronics U.S.A., Inc.  
Service Division Bldg. #3  
201 James Record Rd.  
Huntsville, AL 35824-0126

## **PRECAUTIONS TO AVOID POSSIBLE EXPOSURE TO EXCESSIVE MICROWAVE ENERGY...**

- (a) Do not attempt to operate this oven with the door open since open door operation can result in harmful exposure to microwave energy. It is important not to defeat or tamper with the safety interlocks.
- (b) Do not place any object between the oven front face and the door to allow soil or cleaner residue to accumulate on sealing surfaces.
- (c) Do not operate the oven if it is damaged. It is particularly important that the oven door closes properly and that there is no damage to the:
  - (1) Door (bent).
  - (2) Hinges and latches (broken or loosened).
  - (3) Door seals and sealing surfaces.
- (d) The oven should not be adjusted or repaired by anyone except properly qualified service personnel.

# TABLE OF CONTENTS

<b>PRECAUTIONS TO AVOID POSSIBLE EXPOSURE TO EXCESSIVE MICROWAVE ENERGY .....</b>	<b>2</b>	Pizza .....	16
<b>TABLE OF CONTENTS .....</b>	<b>3</b>	Potato .....	16
<b>SAFETY .....</b>	<b>4</b>	Vegetable .....	16
Important Safety Instructions .....	4	Cook .....	16
<b>INFORMATION .....</b>	<b>6</b>	Reheat .....	16
Location of Model Number .....	6	Sensor Cook Table .....	17
Oven Specifications .....	6	Sensor Reheat Table .....	17
Electrical Rating .....	6	Auto Defrost .....	18
Electrical Requirements .....	6	Weight Conversion Chart .....	18
Grounding Instructions .....	6	Defrosting Tips .....	18
Microwave Oven Features .....	7	Auto Defrost Chart .....	19
Oven Control Panel .....	8	Time Defrost .....	21
<b>OPERATION .....</b>	<b>10</b>	Quick Defrost .....	21
Learn about your Microwave Oven .....	10	Metal Rack .....	21
Clock .....	10	Time Defrost Chart .....	21
Timer .....	10	<b>COOKING .....</b>	<b>22</b>
Custom Set .....	10	Getting the Best Cooking Results .....	22
Child Lock .....	11	Fish & Shellfish .....	22
Vent FAN .....	11	Appetizers/Sauces/Soups .....	23
Light Hi/Low/Off .....	11	Meat .....	23
Light Timer .....	11	Meat Cooking Table .....	24
Ez-ON .....	12	Poultry .....	25
Hold Warm .....	12	Pasta and Rice .....	26
Custom Cook .....	12	<b>MAINTENANCE .....</b>	<b>27</b>
More/Less .....	12	Care and Cleaning .....	27
Cooking at High Power Levels .....	13	Metal Rack .....	27
Cooking at Lower Power Levels .....	13	Cleaning the Grease Filters .....	27
Cooking With More Than One Cook Cycle ....	13	Charcoal Filter Replacement .....	27
Cooking Guide for Lower Power Levels .....	14	Cooktop/Countertop Light Replacement .....	28
Sensor Operating Instructions .....	15	Oven Light Replacement .....	28
Sensor Cooking Guide .....	15	Questions and Answers .....	28
Adding or subtracting Cook Time .....	15	Microwave Utensil Guide .....	29
Popcorn .....	15	<b>TROUBLE SHOOTING .....</b>	<b>30</b>
		Before Calling for Service .....	30
		<b>WARRANTY.....</b>	<b>Inside back cover</b>

# SAFETY

## IMPORTANT SAFETY INSTRUCTIONS

**⚠ WARNING** - To reduce the risk of burns, electric shock, fire, injury to persons or exposure to excessive microwave energy.

- Read all instructions before using the appliance.
- Read and follow the specific "PRECAUTIONS TO AVOID POSSIBLE EXPOSURE TO EXCESSIVE MICROWAVE ENERGY" found on page 2.
- This appliance must be grounded. Connect only to properly grounded outlet. See "GROUNDING INSTRUCTIONS" found on page 6.
- Install or locate this appliance only in accordance with the provided installation instructions.
- Some produce such as whole eggs and sealed containers-for example, closed glass jars are able to explode and should not be heated in this oven.
- Use this appliance only for its intended use as described in the manual. Do not use corrosive chemicals or vapors in this appliance. This type of oven is specifically designed to heat, cook or dry food . It is not designed for industrial or laboratory use.
- As with the appliance, close supervision is necessary when used by children.
- Do not operate this appliance if it has a damaged cord or plug, if it is not working properly, or it has been damaged or dropped.
- This appliance should be serviced only by qualified service personnel. Contact nearest authorized service facility for examination, repair, or adjustment.
- Do not cover or block any openings on the appliance.
- Do not store this appliance outdoors. Do not use this product near water - for example, near a kitchen sink, in a wet basement, near a swimming pool, or similar location.
- Do not immerse cord or plug in water.
- Keep cord away from heated surface.
- Do not let cord hang over edge of table or counter.
- When cleaning surface of door and oven that comes together on closing the door, use only mild, nonabrasive soaps, or detergent applied with a sponge or soft cloth.
- To reduce the risk of fire in the oven cavity:
  - Do not over cook food. Carefully attend appliance when paper, plastic, or other combustible materials are placed inside the oven to facilitate cooking.
  - Remove wire twist - ties from paper or plastic bag before placing bag in oven.
  - If material inside of the oven ignite, keep oven door closed, turn oven off, and disconnect the power cord, shut off power at the fuse or circuit breaker panel.
  - Do not use the cavity for storage purposes. Do not leave paper products, cooking utensils, or food in the cavity when not in use.
- Liquids such as water, coffee, or tea are able to be overheated beyond the boiling point without appearing to be boiling. Visible bubbling or boiling when the container is removed from the microwave oven is not always present. THIS COULD RESULT IN VERY HOT LIQUIDS SUDDENLY BOILING OVER WHEN THE CONTAINER IS DISTURBED OR WHEN A SPOON OR OTHER UTENSIL IS INSERTED INTO THE LIQUID. To reduce the risk of injury to persons;
  - Do not overheat the liquid.
  - Stir the liquid both before and halfway through heating it.
  - Do not use straight-sided containers with narrow necks.
  - After heating, allow the container to stand in the microwave oven for a short time before removing the container
  - Use extreme care when inserting a spoon or other utensil into the container.

# SAFETY

- Clean Ventilation Hoods Frequently - Grease should not be allowed to accumulate on hood or filter.
- When flaming foods under the hood, turn the fan on.
- Use care when cleaning the vent-hood filter. Corrosive cleaning agents, such as lye-based oven cleaners, may damage the filter.
- Suitable for use above both gas and electric cooking equipment.

## SAVE THESE INSTRUCTIONS

### FEDERAL COMMUNICATIONS COMMISSION RADIO FREQUENCY INTERFERENCE STATEMENT ( U.S.A. ONLY)

#### **▲WARNING:**

This equipment generates and uses ISM frequency energy and if not installed and used properly, that is in strict accordance with the manufacturer's instructions, may cause interference to radio and television reception. It has been type tested and found to comply with limits for ISM Equipment pursuant to part 18 of FCC Rules, which are designed to provide reasonable protection against such interference in a residential installation. However, there is no guarantee that interference will not occur in a particular installation. If this equipment does cause interference to radio or television reception, which can be determined by turning the equipment off and on, the user is encouraged to try to correct the interference by one or more of the following:

- Clean door and sealing surface of the oven.
- Reorient the receiving antenna of the radio or television.
- Relocate the Microwave Oven with respect to the receiver.
- Move the microwave oven away from the receiver.
- Plug the microwave oven into a different outlet so that the microwave oven and the receiver are on different branch circuits.

**The manufacturer** is not responsible for any radio or TV interference caused by **unauthorized modification** to this microwave oven. It is the responsibility of the user to correct such interference.

# INFORMATION

Please read this owner's manual. It will tell you how to use all the fine features of this microwave oven.

## LOCATION OF MODEL NUMBER

To request service information or replacement parts, the service center will require the complete model number of your microwave oven. The number is on the oven front as shown in the illustration below.

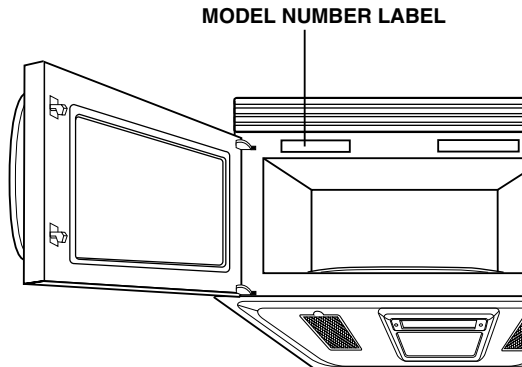

## OVEN SPECIFICATIONS

Output Power	1,000W (IEC 60705)
Outer Dimensions	29-15/16" x 16-7/16" x 15-3/8"
Cavity Volume	1.6 Cu.ft
Net Weight	53 lbs.

## ELECTRICAL RATING

\* Electrical Rating of the Oven: 120V AC, 60Hz  
\* 13.3 Amp./ 1,560W (MWO + Cooktop Lamp + Ventilation Fan)

## ELECTRICAL REQUIREMENTS

The oven is designed to operate on a Standard 120V/60Hz household outlet. Be sure the circuit is at least 15A or 20A and the microwave oven is the **only appliance on the circuit**. It is not designed for 50Hz or any circuit other than a 120V/60Hz circuit.

## GROUNDING INSTRUCTIONS

This appliance must be grounded. In the event of an electrical short circuit, grounding reduces the risk of electric shock by providing an escape wire for the electric current. This appliance is equipped with a cord having outlet that a grounding plug. The plug must be plugged into an outlet that is properly installed and grounded.

**⚠ WARNING - Improper use of the grounding can result in a risk of electric shock.**

Consult a qualified electrician or serviceman if the grounding instructions are not completely understood, or if doubt exists as to whether the appliance is properly grounded.

Do not use extension cord. If the power supply cord is too short, have a qualified electrician or service man install an outlet near the appliance. A short power supply cord is provided to reduce the risks resulting from becoming entangled in or tripping over a longer cord.

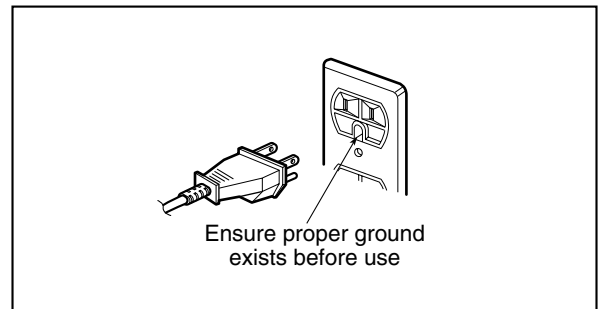

# INFORMATION

## MICROWAVE OVEN FEATURES

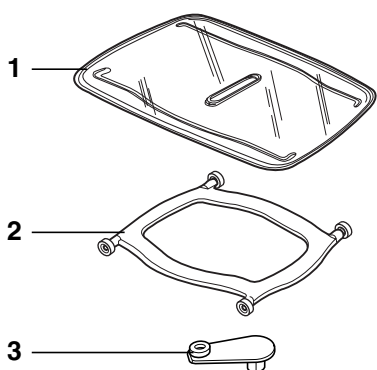
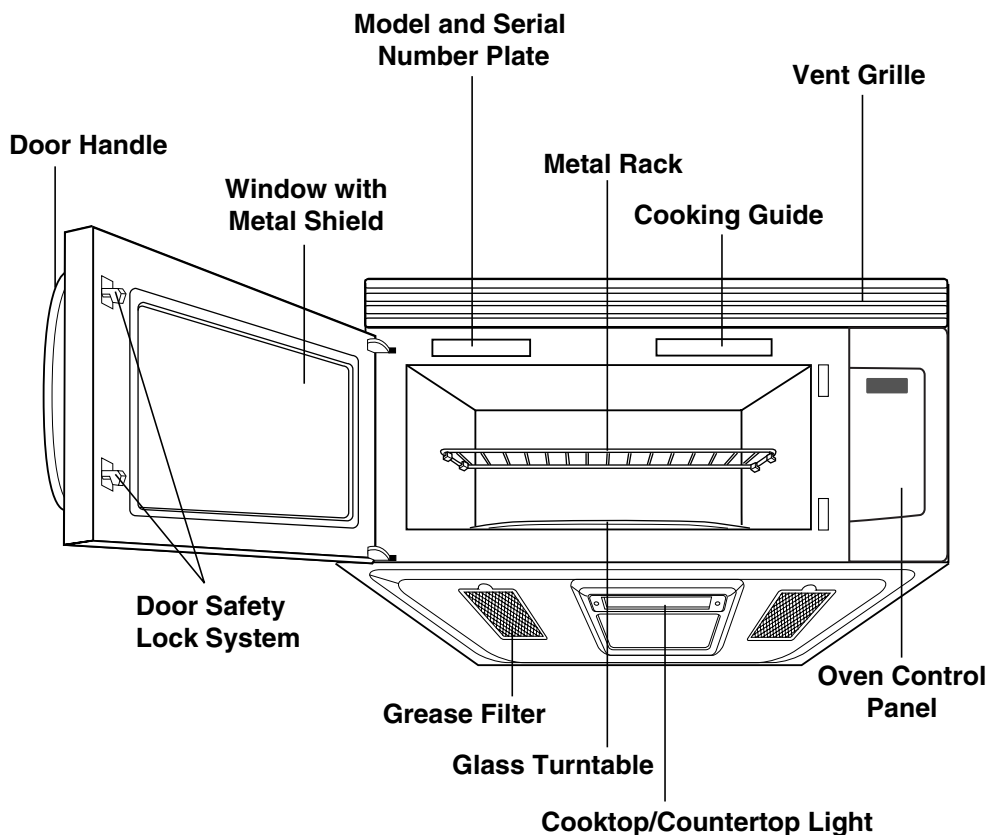

1. Glass tray
2. Support
3. Hub

The glass tray moves in both directions to help cook food more evenly. Do not operate the microwave oven without the glass tray in place.

### To Install:

1. Place the support on the oven cavity bottom.
2. Place the glass tray on the support.

Fit the raised, hollowed groove of the glass tray bottom between the rollers of the hub. The rollers on the support should fit inside the glass tray bottom ridge.

# INFORMATION

## OVEN CONTROL PANEL

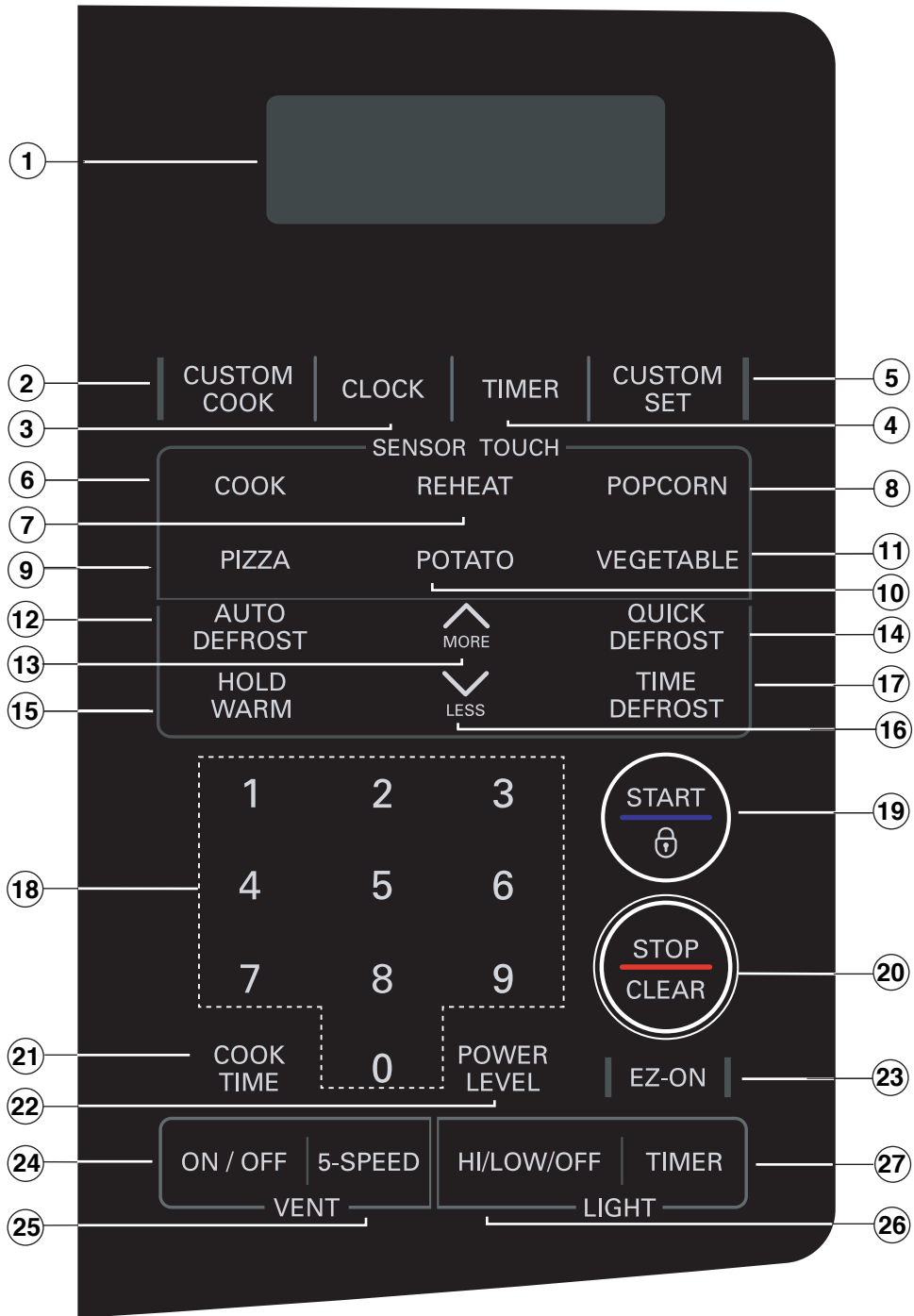



# INFORMATION

1. **DISPLAY:** The Display includes a clock and indicators to tell you time of day, cooking time settings and cooking functions selected.
2. **CUSTOM COOK:** Touch this pad to recall one cooking instruction previously programmed into memory.
3. **CLOCK:** Touch this pad to enter the time of day.
4. **TIMER:** Touch this pad to set the timer.
5. **CUSTOM SET:** Touch this pad to change the oven's default settings for sound, clock, display speed and defrost weight.
6. **COOK:** Touch this pad to cook frozen entree, casserole, and rice. The oven's sensor will tell the oven how long to cook depending on the amount of humidity coming from the food.
7. **REHEAT:** Touch this pad to reheat dinner plate, soup/sauce, and casserole. The oven's sensor will tell the oven how long to reheat depending on the amount of humidity coming from the food.
8. **POPCORN:** Touch this pad when popping popcorn in your microwave oven. The oven's sensor will tell the oven how long to cook depending on the amount of humidity it detects from the popcorn.
9. **PIZZA:** Touch this pad to reheat pizza. The oven's sensor will tell the oven how long to reheat depending on the amount of humidity it detects from the pizza.
10. **POTATO:** Touch this pad to cook potatoes. The oven's sensor will tell the oven how long to cook depending on the amount of humidity it detects from the potato.
11. **VEGETABLE:** Touch this pad to cook vegetables. The oven's sensor will tell the oven how long to cook depending on the amount of humidity it detects from the vegetables.
12. **AUTO DEFROST:** Meat, poultry, fish. Touch this pad to select food type and defrost food by weight.
13. **MORE:** Touch this pad to add ten seconds of cooking time each time you press it.
14. **QUICK DEFROST:** This pad provides you with the RAPID defrosting method for 1.0 pound frozen foods.
15. **HOLD WARM:** Touch this pad to keep hot, cooked foods warm in your microwave oven for up to 99 minutes 99 seconds.
16. **LESS:** Touch this pad to subtract ten seconds of cooking time each time you press it.
17. **TIME DEFROST:** Touch this pad to defrost most other frozen foods.
18. **NUMBER:** Touch number pads to enter cooking time, power level, quantities, or weights.
19. **START:** Touch this pad to start a function. If you open the door after oven begins to cook, START again.
20. **STOP/CLEAR:** Touch this pad to stop the oven or to clear all entries.
21. **COOK TIME:** Touch this pad to set a cooking time.
22. **POWER LEVEL:** Touch this pad to select a cooking power level.
23. **Ez-ON:** Touch this pad to set and start quickly at 100% power level.
24. **VENT ON/OFF:** Touch this pad to turn the fan on or off.
25. **VENT CONTROL 5 SPEED:** Touch this pad to choose one of 5 fan speeds.
26. **LIGHT HI/LOW/OFF:** Touch this pad to turn on the cooktop/countertop light.
27. **LIGHT TIMER:** Touch this pad to set the light timer.

## **WARNING:**

**DO NOT RUN THE OVEN EMPTY WITHOUT FOOD IN IT.**

# OPERATION

## LEARN ABOUT YOUR MICROWAVE OVEN

This section discusses the concepts behind microwave cooking and introduces you to the basics you need to know to operate your microwave oven. Please read this information before use.

### ⚠ CAUTION

To avoid risk of personal injury or property damage, do not use stoneware, aluminum foil, metal utensils, or metal trimmed utensils in the oven.

### ⚠ CAUTION

To avoid risk of personal injury or property damage, do not run oven empty.

## CLOCK

When your microwave oven is first plugged in or after a power failure, the Display will show "PLEASE SET TIME OF DAY". If a time of day is not set, ":" will show on the Display until you touch "Clock".

### Example: To set 8:00 AM.

CLOCK

1. Touch **CLOCK** pad.  
(Press once for AM, twice for PM.)

8

0

0

2. Enter the time by using the number key pad.

START

START

3. Touch **START** pad.

## TIMER

You can use your microwave oven as a timer. Use the Timer for timing up to 99 minutes, 99 seconds.

### Example: To set for 3 minutes.

TIMER

1. Touch **TIMER** pad.

3

0

0

2. Enter the time by using the number key pad.

START

START

3. Touch **START** pad.

When the time is over, you will hear seven beeps and **END** will display.

## CUSTOM SET

You can change the default values for beep sound, clock, display speed and defrost weight. See following chart for more information.

NUMBER	FUNCTION	NUMBER	RESULT
1	Beep ON/OFF control	1	Sound ON
		2	Sound OFF
2	Clock display control	1	Clock ON
		2	Clock OFF
3	Display	1	Slow speed
		2	Normal speed
		3	Fast speed
4	Defrost weight mode select	1	Lbs.
		2	Kg.

### Example: To change defrost weight mode.(from Lbs. to Kg.)

CUSTOM SET

1. Touch **CUSTOM SET** pad.

4

2. Touch number **4** pad.

2

3. Touch number **2** pad.

# OPERATION

## CHILD LOCK

You may lock the control panel to prevent the microwave from being accidentally started or used by children.

The Child Lock feature is also useful when cleaning the control panel. Child Lock prevents accidental programming when wiping the control panel.

### Example: To set the child lock.



1. Touch **STOP/CLEAR** pad.
2. Touch and hold **STOP/CLEAR** pad more than 4 seconds. **LOCKED** will appear in the display window with two beeps.

### Example: To cancel the child lock.



1. Touch and hold **STOP/CLEAR** pad more than 4 seconds. **LOCKED** will disappear and you hear two beeps. At this time the oven is ready.

## VENT FAN

The fan moves steam and other vapors from the cooking surface. There are five speeds.

### Example for Level 4



1. Touch **ON/OFF** pad. This shows the last level until you select the fan speed level.
2. Touch **5-SPEED** pad until **LEVEL4** appears in the display.

Touch **ON/OFF** pad to turn off fan when desired.

### NOTE:

- If the temperature from the range or cooktop below the oven gets too hot, the exhaust fan in the vent hood will automatically turn on to protect the oven.
- It may stay on up to an hour to cool the oven. When this occurs, the **ON/OFF** button will not turn the fan off.

## LIGHT HI/LOW/OFF



Touch **HI/LOW/OFF** pad once for bright light, twice for night light, or three times to turn the light off.

## LIGHT TIMER

You can set the LIGHT to turn on and off automatically at any time you want. The light comes on at the same time every day until reset.

### Example: Turn on 2:00 AM, turn off 7:00 AM.



1. Touch **TIMER** pad. (Press once for AM, twice for PM.)



2. Enter the time you want the LIGHT to turn on.



3. Touch **TIMER** pad again. (Press once for AM, twice for PM.)



4. Enter the time you want the LIGHT to turn off.



5. Touch **START** pad.

**NOTE:** To reset the time to turn on and off the LIGHT, repeat steps 1 to 5.

### Example: To cancel the LIGHT TIMER.



1. Touch **TIMER** pad.



2. Touch **STOP/CLEAR** pad.

**NOTE:** If you want to cancel the LIGHT TIMER in

operation, you should touch **HI/LOW/OFF** pad.

# OPERATION

## Ez-ON

A time-saving pad, this simplified control lets you quickly set and start microwave cooking without the need to touch **START** pad.

### Example: To set Ez-ON for 2 minutes.



1. Touch **Ez-ON** pad 4 times.  
The oven begins cooking and display shows time counting down.

### NOTE:

If you touch **Ez-ON**, it will add 30 seconds up to 3 minutes; after 3 minutes, every touch will add 1 minute up to 99 min 59 seconds.

## HOLD WARM

You can keep cooked food warm in your microwave oven for up to 99 minutes 99 seconds. You can use **HOLD WARM** by itself or to follow a cooking cycle automatically.

### Example: To use the hold warm.



1. Touch **HOLD WARM** pad.



2. Touch **START** pad.

### NOTE:

- **HOLD WARM** operates for up to 99 minutes 99 seconds.
- **Food cooked covered** should be covered during **HOLD WARM**.
- **Pastry items** (pies, turnovers, etc.) should be uncovered during **HOLD WARM**.
- **Complete meals** kept warm on a dinner plate can be covered during **HOLD WARM**.

Food Type	Recommended Quantity
Liquid	1-2 cups
Dry	5-10 ozs.

### To make **HOLD WARM** automatically follow another cycle:

- While you are programming the cooking instructions, touch **HOLD WARM** before touching **START**.
- When the last cooking cycle is over, you will hear two tones and “**HOLD WARM**” will appear in the oven display.
- You can set **HOLD WARM** to follow **AUTO DEFROST**, or multi-cycle cooking.

## CUSTOM COOK

**CUSTOM COOK** lets you recall one cooking instruction previously placed in memory and begin cooking quickly.

### Example: To cook for 2 minutes.



1. Touch **CUSTOM COOK** pad.



2. Enter the cook time.



3. Touch **START** pad.

### Example: To recall the favorite recipe.



1. Touch **CUSTOM COOK** pad.



2. Touch **START** pad.  
When the cook time is over, you will hear four beeps and **END** will display.

## MORE/LESS

By using the **MORE** or **LESS** keys, all of the pre-programmed cook and time cook features can be adjusted to cook food for a longer or shorter time.

### Example



1. Pressing **MORE** will add 10 seconds of cooking time each time you press it.





2. Pressing **LESS** will subtract 10 seconds of cooking time each time you press it.

# OPERATION

## COOKING AT HIGH POWER LEVELS

**Example: To cook food for 8 minutes 30 seconds.**

   1. Enter the cook time.





2. Touch **START** pad.  
When the cook time is over,  
you will hear four beeps  
and **END** will display.

## COOKING AT LOWER POWER LEVELS

HIGH power cooking does not always give you the best results with foods that need slower cooking, such as roasts, baked goods, or custards. Your oven has 10 power settings in addition to HIGH.

**Example: To cook food for 7 minutes 30 seconds at 70% power.**

   1. Enter the cook time.



2. Touch **POWER LEVEL** pad.



3. Enter the power level.





4. Touch **START** pad.  
When the cook time is over,  
you will hear four beeps and  
**END** will display.  
See cooking guide for  
power levels, page 14.

## COOKING WITH MORE THAN ONE COOK CYCLE

For best results, some recipes call for one Power Level for a certain length of time, and another Power Level for another length of time. Your oven can be set to change from one to another automatically, for up to three cycles if the first heating cycle is defrost.

**Example: To cook food for 3 minutes at 100% power and then 70% power for 7 minutes 30 seconds.**

   1. Enter the first cook time.



2. Touch **COOK TIME** pad.

   3. Enter the second cook time.



4. Touch **POWER LEVEL** pad.



5. Enter the power level.



6. Touch **START** pad.  
When the cook time is over,  
you will hear four beeps  
and **END** will display.

# OPERATION

## COOKING GUIDE FOR LOWER POWER LEVELS

The 10 power levels in addition to "HIGH" allow you to choose the best power level for the food you are cooking. Below are listed all the power levels, examples of foods best cooked at each level, and the amount of microwave power you are using.

POWER LEVEL	MICROWAVE OUTPUT	USE
10 High	100%	<ul style="list-style-type: none"> <li>• Boil water.</li> <li>• Cook ground beef.</li> <li>• Make candy.</li> <li>• Cook fresh fruits and vegetables.</li> <li>• Cook fish and poultry.</li> <li>• Preheat browning dish.</li> <li>• Reheat beverages.</li> <li>• Bacon slices. Place utensil on metal oven rack.</li> </ul>
9	90%	<ul style="list-style-type: none"> <li>• Reheat meat slices quickly.</li> <li>• Saute onions, celery, and green pepper.</li> </ul>
8	80%	<ul style="list-style-type: none"> <li>• All reheating.</li> <li>• Cook scrambled eggs.</li> </ul>
7	70%	<ul style="list-style-type: none"> <li>• Cook breads and cereal products.</li> <li>• Cook cheese dishes, veal.</li> <li>• Cook cakes, muffins, brownies, cupcakes.</li> </ul>
6	60%	<ul style="list-style-type: none"> <li>• Cook pasta.</li> </ul>
5	50%	<ul style="list-style-type: none"> <li>• Cook meats, whole poultry.</li> <li>• Cook custard.</li> <li>• Cook whole chicken, turkey, spare ribs, rib roast, sirloin roast.</li> </ul>
4	40%	<ul style="list-style-type: none"> <li>• Cook less tender cuts of meat.</li> <li>• Reheat frozen convenience foods.</li> </ul>
3	30%	<ul style="list-style-type: none"> <li>• Thawing meat, poultry, and seafood.</li> <li>• Cooking small quantities of food.</li> <li>• Finish cooking casserole, stew, and some sauces.</li> </ul>
2	20%	<ul style="list-style-type: none"> <li>• Soften butter and cream cheese.</li> <li>• Heating small amounts of food.</li> </ul>
1	10%	<ul style="list-style-type: none"> <li>• Soften ice cream.</li> <li>• Raise yeast dough.</li> </ul>
0		<ul style="list-style-type: none"> <li>• Standing time.</li> </ul>

# OPERATION

## SENSOR OPERATING INSTRUCTIONS

Sensor Cook allows you to cook most of your favorite foods without selecting cooking times and power levels. The oven automatically determines required cooking time for each food item. When the internal sensor detects a certain amount of humidity coming from the food, it will tell the oven how much longer to heat. The display will show the remaining heating time. For best results for cooking by Sensor, following these recommendations.

1. Food cooked with the sensor system should be at normal storage temperature.
2. Glass Tray and outside of container should be dry to assure best cooking results.
3. Foods should always be covered loosely with microwavable plastic wrap, waxed paper, or a lid.
4. Do not open the door or touch the **STOP/CLEAR** key during the sensing time. When the sensing time has ended, the oven beeps twice and the remaining cooking time will appear in the display window. At this time you can open the door to stir, turn, or rearrange the food.

## SENSOR COOKING GUIDE

Appropriate containers and coverings help assure good Sensor cooking results.

1. Always use microwavable containers and cover them with lids or vented plastic wrap.
2. Never use tight-sealing plastic covers. They can prevent steam from escaping and cause food to overcook.
3. Match the amount to the size of the container. Fill containers at least half full for best results.
4. Be sure the outside of the cooking container and the inside of the microwave oven are dry before placing food in the oven. Beads of moisture turning into steam can mislead the sensor.

## ADDING OR SUBTRACTING COOK TIME

By using the **MORE** or **LESS** pads all of the sensor cook and time cook settings can be adjusted to cook food for a longer or shorter time. Pressing **MORE** will add 10 seconds of cooking time each time you press it. Pressing **LESS** will subtract 10 seconds of cooking time each time you press it.

## POPCORN

POPCORN lets you pop commercially packaged microwave popcorn. Pop only one package at a time. For best results, use fresh bags of popcorn.

### Example: To pop popcorn.

POPCORN

1. Touch **POPCORN** pad. When the cook time is over, you will hear four beeps and **END** will display.

- Recommended amount : 3.0 ~ 3.5 ozs.

## ⚠ CAUTION

**Do not** leave microwave oven unattended while popping. When popping commercially packaged popcorn, **Remove the rack from the oven**; Do not place the bag of microwave popcorn on the rack or under the rack.

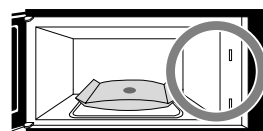
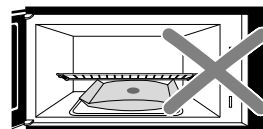
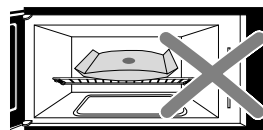

# OPERATION

## PIZZA

Reheating pizza with the PIZZA function lets you reheat one or several slices of pizza without selecting cooking times and power levels.

### Example: To reheat 2 slices of pizza.

**PIZZA**

1. Touch **PIZZA** pad.  
When the cook time is over, you will hear four beeps and **END** will display.

## POTATO

The POTATO pad lets you bake one or several potatoes without selecting cooking times and power levels.

### Example: To cook 2 potatoes.

**POTATO**

1. Touch **POTATO** pad.  
When the cook time is over, you will hear four beeps and **END** will display.

## VEGETABLE

VEGETABLE has preset cook powers for 3 food categories: **Fresh, Frozen, and Canned.**

### Example: To Cook Frozen Vegetable.

**VEGETABLE**

1. Touch **VEGETABLE** pad.
2. Choose food category.

Category	Touch Pad Number
Fresh	1
Frozen	2
Canned	3

When the cook time is over, you will hear four beeps and **END** will display.

## COOK

Using COOK lets you heat common microwave-prepared foods without needing to program times and Cook Powers. COOK has preset Cook Power for 3 food categories: **Frozen Entree, Casserole, and Rice.**

### Example: To cook Rice.

**COOK**

1. Touch **COOK** pad.

**3**

2. Choose food category.

Category	Touch Pad Number
Frozen Entree	1
Casserole	2
Rice	3

When the cook time is over, you will hear four beeps and **END** will display.

### NOTE:

- Use only long grain rice with sensor cook program. See page 26 to cook other types of rice.

## REHEAT

REHEAT lets you heat foods without needing to program times and Cook Powers.

REHEAT has preset Cook Powers for 3 categories: **Dinner Plate, Soup/Sauce, and Casserole.**

### Example: To reheat Casserole.

**REHEAT**

1. Touch **REHEAT** pad.

**3**

2. Choose food category.

Category	Touch Pad Number
Dinner Plate	1
Soup/Sauce	2
Casserole	3

When the cook time is over, you will hear four beeps and **END** will display.



# OPERATION

## SENSOR COOK TABLE

CATEGORY		DIRECTION	AMOUNT
Potato		Pierce each potato with a fork and place on the oven tray around the edge, at least one inch apart.	1 - 4 medium approx. 8 -10 ozs. each
VEGETABLE	Fresh Vegetable	Prepare as desired, wash, and leave residual water on the vegetables. Place in an appropriately-sized microwave container, cover with plastic wrap and vent.	1 - 4 cups
	Frozen Vegetable	Remove from package, rinse off frost under running water. Place in an appropriately-sized microwave container, cover with plastic wrap and vent.	1 - 4 cups
	Canned Vegetable	Remove from the outer display can. Place in an appropriately sized microwave container, cover with plastic wrap and vent. After cooking, stir and allow to stand for 3 minutes.	1 - 4 cups
Frozen Entrée		Remove from outer display package. Slit cover. If not in microwave-safe container, place on plate, cover with plastic wrap and vent.	10 - 21 ozs.
Casserole		Assemble the ingredients per the recipe in a 1-2 quart casserole. Cooking with plastic wrap and vent. After cooking, stir and allow to stand for 3 minutes	1 - 4 cups
Rice		Add twice the amount of water to the rice. Use a microwave container large enough to prevent water from boiling over dish. Cover with plastic wrap or lid.	1/2 - 2 cups

## SENSOR REHEAT TABLE

CATEGORY		DIRECTION	AMOUNT
Pizza		This is reheat function for a leftover pizza. Place on paper towel on a microwave safe plate.	1 - 3 slices (3 - 5 ozs. slice)
Dinner Plate		Place on a low plate. Cover with vented plastic wrap. Let stand 3 minutes.	1 - 2 servings
Soup/Sauce		Place in shallow microwavable casserole. Cover with vented plastic wrap. After cooking, stir and let stand 3 minutes.	1 - 4 cups
Casserole		Cover dish containing the casserole with plastic wrap and vent. After cooking, stir and allow to stand for 3 minutes.	1 - 4 cups

# OPERATION

## AUTO DEFROST

Three defrost choices are preset in the oven. The defrost feature provides you with the best defrosting method for frozen foods, because the oven automatically sets the defrosting times for each food item according to the weight you enter. For added convenience, the AUTO DEFROST includes a built-in tone mechanism that reminds you to check, turn over, separate, or rearrange the food during the defrost cycle. Three different defrosting options are provided.

1. **MEAT**
2. **POULTRY**
3. **FISH**

After touching AUTO DEFROST once, select the food category. Available weight ranges for Meat, Poultry and Fish are 0.1 to 6.0 lbs.

### Example: To defrost 1.2 lbs of meat.



1. Touch **AUTO DEFROST** pad.



2. Choose food category.



3. Enter the weight.



4. Touch **START** pad.

### NOTE:

- After you touch START, the display counts down the defrost time. The oven will beep once during the Defrost cycle. At this time, open the door and turn, separate, or rearrange the food as needed. Remove any portions that have thawed then return frozen portions to the oven and touch START to resume the defrost cycle.
- **The oven will not stop during the BEEP unless the door is opened.**

## WEIGHT CONVERSION CHART

To enter food weight in AUTO DEFROST, you must specify pounds and tenths of a pound. If the weight on the food package is in fractions of a pound, you can use the following chart to convert the weight to decimals.

EQUIVALENT OUNCE WEIGHT	NUMBER AFTER DECIMAL	
1.6	.10	
3.2	.20	
4.0	.25	One-Quarter Pound
4.8	.30	
6.4	.40	
8.0	.50	One- Half Pound
9.6	.60	
11.2	.70	
12.0	.75	Three-Quarters Pound
12.8	.80	
14.4	.90	
16.0	1.00	One Pound

## DEFROSTING TIPS

- **When using** AUTO DEFROST, the weight to be entered is the net weight in pounds and tenths of pounds (the weight of the food minus the container).
- **Use** AUTO DEFROST only for raw food. AUTO DEFROST gives best results when food to be thawed is a minimum of 0°F (taken directly from a **true** freezer). If food has been stored in a refrigerator-freezer that does not maintain a temperature of 5°F or below, always program a lower food weight (for a shorter defrosting time) to prevent cooking the food.
- **If the food is stored outside** the freezer for up to 20 minutes, enter a lower food weight.
- **The shape of the package** alters the defrosting time. Shallow rectangular packets defrost more quickly than a deep block.
- **Separate pieces** as they begin to defrost. Separated pieces defrost more easily.
- **You can use small pieces** of aluminum foil to shield foods like chicken wings, leg tips, and fish tails, but the foil must not touch the side of the oven. Foil causes arcing, which can damage the oven lining.
- **Shield areas of food** with small pieces of foil if they start to become warm.
- **For even, complete defrosting**, use the defrosting rack.
- **For best results**, elevate food to be defrosted on a microwave safe roasting rack. This prevents the possibility of warm meat juices cooking food during defrost.

# OPERATION

## AUTO DEFROST CHART

### Meat setting

FOOD	SETTING	AT BEEP	SPECIAL INSTRUCTIONS
<b>BEEF</b>			Meat of irregular shape and large, fatty cuts of meat should have the narrow or fatty areas shielded with foil at the beginning of a defrost sequence.
Ground Beef, Bulk	MEAT	Remove thawed portions with fork. Turn over. Return remainder to oven.	Do not defrost less than 1/4 lb. Freeze in doughnut shape.
Ground Beef, Patties	MEAT	Separate and rearrange.	Do not defrost less than two oz. patties. Depress center when freezing. Place on a microwavable roasting rack.
Round Steak	MEAT	Turn over. Cover warm areas with aluminum foil.	Place on a microwavable roasting rack.
Tenderloin Steak	MEAT	Turn over. Cover warm areas with aluminum foil.	Place on a microwavable roasting rack.
Stew Beef	MEAT	Remove thawed portions with fork. Separate remainder. Return remainder to oven.	Place in a microwavable baking dish.
Pot Roast, Chuck Roast	MEAT	Turn over. Cover warm areas with aluminum foil.	Place on a microwavable roasting rack.
Rib Roast	MEAT	Turn over. Cover warm areas with aluminum foil.	Place on a microwavable roasting rack.
Rolled Rump Roast	MEAT	Turn over. Cover warm areas with aluminum foil.	Place on a microwavable roasting rack.
<b>LAMB</b>			
Cubes for Stew	MEAT	Remove thawed portions with fork. Return remainder to oven.	Place in a microwavable baking dish.
Chops (1 inch thick)	MEAT	Separate and rearrange.	Place on a microwavable roasting rack.
<b>PORK</b>			
Chops (1/2 inch thick)	MEAT	Separate and rearrange.	Place on a microwavable roasting rack.
Hot Dogs	MEAT	Separate and rearrange.	Place on a microwavable roasting rack.
Spareribs Country-style Ribs	MEAT	Turn over. Cover warm areas with aluminum foil.	Place on a microwavable roasting rack.
Sausage, Links	MEAT	Separate and rearrange.	Place on a microwavable roasting rack.
Sausage, Bulk	MEAT	Remove thawed portions with fork. Turn over. Return remainder to oven.	Place in a microwavable baking dish.
Loin Roast, Boneless	MEAT	Turn over. Cover warm areas with aluminum foil.	Place on a microwavable roasting rack.

# OPERATION

## AUTO DEFROST CHART (CONTINUED)

### Poultry setting

FOOD	SETTING	AT BEEP	SPECIAL INSTRUCTIONS
<b>CHICKEN</b> Whole (under 4 lbs)	POULTRY	Turn over (finish defrosting breast side down). Cover warm areas with aluminum foil.	Place chicken breast-side up on a microwavable roast rack. Finish defrosting by immersing in cold water. Remove giblets when chicken is partially defrosted.
Cut-up		Separate pieces and rearrange.  Turn over. Cover warm areas with aluminum foil.	Place on a microwavable roasting rack.  Finish defrosting by immersing in cold water.
<b>CORNISH HENS</b> Whole	POULTRY	Turn over. Cover warm areas with aluminum foil.	Place on a microwavable roasting rack. Finish defrosting by immersing in cold water.
<b>TURKEY</b> Breast (under 6 lbs)	POULTRY	Turn over. Cover warm areas with aluminum foil.	Place on a microwavable roasting rack. Finish defrosting by immersing in cold water.

### Fish setting

FOOD	SETTING	AT BEEP	SPECIAL INSTRUCTIONS
<b>FISH</b> Fillets	FISH	Turn over. Separate fillets when partially thawed if possible.	Place in a microwavable baking dish. Carefully separate fillets under cold water.
Steaks	FISH	Separate and rearrange.	Place in a microwavable baking dish. Run cold water over to finish defrosting.
Whole	FISH	Turn over.	Place in a microwavable baking dish. Cover head and tail with foil; do not let foil touch sides of microwave. Finish defrosting by immersing in cold water.
<b>SHELLFISH</b> Crabmeat	FISH	Break apart. Turn over.	Place in a microwavable baking dish.
Lobster tails	FISH	Turn over and rearrange.	Place in a microwavable baking dish.
Shrimp	FISH	Separate and rearrange.	Place in a microwavable baking dish.
Scallops	FISH	Separate and rearrange.	Place in a microwavable baking dish.

**NOTE :** Food to be defrosted must be not more than 6.0 lbs  
\*Available weight is 0.1~6.0 lbs

# OPERATION

## TIME DEFROST

This feature allows you to choose the time you want to defrost.

**Example: To defrost for 2 minutes.**



1. Touch **TIME DEFROST** pad.



2. Enter the defrosting time you want.



3. Touch **START** pad.  
(Defrost starts)  
When the defrost time is over, you will hear four beeps and **END** will display.

## QUICK DEFROST

The QUICK DEFROST feature provides you with the rapid defrosting method for 1.0 pound frozen foods. The oven automatically sets the defrosting time for ground beef.

**Example: To defrost 1lb ground beef.**



1. Touch **QUICK DEFROST** pad.



2. Touch **START** pad.

## METAL RACK

The metal rack gives you extra space when cooking in more than one container at the same time.

### To use rack:

1. Place rack securely in the four plastic supports.
  - Rack **MUST NOT** touch metal walls or back of microwave oven.
2. Place equal amounts of food both **ABOVE AND BELOW** rack.
  - Amount of food must be approximately the same to balance out cooking energy.

## CAUTION

To avoid risk of property damage:

- Do not use rack to pop popcorn.
- Rack must be on the four plastic supports when used.
- Use the rack only when cooking food on rack position.
- Do not cook with rack on floor of the oven.

## TIME DEFROST CHART

FOOD	TIME/lb	SPECIAL INSTRUCTIONS
<b>MEAT</b> Bacon Ground meat Roasts  Steaks, chops and cutlets	2 - 4 minutes 4½ - 6 minutes 4½ - 6 minutes  4½ - 6 minutes	Turn food over at beep. Stand for 5 minutes after defrosting. Turn food over at beep. Stand for 5 minutes after defrosting. Turn food over at beep. Shield warm areas with foil. Stand for 5 to 10 minutes. Same as above.
<b>POULTRY</b> Chicken, broiler-fryer cut up (2½ to 3 lbs.) Chicken, whole (2 to 3 lbs.)  Cornish hen	4⅓ - 5⅓ minutes 5 - 6 minutes  5 - 7 minutes	Turn food over at beep. Shield warm areas with foil. Stand for 20 to 30 minutes. Cover with foil. Turn food over at beep. Shield warm areas with foil. Stand for 20 to 30 minutes. Cover with foil. Turn food over at beep. Shield warm areas with foil. Stand for 20 to 30 minutes. Cover with foil.
<b>FISH &amp; SEAFOOD</b> Filletts Shellfish, small pieces	4 - 5½ minutes 4 - 5 minutes	Place block in casserole. Turn food over and break up after beep. Stand for 5 minutes.

### NOTE:

Defrost times are approximate and are intended as guidelines.

# COOKING

## GETTING THE BEST COOKING RESULTS

To get the best results from your microwave oven, read and follow the guidelines below.

- **Storage Temperature:** Foods taken from the freezer or refrigerator take longer to cook than the same foods at room temperature. The time for recipes in this book is based on the normal storage temperature of the food.
- **Size:** Small pieces of food cook faster than large ones, pieces similar in size and shape cook more evenly. For even cooking, reduce the power when cooking large pieces of food.
- **Natural Moisture:** Very moist foods cook more evenly because microwave energy is attracted to water molecules.
- **Stir** foods such as casseroles and vegetables from the outside to the center to distribute the heat evenly and speed cooking. Constant stirring is not necessary.
- **Turn over** foods like pork chops, baking potatoes, roasts, or whole cauliflower halfway through the cooking time to expose all sides equally to microwave energy.
- **Place** delicate areas of foods, such as asparagus tips, toward the center of the dish.
- **Arrange** unevenly shaped foods, such as chicken pieces or salmon steaks, with the thicker, meatier parts toward the outside of the dish.
- **Shield**, with **Small** pieces of aluminum foil, parts of food that may cook quickly, such as wing tips and leg ends of poultry.
- **Let It Stand:** After you remove the food from the microwave, cover food with foil or casserole lid and let it stand to finish cooking in the center and avoid overcooking the outer edges. The length of standing time depends on the density and surface area of the food.
- **Wrapping in waxed paper or paper towel:** Sandwiches and many other foods containing prebaked bread should be wrapped prior to microwaving to prevent drying out.

## Fish & Shellfish

### Cooking Fish and Shellfish: General Directions

- Prepare the fish for cooking.
  - Completely defrost the fish or shellfish.
  - Arrange unevenly shaped pieces with thicker parts toward the outside of the dish. Arrange shellfish in a single layer for even cooking.
  - The type of cover you use depends on how you cook. Poached fish needs a microwavable lid or **vented** plastic wrap.
  - Baked fish, coated fish, or fish in sauce needs to be covered lightly with waxed paper to keep the coating crisp and sauce from getting watery.
- Always set the shortest cooking time. Fish is done when it turns opaque and the thickest part begins to flake. Shellfish is done when the shell turns from pink to red and the flesh is opaque and firm.
- The Fish and Shellfish Cooking Table below provides specific directions with Power Level and Cooking Time settings for most types of fish and shellfish.

### Fish And Shellfish Cooking Table

FISH	POWER LEVEL	COOKING TIME	DIRECTIONS
Fish fillets	HI	3 <sup>1</sup> / <sub>2</sub> -4 <sup>1</sup> / <sub>2</sub> minutes	Arrange the fish in a single layer with thickest portion toward outside edge of 1 <sup>1</sup> / <sub>2</sub> quart microwavable baking dish. Brush with melted butter and season, if desired. Cook covered with vented plastic wrap. Let stand covered 2 minutes. If you are cooking more than 1 lb. of fish, turn the fish halfway through cooking.
Fish steaks	HI	4 <sup>1</sup> / <sub>2</sub> -5 <sup>1</sup> / <sub>2</sub> minutes	
Whole fish	7	4 <sup>1</sup> / <sub>2</sub> -6 minutes	
Scallops	HI	3 <sup>1</sup> / <sub>2</sub> -5 minutes	Arrange in a single layer. Prepare as directed above, except stir instead of turning the shellfish.
Shrimp, shelled	HI	3 <sup>1</sup> / <sub>2</sub> -5 minutes	

# COOKING

## Appetizers / Sauces / Soups

### Cooking Appetizers: Tips and Techniques

#### Recommended

- Crisp crackers, such as melba toast, shredded wheat, and crisp rye crackers are best for microwave use. Wait until party time to add the spreads. Place a paper towel under the crackers while they cook in the microwave oven to absorb extra moisture.
- Arrange individual appetizers in a circle for even cooking.
- Stir dips to distribute heat and shorten cooking time.

### Cooking Sauces: Tips and Techniques

- Use a microwavable casserole or glass measuring cup that is at least 2 or 3 times the volume of the sauce.
- Sauces made with cornstarch thicken more rapidly than those made with flour.

### Cooking Soups: Tips and Techniques

- Cook soups in a microwavable dish which holds double the volume of the recipe ingredients to prevent boil-over, especially if you use cream or milk in the soup.
- Generally, cover microwaved soups with VENTED plastic wrap or a microwavable lid.
- Cover foods to retain moisture. Uncover foods to retain crispness.
- Avoid overcooking by using the minimum suggested time. Add more time, if necessary, only after checking the food.

### Not Recommended

- Appetizers with a crisp coating or puff pastry are best done in a conventional oven with dry heat.
- Breaded products can be warmed in the microwave oven but will not come out crisp.
- Cook sauces made with cornstarch or flour uncovered so you may stir them 2 or 3 times during cooking for a smooth consistency.
- To adapt a conventional sauce or gravy recipe, reduce the amount of liquid slightly.
- Stirring occasionally will help blend flavors, distribute heat evenly, and may even shorten the cooking time.
- When converting a conventional soup recipe to cook in the microwave, reduce the liquid, salt, and strong seasonings.

## Meat

### Cooking Meat: General Directions

- Prepare the meat for cooking.
  - Defrost completely.
  - Trim off excess fat to avoid splattering.
  - Place the meat, fat side down, on a microwavable rack in a microwavable dish.
  - Use oven cooking bag for less tender cuts of meat.
  - Arrange the meat so that thicker portions are toward the outside of the dish.
  - Cover the meat with waxed paper to prevent splattering.
- Tend the meat as it cooks.
  - Drain juices as they accumulate to reduce splattering and keep from overcooking the bottom of the meat.
  - Shield thin or bony portions with strips of foil to prevent overcooking.

**NOTE:** Keep the foil at **least 1 inch** from the oven walls, and do not cover more than one-third of the meat with foil at any one time.

- Let the meat stand covered with foil 10-15 minutes after you remove it from the oven. The internal temperature of the meat may rise an additional 5-10°F during standing time.

The Meat Cooking Table on the next page provides detailed directions, Power Level, and Cooking Time settings for most cuts of meat.

# COOKING

## Meat Cooking Table

MEAT	POWER LEVEL	COOKING TIME	DIRECTIONS
Beef Hamburgers, Fresh or defrosted (4 oz. each) 1 patty 2 patties 4 patties	HI	1-1½ minutes 1½-2 minutes 2½-3½ minutes	Form patties with depression in center of each. Place on microwavable roast rack. Brush with browning agent, if desired. Cover with waxed paper. Turn over halfway through cooking. Let stand covered 1 minute.
Sirloin tip roast (3-4 lbs.)	5	8-10 minutes per pound RARE (135°F) 11-13 minutes per pound MEDIUM (155°F)	Place roast fat side down on a microwavable roast rack. Add desired seasonings and cover with waxed paper. Turn meat over halfway through cooking and shield if necessary. Remove roast from microwave oven when desired temperature is reached. Let stand covered with foil 15 minutes.(Temperature may rise about 10°F).
Lamb Lamb roast, rolled boneless (3-4 lbs.)	5	11-12 minutes per pound RARE (135°F) 12-13 minutes per pound MEDIUM (145°F) 13-14 minutes per pound WELL (155°F)	Place roast fat side down on a microwavable roast rack. Brush lamb with marinade or desired seasonings such as rosemary, thyme or marjoram. Cover with waxed paper. Turn roast over after 15 minutes, and again after 30 minutes. Shield if necessary. Remove roast from microwave when desired temperature is reached. Let stand covered with foil 15 minutes. (Temperature may rise about 10°F).
Pork Bacon slices 2 slices 4 slices 6 slices 10 slices	HI	1½-2 minutes 2-3 minutes 4-5 minutes 7-8 minutes	Place bacon slices on a microwavable roast rack. Cover with paper towels. After cooking, let stand 1 minute.
Chops (5-7 oz. each) 2 chops 4 chops	3	18-20 minutes per pound 15-17 minutes per pound	Place chops in a microwavable baking dish. Add desired seasonings and cover with vented plastic wrap. Cook until no longer pink or until internal temperature reaches 170° F. Turn chops over halfway through cooking. Let stand covered 5 minutes. (Temperature may rise about 10°F).
Loin Roast, rolled, boneless (3½- 4½ lbs.)	3	25-27 minutes per pound (165°F)	Place roast in cooking bag in a microwavable dish. Add seasonings and browning agent if desired. Close bag loosely with microwavable closure or string. After cooking, let stand in bag 15 minutes. (Temperature may rise about 10°F.) Internal temperature of pork should reach 170°F before serving.
Sausage links, Fresh or Frozen, defrosted (1-2 oz. each) 2 links 4 links 6 links 10 links	HI	45-60 seconds 1-1½ minutes 1½-2 minutes 1¾-2 minutes	Pierce links and place on a microwavable roast rack. Cover with waxed paper or paper towel. Turn over halfway through cooking. After cooking, let stand covered 1 minute.



# COOKING

## Poultry

### Cooking Poultry: General Directions

- Prepare the poultry for cooking.
  - Defrost completely.
  - Arrange poultry pieces with thicker pieces at the outside edge of the baking dish. When cooking legs, arrange them like the spokes of a wheel.
  - Cover the baking dish with waxed paper to reduce splattering.
  - Use a browning agent or cook with a sauce to give a browned appearance.
- Watch the poultry as it cooks.
  - Drain and discard juices as they accumulate.
  - Shield thin or bony pieces with small strips of aluminum foil to prevent overcooking. Keep foil **at least 1 inch** from the oven walls and other pieces of foil.
- The poultry is done when it is no longer pink and the juices run clear. When done, the temperature in the thigh meat should be 180-185°F.
- Let the poultry stand after cooking covered with foil for 10 minutes.

The Poultry Cooking Table below provides detailed directions, Power Level, and Cooking Time settings for most cuts and types of poultry.

### Poultry Cooking Table

POULTRY	POWER LEVEL	COOKING TIME	DIRECTIONS
Chicken pieces (2½-3 lbs.)	HI	4½-5½ minutes per pound	Before cooking, wash pieces and shake the water off. Place pieces in a single layer in a microwavable baking dish with thicker pieces to the outside. Brush with butter or browning agent and seasonings if desired. Cover with waxed paper. Cook until no longer pink and juices run clear. Let stand covered 5 minutes.
Chicken whole (3-3½ lbs.)	HI	12-13 minutes per pound	Before cooking, wash and shake off water. Place breast side down on a microwavable roasting rack. Brush with butter, or browning agent and seasoning if desired. Cover with waxed paper. Cook ⅓ of estimated time. Turn breast side up, brush with butter, or browning agent. Replace waxed paper. Cook ⅓ of estimated time again. Shield if necessary. Cook remaining ⅓ of estimated time or until no longer pink and juices run clear. Let stand covered with foil 10 minutes. (The temperature may rise about 10°F.) The temperature in the thigh should be 180°F-185°F when the poultry is done.
Cornish Hens whole (1-1½ lbs. each)	HI	6-7 minutes per pound	Before cooking, wash and shake the water off. Tie wings to body of hen and the legs to tail. Place hens breast side down on microwavable rack. Cover with waxed paper. Turn breast side up halfway through cooking. Shield bone ends of drumsticks with foil. Remove and discard drippings. Brush with butter or browning agent and seasonings if desired. Cook until no longer pink and juices run clear. Remove hens from microwave when they reach desired temperature. Let stand covered with foil 5 minutes. (Temperature may rise about 10°F). Temperature in breast should be 170°F before serving.

# COOKING

## Pasta And Rice

Microwave cooking and conventional cooking of pasta, rice, and cereal require about the same amount of time, but the microwave is a more convenient method because you can cook and serve in the same dish.

There is no stirring needed and leftover pasta tastes just like fresh cooked when reheated in the microwave oven.

### Cooking Pasta and Rice: Tips and Techniques

- If you are planning to use rice or pasta in a casserole, undercook it so it is still firm.
- Allow for standing time with rice, but not for pasta.
- The Pasta and Rice Cooking Tables below provide specific directions, with Power Level and Cooking Time settings for most common types of pasta and rice.

### Pasta Cooking Table

TYPE OF PASTA	POWER LEVEL	COOKING TIME	DIRECTIONS
<b>Spaghetti</b> 4 cups water Add 8 ozs. spaghetti	HI 5	9-10 minutes 7½-8½ minutes	Combine hot tap water and salt, if desired. Use a 2-quart microwavable baking dish and cover with vented plastic wrap for spaghetti and lasagna noodles. Use microwavable lid or vented plastic wrap for macaroni and egg noodles. Cook at Power Level HI as directed in chart or until water boils. Stir in pasta; cook covered at Power Level 5 as directed in chart or until tender. Drain in a colander.
<b>Macaroni</b> 3 cups water Add 2 cups macaroni	HI 5	6-7 minutes 5½-6½ minutes	
<b>Lasagna noodles</b> 4 cups water Add 8 ozs. lasagna noodles	HI 5	7-8 minutes 11-12½ minutes	
<b>Egg noodles</b> 6 cups water Add 4 cups noodles	HI 5	8-10 minutes 5½-6½ minutes	

### Rice Cooking Table

TYPE OF RICE	POWER LEVEL	COOKING TIME	DIRECTIONS
<b>Long grain</b> 2¼ cups water Add 1 cup rice	HI 3	5-7 minutes 19 minutes	Combine hot tap water and salt, if desired, in 2 quart microwavable casserole. Cover with microwavable lid or vented plastic wrap. Cook as directed in chart at Power Level HI or until water boils. Stir in rice and any seasonings. Cook covered as directed in chart at Power Level 3 or until water is absorbed and rice is tender. Let stand covered 5 to 10 minutes. Fluff with fork.
<b>Brown</b> 2¼ cups water Add 1 cup rice	HI 3	4½-5½ minutes 28 minutes	
<b>Long grain and wild rice mix</b> 2⅓ cups water Add 6 oz. package	HI 3	4-5 minutes 24 minutes	
<b>Quick cooking</b> 1 cup water Add 1 cup rice	HI	2-3 minutes	Cook water until it boils. Stir rice into boiling water and let stand, covered 5 to 10 minutes or until water is absorbed and rice is tender. Fluff with fork.

# MAINTENANCE

## CARE AND CLEANING

For best performance and safety, keep the oven clean inside and outside. Take special care to keep the inner door panel and the oven front frame free of food or grease build-up.

**Never use rough powder or pads.** Wipe the microwave oven inside and out, including the hood bottom cover, with a soft cloth and a warm (not hot) mild detergent solution. Then rinse and wipe dry. Use a chrome cleaner and polish on chrome, metal, and aluminum surfaces. Wipe spatters immediately with a wet paper towel, especially after cooking chicken or bacon. Clean your oven weekly or more often, if needed.

## METAL RACK

Wash the metal rack with a mild soap and a soft or nylon scrub brush. Dry completely. Do not use abrasive scrubbers or cleaners to clean rack.

## CLEANING THE GREASE FILTERS

The grease filter should be removed and cleaned often, at least once a month.

1. **Disconnect** power or **unplug** microwave oven.
2. To remove grease filter, slide filter to the side. Pull filter downward and push to the other side. The filter will drop out.

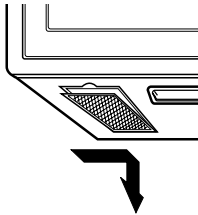

3. Soak grease filter in hot water and a mild detergent. Rinse well and shake to dry. **Do not use ammonia or place in a dishwasher. The aluminum will darken.**

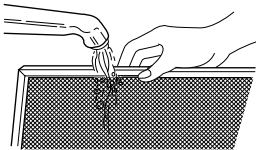

4. To reinstall the filter, slide it into the back slot, then push up to lock.

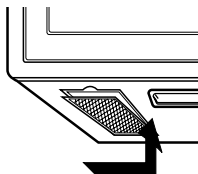

5. **Reconnect** power or **plug** in microwave oven. **NOTE: Do not** operate the hood without the filter in place.

## CHARCOAL FILTER REPLACEMENT

If your oven is vented inside, the charcoal filter should be replaced every 6 to 12 months, and more often if necessary. The charcoal filter cannot be cleaned. To order a new charcoal filter, contact the Parts Department at your nearest Authorized Service Center.

1. **Disconnect** power or **unplug** microwave oven.
2. **Remove** the two vent grille mounting screws.

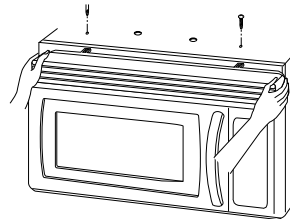

3. **Tip** the grille forward, then lift out to remove.
4. Remove old filter.

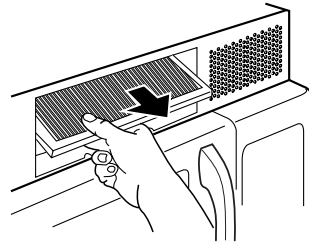

5. **Slide** a new charcoal filter into place. The filter should rest at the angle shown.

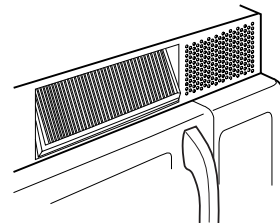

6. **Slide** the bottom of the vent grille into place. **Push** the top until it snaps into place. **Replace** the mounting screws.
7. **Reconnect** power or **plug** in microwave oven.

# MAINTENANCE

## COOKTOP/COUNTERTOP LIGHT REPLACEMENT

1. **Disconnect** power or **unplug** microwave oven.

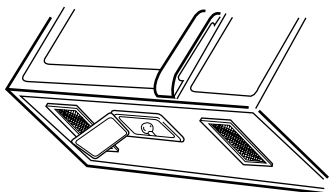

2. **Remove** the bulb cover mounting screws.
3. Replace bulb with 30 or 40 watt appliance bulb.
4. Replace bulb cover, and mounting screws.
5. **Reconnect** power or **plug** in microwave oven.

## OVEN LIGHT REPLACEMENT

1. **Disconnect** power or **unplug** microwave oven.
2. **Remove** the vent grille mounting screws. (2 outer screws)
3. **Tip** the cover forward, then **lift out** to remove.

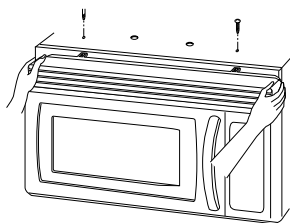

4. Push the hook.

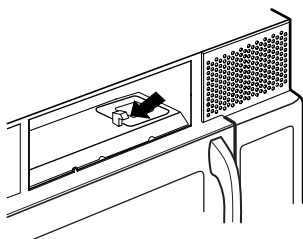

5. **Lift up** the bulb holder.

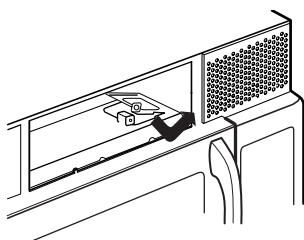

6. **Replace** bulb with a 30 or 40 watt appliance bulb.
7. **Replace** the bulb holder.
8. Slide the bottom of the vent cover into place. **Push** the top until it snaps into place. **Replace** the mounting screws.
9. **Reconnect** power or **plug** in microwave oven.

## QUESTIONS AND ANSWERS

**Q. Can I use a rack in my microwave oven so that I may reheat or cook in two rack positions at a time?**

A. Only use the rack that is supplied with your microwave oven. Use of any other rack can result in poor cooking performance and/or arcing and may damage your oven.

**Q. Can I use either metal or aluminum pans in my microwave oven?**

A. Usable metal includes aluminum foil for shielding (use small, flat pieces). Never allow metal to touch walls or door.

**Q. Sometimes the door of my microwave oven appears wavy. Is this normal?**

A. This appearance is normal and does not affect the operation of your oven.

**Q. What are the humming noises I hear when my microwave oven is operating?**

A. This is the sound of the transformer when the magnetron tube cycles on and off.

**Q. Why does the dish become hot when I microwave food in it?**

A. As the food becomes hot it will conduct the heat to the dish. Use hot pads to remove food after cooking. The dish may not be microwave safe.

**Q. What does standing time mean?**

A. Standing time means that food should be taken out of the oven and covered for additional time after cooking. This process allows the cooking to finish, saves energy, and frees the oven for other purposes.

**Q. Can I pop popcorn in my microwave oven? How do I get the best results?**

A. Yes. Pop packaged microwave popcorn following manufacturer's guidelines or use the preprogrammed Popcorn pad. Do not use regular paper bags. Use the listening test by stopping the oven as soon as the popping slows to a pop every one or two seconds. Do not try to repop unpropped kernels. You can also use special microwave poppers. When using a popper, be sure to follow manufacturer's directions. Do not pop popcorn in glass utensils.

**Q. Why does steam come out of the air exhaust vent?**

A. Steam is normally produced during cooking. The microwave oven has been designed to vent this steam out the vent.

# MAINTENANCE

## MICROWAVE UTENSIL GUIDE

USE	DO NOT USE
<p><b>OVENPROOF GLASS</b> (treated for high intensity heat): Utility dishes, loaf dishes, pie plates, cake plates, liquid measuring cups, casseroles and bowls without metallic trim.</p> <p><b>CHINA:</b> Bowls, cups, serving plates and platters without metallic trim.</p> <p><b>PLASTIC:</b> Plastic wrap (as a cover)-- lay the plastic wrap loosely over the dish and press it to the sides. Vent plastic wrap by turning back one edge slightly to allow excess steam to escape. The dish should be deep enough so that the plastic wrap will not touch the food. As the food heats it may melt the plastic wrap wherever the wrap touches the food. Use plastic dishes, cups, semirigid freezer containers and plastic bags <b>only for short cooking times. Use these with care because the plastic may soften from the heat of the food.</b></p> <p><b>PAPER:</b> Paper towels, waxed paper, paper napkins, and paper plates with no metallic trim or design. Look for the manufacturer's label for use in the microwave oven.</p>	<p><b>METAL UTENSILS:</b> Metal shields the food from microwave energy and produces uneven cooking. Also avoid metal skewers, thermometers or foil trays. Metal utensils can cause arcing, which can damage your microwave oven.</p> <p><b>METAL DECORATION:</b> Metal-trimmed or metal-banded dinnerware, casserole dishes, etc. The metal trim interferes with normal cooking and may damage the oven.</p> <p><b>ALUMINUM FOIL:</b> Avoid large sheets of aluminum foil because they hinder cooking and may cause harmful arcing. Use small pieces of foil to shield poultry legs and wings. Keep ALL aluminum foil at least 1 inch from the side walls and door of the oven.</p> <p><b>WOOD:</b> Wooden bowls and boards will dry out and may split or crack when you use them in the microwave oven. Baskets react in the same way.</p> <p><b>TIGHTLY COVERED UTENSILS:</b> Be sure to leave openings for steam to escape from covered utensils. Pierce plastic pouches of vegetables or other food items before cooking. Tightly closed pouches could explode.</p> <p><b>BROWN PAPER:</b> Avoid using brown paper bags. They absorb too much heat and could burn.</p> <p><b>FLAWED OR CHIPPED UTENSILS:</b> Any utensil that is cracked, flawed, or chipped may break in the oven.</p> <p><b>METAL TWIST TIES:</b> Remove metal twist ties from plastic or paper bags. They become hot and could cause a fire.</p>

# TROUBLE SHOOTING

## BEFORE CALLING FOR SERVICE

Check the following list to be sure a service call is really necessary. A quick reference of this manual as well as reviewing additional information on items to check may prevent an unneeded service call.

### **If nothing on the oven operates:**

- check for a blown circuit fuse or a tripped main circuit breaker.
- check if oven is properly connected to electric circuit in house.
- check that controls are set properly.

### **If the oven interior light does not work:**

- the light bulb is loose or defective.

### **If oven will not cook:**

- check that control panel was programmed correctly.
- check that door is firmly closed.
- check that Start Pad was touched.
- check that timer wasn't started instead of a cook function.

### **If oven takes longer than normal to cook or cooks too rapidly:**

- be sure the Power Level is programmed properly.

### **If the time of day clock does not always keep correct time:**

- check that the power cord is fully inserted into the outlet receptacle.
- be sure the oven is the only appliance on the electrical circuit.

### **If food cooks unevenly:**

- be sure food is evenly shaped.
- be sure food is completely defrosted before cooking.
- check placement of aluminum foil strips used to prevent overcooking.

### **If food is undercooked:**

- check recipe to be sure all directions (amount, time, and power levels) were correctly followed.
- be sure microwave oven is on a separate circuit.
- be sure food is completely defrosted before cooking.

### **If food is overcooked:**

- check recipe to be sure all directions (amount, power level, time, size of dish) were followed.

### **If arcing (sparks) occur:**

- be sure microwavable dishes were used.
- be sure wire twist ties weren't used.
- be sure oven wasn't operated when empty.
- make sure metal rack (if used) is properly installed on 4 supports.

### **If the Display shows a time counting down but the oven is not cooking:**

- check that door is firmly closed.
- check that timer wasn't started instead of a cooking function.

### **Vent fan starts automatically:**

- If the temperature gets too hot around the microwave oven, the fan in the vent hood will automatically turn on to cool the oven. It may stay on up to an hour to cool the oven.

# LG MICROWAVE OVEN LIMITED WARRANTY – USA

LG Electronics Inc. will repair or replace your product, at LG’s option, if it proves to be defective in material or workmanship under normal use, during the warranty period set forth below, effective from the date of original consumer purchase of the product. This limited warranty is good only to the original purchaser of the product and effective only when used in the United States, including U.S. Territories.

<p><b><u>WARRANTY PERIOD:</u></b></p> <p><b>Model: LMV1650SW</b> <b>LMV1650SB</b></p> <p><b>Labor: 1 Year</b> from the Date of Purchase.</p> <p><b>Parts: 1 Year</b> from the Date of Purchase.</p> <p><b>Magnetron: 10 Years</b> from the Date of Purchase.</p>	<p><b><u>HOW SERVICE IS HANDLED:</u></b></p> <p>Call 1-877-714-7486 and choose the appropriate prompt. Please have product type (Microwave) and ZIP code ready.</p>
--	---

**THIS WARRANTY IS IN LIEU OF ANY OTHER WARRANTIES, EXPRESS OR IMPLIED, INCLUDING WITHOUT LIMITATION, ANY WARRANTY OF MERCHANTABILITY OR FITNESS FOR A PARTICULAR PURPOSE. TO THE EXTENT ANY IMPLIED WARRANTY IS REQUIRED BY LAW, IT IS LIMITED IN DURATION TO THE EXPRESS WARRANTY PERIOD ABOVE. LG WILL NOT BE LIABLE FOR ANY CONSEQUENTIAL, INDIRECT, OR INCIDENTAL DAMAGES OF ANY KIND, INCLUDING LOST REVENUES OR PROFITS, IN CONNECTION WITH THE PRODUCT. SOME STATES DO NOT ALLOW LIMITATION ON HOW LONG AN IMPLIED WARRANTY LASTS OR THE EXCLUSION OF INCIDENTAL OR CONSEQUENTIAL DAMAGES, SO THE ABOVE LIMITATIONS OR EXCLUSIONS MAY NOT APPLY TO YOU.**

**THIS LIMITED WARRANTY DOES NOT APPLY TO:**

1. Service trips to your home to deliver, pick up, and/or install the product, instruct, or replace house fuses or correct wiring, or correction of unauthorized repairs; and
2. Damages or operating problems that result from misuse, abuse, operation outside environmental specifications or contrary to the requirements or precautions in the Operating Guide, accident, vermin, fire, flood, improper installation, acts of God, unauthorized modification or alteration, incorrect electrical current or voltage, or commercial use, or use for other than intended purpose.

**Therefore, the cost of repair or replacement of such a defective product shall be borne by the consumer.**

**CUSTOMER INTER-ACTIVE CENTER NUMBERS:**

<p><b>To Prove Warranty Coverage</b></p>	<p><b>Retain your Sales Receipt to prove date of purchase.</b> A copy of your Sales Receipt must be submitted at the time warranty service is provided.</p>
<p><b>To Obtain Nearest Authorized Service Center or Sales Dealer, or to Obtain Product, Customer, or Service Assistance</b></p>	<p><b>Call 1-877-714-7486</b> (Phone answered 24 hours - 365 days a year) and choose the appropriate prompt from the menu; or visit our website at: <b><a href="http://us.lgservice.com">http://us.lgservice.com</a></b>.</p>



**LG Electronics Inc.**

Printed in China



## Free Manuals Download Website

<http://myh66.com>

<http://usermanuals.us>

<http://www.somanuals.com>

<http://www.4manuals.cc>

<http://www.manual-lib.com>

<http://www.404manual.com>

<http://www.luxmanual.com>

<http://aubethermostatmanual.com>

Golf course search by state

<http://golfingnear.com>

Email search by domain

<http://emailbydomain.com>

Auto manuals search

<http://auto.somanuals.com>

TV manuals search

<http://tv.somanuals.com>