



26LT670H
32LT670H
37LT670H
42LT670H

Lodging Guest Interactive Pro:Centric™ TVs

Commercial Mode Setup Guide

Note: Selected features shown in this guide may not be available on all models.

EXPERIENCED INSTALLER

Automated Installation Routine Wizard
pages 11 – 13

Custom Master TV Setup
pages 14 – 17

Cloning Information
pages 28 – 36

FTG Mode of Operation
pages 37 – 48

For Customer Support/Service, please call:
1-888-865-3026

The latest product information and documentation is available online at:
www.LGolutions.com/products

MODEL and SERIAL NUMBER
The model and serial numbers of this TV are located on the back of the cabinet. For future reference, LG suggests that you record those numbers here:

Model No. _____ Serial No. _____



WARNING:

TO REDUCE THE RISK OF ELECTRIC SHOCK DO NOT REMOVE COVER (OR BACK). NO USER-SERVICEABLE PARTS INSIDE. REFER TO QUALIFIED SERVICE PERSONNEL.



The lightning flash with arrowhead symbol, within an equilateral triangle, is intended to alert the user to the presence of uninsulated “dangerous voltage” within the product’s enclosure that may be of sufficient magnitude to constitute a risk of electric shock to persons.



The exclamation point within an equilateral triangle is intended to alert the user to the presence of important operating and maintenance (servicing) instructions in the literature accompanying the appliance.

WARNING:

TO PREVENT FIRE OR SHOCK HAZARDS, DO NOT EXPOSE THIS PRODUCT TO RAIN OR MOISTURE.

POWER CORD POLARIZATION:

This product is equipped with a 3-wire grounding-type alternating current power plug. This plug will fit into the power outlet only one way. This is a safety feature. If you are unable to insert the plug fully into the outlet, contact your electrician to replace your obsolete outlet. Do not defeat the safety purpose of the 3-wire grounding-type plug.

NOTE TO CABLE/TV INSTALLER:

This reminder is provided to call the cable TV system installer’s attention to Article 820-40 of the National Electric Code (U.S.A.). The code provides guidelines for proper grounding and, in particular, specifies that the cable ground shall be connected to the grounding system of the building, as close to the point of the cable entry as practical.

REGULATORY INFORMATION:

This equipment has been tested and found to comply with the limits for a Class B digital device, pursuant to Part 15 of the FCC Rules. These limits are designed to provide reasonable protection against harmful interference when the equipment is operated in a residential installation. This equipment generates, uses and can radiate radio frequency energy and, if not installed and used in accordance with the instruction manual, may cause harmful interference to radio communications. However, there is no guarantee that interference will not occur in a particular installation. If this equipment does cause harmful interference to radio or television reception, which can be determined by turning the equipment off and on, the user is encouraged to try to correct the interference by one or more of the following measures:

- Reorient or relocate the receiving antenna.
- Increase the separation between the equipment and receiver.
- Connect the equipment to an outlet on a circuit different from that to which the receiver is connected.
- Consult the dealer or an experienced radio/TV technician for help.

CAUTION:

Do not attempt to modify this product in any way without written authorization from LG Electronics U.S.A., Inc. Unauthorized modification could void the user’s authority to operate this product.

COMPLIANCE:

The responsible party for this product’s compliance is: LG Electronics U.S.A., Inc.
1000 Sylvan Avenue, Englewood Cliffs, NJ 07632, USA • Phone: 1-201-816-2000

Marketed and Distributed in the United States by LG Electronics U.S.A., Inc.
1000 Sylvan Avenue, Englewood Cliffs, NJ 07632

IMPORTANT SAFETY INSTRUCTIONS

1. Read these instructions.
2. Keep these instructions.
3. Heed all warnings.
4. Follow all instructions.
5. Do not use this apparatus near water.
6. Clean only with dry cloth.
7. Do not block any ventilation openings. Install in accordance with the manufacturer's instructions.
8. Do not install near any heat sources, such as radiators, heat registers, stoves, or other apparatus (including amplifiers) that produce heat.
9. Do not defeat the safety purpose of the polarized or grounding-type plug. A polarized plug has two blades with one wider than the other. A grounding-type plug has two blades and a third grounding prong. The wide blade or the third prong are provided for your safety. If the provided plug does not fit into your outlet, consult an electrician for replacement of the obsolete outlet.
10. Protect the power cord from being walked on or pinched, particularly at plugs, convenience receptacles, and the point where it exits from the apparatus.
11. Only use attachments/accessories specified by the manufacturer.
12. Use only with the cart, stand, tripod, bracket, or table specified by the manufacturer or sold with the apparatus. When a cart is used, use caution when moving the cart/apparatus combination in order to avoid injury from tip-over.



13. Refer all servicing to qualified service personnel. Servicing is required when the apparatus has been damaged in any way, such as power-supply cord or plug is damaged, liquid has been spilled or objects have fallen into the apparatus, the apparatus has been exposed to rain or moisture, does not operate normally, or has been dropped.
14. Never touch this apparatus or antenna during a thunder or lightning storm.
15. When mounting a TV on the wall, make sure not to install the TV by the hanging power and signal cables on the back of the TV.
16. Do not allow an impact shock or any objects to fall into the product, and do not drop objects onto the screen.

17. Power Cord

Caution: It is recommended that appliances be placed upon a dedicated circuit; that is, a single outlet circuit which powers only that appliance and has no additional outlets or branch circuits. Check the specification page in the Owner's Manual to be certain.

Periodically examine the cord of your appliance, and if its appearance indicates damage or deterioration, unplug it, discontinue use of the appliance, and have the cord replaced with an exact replacement part by an authorized servicer. Protect the power cord from physical or mechanical abuse, such as twisting, kinking, or pinching or being closed in a door or walked upon. Pay particular attention to plugs, wall outlets, and the point where the cord exits the appliance.

Do not use a damaged or loose power cord. Be sure to grasp the plug when unplugging the power cord. Do not pull on the power cord to unplug the TV.

18. Overloading

Do not connect too many appliances to the same AC power outlet as this could result in fire or electric shock. Do not overload wall outlets. Overloaded wall outlets, loose or damaged wall outlets, extension cords, frayed power cords, or damaged or cracked wire insulation are dangerous. Any of these conditions could result in fire or electric shock.

19. Outdoor Use/Wet Location



Warning: To reduce the risk of fire or electrical shock, do not expose this product to rain, moisture or other liquids.

Do not touch the TV with wet hands. Do not install this product near flammable objects such as gasoline or candles or expose the TV to direct air conditioning.

Do not expose to dripping or splashing and do not place objects filled with liquids, such as vases, cups, etc., on or over the apparatus (e.g., on shelves above the unit).

20. Grounding

Ensure that you connect the earth ground wire to prevent possible electric shock (i.e., a TV with a three-prong grounded AC plug must be connected to a three-prong grounded AC outlet). If grounding methods are not possible, have a qualified electrician install a separate circuit breaker. Do not try to ground the unit by connecting it to telephone wires, lightning rods, or gas pipes.

21. Disconnect Device

The mains plug is the disconnecting device. The plug must remain readily operable.

As long as this unit is connected to the AC wall outlet, it is not disconnected from the AC power source even if you turn off this unit by SWITCH.

(Continued on next page)

IMPORTANT SAFETY INSTRUCTIONS

(Continued from previous page)

22. Outdoor Antenna Grounding

If an outside antenna or cable system is connected to the product, follow the precautions below.

An outdoor antenna system should not be located in the vicinity of overhead power lines or other electric light or power circuits or where it can come into contact with such power lines or circuits as death or serious injury can occur.

Be sure the antenna system is grounded so as to provide some protection against voltage surges and built-up static charges.

Article 810 of the National Electrical Code (NEC) in the U.S.A. provides information with respect to proper grounding of the mast and supporting structure, grounding of the lead-in wire to an antenna-discharge unit, size of grounding conductors, location of antenna-discharge unit, connection to grounding electrodes, and requirements for the grounding electrode.

Antenna Grounding According to NEC, ANSI/NFPA 70

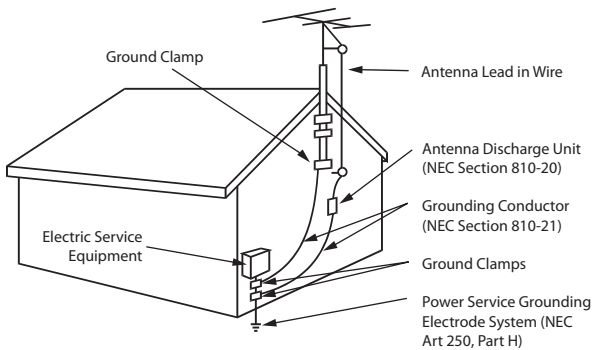

23. Cleaning

When cleaning, unplug the power cord and wipe gently with a soft cloth to prevent scratching. Do not spray water or other liquids directly on the TV as electric shock may occur. Do not clean with chemicals such as alcohol, thinners or benzene.

24. Transporting Product

Make sure the TV is turned Off and unplugged and that all cables have been removed. It may take two or more people to carry larger TVs. Do not press against or put stress on the front panel of the TV during transport.

25. Ventilation

Install the TV where there is proper ventilation. Do not install in a confined space such as a bookcase. Do not cover the TV with cloth or other materials (e.g., plastic) while it is plugged in. Do not install in excessively dusty places.

26. Do not touch the ventilation openings, as they may become hot while the TV is operating.
27. If you smell smoke or other odors coming from the TV or hear strange sounds, unplug the power cord, and contact an authorized service center.

28. Do not press against the front panel of the TV with your hand or a sharp object (e.g., a nail, pencil, or pen) or make a scratch on it.

29. Keep the product away from direct sunlight.

30. Dot Defect

The LCD panel is a high technology product with resolution of two million to six million pixels. In a very few cases, you could see fine dots on the screen while you are viewing the TV. Those dots are deactivated pixels and do not affect the performance and reliability of the TV.

31. Generated Sound

“Cracking”: A cracking noise that occurs while the TV is On or when it is turned Off is generated by plastic thermal contraction due to temperature and humidity. This noise is common for products where thermal deformation is required.

Electrical circuit humming/panel buzzing: A low level noise is generated from a high-speed switching circuit, which supplies a large amount of current to operate a product. It varies depending on the product. This generated sound does not affect the performance and reliability of the product.

32. For LCD TV

If the TV feels cold to the touch, there may be a small “flicker” when it is turned On. This is normal; there is nothing wrong with the TV. Some minute dot defects may be visible on the screen, appearing as tiny red, green, or blue spots. However, they have no adverse effect on the TV’s performance. Avoid touching the LCD screen or holding your finger(s) against it for long periods of time. Doing so may produce some temporary distortion effects on the screen.

Table of Contents

Safety Warnings	2	FTG Mode via CPU	39–43
Important Safety Instructions	3–4	Creating an FTG Configuration File using the	
Table of Contents	5	FTG File Manager	39
Commercial Mode Overview	6–8	Teaching FTG Configuration to a TV	41
Setup Checklist	6	Learning an FTG Configuration File from a TV	42
Pass-through Mode	6	Optional Manual Configuration / TV Setup	43
FTG Mode	8	FTG Mode via EBL (Local Configuration)	44
Remote Management in FTG Mode	8	FTG File Manager Utilities Overview	45–48
Pro:Centric Operation	9–10	FTG File Manager Main Screen	45
Pro:Centric TV Interactive Menu Features	9	FTG Channel Map Configuration Utility	46
Pro:Centric Interactive Menu Navigation	9	FTG Channel Map Editor	47
Pro:Centric Setup	10	FTG Installer Menu Configuration Utility	48
Automated Installation Routine Wizard	11–13	Remote Jack Pack / TV Connections & Setup	49
Pro:Centric Auto Configuration	11	References	
Pro:Centric Manual Configuration	12	Upgrading TV/PTC Software using a USB Memory	
USB Configuration	13	Device	50
Custom Master TV Setup	14–17	Downloading a Splash Screen using a USB Memory	
Before You Begin	14	Device	51
Cloning Methods	14	Power Consumption Settings	52
Clonable TV Setup Menu Features	14	TV Aux Input Configuration	53
Custom Master TV Setup Procedure	15	b-LAN Setup & Overview	54
Installer Menu	18–26	RJP Model List & Input Auto-sensing Hierarchy	55
Accessing the Installer Menu	18	Restoring Factory Defaults on the TV(s)	56
Using the Installer Menu	19	TV Zone Restrictions	57
Exiting the Installer Menu and Activating Updates	19	LT670H Rear and Side Jack Panels	58
Channel Icons / Custom Text Labels		Installer Remote Control Typical Key Functions	59
(2-5-4 + MENU Mode)	27	Troubleshooting	60–63
Cloning Overview	28	General Troubleshooting	60
USB Cloning Procedures	29–32	Troubleshooting Flow Chart	61
Learning / Teaching a Master TV Setup using		Commercial Mode Check / FTG Operation	
a USB Memory Device / .tlx File	29	Troubleshooting	62
Learning / Teaching a Master TV Setup using		Clone Programmer Troubleshooting	63
a USB Memory Device / .tll File	31	Glossary of Terms	64
Clone Programmer Cloning Procedures	33–36	Document Revision History / Open Source Software Notice	65
Learning / Teaching a Master TV Setup using		Back Cover	66
a TLL-1100A Clone Programmer	33		
Learning / Teaching a Master TV Setup using			
an LT2002 Clone Programmer	35		
FTG Mode of Operation Overview	37–38		
FTG Mode via CPU or EBL	37		
Determining the TV Operating Mode	38		

Notes

- Installer Menu content is intended for use primarily by qualified TV electronics technicians.
- Refer to the Quick Reference Guide for additional information on TV installation, features, specifications, maintenance, and safety instructions.
- Design and specifications subject to change without prior notice.

Commercial Mode Overview

This document describes how to set up LT670H Pro:Centric™ TVs for Commercial Mode operation. LG commercial TV functionality is based on “ownership” of the Channel Map; that is, the Channel Map resides in the TV’s CPU, Protocol Translator Card (PTC), or embedded *b*-LAN™ (EBL) module, or it resides externally from the TV (i.e., in a device from the solution provider).

These TV models are capable of Free-To-Guest (FTG) Mode operation via the TV CPU. Alternatively, the EBL module can be configured either for Pass-through Mode (default) or FTG Mode. When neither the CPU nor EBL is in FTG Mode, these TV models also allow external control via the TV’s MPI port.

Setup Checklist

Note: This document provides information specific to Commercial Mode operation. Refer to the Owner’s Manual for detailed information on TV installation and hardware and cable connections.

Installation

- ___ Unpack TV and all accessories.
- ___ Install batteries in the Installer Remote.
- ___ Install TV on VESA mount or stand.
Note: It may be advisable to make all cable connections before installing on VESA mount or stand, as appropriate.

Cable Connections

- ___ Make all rear jack panel and MPI card slot connections, as appropriate.

Commercial Mode Setup

- ___ Complete appropriate procedures as described in this document for Commercial Mode operation.

Hardware Connections

- ___ Install any additional hardware as appropriate to your institution, LAN, etc.

Pass-through Mode

This mode allows you to configure individual TVs for Pro:Centric or FTG Mode via CPU operation and/or create a Master TV Setup for cloning purposes for TVs that are to remain in Pass-through Mode. This mode also allows external control via the GAME CONTROL/MPI port on the TV rear jack panel.

There are two methods for configuring individual TVs that are currently in Pass-through Mode: either using the Automated Installation Routine Wizard or the Custom Master TV Setup procedure as described in this document.

Automated Installation Routine Wizard

The Automated Installation Routine Wizard provides Auto or Manual options for configuring essential items for Pro:Centric operation and also provides an option for using a USB memory device to configure the TV for FTG Mode via CPU. Use the Installer Remote to make selections and complete each step. See “Automated Installation Routine Wizard” on pages 11 to 13 for detailed information.

Custom Master TV Setup

The Custom Master TV Setup procedure enables you to create a customized Master TV Setup for cloning purposes. Use the Installer Remote to configure Installer Menu items as required for TV operation and set up TV features (Channel, Picture, Audio, etc.). See “Custom Master TV Setup” on pages 14 to 17 for detailed information.

Commercial Mode Overview (Cont.)

Installer Menu

To create a Master TV Setup, you will need to know how to access the commercial controller (PTC) Installer Menu and make changes to the default values as required. If necessary, familiarize yourself with the Installer Menu and how to make and save changes. Refer to pages 18 to 26 for information on accessing the Installer Menu and for detailed descriptions of the Installer Menu items.

TV Setup Menus

On-screen setup menus control the features of the TV. Use the Installer Remote to access the TV setup menus, and set the TV features to the desired configuration for the end user.

Cloning

Cloning refers to the process of capturing a Master TV Setup and transferring it to a Target TV— both TVs must be in Pass-through Mode and both TVs must be identical models. The Master TV's clonable setup menu features should be configured as part of the Master TV Setup. If there are features in the Master TV's setup—channel icons or labels, digital font options, etc.—that are not set or that are set incorrectly, those features also will not be set or will be set incorrectly in the Target TVs. Refer to pages 28 to 36 for detailed information on cloning requirements and procedures.

External MPI Control

To control the TV using an external MPI control device, you must use the TV's GAME CONTROL/MPI port for communication purposes. In these TVs, Installer Menu item 118 POWER SAVINGS controls the power circuitry for both the embedded *b*-LAN module and the GAME CONTROL/MPI port; therefore, to ensure that the GAME CONTROL/MPI port circuitry is powered, thus enabling MPI communication, Installer Menu item 118 POWER SAVINGS must be set appropriately. See Installer Menu item descriptions as well as Reference section, "*b*-LAN Setup & Overview," for further information.

Note: These TV models are not equipped with MPI card slots.

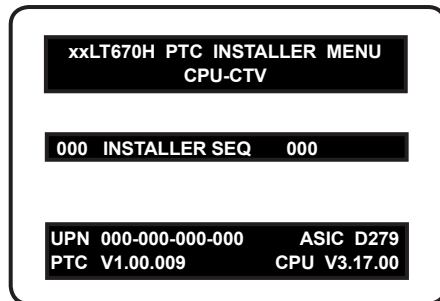

Typical Installer Menu

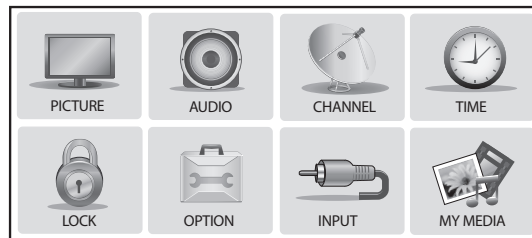

TV Setup Menus

Commercial Mode Overview (Cont.)

FTG Mode

This mode enables Pro:Idiom[®] decryption and also allows logical channel mapping of physical channels to remove the need for dash tuning. TV operation in FTG Mode is based on which element of the TV owns the FTG Logical Channel Map—the CPU or the EBL. Understanding the application in which the TV will be used is vital in determining the owner.

As indicated above, FTG mode operation in the LT670H models can be provided either by the TV CPU or EBL. These are two separate and distinct FTG Modes of operation, each with its own unique advantages and requirements as described later in this document. When the TV CPU is configured with an FTG Channel Map, the CPU controls the operation of the TV, and when the EBL is configured with an FTG Channel Map, the EBL controls the operation of the TV.

Once it is determined whether the TV CPU or the EBL will own the FTG Channel Map, configuration can begin. Configuration of either requires a PC application—the LG FTG File Manager for the TV CPU or the LG FTG Device Configuration Application for the EBL. Each application provides utilities that enable you to create/edit an FTG Channel Map and configure Installer Menu settings. See pages 37 to 48 for further information on FTG Mode operation and configuration.

Remote Management in FTG Mode

When the TV is configured for FTG Mode via CPU, remote management of the FTG Channel Map and FTG Installer Menu settings is provided by a Pro:Centric server. Refer to the **Pro:Centric™ Server Admin Client User Guide** for further information.

When the TV is configured for FTG Mode via EBL, the *b*-LAN module, which is internal to the TV, allows hotel/institution head end equipment (for example, an FMA-LG101) with *b*-LAN technology to communicate with the TV to provide remote management of the FTG Channel Map and FTG Installer Menu settings. See Reference section, “*b*-LAN Setup & Overview,” for further information.

Pro:Centric TV Interactive Menu Features

When running the Pro:Centric application, the interactive Pro:Centric TV enables guests to locate and select television entertainment using an interactive channel guide, check the daily weather, and view hotel and surrounding amenities via custom billboards and points-of-interest maps.

Pro:Centric application features include:

- Portal and information screens/pages (including a “Welcome” page) that include branding logos.
- An optional customized user interface (custom “skins”).
- Billboards and points-of-interest maps that can be customized to focus on hotel amenities, local attractions and businesses, restaurants, news, events, etc.
- An optional Weather billboard that includes a local radar map, current conditions, and a four day forecast.
- An interactive channel guide that provides a channel list with channel icons. An electronic program guide (EPG) is an optional feature that displays up to three days of programming information viewable by channel and time.
- Video spooling that enables the hotel to deliver a video file to guest TVs for promotion and information purposes.

The Pro:Centric server Admin Client web editor/content wizard is provided for customer configuration of portal messages and billboards/maps.

Note: Customized content is typically defined by the service integrator and/or hotel administrators. LG does not provide hotel-specific content.

Pro:Centric Interactive Menu Navigation

Use the Pro:Centric TV remote control to operate both interactive menus and regular TV features. Press **PORTAL** on the remote to access the interactive menus.

Note: Interactive menu options may vary, depending on Pro:Centric features enabled for the site. The following are default interactive menus.



Channel Guide

Shows available TV networks and logical channels. When available, EPG data provides additional channel and program information.

Information

Typically displays information on hotel amenities, for example, restaurants, in-room dining, business centers, facilities, etc., as well as information on local weather and attractions.

Help

Provides help for navigating the interactive menus.

Watch TV

Removes the interactive menu from the screen and returns to the previously tuned TV channel.

Pro:Centric Operation (Cont.)

Pro:Centric Setup

Administration and management options for the Pro:Centric server are described in detail in the **Pro:Centric™ Server Admin Client User Guide**. This document describes only those settings that must be specified on the TVs.

On the TVs, the Data Channel must be set appropriately to enable Pro:Centric remote management/administration facilities, while the Pro:Centric Application Mode must be set appropriately to enable the Pro:Centric application.

- Remote management/administration (TV E-Z Installation): The Pro:Centric server Admin Client provides remote management/administration facilities for downloading splash screens and software/firmware updates as well as facilities for downloading the FTG Channel Map and FTG Installer Menu settings for TVs that are in FTG Mode via CPU.
- Pro:Centric application: The application, which operates in conjunction with FTG and PPV Modes, comprises the Pro:Centric interactive menus/features described on the previous page. Pro:Centric application settings are managed via the Pro:Centric Admin Client.

The Data Channel and Pro:Centric Application Mode can be set using one of the following methods:

- When the TV is in a factory default state, the Automated Installation Routine Wizard provides Auto or Manual options for configuring both the Data Channel and the Pro:Centric Application Mode.

The Automated Installation Routine Wizard also provides a USB Configuration option that enables you to configure a TV for FTG Mode via CPU using an FTG Configuration (.tlx) file stored on a USB memory device. The FTG Configuration file incorporates FTG Installer Menu settings, which includes Installer Menu items 098 PRO:CENTRIC and 119 DATA CHANNEL.

Refer to “Automated Installation Routine Wizard” on pages 11 to 13 for further information on the Automated Installation Routine Wizard options.

- If the TV is in Pass-through Mode, set Installer Menu items 098 PRO:CENTRIC and 119 DATA CHANNEL to the appropriate values. Refer to “Installer Menu” information on pages 18 to 26 for further information. Also, as necessary, refer to “Custom Master TV Setup” information on pages 14 to 17 and/or cloning information on pages 28 to 36.
- If the TV is in FTG Mode (via CPU or EBL), use the appropriate software to update Installer Menu items 098 PRO:CENTRIC and 119 DATA CHANNEL and then transfer the FTG Installer Menu settings to the TV in accordance with the FTG Mode of configuration. Refer to FTG Mode information on pages 37 to 48 for further information.

Automated Installation Routine Wizard

The Automated Installation Routine Wizard will appear on the screen each time the TV is turned ON, until one of its configuration methods has been completed or the wizard is exited. The wizard's Welcome screen provides a selection of configuration methods: Auto or Manual options for configuring essential items for Pro:Centric operation and also an option for using a USB memory device to configure the TV for FTG Mode via CPU. This section describes each of the Automated Installation Routine Wizard options.

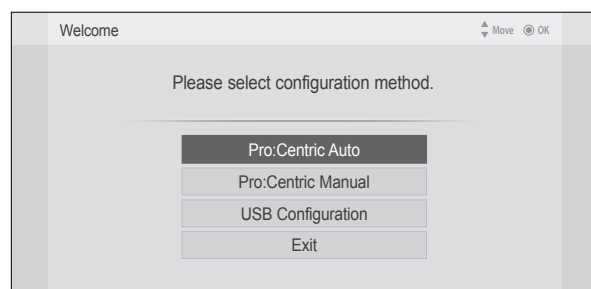

Note: If it has been completed or exited and therefore does not display, the Automated Installation Routine Wizard can be re-activated; however, this requires that factory defaults be restored on the TV(s). Refer to Reference section, “Restoring Factory Defaults on the TV(s),” for further information.

Note: If you plan to create a Master TV Setup using the procedure on pages 14 to 17, be sure to exit the Automated Installation Routine Wizard in order to avoid setting modes that may restrict the custom setup procedure.

Note: If any of the configuration steps fails, you will see an “Incomplete” screen with an indication of the failure. You will then have the opportunity to reinitiate the current configuration process, select another configuration method (for example to select Pro:Centric Manual instead of Auto configuration), or exit the Automated Installation Routine Wizard.

Caution: Do NOT unplug the TV power cord or remove the antenna cable during any of the configuration processes, as doing so will interrupt the current step and may corrupt the configuration data.

To exit the Automated Installation Routine Wizard, use the Up/Down arrow keys on the Installer Remote to select/highlight **Exit**. Then, press **OK**.

Pro:Centric Auto Configuration

When selected, this option enables the TV to use a search algorithm to automatically determine the type of Pro:Centric network, the Data Channel, and the Pro:Centric Application Mode. The TV then looks for the Pro:Centric application and maintenance (E-Z Installation) files to download.

Note: If you intend to use the Pro:Centric server for remote management only of E-Z Installation (splash screen, configuration, or firmware) data downloads, use the “Pro:Centric Manual” option described on the following page.

Use the Up/Down arrow keys on the Installer Remote to select/highlight **Pro:Centric Auto** from the Automated Installation Routine Wizard Welcome screen. Then, press **OK**.

The Pro:Centric Auto Configuration will proceed with a series of automated steps to configure the TV for Pro:Centric operation and to download the Pro:Centric application and E-Z Installation data. The Auto Configuration screen (see example at right) shows overall progress, as well as the progress and/or values for each of the individual installation steps. Note that some steps may require up to 15 minutes.

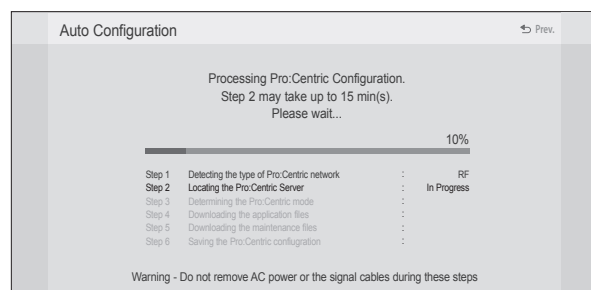

When the Pro:Centric Auto Configuration is complete, the wizard exits, and the TV will turn OFF.

Automated Installation Routine Wizard (Cont.)

Pro:Centric Manual Configuration

If you already know the required Data Channel and Pro:Centric Application Mode settings for the TV, you may streamline the setup process by entering this data manually.

1. Use the Up/Down arrow keys on the Installer Remote to select/highlight **Pro:Centric Manual** from the Automated Installation Routine Wizard Welcome screen. Then, press **OK**.
2. The first Manual Configuration Screen (see example at right) enables you to specify the following data:
 - Pro:Centric Mode: Use the Left/Right arrow keys to select the appropriate Pro:Centric Application Mode (GEM, FLASH, or Configuration Only).
 - Channel Number: Either directly enter or use the Left/Right arrow keys to select the Data Channel.

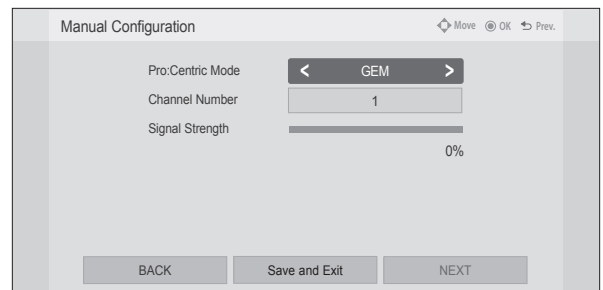

Note: For remote management only, select the Pro:Centric Mode “Configuration Only” option to search for TV E-Z Installation (splash screen, configuration, or firmware) data downloads. Pro:Centric application data will not be downloaded.

Note: Select the “Back” button from the Manual Configuration screen or press the ⏪ key on the Installer Remote, if desired, to return to the Welcome screen.

3. Once you have specified the data as indicated above, you have two options:
 - To save the data entered and exit the wizard, use the arrow keys to select **Save and Exit**, and then press **OK**. The Pro:Centric application and/or E-Z Installation data will be downloaded to the TV at a later time. This option is useful, in particular, if the Pro:Centric server is not yet set up.
 - To initiate a real-time download of Pro:Centric application and/or E-Z Installation data, use the arrow keys to select **Next**, and then press **OK**.

Note: Signal must be detected on the Data Channel from the Pro:Centric server in order for you to select “Next” (you should see a “Data Channel found” message below the signal strength indicator).

The Pro:Centric Manual Configuration will proceed with the remaining Pro:Centric application and/or E-Z Installation data download steps, as shown on the second Manual Configuration screen (see example at right). When the Pro:Centric Manual Configuration is complete, the wizard exits, and the TV will turn OFF.

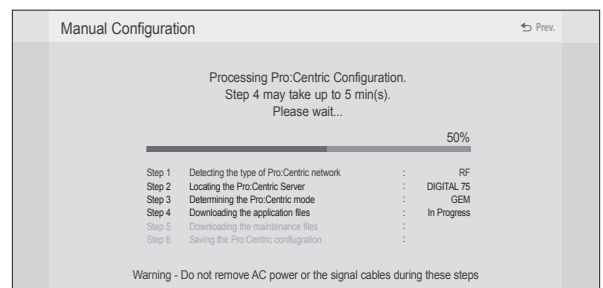

Automated Installation Routine Wizard (Cont.)

USB Configuration

This section describes how to configure a TV for FTG Mode via CPU operation using an FTG Configuration (.tlx) file loaded on a USB memory device.

Note: Refer to the *Free-To-Guest (FTG) File Manager User Guide* and/or “Creating an FTG Configuration File using the FTG File Manager” on pages 39 to 40 for information on creating an FTG Configuration (.tlx) file.

Note: This procedure assumes that the FTG Configuration file contains an FTG Channel Map. If not, any Installer Menu and/or TV setup menu settings contained in the file will be transferred to the TV (as with typical cloning); however, the TV will remain in Pass-through Mode and will not be configured for FTG Mode via CPU.

1. Plug the USB memory device that contains the FTG Configuration (.tlx) file into the Target LT670H TV USB IN port.
2. Use the Up/Down arrow keys on the Installer Remote to select/highlight **USB Configuration** from the Automated Installation Routine Wizard Welcome screen. Then, press **OK**.
3. In the Accessing USB Storage Device window, use the Up/Down arrow keys to select the FTG Configuration file you wish to use to configure this TV, and then press **OK**.

The TV will show configuration progress in a new window. Do NOT remove the USB device until configuration is complete. When the configuration is complete, the TV will briefly display a “Complete” window and then exit the Automated Installation Routine Wizard.

4. Remove the USB memory device, and verify that the FTG Configuration is resident on the Target TV.

The Target TV CPU is now in FTG Mode.

Note: After the configuration process is complete, the TV tunes according to the Start Channel setting in the Installer Menu. If a Start Channel is specified, the TV will tune to that channel; otherwise, the TV will tune to the lowest logical channel in the FTG Channel Map.

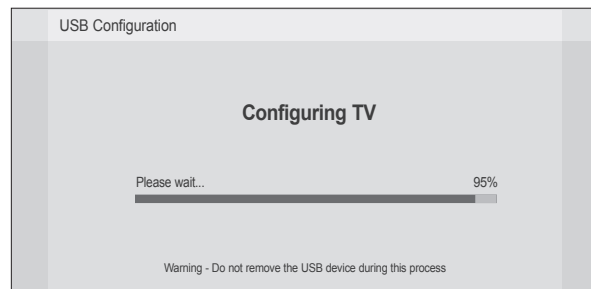
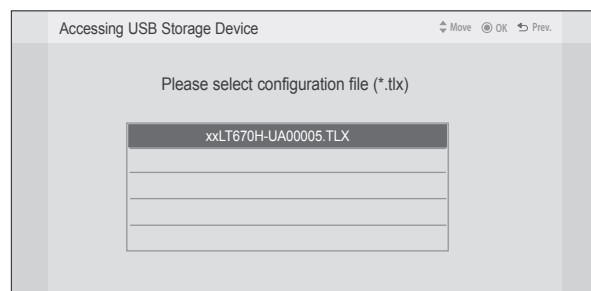

Custom Master TV Setup

This section describes how to create a customized Master TV Setup for cloning purposes when the TV is in Pass-through Mode.

Note: Refer to FTG Mode information on pages 37 to 48 for details on entering FTG Mode and configuring/editing the FTG Channel Map and FTG Installer Menu settings.

Note: Cloning requirements and procedures are described in detail on pages 28 to 36.

Before You Begin

- It is recommended that you disconnect all Aux inputs if you intend to run Auto Tuning (Channel Search). Under certain conditions, Auto Tuning is disabled if there is an Aux input active.
- Determine which cloning tool—USB memory device or clone programmer—is appropriate for your application; several of the Master TV Setup procedure steps are dependent on the cloning tool to be used. See “Cloning Methods” at right for further information.
- If you intend to use a USB memory device, determine the type of file—either the new “.tlx” file format or the legacy “.tll” file format—to use for cloning purposes; several of the Master TV Setup procedure steps are dependent on the desired file type. See “Cloning Methods” at right for further information.
- If the Automated Installation Routine Wizard appears on the screen, exit the wizard before beginning/continuing the Custom Master TV Setup procedure.

Cloning Methods

See also “Clonable TV Setup Menu Features” list below.

Using a USB Memory Device / .tlx File

- The .tlx file format clones Installer Menu settings and all TV sources’ (analog, digital, AV1, HDMI, etc.) clonable setup menu settings.
- Not intended for cloning an auto-tuned/edited Channel Map, as the channel lineup is converted to a logical FTG Channel Map when saved (Learned) from a TV to a .tlx file. If the .tlx file with the FTG Channel Map is then used for Teaching purposes, all Target TVs will be configured for FTG Mode via CPU.

Using a USB Memory Device / .tll File

The .tll file format clones the contents of the commercial controller (PTC) memory, including an auto-tuned/edited Channel Map, Installer Menu settings, and one TV source’s (analog, digital, or Aux) clonable setup menu settings.

Using a Clone Programmer (TLL-1100A or LT2002)

Both the TLL-1100A and LT2002 clone the contents of the commercial controller (PTC) memory, including an auto-tuned/edited Channel Map, Installer Menu settings, and one TV source’s (analog or Aux) clonable setup menu settings.

Clonable TV Setup Menu Features

Channel Auto Tuning (Channel Lineup) Manual Tuning Channel Edit Channel Label	Audio Auto Volume Clear Voice Sound Mode Balance TV Speaker	Option Menu Language Audio Language Caption
Picture Picture Mode	Time Auto Clock Auto Off (Sleep Timer)	Lock Movie Rating TV Rating – Children TV Rating – General

Note: Some menu options vary between analog and digital channels and Aux inputs.

Custom Master TV Setup Procedure

1. Turn ON the TV.

If the Automated Installation Routine Wizard appears on the screen when you turn ON the TV, use the Up/Down arrow keys on the Installer Remote to select **Exit** from the Welcome screen, and press **OK** to exit the wizard.

2. Set Installer Menu items.

This step provides specific instruction only on the Installer Menu items that should be set on a Master TV. Refer to pages 18 to 26 for detailed information on all Installer Menu items.

- a) Use the Installer Remote to access the PTC Installer Menu (see “Accessing the Installer Menu” on page 18 for further information).

The next step depends on whether the Automated Installation Routine Wizard appeared when you turned ON the TV:

- If the wizard did appear, the TV is in a factory default state, and you can proceed to set Installer Menu items. Go to step (c).
- If the wizard did not appear, go to step (b).

- b) Set Installer Menu item **117 FACT DEFAULT** to **001** and press **OK** on the Installer Remote.

This clears all Installer Menu custom settings, channel lineup, etc. and restores the factory default settings. The value will change back to 0 after the PTC has been restored to factory default condition. This step ensures that the TV Channel Memory will be the active channel lineup.

- c) Set Installer Menu item **003 BAND/AFC**, as appropriate.

- Broadcast: Set to 000.
- HRC: Set to 002.
- CATV: Set to 001 (default).
- IRC: Set to 003.

- d) Set any other Installer Menu items that affect your TV programming network to the required configuration. For example, enable/disable Aux inputs, set a Start Channel, etc.

- e) After you have adjusted all Installer Menu item settings as required, press **OK** once on the Installer Remote to save your changes; then, press **OK** again to exit the menu.

Note: If you performed step (b) above to restore factory defaults, the Automated Installation Routine Wizard will re-activate as soon as you exit the Installer Menu. Exit the wizard (see step 1), and then continue with step 3.

3. Set up TV features.

On-screen setup menus control the features of the TV. Press **MENU SETTINGS** on the Installer Remote to access the TV setup menus, and then set Channel, Picture, Audio, Lock, Time, etc. options to the desired configurations. See “Clonable TV Setup Menu Features” list on previous page and also notes on the following page.

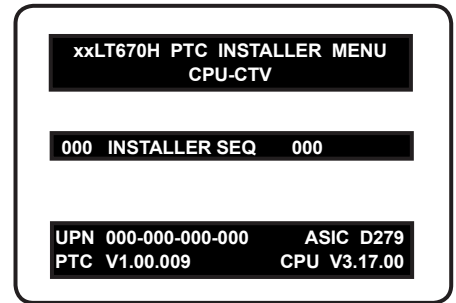

Typical Installer Menu

Note: The Installer Menu header will vary depending on the TV you are setting up.

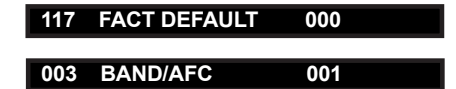

Adjust the values for these Installer Menu items, as required.

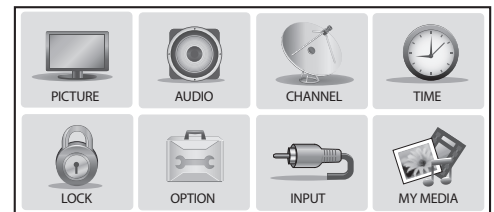

Use the TV setup menus to set the TV features to the desired configuration for the end user.

(Continued on next page)

Custom Master TV Setup (Cont.)

(Continued from previous page)

Note: If you intend to clone the PTC, remember that only one TV source's clonable setup menu settings will be cloned. Thus, for a clone programmer, the TV setup menu settings should be applicable to either an analog channel or Aux input, while for a USB device / .tll file, the TV setup menu settings should be applicable to the analog or digital channel or Aux input to which the Target TV will be set during the Teaching process.

Note: If desired and if appropriate depending on the cloning method to be used (see "Cloning Methods" on page 14), you can run Auto Tuning (see step 4) prior to completing this step.

4. (Optional) Run Auto Tuning.



Note: If you intend to use a USB memory device / .tll file for cloning purposes, DO NOT run Auto Tuning. If you Teach a .tll file with an auto-tuned/edited Channel Map to a Target TV, this will put the Target TV in FTG Mode via CPU. Proceed to step 6 to verify the TV setup. (Steps 5 and 6 are not applicable for .tll files.)

If you run Auto Tuning with the intention to clone the resulting Channel Map, you must use a USB memory device / .tll file or a clone programmer for this cloning purpose.

- a) To search for all available analog and digital channels, go to the Channel Menu, select the **Auto Tuning** option, and follow the on-screen instructions.
- b) Use the **Channel Edit** option in the Channel Menu to edit the channel lineup, as necessary, to include only free to guest (non-encrypted) channels.
 - Add/delete channels per your system requirements.
 - Use the **Channel Label** option in the Channel Menu to select the appropriate trademark/icon for each channel's Channel-Time on-screen display. Icons are available for familiar channels, such as ABC, CBS, NBC, etc. Identifiable labels (icons) should enable the end user to readily know what common networks are available.

Note: If you intend to clone the PTC and Installer Menu item 103 ATSC TUNE MODE is set for Physical Channel tuning (default and recommended setting), channels with minor channel numbers higher than 255 will not transfer correctly in step 5. If item 103 is set for Virtual Channel tuning and either the major or minor channel numbers are higher than 255, the channel(s) will not transfer correctly in step 5.

Note: If you intend to clone the PTC, you can add the channel icons in this step or as described in step 6. Also in step 6, you can add custom text labels for channels without icons.

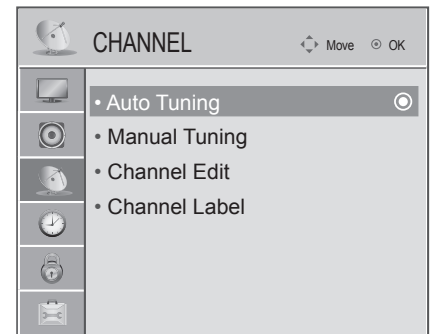

(Optional) Use Channel Menu options to run Auto Tuning, edit channels, and select channel icons.

(Continued on next page)

(Continued from previous page)

5. Transfer the TV setup menu settings to the commercial controller (PTC):

2-5-5 + MENU Mode



Note: This step is essential for successful cloning using a USB memory device / .tll file or a clone programmer. Without this step, the PTC will not contain any of the TV setup menu settings.



Note: The maximum number of channels (analog, digital, and Aux inputs) that can be transferred to the PTC is 141. An attempt to transfer more than 141 channels of any combination will result in a Channel Map of exactly 141 channels; any extra channels will not be available in the PTC Channel Map. For example, if you enabled three Aux inputs in the Installer Menu and Auto Tuning found 141 channels, you must edit the Channel Map to decrease the number of analog/digital channels to (at most) 138.

- a) After the TV channel lineup has been edited and channel label icons added, tune to the channel (source) for which you wish to transfer TV setup menu settings.

Note: If you intend to use a clone programmer for cloning purposes, this must be either an analog channel or Aux input.

- b) Access the Installer Menu, and press **2-5-5 + MENU SETTINGS** on the Installer Remote to initiate the transfer of the Master TV Setup to the PTC. The TV exits the Installer Menu and then tunes through the channels in the channel lineup during the transfer. When the transfer is complete, the TV tunes back to the channel that was tuned before the transfer began.

6. (Optional) Add Custom Channel and Aux Input Labels:

2-5-4 + MENU Mode

Note: 2-5-4 + MENU Mode enables you to add/edit channel icons and custom text labels in the PTC once the Master TV Setup has been transferred as described in the previous step.

Access the Installer Menu, and press **2-5-4 + MENU SETTINGS** on the Installer Remote. Add/edit custom text labels and/or change icons for the Channel-Time on-screen displays (see 2-5-4 + MENU procedural information on page 27). Note that broadcast digital channels often already have a broadcaster generated label. When you are finished, press **MENU SETTINGS** to exit 2-5-4 + MENU Mode.

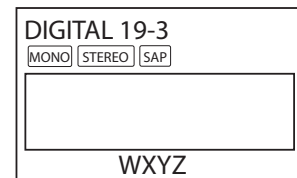

Custom text label "WXYZ" created in 2-5-4 + MENU Mode.

7. Verify the TV setup.

As applicable, verify that the channel lineup, channel icons, and custom text labels are correct. Also, make sure the TV features are set per your requirements.

8. (Recommended) Lock the channel lineup.

Access the Installer Menu. Set item **028 CH. OVERRIDE** to **000** and press **OK** to lock the channel lineup and restrict access to the TV setup menus. Press **OK** again to save your changes and exit the Installer Menu.*

The Master TV Setup is now ready to be copied to the predetermined cloning tool—a USB memory device (.tll or .tll file) or a clone programmer. See cloning procedures in this document.

028 CH. OVERRIDE 000

After verifying the TV Setup, set Installer Menu item 028 CH. OVERRIDE to 000.*

* This step prevents end users from accessing channel settings (i.e., the Channel Menu will be inaccessible/grayed out).

Installer Menu

Use the Installer Menu to set up, change, or view operational settings. Refer to the table starting on the next page for brief descriptions of Installer Menu items. More detailed descriptions follow the table listing.

Accessing the Installer Menu

1. Turn ON the TV.

If the Automated Installation Routine Wizard appears on the screen when you turn ON the TV, use the Up/Down arrow keys on the Installer Remote to select **Exit** from the Welcome screen, and press **OK** to exit the wizard.

2. Using an Installer Remote, press **MENU SETTINGS** repeatedly until the on-screen display of the TV setup menus (if the TV is in Pass-through Mode) or the Function Menu (if the TV is not in Pass-through Mode) no longer toggles, and then press the Installer Menu entry sequence (e.g., **9-8-7-6**) + **OK** to access the Installer Menu.

Note: The default Installer Menu entry sequence is “9876”; however, if Installer Menu item 000 INSTALLER SEQUENCE has been modified, the entry sequence may be one of three additional options. See Installer Menu detailed descriptions for further information.

The Installer Menu opens with item 000 INSTALLER SEQ 000.

Note: If the password (entry sequence) is not entered or registered correctly, you will see the message “ENTER PASSWORD 0000” at the top of the screen instead of the Installer Menu header. Once you re-enter the correct password (e.g., press 9-8-7-6 + OK), the Installer Menu will display.

Note: If the TV is not in Pass-through Mode, the Installer Menu is accessible as read-only.

As part of the Installer Menu header, two 3-character acronyms are displayed to indicate the TV’s current configuration mode. The table below lists all possible mode identifiers for these TV models.

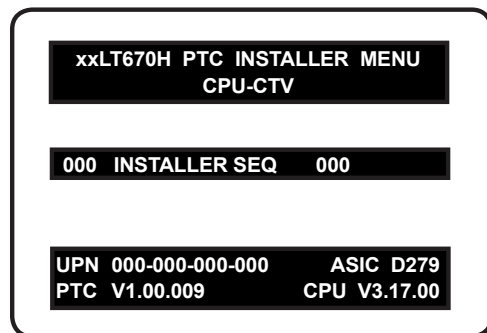

Typical Installer Menu

Acronym	Description
CPU-CTV	Pass-through Mode with Channel Map in CPU
CPU-FTG	FTG Mode via CPU
EBL-FTG	FTG Mode via EBL
EBL-LNT	LodgeNet PPV Mode
MPI-EXT	External MPI Control
PTC-CTV	Pass-through Mode with Channel Map in PTC

Using the Installer Menu

Refer to the table on pages 20 and 21 for an overview of the available Installer Menu items, including their item numbers, functions, value ranges, and default values.

Installer Menu items not relevant to these TV models are not present in the Installer Menu; therefore, some numbers are missing. For example, item 006 will not appear. In addition, items that are dependent on other Installer Menu item settings will not be initially accessible. For example, item 046 STRT AUX SRCE will not display in the Installer Menu unless item 004 STRT CHANNEL is set to 0.

Navigation within the Installer Menu

Use the Up/Down arrow keys on the Installer Remote to sequence through the available menu items, or access an item directly by keying in the item number and then pressing **MENU SETTINGS**. For example, to access the SLEEP TIMER option, which is item 015, press 0-1-5 + MENU.

Changing Installer Menu Settings

To change an Installer Menu item value, use the Left/Right arrow keys on the Installer Remote, or enter a valid value directly. To save the new setting, press **OK**, or use the Up/Down arrow keys to navigate to a new Installer Menu item if you have additional items to edit. Note that invalid values will not be saved.

Exiting the Installer Menu and Activating Updates

After you have adjusted all required Installer Menu item settings, press **OK** once on the Installer Remote to save your changes; then, press **OK** again to exit the Installer Menu. Any changes you make will be stored in non-volatile memory.

Note: Each time you exit the Installer Menu in Pass-through Mode, all V-Chip (Parental Control) settings in the TV are reset to their default values; that is, the Lock System, if previously enabled from the Lock setup menu (see the Owner's Manual for additional information), will now be disabled, and the individual Parental Control settings will be restored to default values.

Installer Menu (Cont.)

Installer Menu Items 000 through 075

Menu Item	Function	Value Range	Default Value	Brief Description of Function and Comments
000	INSTALLER SEQ	0 ~ 3	0	Leave default set to 0.
001	POWER MANAGE	0 ~ 7	0	Sets number of hours of no activity before automatic shutoff.
002	AC ON	0 / 1	0	Set to 1 to enable Auto Turn ON when AC power is applied.
003	BAND/AFC	0 ~ 3	1	Selects Tuning Band: 0=Broadcast, 1=CATV, 2=HRC, 3=IRC
004	STRT CHANNEL	0 ~ 127, 255	255	Channel tuned when TV is turned ON. (Set to 255 to tune to channel tuned before TV turned OFF.)
005	CHAN LOCK	0 / 1	0	If set to 1, cannot tune from current channel.
007	STRT VOLUME	0 ~ 63, 255	255	Volume level when TV is turned ON. (Set to 255 to use volume level before TV turned OFF.)
008	MIN VOLUME	0 ~ 63	0	Sets minimum allowable volume setting.
009	MAX VOLUME	0 ~ 63	63	Sets maximum allowable volume setting.
010	MUTE DISABLE	0 / 1	0	Set to 1 to disable Mute Function.
011	KEY DEFEAT	0 / 1	0	Set to 1 to disable menu navigation keys on display panel.
015	SLEEP TIMER	0 / 1	1	Set to 1 to enable Sleep Timer.
016	EN TIMER	0 / 1	0	Set to 1 to enable On/Off Timers.
017	ALARM	0 / 1	1	Set to 1 to enable Alarm.
020	FEATURE LEVEL	0, 16 ~ 24	0	Determines an additional IR code scheme to which the TV will respond.
021	V-CHIP	0 / 1	1	Set to 1 to enable V-Chip (Parental Control) functions.
022	MAX BLK HRS	0 ~ 99	12	Sets number of V-Chip blocking hours.
023	CAPTION LOCK	0 / 1	0	Set to 1 to retain caption setting set before TV turned OFF.
028	CH. OVERRIDE	0 / 1	1	If set to 0, limits direct access to favorite channels.
029	OLD OCV	0 / 1	0	Set to 1 to change MPI operation to OCV.
030	ACK MASK	0 / 1	0	If set to 1, enables ACK feature of MPI.
031	POLL RATE	20 ~ 169	94	Selects poll rate for MPI.
032	TIMING PULSE	186 ~ 227	207	Sets baud rate for MPI.
035	HDMI1 ENABLE	0 / 1	1	Set to 0 to disable HDMI 1. Set to 1 enable HDMI 1.
039	REAR AUX EN.	0 / 1	1	Set to 1 to enable display panel Video 1 input jack.
041	SIMPLINK EN	0 ~ 3	0	Determines the status of the SIMPLINK feature. (See detailed descriptions.)
046	STRT AUX SRCE	1, 3 ~ 5, 7, 255	7	Sets the starting Aux source (if item 004 STRT CHANNEL is set to 0).
047	AUX STATUS	0 / 1	0	Set to 1 for MPI Aux source to be reported as a channel number instead of Channel 0.
053	DIS. CH-TIME	0 / 1	0	Set to 1 to disable Channel-Time display.
069	EN. CH-T COL.	0 / 1	1	Set to 1 to enable custom color for the Channel-Time display.
070	FOR. CH-TIME	0 ~ 7	2	Chooses custom foreground color for the Channel-Time display.
071	BCK. CH-TIME	0 ~ 7	2	Chooses custom background color for the Channel-Time display.
073	CH NOT AVBLE	0 / 1	0	If set to 1 and item 028 CH. OVERRIDE is set to 0, "NOT AVAILABLE" message is displayed if user direct tunes a channel that is not in the favorite channel list.
075	REVERT CH	0 / 1	0	If set to 1 and loss of MPI communication occurs, TV tunes to Start Channel.

Installer Menu Items 078 through 122

Menu Item	Function	Value Range	Default Value	Brief Description of Function and Comments
078	UPN MSB	0 ~ 255	0	User programmable number, most significant byte.
079	UPN MSB-1	0 ~ 255	0	User programmable number, most significant byte - 1.
080	UPN MSB-2	0 ~ 255	0	User programmable number, most significant byte - 2.
081	UPN LSB	0 ~ 255	0	User programmable number, least significant byte.
082	CHKSM ERROR	0 / 1	1	Enforces rigid MPI checksum.
083	HANDSHK TIME	0 ~ 5	5	Relaxes MPI timing to be compatible with PC-based Windows-controlled systems.
084	PERMANENT BLK	0 / 1	0	Removes block hours setting for Parental Control and makes block permanent.
087	REAR RGB EN.	0 / 1 / 17	1	Dependent on item 093 RJP AVAILABLE setting. Set to 0 to disable RGB input. Set to 1 to enable RGB input. Set to 17 for Auto Configure.
088	EN NOISE MUTE	0 / 1	1	If set to 1, audio is muted if no signal is present.
090	KEY LOCK	0 / 1	0	If set to 1, keyboard is locked out, IR is still functional.
091	HDMI2 ENABLE	0 / 1	1	Set to 0 to disable HDMI 2. Set to 1 to enable HDMI 2.
092	HDMI3 ENABLE	0 / 1	1	Set to 0 to disable HDMI 3. Set to 1 to enable HDMI 3.
093	RJP AVAILABLE	0, 1, 2, 5, 6	0	Set to 0 to disable. Set to 1, 2, 5, or 6 for HDMI or DVI Mode. (See detailed descriptions.)
094	SAP MENU EN	0 / 1	1	Set to 0 to disable feature on Function Menu. Set to 1 to enable feature on Function Menu.
096	DEF. ASP. RATIO	0 ~ 4	2	Sets default aspect ratio at power up. See detailed descriptions and item 106.
098	PRO:CENTRIC	0 ~ 2	0	Set to 0 to disable Pro:Centric operation. Set to 1 for Flash Mode. Set to 2 for GEM (Java Application) Mode.
099	BACK LIGHTING	1 ~ 100, 101 ~ 200, 255	100	Sets the level of the TV picture back lighting. (See detailed descriptions.)
102	ATSC BAND	0 ~ 4	4	Selects ATSC band.
103	ATSC TUNE MODE	0 / 1	1	Set to 1 (default) for Physical Channel scan. Set to 0 for Virtual Channel scan.
104	START MINOR CH	0 ~ 255	0	Selects Minor Start Channel. Set to 0 for NTSC.
106	ASP RATIO LOCK	0 / 1	0	To retain set aspect ratio on power cycle, set to 1. Set to 0 for default ratio on power cycle.
116	VIDEO MUTE EN	0 / 1	0	Set to 0 for Normal. Set to 1 for Blank.
117	FACT DEFAULT	0 / 1	0	Set to 0 for Normal. Set to 1 to load presets for all Installer Menu settings.
118	POWER SAVINGS	1 / 3	3	Set to 3 (default— <i>b</i> -LAN module only powered when TV is turned ON), or set to 1 (<i>b</i> -LAN module is always powered). (See detailed descriptions.)
119	DATA CHANNEL	0 ~ 135	0	Set to 0 to disable. Set to the RF channel number of the Data Channel for Pro:Centric or TV E-Z Installation data. (See detailed descriptions.)
121	P:C RF WAKE HR	0 ~ 23, 128	128	Sets the hour for Wake On RF. The value "128" is displayed as "OFF." Directly entering 128 turns the Wake On RF feature OFF.
122	P:C RF WAKE MN	0 ~ 59	0	Sets the minute for Wake On RF.



Caution: Installer Menu settings may affect options available from the TV setup menus or the Function Menu.

Installer Menu (Cont.)

Detailed Descriptions of Installer Menu Items

000 - INSTALLER SEQUENCE

Specifies entry sequence to the Installer Menu.

0 = 9876	1 = 4321
2 = 1478	3 = 3698

001 - POWER MANAGE (Power Management)

Determines hours of no activity before automatic shutoff. The Power Management function is for saving energy. If set to 0, Power Management is Off. Settings range from 0 ~ 7, with 1 ~ 7 representing the hours that the unit will remain ON, unless there has been activity from either the control panel or remote control.

002 - AC ON (AC Power Switchable)

If set to 1, this allows the TV to turn ON when AC power is applied. Pressing the ON button is not necessary. This is desirable if the TV is plugged into a cable box or a power outlet controlled by a wall switch. Use the Left/Right arrow keys to choose 0 or 1, where 0 is the default (OFF), and 1 is ON.

Note: If set to 1 (ON), the TV does not respond to ON/OFF commands from either the remote or the display panel, and the SLEEP TIMER is also nonfunctional.

003 - BAND/AFC (Band/Automatic Frequency Control)

There are four possible settings for this option:

0 = Broadcast	1 = CATV (default)
2 = HRC	3 = IRC

If some channels were not found by Auto Tuning (Channel Search), select the appropriate Band setting here, and add the channels using the Channel Edit option in the Channel Menu.

004 - STRT CHANNEL (Start Channel)

If active, this function allows you to determine the initial Major Start Channel number when the TV is turned ON. This feature is useful for an in-house information channel, since the TV would always select that channel when it is turned ON. If set to 255, the last channel tuned before the TV was turned OFF will be the channel tuned when the TV is turned ON again.

0 = Aux	127 = Map to Major CH 4
1 ~ 125 = Major CH #	255 = Last Channel
126 = Map to Major CH 3	

Note: For a digital Start Channel, always remember to set item 104 to the Minor Start Channel number.

Note: 126 and 127 are mapped only in LodgeNet PPV Mode.

005 - CHAN LOCK (Channel Lock)

Channel Lock is ideal if the system must always be on the same channel. Changing channels with the Channel Up/Down or keypad numbers is impossible. Channel Lock is inactive if set to 0 (default).

Generally, this feature is used in connection with item 004 STRT CHANNEL where the Start Channel may, for example, be set to 3 or 4. If the Start Channel is 3, then the TV will remain locked on channel 3.

NOTE: For items 007, 008, and 009

For legacy reasons, the scale used is 0–63. The PTC software will translate this to the 0–100 scale used by the TV.

To translate a TV volume level to the Installer Menu value, use the following formula:

$$\text{Installer Value} = \frac{\text{TV Value} \times 63}{100}$$

Enter only the whole number (disregard fractions).

007 - STRT VOLUME (Start Volume)

This function allows the Installer to determine the initial volume level setting when the TV is turned ON. This feature is useful for an in-house information channel, since the TV would always select that volume level when it is turned ON. The range of values are 0 - 63, 255. If 255 is selected, the current volume level will be retained in memory when the TV is turned OFF; at turn ON, the volume level will be automatically set at the previous or last level.

008 - MIN VOLUME (Minimum Volume)

This function determines the minimum volume level allowable with the Volume (VOL) Up/Down control. In this way, for example, someone cannot set the volume too low to hear. The value range is from 0 to 63. Use the Left/Right arrow keys to change values. The factory default is 0, which provides the full range of volume control, if item 009 MAX VOLUME is also set to 63. It may be best to set the same value on every TV.

Note: The minimum volume level cannot have a value setting higher than the maximum volume level (described below).

009 - MAX VOLUME (Maximum Volume)

This function determines the maximum volume level allowable with the Volume (VOL) Up/Down control. In this way, for example, someone cannot set the volume level high enough to disturb others. The value range is 0 to 63, with 63 as the default, which gives the user the full range of volume control, if item 008 MIN VOLUME is also set at 0. Use the Left/Right arrow keys to change values. It may be best to set the same value on every TV.

Note: The maximum volume level cannot have a value setting lower than the minimum volume level (described above).

010 - MUTE DISABLE

Enables or disables sound mute function. If set to 1, sound cannot be muted. If set to 0, sound can be muted.

011 - KEY DEFEAT (Keyboard Defeat)

If set to 1, KEY DEFEAT prevents the end user from accessing the on-screen menu(s) from the display panel—MENU SETTINGS, OK, and menu navigation keys do not function. If set to 0, those keys do function.

Note: Users can always access the menus by pressing MENU on the remote.

015 - SLEEP TIMER

If set to 1, the Sleep Timer feature may be used. If set to 0, the Sleep Timer is not available.

016 - EN TIMER (Enable On/Off Timers)

If set to 1, the Timer function is available to the end user and enabled continuously. Set to 0 to disable On/Off timers.

Note: Clock must be set in order for timers to be used.

017 - ALARM

Gives the installer the option of making the Alarm function available to the end user. If set to 1, the Alarm function is available to the end user. Set to 0 to disable the Alarm function.

Note: Clock must be set before the Alarm function will work.

020 - FEATURE LEVEL

Determines an additional IR code scheme to which the TV will respond, allowing for the use of unique IR codes based on “bed number” in a multi-TV single room installation. First determine the IR mode; then select the bed number.

Values	IR Mode	Bed #
0	Disabled	N/A
16–24	Multi-code Remote	1–9

Note: For further information, see documentation for the accessory package that includes the multi-code remote.

021 - V-CHIP (Parental Control)

Set to 1 to activate V-Chip (Parental Control) and have it available to the end user to filter and control or otherwise restrict programming content that can appear. Set to 0 to turn the V-Chip feature Off (not available to user); no programming restrictions can be set.

022 - MAX BLK HRS (Maximum Block Hours)

Sets hours from 0 to 99 for the maximum V-Chip (Parental Control) block hours. Default setting is for 12 blocking hours.

023 - CAPTION LOCK

If set to 0, captions are OFF when the TV is turned ON. Set to 1 to use the caption setting configured before the TV was turned OFF when the TV is turned ON.

028 - CH. OVERRIDE (Channel Override)

If set to 1, the user can select channels with either Channel Up/Down or by direct keypad entry. If set to 0, only those channels that are active in the TV’s memory can be selected.

029 - OLD OCV (On Command Video™)

Set to 1 for operation with systems from On Command Corporation.

030 - ACK MASK

MPI Communication Parameter. When set to 1, enables ACK feature of MPI.

031 - POLL RATE

MPI Communication Parameter. Selects poll rate for MPI. Step size of 16 ms. Changing from default may affect communication via MPI.

032 - TIMING PULSE

MPI Communication Parameter. Sets baud rate for MPI. Step size of 4.3 uS. Changing from default may affect communication via MPI.

035 - HDMI1 ENABLE

Set to 1 to enable display panel HDMI 1 input. Set to 0 to disable display panel HDMI 1 input.

Note: This setting is ignored if item 093 RJP AVAILABLE is set to 1.

039 - REAR AUX EN. (Rear Aux Enable)

Set to 1 to enable display panel rear Aux (Video 1) input. Set to 0 to disable display panel rear Aux (Video 1) input.

041 - SIMPLINK EN

Set to 0 to disable the SIMPLINK feature. Set to 1 to enable SIMPLINK functionality without enabling remote control access to the SIMPLINK Menu. Set to 2 to enable both SIMPLINK functionality and SIMPLINK Menu access, though note that the Speaker menu option will be inaccessible/grayed out. Set to 3 to enable all aspects of SIMPLINK feature and SIMPLINK Menu. If a home theater device is connected to the TV, users can select either the TV or HT (home theater) speaker.

046 - STRT AUX SRCE (Start Aux Source)

Sets the starting Aux source. When turned ON, the TV will tune to starting Aux source if item 004 STRT CHANNEL is set to 0.

1 = Video 1 4 = RGB 7 = HDMI 3
3 = HDMI 1 5 = HDMI 2 255 = Last Aux

Note: Above is applicable only if all Aux sources are enabled.

Note: This item is not available in the Installer Menu unless item 004 STRT CHANNEL is set to 0.

047 - AUX STATUS

Set to 1 for MPI Aux source to be reported as a channel number instead of channel 0. Set to 0 to disable Aux identification change. Controls MPI status channel response for Aux inputs.

053 - DIS. CH-TIME (Disable Channel-Time)

Set to 1 to disable the Channel-Time display; Channel-Time display will not appear. Set to 0 to enable the Channel-Time display.

Installer Menu (Cont.)

069 - EN. CH-T COL. (Enable Channel-Time Custom Color)

Set to 1 to enable custom color for the Channel-Time display. Set to 0 to disable custom color for the Channel-Time display.

070 - FOR. CH-TIME (Channel-Time Display Foreground Color)

Set according to Color Chart:

0 = Black	3 = Cyan	6 = Yellow
1 = Blue	4 = Red	7 = White
2 = Green	5 = Violet	

Note: If foreground color and background color are the same, the menu background will be transparent.

Note: Applies only to “Channel Not Available” message if item 073 CH NOT AVBLE is set to 1 (enabled). Also, items 070 FOR. CH-TIME and 071 BCK. CH-TIME are not available in the Installer Menu when item 069 EN. CH-T COL. is set to 0.

071 - BCK. CH-TIME (Channel-Time Display Background Color)

See description for item 070 FOR. CH-TIME above. The color chart is the same for both items.

073 - CH NOT AVBLE (Channel Not Available)

If set to 1 and item 028 CH. OVERRIDE is set to 0, a “NOT AVAILABLE” message is displayed when a user direct tunes a channel that is not in the channel scan list available in memory.

075 - REVERT CH (Revert to Start Channel)

If set to 1 and loss of MPI communication occurs, TV automatically tunes to the specified Start Channel.

Note: This item is not available in the Installer Menu when item 004 STRT CHANNEL is set to 255.

078 - UPN MSB (UPN Most Significant Byte)

User programmable number, most significant byte readable by MPI command. Note: Not linked to serial number.

079 - UPN MSB-1 (UPN Most Significant Byte-1)

User programmable number, most significant byte-1 readable by MPI command. Note: Not linked to serial number.

080 - UPN MSB-2 (UPN Most Significant Byte-2)

User programmable number, most significant byte-2 readable by MPI command. Note: Not linked to serial number.

081 - UPN LSB (UPN Least Significant Byte)

User programmable number, least significant byte readable by MPI command. Note: Not linked to serial number.

082 - CHKSM ERROR (Checksum Error)

Enforces rigid MPI checksum validation. Set to 1 for validation. Set to 0 to disable (does not check checksum on MPI async port). SPI is always checked.

083 - HANDSHK TIME (Handshake Time)

Adds an additional delay to the handshake time which is 64 msec, thus relaxing MPI timing requirements to be compatible with PC-based Windows controlled systems. Range is 0 - 5. (Timeout = 25.5MS + [25.5 MS* Handshake time].)

084 - PERMANENT BLK (Permanent Block)

Allows Lock (Parental Control) blocking schemes to be permanent by disabling the blocking hours function. Set to 1 to install Parental Control restrictions permanently. Set to 0 for user-specified hours control of blocking schemes.

087 - REAR RGB EN. (Rear RGB Enable)

Controls access to rear RGB input on TV. Set to 0 to disable RGB input. Set to 1 to enable RGB input. Set to 17 to initiate a one-time automatic configuration after an AC power cycle; otherwise, automatic adjustment will be performed each time the RGB input is accessed.

088 - EN NOISE MUTE (Enable Noise Mute)

If set to 1, audio mutes if no signal is present.

090 - KEY LOCK

If set to 1, display panel Channel, Volume, and Caption buttons are disabled, Power button remains enabled. If set to 0, Channel, Volume, Caption, and Power buttons are all enabled.

091 - HDMI2 ENABLE

Set to 1 to enable display panel HDMI 2 input. Set to 0 to disable display panel HDMI 2 input.

092 - HDMI3 ENABLE

Set to 1 to enable display panel HDMI 3 input. Set to 0 to disable display panel HDMI 3 input.

093 - RJP AVAILABLE (Remote Jack Pack Available)

- 0 = Remote jack pack is not available or disabled.
- 1 = Legacy Model RJPs: HDMI Mode
Enables RJP feature for use with full cable bundle models. In this mode, when an HDMI source is connected to the RJP, both digital video and audio are expected via the HDMI cable. If no digital audio is present, no audio will be heard.
- 2 = Legacy Model RJPs: DVI Mode
Enables RJP feature for use with full cable bundle models. In this mode, when an HDMI/DVI source is connected to the RJP, only digital video is expected via the HDMI cable. Analog audio is provided via a separate cable, from the source, connected to an RJP AUDIO IN. If no analog audio cable is connected, tuner audio will be heard.

- **5 = Scaler Model RJPs: HDMI Mode**
Enables RJP feature for use with reduced cable bundle models. In this mode, when an HDMI source is connected to the RJP, both digital video and audio are expected via the HDMI cable. If no digital audio is present, no audio will be heard.
- **6 = Scaler Model RJPs: DVI Mode**
Enables RJP feature for use with reduced cable bundle models. In this mode, when an HDMI/DVI source is connected to the RJP, only digital video is expected via the HDMI cable. Analog audio is provided via separate cable, from the source, connected to an RJP AUDIO IN. If no analog audio cable is connected, tuner audio will be heard.

Notes:

See Reference section, "RJP Model List and Input Auto-sensing Hierarchy." If RJP AVAILABLE is set to 1, 2, 5, or 6, item 040 AUTO CAMPORT is automatically set to 0. Settings 1, 2, 5, and 6 allow the lodge staff to customize each TV's RJP setup based on customer requirements.

094 - SAP MENU EN (2nd Audio Program)

Set to 1 to enable SAP feature on Function Menu, if Function Menu is available (i.e., TV is not in Pass-through Mode). Set to 0 to disable SAP feature on Function Menu, if Function Menu is available.

096 - DEF. ASP. RATIO (Default Aspect Ratio)

Selects default aspect ratio at power up.

- Set to 0 for Set By System.
- Set to 1 for 4:3.
- Set to 2 for 16:9 (Factory Default).
- Set to 3 for Just Scan.
- Set to 4 for Zoom.

Note: This item is not available in the Installer Menu unless item 106 ASP RATIO LOCK is set to 0.

098 - PRO:CENTRIC

Selects the Pro:Centric Application Mode. Set to 0 (default) to disable Pro:Centric operation. Set to 1 for Flash Mode. Set to 2 for GEM (Java Application) Mode.

Note: This item is not available in the Installer Menu when item 119 DATA CHANNEL is set to 0.

099 - BACK LIGHTING

Sets the TV screen brightness at power up. Default setting is 100.

- 1 - 100 Static Back Lighting
(1 = Dimmest picture, 100 = Brightest picture)
- 101 - 200 Dynamic Back Lighting
(101 = Dimmest picture, 200 = Brightest picture)

If set between 101 and 200, the TV automatically controls back lighting depending upon the picture level of the current program. If set to 255, back lighting is controlled via the Picture settings in the TV's setup menus.

102 - ATSC BAND

Sets up TV to receive different types of incoming signals: 0 = Broadcast, 1 = CATV, 2 = HRC, 3 = IRC, 4 = Same as NTSC.

103 - ATSC TUNE MODE

Sets ATSC tuning mode. Default set to 1 for Physical Channel scan. Set to 0 for Virtual Channel scan.

104 - START MINOR CHANNEL

Sets Minor Start Channel number at power up. 0 = NTSC. If not 0, number selected is the digital channel's Minor Start Channel number.

Note: This item is not available in the Installer Menu when item 004 STRT CHANNEL is set to 0 or 255.

106 - ASP RATIO LOCK (Aspect Ratio Lock)

Set to 1 to retain previous aspect ratio with power off. Set to 0 to retain default aspect ratio with power off. See item 096 DEF. ASP. RATIO above.

116 - VIDEO MUTE EN (Video Mute Enable)

Set to 0 for Normal. Set to 1 for Blank.

117 - FACT DEFAULT (Factory Default)

Set to 0 for normal. Set to 1 to restore the factory default settings of all Installer Menu items. The restoring of factory defaults will also re-activate the Automated Installation Routine Wizard (see pages 11 to 13).



Caution: If set to 1, this will restore the factory defaults and clear the channel lineup, including any assigned channel icons and custom text labels.

Note: See also Reference section, "Restoring Factory Defaults on the TV(s)," for further information.

118 - POWER SAVINGS

Default set to 3—the power circuitry for both the embedded *b*-LAN module and the GAME CONTROL/MPI port is only powered when the TV is turned ON. When the TV is in Standby Mode, the embedded *b*-LAN and the GAME CONTROL/MPI port are not powered.

Note that the TV must be turned ON in order to communicate with the embedded *b*-LAN module for configuration and control when POWER SAVINGS is set to 3. If POWER SAVINGS is set to 1, the *b*-LAN module is always powered.

Similarly, if MPI communication is required for external MPI control, POWER SAVINGS should be set to 1 so that the GAME CONTROL/MPI port circuitry is always powered.

Note: See Reference section, "*b*-LAN Setup & Overview," for further information.

Installer Menu (Cont.)

119 - DATA CHANNEL

Set to 0 (default) to disable. Set to the RF channel number of the data channel for Pro:Centric or TV E-Z Installation (splash screen, configuration, or firmware) data.

Note: Pro:Centric updates are downloaded from the Pro:Centric server to the TV when the TV is turned OFF. Also, while Pro:Centric updates are in progress, it is not possible to turn ON the TV. The TV may take several minutes to load EPG data after the initial download of the Pro:Centric application. Subsequent updates generally will take less than one minute.

121 - P:C RF WAKE HR

Set the hour from 0 to 23 for Wake On RF. This item uses the 24-hour clock format. The value "128" is displayed as "OFF." Directly entering 128 turns the Wake On RF feature OFF.

Note: This item is not available in the Installer Menu when item 119 DATA CHANNEL is set to 0.

122 - P:C RF WAKE MN

Set the minute from 0 to 59 for Wake On RF.

Note: This item is not available in the Installer Menu when item 119 DATA CHANNEL is set to 0 or when item 121 P:C RF WAKE HR is set to 128/OFF.

Channel Icons / Custom Text Labels (2-5-4 + MENU Mode)

Changing Channel Icons and/or Adding or Editing Custom Text Labels in the Channel-Time Display

If there is no pre-assigned icon for a channel, you can add a custom text label of up to seven (7) characters to help identify the channel or network. Also, if desired, a custom text label can be added to the Channel-Time display in addition to a pre-assigned icon. You may also add text labels for the Aux input sources to clearly identify the devices that are connected to the Aux inputs.

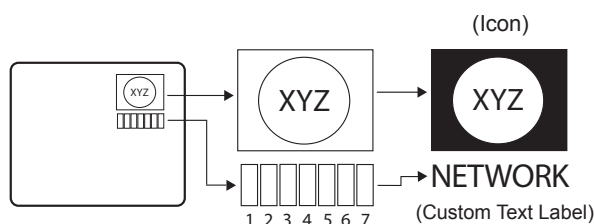

Changing icons and/or adding or editing custom text labels can only be done if there are channels that have been transferred to the TV's PTC either during Master TV Setup (see pages 14 to 17) or by cloning.

Note: A blank letter space is available between “Z” and “!”.

To perform channel editing/labeling:

1. Use the Installer Remote to access the Installer Menu (see “Accessing the Installer Menu” on page 18 for further information).
2. Press **2-5-4 + MENU SETTINGS** on the Installer Remote to enter the Channel Label Editing Menu.
3. Change channel icons and/or add or edit custom text labels as described in the procedures below. (You can do this more than once.)
4. To exit the menu when done, press **MENU SETTINGS**.

Changing a Channel's Icon on the Master TV

1. Use Channel Up/Down to select the desired channel.
2. Use the Left/Right arrow keys to select the thin letter “I” on the Channel-Time display.
3. Use the Up/Down arrow keys to select the icon with which you want to identify the channel. (If you know the icon number, enter the number, and press **OK**.)
4. Proceed to add/edit custom text labels, or go to the next channel.

Adding/Editing Channel Labels on the Master TV

1. Use Channel Up/Down to select the desired channel.
2. Press the Left or Right arrow repeatedly until the numbers 1 to 7 appear on the display. The number shows the position of the character that can be changed. Number 1 is the first character, number 2 the second character, etc.
3. Use the Up/Down arrow keys to select the desired character.
4. Proceed to the next number position, or go to the next channel.

Adding/Editing Source Labels on the Master TV

1. Press **INPUT** to select the desired Aux input source: AV, RGB, HDMI, HDMI2, or HDMI3.
2. Press the Left or Right arrow repeatedly until the numbers 0 to 9 appear on the display. The number shows the position of the character that can be changed.
3. Use the Up/Down arrow keys to select the desired character.
4. Press **INPUT** for the next Aux input, or use Channel Up/Down to return to channels.

Installer Remote Control Key Functions for Master TV Channel Label Editing Menu

- **Channel Up/Down:** Tunes to the next channel in scan.
- **Left/Right Arrows:** Select the item to change. If “I” is shown, the icon can be changed. If a number is shown, it indicates the position of the character that can be changed.
- **Up/Down Arrows:** Select the icon or the character to be displayed. Tip: Arrows can be held down for fast scrolling.
- **0 – 9:** Use to enter the index number of the icon, if known.
- **OK:** Changes the icon after the icon number has been entered.
- **INPUT:** Changes the Aux input label.
- **MENU SETTINGS:** Exits the editing process.

Cloning Overview

IMPORTANT CLONING INFORMATION

There are four different procedures for cloning a Master TV Setup, each with its own advantages and limitations (see also “Cloning Methods” on page 14):

- Using a USB memory device / .tlx file
- Using a USB memory device / .tll file
- Using a TLL-1100A clone programmer
- Using a LT2002 clone programmer

Each cloning method is described in further detail on the pages that follow. As you perform cloning procedures, be sure to complete each task as indicated. If a procedure or step is omitted or not performed completely, cloning may not work. At each step, pay attention to ensure the TV screen shows the proper message when cloning. If the message indicated does not appear, there is a problem with that step, and cloning may not be successful.



Caution: Copying a blank or incorrect memory into a TV from a clone programmer will cause the TV to operate erratically or become inoperable.



Caution: If the TV is in LodgeNet PPV Mode (check with the site administrator if you are not certain), do not connect a clone programmer to the GAME CONTROL/MPI port, as this will damage the clone programmer.

Before you begin cloning:

- Complete the Custom Master TV Setup procedure (see pages 14 to 17).
- All equipment should be connected to power and turned ON.
- Both the Master and Target TVs must be in Pass-through Mode (i.e., the TV setup menus should be displayed when you press **MENU SETTINGS** on the Installer Remote).
- Learning and Teaching is only possible between identical model TVs.
- If using a USB memory device, ensure the USB device has been formatted with FAT format.
- If using a USB memory device / .tlx file, ensure that the Master TV Setup does not contain a Channel Map; otherwise, Teaching will result in the Target TV(s) being configured for FTG Mode via CPU.
- For both Master and Target TVs—If using a clone programmer, ensure the TV is tuned to either an Aux input or an analog (not a digital) channel.
- LT2002 only—Make sure the batteries in the clone programmer are fresh. If batteries are removed, the clone programmer clock time (if set) will be lost (see page 36 for information on the clone programmer clock).



Caution: Do not unplug the TV power cord or remove/disconnect the USB memory device/clone programmer while Learning or Teaching, as doing so may cause the TV to malfunction or harm the USB device/clone programmer, respectively.

Learning / Teaching a Master TV Setup using a USB Memory Device / .tlx File

USB Cloning Notes

- Read the IMPORTANT CLONING INFORMATION on page 28 before beginning any cloning procedures. In particular, ensure that the Master TV Setup does not contain a Channel Map; otherwise, Teaching will result in the Target TV(s) being configured for FTG Mode via CPU.
- You may edit the filename as part of the Learning procedure; however, a file with edited contents will not be recognized.
- It is not possible to clone a Master TV's clock using a USB memory device. Either set a Target TV's clock manually, or use the Auto Clock setting in the TV setup menus.

Learn Setup from Master TV

1. Ensure the Master TV is set up completely and in Pass-through Mode.
2. Plug the USB memory device into the USB IN port on the Master TV.
3. Press **MENU SETTINGS** on the Installer Remote to display the TV setup menus. Use the arrow navigation keys to select/highlight the **Option** menu icon, and then press the number "7" key a total of seven times to display the USB Download Menu.
4. To gain access to the "Learn From TV" option in the USB Download Menu, key in the password used to access the Installer Menu (Example: Press **9-8-7-6**).
5. Use the Up/Down arrow keys to select **Learn From TV (TLX)**, and then press **OK**.
6. To differentiate this .tlx file from others, you can use the Up/Down arrow keys to change the last five digits of the filename. Press **OK** when you are ready to initiate Learning.
Learning status will be shown on a progress bar in a new window. When the Learning process is complete, the USB Download menu will reappear on the screen.
7. When Learning is done, press ↵ on the Installer Remote to exit the USB Download Menu, and remove the USB memory device from the Master TV.

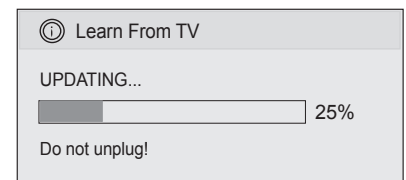
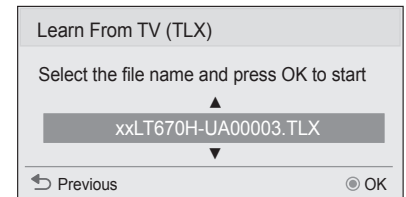
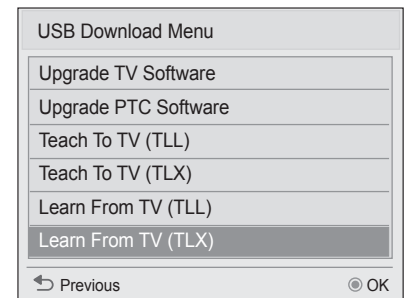

USB Cloning Procedures (Cont.)

Teach Master TV Setup to Target TV

1. Turn ON the Target TV.

The next step depends on whether the Automated Installation Routine Wizard appears on the screen when you turn ON the TV:

- If the wizard is displayed, the TV is already in the required factory default state. Use the Up/Down arrow keys on the Installer Remote to select **Exit** from the Welcome screen, and press **OK** to exit the wizard. Then, go to step 3.
- Otherwise, ensure the Target TV is in Pass-through Mode. Then, continue with step 2.

2. Use the Installer Remote to access the Target TV Installer Menu (see “Accessing the Installer Menu” on page 18 for further information). Set Installer Menu item **117 FACT DEFAULT** to **001**, and press **OK**. When the value changes back to 0, press **OK** again to exit the Installer Menu.

Note: This step restores factory default settings on the TV, which will in turn re-activate the Automated Installation Routine Wizard. Use the Up/Down arrow keys on the Installer Remote to select **Exit** from the Welcome screen. Then, press **OK** to exit the wizard.

3. Plug the USB memory device with the .tlx file into the Target TV USB IN port.

4. Press **MENU SETTINGS** on the Installer Remote to display the TV setup menus. Use the arrow navigation keys to select/highlight the **Option** menu icon, and then press the number “7” key a total of seven times to display the USB Download Menu.

5. Use the Up/Down arrow keys to select **Teach To TV (TLX)**, and then press **OK**.

6. Use the Up/Down arrow keys to select the Master TV Setup you want to install, and then press **OK**. Note: Filenames identify the TV and the TLX version (see example at right).

Teaching status will be shown on a progress bar in a new window. When the Teaching process is complete, the TV will briefly display a “Teaching Completed” window and then exit the USB Download Menu.

7. Remove the USB memory device from the Target TV, and verify that the Master TV Setup is now resident on the Target TV.

Note: After the Teaching process is complete, the TV tunes according to the setting of Installer Menu item 004 STRT CHANNEL (Start Channel). If a Start Channel is specified, the TV will tune to that channel; otherwise, the TV will return to the last channel tuned.

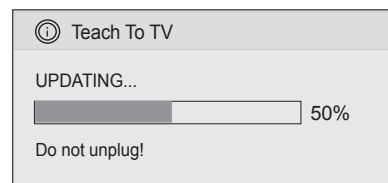
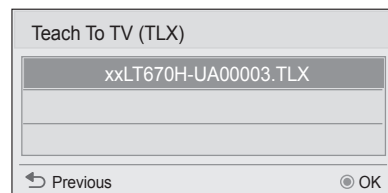
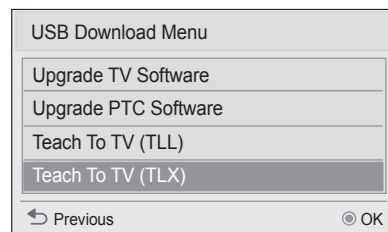

Learning / Teaching a Master TV Setup using a USB Memory Device / .tll File

USB Cloning Notes

- Read the IMPORTANT CLONING INFORMATION on page 28 before beginning any cloning procedures.
- You may edit a filename as part of the Learning procedure; however, a file with edited contents will not be recognized.
- It is not possible to clone a Master TV's clock using a USB memory device. Either set a Target TV's clock manually, or use the Auto Clock setting in the TV setup menus.

Learn Setup from Master TV

1. Ensure the Master TV is set up completely and in Pass-through Mode.
2. Plug the USB memory device into the USB IN port on the Master TV.
3. Press **MENU SETTINGS** on the Installer Remote to display the TV setup menus. Use the arrow navigation keys to select/highlight the **Option** menu icon, and then press the number "7" key a total of seven times to display the USB Download Menu.
4. To gain access to the "Learn From TV" option in the USB Download Menu, key in the password used to access the Installer Menu (Example: Press **9-8-7-6**).
5. Use the Up/Down arrow keys to select **Learn From TV (TLL)**, and then press **OK**.
6. To differentiate this .tll file from others, you can use the Up/Down arrow keys to change the last five digits of the filename. Press **OK** when you are ready to initiate Learning.

Learning status will be shown on a progress bar in a new window. When the Learning process is complete, the USB Download Menu will reappear on the screen.
7. When Learning is done, press ↵ on the Installer Remote to exit the USB Download Menu, and remove the USB memory device from the Master TV.

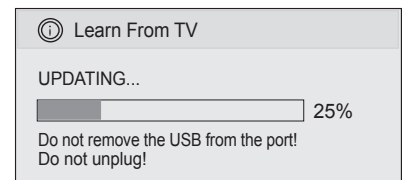
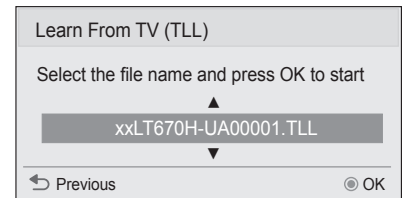
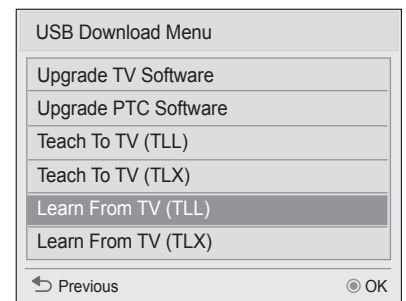

USB Cloning Procedures (Cont.)

Teach Master TV Setup to Target TV

1. Turn ON the Target TV.

The next step depends on whether the Automated Installation Routine Wizard appears on the screen when you turn ON the TV:

- If the wizard is displayed, the TV is already in the required factory default state. Use the Up/Down arrow keys on the Installer Remote to select **Exit** from the Welcome screen, and press **OK** to exit the wizard. Then, go to step 3.
- Otherwise, ensure the Target TV is in Pass-through Mode. Then, continue with step 2.

2. Use the Installer Remote to access the Target TV Installer Menu (see “Accessing the Installer Menu” on page 18 for further information). Set Installer Menu item **117 FACT DEFAULT** to **001**, and press **OK**. When the value changes back to 0, press **OK** again to exit the Installer Menu.

Note: This step restores factory default settings on the TV, which will in turn re-activate the Automated Installation Routine Wizard. Use the Up/Down arrow keys on the Installer Remote to select **Exit** from the Welcome screen. Then, press **OK** to exit the wizard.

3. Tune/set the TV to an analog or digital channel or Aux input, (ideally the same source tuned for 2-5-5 + MENU Mode during the Master TV Setup procedure).
4. Plug the USB memory device with the .tll file into the Target TV USB IN port.

5. Press **MENU SETTINGS** on the Installer Remote to display the TV setup menus. Use the arrow navigation keys to select/highlight the **Option** menu icon, and then press the number “7” key a total of seven times to display the USB Download Menu.

6. Use the Up/Down arrow keys to select **Teach To TV (TLL)**, and then press **OK**.

7. Use the Up/Down arrow keys to select the Master TV Setup you want to install, and then press **OK**. Note: Filenames identify the TV and the TLX version (see example at right).

Teaching status will be shown on a progress bar in a new window. When the Teaching process is complete, the USB Download menu will reappear on the screen.

8. When Teaching is done, press **↵** on the Installer Remote to exit the USB Download Menu, remove the USB memory device from the Target TV, and turn OFF the TV.

9. After a few seconds, turn ON the TV, and verify that the Master TV Setup is now resident on the Target TV.

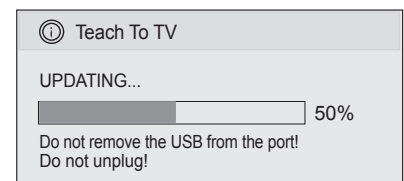
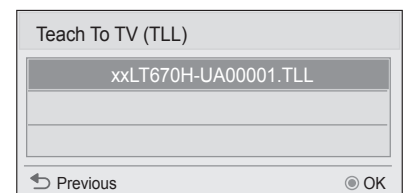
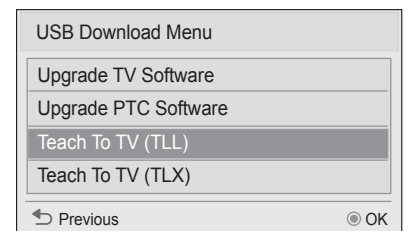

Clone Programmer Cloning Procedures

Learning / Teaching a Master TV Setup using a TLL-1100A Clone Programmer



Caution: If the TV is in LodgeNet PPV Mode (check with the site administrator if you are not certain), do not connect a clone programmer to the GAME CONTROL/MPI port, as this will damage the clone programmer.

Cloning is accomplished using the TV/clone programmer MPI ports for communication (see figure).

TLL-1100A Cloning Notes

- Read the IMPORTANT CLONING INFORMATION on page 28 before beginning any cloning procedures.
- Ensure the TLL-1100A is either fully charged or connected to AC power.
- Learning and Teaching is only possible between identical model TVs; however, the TLL-1100A can store up to eight different Master TV Setups.

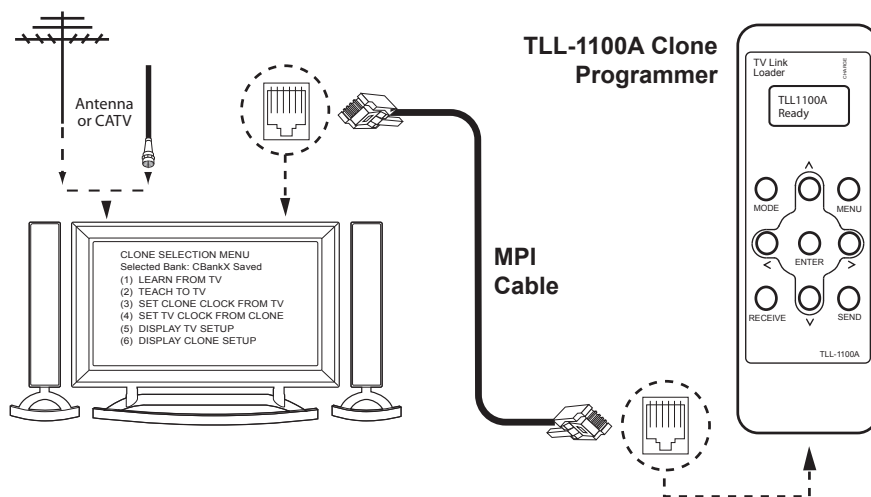

Learn Setup from Master TV

1. Ensure the Master TV is set up completely and in Pass-through Mode.
2. Tune/set the TV to an analog channel or Aux input, and then, plug one end of the MPI cable into the TV MPI port.
3. Turn ON the TLL-1100A.
4. Use the **MODE** button on the TLL-1100A to select **Clone Mode**.
5. Use the Left/Right arrows on the TLL-1100A to select the Memory CBank (1 to 8) in which to store the Master TV Setup.
6. Plug the other end of the MPI cable into the MPI port on the bottom of the TLL-1100A. The Clone Selection Menu will display on the TV screen.

7. Press **1** on the Installer Remote to select **LEARN FROM TV** from the Clone Selection Menu. Then, press **OK** to transfer the Master TV Setup into CBankX on the TLL-1100A.

Learning usually takes about 90 seconds. "LEARNING IN PROGRESS" will be displayed on the screen while the TLL-1100A copies the Master Setup. When the Learning process is complete, a "LEARNING COMPLETE" message will be displayed.

8. When Learning is complete, disconnect the MPI cable from the Master TV.

CLONE SELECTION MENU
Selected Bank: CBankX Saved
(1) LEARN FROM TV
(2) TEACH TO TV
(3) SET CLONE CLOCK FROM TV
(4) SET TV CLOCK FROM CLONE
(5) DISPLAY TV SETUP
(6) DISPLAY CLONE SETUP

CLONE CLOCK = XX:XX
TV CLOCK = XX:XX
THE CLONE IS VERSION VX.X.X
- To change menu items, press channel keys or digits.
- To execute item, press Enter.

Clone Programmer Cloning Procedures (Cont.)

(Optional) Set the Clock

Set the time on a Master TV's clock. (If the time has already been copied from a TV into the TLL-1100A clone programmer, you can set the Master TV's clock by copying the time from the clone programmer.) The TLL-1100A can copy the current time to both a Master TV and to the clone's internal clock—accurate to within one minute.

Since the TLL-1100A's time cannot be set directly, the current time needs to be copied from an LG TV equipped with an enabled MPI port.

After the time is copied to the TLL-1100A clone programmer, the current time will be maintained and can then be transferred to another TV. (This can be a Master TV or another TV which has already had the features set up.)

Teach Master TV Setup to Target TV

1. Turn ON the Target TV.

The next step depends on whether the Automated Installation Routine Wizard appears on the screen when you turn ON the TV:

- If the wizard is displayed, the TV is already in the required factory default state. Use the Up/Down arrow keys on the Installer Remote to select **Exit** from the Welcome screen, and press **OK** to exit the wizard. Then, go to step 3.
- Otherwise, ensure the Target TV is in Pass-through Mode. Then, continue with step 2.

2. Use the Installer Remote to access the Target TV Installer Menu (see "Accessing the Installer Menu" on page 18 for further information). Set Installer Menu item **117 FACT DEFAULT** to **001**, and press **OK**. When the value changes back to 0, press **OK** again to exit the Installer Menu.

Note: This step restores factory default settings on the TV, which will in turn re-activate the Automated Installation Routine Wizard. Use the Up/Down arrow keys on the Installer Remote to select **Exit** from the Welcome screen. Then, press **OK** to exit the wizard.

3. Tune/set the TV to an analog channel or Aux input (ideally the same source tuned for 2-5-5 + MENU Mode during the Master TV Setup procedure), and then connect the MPI cable to the MPI port on the Target TV. The Clone Selection Menu will display on the TV screen.

4. Ensure the correct Memory CBank(X) is selected on the TLL-1100A.

5. Press **2** on the Installer Remote to select **TEACH TO TV** from the Clone Selection Menu. Then, press **OK** to transfer the Master TV Setup to the Target TV.

Teaching usually takes 3 to 4 minutes. "TEACHING IN PROGRESS" will be displayed on the screen during Teaching. When the Teaching process is complete, a "TEACHING COMPLETE" message will be displayed.

6. When Teaching is done, disconnect the MPI cable from the Target TV, and turn OFF the TV.
7. After a few seconds, turn ON the TV, and verify that the Master TV Setup is now resident on the Target TV.

```
CLONE SELECTION MENU
Selected Bank: CBankX Saved
(1) LEARN FROM TV
(2) TEACH TO TV
(3) SET CLONE CLOCK FROM TV
(4) SET TV CLOCK FROM CLONE
(5) DISPLAY TV SETUP
(6) DISPLAY CLONE SETUP
```

```
CLONE CLOCK = XX:XX
TV    CLOCK = XX:XX
THE CLONE IS VERSION VX.X.X
- To change menu items, press
channel keys or digits.
- To execute item, press Enter.
```

```
CLONE SELECTION MENU
Selected Bank: CBankX Saved
(1) LEARN FROM TV
(2) TEACH TO TV
(3) SET CLONE CLOCK FROM TV
(4) SET TV CLOCK FROM CLONE
(5) DISPLAY TV SETUP
(6) DISPLAY CLONE SETUP
```

```
CLONE CLOCK = XX:XX
TV    CLOCK = XX:XX
THE CLONE IS VERSION VX.X.X
- To change menu items, press
channel keys or digits.
- To execute item, press Enter.
```

Clone Programmer Cloning Procedures (Cont.)

Learning / Teaching a Master TV Setup using an LT2002 Clone Programmer



Caution: If the TV is in LodgeNet PPV Mode (check with the site administrator if you are not certain), do not connect a clone programmer to the GAME CONTROL/MPI port, as this will damage the clone programmer.

Cloning is accomplished using the TV/clone programmer MPI ports for communication (see figure).

LT2002 Cloning Notes

- Read the IMPORTANT CLONING INFORMATION on page 28 before beginning any cloning procedures.
- A slow flashing green light indicates that there are communication problems between the TV and the LT2002. If this is the case, check for a damaged cable, poor contacts, or other connection troubles.
- If the status indicator is red, the LT2002 batteries are low and should be replaced. Install four (4) high-quality alkaline AA batteries.
- Learning and Teaching is only possible between identical model TVs; however, the LT2002 can store up to three different Master TV Setups.

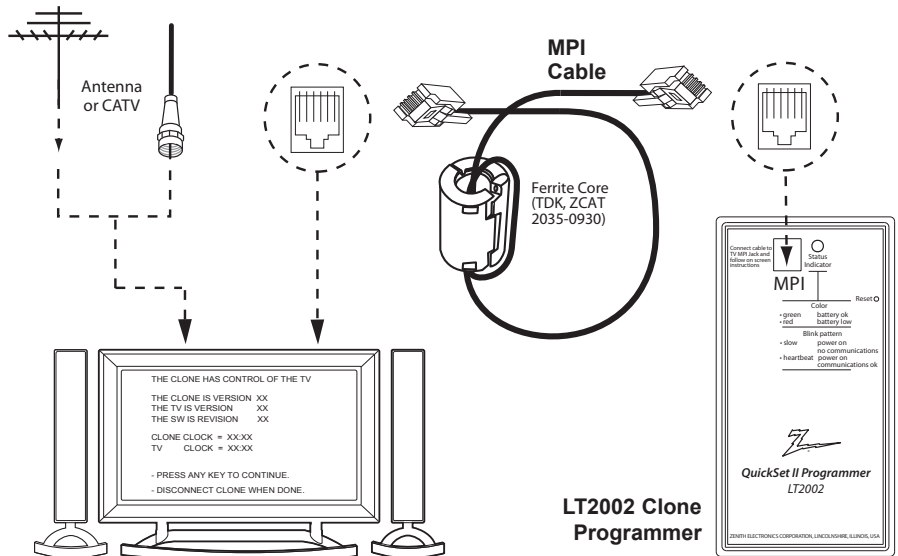

Learn Setup from Master TV

1. Ensure the Master TV is set up completely and in Pass-through Mode.
2. Tune/set the TV to an analog channel or Aux input, and then plug one end of the MPI cable into the TV MPI port.
3. If there is a good connection after the LT2002 is connected to the TV MPI port, "THE CLONE HAS CONTROL OF THE TV" message will appear on the TV screen. Press any key on the Installer Remote to access the LT2002 Clone Selection Menu.
4. Press **1** on the Installer Remote to select **LEARN FROM TV** from the Clone Selection Menu; then press **OK** to proceed to the Memory Bank Selection Menu.
5. Press 1, 2, or 3 on the Installer Remote to select the clone Memory Bank in which to store the Master Setup. Then, press **OK**.

Note: If you choose a Memory Bank that already has a Master device's setup programmed into it, that setup will be overwritten by the new Master TV Setup.
6. Verify the Learning setup information on the next screen, and then press **POWER** to transfer the Master TV Setup into the selected Memory Bank on the LT2002.

Learning usually takes about 90 seconds. "LEARNING IN PROGRESS" will be displayed on the screen while the LT2002 copies the Master Setup. When the Learning process is complete, a "LEARNING COMPLETE" message will be displayed.
7. When Learning is complete, disconnect the MPI cable from the Master TV.

CLONE SELECTION MENU

(1) LEARN FROM TV
 (2) TEACH TO TV
 (3) SET CLONE CLOCK FROM TV
 (4) SET TV CLOCK FROM CLONE
 (5) DISPLAY TV SETUP
 (6) DISPLAY CLONE SETUP

- TO CHANGE MENU ITEMS, PRESS CHANNEL KEYS OR DIGITS.

- TO EXECUTE ITEM, PRESS ON/OFF, POWER, OR ENTER.

SAVE TV SETUP IN SELECTED CLONE MEMORY

(1) MEMORY 1 VER XX REV XX
 (2) MEMORY 2 VER XX REV XX
 (3) MEMORY 3 VER XX REV XX
 (4) RETURN TO CLONE MENU

- TO CHANGE MENU ITEMS, PRESS CHANNEL KEYS OR DIGITS.

- TO EXECUTE ITEM, PRESS ON/OFF, POWER, OR ENTER.

Clone Programmer Cloning Procedures (Cont.)

(Optional) Set the Clock

Set the time on a Master TV's clock. (If the time has already been copied from a TV into the LT2002 clone programmer, you can set the Master TV's clock by copying the time from the clone programmer.) The LT2002 can copy the current time to both a Master TV and to the clone's internal clock—accurate to within one minute. (Another reason that the LT2002 should be equipped with fresh, high-quality alkaline batteries, is for it to keep the time as accurately as possible.)

Since the LT2002's time cannot be set directly, the current time needs to be copied from an LG TV equipped with an enabled MPI port.

After the time is copied to the LT2002 clone programmer, the current time will be maintained and can then be transferred to another TV. (This can be a Master TV or another TV which has already had the features set up.)

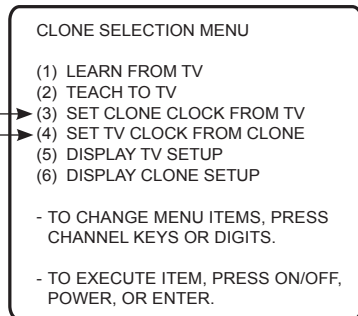

Teach Master TV Setup to Target TV

1. Turn ON the Target TV.

The next step depends on whether the Automated Installation Routine Wizard appears on the screen when you turn ON the TV:

- If the wizard is displayed, the TV is already in the required factory default state. Use the Up/Down arrow keys on the Installer Remote to select **Exit** from the Welcome screen, and press **OK** to exit the wizard. Then, go to step 3.
- Otherwise, ensure the Target TV is in Pass-through Mode. Then, continue with step 2.

2. Use the Installer Remote to access the Target TV Installer Menu (see “Accessing the Installer Menu” on page 18 for further information). Set Installer Menu item **117 FACT DEFAULT** to **001**, and press **OK**. When the value changes back to 0, press **OK** again to exit the Installer Menu.

Note: This step restores factory default settings on the TV, which will in turn re-activate the Automated Installation Routine Wizard. Use the Up/Down arrow keys on the Installer Remote to select **Exit** from the Welcome screen. Then, press **OK** to exit the wizard.

3. Tune/set the TV to an analog channel or Aux input (ideally the same source tuned for 2-5-5 + MENU Mode during the Master TV Setup procedure), and then connect the MPI cable to the MPI port on the Target TV.
4. With “THE CLONE HAS CONTROL OF TV” message on display, press **2** on the Installer Remote to select **TEACH TO TV** from the LT2002 Clone Selection Menu. Then, press **OK**.
5. Select the LT2002 Memory Bank in which the new Master TV Setup is located, and press **OK**.

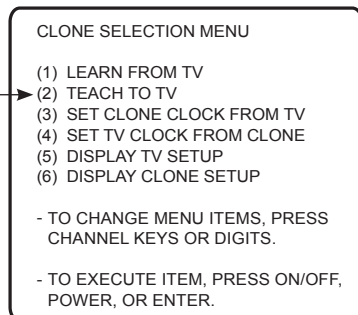

6. Verify the Teaching setup information on the next screen, and then press **POWER** to transfer the Master TV Setup to the Target TV.

Teaching usually takes 3 to 4 minutes. “TEACHING IN PROGRESS” will be displayed on-screen during Teaching. When the Teaching process is complete, a “TEACHING COMPLETE” message will be displayed.

7. When Teaching is done, disconnect the MPI cable from the Target TV, and turn OFF the TV.
8. After a few seconds, turn ON the TV, and verify that the Master TV Setup is now resident on the Target TV.

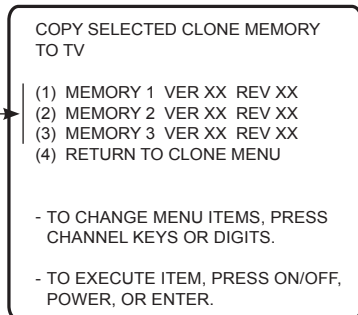

FTG Mode via CPU or EBL

FTG Mode enables Pro:Idiom decryption and also allows logical channel mapping of physical channels.

As indicated in the introduction to this document, there are two separate and distinct methods for configuring LT670H TVs for FTG Mode of operation: one (new) method is to configure the TV CPU for FTG Mode operation, while the other is to configure the TV EBL for FTG Mode operation. FROM A LOCAL CONFIGURATION STANDPOINT, EACH OF THESE METHODS IS MUTUALLY EXCLUSIVE. IF THE CPU IS IN FTG MODE, THE EBL CANNOT BE SWITCHED TO FTG MODE. LIKEWISE, IF THE EBL IS IN FTG MODE, THE CPU CANNOT BE SWITCHED TO FTG MODE.

FTG Mode via CPU

This mode provides the following features:

- Logical channels mapped to either RF or IP delivered content.
- Digital RF channel minor (program) numbers up to 999.
- FTG Channel Map of up to 600 logical channels.
- Start Channel set for RF, Aux input, or IP delivered content.
- Pro:Centric data delivery over RF or IP.

FTG Mode via CPU requires that you use LG FTG File Manager PC software to create an FTG Configuration (.tlx) file. In this mode, the CPU is the owner of the FTG Channel Map and must be configured with an FTG Channel Map and FTG Installer Menu settings using one of the following processes:

- Local: Configure an individual LT670H TV via its USB port using an FTG Configuration (.tlx) file on a USB memory device. The “Teach to TV (TLX)” process, along with associated procedures, is described on pages 39 to 43.
- Remote: Configure all LT670H TVs at the site using a Pro:Centric server head end device (Example: PCS150R). Load an FTG Configuration (.tlx) file on the Pro:Centric server using the TV E-Z Installation “Configuration” option in the Pro:Centric server Admin Client. Refer to the **Pro:Centric™ Server Admin Client User Guide** for further information.

FTG Mode via EBL

This mode provides the following features:

- Logical channels mapped to RF delivered content.
- Digital RF channel minor (program) numbers up to 255.
- FTG Channel Map of up to 141 logical channels.
- Start Channel set for RF or Aux input delivered content.
- Pro:Centric data delivery over RF.

FTG Mode via EBL requires LG FTG Device Configuration Application PC software. In this mode, the EBL is the owner of the FTG Channel Map and must be configured with an FTG Channel Map and FTG Installer Menu settings using one of the following processes:

- Local: Configure an individual LT670H TV’s EBL via its TV-LINK CFG jack using a direct PC-to-TV connection and the FTG Device Configuration Application. The “Write” process for an FTG Channel Map and FTG Installer Menu settings is described on page 44.
- Remote: Configure all LT670H TV EBLs at the site using a Free-To-Guest Management Appliance (FMA) head end device (Example: FMA-LG101). Refer to the **Free-To-Guest (FTG) Device Configuration Application User Guide** and/or the Installation & Configuration Guide for the FMA device for further information.

FTG Mode of Operation Overview (Cont.)

While the TV is in FTG Mode:

- Users can still access the Installer Menu using an LG Installer Remote; however, all Installer Menu items will be read-only.
- Any FTG configuration changes must be made using either the FTG File Manager (FTG Mode via CPU) or the FTG Device Configuration Application (FTG Mode via EBL). FTG Channel Map Configuration and FTG Installer Menu Configuration Utilities enable you to make changes, respectively, to the FTG Channel Map and FTG Installer Menu settings as necessary. Based on the initial method used to configure the TV for FTG Mode operation (via CPU or EBL), all subsequent changes must be transferred to either the TV CPU or the EBL via a process that is in accordance or compatible with that method (see information on local configuration in this document or refer to documentation for the head end device/server for information on remote management).
- If it becomes necessary to reset the TV to Pass-through Mode, there are several options that will enable you to do so. Refer to Reference section, "Restoring Factory Defaults on the TV(s)," for further information.

Pages 45 to 48 provide overviews of the utilities that comprise the FTG File Manager. Refer to the **Free-To-Guest (FTG) File Manager User Guide** for further information on the FTG File Manager. Refer to the **Free-To-Guest (FTG) Device Configuration Application User Guide** for information on the FTG Device Configuration Application.

Determining the TV Operating Mode

To determine the operating mode of the TV, press **MENU** on the Installer Remote. The menu displayed depends on the operating mode. See examples below.

If the Function Menu appears, the TV is in a mode (FTG, PPV, etc.) that does not allow the end user to change the fundamental TV setup. If the TV setup menus appear, the TV is in Pass-through Mode.

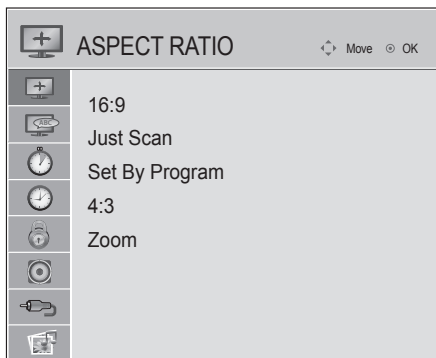

Function Menu

Indicates the TV is not in Pass-through Mode. While the TV is in this mode, Installer Menu settings can be accessed as read-only.

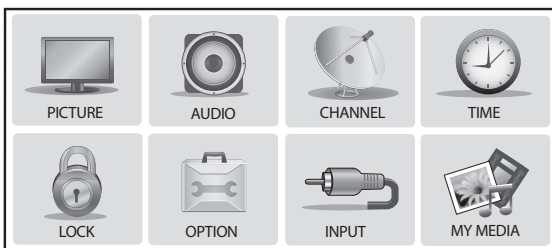

TV Setup Menus

Shows that the TV is in Pass-through Mode.

Creating an FTG Configuration File using the FTG File Manager

This section describes how to create an FTG Configuration (.tlx) file that can be saved to a USB memory device. In order to enable Pro:Idiom decryption, it is recommended that you create an FTG Configuration file using the FTG File Manager.

- Notes:**
- FTG File Manager software is available online at: www.LGolutions.com/ftgsoftware.
 - There is also an option to save (Learn) an FTG Configuration file from a TV, which may be desirable or required in either of the following situations:
 - If you want to save customized TV setup menu settings to the FTG Configuration file (in addition to the FTG Channel Map and FTG Installer Menu settings).
 - If you do not know the RF channels at the site.
- See “Learning an FTG Configuration File from a TV” on page 42 for further information. However, if you use this option to save an FTG Configuration file, it is still highly recommended that you open the saved FTG Configuration file in the FTG File Manager to verify the file contents/settings and to enable Pro:Idiom decryption by marking Encrypted channels using the FTG Channel Map Editor.

The procedure below provides an overview of the steps required to create an FTG Configuration (.tlx) file. Refer to the **Free-To-Guest (FTG) File Manager User Guide** for further information. See also FTG File Manager sample screens on pages 45 to 48.

1. Install (if necessary) and launch the FTG File Manager (v1.0.0 or higher) on the PC that will be used to create the FTG Configuration (.tlx) file.
2. You have a number of options:
 - To view and/or base a new FTG Configuration file on an existing FTG Configuration (.tlx) file, click the **Open** button in the TLX File command section of the FTG File Manager main screen, and select the desired (.tlx) file.

A list of the file's contents will be displayed in the TLX File Contents window. Either double-click on an individual item to copy it or click the **Copy All** button directly above the TLX File Contents window to automatically copy all the contents of the opened .tlx file to the FTG Configuration List and, if applicable, TV Setup Menu List. Note, though, that while TV setup menu settings can be included in the new FTG Configuration file, the TV setup menu settings are not available for editing.

Edit the configuration of the items in the FTG Configuration List as well as the FTG Configuration List itself and/or the TV Setup Menu List, as necessary, to create a new file. Then, proceed to step 3 when you are ready to continue.
 - To open an existing FTG Configuration (.rml) file created in the FTG Device Configuration Application to use its FTG Channel Map and/or FTG Installer Menu settings, click **File** and then **Open** from the FTG File Manager menu bar, and select/double-click on the desired “.rml” file.

Edit the channels and/or settings as necessary, and then proceed to step 3 when you are ready to continue.
 - Create a new FTG Channel Map using the FTG Channel Map Editor in the FTG Channel Map Configuration Utility. Up to 600 logical channels (combined total of both RF and IP mapped channels) can be defined in the FTG Channel Map.

When you are ready to continue, click **Configure** and then **FTG File Manager** from the FTG File Manager menu bar to return to the FTG File Manager main screen, and then proceed to step 3.

(Continued on next page)

FTG Mode via CPU (Cont.)

(Continued from previous page)

Note: To remove an individual item from the FTG Configuration List or the TV Setup Menu List, click on/highlight the item to be removed, and then click the **Remove Item** button directly above the applicable “List” window. To clear both the current FTG Configuration List and TV Setup Menu List contents, click the **Clear** button in the List command section of the FTG File Manager main screen.

Note: To clear the current TLX File Contents, click the **New** button in the TLX File command section of the FTG File Manager main screen (above the TLX File Contents window).

3. To add an FTG Channel Map to the FTG Configuration List, click **>>** under FTG Channel Map. This will copy the current mapped RF and IP channels to the FTG Configuration List.

Note: If you make any change(s) in the FTG Channel Map Configuration Utility to the current data to be included in the FTG Configuration List, you will need to recopy the FTG Channel Map to the FTG Configuration List.

4. (Optional) Load default FTG Installer Menu settings for the TV:

- Click the down arrow at the right of the Chassis field in the Installer Menu Templates section of the FTG File Manager main screen, and select the appropriate chassis (depending on the TV type) from the drop-down list of available models.
- Click the **Load** button.
- Use the FTG Installer Menu Configuration Utility to modify settings, if necessary. Then, return to the FTG File Manager main screen.

5. To add FTG Installer Menu settings to the FTG Configuration List, click **>>** under FTG Installer Menu Settings. This will copy the selected model settings to the FTG Configuration List.

Note: If you make any change(s) in the FTG Installer Menu Configuration Utility to the current data to be included in the FTG Configuration List, you will need to recopy the FTG Installer Menu settings to the FTG Configuration List.

6. Click the **Save** button in the List command section of the FTG File Manager main screen to save the FTG Configuration List and, if present, TV Setup Menu List contents to an FTG Configuration (.tlx) file on the PC’s hard drive for later use.

In the Save As pop-up window, name the file, and click **Save**. The default folder path is C:\Program Files\Zenith\FTG\TLX. Note that the FTG Configuration file will have a “.tlx” file extension.

Note: To remove an individual item from the FTG Configuration List or the TV Setup Menu List before saving the new file, click on/highlight the item to be removed, and then click the **Remove Item** button directly above the applicable window. To clear both the current FTG Configuration List and TV Setup Menu List contents, click the **Clear** button in the List command section of the FTG File Manager main screen.

7. Transfer the FTG Configuration (.tlx) file to a USB memory device, and proceed to “Teaching FTG Configuration to a TV” on the following page to transfer the FTG Configuration file to an LT670H TV.

Teaching FTG Configuration to a TV

This section describes how to “Teach” an FTG Configuration file from a USB memory device to a TV. Ensure you have completed the procedure on the previous page to create the FTG Configuration file before proceeding with the steps below.

- Notes:**
- If the TV EBL is already in FTG Mode, you cannot use this procedure to make changes to the FTG Channel Map and FTG Installer Menu settings. You must use a direct PC-to-TV connection as described on page 44 or an FMA head end device to reconfigure the EBL.
 - If the preceding condition applies, but you wish to switch the TV to FTG mode via CPU, refer to Reference section, “Restoring Factory Defaults on the TV(s),” for further information before proceeding.

Note: If the Automated Installation Routine Wizard appears on the screen when you turn ON the TV, you can use the “USB Configuration” option to configure this TV, if desired (see “USB Configuration” on page 13).

1. Turn ON the TV, and then plug the USB memory device that contains the FTG Configuration file into the Target LT670H TV USB IN port.
2. Press **MENU SETTINGS** on the Installer Remote to display the TV setup menus (TV is in Pass-through Mode) or the Function Menu (TV is already in FTG Mode).
3. Use the arrow navigation keys to select/highlight either the **Option** menu icon from the TV setup menus or the **Lock** menu icon from the Function Menu. Then, press the number “7” key a total of seven times to display the USB Download Menu.
4. Use the Up/Down arrow keys to select **Teach To TV (TLX)**, and then press **OK**.
5. Use the Up/Down arrow keys to select the FTG Configuration file you want to install, and then press **OK**.
Teaching status will be shown on a progress bar in a new window. Do NOT remove the USB device until Teaching is complete. When the Teaching process is complete, the TV will briefly display a “Teaching Completed” window and then exit the USB Download Menu.
6. Remove the USB memory device from the Target TV, and verify that the FTG Configuration is resident on the Target TV.

The Target TV CPU is now in FTG Mode (if it was previously in Pass-through Mode).

Note: After the Teaching process is complete, the TV tunes according to the Start Channel setting in the Installer Menu. If a Start Channel is specified, the TV will tune to that channel; otherwise, the TV will tune to the lowest logical channel in the FTG Channel Map.

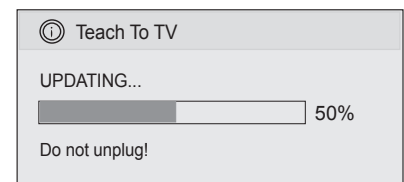
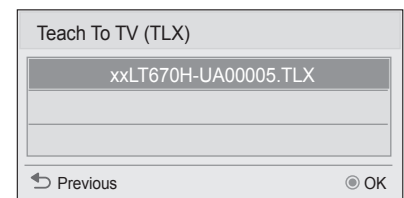
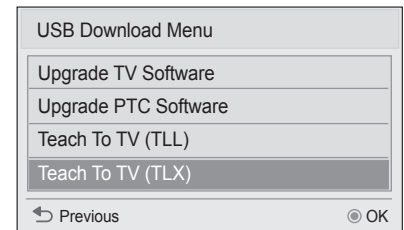

FTG Mode via CPU (Cont.)

Learning an FTG Configuration File from a TV

To ensure that Pro:Idiom decryption is enabled, it is recommended that you create an FTG Configuration file using the FTG File Manager as described on pages 39 to 40. However, if necessary, this option enables you to save (Learn) an FTG Configuration file from an LT670H TV to a USB memory device.

- Notes:**
- The option to save (Learn) an FTG Configuration file from a TV may be desirable or required in either of the following situations:
 - If you want to save customized TV setup menu settings to the FTG Configuration file (in addition to the FTG Channel Map and FTG Installer Menu settings).
 - If you do not know the RF channels at the site.
 - If the TV is NOT already in FTG Mode, you may need to perform some manual configuration on the TV before you start this procedure (see “Optional Manual Configuration / TV Setup” on following page).

1. Turn ON the TV, and then plug a USB memory device into the USB IN port on the TV.
2. Press **MENU SETTINGS** on the Installer Remote to display the TV setup menus (TV is in Pass-through Mode) or the Function Menu (TV is already in FTG Mode).
3. Use the arrow navigation keys to select/highlight either the **Option** menu icon from the TV setup menus or the **Lock** menu icon from the Function Menu. Then, press the number “7” key a total of seven times to display the USB Download Menu.
4. To gain access to the Learn From TV options in the USB Download Menu, key in the password used to access the Installer Menu (Example: Press **9-8-7-6**).
5. Use the Up/Down arrow keys to select **Learn From TV (TLX)**, and then press **OK**.
6. To differentiate this .tlx file from others, you can use the Up/Down arrow keys to change the last five digits of the filename. Press **OK** when you are ready to initiate Learning.

The TV will show Learning completion progress in a new window. Do NOT remove the USB device until Learning is complete. When Learning is complete, the USB Download Menu will reappear on the screen.
7. When you are finished, press **↵** on the Installer Remote to exit the USB Download Menu, and remove the USB memory device.

 **Note: It is highly recommended that you open this FTG Configuration file in the FTG File Manager—BEFORE transferring (Teaching) the file to any TVs—to verify FTG Channel Map and FTG Installer Menu settings and enable Pro:Idiom decryption by marking Encrypted channels. This will also enable you to confirm channels and add channel attributes, labels, etc.**

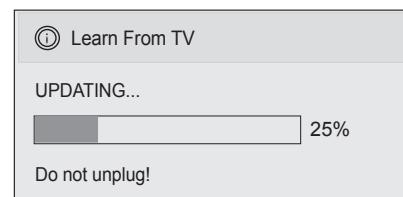
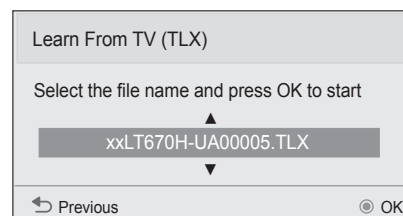
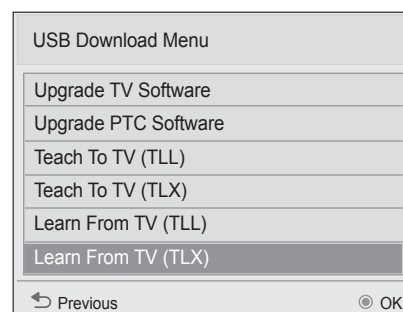

Optional Manual Configuration / TV Setup

The manual configuration procedures below should only be performed if you do not know the RF channels at the site and need to “Learn” an FTG Configuration file from an LT670H TV as described on the previous page. Ensure the TV is in Pass-through Mode before you begin.

Set Installer Menu Items

These steps provide specific instruction only on the Installer Menu items that should be set on an LT670H TV. Refer to pages 18 to 26 for detailed information on all Installer Menu items.

1. Turn ON the TV.* Then, use the Installer Remote to access the Installer Menu (see “Accessing the Installer Menu” on page 18 for further information).
2. Set Installer Menu item **117 FACT DEFAULT** to **001** and press **OK** on the Installer Remote.

This clears all Installer Menu custom settings, the channel lineup, etc. and restores the factory default settings. The value will change back to 0 after the commercial controller (PTC) has been restored to factory default condition. This step ensures that the TV Channel Memory will be the active channel lineup.

3. Set Installer Menu item **003 BAND/AFC**, as appropriate.
 - Broadcast: Set to 000. • HRC: Set to 002.
 - CATV: Set to 001 (default). • IRC: Set to 003.
4. Set any other Installer Menu items that affect your TV programming network to the required configuration. For example, enable/disable Aux inputs, set a Start Channel, etc.
5. After you have adjusted all Installer Menu item settings as required, press **OK** once on the Installer Remote to save your changes; then, press **OK** again to exit the menu.

Run Auto Tuning (Channel Search)

Note: In the FTG Configuration file, Logical Channel numbers will automatically be assigned in ascending order, starting with 0 (zero), to the Physical Channels from the TV Channel Map.

Note: Pro:Idiom decryption for encrypted channels will not be enabled unless you use the FTG File Manager to set the channel attributes.

1. Search for all available analog and digital channels: Use the Installer Remote to go to the Channel Menu, select the **Auto Tuning** option, and follow the on-screen instructions.
2. Use the **Channel Edit** option in the Channel Menu to edit the channel lineup, as necessary, to include free to guest channels only. Add/delete channels per your system requirements.

Once you have completed these procedures, return to “Learning an FTG Configuration File from a TV” on the previous page to complete the Learn sequence.

* If the Automated Installation Routine Wizard appears on the screen when you turn ON the TV, use the Up/Down arrow keys on the Installer Remote to select **Exit** from the Welcome screen, and press **OK** to exit the wizard. Note that in this case, you will not need to perform step 2 because the TV is already in a factory default state.

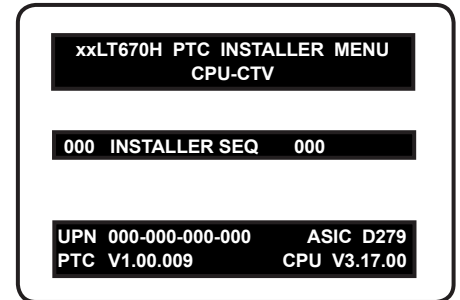

Typical Installer Menu

Note: The Installer Menu header will vary depending on the TV you are setting up.

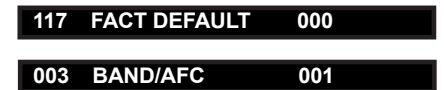

Adjust the values for these Installer Menu items.

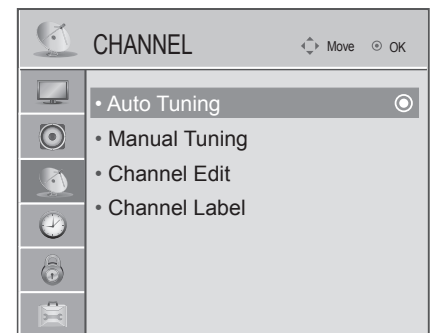

Use Channel Menu options to run Auto Tuning and edit the channel lineup, as necessary.

FTG Mode via EBL

The following steps outline local FTG configuration of individual TV EBLs using a direct PC-to-TV connection. Refer to the **Free-To-Guest (FTG) Device Configuration Application User Guide** for further information.

- Notes:**
- FTG Device Configuration Application software is available online at: www.LGolutions.com/ftgsoftware.
 - If the TV CPU is already in FTG Mode, you cannot use this procedure to make changes to the FTG Channel Map and FTG Installer Menu settings. Instead, refer to and use the processes described on pages 39 to 43 to reconfigure the TV CPU.
 - If the preceding condition applies, but you wish to switch the TV to FTG Mode via EBL, refer to Reference section, “Restoring Factory Defaults on the TV(s),” for further information before proceeding.

1. Install (if necessary) and launch the FTG Device Configuration Application (v5.0.0 or higher) on the PC that will be used to configure the EBL.

2. Build an FTG Channel Map using the FTG Channel Map Editor in the FTG Channel Map Configuration Utility (or, if applicable, open an existing FTG Configuration [.rml] file).

Note: Up to 141 logical channels can be defined in the FTG Channel Map.

3. Connect the PC to the TV-LINK CFG jack on the TV's rear jack panel using a USB-to-TTL serial cable (TTL-232R-5V-AJ). If necessary, install the device driver on the PC.

4. Turn ON the TV.

Note: If Installer Menu item 118 POWER SAVINGS is set to 3 (default), the TV must be ON in order for steps 5 and 6 below to be successful.

5. “Write” the FTG Channel Map to the EBL (switches the EBL from Pass-through Mode to FTG Mode).

Note: After a “Write” of new data, the TV will briefly display a green text banner that shows the EBL firmware version and release date.

6. “Read” the current FTG Installer Menu settings from the EBL using the FTG Installer Menu Configuration Utility. If necessary to make changes to Installer Menu items, “Write” them back to the EBL in FTG Mode.

7. Save the FTG Channel Map and FTG Installer Menu settings to an FTG Configuration (.rml) file for future use.

8. Tune the TV to a logical channel in the FTG Channel Map.

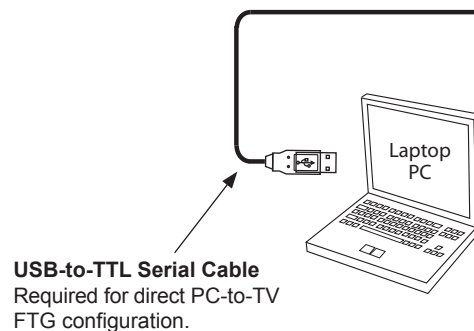
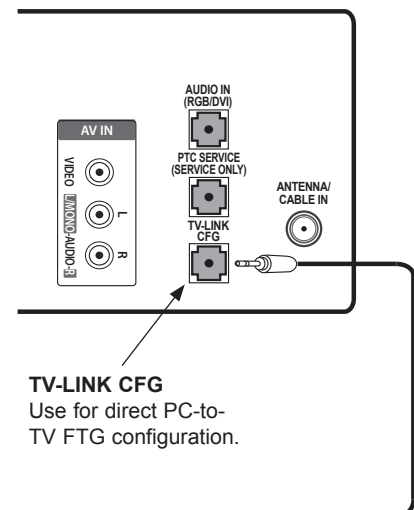

FTG File Manager Main Screen

The screenshot shows the FTG File Manager interface with the following callouts:

- FTG CONFIGURATION LIST**: Data to be saved in FTG Configuration (.tx) file.
- CLEAR/SAVE**: FTG Configuration List options.
- NEW/OPEN**: TLX File options.
- Filename of opened FTG Configuration (.rml) file**: created using FTG Device Configuration Application.
- Copy FTG Channel Map to and from FTG Configuration List.**
- Copy FTG Installer Menu settings to and from FTG Configuration List.**
- Load default FTG Installer Menu for appropriate LT670H chassis.**

TV SETUP MENU LIST
Data to be saved in FTG Configuration file.

TLX FILE CONTENTS
Data contained in opened FTG Configuration (.tx) file.



Note: The data referenced in the FTG Configuration List is only a snapshot of the current FTG Channel Map and FTG Installer Menu settings when copied to the list. If you make any change(s) to the current data to be included in the FTG Configuration List, you will need to recopy Channel Map and Installer Menu settings to the FTG Configuration List.

FTG File Manager Utilities Overview (Cont.)

FTG Channel Map Editor

The FTG Channel Map Editor shows a single Logical Channel's data and the FTG Channel Map.

LOGICAL CHANNEL MAPPING

Select a Logical Channel number. Then, assign the RF, Major, and Minor channel numbers to complete the mapping.

CUSTOM CHANNEL LABELS/ICONS

Enter custom labels and select icons by name on menu or by number.

SET CHANNEL ATTRIBUTES

Check/select Encrypted, OSD, or Blank Video.

Logical	RF	Major	Minor	Label	ICON	Attribute	Restricted
2	2	2	0	WBBM-TV	14 - CBS	0	
5	5	5	0	WMAQ-TV	15 - NBC	0	
7	7	7	0	WLS-TV	13 - ABC	0	
9	9	9	0	WGN-TV	89 - WGN	0	
11	11	11	0	WTTW	17 - PBS	0	
14	31	31	3	FOX	16 - FOX	0	
15	19	19	3	WGN	89 - WGN	0	
16	47	47	4	KIDS	133 - PBS Kids	0	
17	27	27	3	THE U	174 - UPN	0	
40	65	65	1	HBO-HD	12 - HBO	EO	
41	65	65	11	ESPN-HD	2 - ESPN	EO	
42	67	67	1	ESPN2HD	21 - ESPN2	EO	

ZONE RESTRICTION

Select Zone restriction for channel. See Reference section, "TV Zone Restrictions," for further information.

ADD

After defining a new Logical Channel, click to add channel to the FTG Channel Map.

EXIT

Click to exit editor and return to FTG Channel Map Configuration Utility.

UPDATE

After editing an existing Logical Channel's data, click to commit the changes in the FTG Channel Map.

DELETE

Click to remove highlighted channel from FTG Channel Map.

FTG File Manager Utilities Overview (Cont.)

FTG Installer Menu Configuration Utility

CONFIGURATION SETTINGS

Select tabs for categories of Installer Menu items to set up TV.

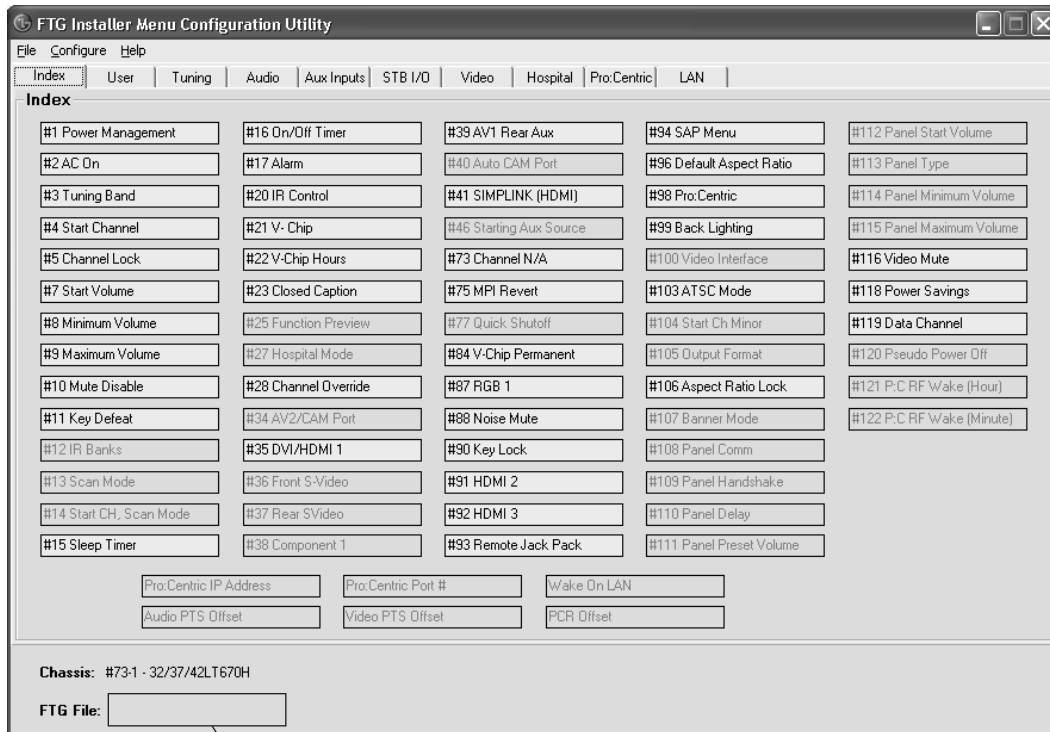

Filename of opened FTG Configuration (.rml) file created using FTG Device Configuration Application.

Notes:

- The Pro:Centric tab enables you to set up Pro:Centric-specific parameters. Refer to the **Free-To-Guest (FTG) File Manager User Guide** for further information.
- LAN and Hospital parameters are not applicable for these TV models.

Remote Jack Pack / TV Connections & Setup

Remote Jack Pack Setup

RJP Available? If you will use a Remote Jack Pack (RJP) in your system, set Installer Menu item **093 RJP AVAILABLE** appropriately (for example, on a legacy model RJP: HDMI Mode, set RJP AVAILABLE to 001). See Installer Menu detailed descriptions for further information.

093 RJP AVAILABLE 001

TV Connections



Make these connections ONLY after Master TV Setup and TV cloning procedures are complete.

Refer to the figure below, and connect the RJ-45 Control cable from the RJP cable bundle to the RJP INTERFACE port on the TV's rear jack panel. Then, connect HDMI, RGB, and Composite Video/Audio connectors, as applicable, for the cable bundle.

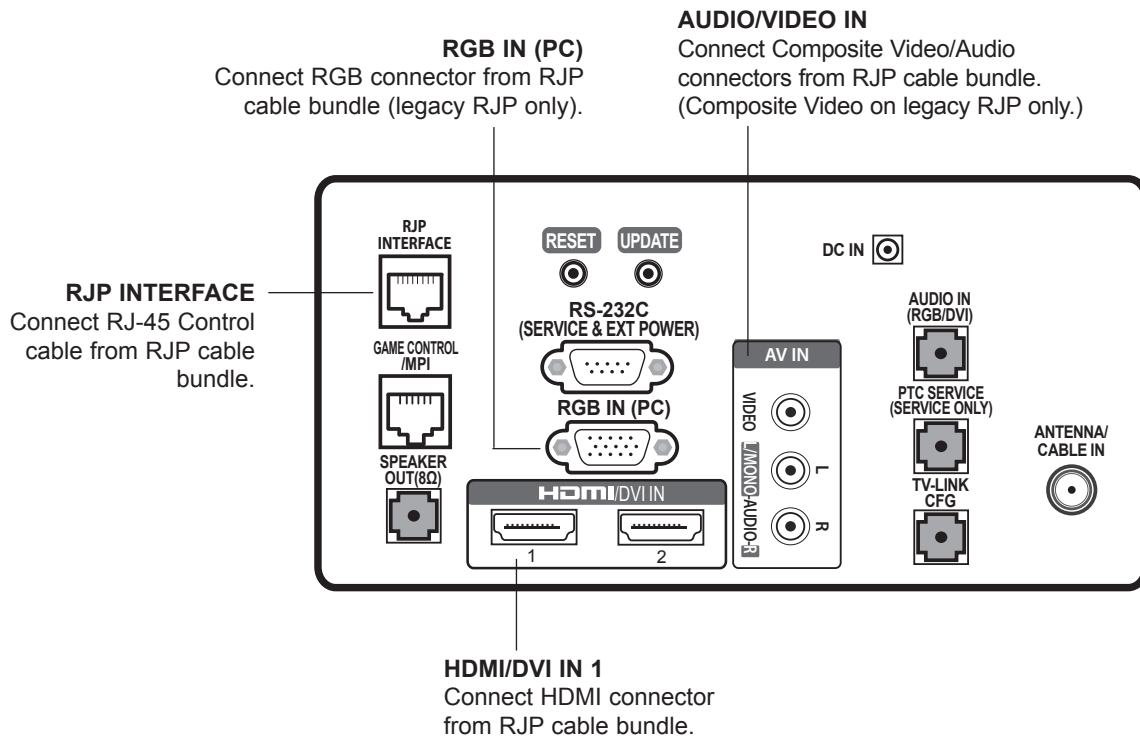

Note: DC IN connector on rear jack panel of 26LT670 only.

Reference: Upgrading TV/PTC Software using a USB Memory Device

Checking the Software Versions

You can check the software versions of the TV by accessing the Installer Menu with the Installer Remote (see “Accessing the Installer Menu” on page 18 for further information).

When you are finished, press **OK** again to exit the Installer Menu.

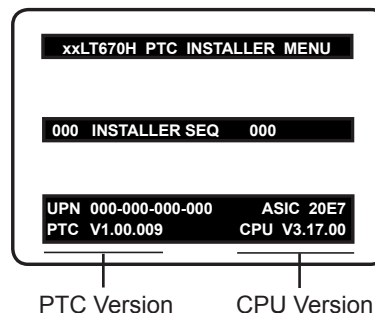

Typical Installer Menu

Upgrading TV/PTC Software

Before you begin, note that the software upgrade files must be stored in a folder named “LG_DTV” in the root directory of the USB memory device. Also, ensure the USB device has been formatted with FAT format.

Note for TV Software Upgrade only: If the TV detects a later version of software on the USB device, it will automatically display a dialog from which you can start the software upgrade immediately. Otherwise, you can close the dialog, and access the USB Download Menu as described below.

1. Turn ON the TV, and then plug the USB memory device into the USB IN port on the TV.
2. Press **MENU SETTINGS** on the Installer Remote to display the TV setup menus (TV is in Pass-through Mode) or the Function Menu (TV is not in Pass-through Mode).
3. Use the arrow navigation keys to select/highlight either the **Option** menu icon from the TV setup menus or the **Lock** menu icon from the Function Menu. Then, press the number “7” key a total of seven times to display the USB Download Menu.
4. Use the Up/Down arrow keys to select **Upgrade TV Software** or **Upgrade PTC Software**, as applicable, and press **OK**.
5. Select the appropriate option(s), depending on the type of upgrade:
 - TV Software Upgrade: (See screen samples at right.) Select **TV Software Update** from the first TV Software Update window. In the second TV Software Update window, select/highlight the update file to install and press **OK**.
Note: Do not select Forced Update options unless you have been specifically instructed to do so or have previous experience with Expert Software Updates.
 - PTC Software Upgrade: In the PTC Software Update window, select/highlight the update file to install and press **OK**.
Note: The PTC Software Update window is similar to the second TV Software Update window, though there are no Forced Update options. Current software version information is shown at the top and update files on the USB device are listed at the bottom of the window.

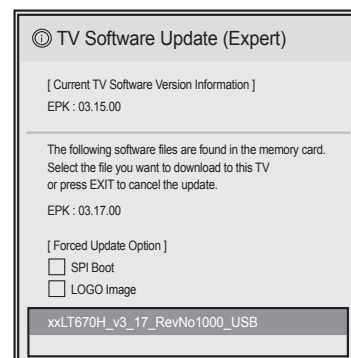
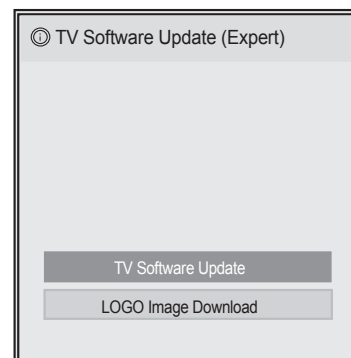
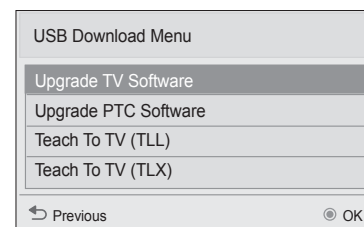

The TV will show update completion progress in a new window. Do NOT remove the USB device until the software upgrade is complete. When a TV software upgrade is complete, the TV will reset itself with an automatic restart. When a PTC upgrade is complete, the TV will turn OFF.

Reference: Downloading a Splash Screen using a USB Memory Device

Splash Screen Image File Guidelines

- The splash screen image must be a baseline (not progressive) JPEG.
- The image should be no larger than 1 MB.
- The ideal size for the image is 1366 x 768 pixels or under.
- The image file must be stored in a folder named “LG_DTV” in the root directory of USB memory device.
- Ensure the USB device has been formatted with FAT format.

Downloading a Splash Screen Image

1. Turn ON the TV, and then plug the USB memory device into the USB IN port on the TV.
2. Press **MENU SETTINGS** on the Installer Remote to display the TV setup menus (TV is in Pass-through Mode) or the Function Menu (TV is not in Pass-through Mode).
3. Use the arrow navigation keys to select/highlight either the **Option** menu icon from the TV setup menus or the **Lock** menu icon from the Function Menu. Then, press the number “7” key a total of seven times to display the USB Download Menu.
4. Use the Up/Down arrow keys to select **Upgrade TV Software**, and then press **OK**.
5. Select **LOGO Image Download** from the first TV Software Update window.
6. In the second TV Software Update window, use the Up/Down arrow keys to select the image file to download, and then press **OK**.

The TV will show download completion progress in a new window. Do NOT remove the USB device until the image download is complete. When the image download is complete, the TV will reset itself with an automatic restart. Upon the restart, you should see the new splash screen.

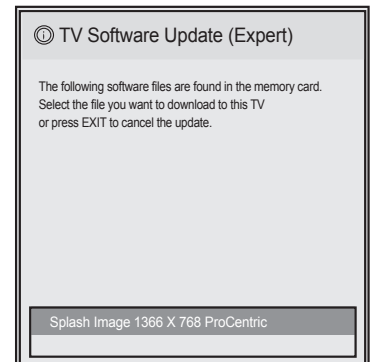
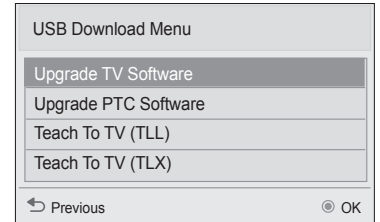

Reference: Power Consumption Settings

The following tables assume that Installer Menu item 118 POWER SAVINGS is set to 003 (default) and Installer Menu item 099 BACK LIGHTING is set as shown below (default value is 100).

Item 099 Back Lighting (Static)	26LT670H		32LT670H		37LT670H		42LT670H	
	Power Consumption (Watts)	Percent Savings	Power Consumption (Watts)	Percent Savings	Power Consumption (Watts)	Percent Savings	Power Consumption (Watts)	Percent Savings
100	31.9	0.0%	39.2	0.0%	49.2	0.0%	66.6	0.0%
90	30.2	5.3%	37.3	4.8%	46.7	5.1%	62.7	5.9%
80	28.5	10.7%	35.4	9.7%	44.2	10.2%	59.8	10.2%
70	26.6	16.6%	33.5	14.5%	41.8	15.0%	57.5	13.7%
60	25.0	21.6%	31.6	19.4%	39.2	20.3%	56.1	15.8%
50	23.4	26.6%	29.6	24.5%	36.6	25.6%	53.7	19.4%
40	21.7	32.0%	27.7	29.3%	34.1	30.7%	51.2	23.1%
30	19.9	37.6%	25.8	34.2%	31.6	35.8%	45.1	32.3%
20	18.0	43.6%	23.8	39.3%	29.1	40.9%	39.7	40.4%
10	16.4	48.6%	21.7	44.6%	26.5	46.1%	33.7	49.4%
1	14.6	54.2%	20.0	49.0%	23.7	51.8%	28.5	57.2%

Item 099 Back Lighting (Dynamic)	26LT670H		32LT670H		37LT670H		42LT670H	
	Power Consumption (Watts)	Percent Savings	Power Consumption (Watts)	Percent Savings	Power Consumption (Watts)	Percent Savings	Power Consumption (Watts)	Percent Savings
200	32.2	0.0%	38.7	0.0%	48.7	0.0%	66.3	0.0%
190	30.4	5.6%	36.8	4.9%	46.1	5.3%	62.6	5.6%
180	28.7	10.9%	34.8	10.1%	44.3	9.0%	59.8	9.8%
170	26.6	17.4%	33.4	13.7%	41.8	14.2%	57.6	13.1%
160	25.1	22.0%	31.5	18.6%	39.1	19.7%	56.0	15.5%
150	23.6	26.7%	29.6	23.5%	37.0	24.0%	53.8	18.9%
140	21.7	32.6%	27.7	28.4%	34.4	29.4%	51.2	22.8%
130	19.7	38.8%	25.5	34.1%	31.7	34.9%	45.2	31.8%
120	18.1	43.8%	23.8	38.5%	29.1	40.2%	39.6	40.3%
110	16.3	49.4%	21.8	43.7%	26.4	45.8%	33.8	49.0%
101	14.7	54.3%	20.0	48.3%	23.8	51.1%	28.3	57.3%

Note: Values are results of controlled experiments under laboratory conditions.

Reference: TV Aux Input Configuration

DIRECT ACCESS Tuning		TV		ENABLE				MPI DATA			START AUX SOURCE ASSIGN- MENT
				Installer Menu		MPI DATA STATUS TYPE 0x41 SOURCES ENABLED (R/W)		DATA STATUS TYPE 0xD2 CURRENT AV SOURCE (R)		DATA STATUS TYPE 0x0D AUX SOURCE (R)	
OLD_ OCV = 0	OLD_ OCV = 1	Source Input	Source Mode	Number	Labeling	Value	Labeling	Value	Labeling		
131	91	Video1 (Rear)	CV	39	REAR_AUX_EN	0x02	Rear Video (Aux)	1	Rear Video (Aux)	0 (VIDEO)	1
132	92	HDMI2	DTV/PC	91	HDMI2 ENABLE	0x04	S-Video Rear	2	S-Video Rear	0 (VIDEO)	5
133	93	HDMI1/DVI	DTV/PC	35	HDMI1 ENABLE	0x08	Front Computer	3	Front Computer	0 (VIDEO)	3
134	94	RGB	PC	87	REAR RGB EN	0x10	SVGA Rear Computer	4	SVGA Rear Computer	2 (COMPUTER)	4
135	95	HDMI3	DTV/PC	92	HDMI3 ENABLE	0x20	NTSC Rear Computer	5	NTSC Rear Computer	0 (VIDEO)	7

Reference: *b*-LAN Setup & Overview

The *b*-LAN module is internal to the TV. It allows hotel/institution head end equipment with *b*-LAN technology to communicate, via the institution's RF distribution system, with the TV for configuration and control.

Note: MPI cards with *b*-LAN technology—LMT7Z5, LMT7Z7, LMT7Z9—are NOT supported in TVs in which *b*-LAN technology is already integrated.

Installer Menu item 118 POWER SAVINGS controls the power circuitry for both the embedded *b*-LAN module and the GAME CONTROL/MPI port (see note below). The default value is 003—the *b*-LAN module is only powered when the TV is turned ON. See chart below.

POWER SAVINGS	TV Standby State	TV Power On State
	<i>b</i> -LAN & GAME CONTROL/MPI Port Power	<i>b</i> -LAN & GAME CONTROL/MPI Port Power
001	On	On
003 (default)	Off	On

A *b*-LAN enabled head end device, such as an LG FMA-LG101, broadcasts over the RF distribution system to communicate to multiple TVs. When the TV is first installed, it must be turned ON in order for its embedded *b*-LAN module to receive communication from the head end device. At this point, if it is desired for the *b*-LAN module to always be powered, including while the TV is in Standby, set Installer Menu item 118 POWER SAVINGS to 001.

Also, if MPI communication is required for external MPI control, set Installer Menu item 118 POWER SAVINGS to 001 so that the GAME CONTROL/MPI port circuitry is always powered.

Reference: RJP Model List & Input Auto-sensing Hierarchy

RJP Legacy Models

- RJP-101M
- RJP-101ML
- RJP-110F
- RJP-110FW
- RJP-110W
- RJP-110WBR
- RJP-110S
- RJP-120G
- RJP-120T
- RJP-201B/202B

RJP Scaler Models

- RJP-201M
- RJP-301B
- RJP-401B

RJP Input Auto-sensing Hierarchy

Priority	Video	Audio
1st (Highest)	Digital Video In	Audio In (3.5mm)
2nd	PC Video In	Audio In (L/R)
3rd	Video In	Digital Video In

Reference: Restoring Factory Defaults on the TV(s)

This section describes how to restore factory defaults either on a single TV that is currently in Pass-through or FTG Mode or on multiple TVs that are currently in FTG Mode.

Note: If the TV(s) is/are currently in FTG Mode, restoring the factory defaults also resets the TV to Pass-through Mode.

Installer Menu Item 117 FACT DEFAULT

If the TV is currently in Pass-through Mode, you can set Installer Menu item 117 FACT DEFAULT to 001 to restore the factory defaults and clear the channel lineup, including any assigned channel icons and custom text labels.

Factory “IN-STOP”

If the TV is currently in FTG Mode, a predefined value for Installer Menu item 117 FACT DEFAULT enables access to initiate a factory “IN-STOP” process that will restore the TV to Pass-through Mode in addition to restoring all factory defaults. Contact technical support for the required value for Installer Menu item 117 and for additional information on performing the IN-STOP from the Installer Menu.

Additional FTG Mode via CPU Options

There are two additional options for restoring Pass-through Mode/factory defaults on TVs that are in FTG Mode via the CPU. The first enables you to reset a single TV to Pass-through Mode, while the second enables you to reset multiple TVs to Pass-through Mode at one time. However, both options require that you create a “Zero Mapped Channels” FTG Configuration (.tlx) file, i.e., an FTG Configuration file with no data. Refer to the *Free-To-Guest (FTG) File Manager User Guide* for further information.

- Using a USB memory device, “Teach” a “Zero Mapped Channels” FTG Configuration (.tlx) file to the TV. Refer to “Teaching FTG Configuration to a TV” on page 41 of this document for further information on the Teaching process.
- If your system uses a Pro:Centric server for remote management/administration, use the Pro:Centric Admin Client to load a “Zero Mapped Channels” FTG Configuration (.tlx) file on the Pro:Centric server. Refer to the *Pro:Centric™ Server Admin Client User Guide* for further information.

Additional FTG Mode via EBL Options

There are two additional options for restoring Pass-through Mode/factory defaults on TVs that are in FTG Mode via the EBL. The first enables you to reset a single TV to Pass-through Mode, while the second enables you to reset multiple TVs to Pass-through Mode at one time.



Note: While the IN-STOP process described above will clear both the PTC and the CPU, both options below only clear the PTC. Thus, the current Channel Map and TV setup menu settings will remain in the CPU after the reset is completed.

- Using a direct PC-to-TV connection, “Write” an unpopulated Channel Map—that is, a Channel Map with 0 (zero) channels—to the TV. Refer to the “FTG Mode via EBL” procedure on page 44 and/or the *Free-To-Guest (FTG) Device Configuration Application User Guide* for further information.
- If your system uses an FMA for remote management/broadcast configuration, configure the FMA device with an FMA Configuration (.fma) file that only contains a “0 Mapped Channels” FTG Channel Map to broadcast to the TV EBL(s). Refer to the *Free-To-Guest (FTG) Device Configuration Application User Guide* and/or the Installation & Configuration Guide for the FMA device for further information.

Reference: TV Zone Restrictions

The FTG Channel Map Editor in the FTG File Manager's FTG Channel Map Configuration Utility enables you to assign Zone restrictions to channels that may be deemed unsuitable for certain locations, for example, a hotel lobby. In the FTG Channel Map Editor, a Zone # (for example, "1") must be designated for each channel that is to be restricted.

On location, set the Zone # for all the TVs in a select area, or "Zone" (for example, the lobby) so that the TVs can omit channels that have been restricted in the FTG Channel Map. However, note that while a channel can be restricted from up to eight Zones, a TV can only ever be in (set for) one Zone. TV Zone 0 is the default TV Zone #. When the TV Zone is 0, the TV will ignore any restriction that may be placed on channels in the FTG Channel Map.

See the FTG Channel Map Editor overview on page 47. Also, see the **Free-To-Guest (FTG) File Manager User Guide** for more detailed information on assigning Zone restrictions.

Use the following procedure to specify a Zone designation for a TV. Note that the Zone can only be set while the TV is in Pass-through Mode.

1. Turn ON the TV.
2. Press **MENU SETTINGS** on the Installer Remote, and use the arrow navigation keys to select/highlight the **OPTION** menu option. Then, press **OK**.
3. Use the Up/Down arrows to select **Zone**, and then press **OK**.
4. In the Zone pop-up window, use the Left/Right arrows to select the appropriate Zone number. Then, press **OK**.
5. Press **MENU SETTINGS** to return to TV viewing.

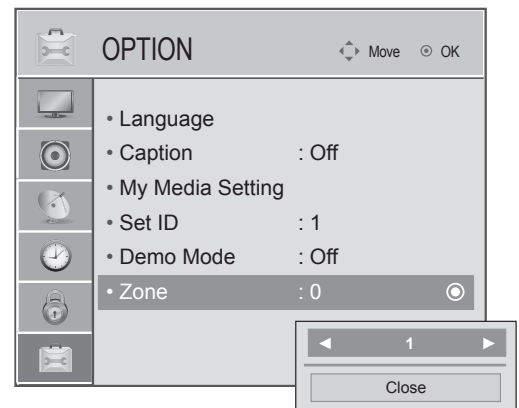

Reference: LT670H Rear and Side Jack Panels

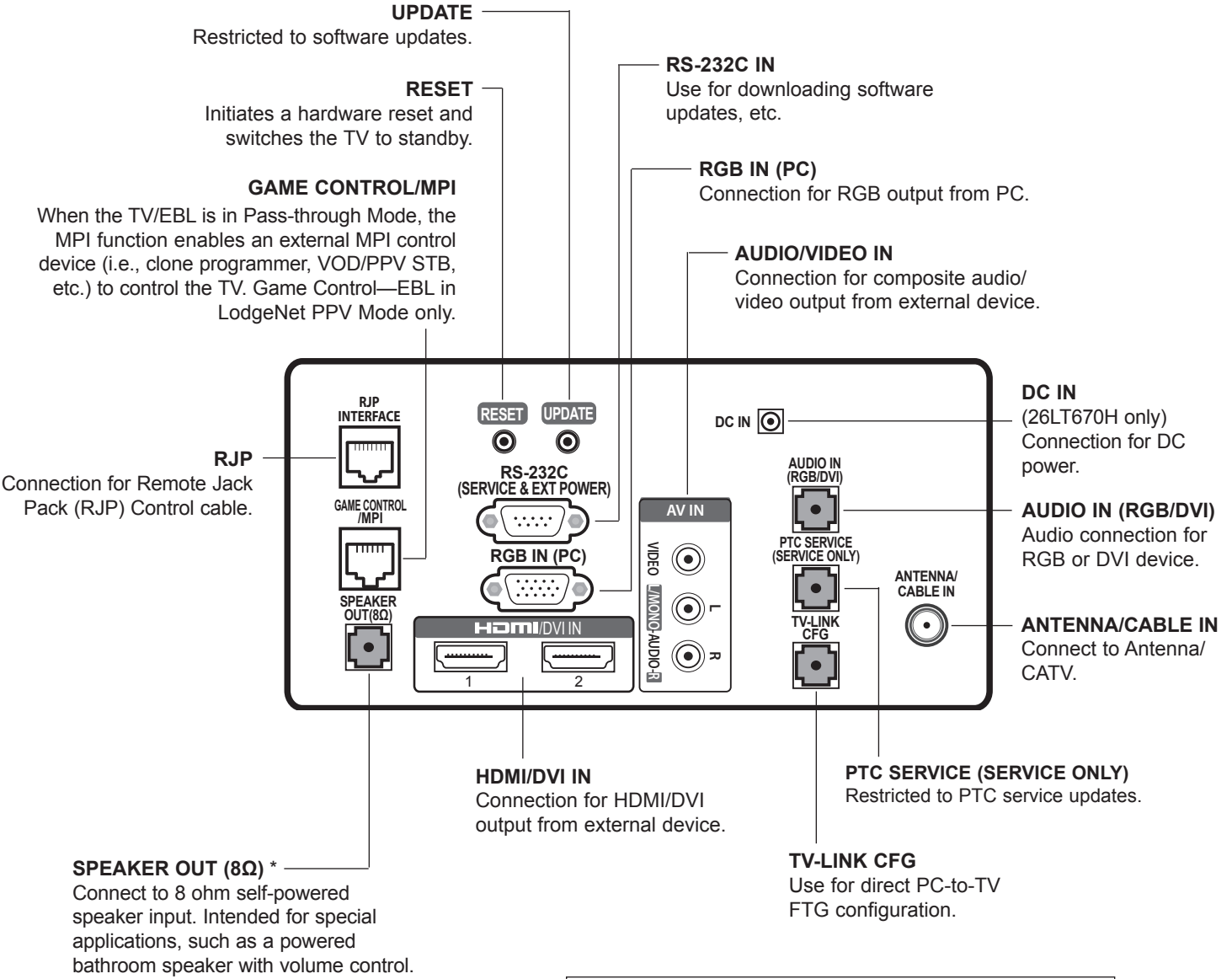

* This stereo jack provides a mono speaker fixed-level, 1 watt output (audio +, audio -, w/ground shield). Do NOT plug in a mono connector, as this may damage the TV.

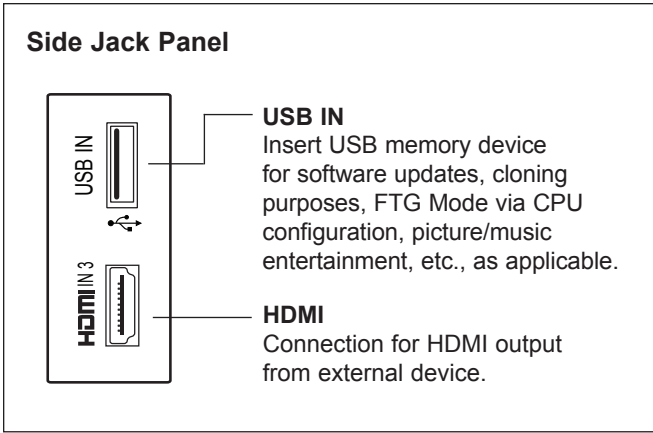

Reference: Installer Remote Control Typical Key Functions

The LG Installer Remote is supplied with and dedicated to operate the TV. The LG Installer Remote illustrated below and throughout this document shows typical remote control functions and is provided for reference only. This Installer Remote may vary from the Installer Remote supplied with the TV.

⏻ (POWER)
Turns the TV ON or OFF

TV/DVD
Select the remote's operating mode: TV or DVD.

NUMBER Buttons (0 - 9) & DASH
Use to enter a channel or program number. Dash is used for sub-channel numbers such as 2-1, 2-2, etc.

FLASHBK (FLASHBACK)
Returns to the previously tuned channel or input.

VOLUME UP/DOWN
Increases/decreases sound level.

CC
Activates subtitles.

TIMER
Sets the amount of time before the TV automatically turns itself OFF.

MUTE
Switches sound ON or OFF.

CHANNEL/PAGE UP/DOWN
Changes channels based on channels in the channel lineup. Moves to previous or next screen in Pro:Centric channel guide.

DVD/USB buttons
Use to control DVD player or view USB memory device content.

SIMPLINK
Accesses the AV devices connected to the HDMI ports of the TV. Opens the SIMPLINK Menu.

(PIP/SWAP options N/A for these TV models)

SAP
Analog Mode: Selects MTS sound (Mono, Stereo, or SAP). DTV Mode: Changes audio language, if additional languages are available.*

Q.MENU

BANK CH.PREVIEW

INPUT
Displays available input sources.
(Q. MENU/MARK options N/A for these TV models)

Arrows (Up/Down/Left/Right) & OK
Use to navigate on-screen menus, direct tune channels, and adjust TV settings.

MENU SETTINGS
Displays and removes the TV setup menus (or, if applicable, the Function Menu).

PORTAL
Displays and removes the Pro:Centric interactive menu.

INFO
Displays channel information.

GUIDE
Displays and removes the Pro:Centric channel guide/EPG.

↩ (RETURN)
Returns one level to the previous menu/display.

EXIT
Clears all on-screen displays and returns to TV viewing.

Color buttons access special functions in some menus.

* SAP notes:

- If SAP is selected and no SAP is provided, sound may not be heard on channel.
- Each analog channel may have its own SAP setting.
- Digital channels will reset to default audio language when TV is turned Off/On.

Troubleshooting

General Troubleshooting

Some Quick and Easy Tips for Resolving Problems

Symptom	Possible Cause(s)	Possible Solution(s)
Installation		
Cannot direct enter channel number.	(TV in Pass-through Mode) Installer Menu item 028 CH. OVERRIDE is set to 0, i.e., disabled (recommended setting).	If Installer Menu item 028 CH. OVERRIDE is set to 0, only channels that are active in the TV's channel lineup can be selected. Set CH. OVERRIDE to 1 to allow access for direct keypad entry to all channels.
	(TV in FTG Mode) The channel entered is not part of the FTG Channel Map.	Channel access is restricted to channels included in the FTG Channel Map. If necessary, make changes to the FTG Channel Map using the FTG File Manager or the FTG Device Configuration Application, as appropriate.

Power

No power.	See troubleshooting flow chart on following page.
-----------	---

Picture Reception and Sound

No picture.	TV is turned OFF.	<ul style="list-style-type: none"> • Turn TV ON. • Power failure?
	Antenna/cable not connected.	Connect antenna/cable signal to TV.
	Connections incorrect.	Check connections on TV.
	MPI not connected.	If applicable, connect MPI cable to MPI device.
	Encrypted program.	Try another channel.
Normal picture, poor or no sound.	Wrong tuning band.	Adjust Installer Menu settings.
	Audio muted.	Press MUTE or use Volume Up key to increase sound level.
	Broadcast problem.	Try a different channel.

Erratic Operation

Installer Menu setup.	Wrong Installer Menu settings.	Adjust Installer Menu settings as required.
-----------------------	--------------------------------	---

Installer Remote

Remote doesn't work.	Remote not in TV Mode.	Use MODE key to select "TV"; puts remote into TV Mode.
	Not aimed at IR remote sensor.	Point remote at IR receiver on TV.
	Remote too far from IR sensor.	Move remote closer to IR receiver on TV or darken room.
	MPI not connected.	If applicable, connect MPI cable to MPI device.
	IR path to TV's receiver obstructed.	Remove obstructions.
	Weak batteries.	Replace batteries.
	Wrong battery polarity.	Check that "+" and "-" match in battery compartment.
	Too much light in room.	Dim room light.
Wrong Installer Remote.	Requires compatible Installer Remote. Contact your LG dealer.	

Troubleshooting (Cont.)

Troubleshooting Flow Chart

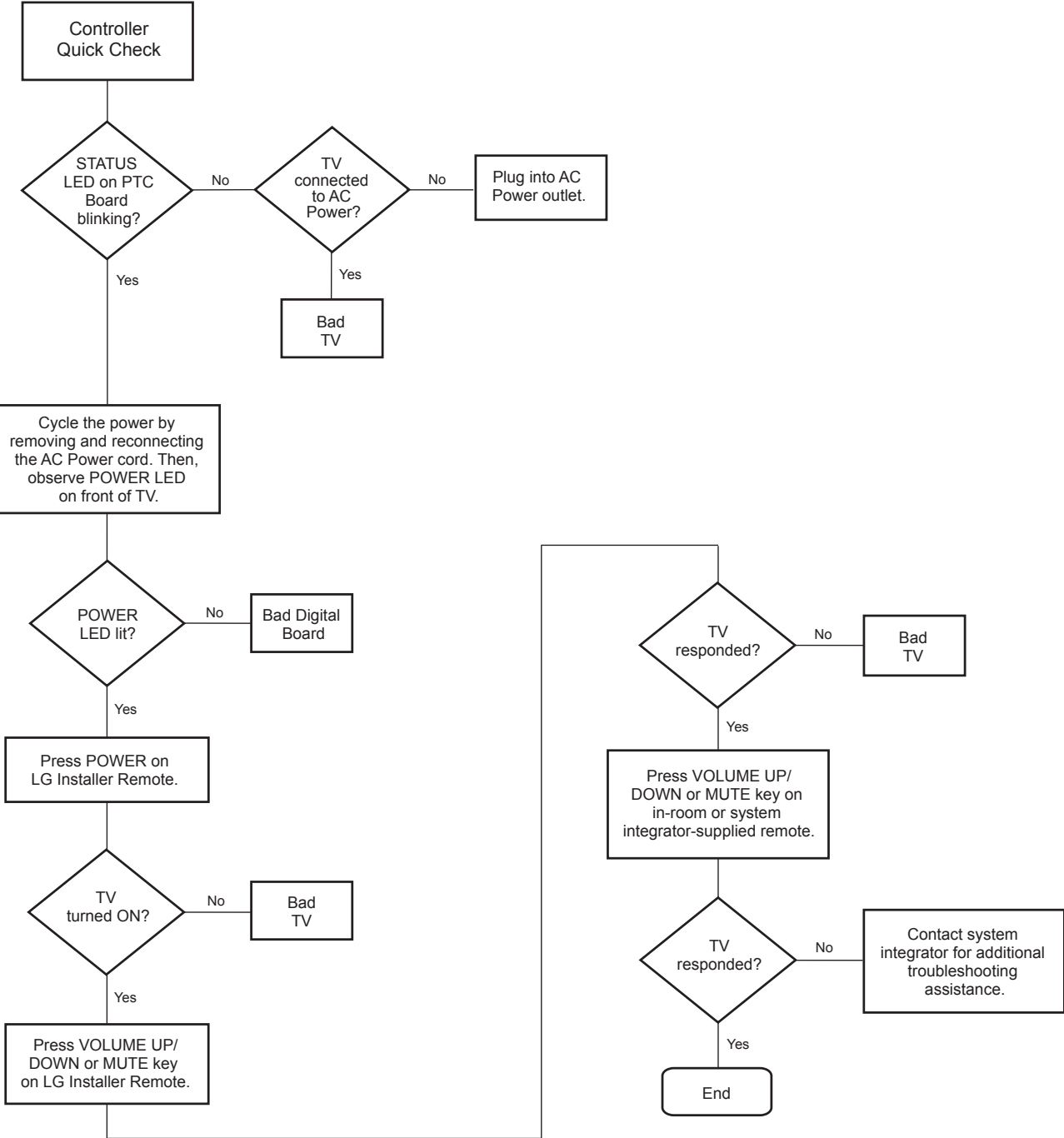

Troubleshooting (Cont.)

Commercial Mode Check / FTG Operation Troubleshooting

Commercial Mode Check

Use this flowchart to determine whether the TV is currently in Commercial Mode.

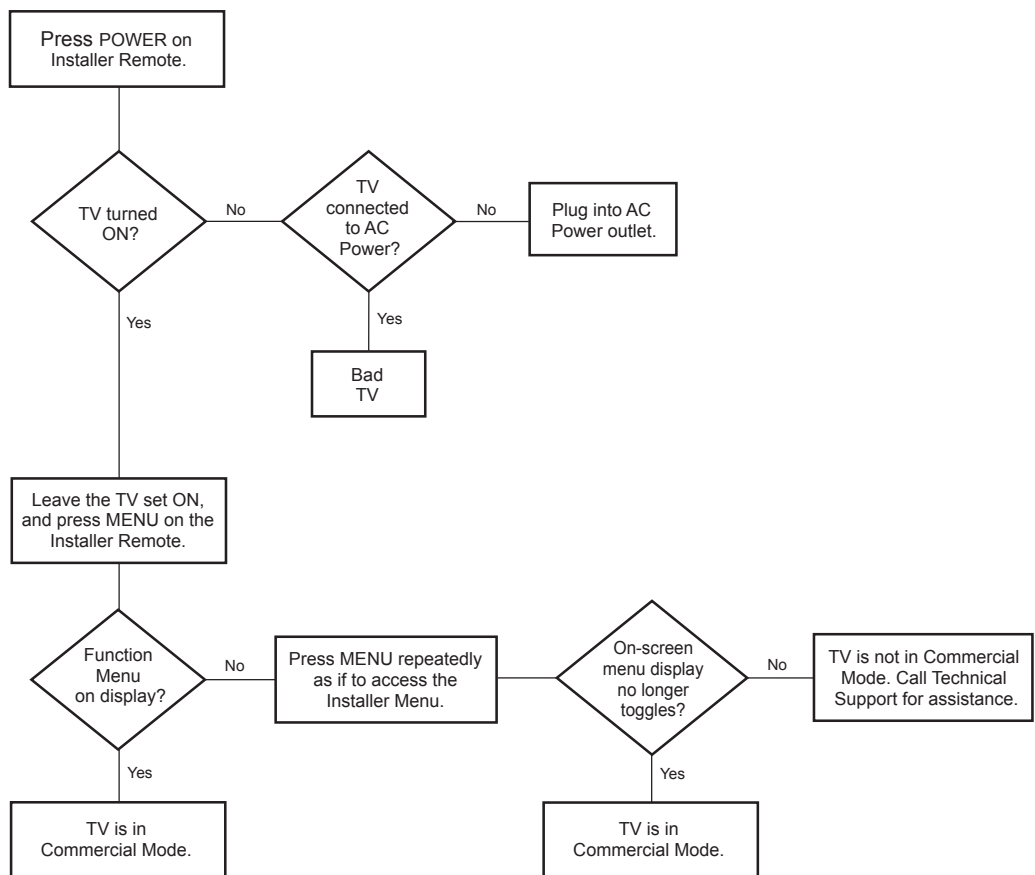

FTG Operation Troubleshooting

The following table provides troubleshooting information for when the EBL is configured in the FTG Mode of operation.

Symptom	Possible Cause(s)	Solution(s)
Communication Error ("Communications Timeout")	Cable(s) not connected.	Check and connect communication cables.
	TV not powered.	Check/connect the TV power cord.
	TV not turned ON.	TV needs to be turned ON (default setting of Installer Menu item 118 POWER SAVINGS).
	Wrong COM (communication) port.	In the FTG Device Configuration Application, select the correct COM port for the cable being used.

Clone Programmer Troubleshooting



Caution: If the TV is in LodgeNet PPV Mode (check with the site administrator if you are not certain), do not connect a clone programmer to the GAME CONTROL/MPI port, as this will damage the clone programmer.

Reset Clone Programmer After Static Shock

After replacing exhausted batteries (LT2002 only), or if the clone programmer behaves strangely after a static shock:

- TLL-1100A: Turn the TLL-1100A OFF and then ON.
- LT2002: Use a paper clip or similar instrument inserted through the small hole marked RESET to activate the internal reset switch and restore normal operation.

After a reset, check the real-time clock setting. It may be necessary to set the clone programmer clock from a TV containing the correct time.

Note: Both the Master and Target TVs must be in Pass-through Mode for cloning purposes. See also IMPORTANT CLONING INFORMATION on page 28.

Clone Programmer

Symptom	Possible Cause(s)	Possible Solution(s)
Clone copies setup in less than 30 seconds.	Not enough time to copy entire TV setup.	TLL-1100A: Turn the TLL-1100A OFF and then ON. LT2002: Press RESET on clone programmer. Then redo Learn/Teach. (Learning usually takes about 90 seconds; Teaching usually takes 3 to 4 minutes.)
Remote does not operate clone programmer.	Wrong Installer Remote.	Only use an LG Installer Remote to operate clone programmer with TV.
Clone menu does not display on TV screen, TLL-1100A shows error message, or LT2002 LED does not blink.	MPI cable not connected.	Connect MPI cable properly, and ensure good connection.
	TV not turned ON.	TV must be turned ON for clone programmer to work.
	(LT2002 only) Weak batteries.	Install four (4) fresh AA high-quality alkaline batteries.
	(TLL-1100A only) No charge.	Ensure the TLL-1100A is fully charged or connected to AC power.
Clone menu hard to read.	Weak signal.	Connect TV to a reliable analog channel signal source.
No time set.	Time not available.	Set time on a TV, and copy time to clone programmer.
Clone not working.	Clone programmer problem.	<ul style="list-style-type: none"> • Try a different clone programmer. • Reset the clone programmer.
Clone scans channels more than once.	Clone should only scan channels once.	Ensure TV is set up correctly, and try cloning again.

Master and Target TVs

Symptom	Possible Cause(s)	Possible Solution(s)
Cloning did not work.	Procedure interrupted.	Wait until procedure complete message is displayed.
	Different TV models.	Cloning is only possible with identical model TVs.
	Step(s) omitted or not performed.	Refer to the applicable cloning procedure(s), and make sure all tasks were performed.
(LT2002 only) Clone time disappeared.	Batteries were removed.	Batteries must remain installed to retain time settings.
New setup not present.	Target TV not reset.	Disconnect Target TV from AC power for 15 seconds.

- After cloning operations are complete, unplug the TLL-1100A/LT2002 from the TV.
- If the TV does not display a picture (blank screen) after a few seconds, just change channels.

Glossary of Terms

A list of definitions for some of the words found in this guide.

75 OHM RF CABLE

The wire that comes from an off-air antenna or cable service provider. The end looks like a hex-shaped nut with a wire through the middle. It screws onto the Antenna/Cable threaded jack on the back of the TV.

300 TO 75 OHM ADAPTER

A small device that connects a 2-wire 300 ohm antenna to a 75 ohm RF jack. It is usually about an inch long with two screws on one end and a round opening with a wire extending out the other end.

A/V CABLES

Audio/Video cables. Three cables bunched together—right audio (red), left audio (white), and video (yellow). A/V cables are used for stereo playback of videocassettes and for higher quality picture and sound from other A/V devices.

A/V DEVICE

Any device that produces video or sound (VCR, DVD, cable box, or television).

AMPLIFIER

An electronic device that amplifies sound from a television, CD player, VCR, DVD player, or other Audio/Video device.

ANTENNA

The physical receiver of television signals sent over the air. A large metal piece of equipment does not always have to be visible to be using an antenna.

b-LAN

LodgeNet Interactive Corporation proprietary RF communication system used to configure/control TV via RF distribution system.

CABLE

Cable service box. Refers to the descrambler box cable subscribers use to receive cable programming signals.

CATV

Programming provided by a cable service.

COMPONENT VIDEO

Uses three wires for transporting three-color video signals. The end result is usually better video quality.

COMPOSITE VIDEO

Typical video jack, uses one wire for transporting three-color video signals.

DIGITAL TELEVISION

High-resolution, cinema-quality television signals transmitted digitally.

DVI

Digital Video Interface. Accommodates analog and digital interfaces with a single connector.

EBL

Embedded *b*-LAN module. See also *b*-LAN.

HDMI

High-definition multi-media interface.

HDSTB

High-definition set top box. Refers to a tuner device that receives high-definition television signals which have higher resolution than ordinary analog TV signals.

HDTV

High-definition television. Refers to television signals that have higher resolution than ordinary analog TV signals.

INPUT

Refers to the input jack that receives a signal from a TV, VCR, DVD Player, or other Audio/Video device.

JACK

An input or output connector on the back of a TV, VCR, DVD Player, or other Audio/Video device.

MONO SOUND

Mono (monaural) sound is one channel of sound. On more than one speaker, all the speakers play the same audio.

OUTPUT

Refers to the output jack that sends a signal out of a VCR, DVD, or other A/V device.

PHYSICAL CHANNEL NUMBER

The actual channel number. Analog channels use the Physical Channel number and digital channels can use a Virtual Channel number.

PTC

Protocol Translator Card. The commercial controller of the TV.

RGB (RED, GREEN, BLUE)

Connection input or output port available for producing a video image using three separate colors: Red, Green, and Blue.

RS-232

Serial communication port through which firmware is downloaded.

2ND AUDIO PROGRAMMING/SAP

Second Audio Programming (SAP) is another, separate audio channel available with some programming. Choosing SAP often refers to listening to audio in another language, such as Spanish or French.

SIGNAL

Picture and sound traveling through a cable, or over the air, to the TV.

STEREO SOUND

Stereo (Stereophonic) sound refers to audio that's divided into right and left sides.

TUNER

Device that picks up the broadcast signal and turns it into picture and sound.

VIRTUAL CHANNEL NUMBER

A re-mapped channel number. Analog channels use the Physical Channel number; however digital channels use a Virtual (or false) Channel number.

XDS

Extended Data Service. Additional program information included on the signal provided at the discretion of the broadcaster.

Note: Refer to www.atsc.org for further information.

Document Revision History / Open Source Software Notice

Document Revision History

Date	Description
June 2012	Revision A: New document

Product documentation is available online at: www.LGolutions.com/products. From the Products page, select **TVs, Systems & Solutions**, then **LCD TVs**, then the applicable TV. Click the **Literature & Downloads** tab at the bottom of the TV page, and select the required document(s) from the Downloads list.

Open Source Software Notice

To obtain the source code under GPL, LGPL, MPL and other open source licenses that are contained in this product, please visit <http://opensource.lge.com>. In addition to the source code, all referenced license terms, warranty disclaimers and copyright notices are available for download. LG Electronics will also provide open source code to you on CD-ROM for a charge covering the cost of performing such distribution (such as the cost of media, shipping and handling) upon e-mail request to opensource@lge.com. This offer is valid for three (3) years from the date on which you purchased the product.



For Customer Support/Service, please call:

1-888-865-3026

www.LGsolutions.com

Pro:Idiom is a registered trademark of Zenith Electronics LLC. Pro:Centric is a trademark of LG Electronics U.S.A., Inc. *b*-LAN is a trademark of LodgeNet Interactive Corporation. All other trademarks or registered trademarks are the property of their respective owners.

Free Manuals Download Website

<http://myh66.com>

<http://usermanuals.us>

<http://www.somanuals.com>

<http://www.4manuals.cc>

<http://www.manual-lib.com>

<http://www.404manual.com>

<http://www.luxmanual.com>

<http://aubethermostatmanual.com>

Golf course search by state

<http://golfingnear.com>

Email search by domain

<http://emailbydomain.com>

Auto manuals search

<http://auto.somanuals.com>

TV manuals search

<http://tv.somanuals.com>