

# ***Portable DVD Player***

---



## **Owner's Manual**

### **Model: DP771**



Before connecting, operating or adjusting this product, please read this instruction booklet carefully and completely.



## Safety Precautions (Continued)



**CAUTION**  
RISK OF ELECTRIC SHOCK  
DO NOT OPEN



**CAUTION:** TO REDUCE THE RISK OF ELECTRIC SHOCK  
DO NOT REMOVE COVER (OR BACK)  
NO USER-SERVICEABLE PARTS INSIDE  
REFER SERVICING TO QUALIFIED SERVICE PERSONNEL.



This lightning flash with arrowhead symbol within an equilateral triangle is intended to alert the user to the presence of uninsulated dangerous voltage within the product's enclosure that may be of sufficient magnitude to constitute a risk of electric shock to persons.



The exclamation point within an equilateral triangle is intended to alert the user to the presence of important operating and maintenance (servicing) instructions in the literature accompanying the product.

**WARNING:** TO PREVENT FIRE OR ELECTRIC SHOCK HAZARD, DO NOT EXPOSE THIS PRODUCT TO RAIN OR MOISTURE.

**WARNING:** Do not install this equipment in a confined space such as a bookcase or similar unit.

**CAUTION:** Do not block any ventilation openings. Install in accordance with the manufacturer's instructions.

Slots and openings in the cabinet are provided for ventilation and to ensure reliable operation of the product and to protect it from over heating. The openings should never be blocked by placing the product on a bed, sofa, rug or other similar surface. This product should not be placed in a built-in installation such as a bookcase or rack unless proper ventilation is provided or the manufacturer's instruction have been adhered to.

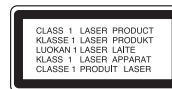

### CAUTION:

This product employs a Laser System.

To ensure proper use of this product, please read this owner's manual carefully and retain it for future reference. Should the unit require maintenance, contact an authorized service center.

Use of controls, adjustments or the performance of procedures other than those specified herein may result in hazardous radiation exposure.

To prevent direct exposure to laser beam, do not try to open the enclosure. Visible laser radiation when open. **DO NOT STARE INTO BEAM.**

**CAUTION:** The apparatus should not be exposed to water (dripping or splashing) and no objects filled with liquids, such as vases, should be placed on the apparatus.

**CAUTION:** Danger of explosion if battery is incorrectly replaced. Replace only with the same or equivalent type.

### NOTES ON COPYRIGHTS:

It is forbidden by law to copy, broadcast, show, broadcast via cable, play in public, or rent copyrighted material without permission.

This product features the copy protection function developed by Macrovision. Copy protection signals are recorded on some discs. When recording and playing the pictures of these discs on a VCR, picture noise will appear.

This product incorporates copyright protection technology that is protected by method claims of certain U.S. patents and other intellectual property rights owned by Macrovision Corporation and other rights owners. Use of this copyright protection technology must be authorized by Macrovision Corporation, and is intended for home and other limited viewing uses only unless otherwise authorized by Macrovision Corporation. Reverse engineering or disassembly is prohibited.

## Safety Precautions

### CAUTION concerning the Power Cord

#### Most appliances recommend they be placed upon a dedicated circuit;

That is, a single outlet circuit which powers only that appliance and has no additional outlets or branch circuits. Check the specification page of this owner's manual to be certain.

Do not overload wall outlets. Overloaded wall outlets, loose or damaged wall outlets, extension cords, frayed power cords, or damaged or cracked wire insulation are dangerous. Any of these conditions could result in electric shock or fire. Periodically examine the cord of your appliance, and if its appearance indicates damage or deterioration, unplug it, discontinue use of the appliance, and have the cord replaced with an exact replacement part by an authorized servicer.

Protect the power cord from physical or mechanical abuse, such as being twisted, kinked, pinched, closed in a door, or walked upon. Pay particular attention to plugs, wall outlets, and the point where the cord exits the appliance.

To disconnect power from the mains, pull out the mains cord plug. When installing the product, ensure that the plug is easily accessible.

**FCC WARNING:** This equipment may generate or use radio frequency energy. Changes or modifications to this equipment may cause harmful interference unless the modifications are expressly approved in the instruction manual. The user could lose the authority to operate this equipment if an unauthorized change or modification is made.

#### REGULATORY INFORMATION: FCC Part 15

This equipment has been tested and found to comply with the limits for a Class B digital device, pursuant to Part 15 of the FCC Rules. These limits are designed to provide reasonable protection against harmful interference in a residential installation. This equipment generates, uses and can radiate radio frequency energy and, if not installed and used in accordance with the instructions, may cause harmful interference to radio communications.

However, there is no guarantee that interference will not occur in a particular installation. If this equipment does cause harmful interference to radio or television reception, which can be determined by turning the equipment off and on, the user is encouraged to try to correct the interference by one or more of the following measures:

- Reorient or relocate the receiving antenna.
- Increase the separation between the equipment and receiver.
- Connect the equipment into an outlet on a circuit different from that to which the receiver is connected.
- Consult the dealer or an experienced radio/TV technician for help.

**FCC COMPLIANCE:** The responsible party for this product's compliance is:

LG Electronics U.S.A., Inc.,  
1000 Sylvan Avenue, Englewood Cliffs, NJ.  
Phone: 1-201-816-2000.

# IMPORTANT SAFETY INSTRUCTIONS

**CAUTION: PLEASE READ AND OBSERVE ALL WARNINGS AND INSTRUCTIONS IN THIS OWNER'S MANUAL. AND THOSE MARKED ON THE PRODUCT. RETAIN THIS BOOKLET FOR FUTURE REFERENCE.**

This product has been designed and manufactured to assure personal safety. Improper use can result in electric shock or fire hazard. The safeguards incorporated in this product will protect you if you observe the following procedures for installation, use, and servicing.

This product does not contain any parts that can be repaired by the user.

**DO NOT REMOVE THE CABINET COVER, OR YOU MAY BE EXPOSED TO DANGEROUS VOLTAGE. REFER SERVICING TO QUALIFIED SERVICE PERSONNEL ONLY.**

1. **Read these instructions.** - All these safety and operating instructions should be read before the product is operated.
2. **Keep these instructions.** - The safety, operating and use instructions should be retained for future reference.
3. **Heed all warnings.** - All warnings on the product and in the operating instructions should be adhered to.
4. **Follow all instructions.** - All operating and use instructions should be followed.
5. **Do not use this apparatus near water.** - For example: near a bath tub, wash bowl, kitchen sink, laundry tub, in a wet basement; or near a swimming pool; and other areas located near water.
6. **Clean only with dry cloth.** - Unplug this product from the wall outlet before cleaning. Do not use liquid cleaners.
7. **Do not block any ventilation openings. Install in accordance with the manufacturer's instructions.** - Slots and openings in the cabinet are provided for ventilation and to ensure reliable operation of the product and to protect it from over-heating. The openings should never be blocked by placing the product on a bed, sofa, rug or other similar surface. This product should not be placed in a built-in installation such as a bookcase or rack unless proper ventilation is provided or the manufacturer's instructions have been adhered to.

8. Do not install near any heat sources such as radiators, heat registers, stoves, or other apparatus (including amplifiers) that produce heat.
9. Do not defeat the safety purpose of the polarized or grounding-type plug. A polarized plug has two blades with one wider than the other. A grounding type plug has two blades and a third grounding prong. The wide blade or the third prong are provided for your safety. If the provided plug does not fit into your outlet, consult an electrician for replacement of the obsolete outlet.
10. Protect the power cord from being walked on or pinched particularly at plugs, convenience receptacles, and the point where they exit from the product.
11. Only use attachments/accessories specified by the manufacturer.
12. Use only with the cart, stand, tripod, bracket, or table specified by the manufacturer, or sold with apparatus. When a cart is used, use caution when moving the cart/product combination to avoid injury from tip-over.



13. Unplug this product during lightning storms or when unused for long periods of time.
14. Refer all servicing to qualified service personnel. Servicing is required when the product has been damaged in any way, such as power-supply cord or plug is damaged, liquid has been spilled or objects have fallen into the product, the product has been exposed to rain or moisture, does not operate normally, or has been dropped.

# Contents

## Introduction

Safety Precautions . . . . .	2-3
IMPORTANT SAFETY INSTRUCTIONS . . . . .	4
Contents . . . . .	5
Before Use . . . . .	6-8
About the ☹ Symbol Display . . . . .	6
Symbol used in this Manual . . . . .	6
Notes on Discs . . . . .	6
Maintenance and Service . . . . .	7
Types of Playable Discs . . . . .	8
Regional Code . . . . .	8
Identification of Controls . . . . .	9-12
Main Unit . . . . .	9-10
Remote Control . . . . .	11-12
Power Connections . . . . .	13-16
Connect the AC adapter . . . . .	13
Connect the Automotive adapter . . . . .	14
Battery Pack . . . . .	15-16
Rotating the LCD . . . . .	17
Playing a Disc . . . . .	18

## Advanced Operations

Displaying Disc Information on-screen . . . . .	19
Initial Settings . . . . .	19-24
General Operation . . . . .	19
LANGUAGE . . . . .	20
DISPLAY . . . . .	20
AUDIO . . . . .	21
LOCK (Parental Control) . . . . .	22-23
OTHERS . . . . .	24
General Features . . . . .	25-27
Additional Features . . . . .	28

Playing an Audio CD or MP3/WMA file . . . . .	29
Programmed Playback . . . . .	30
Repeat Programmed Tracks . . . . .	30
Erasing a Track from Program List . . . . .	30
Erasing the Complete Program List . . . . .	30
Viewing a JPEG file . . . . .	31-32
Slide Show . . . . .	31
Still Picture . . . . .	31
Moving to another File . . . . .	32
Zoom . . . . .	32
To rotate picture . . . . .	32
To listen to MP3/WMA music while watching picture . . . . .	32
JPEG disc compatibility with this unit is limited as follows . . . . .	32
Playing a DVD VR format Disc . . . . .	33
Playing an USB Flash Drive . . . . .	34

## Connections

Setting up the Player . . . . .	35-37
AV output Connections . . . . .	35
AV input Connections . . . . .	36
Audio Connection to Optional Equipment . . . . .	37

## Reference

Troubleshooting . . . . .	38
Language Code . . . . .	39
Area Codes . . . . .	40
Specifications . . . . .	41

## Before Use

To ensure proper use of this product, please read this owner's manual carefully and retain for future reference.

This manual provides information on the operation and maintenance of your unit. Should the unit require service, contact an authorized service location.

### About the Symbol Display

“ ” may appear on your LCD display during operation and indicates that the function explained in this owner's manual is not available on that specific DVD video disc.





### Symbol Used in this Manual

#### NOTE

Indicates special notes and operating features.

#### TIP

Indicates tips and hints for making the task easier. A section whose title has one of the following symbols is applicable only to the disc represented by the symbol.

-  All discs and files listed below
-  DVD and finalized DVD±R/RW
-  MP3 files.
-  Audio CDs.       WMA files.

## Notes on Discs

### Handling Discs

Do not touch the playback side of the disc. Hold the disc by the edges so that fingerprints do not get on the surface. Never stick paper or tape on the disc.



### Storing Discs

After playing, store the disc in its case. Do not expose the disc to direct sunlight or sources of heat and never leave it in a parked car exposed to direct sunlight.

### Cleaning Discs

Fingerprints and dust on the disc can cause poor picture quality and sound distortion. Before playing, clean the disc with a clean cloth. Wipe the disc from the center out.

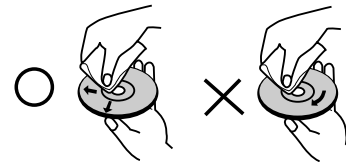

Do not use strong solvents such as alcohol, benzine, thinner, commercially available cleaners, or anti-static spray intended for older vinyl records.

### Maintenance and Service

Refer to the information in this chapter before contacting a service technician.

#### Handling the Unit

##### When shipping the unit

Please save the original shipping carton and packing materials. If you need to ship the unit, for maximum protection, re-pack the unit as it was originally packed at the factory.

##### Keeping the exterior surfaces clean

- Do not use volatile liquids such as insecticide spray near the unit.
- Do not leave rubber or plastic products in contact with the unit for a long period of time. since they leave marks on the surface.

##### Cleaning the unit

To clean the player, use a soft, dry cloth. If the surfaces are extremely dirty, use a soft cloth lightly moistened with a mild detergent solution.

Do not use strong solvents such as alcohol, benzine, or thinner, as these might damage the surface of the unit.

#### Maintaining the Unit

The DVD player is a high-tech, precision device. If the optical pick-up lens and disc drive parts are dirty or worn, the picture quality could be diminished.

Depending on the operating environment, regular inspection and maintenance are recommended after every 1,000 hours of use.

For details, please contact your nearest authorized service center.

## Before Use (Continued)

### Types of Playable Discs



DVD  
(8 cm / 12 cm disc)



Audio CD  
(8 cm / 12 cm disc)

In addition, this unit plays DVD±R/RW and CD-R/RW, USB that contains audio titles, MP3, WMA, and/or JPEG files.



This indicates a product feature that is capable of playing DVD-RW discs recorded with Video Recording format.

#### NOTES

- Depending on the conditions of the recording equipment or the CD-R/RW (or DVD±R/RW) disc itself, some CD-R/RW (or DVD±R/RW) discs cannot be played on the unit.
- Do not attach any seal or label to either side (the labeled side or the recorded side) of a disc.
- Do not use irregularly shaped CDs (e.g., heart-shaped or octagonal). It may result in malfunctions.

Customers should note that permission is required in order to download MP3 / WMA files and music from the Internet. Our company has no right to grant such permission. Permission should always be sought from the copyright owner.

### Regional Code

This unit has a regional code printed on the rear of the unit. This unit can play only DVD discs labelled same as the rear of the unit or "ALL".

#### Notes on Regional Codes

- Most DVD discs have a globe with one or more numbers in it clearly visible on the cover. This number must match your unit's regional code or the disc cannot play.
- If you try to play a DVD with a different regional code from your player, the message "Check Regional Code" appears on the TV screen.

**Manufactured under license from Dolby Laboratories. "Dolby", "Pro Logic" and the double-D symbol are trademarks of Dolby Laboratories.**

**DTS and DTS Digital Out are trademarks of Digital Theater Systems, Inc.**



# Identification of Controls

## Main Unit

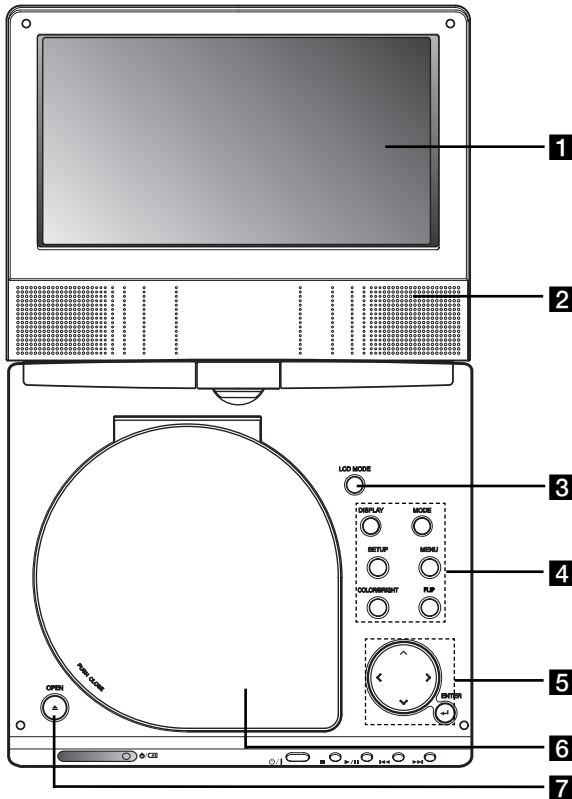

**1** LCD screen

**2** Speaker

**3** LCD MODE: NORMAL → 4:3 Mode → OFF

**4** Function Buttons

- **DISPLAY:** Accesses On-Screen display.
- **MODE:** Selects a mode among DISC, AV IN or USB.
- **SETUP:** Accesses or removes setup menu.
- **MENU:** Accesses menu on a DVD disc.
- **COLOR/BRIGHT:** Selects the mode of LCD adjustment  
Brightness → Color → OFF
- **FLIP:** Rotates the screen.

**5** Menu Control Buttons

- **◀ ▶ ▲ ▼ (left/right/up/down)**  
Selects an item in the menu.
- **◀ ▶:** Adjusts the COLOR/BRIGHT.
- **ENTER:** Confirms menu selection.

**6** Disc Lid

**7** OPEN button: Push this button to open the Disc lid.

## Identification of Controls (Continued)

### Main Unit

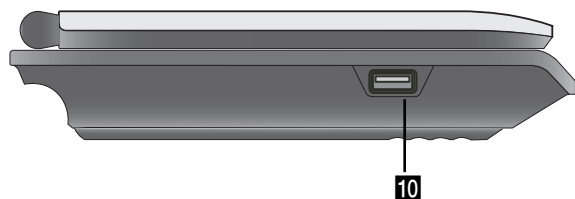
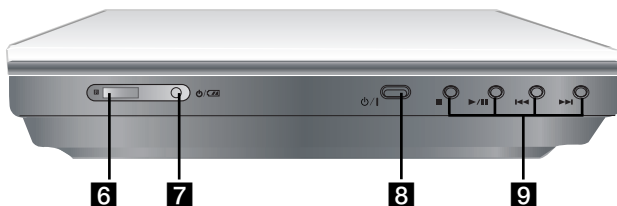
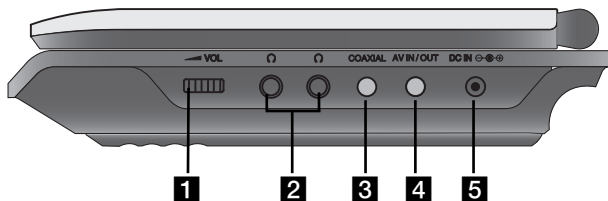

- 1 Volume Control**
- 2 Earphones jacks**
- 3 COAXIAL jack**
- 4 AV IN/OUT jack**

#### NOTE

If the VIDEO IN signal is not connected in AV IN mode, this unit will automatically power off in 10 minutes to prevent battery discharge.

- 5 DC IN**  Connect the AC adapter or Automotive adapter.
- 6 Remote sensor**  
Receive the signal from the Remote Control for operation.

#### 7 Battery charge indicator

- 8 ⏻/⏻ (POWER):** Switches the player ON or OFF.

#### 9 Playback buttons

- ( **STOP** ): Stops playback.
- ▶/|| ( **PLAY/PAUSE** ):  
Starts playback/ Pauses playback temporarily.
- ◀◀ ( **Reverse SKIP/SEARCH** )  
Search backward\*/ go to beginning of current chapter or track or go to previous chapter or track.
- ▶▶ ( **Forward SKIP/SEARCH** )  
Search forward\*/ go to next chapter or track.

\* Press and hold button for about two seconds.

- 10 USB:** Connect a USB Flash Drive.

## Identification of Controls (Continued)

### Remote Control

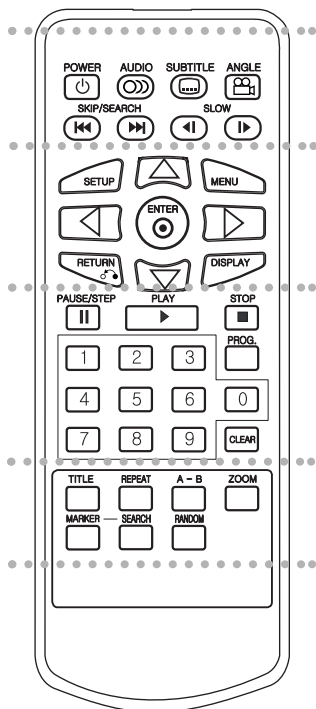

1



**POWER:** Switches DVD Player ON or OFF.

**AUDIO:** Selects an audio language.

**SUBTITLE:** Selects a subtitle language.

**ANGLE:**  
Selects a DVD camera angle, if available.

**Reverse SKIP/SEARCH ( ◀◀ ):**   
Search backward\*/ go to beginning of current chapter or track or go to previous chapter or track.

**Forward SKIP/SEARCH ( ▶▶ ):**   
Search forward\*/ go to next chapter or track.

\* Press and hold button for about two seconds.

**SLOW ( ◀ | ▶ ):**   
Reverse/ Forward slow playback.



**SETUP:** Accesses or removes setup menu.

**MENU:** Accesses menu on a DVD disc.

**RETURN ( ↶ ):**  Removes the menu.

**DISPLAY:** Accesses On-Screen display.

**◀ ▶ ▲ ▼ (left/right/up/down):**   
Selects an item in the menu.

**ENTER:** Confirms menu selection.



**PAUSE/STEP ( || ):**   
Pauses playback temporarily/ press repeatedly for frame-by-frame playback.

**PLAY ( ▶ ):**  Starts playback.  
**STOP ( ■ ):**  Stops playback.

**0-9 number buttons:**  
Selects numbered items in a menu.

**PROG.:** Places a track on the program list.

**CLEAR:**  
Removes a track number on the program list or a mark on the MARKER SEARCH menu.



**TITLE:** Displays title menu, if available.

**REPEAT:** Repeat chapter, track, title all.

**A-B:** Repeat sequence.

**ZOOM:** Enlarges video image.

**MARKER:** Marks any point during playback.

**SEARCH:** Displays MARKER SEARCH menu.

**RANDOM:** Plays tracks in random order.

## Identification of Controls (Continued)

### Insert the battery (Lithium battery)

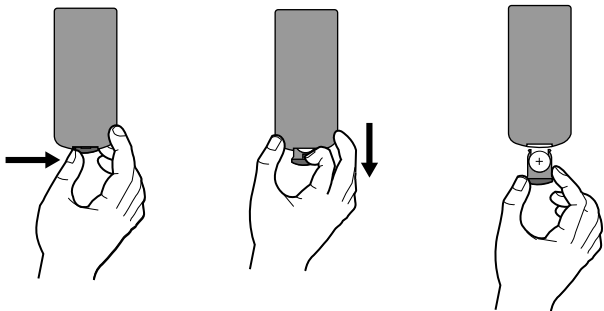

#### NOTES

- Do not expose the Remote Control sensor to bright light.
- Do not place obstacles between the Remote Control sensor and the Remote Control.

#### ■ Replacing the button-type battery

The battery normally lasts for about a year. Replace the battery if the Remote Control fails to operate the unit when used within the operation range.

### Button-type battery (Lithium battery)

1. Pinch the battery holder clip together then pull the tab to remove the battery holder.
2. Insert the battery with the + facing in the same direction as the + on the battery holder.
3. Replace the battery holder with battery into the Remote Control unit making sure that it is fully inserted.

#### NOTES

- Replace Remote Control unit battery with 3V micro lithium cells such as CR. 2025 or its equivalent.
- Dispose of battery safely in accordance with local laws. Do not dispose of in fire.

**Warning:** The battery used in this device may present a fire or chemical burn hazard if mistreated. Do not recharge, disassemble, incinerate, or heat above 100 °C (212 °F). Replace the battery with Matsushita Elec. Ind. Co., Ltd. (Panasonic), part no. CR. 2025 only. Use of another battery may present a risk of fire or explosion. Dispose of used batteries. Keep batteries away from children. Do not disassemble or dispose of in fire.

## Power Connections

### Connect the AC adapter.

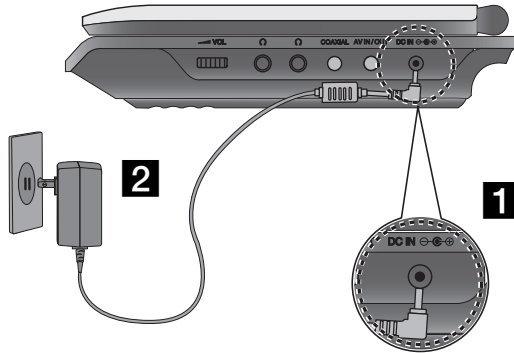

**1** Connect the AC Adapter to the DC IN  jack on the unit.

**2** Connect the AC adapter to the wall outlet.

### Caution

- Do not connect the power plug to a power outlet other than that indicated on the label, as this can result in a risk of fire or electric shock.
- Do not connect or disconnect the power plug with wet hands. Doing so may cause electric shock.
- Do not use an AC adapter other than one specified, as it can cause a fire or damage to the player.

### AC adapter

- This AC adapter operates on 100-120V~ 27W 50/60Hz.
- Contact an electrical parts distributor for assistance in selecting a suitable AC plug adapter or AC cord set.
- Manufactured by WANLIDA Digital Technology Co., Ltd.

## Power Connections (Continued)

### Connect the Automotive adapter

This unit and its automotive adapter are designed for use in vehicles that have 8.5-16 volt, negative ground electrical systems. (This is standard for most vehicles.) If your vehicle has a different type of electrical system, the DC power system cannot be used.

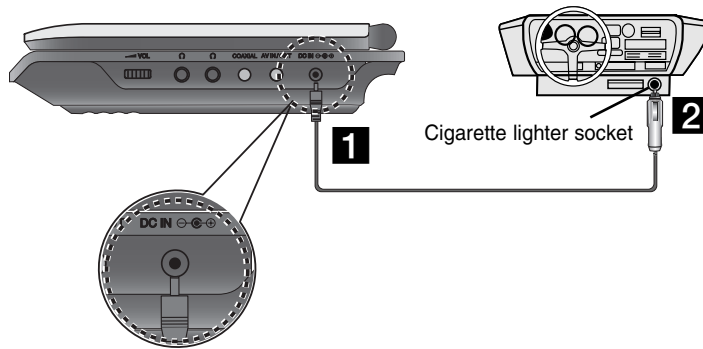

- 1.** Connect the automotive adapter to the DC IN  $\ominus$   $\oplus$  jack on the unit.
- 2.** Connect the automotive adapter to the car's cigarette lighter socket.

### Caution

- To prevent electrical shock and possible damage to your unit or vehicle, always unplug the automotive adapter from the cigarette lighter socket before you remove the plug from your unit.
- A 3 amp, 250V fuse for protection is installed in the automotive adapter.
- While the engine is being started, disconnect the automotive adapter from the car's cigarette lighter socket.
- Do not operate your unit when the car battery is discharged. Peak current from the car generator may cause the DC fuse to blow.
- If the vehicle's supply voltage drops below approximately 10 volts, your unit may not work properly.
- Do not leave your unit in a place where the temperature exceeds 70°C (158°F), or the pick-up device may be damaged.

Examples include:

- Inside a car with the windows closed and in direct sunshine.
- Near a heating appliance.

### Automotive adapter

- This automotive adapter operates on DC 8.5-16V.
- Contact an electrical parts distributor for assistance in selecting a suitable automotive adapter.
- Manufactured by WANLIDA Digital Technology Co., Ltd.

## Power Connections (Continued)

### Battery Pack

Charge the battery pack before using it for the first time.

#### ■ Attaching the battery pack

- 1** Match the hooks of the battery pack into the holes on the bottom of the player.
- 2** Press and slide the battery pack until the hooks click.

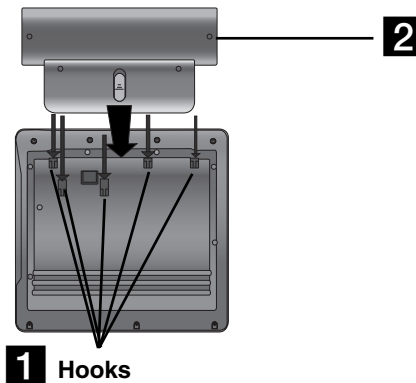

#### NOTES

- Do not detach the battery pack during playback.
- Be careful not to drop the battery pack.

#### ■ Detaching the battery pack

- 1** Press the PUSH knob.
- 2** Pull the battery pack until the hooks click.

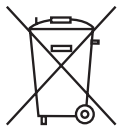
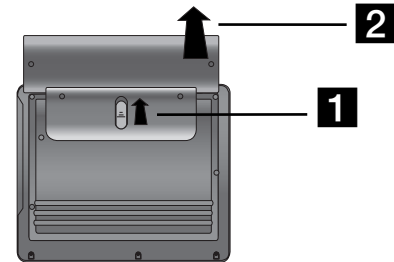

#### ATTENTION

The product that you have purchased contains a rechargeable battery. The battery is recyclable. At the end of its useful life, under various state and local laws, it may be illegal to dispose of this battery into the municipal waste stream. Check with your local solid waste/officials for details in your area for recycling options or proper disposal.

## Power Connections (Continued)

### ■ Charging the battery pack

1. Attach the battery pack to the player.
2. Connect the AC power adapter to the player and the plug into an AC outlet.

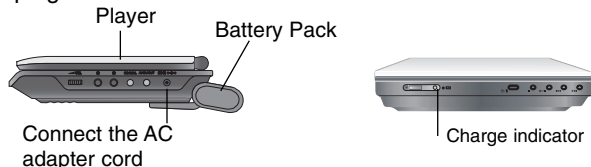

3. During recharging, charge indicator is red. If recharging is complete, charge indicator changes to green color.

### CAUTION

Take the following precautions to avoid liquid leakage, overheating, etc.

- Do not use any unauthorized parts.
- Use the authorized AC adapter when recharging battery.
- Do not expose to high temperature above 60°C (140°F).
- Do not attempt to dismantle or modify the unit.
- Excessive impact may cause the unit to malfunction.
- Do not incinerate.
- Do not disassemble; dispose of properly.
- Do not short-circuit.

### NOTE

Charging a battery only happens when the power is off.

The battery will not be charged when it is naturally or purposely discharged. Because the unit cannot perceive battery voltage, even if you attached the battery.

When you are in this situation, power on the unit and then power off again. Then battery charge will proceed.

### ■ Recharging and play times

Recharging without Playback	Play time	
	LCD On	LCD Off
Approx. 3 hour	Approx. 3.5 hours*	Approx. 4 hours

- \* When Brightness control is set to initial mode.  
- using the headphones and volume center.

### ■ Press “Display” to display the battery status on the screen.



If using the AC adapter, battery display does not appear.

If the battery capacity is not enough, “Check Battery Status”

or “” is displayed on the screen and then the power is automatically turned off after a few minute.

### ■ If play time dramatically reduces after recharging

The battery pack has reached the end of its service life (it can be recharged about 300 times).

### ■ If the unit is not used for a long time

- Detach the battery pack. (Even if the unit is off, it still uses some power. This can lead to over discharging of the battery and malfunction.)
- Recharge the battery pack when you are ready to use it again.



## Rotating the LCD

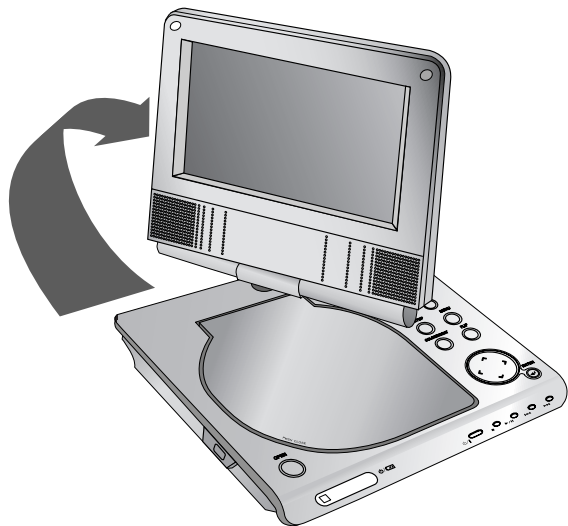

You can rotate the LCD clockwise 180 degrees, however, if you turn it by force, it can cause serious damage.



After rotating LCD completely, you can fold the LCD screen as shown above.

## Playing a Disc

1. Prepare the power supply.
2. Open the outer cover and press **POWER** button.
3. Press **OPEN** to open the disc lid and insert a disc with the side you want to play label up. Close the disc lid by hand.
  - If the disc is placed in upside down (and it is a single-sided disc), "CHECK DISC" or "DISC ERROR" appears on the screen.
  - After playing back all of the chapters in the title, the unit automatically stops and returns to the menu screen.
4. Press **PLAY**(▶) to playback.
5. Adjust the volume.

### NOTES

- Place a disc with the playback side down on the spindle, and push gently on the center of the disc so it goes into position.
- If you are not using the LCD on this unit, select OFF to conserve power.
- The LCD is turned off if you close the unit.
- The picture shown on the LCD depends on the display mode and the size recorded on the disc.

### ■ Changing the size of the picture

Use the LCD MODE button to change the picture mode.  
The mode is shown on the unit's display as follows.

NORMAL → 4:3 mode → OFF



### NOTE

May appear to differ according to kind of disc.

## Select a MODE

Selects a mode among DISC, AV IN or USB.

1. Press MODE button on the unit.  
The mode selection menu appears on the screen.



2. Use ◀ / ▶ to select the mode then press ENTER.
  - DISC: The disc menu or playback picture for the disc appears on the screen .
  - AV IN: A picture from external device appears on the screen.
  - USB: A file or folder list in USB Flash Drive appears on the screen.

## On-Screen Display

### Displaying Disc Information on-screen

You can display various information about the disc loaded on-screen.

1. Press DISPLAY to show various playback information. The items displayed differ depending on the disc type or playing status.



2. You can select an item by pressing ▲ / ▼ and change or select the setting by pressing ◀ / ▶.
  - Title (Track) – Current title (or track). number/total number of titles (or tracks).
  - Chapter – Current chapter number/total number of chapters.
  - Time – Elapsed playing time.
  - Audio – Selected audio language or channel.
  - Subtitle – Selected subtitle.
  - Angle – Selected angle/total number of angles.

#### NOTE

If no button is pressed for a few seconds, the on-screen display disappears.

### Initial Settings

By using the Setup menu, you can make various adjustments to items such as picture and sound. You can also set a language for the subtitles and the Setup menu, among other things. For details on each Setup menu item, see pages 20 to 24.

#### To display and exit the Menu:

Press SETUP to display the menu. A second press of SETUP will take you back to initial screen.

#### To go to the next level:

Press ▶ on the Remote Control.

#### To go back to the previous level:

Press ◀ on the Remote Control.

### General Operation

1. Press SETUP. The Setup menu appears.
2. Use ▲ / ▼ to select the desired option then press ▶ to move to the second level. The screen shows the current setting for the selected item, as well as alternate setting(s).
3. Use ▲ / ▼ to select the second desired option then press ▶ to move to the third level.
4. Use ▲ / ▼ to select the desired setting then press ENTER to confirm your selection. Some items require additional steps.
5. Press SETUP or PLAY(▶) to exit the Setup menu.

## Initial Settings

### LANGUAGE

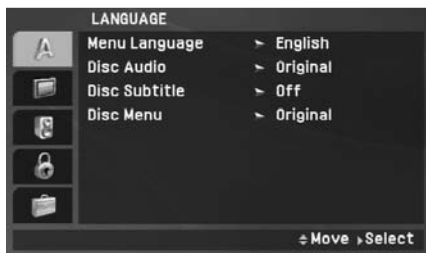

#### Menu Language

Select a language for the Setup menu and on-screen display.

#### Disc Audio / Subtitle / Menu

Select the language you prefer for the audio track (disc audio), subtitles and the disc menu.

**Original:** Refers to the original language in which the disc was recorded.

**Other:** To select another language, press numeric buttons and then ENTER to enter the corresponding 4-digit number according to the language code list on the page 39. If you enter the wrong language code, press CLEAR.

**Off (for Disc Subtitle)** – Turn off Subtitle.

### DISPLAY



#### TV Aspect

**4:3:** Select when a standard 4:3 TV is connected.

**16:9:** Select when a 16:9 TV is connected.

#### NOTE

If the TV Aspect option is set to 16:9, the Display Mode setting is automatically set to Widescreen.

#### Display Mode

Display Mode setting works only when the TV Aspect mode is set to "4:3".

**LetterBox:** Displays a wide picture with bands on the upper and lower portions of the screen.

**Panscan:** Automatically displays the wide picture on the entire screen and cuts off the portions that do not fit.

## Initial Settings (continued)

### AUDIO

Each DVD disc has a variety of audio output options. Set the player's AUDIO options according to the type of audio system you use.



#### Dolby Digital / DTS / MPEG

**Bitstream:** Select “Bitstream” if you connect the unit's DIGITAL OUT jack to an amplifier or other equipment with a Dolby Digital, DTS or MPEG decoder.

**PCM (for Dolby Digital / MPEG):** Select when connected to a two-channel digital stereo amplifier. DVDs encoded in Dolby Digital or MPEG will be automatically downmixed to two-channel PCM audio.

**Off (for DTS):** If you select “Off”, the DTS signal is not output through the DIGITAL OUT jack.

#### Sample Freq. (Frequency)

If your receiver or amplifier is NOT capable of handling 96 kHz signals, select 48 kHz. When this choice is made, this unit automatically converts any 96 kHz signals to 48 kHz so your system can decode them.

If your receiver or amplifier is capable of handling 96 kHz signals, select 96 kHz. When this choice is made, this unit passes each type of signal through without any further processing.

Check the documentation for your amplifier to verify its capabilities.

#### DRC (Dynamic Range Control)

With the DVD format, you can hear a program's soundtrack in the most accurate and realistic presentation possible, thanks to digital audio technology. However, you may wish to compress the dynamic range of the audio output (the difference between the loudest sounds and the quietest ones). This allows you to listen to a movie at a lower volume without losing clarity of sound. Set DRC to On for this effect.

#### Vocal

Set to On only when a multi-channel karaoke DVD is playing. The karaoke channels on the disc mix into normal stereo sound.

## Initial Settings (continued)

### LOCK (Parental Control)



#### Rating

Blocks playback of rated DVDs based on their content. Not all discs are rated.

1. Select “Rating” on the LOCK menu then press ►.
2. To access the Rating, Password and Area Code features, you must input the 4-digit password you created. If you have not yet entered a password you are prompted to do so.  
Input a 4-digit code and press ENTER. Enter it again and press ENTER to verify. If you make a mistake before pressing ENTER, press CLEAR.

3. Select a rating from 1 to 8 using the ▲ / ▼ buttons.

**Rating 1-8:** Rating one (1) has the most restrictions and rating eight (8) is the least restrictive.

**Unlock:** If you select unlock, parental control is not active and the disc plays in full.

#### **NOTE**

If you set a rating for the unit, all disc scenes with the same rating or lower are played. Higher rated scenes are not played unless an alternate scene is available on the disc. The alternative must have the same rating or a lower one. If no suitable alternative is found, playback stops. You must enter the 4-digit password or change the rating level in order to play the disc.

4. Press ENTER to confirm your rating selection, then press SETUP to exit the menu.

## Initial Settings (continued)

### Password

You can enter or change password.

1. Select Password on the LOCK menu then press ►.
2. **To make a new password:**  
Press ENTER when the “New” option is highlighted. Enter a new password using the numbered buttons then press ENTER. Enter the password again to verify.  
**To change the password:**  
Press ENTER when the “Change” option is highlighted. Enter a current password using the numbered buttons then press ENTER. Enter a new password using the numbered buttons then press ENTER. Enter the password again to verify.
3. Press SETUP to exit the menu.

### *If you forget your password*

If you forget your password, you can clear it using the following steps:

1. Press SETUP to display the Setup menu.
2. Input the 6-digit number “210499” and the password is cleared.

### Area Code

Enter the code of the area whose standards were used to rate the DVD video disc, based on the list on page 40.

1. Select “Area Code” on the LOCK menu then press ►.
2. Follow step 2 as shown previous page (Rating).
3. Select the first character using ▲ / ▼ buttons.
4. Press ENTER and select the second character using ▲ / ▼ buttons.
5. Press ENTER to confirm your area code selection.

## Initial Settings (continued)

### OTHERS

The B.L.E settings can be changed.



#### **B.L.E. (Black Level Expansion)**

To select the black level of playback pictures. Set your preference and monitor's ability.

**On:** Expanded grey scale. (0 IRE cut off)

**Off:** Standard grey scale. (7.5 IRE cut off)



## General Features

### If a menu screen is displayed

#### DVD

Use the ◀▶▲▼ buttons to select the title/chapter you want to view, then press ENTER to start. Press TITLE or MENU to return to the menu screen.

#### NOTES

- If parental control is set and the disc is not within the rating settings you must input the password.  
(See “LOCK Menu” on page 22-23.)
- DVDs may have a region code. Your unit does not play discs that have a region code different from your unit.

**Unless stated otherwise, all operations described use the Remote Control. Some features may also be available on the Setup menu.**

#### Resume Play **ALL**

When play is stopped, the unit records the point where STOP was pressed (RESUME function).

Press PLAY(▶) and play will resume from this point.

#### Moving to another TITLE **DVD**

When a disc has more than one title, you can move to another title. Press DISPLAY during playback or resume play then the appropriate number (0-9) or use ◀/▶ to move to another title.

#### Moving to another CHAPTER/TRACK **ALL**

During playback, press SKIP/SEARCH (I◀◀ or ▶▶I) to go to the next chapter/track or to return to the beginning of the current chapter/track.

Press SKIP I◀◀ twice briefly to step back to the previous chapter/track.

#### Search **ALL**

1. Press and hold SKIP/SEARCH (I◀◀ or ▶▶I) for about two seconds during playback.  
The player will now go into SEARCH mode.
2. Press and hold SKIP/SEARCH (I◀◀ or ▶▶I) repeatedly to select the required speed.  
DVD disc: 4 steps  
MP3, WMA, Audio CD: 3 steps
3. To exit SEARCH mode, press PLAY(▶).

#### Slow Motion **DVD**

1. Press SLOW (◀I or I▶) during playback.  
The player will enter Slow mode.  
DVD disc: 4 steps
2. To exit slow motion mode, press PLAY(▶).

## General Features (Continued)

### Still Picture and Frame-by-Frame Playback

#### ALL

During playback, press PAUSE/STEP(III) to pause playback.

#### DVD

Press PAUSE/STEP(III) repeatedly to play Frame-by-Frame.  
( Remote Control Only )

To exit still motion mode, press PLAY(▶).

### Time Search **DVD**

To start playing at any chosen time on the disc:

1. Press DISPLAY during playback. The time search box shows the elapsed playing time.
2. Use ▲ / ▼ to select the time search box and “-:--:--” appears.
3. Input the required start time in hours, minutes, and seconds from left to right. If you enter the wrong numbers, press CLEAR to remove the numbers you entered, then input the correct numbers.
4. Press ENTER to confirm. Playback starts from the selected time.

### Repeat A-B **DVD** **ACD**

During playback, each press of A-B button to select point A and point B and repeats a sequence from point A (Starting point) to point B (End point).

Press A-B again to cancel.

### Repeat **ALL**

During playback, press REPEAT repeatedly to select a desired repeat mode.

DVD Video Discs: Chapter/Title/Off

Audio CD, MP3/WMA discs: Track/All/Off

#### NOTES

If you press SKIP (▶▶) once during Repeat Chapter (Track) playback, the repeat playback cancels.

### Zoom **DVD**

During watching pictures, press ZOOM to enlarge the video image (3 steps).

You can move through the zoomed picture using ◀ ▶ ▲ ▼ buttons. Press CLEAR to exit.

#### NOTES

Zoom may not work on some DVDs.

## General Features (Continued)

### Title Menu **DVD**

If the current DVD title has a menu, the title menu appears on the screen. Otherwise, the disc menu appears.

### Disc Menu **DVD**

Press MENU and the disc menu is displayed. Press MENU again to exit.

### Changing the Audio Language **DVD**

Press AUDIO repeatedly during playback to hear a different audio language or encoding method.

With DVD-RW discs recorded in VR mode that have both a main and a Bilingual audio channel, you can switch between Main (L), Bilingual (R), or a mix of both (Main + Bilingual) by pressing AUDIO.

### Camera Angle **DVD**

During playback of DVD disc contains scenes recorded different camera angles, press ANGLE repeatedly to select a desired angle.

#### **TIP**

The angle indicator will blink on the screen during scenes recorded at different angles as an indication that angle switching is possible.

### Subtitles **DVD**

Press SUBTITLE repeatedly during playback to see the different subtitle languages.

## Additional features

### Marker Search **DVD**

#### To enter a Marker

You can start playback from up to nine memorized points. To enter a marker, press **MARKER** at the desired point on the disc. The Marker icon appears on the TV screen briefly. Repeat to enter up to nine markers.

#### To Recall or Clear a Marked Scene

1. During disc playback, press **SEARCH**. The marker search menu appears on the screen.
2. Within 9 seconds, press **◀ / ▶** to select a marker number that you want to recall or clear.
3. Press **ENTER** and playback starts from the marked scene. Or, Press **CLEAR** and the marker number is erased from the list.
4. You can play any marker by inputting its number on the marker search menu.

#### **NOTES**

- Some subtitles recorded around the marker may fail to appear (DVD).
- All the markers are cleared when the power is turned off or the disc is removed.
- The marker is not stored when the DVD or title menu is displayed on the screen.

### Last Scene Memory **DVD** **ACD**

This unit memorizes last scene from the last disc that is viewed. The last scene remains in memory even if you remove the disc from the unit or switch off the unit. If you load a disc that has the scene memorized, the scene is automatically recalled.

#### **NOTES**

This unit does not memorize the scene of a disc if you switch off the unit before commencing to play the disc.

### Screen Saver/Auto Power Off

The screen saver appears when you leave the unit in Stop mode for about five minutes. If the Screen Saver is displayed for five minutes, the unit automatically turns itself off.

## Playing an Audio CD or MP3/WMA file

This unit can play Audio CDs or MP3/WMA files.

### MP3/ WMA/ Audio CD

Once you insert an MP3/WMA files recorded media or Audio CD, a menu appears on the TV screen.

Press ▲ / ▼ to select a track/file then press PLAY(▶) or ENTER and playback starts. You can use variable playback functions.

Refer to page 25-26.



### ID3 TAG

- When playing a file containing information such as track titles, you can see the information by pressing DISPLAY.  
[ Title, Artist, Album, Year, Comment ]
- If there is no information, “NO ID3 TAG” appears on the display.

### TIPS

- If you are in a file list on the MUSIC menu and want to return to the Folder list, use the ▲ / ▼ to highlight  and press ENTER.
- Press MENU to move to the next page.
- On a CD with MP3/WMA and JPEG file, you can switch MUSIC and PHOTO menu. Press TITLE and MUSIC and PHOTO word on top of the menu is highlighted.

**MP3 / WMA file compatibility with this unit is limited as follows:**

- Sampling frequency: within 8 - 48 kHz (MP3), within 32 - 48kHz (WMA)
- Bit rate: within 8 - 320kbps (MP3), 32 - 192kbps (WMA)
- The unit cannot read an MP3/WMA file that has a file extension other than “.mp3” / “.wma”.
- CD-R physical format should be ISO 9660
- If you record MP3 / WMA files using software that cannot create a file system (eg. Direct-CD) it is impossible to playback MP3 / WMA files. We recommend that you use Easy-CD Creator, which creates an ISO 9660 file system.
- File names should have a maximum of 16 letters and must incorporate an .mp3 or .wma extension.
- They should not contain special letters such as / ? \* : “ < > | etc.
- The total number of files on the disc should be less than 650.
- This unit requires discs and recordings to meet certain technical standards in order to achieve optimal playback quality. Pre-recorded DVDs are automatically set to these standards. There are many different types of recordable disc formats (including CD-R containing MP3 or WMA files) and these require certain pre-existing conditions (see above) to ensure compatible playback.

## Programmed Playback

The program function enables you to store your favorite tracks from any disc in the player memory.

A program can contain 30 tracks.

1. Insert an Audio CD or MP3/WMA files recorded media. AUDIO CD or MUSIC menu appears.
2. Press PROG. The  mark will appear



### NOTE

Press PROG. again, then the  mark will disappear to exit the Program Edit mode.



Audio CD Menu

MP3/WMA Menu

3. Select a track on the "List", then press ENTER to place the selected track on the "Program" list. Repeat to place additional tracks on the list.
4. Press .  
Select the track you want to start playing on the "Program" list.
5. Press PLAY() or ENTER to start. Playback begins in the order in which you programmed the tracks. Playback stops after all of the tracks on the "Program" list have played once.
6. To resume normal playback from programmed playback, select a track of AUDIO CD (or MUSIC) list and then press PLAY().

## Repeat Programmed Tracks





Press REPEAT to select a desired repeat mode.

- Track: repeats the current track
- All: repeats all the tracks on programmed list.
- Off(No display): does not play repeatedly.





### NOTE

If you press  once during Repeat Track playback, the repeat playback cancels.

## Erasing a Track from Program List

1. Press PROG. and the  mark will appear
2. Use     to select the track that you wish to erase from the Program list.
3. Press CLEAR. Repeat step 1-3 to erase additional tracks on the program list.

## Erasing the Complete Program List

1. Press PROG. and the  mark will appear
2. Use     to select "Clear All", then press ENTER.

### NOTE

The programs are also cleared when the power is off or the disc is removed.

## Viewing a JPEG file

This unit can play JPEG files.

1. Insert a JPEG files recorded media. The PHOTO menu appears on the TV screen.



2. Press ▲ / ▼ to select a folder, and press ENTER. A list of files in the folder appears. If you are in a file list and want to return to the previous Folder list, use the ▲ / ▼ buttons on the remote to highlight and press ENTER.
3. If you want to view a particular file, press ▲ / ▼ to highlight a file and press ENTER or PLAY().
4. While viewing a file, you can press STOP() to move to the previous menu (PHOTO menu).

### TIPS

- Press MENU to move to the next page.
- There are three Slide Speed options : >>> (Fast), >> (Normal) and > (Slow). Use ▲ ▼ ◀ ▶ to highlight the . Then, use ◀ / ▶ to select the option you want to use.
- On a CD with MP3/WMA and JPEG file, you can switch MUSIC and PHOTO menu. Press TITLE and MUSIC and PHOTO word on top of the menu is highlighted.
- While watching a picture, press RETURN () to hide the help menu.

### Slide Show

Use ▲ ▼ ◀ ▶ to highlight the (Slide Show) then press ENTER.

### Still Picture

1. Press PAUSE/STEP() during slide show. The unit will now go into pause mode.
2. To return to the slide show, press PLAY() or press PAUSE/STEP() again.

## Viewing a JPEG file (Continued)

### Moving to another file

Press SKIP/SEARCH (◀◀ or ▶▶) or cursor (◀ or ▶) once while viewing a picture to advance to the next or previous file.

### Zoom

During watching pictures, press ZOOM to enlarge the image (3 steps).

You can move through the zoomed picture using ◀ ▶ ▲ ▼ buttons. Press CLEAR to exit.

### To rotate picture

Press ▲ / ▼ during showing a picture to rotate the picture clockwise or counter clockwise.

### To listen to MP3/WMA music while watching picture

1. Insert the disc containing the two types of file in the unit.
2. Press TITLE to display PHOTO menu.
3. Press ▲ / ▼ to select a photo file.
4. Use ▶ to select  icon then press ENTER. Playback starts.
5. While viewing a file, you can press STOP(■) to move to the previous menu (PHOTO menu).

### TIP

To listen to only the desired music while watching picture, programmed the desired files from the “MUSIC” menu and then proceed as above.

### JPEG disc compatibility with this unit is limited as follows:

- Depending upon the size and number of JPEG files, it could take a long time for the unit to read the disc's contents. If you don't see an on-screen display after several minutes, some of the files may be too large — reduce the resolution of the JPEG files to less than 2M pixels as 2760 x 2048 pixels and burn another disc.
- The total number of files and folders on the disc should be less than 650.
- Some discs may be incompatible due to a different recording format or the condition of disc.
- Ensure that all the selected files have the “.jpg” extensions when copying into the CD layout.
- If the files have “.jpe” or “.jpeg” extensions, please rename them as “.jpg” file.
- File names without “.jpg” extension will not be able to be read by this unit. Even though the files are shown as JPEG image files in Windows Explorer.



## Playing a DVD VR format Disc

This unit will play DVD-RW discs recorded using the Video Recording (VR) format.

1. Insert a disc and close the tray. The DVD-VR menu appears on the screen.

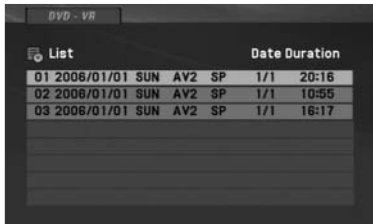

2. Press ▲ / ▼ to select a track then press PLAY(▶) or ENTER and playback starts.
3. Press MENU to move to the list menu.

### NOTES

- This unit will play DVD-R/RW disc that is recorded using the DVD-Video format that have been finalized using a DVD-recorder. Unfinalized DVD-R/RW discs cannot be played in this unit.
- Some DVD-VR disc are made with CPRM data by DVD RECORDER. Player does not support these kinds of discs.

#### What is 'CPRM'?

CPRM is a copy protection system (with scramble system) only allowing the recording of 'copy once' broadcast programs. CPRM stands for Content Protection for Recordable Media.

## Playing an USB Flash Drive

This unit can play JPEG or MP3/WMA files.

1. Connect the USB Flash Drive to the USB port on the unit after power is on.
2. Press MODE on the unit.  
The mode selection menu appears on the screen.



3. Select the USB using ◀ / ▶ buttons and press ENTER.  
The file or folder list in USB Flash Drive appears on the screen.
4. If you want to change the other mode, select the other mode in mode selection menu.

### To Remove the USB Flash Drive from the unit

1. Follow step 4 as shown above, to exit the menu.
2. Remove the USB Flash Drive from the unit.

### NOTES

- Do not extract the USB Flash Drive in operating.
- Music files (MP3/WMA) and image files (JPEG) can be played.
- The total number of files in a USB Flash Drive should be less than 650 files.
- Some USB Flash Drive is not supported on this unit.
- This unit supports only USB Flash Drive.
- This unit can support USB1.1.

**For details on each operations item,  
refer to relevant page. (See pages 25-33)**

## Setting up the Player

The picture and sound of a nearby TV, VCR, or radio may be distorted during playback. If this occurs, position the player away from the TV, VCR, or radio, or turn off the unit after removing the disc.

### AV output Connections

Depending on your TV and other equipment there are various ways you can connect the unit. Please refer to the manuals of your TV, stereo system or other devices as necessary for additional connection information.

#### AV output Connections to Your TV

1. Set the Mode selection menu to "USB" or "DISC" mode.
2. Connect the black end of supplied AV cable to the AV IN/OUT jack on the unit.
3. Connect the yellow end of supplied AV cable to the VIDEO Input jack on your TV.
4. Connect the red and white ends of supplied AV cable to the AUDIO Input jacks on your TV.

#### NOTE

Make sure the DVD player is connected directly to the TV and not to a VCR, otherwise the DVD image could be distorted by the copy protection system.

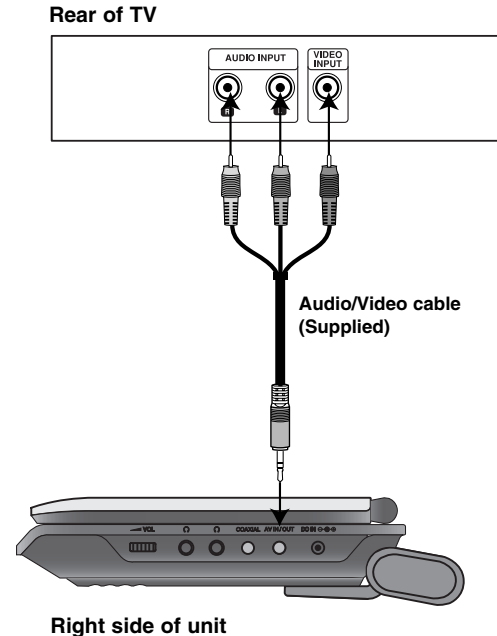

## Setting up the Player (Continued)

### AV input Connections

Connect the input jacks (Audio/Video) on the unit to the audio/video out jacks on your external device, using audio/video cables.

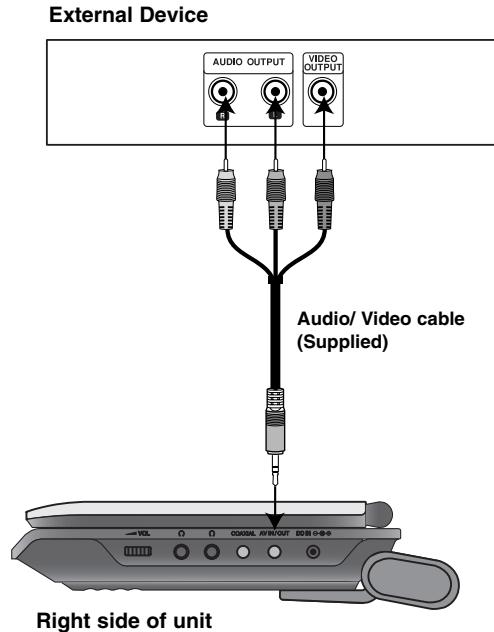

### AV input Connections to Your unit

1. Set the Mode selection menu to "AV IN" mode.
2. Connect the black end of supplied AV cable to the AV IN/OUT jack on the unit.
3. Connect the yellow end of supplied AV cable to the VIDEO Output jack on your external device.
4. Connect the red and white ends of supplied AV cable to the AUDIO Output jacks on your external device.

## Setting up the Player (Continued)

### Audio Connection to Optional Equipment

Connect the unit to your optional equipment for audio output. You must set the Mode selection menu to “USB” or “DISC” mode.

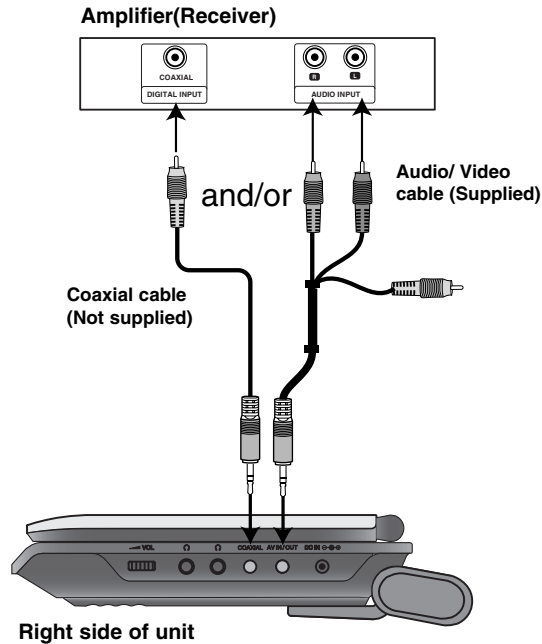

**Amplifier equipped with 2-channel analog stereo or Dolby Pro Logic II / Pro Logic:** Connect the AV IN/OUT jacks on the unit to the audio left and right IN jacks on your amplifier, receiver, or stereo system, using the audio cables.

**Amplifier equipped with 2-channel digital stereo (PCM) or audio / video receiver equipped with a multi-channel decoder (Dolby Digital™, MPEG 2, or DTS):** Connect one of the unit Coaxial jack to the corresponding jack on your amplifier. Use an optional digital audio cable.

### Digital Multi-channel sound

A digital multi-channel connection provides the best sound quality. For this you need a multi-channel audio / video receiver that supports one or more of the audio formats supported by your unit such as MPEG 2, Dolby Digital and DTS. Check the receiver manual and the logos on the front of the receiver.

### NOTES

- If the audio format of the digital output does not match the capabilities of your receiver, the receiver produces a strong, distorted sound or no sound at all.
- Six Channel Digital Surround Sound via a digital connection can only be obtained if your receiver is equipped with a Digital Multi-channel decoder.
- To see the audio format of the current DVD in the on-screen display, press AUDIO.

## Troubleshooting

Symptom	Cause	Correction
No power.	• The power cord is disconnected.	• Plug the power cord into the wall outlet securely.
	• The battery is discharged.	• Recharge the battery.
No picture on the LCD or TV (including video from another unit).	• The video cable is not connected securely.	• Connect the video cable into the jacks securely.
	• The MODE selection is not set correctly.	• Set the MODE correctly. While you are viewing video from other equipment, set the MODE to A/V IN mode.
	• LCD mode is set to OFF.	• Select a LCD mode other than OFF.
	• The TV is not set to receive DVD signal output.	• Select the appropriate video input mode on the TV so the picture from the unit appears on the screen.
No sound.	• The equipment connected with the audio cable is not set to receive DVD signal output.	• Select the correct input mode of the audio receiver so you can listen to the sound from the unit.
	• The audio cables are not connected securely.	• Connect the audio cable into the jacks securely.
The unit does not start playback.	• An unplayable disc is inserted.	• Insert a playable disc. (Check the disc type and Regional code.)
	• The Rating level is set.	• Cancel the Rating function or change the rating level.
No response when buttons are pressed.	• Some discs prohibit certain operations.	• “⊗” may appear on the screen during operation.
The Remote Control does not work properly.	• The Remote Control is too far from the unit.	• Operate the Remote Control within about 23 ft (7 m).

## Language Codes

Use this list to input your desired language for the following initial settings:  
Disc Audio, Disc Subtitle, Disc Menu.

Language	Code	Language	Code	Language	Code	Language	Code
Abkhazian	6566	Fiji	7074	Lingala	7678	Singhalese	8373
Afar	6565	Finnish	7073	Lithuanian	7684	Slovak	8375
Afrikaans	6570	French	7082	Macedonian	7775	Slovenian	8376
Albanian	8381	Frisian	7089	Malagasy	7771	Somali	8379
Ameharic	6577	Galician	7176	Malay	7783	Spanish	6983
Arabic	6582	Georgian	7565	Malayalam	7776	Sudanese	8385
Armenian	7289	German	6869	Maltese	7784	Swahili	8387
Assamese	6583	Greek	6976	Maori	7773	Swedish	8386
Aymara	6588	Greenlandic	7576	Marathi	7782	Tagalog	8476
Azerbaijani	6590	Guarani	7178	Moldavian	7779	Tajik	8471
Bashkir	6665	Gujarati	7185	Mongolian	7778	Tamil	8465
Basque	6985	Hausa	7265	Nauru	7865	Tatar	8484
Bengali; Bangla	6678	Hebrew	7387	Nepali	7869	Telugu	8469
Bhutani	6890	Hindi	7273	Norwegian	7879	Thai	8472
Bihari	6672	Hungarian	7285	Oriya	7982	Tibetan	6679
Breton	6682	Icelandic	7383	Panjabi	8065	Tigrinya	8473
Bulgarian	6671	Indonesian	7378	Pashto, Pushto	8083	Tonga	8479
Burmese	7789	Interlingua	7365	Persian	7065	Turkish	8482
Byelorussian	6669	Irish	7165	Polish	8076	Turkmen	8475
Cambodian	7577	Italian	7384	Portuguese	8084	Twi	8487
Catalan	6765	Japanese	7465	Quechua	8185	Ukrainian	8575
Chinese	9072	Javanese	7487	Rhaeto-Romance	8277	Urdu	8582
Corsican	6779	Kannada	7578	Rumanian	8279	Uzbek	8590
Croatian	7282	Kashmiri	7583	Russian	8285	Vietnamese	8673
Czech	6783	Kazakh	7575	Samoan	8377	Volapük	8679
Danish	6865	Kirghiz	7589	Sanskrit	8365	Welsh	6789
Dutch	7876	Korean	7579	Scots Gaelic	7168	Wolof	8779
English	6978	Kurdish	7585	Serbian	8382	Xhosa	8872
Esperanto	6979	Laothian	7679	Serbo-Croatian	8372	Yiddish	7473
Estonian	6984	Latin	7665	Shona	8378	Yoruba	8979
Faroese	7079	Latvian, Lettish	7686	Sindhi	8368	Zulu	9085

## Area Codes

Choose an area code from this list.

Area	Code	Area	Code	Area	Code	Area	Code
Afghanistan	AF	Ethiopia	ET	Malaysia	MY	Saudi Arabia	SA
Argentina	AR	Fiji	FJ	Maldives	MV	Senegal	SN
Australia	AU	Finland	FI	Mexico	MX	Singapore	SG
Austria	AT	France	FR	Monaco	MC	Slovak Republic	SK
Belgium	BE	Germany	DE	Mongolia	MN	Slovenia	SI
Bhutan	BT	Great Britain	GB	Morocco	MA	South Africa	ZA
Bolivia	BO	Greece	GR	Nepal	NP	South Korea	KR
Brazil	BR	Greenland	GL	Netherlands	NL	Spain	ES
Cambodia	KH	Herd and Mcdonald Islands	HM	Netherlands Antilles	AN	Sri Lanka	LK
Canada	CA	Hungary	HU	New Zealand	NZ	Sweden	SE
Chile	CL	India	IN	Nigeria	NG	Switzerland	CH
China	CN	Indonesia	ID	Norway	NO	Thailand	TH
Colombia	CO	Israel	IL	Oman	OM	Turkey	TR
Congo	CG	Italy	IT	Pakistan	PK	Uganda	UG
Costa Rica	CR	Jamaica	JM	Panama	PA	Ukraine	UA
Croatia	HR	Japan	JP	Paraguay	PY	United States	US
Czech Republic	CZ	Kenya	KE	Philippines	PH	Uruguay	UY
Denmark	DK	Kuwait	KW	Poland	PL	Uzbekistan	UZ
Ecuador	EC	Libya	LY	Portugal	PT	Vietnam	VN
Egypt	EG	Luxembourg	LU	Romania	RO	Zimbabwe	ZW
El Salvador	SV			Russian Federation	RU		



# Specifications

## General

### **Power supply:**

DC 9.5V (AC adapter terminal), DC 7.4V (Battery)

**Power consumption:** 12W with battery

**Net Weight:** 1.60 lbs (0.73 kg) (without battery pack)

### **External dimensions (W x H x D):**

7.6 x 1.5 x 6.7 inches (195 x 38.5 x 172.6 mm)

**Signal system:** NTSC

### **Laser:**

DVD Laser wavelength 662+25 / 662-15 nm

CD Laser wavelength 785+25 / 785-15 nm

### **Frequency range (audio):**

DVD linear sound: 48kHz sampling 8 Hz to 20 kHz  
96kHz sampling 8 Hz to 44 kHz

**Signal-to-noise ratio (audio):** More than 80 dB

**Dynamic range (audio):** More than 80 dB

**Harmonic distortion (audio):** 0.02 %

### **Operating conditions:**

Temperature: 5°C to 35°C, Operation status: Horizontal

## Connectors

### **Video input/output (VIDEO In/Out):**

1.0 V (p-p), 75 Ω, negative sync., ø3.5mm mini jack x 1

### **Audio input/output (AUDIO In/Out, analog audio):**

2.0 Vrms(1 KHz, 0 dB), ø3.5mm mini jack x 1

**Earphone terminal:** ø3.5mm stereo mini jack x 2

## Liquid Crystal Display

**Panel size:** 7 inches wide (diagonal)

**Projection system:** R.G.B. stripe

**Driving system:** TFT active matrix

**Resolution:** 234 x 480 x 3 (effective pixel rate: more than 99.99%)

## Accessories

- RCA Audio/Video cable .....1
- AC Adapter (DPAC1) .....1
- Automotive Adapter (DPDC1) .....1
- Battery Pack (DPB27) .....1
- Remote control.....1
- Battery for Remote control (Lithium Battery) .....1

Design and specifications are subject to change without notice.

Note



## LG Electronics, Inc. Limited Warranty - USA

This LG Electronics product, will be repaired or replaced, at LG's option, if it proves to be defective in material or workmanship, under normal use, during the warranty period ("Warranty Period") listed below, effective from the date ("Date of Purchase") of original consumer purchase of the product. This warranty is good only to the original purchaser of the product and effective only when used in the United States, excluding U.S. Territories.

### **WARRANTY PERIOD:**

**LABOR: 90 days** from the Date of Purchase.

**PARTS: One Year** from the Date of Purchase.

\* Parts replaced are warranted for the remaining portion of the original warranty period.

### **HOW SERVICE IS HANDLED:**

**Call 1-800-243-0000** for instructions on getting the defective unit repaired or replaced.

**Please retain dated sales receipt and your box** to return the unit to LG for repair or replacement.

Shipping both ways will be paid by LG during the first 90 days of the Warranty Period. During the remainder of the Warranty Period (91~365 days), you pay inbound shipping charges and LG pays return shipping charges.

Visit our website at: <http://www.lgservice.com>

**THIS WARRANTY IS IN LIEU OF ANY OTHER WARRANTIES, EXPRESS OR IMPLIED, INCLUDING WITHOUT LIMITATION, ANY WARRANTY OF MERCHANTABILITY OR FITNESS FOR A PARTICULAR PURPOSE. TO THE EXTENT ANY IMPLIED WARRANTY IS REQUIRED BY LAW, IT IS LIMITED IN DURATION TO THE EXPRESS WARRANTY PERIOD ABOVE. LG ELECTRONICS WILL NOT BE LIABLE FOR ANY INCIDENTAL, CONSEQUENTIAL, INDIRECT, SPECIAL OR PUNITIVE DAMAGES OF ANY NATURE, EVEN IF ADVISED OF THE POSSIBILITY OF SUCH DAMAGES, INCLUDING WITHOUT LIMITATION, LOST REVENUES OR PROFITS, LOST OR CORRUPTED PROGRAMMING OR DATA, OR ANY OTHER DAMAGE WHETHER BASED IN CONTRACT, TORT OR OTHERWISE.** Some states do not allow the exclusion or limitation of incidental or consequential damages or limitation on how long an implied warranty lasts, so the above exclusion or limitation may not apply to you. This warranty gives you specific legal rights and you may also have other rights that may vary from state to state.

**THIS LIMITED WARRANTY DOES NOT APPLY TO:**

- Damages or operating problems that result from shipping, installation, adjustment of user controls, calibration, maintenance or failure to maintain, or separate system components; and
- Damages or operating problems that result from normal wear and tear, misuse, abuse, operation outside environmental specifications or contrary to the requirements or precautions in the Operating Guide, accident, lightning strikes or other natural causes, unauthorized modification or alteration, incorrect electrical current or voltage, signal reception or input, software not licensed directly by LG, software errors that do not disable functionality, operating and software protocols adopted after the date of manufacture or for outside the US, institutional or commercial use, or other causes not arising out of defect in material or workmanship.

The cost of repair or replacement under these excluded circumstances shall be borne by the consumer.

**CUSTOMER INTER-ACTIVE CENTER NUMBERS:**

<b>For Warranty Service, Where to buy, Product Assistance, or Customer Assistance</b>	<b>Call 1-800-243-0000</b> (24 hours a day, 365 days per year) and select appropriate options from the menu.  Or visit our website at <a href="http://www.lgservice.com">http://www.lgservice.com</a>
---	---

LG ELECTRONICS U.S.A., INC.  
1000 SYLVAN AVENUE  
ENGLEWOOD CLIFFS, NJ

P/N : MFL37883904  
Printed in China  
Issue O

## Free Manuals Download Website

<http://myh66.com>

<http://usermanuals.us>

<http://www.somanuals.com>

<http://www.4manuals.cc>

<http://www.manual-lib.com>

<http://www.404manual.com>

<http://www.luxmanual.com>

<http://aubethermostatmanual.com>

Golf course search by state

<http://golfingnear.com>

Email search by domain

<http://emailbydomain.com>

Auto manuals search

<http://auto.somanuals.com>

TV manuals search

<http://tv.somanuals.com>