



ENGLISH

ESPAÑOL

INSTALLATION MANUAL ELECTRIC RANGE

Please read these instructions thoroughly before installing and operating the range.

LRE3025ST	LRE3023ST
LRE3025SB	LRE3023SB
LRE3025SW	LRE3023SW



MFL57205804



Printed on 100% Recycled Paper

www.lg.com

TABLE OF CONTENTS

3 SAFETY

- 3 Before You Begin
- 3 Important Safety Instructions
- 5 Prepare to Install the Range

6 PREPARE TO INSTALL RANGE

- 6 Installation Drawings

7 ELECTRICAL CONNECTIONS

- 7 Electrical Connection Requirements
- 7 Connect Range Cord
- 8 3-Wire Connection With a Power Supply Cord
- 9 4-Wire Connection With a Power Supply Cord
- 9 3-Wire Connection: Conduit
- 10 4-Wire Connection: Conduit

11 INSTALL THE RANGE

- 11 Anti-Tip Device Installation
- 11 Final Installation

BEFORE YOU BEGIN

Remove all tape and packing materials before using the range.

Dispose of all plastic bags after unpacking the range. Never allow children to play with packing materials.

You can download the installation and owner's manual at: <http://www.lg.com>.

IMPORTANT SAFETY INSTRUCTIONS

Read and follow all instructions before using your oven to prevent the risk of fire, electric shock, personal injury, or damage when using the range. This guide does not cover all possible conditions that may occur. For further assistance contact your service agent or manufacturer.



This is the safety alert symbol. This symbol alerts you to potential hazards that can cause personal injury to you and others. All safety messages will follow the safety alert symbol with either the word "WARNING" or "CAUTION."

WARNING

This symbol will alert you to hazards or unsafe practices which could cause serious bodily harm or death.

CAUTION

This symbol will alert you to hazards or unsafe practices which could cause bodily injury or property damage.

WARNING

- **The information in this manual should be followed exactly.**
 - A fire or electrical shock may result causing property damage, personal injury or death.
- **Do not step or sit on the oven door. Install the Anti-Tip Brackets supplied with the range.**
 - The range could be tipped and injury might result from spilled hot liquid, food, or the range itself.
 - If the range is pulled away from the wall for cleaning, service, or any other reason, ensure that the Anti-Tip device is properly reengaged when the range is pushed back against the wall.
 - Install the Anti-Tip Brackets.
 - A child or adult can be killed when the range is tipped.
 - 1) According to the Anti-Tip Bracket Template, install 2 Anti-Tip Brackets to the floor and wall.
 - Anti-Tips will fasten the range by holding the range's 2 legs of the rear side and the Anti-Tip Bracket Template lets you know proper locations of Anti-Tip Brackets easily.
 - 2) Engage the range to the Anti-Tip Brackets by putting the range's 2 legs into each Anti-Tip Bracket.
 - 3) Re-engage the Anti-Tip Brackets if you can move the range except for range's front direction.
 - 4) See installation instructions for details (refer to the page 11).
 - Failure to do so can result in death or serious burns to children or adults.
- **You should use two or more people to move and install range. (Excessive Weight Hazard)**
 - Failure to do so can result in back or other injury.
- **You never pull or push any handles of door to move and install range.**
 - Failure to do so can result in serious damage to the door of the range.
- **New branch-circuit installations (1996 NEC) for mobile homes, recreational vehicles, and installations where local codes do not allow grounding through the neutral wire require a 4-conductor UL listed range cord or 4 wire conduit connection.**

⚠ WARNING

- **Power supply cord and plug should not be modified. If it will not fit the outlet, have a proper outlet installed by a qualified electrician.**
- **Using an extension cord to connect the power is prohibited. The way to connect the power cord and plug directly is strongly recommended.**
- **Electrical ground is required on this appliance.**
- **You should make sure that the power cord is not pinched by the range or heavy objects.**
 - Failure to do so can result in serious burns or electrical shock.
- **You never remove the protection cover covering the rear of oven.**
 - Failure to do so can result in serious damage to power cord. The damage causes serious burns and electric shock.
- **The middle (neutral or ground) wire of a 3 wire power cord or a 3 wire conduit has to be connected to the middle post of the main terminal block. The remaining two wires of the power cord or conduit have to be connected to the outside posts of the main terminal connection block.**
 - Failure to do so can result in electrical shock, severe personal injury or death.
- **Only a 4-conductor power-supply cord kit rated 120/240 volts, 50 amperes and marked for use with ranges with closed-loop connectors or open-end spade lugs with upturned ends shall be used. The middle (neutral) wire of the power cord or 4-wire conduit has to be connected to the middle post of the main terminal block. The other two wires of the power cord or conduit have to be connected to the outside posts of the main terminal connection block. The 4th ground wire must be connected to the frame of the range with the ground screw.**
 - Failure to do so can result in electrical shock, severe personal injury or death.

⚠ CAUTION

- **You should put on gloves during the installation procedure.**
 - Failure to do so can result in bodily injury.
- **You should make sure that the wall covering, countertop and cabinets around the range can withstand the heat (up to 194°F) generated by the range.**
 - Discoloration, delamination or melting may occur.
 - This range has been designed to comply with the maximum allowable wood cabinet temperatures of 194°F.
- **Cabinet storage space located above the surface units should be avoided.**
- **You should install a range hood that projects horizontally a minimum of 5 inches beyond the bottom of the cabinets. If cabinet storage is to be provided.**
 - The risk of burns or fire by reaching over the heated surface elements can be reduced.
- **You should not install the range in the humid place. Splashing the range with water or any electrolyte can result in electrical shock.**
- **You should not let cooking grease or flammable material accumulate in or near the range.**
 - Failure to do so can result in serious burns.

⚠ WARNING

- **The information in this manual should be followed exactly.**

- A fire or electrical shock may result causing property damage, personal injury or death.

⚠ WARNING

- **Any person should not step or sit on the oven door. You should install the Anti-Tip Brackets supplied with the range.**



- The range could be tipped and injury might result from spilled hot liquid, food, or the range itself.



- If the range is pulled away from the wall for cleaning, service, or any other reason, ensure that the Anti-Tip Device is properly reengaged when the range is pushed back against the wall. Broiling beyond recommended cooking times.

⚠ CAUTION

- **You should put on gloves during the installation procedure.**

- Failure to do so can result in bodily injury.

ⓘ NOTE

- Read all instructions contained in these installation instructions before installing range.
- Remove all packing materials from the oven compartments before connecting the electrical supply to the range.
- Observe all governing codes and ordinances.
- Be sure to leave these instructions with the consumer.

ⓘ NOTE

Keep these instructions with your owner's manual for future reference.

- As when using any appliance generating heat, there are certain safety precautions you should follow.
- Be sure your range is installed and grounded properly by a qualified installer or service technician.
- Make sure the wall coverings around the range can withstand the heat generated by the range.
- To eliminate the need to reach over the surface elements, cabinet storage space above the elements should be avoided.

PREPARE TO INSTALL THE RANGE**TOOLS NEEDED**

Phillips Screwdriver

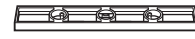

Level

Flat-blade
Screwdriver

Adjustable Wrench

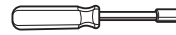

1/4" Nut Driver



Drill

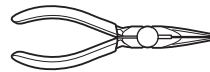

Pliers



Safety Glasses

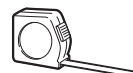

Tape Measure



Gloves

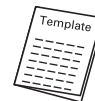

Pencil

PARTS PROVIDED

Template (1)

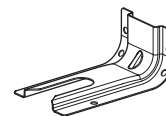

Anti-Tip Brackets (2)

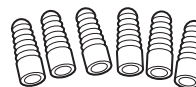

Anchor Sleeves (12)



Lag Bolts (12)

**(For Anti-Tip Bracket Mounted
on Concrete Floors and Walls)**

PARTS NOT PROVIDED**(UL Approved 40 or 50 AMP)**

4-Wire Cord OR 3-Wire Cord

**Strain Relief
(For Conduit
Installations Only)**

INSTALLATION DRAWINGS

NOTE

SAVE FOR THE USE OF THE LOCAL ELECTRICAL INSPECTOR

CLEARANCES AND DIMENSIONS (Figure 1)

To install range refer to the following Figure 1.

For installation in CANADA, a Free-standing range is not to be installed closer than 15/32 (12mm) from any adjacent surface.

CAUTION

- **Make sure that the wall covering, countertop and cabinets around the range can withstand the heat (up to 194°F) generated by the range.**
 - Discoloration, delamination or melting may occur.
 - This range has been designed to comply with the maximum allowable wood cabinet temperatures of **194°F**.

CAUTION

- **Cabinet storage space located above the surface units should be avoided.**
- **Install a range hood that projects horizontally a minimum of 5 inches beyond the bottom of the cabinets if cabinet storage is to be provided.**
 - The risk of burns or fire by reaching over the heated surface elements can be reduced.

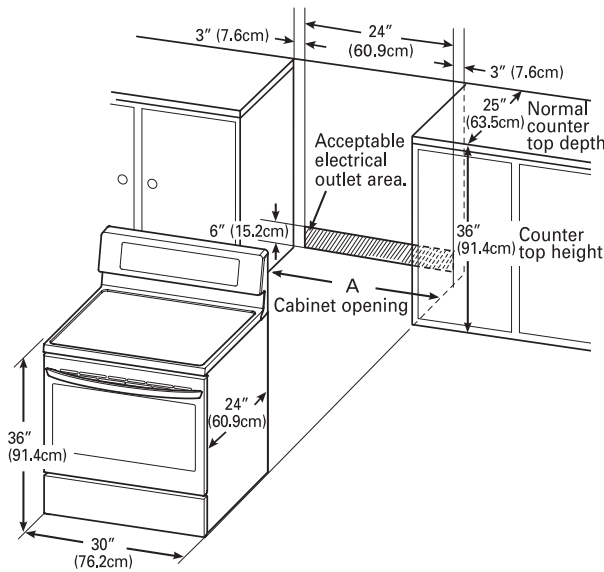

A = 30 (76.2 cm) For U.S.A
 = 30 (76.2 cm) ~ 31 (78.7 cm) For CANADA

FIGURE 1

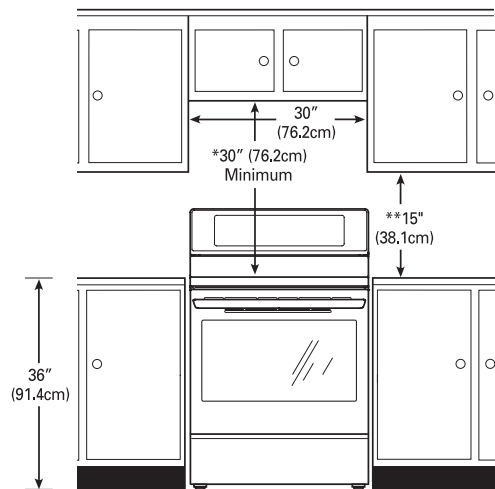

FIGURE 2

MINIMUM DIMENSIONS (Figure 2)

* 30" (76.2 cm) minimum clearance between the top of the cooking surface and the bottom of an unprotected wood or metal cabinet; or 24" (60.9 cm) minimum when bottom of wood or metal cabinet is protected by not less than 1/4" (6.4 cm) flame retardant millboard covered with not less than no. 28 MSG sheet steel, 0.015" (0.381 mm) stainless steel, 0.024" (0.610 mm) aluminum or 0.020" (0.508 mm) copper.

** 15" (38.1 cm) minimum between countertop and adjacent cabinet bottom.

ELECTRICAL CONNECTION REQUIREMENTS

This appliance must be installed and grounded on a branch circuit by a qualified technician in accordance with the National Electrical code ANSI/NFPA NO. 70 - latest edition.

All wiring should conform to Local and NEC. This range requires a single-phase, 3 wire, A.C 120/208V or 120/240V 60Hz electrical system. Use only a 3-conductor or a 4-conductor UL-listed range cord with closed-loop terminals, open-end spade lugs with upturned ends or similar termination. DO NOT install the power cord without a strain relief.

A range cord rated at 40 amps with 120/240 minimum volt range is required. If a 50 amp range cord is used, it should be marked for use with 1 3/8" diameter connection openings. This appliance may be connected by means of conduit or power cord. If conduit is being used, go to page 7 for **3 wire conduit connections** or page 8 for **4 wire conduit connections**.

⚠ WARNING

- **New branch-circuit installations (1996 NEC) for mobile homes, recreational vehicles, and installations where local codes do not allow grounding through the neutral wire require a 4-conductor UL listed range cord or 4 wire conduit connection.**
- **Power supply cord and plug should not be modified. If it will not fit the outlet, have a proper outlet installed by a qualified electrician.**
- **Using an extension cord to connect the power is prohibited. The way to connect the power cord and plug directly is strongly recommended.**
- **Electrical ground is required on this appliance.**
- **You should make sure that the power cord is not pinched by the range or heavy objects.**
 - Failure to do so can result in serious burns or electrical shock.

Specified power-supply-cord kit rating				
Range rating, watts		Specified rating of power supply-cord kit, amperes	Diameter (inches) of Range connection Opening	
120/240 volts 3-wire	120/208 volts 3-wire		Power cord	Conduit
8,750 - 16,500	7,801 - 12,500	40 or 50A	1 3/8"	1 1/8"
16,501 - 22,500	12,501 - 18,500	50	1 3/4"	1 3/8"

3, 4 - Wire electrical wall Receptacle

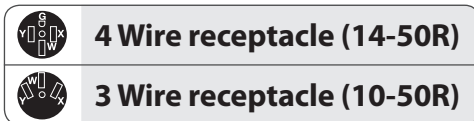

FIGURE 3

CONNECT RANGE CORD

The Rear Access cover must be removed. Loosen the three screws with a screwdriver. The terminal block will then be accessible.

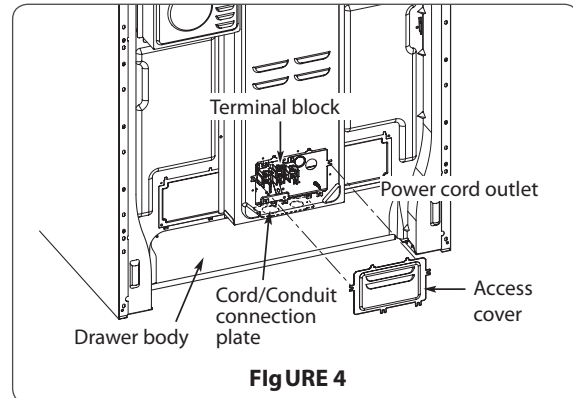

FIGURE 4

The Cord/Conduit connection plate is used for the installation of power cord or conduit. For power cord, install it with the connection plate as INSTALLED. For conduit, remove the connection plate located below the rear of the drawer body and use the conduit hole (1 1/8") instead of power cord hole (1 3/8"). (Refer to Figure 5 and 6.)

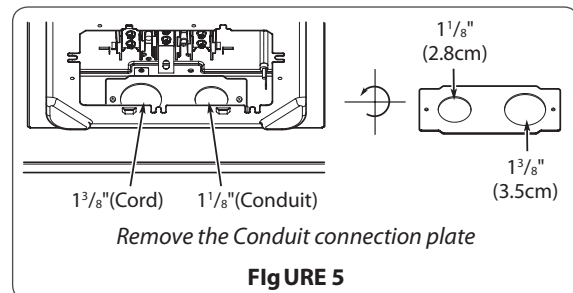

FIGURE 5

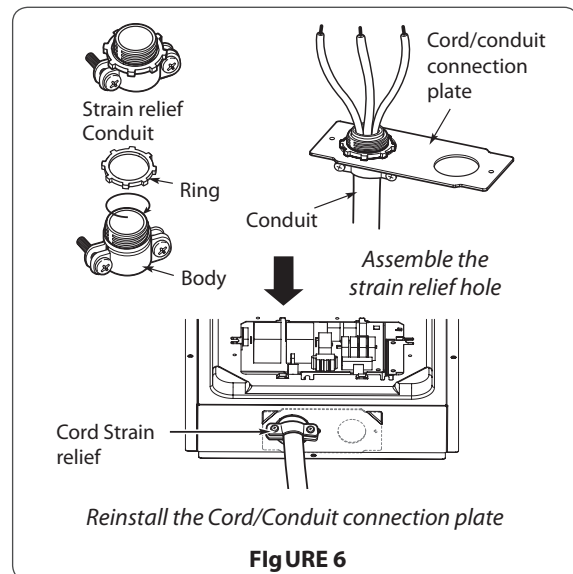

FIGURE 6

3-WIRE CONNECTION WITH A POWER SUPPLY CORD

⚠ WARNING

- The middle (neutral or ground) wire of a 3 wire power cord or a 3 wire conduit has to be connected to the middle post of the main terminal block. The remaining two wires of the power cord or conduit have to be connected to the outside posts of the main terminal connection block.

- Failure to do so can result in electrical shock, severe personal injury or death.

Install the power cord as follows:

For power cord installations, Hook the strain relief over the power cord hole ($1\frac{3}{8}$ ") located below the rear of lower oven. Insert the power cord through the strain relief and tighten it. (Refer to Figure 7.)

DO NOT install the power cord without a strain relief.

1. Remove the lower 3 screws from the terminal block and retain them. (Refer to Figure 8.)
2. Insert the 3 screws through each power cord terminal ring and into the lower terminals of the terminal block. Make sure that the center wire (white/neutral) is connected to the center lower position of the terminal block.
3. Tighten 3 screws securely into the terminal block. Do not remove the ground strap connections.
4. Refer to page 11.

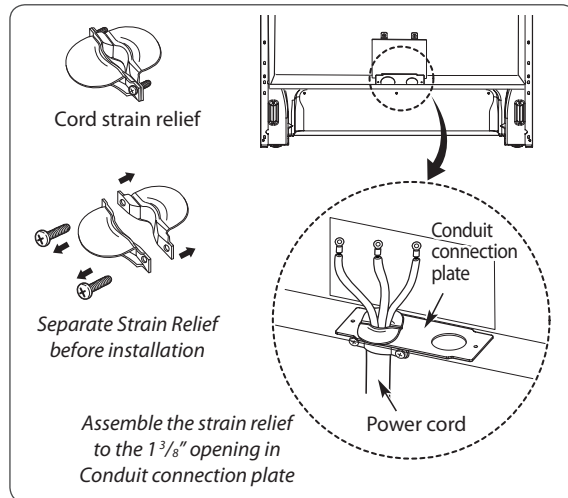

FIGURE 7

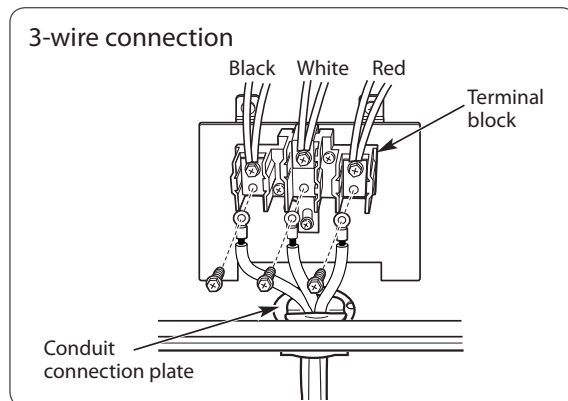

FIGURE 8

4-WIRE CONNECTION WITH A POWER SUPPLY CORD

⚠ WARNING

- Only a 4-conductor power-supply cord kit rated 120/240 volts, 50 amperes and marked for use with ranges with closed-loop connectors or open-end spade lugs with upturned ends shall be used. The middle (neutral) wire of the power cord or 4-wire conduit has to be connected to the middle post of the main terminal block. The other two wires of the power cord or conduit have to be connected to the outside posts of the main terminal connection block. The 4th ground wire must be connected to the frame of the range with the ground screw.

- Failure to do so can result in electrical shock, severe personal injury or death.

Install the power cord as follows:

For power cord installations, Hook the strain relief over the power cord hole ($1\frac{3}{8}$ "") located below the rear of lower oven. Insert the power cord through the strain relief and tighten it. (Refer to Figure 7.)

DO NOT install the power cord without a strain relief.

1. Remove the lower 3 screws from the terminal block and retain them. (Refer to Figure 9.)
2. Remove ground strap and discard as show in in Figure 9.
3. Insert the ground screw into the power cord ground wire terminal ring and secure it to the range frame.
4. Insert the 3 screws through each power cord terminal ring and into the lower terminals of the terminal block. Make sure that the center wire (white/neutral) is connected to the center lower position of the terminal block.
5. Tighten 3 screws securely into the terminal block.

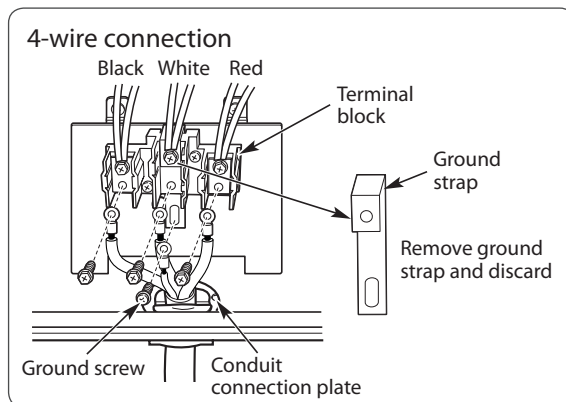

FIGURE 9

3-WIRE CONNECTION: CONDUIT

Install the conduit as follows:

Remove the Conduit connection plate from the rear of lower oven and rotate it as shown in Figure 5. The conduit hole ($1\frac{1}{8}$ "") must be used.

First, prepare the conduit wires as shown in Figure 10.

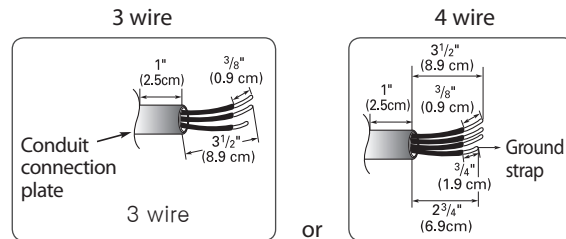

FIGURE 10

Second, install conduit as shown in Figure 6.

For conduit installations, after purchasing a strain relief, insert it in the conduit hole ($1\frac{1}{8}$ ""). Then install the conduit through the body of strain relief and fasten the strain relief with its ring. Reinstall the bracket.

For conduit connections :

If the wire in the conduit is copper it must be 8 or 10 AWG wiring.

If the wire in the conduit is aluminum it must be 6 or 8 AWG wiring.

1. Loosen the lower 3 screws from the terminal block. Refer to Figure 11.)
2. Insert the bare wire (white/neutral) end through the center terminal block opening. Do not remove ground strap connections.
3. Insert the two side bare wire ends into the lower left and the lower right terminal block opening. Tighten the 3 screws securely into the terminal block. (approximately 35 - 50 IN-LB)
4. Refer to page 11.

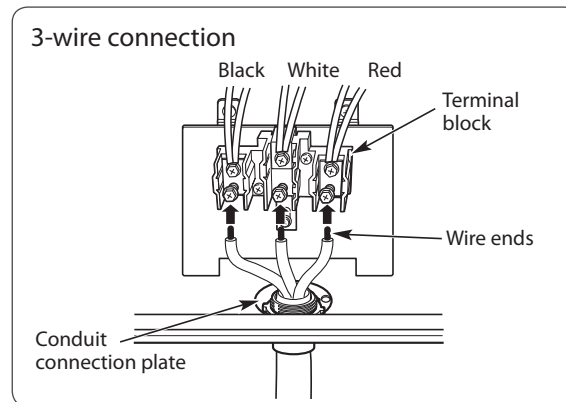

FIGURE 11

4-WIRE CONNECTION: CONDUIT

1. Follow the instructions under "Install the conduit as follows" on page 8 to correctly install the strain relief. DO NOT install the conduit without a strain relief.
2. Loosen the 2 lower left and right screws from the terminal block. (Refer to Figure 12.) Remove the lower 2 center screws.
3. Remove ground strap and discard as shown in Figure 12. Do not discard any screws.
4. Attach the ground bare wire end to range frame and secure it in place with the ground screw (Refer to figure 12.)
5. Insert the bare wire (white/neutral) end through the center terminal block opening.
6. Insert the two side bare wire ends into the left and the right terminal block opening. Tighten the 3 screws securely into the terminal block. (approximately 35 - 50 IN-LB)
7. Refer to page 11.

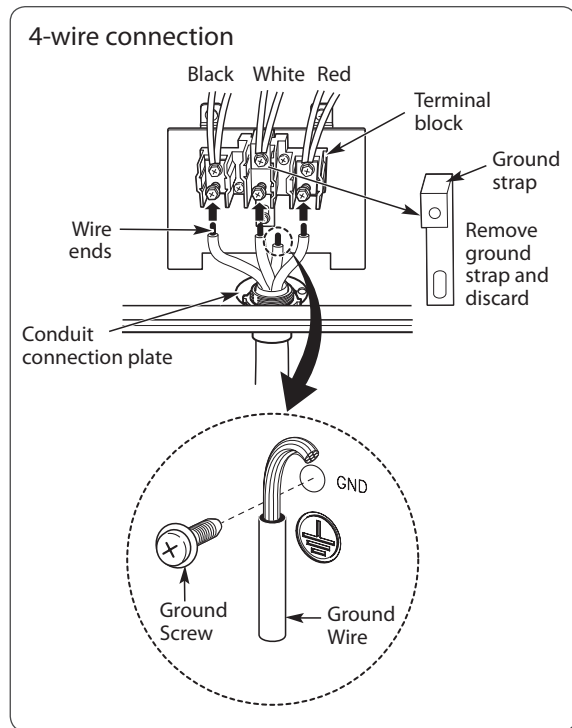
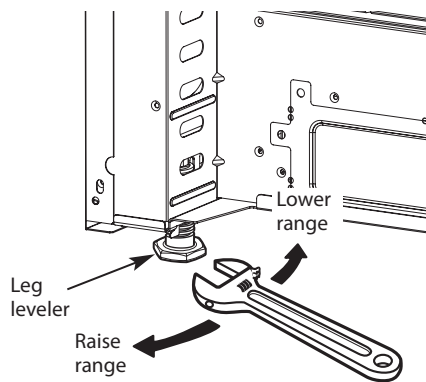
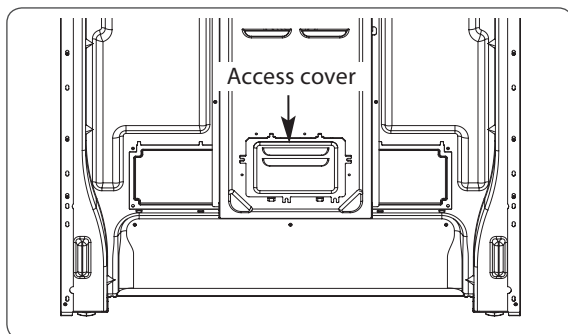

FIGURE 12

Replace the access cover on the back of the range. To replace the wire cover, insert the two tabs into the openings located below the opening and tighten the three screws.



Use a level to check your adjustments. Place the level diagonally on the oven rack, and check each direction for level.

First check direction \hat{A} .
After check direction \hat{C} .
If the level doesn't show level on the rack, adjust the leveling legs with a wrench.

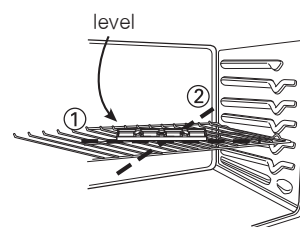

ANTI-TIP DEVICE INSTALLATION

⚠ WARNING



• Any person should not step or sit on the oven door. You should install the Anti-Tip Brackets supplied with the range.

- The range could be tipped and injury might result from spilled hot liquid, food, or the range itself.
- If the range is pulled away from the wall for cleaning, service, or any other reason, ensure that the Anti-Tip Device is properly reengaged when the range is pushed back against the wall. Broiling beyond recommended cooking times.

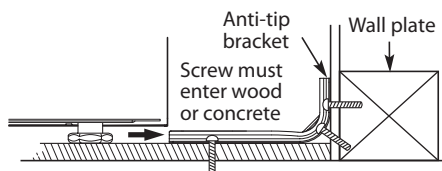

1. Locate the brackets using the template

Anti-tip brackets are packaged with the template. The instructions include necessary information to complete the installation. Read and follow range installation instruction sheet (template).

2. Level the range

Level the range by adjusting the leveling legs with a wrench.

FINAL INSTALLATION

- Move range close enough to the opening to plug into the receptacle.
- Slide range into position insuring that both back legs slide under the anti-tip brackets. Range should sit flush against the back wall when properly installed.
- Carefully attempt to tip range forward to insure that the anti-tip brackets are engaged properly. If properly installed, the anti-brackets will prevent the range from being tipped. If the range can be tipped, reinstall the range until the brackets are properly installed and the range will not tip forward.
- Turn on electrical power. Check the range for proper operation as described in owner's manual.



LG Customer Information Center

For inquires or comments, visit www.lg.com or call

1-800-243-0000 USA, Consumer User

1-888-542-2623 CANADA

Register your product Online!

www.lg.com



Printed on 100% Recycled Paper

Printed in Korea

Free Manuals Download Website

<http://myh66.com>

<http://usermanuals.us>

<http://www.somanuals.com>

<http://www.4manuals.cc>

<http://www.manual-lib.com>

<http://www.404manual.com>

<http://www.luxmanual.com>

<http://aubethermostatmanual.com>

Golf course search by state

<http://golfingnear.com>

Email search by domain

<http://emailbydomain.com>

Auto manuals search

<http://auto.somanuals.com>

TV manuals search

<http://tv.somanuals.com>