



ENGLISH

# OWNER'S MANUAL SoundPlate™

LAP340 / LAP341

Please read this manual carefully before operating your set and retain it for future reference.



MFL67892678



## Safety Information



**CAUTION:** TO REDUCE THE RISK OF ELECTRIC SHOCK DO NOT REMOVE COVER (OR BACK) NO USER-SERVICEABLE PARTS INSIDE REFER SERVICING TO QUALIFIED SERVICE PERSONNEL.



This lightning flash with arrowhead symbol within an equilateral triangle is intended to alert the user to the presence of uninsulated dangerous voltage within the product's enclosure that may be of sufficient magnitude to constitute a risk of electric shock to persons.



The exclamation point within an equilateral triangle is intended to alert the user to the presence of important operating and maintenance (servicing) instructions in the literature accompanying the product.

**WARNING:** TO PREVENT FIRE OR ELECTRIC SHOCK HAZARD, DO NOT EXPOSE THIS PRODUCT TO RAIN OR MOISTURE.

**CAUTION:** The apparatus shall not be exposed to water (dripping or splashing) and no objects filled with liquids, such as vases, shall be placed on the apparatus.

**WARNING:** Do not install this equipment in a confined space such as a book case or similar unit.

**CAUTION:** Do not block any ventilation openings. Install in accordance with the manufacturer's instructions.

Slots and openings in the cabinet are provided for ventilation and to ensure reliable operation of the product and to protect it from over heating. The openings shall be never be blocked by placing the product on a bed, sofa, rug or other similar surface. This product shall not be placed in a built-in installation such as a bookcase or rack unless proper ventilation is provided or the manufacturer's instruction has been adhered to.

### CAUTION concerning the Power Cord

Most appliances recommend they be placed upon a dedicated circuit;

That is, a single outlet circuit which powers only that appliance and has no additional outlets or branch circuits. Check the specification page of this owner's manual to be certain. Do not overload wall outlets. Overloaded wall outlets, loose or damaged wall outlets, extension cords, frayed power cords, or damaged or cracked wire insulation are dangerous. Any of these conditions could result in electric shock or fire. Periodically examine the cord of your appliance, and if its appearance indicates damage or deterioration, unplug it, discontinue use of the appliance, and have the cord replaced with an exact replacement part by an authorized service centre. Protect the power cord from physical or mechanical abuse, such as being twisted, kinked, pinched, closed in a door, or walked upon. Pay particular attention to plugs, wall outlets, and the point where the cord exits the appliance. To disconnect power from the mains, pull out the mains cord plug. When installing the product, ensure that the plug is easily accessible.

**NOTICE:** For Product Identification and Compliance/Safety labeling information please refer to Main label on the bottom of unit.

## 4 Getting Started

---

This device is equipped with a portable battery or accumulator.

**Safety way to remove the battery or the battery from the equipment:** Remove the old battery or battery pack, follow the steps in reverse order than the assembly. To prevent contamination of the environment and bring on possible threat to human and animal health, the old battery or the battery put it in the appropriate container at designated collection points. Do not dispose of batteries or battery together with other waste. It is recommended that you use local, free reimbursement systems batteries and accumulators. The battery shall not be exposed to excessive heat such as sunshine, fire or the like.

# Table of Contents

## 1 Getting Started

---

- 3 Safety Information
- 6 Unique features
- 6 Introduction
- 6 Accessories
- 7 Front panel
- 7 Rear panel
- 8 Remote control
- 10 Setting up the unit

## 2 Operating

---

- 13 Basic operations
  - 13 – Optical input operation
  - 13 – LG Sound Sync
  - 14 – AUTO POWER On/Off
- 15 Using Bluetooth technology
  - 15 – Listening to music stored on the Bluetooth devices
- 16 CINEMA SOUND

## 3 Troubleshooting

---

- 17 Troubleshooting

## 4 Appendix

---

- 18 Specifications
- 19 Trademarks and licenses
- 19 Maintenance
  - 19 – Handling the unit

1

2

3

4

## Unique features

### LG Sound Sync

Controls volume level of this unit by the remote control of your LG TV that is compatible with LG Sound Sync.

### Bluetooth

Enjoys music from bluetooth device with simple connection.

## Introduction

### Symbols used in this manual

#### Note

Indicates special notes and operating features.

#### Caution

Indicates cautions for preventing possible damages from abuse.

## Accessories

Please check and identify the supplied accessories.

Designs and specifications of the accessories are subject to change without prior notice.

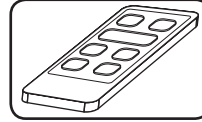

Remote Control (1)

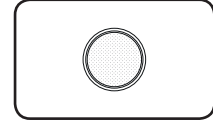

Battery (1)

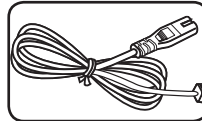

Power cord (1)

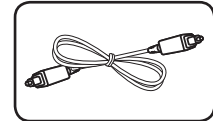

Optical cable (1)

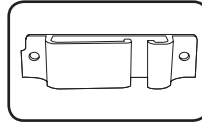

Cable holder (1)

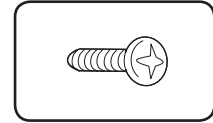

Screw (2)

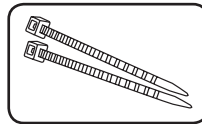

Cable ties for arranging cables (2)

## Front panel

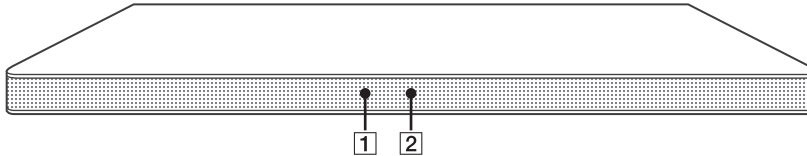

- 1 Remote sensor
- 2 LED indicator

You can check the current state of the unit by the colour LED on it. Refer to the table below.

LED Colour	Red	Orange	Green	White
<b>LED State</b>				
Off	Power on or disconnected power cord			
On	Standby	-	-	-
Blink (Twice rapidly)	CINEMA SOUND is off.	-	CINEMA SOUND is on.	-
Blink (Twice per second)	Booting	Bluetooth ready	-	LG sound sync (LG TV) ready
Blink (Once per second)	Mute	-	-	-
On -> Off (After 3 seconds)	-	Bluetooth paired	Optical function selected	LG sound sync (LG TV) paired

## Rear panel

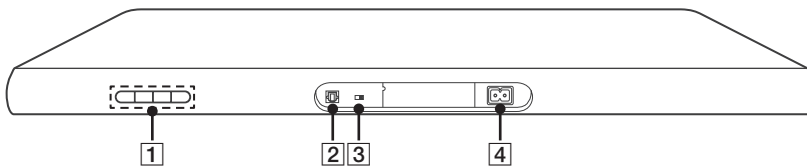

- 1 (Standby/On)  
+/- (Volume)  
Adjusts speaker volume.
  - 2 Optical input
  - 3 **AUTO POWER ON/OFF**  
Turns on or off AUTO POWER function.
  - 4 AC power input
- F** (Function)  
Press it repeatedly to select other function.

## Remote control

1  
Getting Started

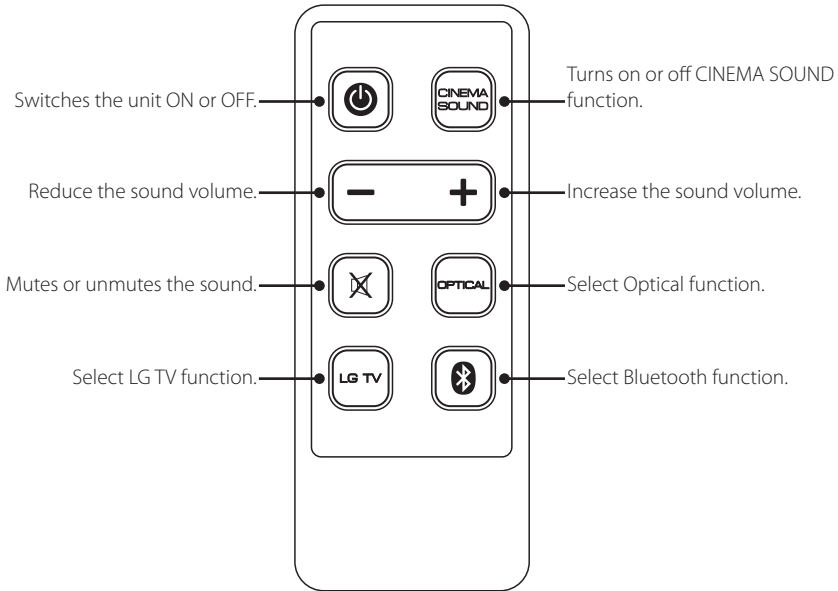

### ! Note

- Once the unit is shut down to standby, please wait several seconds before trying to use remote again.
- When you press any button on the remote control, the red LED on the main unit blinks twice. (Except (Power), **CINEMA SOUND**)
- The colour LED that indicates the current function is lit up for about 3 seconds when you press the function buttons: , **OPTICAL, LG TV**.
- The red LED on Unit will be lit if the volume level is adjusted between minimum to maximum.
- The red LED blinks twice rapidly when CINEMA SOUND function is off.
- The green LED blinks twice rapidly when CINEMA SOUND function is on.



## Battery installation



### Caution

Do not open the battery cover by using your finger. Or else, your nail could break.

1. Turn the battery cover counterclockwise by using your finger. Then take the battery cover.

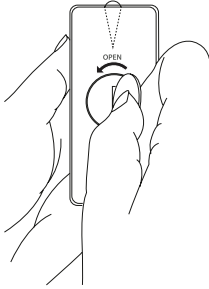

2. Insert and fix the battery with the minus (-) facing in the same direction as the minus (-) on the battery compartment.

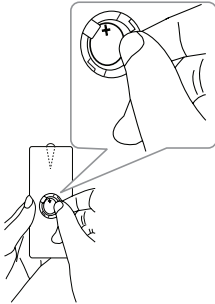

3. Put the battery cover on the remote control and turn it clockwise to close.

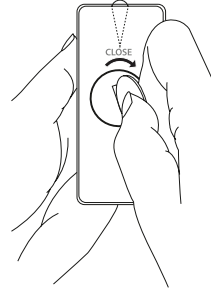

### Warning

DO NOT INGEST BATTERY. CHEMICAL BURN HAZARD.



### Caution

- The battery used in this device may present a fire or chemical burn hazard if mistreated. Do not recharge, disassemble, incinerate, or heat above 100 °C (212 °F). Replace the battery part no. CR2025 only. Use of another battery may present a risk of fire or explosion. Dispose of used battery. Keep battery away from children. Do not disassemble or dispose of in fire.
- [The remote control supplied with] This product contains a coin/button cell battery. If the coin/button cell battery is swallowed, it can cause severe internal burns in just 2 hours and can lead to death. Keep new and used batteries away from children. If the battery compartment does not close securely, stop using the product and keep it away from children. If you think batteries might have been swallowed or placed inside any part of the body, seek immediate medical attention.

## Setting up the unit

This unit is designed to be positioned under your TV.

Before setting up this system with your TV, make sure your TV's specifications.

- **Weight**

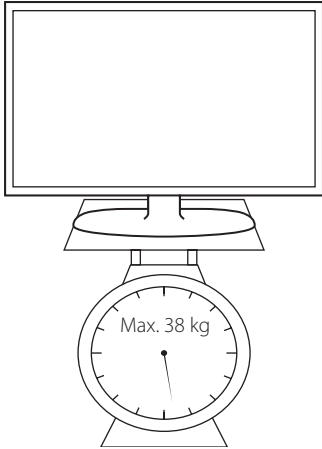

- **Size of the base**

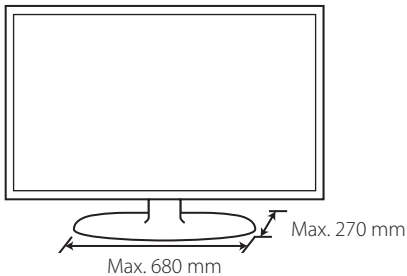

### ⚠ Caution

- Do not try to set up this unit alone. It may need at least 2 persons to lift your TV. Otherwise it may result in a personal injury and/or property damages.
- Do not connect a CRT type TV to this unit. Because this unit contains magnetic parts, colour irregularity may occur on the TV screen.
- Do not put the other objects except a TV or a monitor on the unit.
- The unit must be set up on a stable and horizontal surface.
- Do not put any other object between the unit and the supporting furniture when you set up the unit.

### ! Recommendation

It is recommended to set up the unit on a sufficiently firm and horizontal surface.

1. Place the unit on the position where you want to place your TV.

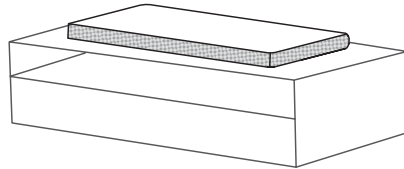

2. Connect the optical cable and the power cord to the unit.

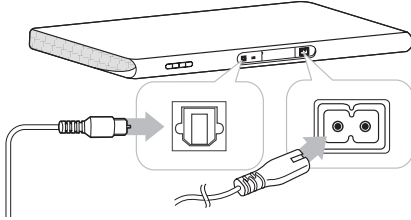

3. Connect another end of optical cable connecting the unit to your TV.

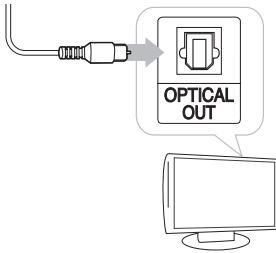

**! Note**

You can arrange the cables of the unit.

1. Fix the cable holder with screws.

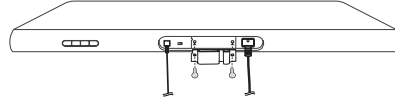

2. Arrange the cables as the below.

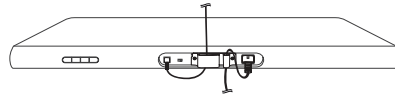

4. Place your TV on the centre of the unit.

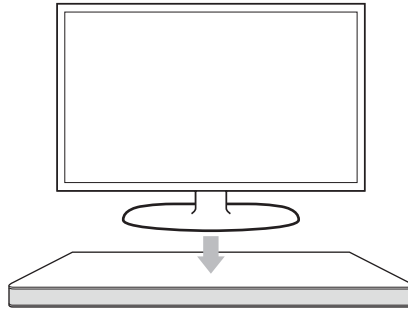

5. Plug in the power cord of the unit.

**Caution**

- Do not place your TV on the edge of this unit. Otherwise it may result in a personal injury and/or property damages.



- If your TV is over recommended weight (max 38 kg) or has a Base larger in area than the Unit do NOT place TV on the Unit.

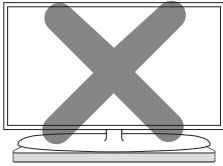

- In this case, it is recommended to place this system in another location such as on the shelf under the TV.

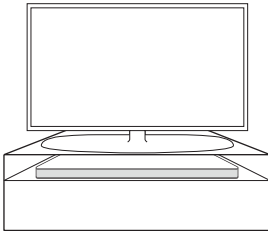

**How to Affix the Ferrite Core (Optional)**

You may need to attach Ferrite core in order to reduce or eliminate any electrical interference.

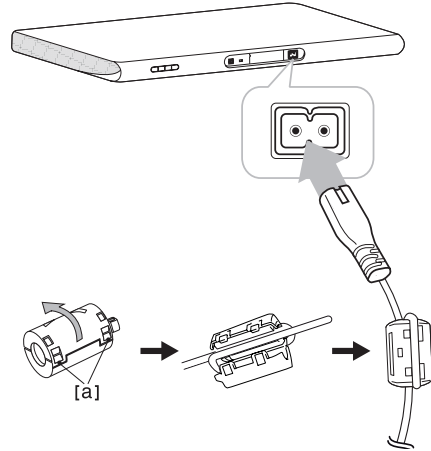

1. Pull the stopper [a] of the ferrite core to open.
2. Wind the power cord around the ferrite core once.
3. Close the ferrite core until it clicks.

## Basic operations

### Optical input operation

#### Note

Before operating this Unit it is advised to turn OFF TV speaker Sound as it may create sound differences between the 2 products running simultaneously.

Refer to TV menu/Specifications and select from below methods :

- Mute your TV.
- Select [Off] on the TV sound setup menu not to output the sound through the TV.
- Select [Optical output] on the TV sound setup menu to listen to the sound through this unit.

1. Connect your TV to the unit by using an optical cable. (Refer to the pages 10 - 11.)
2. Turn on the unit by pressing  (Power) on the remote control.
3. Select OPTICAL function by using **OPTICAL** on the remote control.  
Green LED on the unit is lit up for about 3 seconds and you can listen to the TV's sound.

## LG Sound Sync

**Sound Sync**  
Wireless

You can control some functions of this unit by your TV's remote control with LG Sound Sync. It is compatible with the LG TV that is supported LG Sound Sync. Make sure of the LG Sound Sync logo on your TV.

Controllable function by LG TV's remote control :  
Volume up/down, mute

Refer to the TV's instruction manual for the details of LG Sound Sync.

Make one of the following connections, depending on the capabilities of your equipment.

#### Note

- You can also use the remote control of this unit while using LG Sound Sync. If you use TV's remote control again, the unit synchronizes with the TV.
- When the connections failed, make sure of the condition of the TV and power of it.
- Make sure of the condition of this unit and the connection in the cases below when using LG Sound Sync.
  - Turned off the unit.
  - Changing the function to the others.
  - Disconnecting the optical cable.
  - Disconnecting the wireless connection caused by interference or a distance.
- The amount of time to turn off this unit is different depending on your TV when you set AUTO POWER function to ON.

### With wired connection

1. Connect your LG TV to the unit by using an optical cable. (Refer to the pages 10 - 11.)
2. Set up LG Sound Sync (Optical) on the TV. Refer to the TV's instruction manual.
3. Turn on the unit by pressing  (Power) on the remote control.
4. Select OPTICAL function by using **OPTICAL** on the remote control.

Green LED on the unit is lit up for about 3 seconds and you can listen to the TV's sound.

### With wireless connection

1. Turn on the unit by pressing  (Power) on the remote control.
2. Select LG TV function by using **LG TV** on the remote control. Then white LED on the unit starts to blink.
3. Set up LG Sound Sync (Wireless) on the TV. Refer to the TV's instruction manual.

When connection is completed normally between this unit and your TV, white LED on the unit is lit up for about 3 seconds.

#### Note

If you turned off the unit directly by pressing  (Power), LG Sound Sync (Wireless) will be disconnected. To use this function again, you should reconnect the TV and the unit.

## AUTO POWER On/Off

This function automatically turns on/off the unit when you turn on/off the TV or the external device (DVD Player, Blu-ray Disc Player, etc.) connected to this unit.

It is supported only on OPTICAL and LG TV functions.

You can turn on or off AUTO POWER function by using **AUTO POWER ON/OFF** switch on the rear panel of the unit.

#### Note

- After the unit is turned on by AUTO POWER function, it will be automatically turned off if there is no signal for a certain period of time from the TV connected by LG Sound Sync (Optical/Wireless).
- After the unit is turned on by AUTO POWER function, it will be automatically turned off if there is no signal for a certain period of time from the external device connected by an optical cable.
- AUTO POWER function is initially turned on.
- If you turned off the unit directly, it cannot be turned on automatically by AUTO POWER function. However the unit can be turned on by AUTO POWER function when optical signal comes in after 5 seconds of no signal.
- Depending on the connected device, this function may not operate.
- When booting this unit on LG TV function, it takes about 25 seconds to turn it on and the red LED is blinking twice per second. During that time, you cannot control this unit except turn it off.
- In Bluetooth mode, this unit may be turned on by AUTO POWER setting depending on the connected Bluetooth device and then LG TV function is selected. In this case the unit will be turned off automatically and when you restart the unit, it will be turned on by LG TV function.

## Auto power down

This unit will turn itself off to save electric consumption in the case were main unit is not connected to external device and is not used for 25 minutes.

# Using Bluetooth technology

## About Bluetooth

Bluetooth is wireless communication technology for short range connection.

The sound may be interrupted when there is interference by the other electronic waves which run on same frequency or if you connect bluetooth devices in the other rooms nearby.

Connecting individual devices under **Bluetooth®** wireless technology does not incur any charges. A mobile phone with **Bluetooth®** wireless technology can be operated via the Cascade if the connection was made via **Bluetooth®** wireless technology.

Available Devices : Mobile phone, MP3, Laptop, PDA etc.

## Bluetooth profiles

In order to use **Bluetooth®** wireless technology, devices must be able to interpret certain profiles. This unit is compatible with following profile. A2DP (Advanced Audio Distribution Profile)

## Listening to music stored on the Bluetooth devices

### Pairing this unit and Bluetooth device

Before you start the pairing procedure, make sure the Bluetooth feature is turned on in to your Bluetooth device. Refer to your Bluetooth device's user guide. Once a pairing operation is performed, it does not need to be performed again.

1. Select the Bluetooth function by using  on the remote control. Then the orange LED on the unit starts to blink.
2. Operate the Bluetooth device and perform the pairing operation. When searching for this unit with the Bluetooth device, a list of the devices found may appear in the Bluetooth device display depending on the type of Bluetooth device. Your unit appears as "LG SOUND PLATE (XX:XX)".

#### Note

- XX:XX means the last four digits of BT address. For example, if your unit has a BT address such as 9C:02:98:4A:F7:08, you will see "LG SOUND PLATE (F7:08)" on your Bluetooth device.
- Depending on the Bluetooth device type, some device have a different pairing way. Enter the PIN code (0000) as needed.

3. The orange LED is lit up for about 3 seconds when this unit successfully paired with your Bluetooth device.
4. Listen to music.  
To play a music stored on your Bluetooth device, refer to your Bluetooth device's user guide.

**!** Note

- When using *Bluetooth*® technology, you have to make a connection between the unit and the bluetooth device as close as possible and keep the distance. However it may not work well in the case below :
  - There is a obstacle between the unit and the bluetooth device.
  - There is a device using same frequency with *Bluetooth*® technology such as a medical equipment, a microwave or a wireless LAN device.
- You should connect your Bluetooth device to this unit again when you restart it.
- When you select Bluetooth function again after changing to other functions, Bluetooth connection may be disconnected. You should reconnect the bluetooth device to use this function.
- The sound may be interrupted when the connection interfered by the other electronic wave.
- You cannot control the Bluetooth device with this unit.
- Pairing is limited one Bluetooth device per one unit and multi-pairing is not supported.
- Depending on the type of the device, you may not be able to use the Bluetooth function.
- You can enjoy wireless system using phone, MP3, Notebook, etc..
- The more distant between the unit and the bluetooth device, the lower the sound quality becomes.
- Bluetooth connection will be disconnected when the unit is turned off or the bluetooth device gets far from the unit.
- When Bluetooth connection is disconnected, connect the bluetooth device to the unit again.
- When not connected the Bluetooth, orange LED is blinking.

## CINEMA SOUND

When watching movies, you can enjoy optimized sound effect through the prominent bass and cinematic surround effect.

Turn on or off the sound effect by using **CINEMA SOUND** on the remote control.

**!** Note

CINEMA SOUND will be turned off when you restart the unit.



# Troubleshooting

PROBLEM	CAUSE & CORRECTION
No Power	<ul style="list-style-type: none"> <li>The power cord is unplugged. Plug in the power cord.</li> <li>Check the condition by operating other electronic devices.</li> </ul>
No sound	<ul style="list-style-type: none"> <li>Incorrect input source is selected. Check the input source and select the correct input source.</li> <li>The mute function is activated. Press  or adjust the volume level to cancel the mute function.</li> </ul>
The remote control does not work properly.	<ul style="list-style-type: none"> <li>The remote control is too far from the unit. Operate the remote control within about 7 m.</li> <li>There is an obstacle in the path of the remote control and the unit. Remove the obstacle.</li> <li>The battery in the remote control is exhausted. Replace the battery with new one.</li> </ul>
The AUTO POWER on/off function does not work.	<ul style="list-style-type: none"> <li>Depending on the connected device, this function may not operate.</li> <li>Check the status of <b>AUTO POWER ON/OFF</b> switch on the rear panel of the unit.</li> </ul>
When you feel the output sound of the unit is low.	<p>Check the details below and adjust the unit according to them.</p> <ul style="list-style-type: none"> <li>With the unit connected with TV, change the AUDIO DIGITAL OUT setting on TV Setup Menu from [PCM] to [AUTO] or [BITSTREAM].</li> <li>With the unit connected with Player, change the AUDIO DIGITAL OUT setting on Player Setup Menu from [PCM] to [PRIMARY PASS-THROUGH] or [BITSTREAM].</li> <li>Change Audio DRC setting on Player setup menu to [OFF] state.</li> </ul>
There is a noise on the periphery of the unit.	<p>Depending on the type of the furniture where the unit is placed, you might hear a slight noise from the furniture due to the dual subwoofers built within the product.</p> <ul style="list-style-type: none"> <li>Check the supporting furniture whether it is sufficiently firm and horizontal.</li> <li>However, if you still hear a noise, place a tablecloth between the unit and the surface.</li> </ul>

## Specifications

General	
Power requirements	Refer to the main label on the unit.
Power consumption	Refer to the main label on the unit.
Dimensions (W x H x D)	(700 x 38.5 x 320) mm (With foot)
Net Weight (Approx.)	3.8 kg
Operating temperature	5 °C to 35 °C (41 °F to 95 °F)
Operating humidity	5 % to 90 %

Inputs	
DIGITAL IN (OPTICAL IN)	3.3 V (p-p), Optical jack
Available Digital Input Audio Sampling Frequency	32 kHz, 44.1 kHz, 48 kHz, 96 kHz

Amplifier	
Total output	120 W
Stereo mode	20 W x 2 (8 $\Omega$ at 1 kHz)
Surround mode	20 W x 2 (8 $\Omega$ at 1 kHz)
Built-In subwoofer	40 W (4 $\Omega$ at 100 Hz)
THD	0.1 %

- Designs and specifications are subject to change without prior notice.

## Trademarks and licenses



Manufactured under license from Dolby Laboratories. Dolby and the double-D symbol are trademarks of Dolby Laboratories.



Manufactured under license under U.S. Patent Nos: 5,956,674; 5,974,380; 6,487,535 & other U.S. and worldwide patents issued & pending. DTS, the Symbol, & DTS and the Symbol together are registered trademarks & DTS 2.0 Channel is a trademark of DTS, Inc. Product includes software. © DTS, Inc. All Rights Reserved.



**Bluetooth**® wireless technology is a system which allows radio contact between electronic devices. Connecting individual devices under **Bluetooth**® wireless technology does not incur any charges. A mobile phone with **Bluetooth**® wireless technology can be operated via the Cascade if the connection was made via **Bluetooth**® wireless technology.

The **Bluetooth**® word mark and logos are owned by the **Bluetooth**® SIG, Inc. and any use of such marks by LG Electronics is under license.

Other trademarks and trade names are those of their respective owners.

## Maintenance

### Handling the unit

#### When shipping the unit

Please save the original shipping carton and packing materials. If you need to ship the unit, for maximum protection, re-pack the unit as it was originally packed at the factory.

#### Keeping the exterior surfaces clean

- Do not use volatile liquids such as insecticide spray near the unit.
- Wiping with strong pressure may damage the surface.
- Do not leave rubber or plastic products in contact with the unit for a long period of time.

#### Cleaning the unit

To clean the player, use a soft, dry cloth. If the surfaces are extremely dirty, use a soft cloth lightly moistened with a mild detergent solution. Do not use strong solvents such as alcohol, benzene, or thinner, as these might damage the surface of the unit.



## Free Manuals Download Website

<http://myh66.com>

<http://usermanuals.us>

<http://www.somanuals.com>

<http://www.4manuals.cc>

<http://www.manual-lib.com>

<http://www.404manual.com>

<http://www.luxmanual.com>

<http://aubethermostatmanual.com>

Golf course search by state

<http://golfingnear.com>

Email search by domain

<http://emailbydomain.com>

Auto manuals search

<http://auto.somanuals.com>

TV manuals search

<http://tv.somanuals.com>