



AV RECEIVER SYSTEM

OWNER'S MANUAL

MODEL: AR702TT

| Main Unit - AR702TT-AD
| Speakers - SR72TT-F, SR72TT-C, SR72TT-B
SR72TT-A

AR702TS

| Main Unit - AR702TS-AD
| Speakers - SR72TS-F, SR72TS-C, SR72TS-L
SR72TS-B, SR72TS-A

AR702BR

| Main Unit - AR702BR-AD
| Speakers - SR72BR-L, SR72BR-B, SR72BR-S
SR72BR-A

AR702NS

| Main Unit - AR702NS-AD

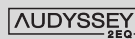

**Before connecting, operating or adjusting this product,
please read this instruction booklet carefully and completely.**



CAUTION: TO REDUCE THE RISK OF ELECTRIC SHOCK DO NOT REMOVE COVER (OR BACK) NO USER-SERVICEABLE PARTS INSIDE REFER SERVICING TO QUALIFIED SERVICE PERSONNEL.



This lightning flash with arrowhead symbol within an equilateral triangle is intended to alert the user to the presence of non insulated dangerous voltage within the product's enclosure that may be of sufficient magnitude to constitute a risk of electric shock to persons.



The exclamation point within an equilateral triangle is intended to alert the user to the presence of important operating and maintenance (servicing) instructions in the literature accompanying the product.

WARNING: TO PREVENT FIRE OR ELECTRIC SHOCK HAZARD, DO NOT EXPOSE THIS PRODUCT TO RAIN OR MOISTURE.

WARNING: Do not install this equipment in a confined space such as a book case or similar unit.

CAUTION: Do not block any ventilation openings. Install in accordance with the manufacturer's instructions.

Slots and openings in the cabinet are provided for ventilation and to ensure reliable operation of the product and to protect it from overheating. The openings should be never be blocked by placing the product on a bed, sofa, rug or other similar surface. This product should not be placed in a built-in installation such as a bookcase or rack unless proper ventilation is provided or the manufacturer's instruction have been adhered to.

CAUTION: The apparatus should not be exposed to water (dripping or splashing) and no objects filled with liquids, such as vases, should be placed on the apparatus.

CAUTION: The apparatus should not be exposed to water (dripping or splashing) and no objects filled with liquids, such as vases, should be placed on the apparatus.

CAUTION concerning the Power Cord

Most appliances recommend they be placed upon a dedicated circuit;

That is, a single outlet circuit which powers only that appliance and has no additional outlets or branch circuits. Check the specification page of this owner's manual to be certain.

Do not overload wall outlets. Overloaded wall outlets, loose or damaged wall outlets, extension cords, frayed power cords, or damaged or cracked wire insulation are dangerous. Any of these conditions could result in electric shock or fire. Periodically examine the cord of your appliance, and if its appearance indicates damage or deterioration, unplug it, discontinue use of the appliance, and have the cord replaced with an exact replacement part by an authorized LG Service Centre.

Protect the power cord from physical or mechanical abuse, such as being twisted, kinked, pinched, closed in a door, or walked upon. Pay particular attention to plugs, wall outlets, and the point where the cord exits the appliance.

To disconnect power from the mains, pull out the mains cord plug. When installing the product, ensure that the plug is easily accessible.

Contents

Introduction4-11

Before use	4
Before connection	4
Symbol Used in this Manual	4
Required cables	4
Front Panel	5
Rear Panel	6
Active Subwoofer	7
Display window	7
Remote Control	8-11

Installation12-22

Connecting components with digital audio output jacks	12-13
Connecting components with analog audio jacks	14-16
Connecting audio components	14
Connecting a camcorder or game console	15
Connecting PC, Portable device, or USB device	16
Connecting video components for Playback	17
Connecting video components for Recording	18
Connecting TV or components with HDMI jack	19
Connecting the antennas	20
Connecting speakers	21-22
Example of 6.1 channel speaker system configuration	21
Speaker System Connection	22

Operation23-37

Turning On the unit	23
Using Headphones	23
Audyssey 2EQ Automatic Speaker Setup	23-24
Selecting the input source	25
Selecting the input mode	25
Switching the audio signal	26
Switching the video signal	26
Playing media files using the USB feature	27

Listening to FM/AM radio	28
Presetting radio stations	28
Setting the Display Brightness	29
Using the Mute Function	29
Using the Sleep Timer	29
Displaying Source Information	29
Selecting setup menu	30-33
Setup Configuration	30
General operation of setup menu	30
1. SURROUND (Enjoying surround sound)	30
2. SPK TYPE (Setting speaker type)	31
3. X-OVER	31
4. SPK DISTANCE (Setting speaker distance)	32
5. SPK LEVEL (Setting speaker level)	32
6. HDMI OUT	32
7. DIGITAL IN (Setting Digital Input Signal)	32
8. LOAD INITIAL	33
Enjoying the listening mode	33-35
SURROUND mode	33
DSP (Digital Sound Processor) mode	34
BYPASS mode	34
ENHANCER mode	34
About Listening mode	35
Adjusting the speaker level	36
TEST TONE	36
AV Sync. (Adjusting the audio delay)	36
Adjusting the tone control	36
Using the NIGHT function (Dolby Digital only)	37
M1, M2, M3	37

Reference38-43

Mini Glossary for Audio Stream & Surround mode	38-39
Troubleshooting	40
Specifications	41-43

Introduction

Before use

- To ensure proper use of this product, please read this owner's manual carefully and keep this manual in an easily accessible place for future reference.
- This manual provides information on the operation and maintenance of your unit. Should the unit require service, contact an authorized service location.
- As the unit may become warm during operation, always leave sufficient space above the unit for ventilation.
- Choose the installation location of your unit carefully. Avoid placing it in direct sunlight or close to a source of heat. Also avoid locations subject to vibrations and excessive dust, heat, cold or moisture.
- When removing the power plug from the wall outlet, always pull directly on the plug, never yank the cord.
- Do not attempt to clean the unit with chemical solvents or it may damage the finish. Use a clean, dry cloth.

Before connection

Turn off the power of all the component before making connections.
Read the owner's manual of each component you intend to use with this unit.
Read this before operation

Symbol Used in this Manual

Note

Indicates special notes and operating features.

Tip

Indicates tips and hints for making the task easier.

Required cables

The hookup diagrams on the subsequent pages assume the use of the following connection cables.

You must purchase the connection cables separately if necessary.

AUDIO Analog audio cable

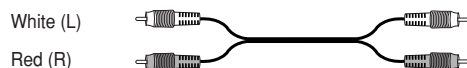

A/V Analog audio/Composite video cable

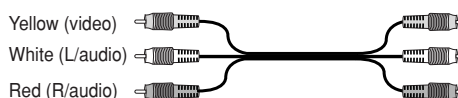

VIDEO Composite video cable



Optical Optical digital audio cable



COAXIAL Coaxial digital audio cable



COMPONENT Component video cable

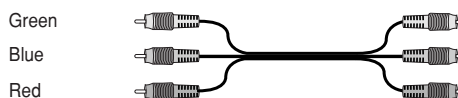

HDMI HDMI cable



USB USB cable

USB cable for PC connection



USB cable for MP3 Player (or Memory Card Reader, etc.)



LINE LINE IN cable



Notes

- Turn off the power to all components before making any connections.
- When connecting an audio/video cable, be sure to match the color-coded pins to the appropriate jacks on the components: yellow (video) to yellow; white (left, audio) to white; and red (right, audio) to red.
- When connecting optical digital cables, insert the cable plugs straight in until they click into place.
- Do not bend or tie optical digital cables.

Front Panel

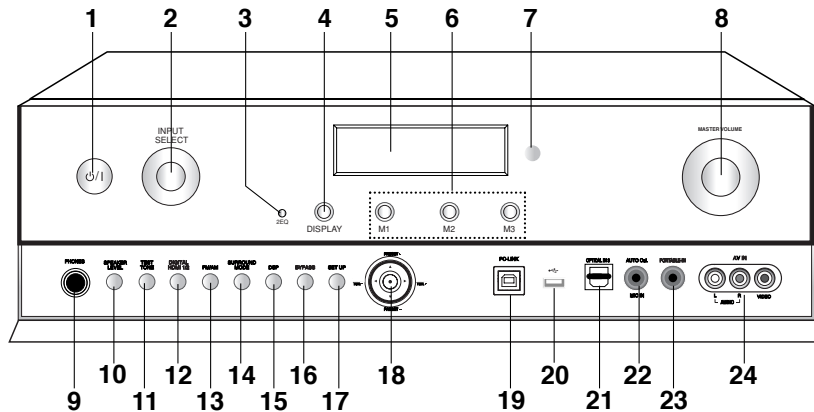

1. **POWER (⏻)**
Sets the unit to On and Standby.
2. **INPUT SELECT**
Select the input source.
Turn this knob until the input source you want appears in the display window.
3. **AUDYSSEY (2EQ) LED indicator**
Lights up when Audyssey 2EQ is active.
4. **DISPLAY**
Displays various information about the currently selected input source.
5. **Display window**
6. **M1, M2, M3**
Loads and stores various settings on this buttons you set at one time.
7. **Remote sensor**
Receives control signals from the remote control.
8. **MASTER VOLUME**
Adjusts the volume of the unit to MIN (-70.0dB) through MAX (+10.0dB).
9. **PHONES connector**
Connect a stereo headphone plug (∅ 6.3 mm) to PHONES connector for private listening.
10. **SPEAKER LEVEL**
Adjusts the level of each speaker.
11. **TEST TONE**
Checks the position and sound balance of speakers in the following order.
(Front left speaker → Center speaker → Front right speaker → Surround right speaker → Surround center speaker → Surround left speaker → Subwoofer)
12. **DIGITAL HDMI 1/2**
Selects the input mode (ANALOG, COAXIAL, OPTICAL 1/2/3).
Selects HDMI 1 or HDMI 2 on the HDMI mode.
13. **FM/AM**
Selects the unit's tuner (FM and AM bands).
14. **SURROUND MODE**
Selects various surround effect.
15. **DSP (Digital Signal Processor)**
Selects DSP (Digital Signal Processor) mode.
16. **BYPASS**
Selects BYPASS mode.
17. **SETUP**
Accesses or removes the setup menu.
18. **◀/▶/▲/▼ (left/right/up/down)**
Selects an item in the menu.
● (ENTER)
Acknowledges the menu selection.
PRESET (-/+)
Selects preset number of radio.
TUN. (-/+)
Tunes in the desired radio station.
19. **PC-LINK**
Connect a USB port of PC.
20. **USB port**
Connect a USB port of USB device.
21. **OPTICAL IN3**
Connect a component with digital audio output jacks.
22. **AUTO Cal.**
Sets the speaker setup automatically.
- MIC IN**
The included speaker setup microphone (∅ 3.5 mm) is connected here for automatic speaker setup.
23. **PORTABLE-IN (3.5 ∅)**
Connect a portable component.
24. **AV IN (AUDIO L/R, VIDEO)**
Connect the components with analog audio/video output jacks (camcorder, game console, etc).

Rear Panel

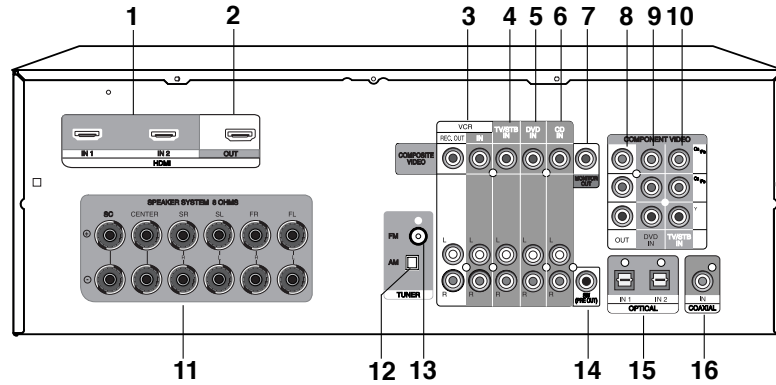

- 1. HDMI IN 1/2**
Connect the component with HDMI output.
- 2. HDMI OUT**
Connect a TV or component with HDMI input.
- 3. VCR IN/VCR REC. OUT**
Connect a VCR.
- 4. TV/STB IN**
Connect a TV, satellite tuner or set-top box.
- 5. DVD IN**
Connect a DVD player to DVD IN jacks.
- 6. CD IN**
Connect a CD player or Super Audio CD player to CD IN jacks.
- 7. MONITOR OUT**
Connect to a video input on your TV or projector.
- 8. COMPONENT VIDEO OUT**
Connect a TV or projector to COMPONENT VIDEO OUT jacks.
- 9. COMPONENT VIDEO DVD IN**
Connect a DVD player with component video out jacks to COMPONENT VIDEO DVD IN jacks.
- 10. COMPONENT VIDEO TV/STB IN**
Connect a satellite tuner or set-top box, etc with component video out jacks to COMPONENT VIDEO TV/STB IN jacks.
- 11. SPEAKER SYSTEM**
Connect the speakers.
- 12. AM ANTENNA**
Connect an AM antenna.
- 13. FM ANTENNA**
Connect a FM antenna.
- 14. SW (PRE OUT)**
Connect the active subwoofer.
- 15. OPTICAL IN 1/2**
Connect CD and DVD player, and other components with an optical digital audio output.
- 16. COAXIAL**
Connect CD and DVD player, and other components with a coaxial digital audio output.

Notes

- The VCR IN video signal is not outputted to the VCR REC. OUT but outputted to the MONITOR OUT. However, The VCR IN audio signal can be outputted to the VCR REC. OUT.
- Don't connect a TV or MONITOR to HDMI 1/2 jacks. The unit may malfunction.

Active Subwoofer

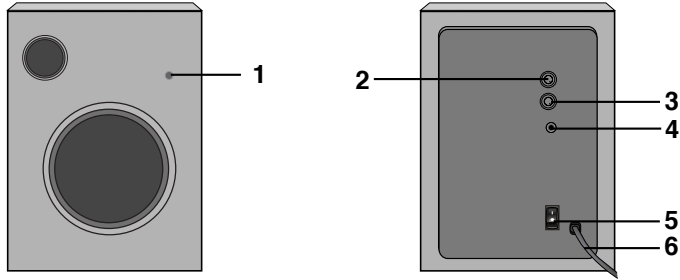

1. LED indicator

The RED lights when active subwoofer does not receive a input for about 10 minutes. (Standby mode.)

The BLUE lights when active subwoofer is receiving a input.

2. Adjusting Volume (MIN - MAX)

Turn VOLUME dial clockwise/counterclockwise to increase or decrease the sound level.

3. Frequency Controller (70Hz - 180Hz)

Turn HIGHCUT dial clockwise/counterclockwise to adjust the frequency.

4. INPUT

Connect the unit's SW(PRE OUT) to INPUT of active subwoofer.

5. Power Switch

When pressing the upper part of this switch, the Power is ON. Pressing the lower part turns OFF the power.

6. Power Cord

Note

AR702NS model does not supply the active subwoofer.

Display window

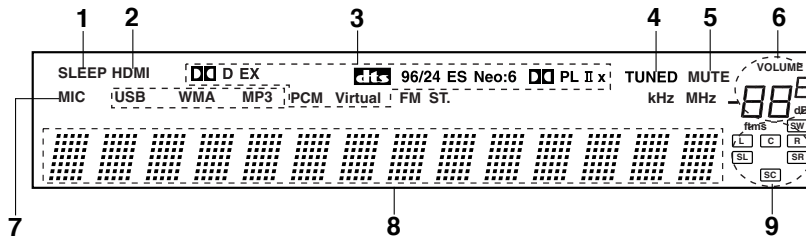

1. SLEEP indicator

Lights up when the Sleep function has been set.

2. HDMI indicator

Lights up when the HDMI function has been set.

3. Listening mode & format indicators

These indicators show the currently selected listening mode and the format of digital input signals.

4. TUNED indicator

Lights up when the unit is tuned into a radio station.

5. MUTE indicator

Flashes while the unit is muted.

6. VOLUME indicator

Displays the level of volume.

7. MIC indicator

Lights up when the unit is connect to MIC IN connector.

8. Message area

Shows various information about the currently selected source.

9. Speaker indicators

Displays the front, center, surround, surround center, and subwoofer.

Remote Control

Remote control operation range

Point the remote control at the remote sensor and press the buttons.

- Distance: About 23 ft (7 m) from the front of the remote sensor
- Angle: About 30° in each direction in front of the remote sensor

Remote control battery installation

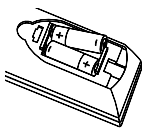

Remove the battery cover on the rear of the remote control, and insert two R06 (size AA) batteries with \oplus and \ominus aligned correctly.

Notes

- Do not mix old and new batteries. Never mix different types of batteries (standard, alkaline, etc.).
- If you intend not to use the remote control for a long time, remove the batteries to prevent damage from leakage or corrosion.
- Expired batteries should be removed as soon as possible to prevent damage from leakage or corrosion.

About the remote control modes

The remote control can be used to control up to ten different components. The remote control has a specific operating mode for use with each type of component. Modes are selected by using the four RECEIVER, DVD, VCR, and TV buttons on the remote control.

1. Press RECEIVER, DVD, VCR, or TV buttons to select a mode.

RECEIVER

In RECEIVER Mode, you can control the unit.

DVD

In DVD Mode, you can control DVD player.

VCR

In VCR Mode, you can control VCR.

TV

In TV Mode, you can control TV.

2. Use the buttons supported by that mode to control the component.

Note

Some of the remote control operations may not work as expected with other components.

RECEIVER Mode **RECEIVER**

To set the remote control to RECEIVER mode, press RECEIVER.

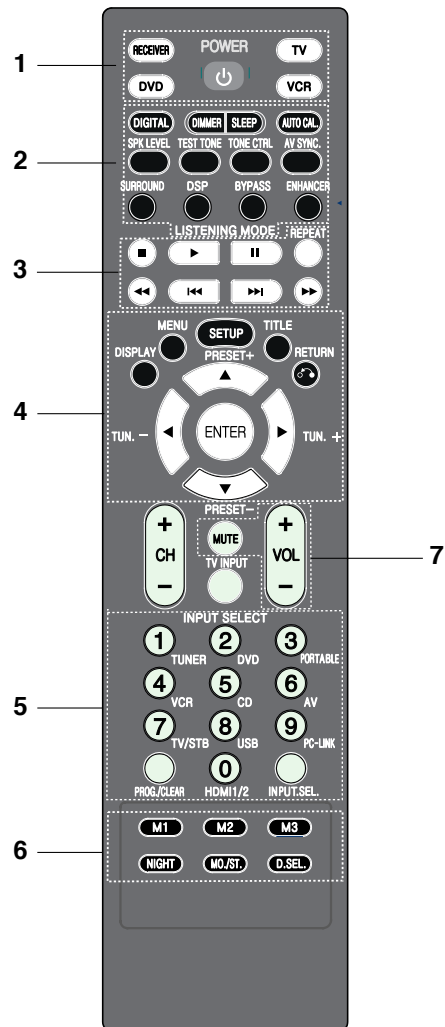

1. POWER ()

Switches the unit ON and OFF.

RECEIVER/DVD/TV/VCR

To operate the desired function with this remote control, select the corresponding the buttons.

2. DIGITAL

Press this button to assign one of the digital inputs to a source.

Selects HDMI 1 or HDMI 2 on the HDMI mode.

DIMMER

Press this button to adjust the brightness of the display window.

SLEEP

Press this button to set the sleep timer.

AUTO CAL.

Starts Audyssey 2EQ automatic speaker setup; and turns Audyssey 2EQ On and Off when setup has been performed.

SPK LEVEL

Adjusts the speaker level from -10dB to +10dB.

TEST TONE

Checks the position and sound balance of speakers in the following order.

TONE CTRL

Controls the BASS, MIDDLE, and TREBLE.

AV SYNC.

Adjusts the Audio Delay.

LISTENING MODE**- SURROUND**

Selects various surround effect.

- DSP (Digital Signal Processor)

Selects DSP (Digital Signal Processor) mode.

- BYPASS

Selects BYPASS mode.

- ENHANCER

Enhances the sound quality of compressed input signal.

3. USB mode only**- STOP (■)**

Stops playback.

- PLAY (▶)

Starts playback.

- PAUSE(⏸)

Pauses playback temporarily.

- REPEAT

Repeats track.

- SKIP (◀◀/▶▶)

Moves to the next or previous track.

4. DISPLAY

Accesses On-Screen display.

MENU

Access the menu on a disc.

SETUP

Accesses or removes setup menu.

TITLE

Displays the disc's title menu, if available.

RETURN

Returns to the previous menu.

◀▶/▲▼ (left/right/up/ down)

Selects an option in the menu.

ENTER

Acknowledges the menu selection.

PRESET (-/+)

Selects program of Radio.

TUN. (-/+)

Tunes in the desired radio station.

5. 0-9 numerical buttons

Selects numbered options in a menu.

INPUT SELECT buttons

- TUNER : Selects an FM or AM broadcast

- DVD : Selects a DVD mode.

- PORTABLE : Selects a POTABLE mode.

- VCR : Selects a VCR mode.

- CD : Selects a CD mode.

- AV : Selects an AV mode.

- TV/STB : Selects a TV/STB mode.

- USB : Selects an USB mode.

- PC-LINK : Selects a PC-LINK mode.

PROG./CLEAR

Stores a radio station's frequency in the tuner's memory.

HDMI1/2

Switches the HDMI mode to HDMI 1 and HDMI 2.

INPUT.SEL.

Selects the input settings.

6. M1, M2, M3

Loads and stores various settings on this buttons you set at one time.

NIGHT

Reduces the dynamic range of Dolby Digital material so that you can still hear quiet parts even when listening at low volume levels

MO./ST.

Selects the mono or stereo during receiving a FM broadcast.

D.SEL

Selects a card on the USB mode in case that more than one memory cards are connected to the USB port.

7. MUTE

Mutes the sound.

VOLUME (-/+)

Adjusts the volume.

DVD Mode **DVD**

To set the remote control to DVD mode, press DVD.

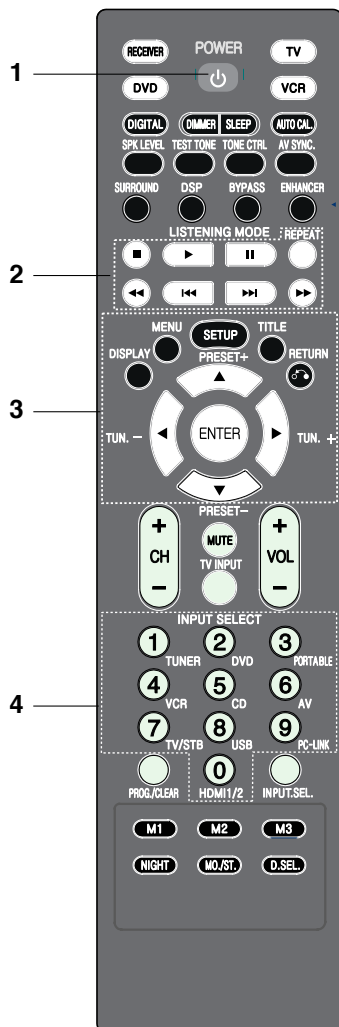

- 1. POWER (⏻)**
Switches the unit ON and OFF.
- 2. STOP (■)**
Stops playback.
PLAY (▶)
Starts playback.
PAUSE(⏸)/STEP
Pauses playback temporarily. Press this button repeatedly to play Frame-by-Frame.
REPEAT
Repeats chapter, track, title or all.
SCAN(◀▶)
Searches backward or forward.
SKIP(◀◀▶▶)
Moves to the next or previous chapter or track.
- 3. DISPLAY**
Accesses On-Screen display.
MENU
Access the menu on a disc.
SETUP
Accesses or removes setup menu.
TITLE
Displays the disc's title menu, if available.
RETURN
Returns to the previous menu.
◀▶/▲▼ (left/right/up/ down)
Selects an option in the menu.
ENTER
Acknowledges the menu selection.
- 4. 0-9 numerical buttons**
Selects numbered options in a menu.

VCR Mode **VCR**

To set the remote control to VCR mode, press VCR.

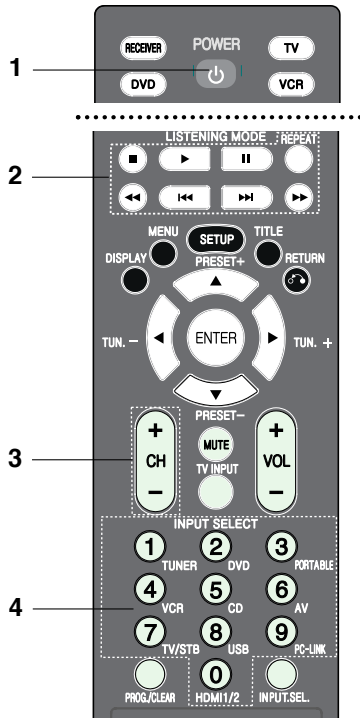

- 1. POWER (⏻)**
Switches the unit ON and OFF.
- 2. STOP (■)**
Stops playback.
PLAY (▶)
Starts playback.
PAUSE(⏸)/STEP
Pauses playback temporarily. Press this button repeatedly to play Frame-by-Frame.
SCAN (◀▶)
Searches backward or forward.
- 3. CH (-/+)**
Selects the channel.
- 4. 0-9 numerical buttons**
Selects numbered options in a menu.

TV Mode **TV**

To set the remote control to TV mode, press TV.

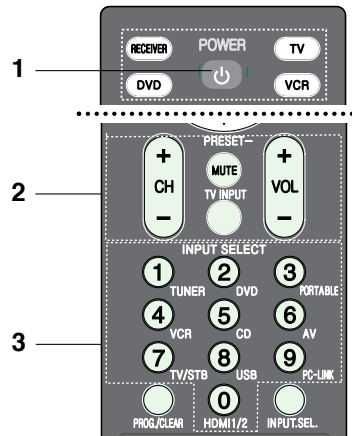

- 1. POWER (⏻)**
Switches the unit ON and OFF.
- 2. CH (-/+)**
Selects the channel.
MUTE
Mutes the sound.
TV INPUT
Selects the TV's source.
VOLUME (-/+)
Adjusts the volume.
- 3. 0-9 numerical buttons**
Selects numbered options in a menu.

Controlling the TV

You can control the channel, sound level, input source, and power switch of your LG TV with the supplied Remote Control.

Setting Remote Control Codes for LG TV

- Hold POWER (⏻) and press CH (-/+) button repeatedly until the TV on or off.
- The POWER (⏻), CH (-/+), VOLUME (-/+), numerical buttons and TV INPUT buttons on remote control can operate the LG TV.

Note

If the remote control does not operate your particular TV, try the other code or use the remote control originally supplied with the LG TV. (LG and Gold Star)
Due to the variety of codes used by manufacturers, OUR COMPANY cannot guarantee that the remote control will operate every LG TV model.

Installation

Connecting components with digital audio output jacks

Connecting a DVD player (or Digital device), TV monitor or satellite tuner (or Set top box etc.)

1. **Connect the audio jacks.**
For details of the required cables, see the page 4.

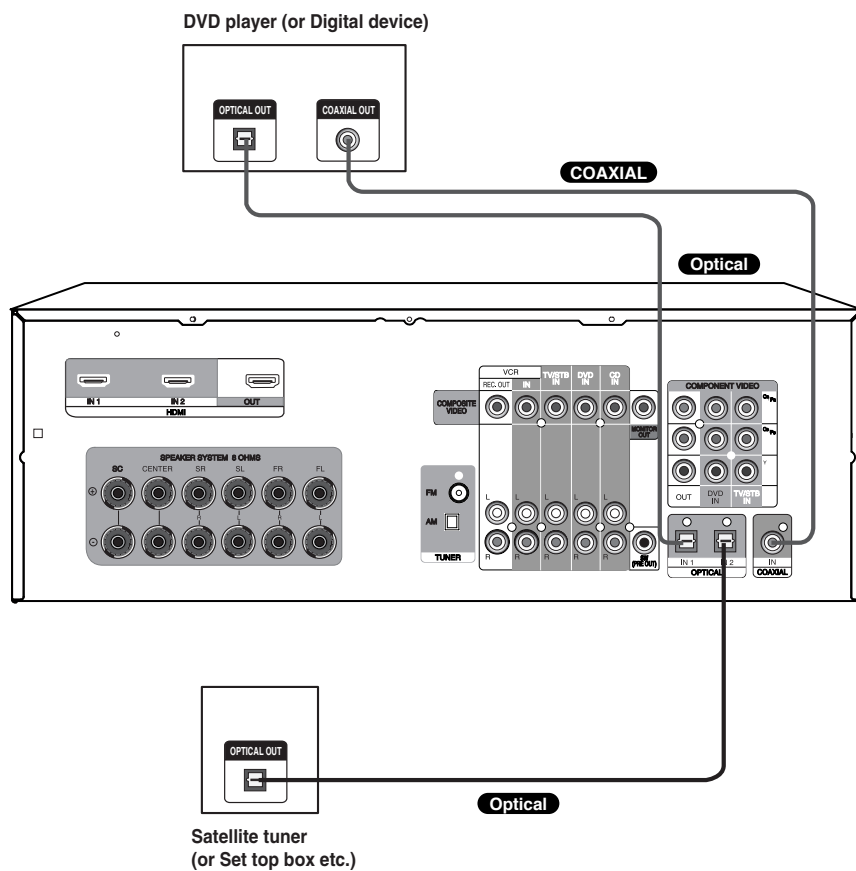

Notes

- You can also connect the device to OPTICAL IN 3 jack on the front panel
- Connect to either the DVD COAXIAL IN or DVD OPTICAL IN 1 jack.
- You can listen to the sound of your TV by connecting your TV's audio output jacks to the TV/STB AUDIO IN jacks on the unit. In this case, do not connect the TV's video output jack to the COMPOSITE VIDEO (TV/STB) IN jack on the unit.

2. Connect the video jacks.

For details of the required cables, see the page 4.

The following illustration shows how to connect a TV or satellite tuner (Set top box, etc) and a DVD player with COMPONENT VIDEO (Y, Cb/Pb, Cr/Pb) output jacks.

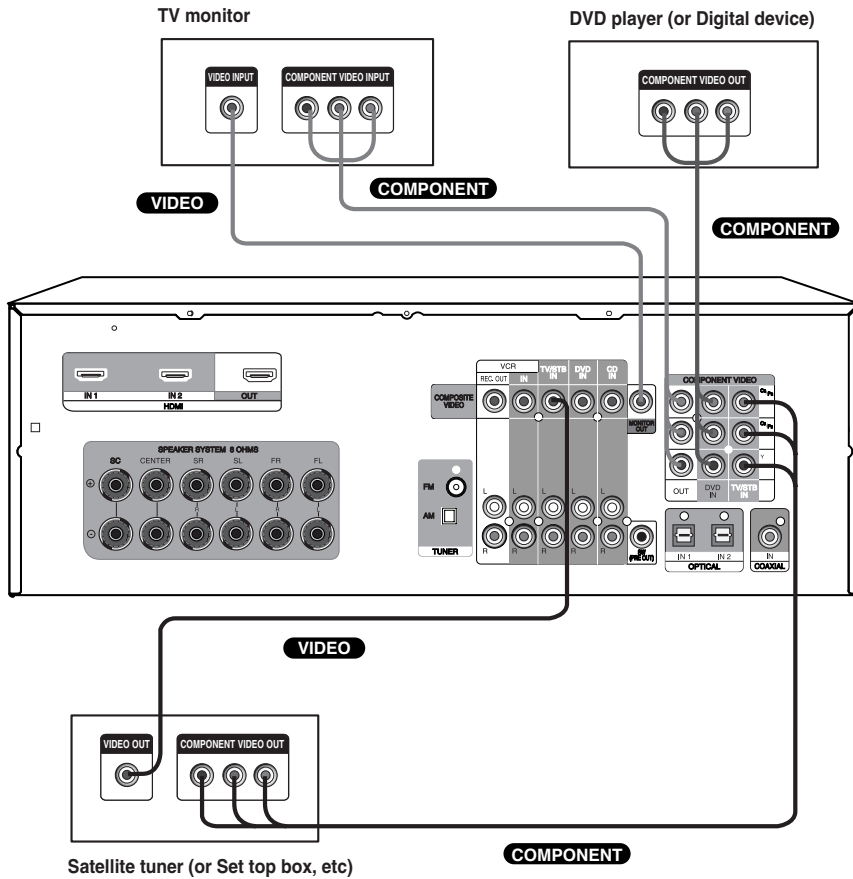

3. Select the input source to play the component.

For details, see the page 25.

Note

Connect to either the COMPOSITE VIDEO OUT or COMPONENT VIDEO OUT jacks.

Connecting components with analog audio jacks

Connecting audio components

1. Connect the audio jacks with analog audio cable.
For details of the required cables, see the page 4.

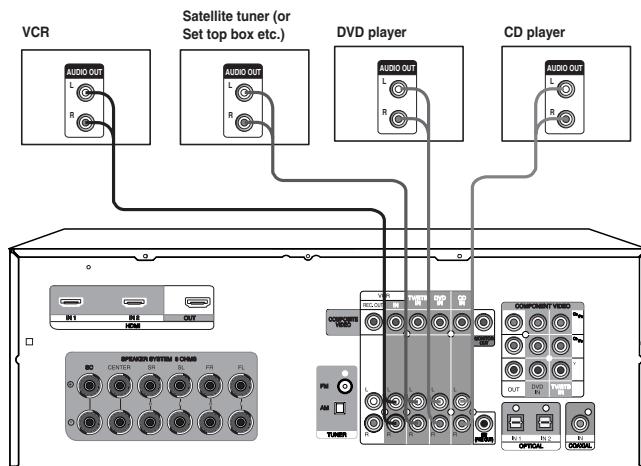

2. Connect the video jacks with composite video cable.
For details of the required cables, see the page 4.

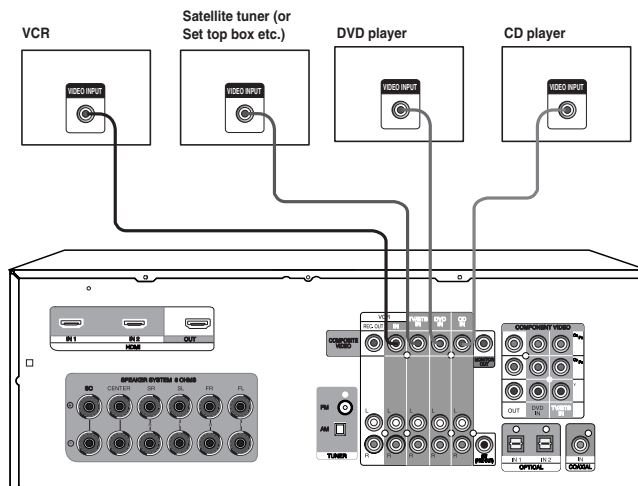

3. Select the input source to play the component.
For details, see the page 25.

Connecting a camcorder or game console

1. **Connect the audio and video jacks.**
For details of the required cables, see the page 4.

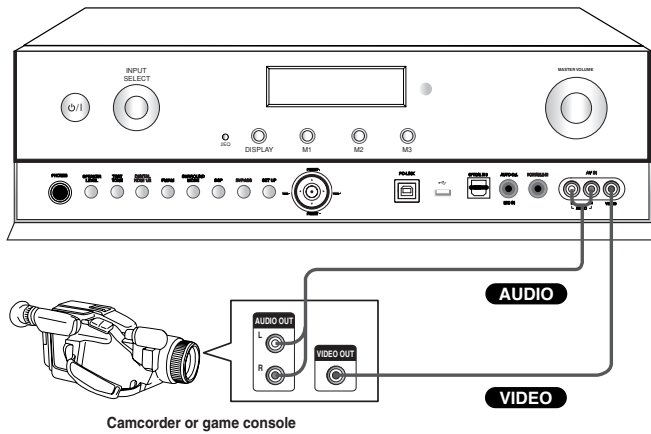

2. **Connect the unit's MONITOR OUT jack to the TV's VIDEO IN jack with composite video cable.**
For details of the required cables, see the page 4.

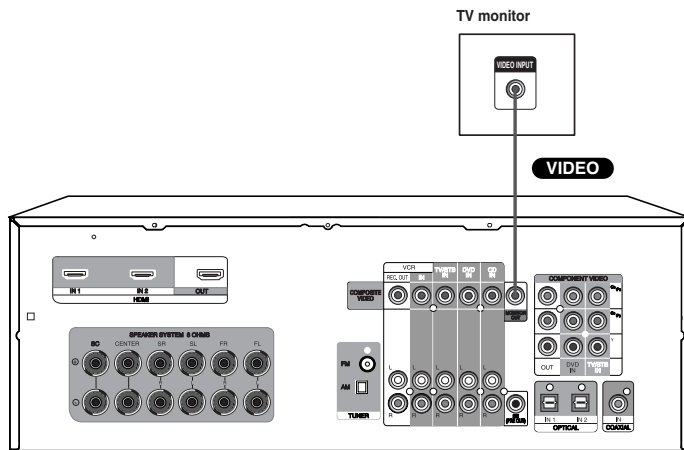

3. **Select the input source to play the component.**
For details, see the page 25.

Connecting PC, Portable device, or USB device

For details of the required cables, see the page 4.

Select the input source to play the component after connecting.

- For details, see the page 25.

PC-LINK Connection (P)

Connect the unit's PC-LINK jack to the corresponding jack of PC with USB cable.

Portable device Connection (L)

Connect the unit's PORTABLE-IN jack to the corresponding jack of portable device with mini stereo (3.5mm) cable.

USB connection (U)

Connect the unit's USB port to the USB port of USB Memory (or MP3 player, etc.).

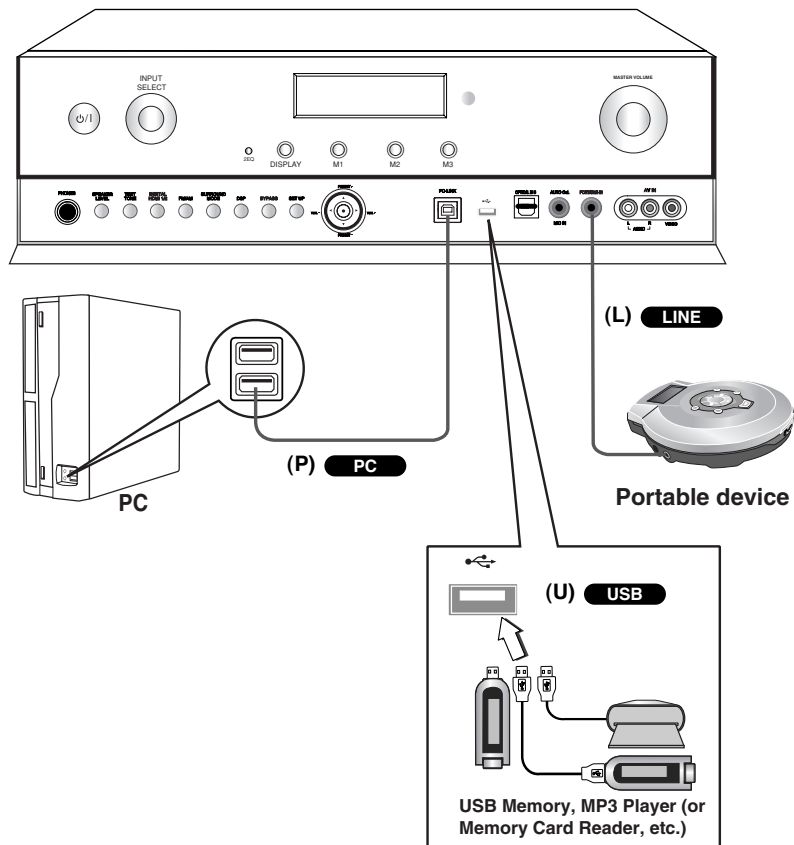

Connecting video components for Playback

1. **Connect the audio jacks.**
For details of the required cables, see the page 4.
2. **Connect the video jack and then connect your TV to the MONITOR OUT jack.**
You can watch the video from the selected input.

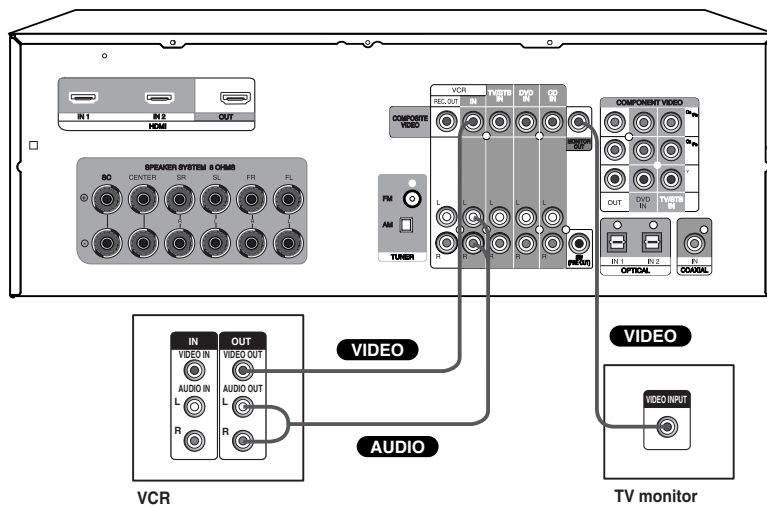

3. **Select the input source to play the component.**
For details, see the page 25.

Note

The VCR IN video signal is not outputted to the VCR REC. OUT but outputted to the MONITOR OUT. However, The VCR IN audio signal can be outputted to the VCR REC. OUT.

Connecting video components for Recording

This section explains how to connect a VCR for recording from a TV or another VCR.

1. Connect the unit's VCR REC. OUT jack to a video input on the recording VCR.
2. Connect the unit's VCR REC. OUT L/R jacks to an audio input L/R on the recording VCR.
3. Connect the unit's TV/STB IN, DVD IN, CD IN, or AV IN jack to a device with video output.
4. Connect the unit's TV/STB IN, DVD IN, CD IN, or AV IN L/R jacks to a device with audio output.

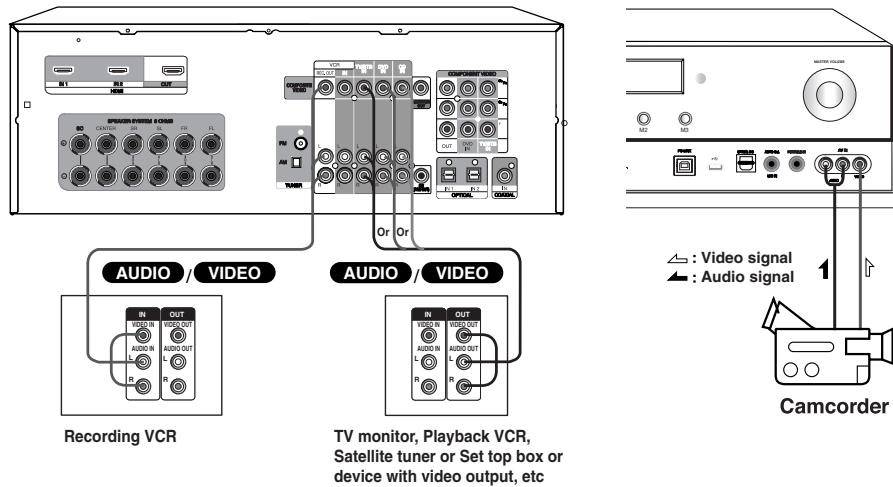

Playback from the Recording VCR

To play back a video in the recording VCR via the unit:

1. Connect the unit's VCR IN jack to a video output on the recording VCR.
2. Connect the unit's VCR IN L/R jacks to an audio output on the recording VCR.
2. Connect the unit's MONITOR OUT jack to a video input jack on the TV.

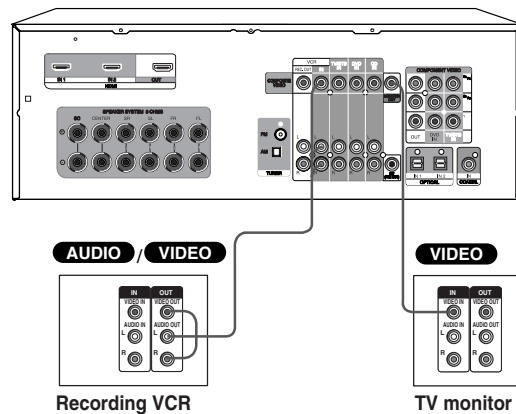

Notes

- The unit must be turned on for recording. Recording is not possible while it's in Standby mode.
- If you want to record directly from your TV or playback VCR to the recording VCR without going through the unit, connect the TV/VCR's audio and video outputs directly to the recording VCR's audio and video inputs. See the manuals supplied with your TV and VCR for details.
- Video signals connected to video inputs can only be recorded via video outputs. If your TV/VCR is connected to a composite video input, the recording VCR must be connected to a composite video output.

Connecting TV or components with HDMI jack

HDMI (High Definition Multimedia Interface) supports both video and audio on a single digital connection for an easy all-digital output to an HDMI or DVI-equipped TV.

Connection to an HDMI TV requires an HDMI cable while connection a DVI-equipped TV requires a DVI adapter besides a HDMI cable.

HDMI has the capability to support standard, enhanced, or high-definition video plus standard to multi-channel surround-sound audio, HDMI features include uncompressed digital video, a bandwidth of up to 5 gigabyte per second, one connector (instead of several cables and connector), and communication between the AV source and AV devices such as DTVs.

HDMI, the HDMI logo and High-Definition Multimedia Interface are trademarks or registered trademarks of HDMI licensing LLC.

If you have a HDMI TV or monitor, you can connect it to this unit with a HDMI cable.

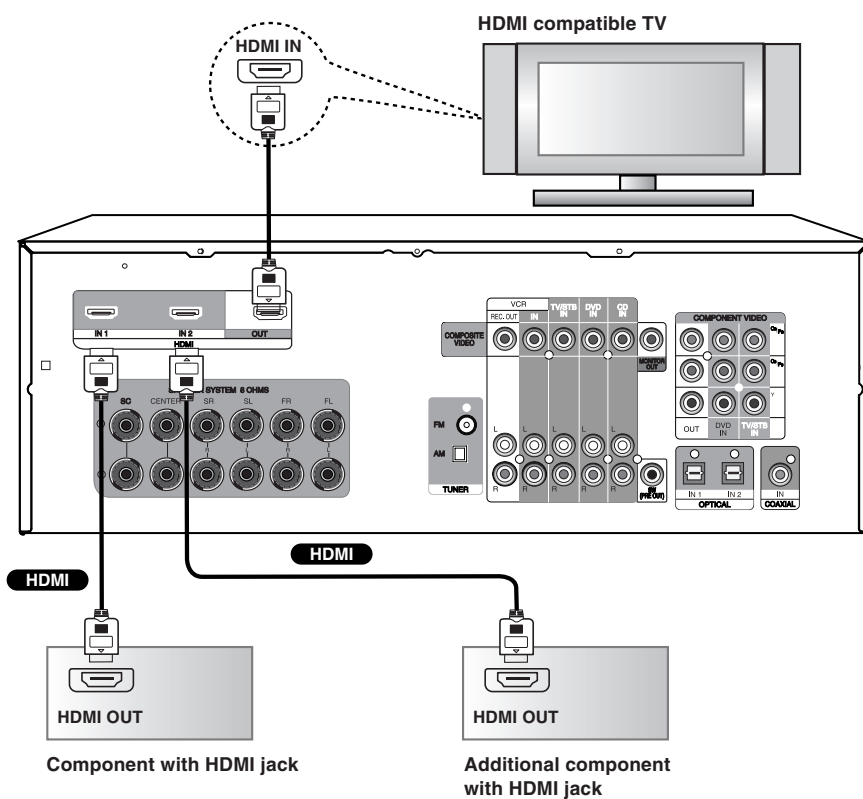

Notes

- The arrow on the cable connector body should face up for correct alignment with the connector on the unit.
- Don't connect a TV or MONITOR to HDMI 1/2 jacks. The unit may malfunction.
- When the multi channel input is used, the real output may be different from the speaker indicators that appear in display window. (Multi channel : A mode that can be inputted and outputted up to 6.1ch.)

Connecting the antennas

Connect the supplied AM loop antenna and FM wire antenna.

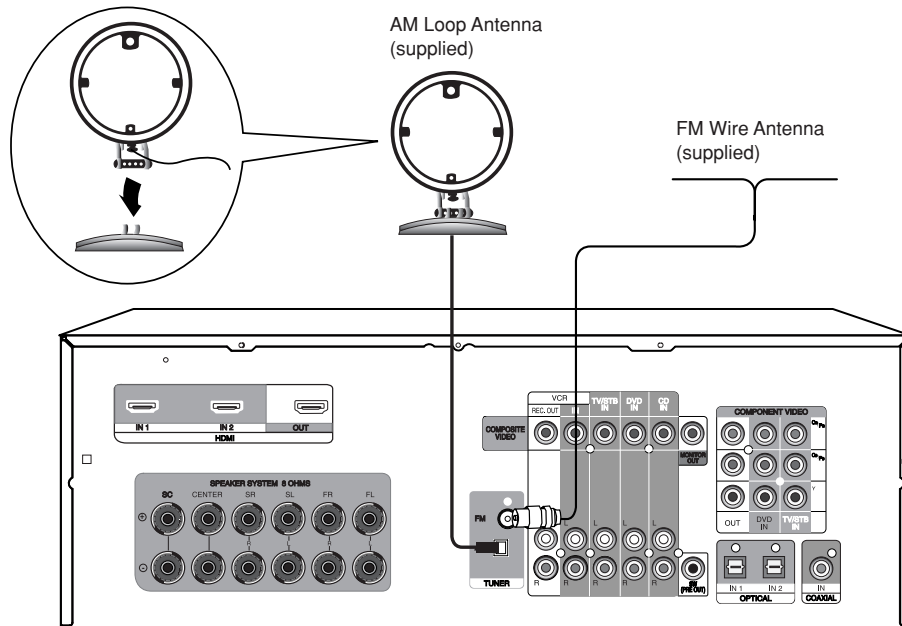

Notes

- To prevent noise pickup, keep the AM Loop antenna away from the unit and other components.
- Be sure to fully extend the FM wire antenna.
- After connecting the FM wire antenna, keep it as horizontal as possible.

Connecting speakers

The unit allows you to use 6.1 channel system.

The ideal surround speaker system for this unit is 6-speaker systems, using front left and right speakers, a center speaker, surround left and right speakers, surround center speaker, and a subwoofer.

You can enjoy high fidelity reproduction of DVD software recorded in the Surround EX format if you connect the surround center speaker (6.1 channel).

For best results we recommend that all front speakers be of the same type, with identical or similar driver units. This the action moves from side to side.

Your center channel speaker is very important as over 80 % of the dialog from a typical motion picture emanates from the center channel. It should possess similar sonic characteristics to the main speakers. Surround channel speakers need not be identical to the front channel speakers, but they should be of high quality.

The surround center speaker is useful for playback of Dolby Digital Surround EX or DTS-ES. One of the benefits of both Dolby Digital and DTS is that surround channels are discrete full range, while they were frequency limited in earlier "Pro Logic" type systems.

Bass effects are an important part of home theater.

For optimal enjoyment a subwoofer should be used as it is optimized for low frequency reproduction.

Example of 6.1 channel speaker system configuration

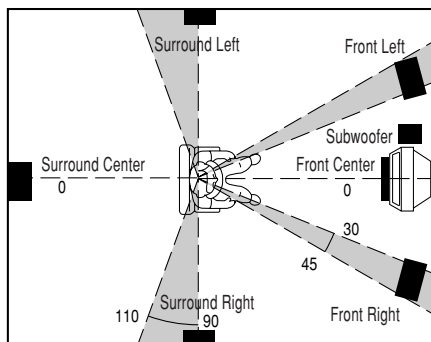

Front left and right speakers

These output the overall sound. Their role in a home theater is to provide a solid anchor for the sound image. They should be positioned facing the listener at about ear level, and equidistant from the TV. Angle them inward so as to create a triangle, with the listener at the apex.

Center speaker

This speaker enhances the front left and right speakers, making sound movements distinct and providing a full sound image. In movies it's used mainly for dialog.

Position it close to your TV (preferably on top) facing forward at about ear level, or at the same height as the front left and right speakers.

Surround left and right speakers

These speakers are used for precise sound positioning and to add realistic ambience. Position them at the sides of the listener, or slightly behind, about 2–3 feet (60–100 cm) above ear level. Ideally they should be equidistant from the listener.

Surround center speaker

Surround center speaker is required when a full 6.1-channel system is installed.

This speaker is necessary to enjoy Dolby Digital EX, DTS-ES Matrix, and DTS-ES Discrete. They enhance the realism of surround sound and improve sound localization behind the listener. Position them behind the listener about 2–3 feet (60–100 cm) above ear level.

Subwoofer

The subwoofer handles the bass sounds of the LFE (Low-Frequency Effects) channel.

The volume and quality of the bass output from your subwoofer will depend on its position, the shape of your listening room, and your listening position. In general, a good bass sound can be obtained by installing the subwoofer as shown left.

Tip

To find the best position for your subwoofer, while playing a movie or some music with good bass, experiment by placing your subwoofer at various positions within the room, and choose the one that provides the most satisfying results.

Speaker System Connection

For the best surround sound, you should connect 6 speakers and/or a powered subwoofer. Connect the your front, center, surround, surround center speakers, and subwoofer by using the speaker wires. Using a suitable cable, connect the SW (PRE OUT) to an input on optional powered subwoofer, as shown below.

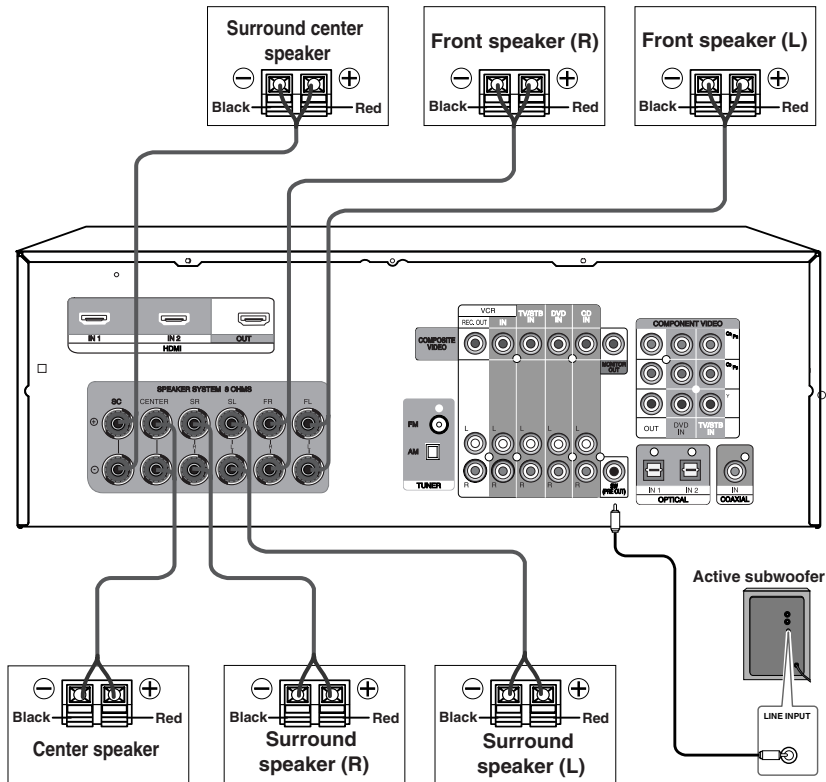

Notes

- Turn the unit off before connecting the speakers wires.
- Be sure to match the speaker wire to the appropriate terminal on the components: + to + and - to -. If the cables are reversed, the sound will be distorted and will lack bass.
- Be sure to use speakers with the specified impedance as shown on the rear panel of this unit.
- Do not touch the speaker terminals when the power is on. It may cause you to receive an electric shock.
- AR702NS model does not supply the speakers. If necessary, be sure to use speakers with the specified impedance as shown on the rear panel of the unit.

Connecting speaker wire

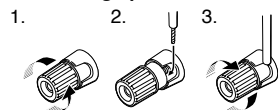

1. Loosen the knob by turning it counterclockwise.
2. Insert the bare part of the wire into the hole in side of each terminal.
3. Tighten the knob by turning it clockwise to secure the wire.

Operation

Turning On the unit

Before connecting the power cord, connect all your speakers and AV components.

1. **Plug the power cord into an AC wall outlet.**
2. **Press the POWER (⏻ or ⏻) button.**
The unit turns on, the display window lights up.

To turn off the unit, press the POWER (⏻ or ⏻) button.

The unit will enter the Standby mode.

Using Headphones

You can connect a pair of stereo headphones (6.3 ϕ phone plug) to the unit's PHONES jack for private listening.

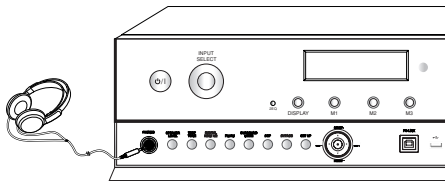

Notes

- Always turn down the volume before connecting your headphones.
- The speakers are turned off while the headphones plug is inserted in the PHONES jack.

Audyssey 2EQ Automatic Speaker Setup

With the bundled speaker setup microphone (ϕ 3.5mm), the Audyssey 2EQ Automatic Speaker Setup function automatically calculates the size, level, distance, bass management crossover frequency, and optimal settings for each speaker at the listening position. Audyssey 2EQ also corrects acoustical distortions within the listening area.

Before using this function, connect and position all your speakers.

Notes

- Set the volume of subwoofer between middle and maximum before the automatic speaker setup.
- When positioning the microphone, use a tripod or stand at ear height with the microphone pointing directly up. It is not recommended to place the microphone on the back of the couch or recliner, or held by the hand. Be sure that the path from microphone to the speakers is not blocked by objects. Avoid placing the microphone close to a seat back or wall as sound reflections may cause adverse results.
- Make sure the environment is quiet before starting the Audyssey 2EQ automatic speaker setup. Turn off air conditioning units if possible.
- Loud test sounds will occur during Audyssey 2EQ Automatic Speaker Setup. This is part of normal operation.
- The Audyssey test sound may be louder than the typical playback level. This is required so that the measurements overcome any background noise in the room.

1. **Connect the speaker setup microphone to the MIC IN jack, and position it in the main listening position.**

"MIC IN" appears in the display window.

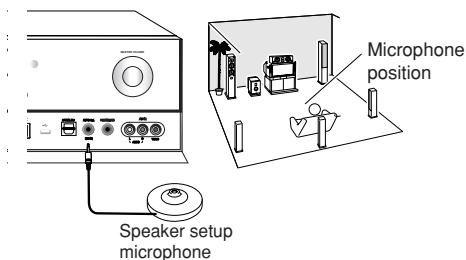

2. Press AUTO CAL..

"Audyssey 2EQ", "AUTO CAL. : START" and "AUTO CAL. : 1ST-P" flash in the display window in turn.

3. Press ENTER.

- "FL TESTING.." appears in the display window.
- The speaker setup function is automatically measured in the first position from each speaker. FL TESTING..→C TESTING..→FR TESTING..→SR TESTING..→SC TESTING..→SL TESTING..→SW TESTING..
- After completed, the "► 2nd-POS CAL." appears in the display window.

Notes

- If each speaker is not connected, "CONNECT SPK" flashes in the display window.
- If the speaker setup microphone is not connected, "CONNECT MIC" appears in the display window.

4. Measure a second position (recommended) or calculate results for first position only. Select "► 2nd-POS CAL." or "2nd-POS ►CAL." by pressing ◀/▶.

"► 2nd-POS CAL.": (Recommended) Selecting this option will measure a second listening position for each speaker and will produce the best correction results. Please place the microphone at ear height in a secondary listening position, such as in a seat next to the first one that was measured.

"2nd-POS ►CAL.": Selecting this option will proceed with the calculation using the first listening position measurement only.

5. Select ENTER.

If you select the "► 2nd-POS CAL.", the audyssey 2EQ automatic speaker setup is measured on the second position. After completed, "CALIBRATING..." appears for about 2 minutes in the display window. If you select the "2nd-POS ►CAL.", "CALIBRATING..." appears for about 2 minutes in the display window.

6. Check the result value of speaker size, level, distance and X-OVER by pressing ◀/▶/▲/▼, ENTER.

You can only check the result values of the first position.

Notes

- If the result values of subwoofer is "NONE", the FRONT LR of SPK TYPE on the SETUP menu are automatically set to "LARGE".
- The result values of the second position is not measured the result value of speaker size, level, distance and X-OVER but an optimum sound.

7. When "RESULT►NO OK" appears in the display window, select the "RESULT NO►OK" by pressing ◀/▶ and then select ENTER.

- The unit will automatically enter the Standby mode.
- Selecting "RESULT►NO OK" will restart the Audyssey 2EQ Automatic Speaker Setup. The previous measurements will be discarded.

8. Turn Audyssey 2EQ On or Off.



- Press AUTO CAL. on the remote control to turn Audyssey 2EQ acoustical correction on or off.

Notes

- Press AUTO CAL. for about 2 seconds to begin the Audyssey 2EQ automatic speaker setup again.
- If you want to cancel during the automatic speaker setup process, press AUTO CAL. The "EXIT? > No Yes" appears in the display window. Then select "YES" by pressing ◀/▶ and then press ENTER.
- If there is excessive noise during automatic speaker setup. "SPK NOISE" appears in the display window. Quiet the environment and begin the Audyssey 2EQ automatic speaker setup again.
- Disconnect the speaker setup microphone after automatic speaker setup.

Selecting the input source

This section explains how to select the input source (i.e., the AV component that you want to listen to or watch).

1. Press **POWER** ( or ) to turn the unit on.
2. Select a source by rotating the **INPUT SELECT** on the front panel.

The selected source appears in the display window.

To select the	Display
Built-in tuner	Tuner or frequency
DVD player	DVD
Portable player	Portable
VCR	VCR
CD or Super Audio CD player	CD
Camcorder or TV game	AV
Satellite tuner	TV/STB
USB device	USB
PC	PC-LINK
Component with HDMI jack	HDMI 1/ HDMI 2

To select the required input source using the remote control you must ensure that the remote is in the receiver mode. This can be verified by pressing the **RECEIVER** button until it can be seen illuminated. Once in the receiver mode simply press the **INPUT. SEL.** button until it is lit and then press the numerical key that corresponds with the desired input. Subsequent presses of the numerical keys will also switch to the input shown on the remote. To cancel this function simply press the **INPUT. SEL.** button again until it is not illuminated.

To select the	Press the	Display
Built-in tuner	TUNER button repeatedly.(①)	Tuner or frequency
DVD player	DVD button.(②)	DVD
Portable player	PORTABLE button.(③)	Portable
VCR	VCR button.(④)	VCR
CD	CD button.(⑤)	CD
Camcorder or TV game	AV button.(⑥)	AV
Satellite tuner	TV/STB button.(⑦)	TV/STB
USB device	USB button.(⑧)	NO USB
PC	PC-LINK button.(⑨)	PC-LINK
Component with HDMI jack	HDMI1/2 button.(⑩)	HDMI1/HDMI2

3. Turn on the component and start playback.
4. To adjust the volume, rotate the **MASTER VOLUME** on the front panel, or press **VOLUME (-/+)** on remote control.

Selecting the input mode

If you connect a component to a digital input jack, you must assign that jack to an input source.

1. Select the input source that you want to assign.
Some of input sources may not be assigned.
2. Press **DIGITAL**.
The current assignment flashes in the display window.
3. Press **DIGITAL** repeatedly to select **Opt. 1, Opt. 2, Opt. 3, Coaxial or Analog**.

Examples:

If you connect your DVD player to the **OPTICAL IN 1** jack, set "DVD" to "Opt. 1".

If you want to listen to audio from the component connected to the **OPTICAL IN 2** jack when the **VCR** input source is selected, set "VCR" to "Opt. 2".

If you want to listen to audio from the component connected to the **COAXIAL IN** jack when the **TV/STB** input source is selected, set "TV/STB" to "Coaxial".

For input source that you don't want to assign a digital input jack, set to "Analog".

Notes

- You can select the input mode only when you set the input source to DVD, VCR, CD, AV, or TV/STB.

Input source	Initial setting	Display
DVD	OPTICAL 1	Opt. 1
VCR	ANALOG	Analog
CD	COAXIAL	Coaxial
AV	OPTICAL 3	Opt. 3
TV/STB	OPTICAL 2	Opt. 2

- You can also select other input mode on the selected input source.

To mute the sound

Press **MUTE** on the remote control. To cancel, press it again.

Switching the audio signal

This section explains how to switch the audio input/output signal about each function mode.
(O: Active, X: Inactive)

Function mode	Input/Output	Input			Output		
		Analog RCA input (VCR, TV/STB, DVD, CD, Portable, AV)	• OPTICAL 1 • OPTICAL 2 • OPTICAL 3 • COAXIAL	• HDMI 1 • HDMI 2	Speaker terminal	VCR REC.OUT	HDMI OUT
TUNER		X	X	X	O	O	X
DVD		O	O	X	O	O	X
Portable		O	X	X	O	O	X
VCR		O	O	X	O	O	X
CD		O	O	X	O	O	X
AV		O	O	X	O	O	X
TV/STB		O	O	X	O	O	X
USB		X	X	X	O	X	X
PC-LINK		X	X	X	O	O	X
HDMI 1/ HDMI 2		X	X	O	O	X	O

Note

The VCR REC. audio output is outputted only when analog audio input is selected on each function mode.

Switching the video signal

This section explains how to switch the video input/output signal about each function mode.
(O: Active, X: Inactive)

Function mode	Output			
	MONITOR OUT	VCR REC. OUT	COMPONENT OUT	HDMI OUT
TUNER	X	X	X	X
DVD	O	O	O	X
Portable	X	X	X	X
VCR	O	X	X	X
CD	O	O	X	X
AV	O	O	X	X
TV/STB	O	O	O	X
USB	X	X	X	X
PC-LINK	X	X	X	X
HDMI 1/ HDMI 2	X	X	X	O

Note

- The VCR IN video signal is not outputted to the VCR REC. OUT video signal. However, The VCR IN audio signal can be outputted to the VCR REC. OUT audio signal.
- COMPOSITE VIDEO signal is only outputted to MONITOR OUT or VCR REC. OUT.
COMPONENT VIDEO signal is only outputted to COMPONENT VIDEO OUT.
HDMI IN signal is only outputted to HDMI OUT.

Playing media files using the USB feature

You can enjoy the media files such as image files (JPEG), video files and Music files (MP3/WMA) saved in an MP3 player or USB memory by connecting the storage device to the USB port of this unit.

Basic Operation

1. Rotate the INPUT SELECT on the front panel until the "USB" appears in the display window. Or press RECEIVER on the remote control, and then press INPUT.SEL. And then press the USB on the remote control.
"NO USB" appears in the display window.
2. Connect the USB device to the USB port of the unit. (See the page 16.)
"CHECKING..." appears in the display window, and then the total number of files is displayed.
3. Press PLAY (▶).

Note

If there is no file in the USB device, "NO FILE" appears in the display window.

Moving to other memory cards

In case that more than one memory cards are connected to the USB port, press the D.SEL repeatedly on the remote control to select a memory card you want to use.

Note

If there is no memory card in the USB device, "NO DISK" appears in the display window.

Pause

Press the PAUSE(⏸) during playback.
Press the PLAY (▶) to resume playback.

Stop

Press the STOP (■) during playback.
- The total number of files appears in the display window.

Skip

During playback, press SKIP (⏮/⏭) to move to the next track or to return to the beginning of the current track. Press SKIP ⏮ twice briefly to step back to the previous track.

Repeat

During playback, press REPEAT repeatedly to select a desired repeat mode.

Display	Playback
N	Plays all tracks once.
1	Plays one track repeatedly
A	Plays all tracks repeatedly.
R	Plays all tracks randomly.

Information display of MP3 file

During playback, press DISPLAY repeatedly.
- You can check the ID3 TAG (Title→Artist→Album), disk number, sound mode, channel and sampling frequency in the display window.

Note

The information of title, artist, and album supports a maximum of 40 letters.

Compatible Devices

1. Devices which require additional program installation when you have connected it to a computer, are not supported.
2. MP3 Player: Flash type MP3 player.
 - The MP3 player requiring installation of a driver is not supported.
3. USB Flash Drive: Devices that support USB2.0 or USB1.1.

Notes:

- Do not extract the USB device in operating.
- A back up demands to prevent a data damage.
- If you use a USB extension cable or USB hub, the USB device might not be recognized.
- This unit can support USB 2.0 or USB 1.1.
- A device using NTFS file system is not supported. (Only FAT (12/16/32) file system is supported.)
- The USB function of this unit does not support all USB devices.
- Digital camera and mobile phone are not supported.
- This unit is not supported when the total number of files is 1000 or more.
- MP3/WMA file compatibility
 - Bit rate: within 8 - 320 Kbps (MP3),
within 8 - 320 Kbps (WMA)
 - Sampling frequency: within 32 - 48 KHz (MP3),
within 32 - 48 KHz (WMA)

Listening to FM/AM radio

You can listen to FM and AM broadcasts through the built-in tuner. Before operation, make sure you have connected the FM and AM antennas to the unit.

Automatic tuning

1. **Rotate INPUT SELECT to select tuner (FM or AM).**
Or select TUNER with the remote control to select tuner (FM or AM).

Tip

Refer to the "Selecting the input source" on the page 25 to select the tuner mode.

2. **Press TUN. - or TUN. + for more than 2 seconds.**
Press TUN. - for more than 2 seconds to scan from high to low.
Press TUN. + for more than 2 seconds to scan from low to high.
The unit stops scanning whenever a station is received.

Note

In case of FM stereo reception, if the FM stereo reception is poor and "ST." flashes in the display window, select monaural audio so that the sound will be less distorted by pressing the MO./ST.

- The "ST." indicator disappears in the display window.

There will be no stereo effect, but the reception will improve. Press the button again to restore the stereo effect.

Manual tuning

Press TUN. - or TUN. + briefly and repeatedly on the FM or AM mode to select a station you want.

Presetting radio stations

You can preset up to 50 FM or AM stations. Then you can easily tune in the stations you often listen to.

1. **Rotate INPUT SELECT to select tuner (FM or AM).**
Or select TUNER with the remote control to select tuner (FM or AM).

Tip

Refer to the "Selecting the input source" on the page 25 to select the tuner mode.

2. **Tune in the station that you want to preset using Automatic tuning or Manual tuning.**
3. **Press PROG./CLEAR.**
A preset number flashes in the display window for a few seconds. When a preset number flashes, do step the 4.
4. **Press PRESET - or PRESET+ to select a preset number you want.**
If a preset number is not flashed before you select the preset number, start again from the step 3.
5. **Press PROG./CLEAR again.**
The station is stored to the selected preset number.
If a preset number is not flashed before you press PROG./CLEAR, start again from the step 3.
6. **Repeat the steps 2 to 5 to preset another station.**

To clear all the stored stations

1. **Press and hold PROG./CLEAR for about two seconds.**
"ERASE ALL" appears in the display window.
2. **Press PROG./CLEAR again.**
All the presetting stations are cleared.

Notes

- If you have accidentally entered into the "ERASE ALL" mode and you do not wish to clear the memory, do not press any key. After a few seconds, "ERASE ALL" will go out by itself and change to normal mode.
- If all stations have already been entered, "FULL" will appear in the display window for a moment and then a preset number will flash. To change the preset number, follow the steps 4-5 as specified above. The previous frequency is automatically refreshed.

Setting the Display Brightness

You can adjust the brightness of the display window.

Press RECEIVER, and then press DIMMER on the remote control repeatedly.
The brightness of the display window is on/off.

Using the Mute Function

You can temporarily mute the output of the unit.

Press RECEIVER, and then press MUTE.
The output is muted and the "MUTE" flashes in the display window.
To cancel it, press the MUTE again, or adjust the volume.

Using the Sleep Timer

With the sleep timer, you can set the unit to turn off automatically after a specified period.

- Press RECEIVER, and then press SLEEP repeatedly to select the required sleep time.**
The SLEEP indicator and the sleep time appears in the display window.
- Each time you press SLEEP the setting changes in the following order.**
SLEEP 180 → 150 → 120 → 90 → 80 → 70 → 60 → 50 → 40 → 30 → 20 → 10 → OFF (No display)
The specified sleep time minute appears on the display for about five seconds, then the previous display reappears.

Note

To check the remaining time before the unit sleeps, press SLEEP.
- The remaining time appears for about five seconds in the display window.

Displaying Source Information

You can display various information about the current input source.

Press RECEIVER, and then press DISPLAY repeatedly to cycle through the available information.

Note

The following information can typically be displayed for input sources in the display window.

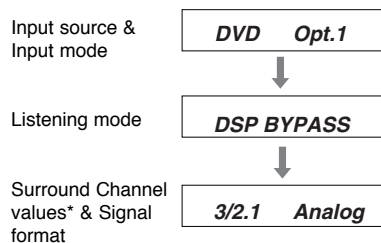

* Interpreting Surround Channel values

$$\frac{3}{A} \frac{2}{B} \frac{1}{C}$$

- A: The number of front channels (3 means front left, front right, and center).
B: The number of surround channels (2 means surround left and surround right). If there's surround center channel information, this will be 3.
C: Subwoofer (1 means yes).

Selecting setup menu

By using the Setup menu, you can make various adjustments to items such as sound.

Setup configuration

1 . SURROUND	<ul style="list-style-type: none"> — A) PL2X-PANO : N/Y — B) PL2X-DIM. : -7 ~ +7 — C) PL2X-CWID : 0 ~ 7 — D) Neo:6-CG : 0.0 ~ 1.0
2 . SPK TYPE	<ul style="list-style-type: none"> — FRONT LR : SMALL / LARGE — CENTER : SMALL / LARGE / NONE — SURR. LR : SMALL / LARGE / NONE — SURR. C : SMALL / LARGE / NONE — LFE OUT : FRONT / SUBWF / BOTH
3 . X - OVER	— X - OVER : 040Hz ~ 200Hz
4 . SPK DISTANCE	<ul style="list-style-type: none"> — DELAY FL : 0.0M ~ 15.0M — DELAY C : 0.0M ~ 15.0M — DELAY FR : 0.0M ~ 15.0M — DELAY SR : 0.0M ~ 15.0M — DELAY SC : 0.0M ~ 15.0M — DELAY SL : 0.0M ~ 15.0M — DELAY SW : 0.0M ~ 15.0M
5 . SPK LEVEL	<ul style="list-style-type: none"> — FL LEV : -10dB ~ +10dB — C LEV : -10dB ~ +10dB — FR LEV : -10dB ~ +10dB — SR LEV : -10dB ~ +10dB — SC LEV : -10dB ~ +10dB — SL LEV : -10dB ~ +10dB — SW LEV : -10dB ~ +10dB
6 . HDMI OUT	— HDMI OUT : TV / SPK
7 . DIGITAL IN	— Digital : AUTO / MANUAL
8 . LOAD INITIAL	— LOAD INIT : NO / YES

General operation of setup menu

1. Press **RECEIVER**, and then press **SETUP**.
The Setup menu appears in the display window.
The default setting is 1 . SURROUND .
2. Use **◀ / ▶** to select the desired item then press **ENTER** to move to the second level.
The current setting for the selected item appears in the display window.
3. Use **◀ / ▶** to select the second desired item and then use **▲ / ▼** to select the desired setting.
4. Press **RETURN** to exit the previous menu.
Press **SETUP** to exit the Setup menu.

1. SURROUND (Enjoying surround sound)

These settings provide for playing any 2-channel digital source such as Dolby Digital, or 2-channel analog/PCM source in the PL1x Music listening mode.

1 . SURROUND	<ul style="list-style-type: none"> — A) PL2X-PANO : N/Y — B) PL2X-DIM. : -7 ~ +7 — C) PL2X-CWID : 0 ~ 7 — D) Neo:6-CG : 0.0 ~ 1.0
--------------	---

PL2X-PANO (Panorama mode)

With this function, you can broaden the width of the front stereo image when using the Pro Logic II Music or Pro Logic IIx Music listening mode.

Y : Panorama function on.

N : Panorama function off (default).

PL2X-DIM. (Dimension mode)

With this setting, you can move the sound field forward or backward when using the Pro Logic II Music or Pro Logic IIx Music listening mode. Higher settings move the sound field forward. It can be adjusted from -7 to 7 (default is 0).

PL2X-CWID (Center width mode)

With this function, you can adjust the width of the sound from the center speaker when using the Pro Logic II Music or Pro Logic IIx Music listening mode. Normally if you are using a center speaker, the center channel sound is outputted by only the center speaker. (If you are not using a center speaker, the center channel sound will be distributed to the front left and right speakers to create a phantom center). This setting controls the front left, right, and center mix, allowing you to adjust the weight of the center channel sound. It can be adjusted from 0 to 7 (default is 3).

Neo:6-CG (Center width mode)

The DTS Neo:6 Music listening mode creates 6-channel surround sound from 2-channel (stereo) sources. With this setting, you can specify by how much the front left and right channel output is attenuated in order to create the center channel. It can be adjusted from 0 to 1.0. This setting is unavailable if no surround speakers are connected. When set to 0, the front left and right channel output is attenuated by half (-6dB), giving the impression that the sound is located centrally. This setting works well when the listening position is considerably off center. When set to 1.0, the front left and right channels are not attenuated, maintaining the original stereo balance.

Note

If you set the surround mode to the Neo:6 CINEMA, you cannot adjust the settings since the Neo:6-CG is fixed to 1.0.

2. SPK TYPE (Setting speaker type)

You can set the size of the speakers connected to this unit.

2. SPK TYPE	<ul style="list-style-type: none"> FRONT LR : SMALL / LARGE CENTER : SMALL / LARGE / NONE SURR. LR : SMALL / LARGE / NONE SURR. C : SMALL / LARGE / NONE LFE OUT : FRONT / SUBWF / BOTH
-------------	--

FRONT LR (FRONT LEFT/RIGHT)

Set the FRONT L/R speaker to LARGE or SMALL.

- **LARGE** : If you connect large speakers that will effectively reproduce bass frequencies, select "LARGE". Normally, select "LARGE".
When the LFE OUT is set to "FRONT", front speakers are automatically set to "LARGE".
- **SMALL** : If the sound is distorted, or you fell a lack of surround effects when using multi channel surround sound, select "SMALL" to activate the bass redirection circuitry and output the front channel bass frequencies from subwoofer.
When the LFE OUT is set to "SUBWF", front speakers are automatically set to "SMALL".

CENTER

Set the CENTER speaker to LARGE, SMALL, or NONE.

- **LARGE** : If you connect large speakers that will effectively reproduce bass frequencies, select "LARGE". Normally, select "LARGE".
- **SMALL** : If the sound is distorted, or you fell a lack of surround effects when using multi channel surround sound, select "SMALL" to activate the bass redirection circuitry and output the center channel bass frequencies from front speaker or subwoofer.
- **NONE** : If you did not connect a center speaker, select "NONE". The sound of the center channel will be outputted from the front speakers.

SURR. LR (SURROUND LEFT/RIGHT)

Set the SURROUND L/R speaker to LARGE, SMALL, or NONE.

- **LARGE** : If you connect large speakers that will effectively reproduce bass frequencies, select "LARGE". Normally, select "LARGE".

- **SMALL** : If the sound is distorted, or you fell a lack of surround effects when using multi channel surround sound, select "SMALL" to activate the bass redirection circuitry and output the surround channel bass frequencies from subwoofer or other "LARGE" speaker.
- **NONE** : If you did not connect surround speaker, select "NONE".

SURR. C (SURROUND CENTER)

When the SURROUND L/R speakers are set to "NONE", the surround center speaker is also automatically set to "NONE" and the setting cannot be changed.

LFE OUT

Set the output of subwoofer to FRONT, SUBWF, or BOTH.

- **FRONT** : Select "FRONT" if you did not connect a subwoofer. The LFE signals, the low-frequency signals of front left and right channels, and the low-frequency signals of other speakers set to "SMALL" or to "NONE" are all directed to the front left and right speakers.
- **SUBWF** : Select "SUBWF" if you connected a subwoofer. The LFE signals as well as the low-frequency signals of other speakers set to "SMALL" or to "NONE" are directed to the subwoofer.
- **BOTH** : Select "BOTH" if you connected a subwoofer. The low-frequency signals of any source are output from the subwoofer. The LFE signals as well as the low-frequency signals of other speakers set to "SMALL" or to "NONE" are directed to the subwoofer. The low-frequency signals of the front left and right channels are directed to the front left and right speakers. (When the analog or digital 2ch input is used, the front speakers is only outputted.)

3. X-OVER

The bass frequency you select is added to the output of subwoofer or outputted to the front speakers.

3. X - OVER	— X - OVER : 040Hz ~ 200Hz
-------------	----------------------------

X - OVER

Set the bass frequency to 40Hz - 200Hz. The default setting is 100Hz.

4. SPK DISTANCE (Setting speaker distance)

You can set the distance of the speakers connected to this unit.

Initial value is 3.0 meter (10 feet).

It lets you set the distance from your listening position to the front, center, surround, surround center, and subwoofer speakers. You can adjust from 0 meter to 15 meters (0 to 50 feet) in 0.3 meter (1 foot) steps.

If you press DISPLAY during setting the distance, the unit of distance is changed from M (Meter) to Ft (Feet) in the display window. If you press DISPLAY again, it is changed from Ft (Feet) to M (Meter).

4 . SPK DISTANCE	—	DELAY FL : 0.0M ~ 15.0M
	—	DELAY C : 0.0M ~ 15.0M
	—	DELAY FR : 0.0M ~ 15.0M
	—	DELAY SR : 0.0M ~ 15.0M
	—	DELAY SC : 0.0M ~ 15.0M
	—	DELAY SL : 0.0M ~ 15.0M
	—	DELAY SW : 0.0M ~ 15.0M

DELAY FL / DELAY FR

Set the distance of Front L/R speakers.

If both front speakers are not placed an equal distance from your listening position, set the distance to the closest speaker.

DELAY C

Sets the distance of Center speaker.

DELAY SR / DELAY SL

Sets the distance of Surround L/R speakers.

If both surround speakers are not placed an equal distance from your listening position, set the distance to the closest speaker.

DELAY CS

Sets the distance of Surround center speaker.

DELAY SW

Sets the distance of Subwoofer.

5. SPK LEVEL (Setting speaker level)

You can adjust the level of each speaker. These setting are applied to all sound fields.

Initial value is 0dB.

You can adjust from -10dB to +10dB in 1dB step.

5 . SPK LEVEL	—	FL LEV : -10dB ~ +10dB
	—	C LEV : -10dB ~ +10dB
	—	FR LEV : -10dB ~ +10dB
	—	SR LEV : -10dB ~ +10dB
	—	SC LEV : -10dB ~ +10dB
	—	SL LEV : -10dB ~ +10dB
	—	SW LEV : -10dB ~ +10dB

FL LEV: Sets the level of Front L speaker.

C LEV: Sets the level of Center speaker.

FR LEV: Sets the level of Front R speaker.

SR LEV: Sets the level of Surround R speaker.

SC LEV: Sets the level of Surround center speaker.

SL LEV: Sets the level of Surround L speaker.

SW LEV: Sets the level of Subwoofer.

6. HDMI OUT

HDMI (High Definition Multimedia Interface) supports both video and audio on a single digital connection for an easy all-digital output to an HDMI or DVI-equipped TV. Set the HDMI OUT sound output to TV or SPK.

6 . HDMI OUT	—	HDMI OUT : TV / SPK
--------------	---	---------------------

HDMI OUT

- TV : Outputs a sound signal of component with HDMI jack to TV.
- SPK : Outputs a sound signal of component with HDMI jack to speakers.

7. DIGITAL IN (Setting Digital Input Signal)

This setting determines how to set the digital signals.

7 . DIGITAL IN	—	Digital : AUTO / MANUAL
----------------	---	-------------------------

Digital

- AUTO : The unit changes to the selected digital signal when received the digital signal. The unit changes to analog signal automatically when not received the digital signal.
- MANUAL : The unit maintains the current mode regardless of digital signal.

8. LOAD INITIAL

This procedure can be used to initialize settings you have made to their factory.

8 . LOAD INITIAL	—	LOAD INIT : NO / YES
------------------	---	----------------------

LOAD INIT

- NO : The unit does not initialize settings you have to the made to their factory default settings.
- YES : The unit initializes settings you have to the made to their factory default settings. While "LOAD INIT : YES" appears in the display window, press ENTER on the remote control. After "LOAD INIT DONE" appears in the display window for a while, the unit is changed to TUNER mode.

The following is reset to their factory settings.

- Current input source : TUNER, FM 87.5MHz
- The following is the default setting on each function.

Function	Display	Function	Display
DVD	Opt. 1	AV	Opt. 3
VCR	Analog	TV/STB	Opt. 2
CD	Coaxial		

If there is no signal to the default setting, "Analog" appears in the display window.

- Default surround mode
 - PCM/MP3/WMA : PL2x Music
 - DD2 : PL2x Movie
 - DD5 : Dolby D EX
 - DD-EX : Dolby D EX
 - DTS 5.1 : MATRIX 6.1
 - DTS-ES : Discrete 6.1
- Current LISTENING MODE
 - DSP EQ LS Mode : CINEMA
 - Bypass LS Mode : DSP Bypass
 - Enhancer LS Mode : VSM (Virtual Speaker Mode)
- PL2x Music & NEO:6 Parameter
 - PLLix Panorama : OFF
 - PLLix Dimension (0~14) : 7
 - PLLix Center Width (0~7) : 3
 - Neo:6 CGAIN : 1.0
- SPEAKER LEVEL : All CH 0dB
- SPEAKER DISTANCE : ALL CH 3.0M (10Feet)
- AV SYNC (AUDIO DELAY) : 0 msec
- SPEAKER TYPE
 - Front: SMALL
 - Center: SMALL
 - Surround: SMALL
 - Surround center: SMALL
 - LFE OUT: SUBWF
- X-OVER: 100Hz
- NIGHT MODE (DRC) : OFF
- TONE CONTROL: OFF
 - BASS : 0, MIDDLE : 0, TREBLE : 0

Enjoying the listening mode

SURROUND mode

This mode lets you specify the type of decoding for 2 channels audio sources. This unit can reproduce 2 channel sound in 5 channels through Dolby Pro Logic II; 6 channels through DTS Neo:6; or 4 channels through Dolby Pro Logic. However, DTS 2CH sources are not decoded by DTS Neo:6; they are output in 2 channels.

Press RECEIVER, and then press SURROUND repeatedly to select the 2 channel decoding mode.

The selected sound appears in the display window.

Display	Description
PL2x MOVIE	Performs Dolby Pro Logic II Movie mode decoding. This setting is ideal for movies encoded in Dolby Surround.
PL2x MUSIC	Performs Dolby Pro Logic II Music mode decoding. This setting is ideal for normal stereo such as CDs.
PL2x GAME	Performs Dolby Pro Logic II Game mode decoding.
Dolby D EX (Dolby SURROUND EX)	Performs Dolby Surround EX mode decoding.
Neo:6 CINEMA	Performs the DTS Neo:6 Cinema mode decoding.
Neo:6 MUSIC	Performs the DTS Neo:6 Music mode decoding. This setting is ideal for normal stereo such as CDs.
MATRIX 6.1 (DTS MATRIX ES)	Performs the DTS Matrix Ex mode decoding.

DSP (Digital Sound Processor) mode

Press RECEIVER, and then press DSP repeatedly to select the DSP (Digital Sound Processor) mode you want.

The selected sound appears in the display window.

Display	Description
CINEMA	Reproduces the powerful sound of movie theater.
BIG HALL	Reproduces the exciting sound of movie concert halls.
CLUB	Reproduces the normal music sound.
JAZZ	Reproduces the acoustics of a jazz club.
ARENA	Reproduces the feeling of a sport ground.
STADIUM	Reproduces the feeling of sports open-air stadium.

BYPASS mode

Press RECEIVER, and then press BYPASS repeatedly to select 2 channel sound from front speakers or subwoofer.

The selected sound appears in the display window.

Display	Description
DSP BYPASS	Reproduces the DSP bypass mode with bass management from front speakers and subwoofer.
STEREO	Reproduces the 2 or 2.1 channel bypass sound in multi channel from front speakers and subwoofer.
PURE BYPASS	Reproduces the pure bypass mode with no bass management from front speakers.

ENHANCER mode

This mode enhances the sound quality of compressed input signal (MP3, WMA, etc) from front speakers and subwoofer.

Press RECEIVER, and then press ENHANCER repeatedly to enhance the sound quality.

Display	Description
VSM-3D	Reproduces the 3D sound effect when the input source is selected 2 or 2.1 channel.
VSM-ES	Reproduces the 3D sound effect when the input source is selected 5.1 channel or more.
MUSIC ENHANCER	Reproduces the compounded the high-frequency. This mode has an effect on the section of Bit rate and Sampling frequency as shown below. - Bit rate : 80-96Kbps - Sampling frequency : 32 - 44.1 kHz

About Listening mode

The following table lists all the listening modes and shows which modes can be selected for each input signal format.

(O: Active, X: Inactive)

Sound Format		PCM		Dolby Digital			DTS	
Input Signal		Analog/ PCM/ MP3/ WMA	Multi Channel	No surround	Surround	DD-EX 3/3.1	3/2.1 (96/24)	ES6.1 3/3.1
Channels		Front L Front R	Front L/R Center Rear L/R Rear back	Front L Front R	Front L/R Center Rear L/R	Front L/R Center Rear L/R Rear back	Front L/R Center Rear L/R	Front L/R Center Rear L/R Rear back
Function Buttons	Signal Listening mode	RCA/ TUNER/ spdif/ HDMI/ USB/ PC-LINK/ Portable	HDMI	spdif/ HDMI	spdif/ HDMI	spdif/ HDMI	spdif/ HDMI	spdif/ HDMI
BYPASS	DSP BYPASS	O	O	O	O	O	O	O
	STEREO	O	O	O	O	O	O	O
	PURE BYPASS	O	O	O	O	O	O	O
SURROUND	PL2x MOVIE	O	X	O	X	X	X	X
	PL2x MUSIC	O	X	O	O	O	O	O
	PL2x GAME	O	X	O	X	X	X	X
	Dolby D EX	X	X	X	O	O	X	X
	Neo:6 CINEMA	O	X	O	X	X	X	X
	Neo:6 MUSIC	O	X	O	X	X	X	X
	MATRIX 6.1	X	X	X	X	X	O	X
DSP	CINEMA	O	O	O	O	O	O	O
	BIG HALL	O	O	O	O	O	O	O
	CLUB	O	O	O	O	O	O	O
	JAZZ	O	O	O	O	O	O	O
	ARENA	O	O	O	O	O	O	O
	STADIUM	O	O	O	O	O	O	O
ENHANCER	VSM-3D	O	X	O	X	X	X	X
	VSM-ES	X	X	X	O	X	O	X
	MUSIC ENHANCER	O	X	X	X	X	X	X

Note

- If you press the SURROUND to select the surround mode when you connect the headphone, the mode is changed to bypass mode.
-“HP DOWNMIX” appears in the display window.
- If you select the PURE BYPASS mode by pressing the BYPASS on the remote control repeatedly during playing the DD-EX, the “EX” indicator does not appear in the display and outputs the 5.1 ch source except for surround center speaker.

Adjusting the speaker level

You can adjust the level of each speaker.

1. Press RECEIVER, and then press SPK LEVEL.

2. Use ▲ / ▼ / ◀ / ▶ to adjust the level of each speaker.

For details, see "5. SPK LEVEL (Setting speaker level)" on the page 32.

To cancel it, press SPK LEVEL again.

TEST TONE

This section explains how to output test tone sequentially from each speaker.

You can adjust the speaker level and volume while listening the test tone from listening position.

1. Press RECEIVER, and then press TEST TONE.

It appears in sequence as shown below.

TEST TONE FL → TEST TONE C → TEST TONE
FR → TEST TONE SR → TEST TONE SC → TEST
TONE SL → TEST TONE SW → TEST TONE FL...

2. Adjust the speaker level and volume while listening the test tone.

To cancel it, press TEST TONE again.

Note

The speakers cannot be calibrated while the output of the unit is muted, while a pair of headphones is connected.

AV Sync. (Adjusting the audio delay)

You may compensate for the difference through the use of delay settings in your listening position. The audio delay is adjusted from 0msec to 300msec in 10msec steps.

1. Press RECEIVER, and then press AV SYNC..

"AV SYNC: xxx ms" appears in the display window.

2. Use ▲ / ▼ to adjust the audio delay.

To cancel it, press AV SYNC. again.

Notes

- This function is not operated on the TUNER, PORTABLE, USB and PC-LINK mode.
- Use this function during playing a video file.
- This function has no effect on when you set HDMI OUT to TV on the SETUP menu and a signal is outputted to VCR REC. OUT L/R .

Adjusting the tone control

You can adjust the bass, middle, and treble level.

The level is adjusted from -10dB to +10dB in 2dB steps and displayed from MIN (-5) through MAX (+5) in the display window.

1. Press RECEIVER, and then press TONE CTRL repeatedly.

"TONE CTRL OFF" or "TONE CTRL ON" appears in the display window.

2. Press ENTER and then use ◀ / ▶ to select bass, middle, or treble level.

3. Use ▲ / ▼ to adjust the bass, middle, or treble level and then press ENTER.

Note

If you press any buttons except for MASTER VOLUME knob and VOLUME (-/+) buttons during adjusting the levels, the unit moves to the previous mode.

Using the NIGHT function (Dolby Digital only)

With the NIGHT function, you can reduce the dynamic range of Dolby Digital material so that you can still hear quiet parts even when listening at low volume levels—ideal for watching movies late at night when you don't want to disturb anyone.

1. **Press RECEIVER, and then press NIGHT repeatedly to select:**
 [NIGHT : OFF] - Late Night function off.
 [NIGHT : STD] - Small reduction in dynamic range.
 [NIGHT : MAX] - Big reduction in dynamic range.

Note

The effect of the NIGHT function depends on the Dolby Digital material that you are playing, and with some material there will be little or no effect.

M1, M2, M3

This section explains how to load and stores various settings on this buttons you set at one time.

The following is the stored items on the M1, M2, or M3 buttons.

- Input source (Tuner, DVD, Portable, VCR, CD, AV, TV/STB, USB, PC-LINK, HDMI 1/ HDMI 2)
- Input mode (Opt. 1, Opt. 2, Opt. 3, Coaxial, Analog)
- Listening mode
 - Surround mode (PL2x MOVIE, PL2x MUSIC, PL2x GAME, Neo:6 CINEMA, Neo:6 MUSIC, Neo:6 MUSIC)
 - DSP (Digital Sound Processor) mode (CINEMA, BIG HALL, CLUB, JAZZ, ARENA, STADIUM)
 - BYPASS mode (DSP BYPASS, STEREO, PURE BYPASS)
 - ENHANCER mode (VSM-3D, VSM-ES, MUSIC ENHANCER)
- Speaker level (FL/C/FR/SR/SC/SL/SW)
- AV SYNC
- X - OVER
- NIGHT mode
- TONE CONTROL (BASS, MIDDLE, TREBLE)
- Radio frequency

Note

This function is not supported the mode of Audyssey 2EQ on and off.

Storing the settings

1. **Press RECEIVER, and then press M1, M2, or M3 on the unit.**
 "M1 (M2 or M3) LOAD?" appears in the display window.
2. **Press ▲ / ▼.**
 "M1 (M2 or M3) SAVE?" appears in the display window.
3. **Press ENTER.**
 After "M1 (M2 or M3) SAVE OK" appears in the display window for a while, the unit is stored to the settings you set.

Loading the settings

1. **Press M1, M2, or M3 to load the stored settings.**
 "M1 (M2 or M3) LOAD?" appears in the display window.
2. **Press ENTER.**
 After "M1 (M2 or M3) LOAD OK" appears in the display window for a while, the unit loads the settings you set.

Reference

Mini Glossary for Audio Stream & Surround mode

Dolby Digital EX

Dolby Digital EX creates 6 full-bandwidth output channels from 5.1-channel sources. This is done using a matrix decoder that drives three surround channels from the two in the original recording. For best results, Dolby Digital EX should be used with movies soundtracks recorded with Dolby Digital Surround EX.

Dolby Digital

Dolby Digital is the multi-channel digital signal format developed by Dolby Laboratories. Discs bearing the “” includes the recording of up to 5.1 channels of digital signals, which can reproduce much better sound quality, spatial expansion and dynamic range characteristics than the previous Dolby Surround effect.

Dolby Surround Pro Logic

Dolby Pro Logic is a specially encoded two channel surround format which consists of four channels (front left, center, front right and surround). Sources bearing the Dolby Surround Pro Logic provide the theater - like surround sound. The surround channel is monaural, but is played through two surround speakers.

Dolby Pro Logic II

This mode applies conventional 2-channel signals such as digital PCM or analog stereo signals as well as Dolby Surround signals, etc. to surround processing to offer improvements over conventional Dolby Pro Logic circuits. Dolby Pro Logic II surround includes two modes as follows:

- **Dolby Pro Logic II MOVIE**
When enjoying movies, this mode allows you to further enhance the cinematic quality by adding processing that emphasizes the sounds of the action special effects.
- **Dolby Pro Logic II MUSIC**
When listening to music, this mode allows you to further enhance the sound quality by adding processing that emphasizes the musical effects.
- **Dolby Pro Logic II GAME**
When listening to game, this mode allows you to further enhance the sound quality by adding processing that emphasizes the dynamic effects.

Dolby Pro Logic IIx

Dolby Pro Logic IIx is the latest extension of Dolby Pro Logic II technology that creates a discrete 6.1 sound field from matrix surround or two-channel music stereo sources in systems configured for surround center speaker.

Audyssey

Audyssey 2EQ removes sound distortion by equalizing your sound system for your listening room. A good loudspeaker is designed to deliver sound without distortion or coloration. But when speakers are placed in a room, things change. Walls, furniture, and other objects reflect and absorb the sound from your speakers, creating complex distortions, specific to your room, which could not be predicted by the loudspeaker designer. Audyssey 2EQ is the first technology to properly measure sound information throughout your listening area and then combine this information to accurately represent the acoustical problems in the room. Based on these measurements, 2EQ calculates an equalization solution that corrects for both time and frequency response problems in every seat. The 2EQ solution results in better sound in every seat and a listening experience unlike anything you have heard before. Audyssey 2EQ is a trademark of Audyssey Laboratories, Inc.

Mini Glossary for Audio Stream & Surround mode

DTS / DTS-ES | Neo:6

"DTS" and "DTS-ES | Neo:6" are registered trademarks of DTS, Inc. "96/24" is a trademark of DTS, Inc.

DTS - ES Extended Surround™

This is a new multi channel digital signal format which greatly improves the 360- degree surround impression and space expression thanks to further expanded surround signals, offering high compatibility with the conventional DTS format.

In addition to the 5.1 channels, DTS-ES Extended Surround also offers the surround center (sometimes also referred to as "surround center") channel for surround playback with a total of 6.1 channels. DTS-ES Extended Surround includes two signal formats with different surround signal recording methods as follows:

- **DTS-ES™ Discrete 6.1**

Because the signals for 6.1 channels (including the surround center channel) are fully independent, it is possible to achieve a sense that the acoustic image are moving about freely among the background sounds surrounding the listener from 360 degrees. Though maximum performance is achieved when sound tracks recorded with this system are played using a DTS -ES decoder, when played with a conventional DTS decoder, the surround center channel signals are automatically down mixed to the surround left and surround right channels so that none of the signal components are lost.

- **DTS - ES™ Matrix 6.1**

With this format, the additional surround center channel signals undergo matrix encoding and are input to the surround left and surround right channels beforehand. During playback, they are decoded to the surround left, surround right and surround center channels. Because the bit stream format is 100% compatible with conventional DTS signals, the effect of the DTS-ES Matrix 6.1 format can be achieved even with DTS 5.1 - channel signal sources. Of course, it is possible to play DTS-ES Matrix 6.1 - channel signal sources with a DTS 5.1 - channel decoder. When DTS-ES Discrete 6.1 or Matrix 6.1 sources are decoded with a DTS - ES decoder, the format is automatically detected upon decoding and the optimum surround mode is selected. However, some DTS - ES Matrix 6.1 sources may be detected as DTS sources. In this case, the DTS - ES Matrix mode must be selected manually to play these sources.

In DTS - ES Discrete 6.1, DTS -ES Matrix 6.1 sources, the surround center channel is monaural, but can be played through a surround center speaker.

DTS Neo : 6™ surround

This mode applies conventional 2-channel signals such as digital PCM or analog stereo signals to the high precision digital matrix decoder used for DTS-ES Matrix 6.1 to achieve 6.1-channel surround playback. DTS Neo : 6 surround includes two modes for selecting the optimum decoding for the signal source.

- **DTS Neo : 6 CINEMA**

This mode is optimum for playing movies. Decoding is performed with emphasis on separation performance to achieve the same atmosphere with 2-channel sources as with 6.1-channel sources.

- **DTS Neo : 6 MUSIC**

This mode is suited mainly for playing music. The front left and front right signals bypass the decoder and are played directly so there is no loss of sound quality, and the effect of the surround signals from the center, surround left, surround right and surround center channels adds a natural sense of expansion to the sound field.

"DTS", "DTS-ES Extended Surround" and "Neo : 6" are trademarks of Digital Theater Systems, Inc.

DTS Digital Surround

DTS was introduced in 1994 to provide 5.1 channels of discrete digital audio into home theater systems.

DTS brings you premium quality discrete multi-channel digital sound to both movies and music.

DTS is a multi-channel sound system designed to create full range digital sound reproduction.

The no compromise DTS digital process sets the standard of quality for cinema sound by delivering an exact copy of the studio master recordings to neighborhood and home theaters.

"DTS" and "DTS Digital Surround" are registered trademarks of Digital Theater Systems, Inc.

Troubleshooting

Check the following guide for the possible cause of a problem before contacting service.

PROBLEM	POSSIBLE CAUSE	REMEDY
No power.	<ul style="list-style-type: none"> The AC input cord is disconnected. Poor connection at AC wall outlet or the outlet is dead or off. 	<ul style="list-style-type: none"> Connect cord securely. Check the outlet using a lamp or another appliance.
No sound.	<ul style="list-style-type: none"> The speaker wires are disconnected. The MASTER VOLUME is adjusted too low. The MUTE button is pressed to ON. The selected decoding mode is not matched to the input signal format. Incorrect selection of input source. Incorrect connections between the components. The USB cable is separated during playing a file on the PC-LINK mode. 	<ul style="list-style-type: none"> Check the speaker connections. Adjust the MASTER VOLUME. Press the MUTE button to cancel the muting effect. Select the available decoding mode. Select the desired input source correctly. Make connections correctly. Execute a media player again.
No sound from the surround speakers.	<ul style="list-style-type: none"> Surround mode is switched off (normal stereo mode). MASTER VOLUME and surround level are too low. Monaural source is used. Surround speaker setting is "NONE". 	<ul style="list-style-type: none"> Select a surround mode. Adjust MASTER VOLUME and surround level. Select a stereo or surround source. Select the desired surround speaker setting.
No sound from the (front) center speaker.	<ul style="list-style-type: none"> Dolby Virtual, normal stereo mode, etc is selected. MASTER VOLUME and center level are too low. 	<ul style="list-style-type: none"> Select the desired surround mode. Adjust MASTER VOLUME and center level.
No sound from the surround center speakers.	<ul style="list-style-type: none"> The input signal format or the current surround mode cannot support the 6.1 surround. MASTER VOLUME and surround center level are too low. 	<ul style="list-style-type: none"> Under the proper situations, perform the 6.1 surround playback. Adjust MASTER VOLUME and surround center level.
Stations cannot be received.	<ul style="list-style-type: none"> No antenna is connected. The desired station frequency is not tuned in. Antenna is in wrong position. 	<ul style="list-style-type: none"> Connect an antenna. Tune in the desired station frequency. Move antenna and retry tuning.
Preset stations cannot be received.	<ul style="list-style-type: none"> An incorrect station frequency has been memorized. The memorized stations are cleared. 	<ul style="list-style-type: none"> Memorize the correct station frequency. Memorize the stations again.
Poor FM reception.	<ul style="list-style-type: none"> No antenna is connected. The antenna is not positioned for the best reception. 	<ul style="list-style-type: none"> Connect an antenna. Change the position of the antenna.
Remote control does not operate.	<ul style="list-style-type: none"> Batteries are not loaded or exhausted. The remote sensor is obstructed. 	<ul style="list-style-type: none"> Replace the batteries. Remove the obstacle.

Specifications

General

Power supply	Refer to main label.
Power consumption	130 W
Net Weight	4.94 kg
External dimensions	430 x 150 x 300 mm (W x H x D)
Operating conditions	Temperature: 5°C to 35°C

Amplifier

Frequency response	10 - 22000 Hz
Signal-to-noise ratio	More than 80 dB (Analog : 1 kHz, NOP -3 dB, 20 kHz LPF/A-Filter) More than 95 dB (Digital : 1 kHz, NOP -3 dB, 20 kHz LPF/A-Filter) More than 70 dB (PC-LINK : 1 kHz, NOP -3 dB, 20 kHz LPF/A-Filter)
COMPONENT VIDEO OUT	(Y) 1.0 V, (P _S)/(P _R) 0.7 V

Output Power

AR702TT/AR702TS model

Front	140 W + 140 W (10% THD, 8Ω, 20 kHz LPF) 100 W + 100 W (0.2% THD, 8Ω, 20 kHz LPF)
Center	140 W (10% THD, 8Ω, 20 kHz LPF) 100 W (0.2% THD, 8Ω, 20 kHz LPF)
Surround	140 W + 140 W (10% THD, 8Ω, 20 kHz LPF) 100 W + 100 W (0.2% THD, 8Ω, 20 kHz LPF)
Surround Center	140 W (10% THD, 8Ω, 20 kHz LPF) 100 W (0.2% THD, 8Ω, 20 kHz LPF)
Active Subwoofer	250 W (10% THD, 4Ω, 20 kHz LPF) 200 W (0.8% THD, 4Ω, 20 kHz LPF)

AR702BR model

Front	70 W + 70 W (10% THD, 8Ω, 20 kHz LPF)
Center	70 W (10% THD, 8Ω, 20 kHz LPF)
Surround	70 W + 70 W (10% THD, 8Ω, 20 kHz LPF)
Surround Center	70 W (10% THD, 8Ω, 20 kHz LPF)
Active Subwoofer	250 W (10% THD, 4Ω, 20 kHz LPF)

Inputs

VCR IN, TV/STB IN, DVD IN, CD IN, OPTICAL 1/2/3 IN, AV IN
COMPONENT VIDEO IN (DVD, TV/STB), COAXIAL IN,
HDMI 1/2 IN, USB, PC-LINK, PORTABLE IN

Outputs

T.H.D

MONITOR OUT, COMPONENT VIDEO OUT, HDMI OUT
Less than 0.05 % (1W, 20kHz LPF)

Tuner

FM

Tuning Range	87.5 - 108.0 MHz or 65.0 - 74.0 MHz, 87.5 - 108.0 MHz
Intermediate Frequency	10.7 MHz
Signal-to Noise Ratio	60 dB (Mono)/ 55 dB (Stereo)
Frequency Response	140 - 10000 Hz

AM

Tuning Range	522 - 1620 kHz or 520 - 1720 kHz
Intermediate Frequency	450 kHz
Signal-to Noise Ratio	30 dB
Frequency Response	140 - 1800 Hz

Speaker

	Front Speaker (SR72TT-F)	Center speaker (SR72TT-C)	Surround Speaker (SR72TT-F)
Type	Bass Reflex 2 Way 2 Speaker System	Sealed Type 2 Way 3 Speaker System	Bass Reflex 2 Way 3 Speaker System
Impedance	8 Ω	8 Ω	8 Ω
Frequency Response	40 - 20000 Hz	80 - 20000 Hz	40 - 20000 Hz
Sound Pressure Level	83 dB/W (1m)	81 dB/W (1m)	83 dB/W (1m)
Rated Input Power	140 W	140 W	140 W
Max. Input Power	280 W	280 W	280 W
Net Dimensions (W x H x D)	206 x 1003 x 270.5 mm	391 x 147.5 x 190.5 mm	206 x 1003 x 270.5 mm
Net Weight (1EA)	17.8 kg	3.21 kg	17.8 kg

	Surround Center Speaker (SR72TT-B)	Active subwoofer (SR72TT-A)
Type	Bass Reflex 2 Way 2 Speaker System	Bass Reflex 1 Way 1 Speaker System
Impedance	8 Ω	4 Ω
Frequency Response	80 - 20000 Hz	30 - 1000 Hz
Sound Pressure Level	81 dB/W (1m)	81 dB/W (1m)
Rated Input Power	140 W	250 W
Max. Input Power	280 W	500 W
Net Dimensions (W x H x D)	321 x 148 x 158.5 mm	266 x 343 x 406 mm
Net Weight (1EA)	2.48 kg	11.28 kg

	Front Speaker (SR72TS-F)	Center speaker (SR72TS-C)	Surround Speaker (SR72TS-L)
Type	Bass Reflex 2 Way 3 Speaker System	Sealed Type 2 Way 3 Speaker System	Bass Reflex 2 Way 2 Speaker System
Impedance	8 Ω	8 Ω	8 Ω
Frequency Response	40 - 20000 Hz	80 - 20000 Hz	80 - 20000 Hz
Sound Pressure Level	83 dB/W (1m)	81 dB/W (1m)	81 dB/W (1m)
Rated Input Power	140 W	140 W	140 W
Max. Input Power	280 W	280 W	280 W
Net Dimensions (W x H x D)	206 x 1003 x 270.5 mm	391 x 147.5 x 190.5 mm	146 x 238 x 183.5 mm
Net Weight (1EA)	17.8 kg	3.21 kg	2.2 kg

	Surround Center Speaker (SR72TS-B)	Active subwoofer (SR72TS-A)
Type	Bass Reflex 2 Way 2 Speaker System	Bass Reflex 1 Way 1 Speaker System
Impedance	8 Ω	4 Ω
Frequency Response	80 - 20000 Hz	30 - 1000 Hz
Sound Pressure Level	81 dB/W (1m)	81 dB/W (1m)
Rated Input Power	140 W	250 W
Max. Input Power	280 W	500 W
Net Dimensions (W x H x D)	321 x 148 x 158.5 mm	266 x 343 x 406 mm
Net Weight (1EA)	2.48 kg	11.28 kg

	Front Speaker (SR72BR-L)	Center speaker (SR72BR-B)	Surround Speaker (SR72BR-S)
Type	Bass Reflex 2 Way 2 Speaker System	Bass Reflex 2 Way 2 Speaker System	Bass Reflex 1 Way 1 Speaker System
Impedance	8 Ω	8 Ω	8 Ω
Frequency Response	80 - 20000 Hz	80 - 20000 Hz	100 - 20000 Hz
Sound Pressure Level	81 dB/W (1m)	81 dB/W (1m)	81 dB/W (1m)
Rated Input Power	70 W	70 W	70 W
Max. Input Power	140 W	140 W	140 W
Net Dimensions (W x H x D)	146 x 238 x 183.5 mm	321 x 148 x 158.5 mm	114 x 186 x 146 mm
Net Weight (1EA)	2.2 kg	2.48 kg	1.2 kg
	Surround Center Speaker (SR72BR-S)	Active subwoofer (SR72BR-A)	
Type	Bass Reflex 1 Way 1 Speaker System	Bass Reflex 1 Way 1 Speaker System	
Impedance	8 Ω	4 Ω	
Frequency Response	100 - 20000 Hz	30 - 1000 Hz	
Sound Pressure Level	81 dB/W (1m)	81 dB/W (1m)	
Rated Input Power	70 W	250 W	
Max. Input Power	140 W	500 W	
Net Dimensions (W x H x D)	114 x 186 x 146 mm	266 x 343 x 406 mm	
Net Weight (1EA)	1.2 kg	11.28 kg	

Reference



P/NO : MFL39518807

Free Manuals Download Website

<http://myh66.com>

<http://usermanuals.us>

<http://www.somanuals.com>

<http://www.4manuals.cc>

<http://www.manual-lib.com>

<http://www.404manual.com>

<http://www.luxmanual.com>

<http://aubethermostatmanual.com>

Golf course search by state

<http://golfingnear.com>

Email search by domain

<http://emailbydomain.com>

Auto manuals search

<http://auto.somanuals.com>

TV manuals search

<http://tv.somanuals.com>