



**LG**

Life's Good

## OWNER'S MANUAL

# LED LCD TV / LCD TV / PLASMA TV

Please read this manual carefully before operating the set and retain it for future reference.

### LED LCD TV MODELS

42LV3700	42LV5500	32LW5700	47LW6500
47LV3700	47LV5500	42LW5700	55LW6500
55LV3700	55LV5500	47LW5700	65LW6500
42LV5400	42LW5600	55LW5700	47LW9800
47LV5400	47LW5600		55LW9800
55LV5400	55LW5600		55LV9500

### LCD TV MODELS

42LK530
47LK530
55LK530
42LK550
47LK550

### PLASMA TV MODELS

50PZ750
60PZ750
50PZ950
60PZ950
50PZ950U
60PZ950U

P/NO : SAC34134226 (1105-REV03)

[www.lg.com](http://www.lg.com)

# LICENSES

Supported licenses may differ by model. For more information about licenses, visit [www.lg.com](http://www.lg.com).



Manufactured under license from Dolby Laboratories. "Dolby" and the double-D symbol are trademarks of Dolby Laboratories.



HDMI, the HDMI logo and High-Definition Multimedia Interface are trademarks or registered trademarks of HDMI Licensing LLC.



ABOUT DIVX VIDEO: DivX® is a digital video format created by DivX, Inc. This is an official DivX Certified® device that plays DivX video. Visit [www.divx.com](http://www.divx.com) for more information and software tools to convert your files into DivX video.

ABOUT DIVX VIDEO-ON-DEMAND: This DivX Certified® device must be registered in order to play purchased DivX Video-on-Demand (VOD) movies. To obtain your registration code, locate the DivX VOD section in your device setup menu. Go to [vod.divx.com](http://vod.divx.com) for more information on how to complete your registration.

"DivX Certified® to play DivX® and DivX Plus™ HD (H.264/MKV) video up to 1080p HD including premium content."

"DivX®, DivX Certified® and associated logos are trademarks of DivX, Inc. and are used under license."

"Covered by one or more of the following U.S. patents :  
7,295,673; 7,460,668; 7,515,710; 7,519,274"



## NOTE

- : Plasma TV
- : LED LCD TV, LCD TV
- Image shown may differ from your TV.
- Your TV's OSD (On Screen Display) may differ slightly from that shown in this manual.
- The available menus and options may differ from the input source or product model that you are using.

# IMPORTANT SAFETY INSTRUCTIONS

Always comply with the following precautions to avoid dangerous situations and ensure peak performance of your product.





**WARNING / CAUTION**

**RISK OF ELECTRIC SHOCK  
DO NOT OPEN**



TO REDUCE THE RISK OF ELECTRIC SHOCK DO NOT REMOVE COVER (OR BACK). NO USER SERVICEABLE PARTS INSIDE. REFER TO QUALIFIED SERVICE PERSONNEL.

 The lightning flash with arrowhead symbol, within an equilateral triangle, is intended to alert the user to the presence of uninsulated "dangerous voltage" within the product's enclosure that may be of sufficient magnitude to constitute a risk of electric shock to persons.

 The exclamation point within an equilateral triangle is intended to alert the user to the presence of important operating and maintenance (servicing) instructions in the literature accompanying the appliance.

**WARNING/CAUTION**

- TO REDUCE THE RISK OF FIRE AND ELECTRIC SHOCK, DO NOT EXPOSE THIS PRODUCT TO RAIN OR MOISTURE.

Read these instructions.  
Keep these instructions.  
Heed all warnings.  
Follow all instructions.

- Do not use this apparatus near water.



- Clean only with a dry cloth.



- Do not block any ventilation openings. Install in accordance with the manufacturer's instructions.

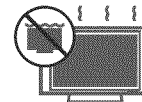

- Do not install near any heat sources such as radiators, heat registers, stoves, or other apparatus (including amplifiers) that produce heat.



- Do not defeat the safety purpose of the polarized or grounding-type plug. A polarized plug has two blades with one wider than the other. A grounding type plug has two blades and a third grounding prong. The wide blade or the third prong are provided for your safety. If the provided plug does not fit into your outlet, consult an electrician for replacement of the obsolete outlet (Can differ by country).

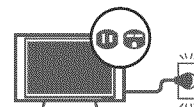

- Protect the power cord from being walked on or pinched particularly at plugs, convenience receptacles, and the point where they exit from the apparatus.



- Only use attachments/accessories specified by the manufacturer.

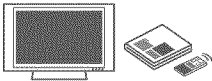

- Use only with a cart, stand, tripod, bracket, or table specified by the manufacturer, or sold with the apparatus. When a cart is used, use caution when moving the cart/apparatus combination to avoid injury from tip-over.



- Unplug this apparatus during lightning storms or when unused for long periods of time.

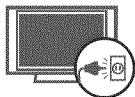

- Refer all servicing to qualified service personnel. Servicing is required when the apparatus has been damaged in any way, such as power-supply cord or plug is damaged, liquid has been spilled or objects have fallen into the apparatus, the apparatus has been exposed to rain or moisture, does not operate normally, or has been dropped.

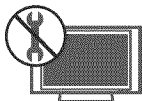

- Never touch this apparatus or antenna during a thunder or lightning storm.
- When mounting a TV on the wall, make sure not to install the TV by hanging the power and signal cables on the back of the TV.

- Do not allow an impact shock or any objects to fall into the product, and do not drop anything onto the screen.

- CAUTION concerning the Power Cord (Can differ by country):

It is recommended that appliances be placed upon a dedicated circuit; that is, a single outlet circuit which powers only that appliance and has no additional outlets or branch circuits. Check the specification page of this owner's manual to be certain. Do not connect too many appliances to the same AC power outlet as this could result in fire or electric shock. Do not overload wall outlets. Overloaded wall outlets, loose or damaged wall outlets, extension cords, frayed power cords, or damaged or cracked wire insulation are dangerous. Any of these conditions could result in electric shock or fire. Periodically examine the cord of your appliance, and if its appearance indicates damage or deterioration, unplug it, discontinue use of the appliance, and have the cord replaced with an exact replacement part by an authorized service. Protect the power cord from physical or mechanical abuse, such as being twisted, kinked, pinched, closed in a door, or walked upon. Pay particular attention to plugs, wall outlets, and the point where the cord exits the appliance. Do not move the TV with the power cord plugged in. Do not use a damaged or loose power cord. Be sure do grasp the plug when unplugging the power cord. Do not pull on the power cord to unplug the TV.

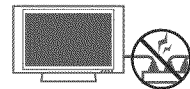

- **Warning** - To reduce the risk of fire or electrical shock, do not expose this product to rain, moisture or other liquids. Do not touch the TV with wet hands. Do not install this product near flammable objects such as gasoline or candles, or expose the TV to direct air conditioning.

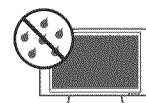

- Do not expose to dripping or splashing and do not place objects filled with liquids, such as vases, cups, etc. on or over the apparatus (e.g. on shelves above the unit).

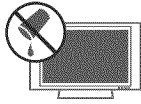

**Grounding**

Ensure that you connect the earth ground wire to prevent possible electric shock (i.e. a TV with a three-prong grounded AC plug must be connected to a three-prong grounded AC outlet). If grounding methods are not possible, have a qualified electrician install a separate circuit breaker. Do not try to ground the unit by connecting it to telephone wires, lightning rods, or gas pipes.

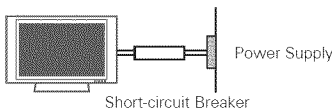

**DISCONNECTING DEVICE FROM THE MAIN POWER**

The power outlet must remain readily accessed in the event the device needs to be unplugged.

- As long as this unit is connected to the AC wall outlet, it is not disconnected from the AC power source even if the unit is turned off.
- Do not attempt to modify this product in any way without written authorization from LG Electronics. Unauthorized modification could void the user's authority to operate this product.

**ANTENNAS Outdoor antenna grounding**  
(Can differ by country):

If an outdoor antenna is installed, follow the precautions below. An outdoor antenna system should not be located in the vicinity of overhead power lines or other electric light or power circuits, or where it can come in contact with such power lines or circuits as death or serious injury can occur. Be sure the antenna system is grounded so as to provide some protection against voltage surges and built-up static charges. Section 810 of

the National Electrical Code (NEC) in the U.S.A. provides information with respect to proper grounding of the mast and supporting structure, grounding of the lead-in wire to an antenna discharge unit, size of grounding conductors, location of antenna discharge unit, connection to grounding electrodes and requirements for the grounding electrode.

**Antenna grounding according to the National Electrical Code, ANSI/NFPA 70**

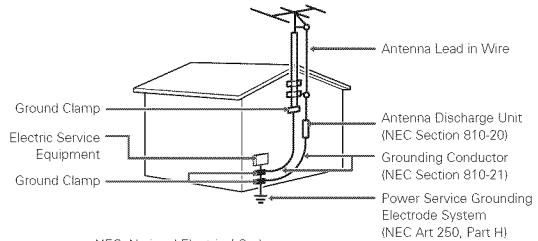

NEC: National Electrical Code

**Cleaning**

When cleaning, unplug the power cord and wipe gently with a soft cloth to prevent scratching. Do not spray water or other liquids directly on the TV as electric shock may occur. Do not clean with chemicals such as alcohol, thinners or benzine.

**Moving**

Make sure the product is turned off, unplugged and all cables have been removed. It may take 2 or more people to carry larger TVs. Do not press or put stress on the front panel of the TV.

**Ventilation**

Install your TV where there is proper ventilation. Do not install in a confined space such as a bookcase. Do not cover the product with cloth or other materials while plugged. Do not install in excessively dusty places.

- If you smell smoke or other odours coming from the TV, unplug the power cord contact an authorized service center.
- Do not press strongly upon the panel with hand or sharp object such as nail, pencil or pen, or make a scratch on it.
- Keep the product away from direct sunlight.

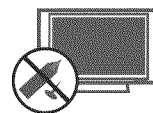

ENGLISH

- **Dot Defect**

The Plasma or LCD panel is a high technology product with resolution of two million to six million pixels. In a very few cases, you could see fine dots on the screen while you're viewing the TV. Those dots are deactivated pixels and do not affect the performance and reliability of the TV.

- **Generated Sound**

"Cracking" noise: A cracking noise that occurs when watching or turning off the TV is generated by plastic thermal contraction due to temperature and humidity. This noise is common for products where thermal deformation is required.

Electrical circuit humming/panel buzzing: A low level noise is generated from a high-speed switching circuit, which supplies a large amount of current to operate a product. It varies depending on the product.

This generated sound does not affect the performance and reliability of the product.

- Take care not to touch the ventilation openings. When watching the TV for a long period, the ventilation openings may become hot. This does not affect the performance of the product or cause defects in the product.

- **Viewing 3D Imaging (For 3D TV)**

- If you watch the 3D imaging too closely or for a long period of time, it may harm your eyesight.
- Watching the TV or playing video games that incorporate 3D imaging with the 3D glasses for a long period of time can cause drowsiness, headaches or fatigue to you and/or your eyes. If you have a headache, or otherwise feel fatigued or drowsy, stop watching the TV and have a rest.
- Pregnant woman, seniors, persons with heart problems or persons who experience frequent drowsiness should refrain from watching 3D TV.
- Some 3D imaging may cause you to duck or dodge the image displayed in the video. Therefore, it is best if you do not watch 3D TV near fragile objects or near any objects that can be knocked over easily.
- Please prevent children under the age of 5 from watching 3D TV. It may affect their vision development.
- Warning for photosensitization seizure: Some

viewers may experience a seizure or epilepsy when exposed to certain factors, including flashing lights or images in TV or video games. If you or anybody from your family has a history of epilepsy or seizure, please consult with your doctor before watching 3D TV.

Also certain symptoms can occur in unspecified conditions without any previous history. If you experience any of the following symptoms, immediately stop watching the 3D imaging and consult a doctor: dizziness or light-headedness, visual transition or altered vision, visual or facial instability, such as eye or muscle twitching, unconscious action, convulsion, loss of conscience, confusion or disorientation, loss of directional sense, cramps, or nausea. Parents should monitor their children, including teenagers, for these symptoms as they may be more sensitive to the effects of watching 3D TV.

Risk of photosensitization seizure can be reduced with the following actions.

- Take frequent breaks from watching 3D TV.
- For those who have vision that is different in each eye, they should watch the TV after taking vision correction measures.
- Watch the TV so that your eyes are on the same level as the 3D screen and refrain from sitting too closely to the TV.
- Do not watch the 3D imaging when tired or sick, and avoid watching the 3D imaging for a long period of time.
- Do not wear the 3D glasses for any other purpose than viewing 3D imaging on a 3D TV.
- Some viewers may feel disoriented after watching 3D TV. Therefore, after you watch 3D TV, take a moment to regain awareness of your situation before moving.



- If the TV feels cold to the touch, there may be a small “flicker” when it is turned on. This is normal, there is nothing wrong with TV. Some minute dot defects may be visible on the screen, appearing as tiny red, green, or blue spots. However, they have no adverse effect on the TV’s performance. Avoid touching the LCD screen or holding your finger(s) against it for long periods of time. Doing so may produce some temporary distortion effects on the screen.

#### **DISPOSAL (Hg lamp only used in LCD TVs)**

The fluorescent lamp used in this product contains a small amount of mercury. Do not dispose of this product with general household waste. Disposal of this product must be carried out in accordance to the regulations of your local authority.

#### **For USA**

##### **NOTE TO CABLE/TV INSTALLER**

This reminder is provided to call the CATV system installer’s attention to Article 820-40 of the National Electric Code (U.S.A.). The code provides guidelines for proper grounding and, in particular, specifies that the cable ground shall be connected to the grounding system of the building, as close to the point of the cable entry as practical.

# TABLE OF CONTENTS

## 2 LICENSES

---

## 3 IMPORTANT SAFETY INSTRUCTIONS

---

## 8 TABLE OF CONTENTS

---

## 10 ASSEMBLING AND PREPARING

---

- 10 Unpacking
- 13 Optional Extras
- 14 Parts and buttons
- 22 Lifting and moving the TV
- 22 Setting up the TV
  - 22 - Attaching the stand
  - 28 - Mounting on a table
  - 30 - Mounting on a wall
  - 31 - Tidying cables

## 32 REMOTE CONTROL

---

- 36 Magic Motion Remote Control Functions
  - 37 - Registering Magic Motion Remote Control
  - 37 - How to use Magic Motion Remote Control
  - 37 - Precautions to Take when Using the Magic Motion Remote Control

## 38 WATCHING TV

---

- 38 Connecting to an antenna or cable
  - 38 - Connecting an antenna or basic cable
  - 38 - Connecting a cable box
- 39 Turning the TV on for the first time
- 40 Watching TV
- 41 Accessing Home Menu
- 42 Managing channels
  - 42 - Setting up channels

- 43 - Using favorite channels
- 44 - Checking current program info
- 45 Using additional options
  - 45 - Adjusting aspect ratio
  - 46 - Changing AV modes
  - 46 - Using the input list
- 47 Using the quick menu

## 48 ENTERTAINMENT

---

- 48 Network Connection
  - 48 - Connecting to a wired network
  - 49 - Connecting to a wireless network
    - 50 - When a security code is already set
  - 53 - Network Status
- 54 Premium Account Function
  - 54 - Notice
- 56 LG Apps function
  - 56 - Registration LG Apps
  - 57 - Sign in with LG Apps account
  - 58 - Using LG Apps
  - 59 - Using My Apps
- 60 Search
- 61 Web Browser Function
  - 61 - Using Web Browser
  - 62 - Browsing Favorite Websites
  - 62 - Browsing Websites by Directly Entering Address
    - 63 - Viewing Visited Website List
- 64 Smart Share Function
  - 64 - Connecting USB storage devices
  - 65 - Connecting DLNA DMP (Digital Living Network Alliance, Digital Media Player)
  - 68 - Connecting DLNA DMR (Digital Living Network Alliance, Digital Media Render)
    - 69 - Browsing files
    - 70 - Viewing Videos
    - 73 - DivX registration code
    - 74 - Viewing Photos
    - 76 - Listening to music



- 78 Media Link Function
- 78 - Media Link Connection
- 79 - Using Media Link
- 79 - Viewing Movies
- 80 - Using Music Section
- 80 - Using TV Program Section
- 81 - Installing Plug-Ins

## **82 3D IMAGING (FOR 3D TV)**

---

- 82 3D Technology
- 82 - When watching 3D imaging
- 83 - When using 3D Glasses
- 83 - 3D Imaging Viewing Range 
- 84 Viewing 3D Imaging
- 84 - Setting 3D Imaging

## **86 CUSTOMIZING TV SETTINGS**

---

- 86 The SETUP Menu
- 87 Customizing Settings
- 87 - CHANNEL Settings
- 88 - PICTURE Settings
- 93 - AUDIO Settings
- 95 - TIME Settings
- 96 - LOCK Settings
- 98 - OPTION Settings
- 101 - NETWORK Settings
- 102 - SUPPORT Settings

## **103 MAKING CONNECTIONS**

---

- 104 Connection Overview
- 105 Connecting to a HD receiver, DVD, or VCR player
- 105 - HDMI Connection
- 106 - DVI to HDMI Connection
- 107 - Component Connection
- 108 - Composite Connection
- 110 Connecting to a PC

- 110 - HDMI Connection
- 111 - DVI to HDMI Connection
- 112 - RGB Connection
- 113 Connecting to an Audio System
- 113 - Digital Optical Audio Connection
- 115 Connecting to a USB
- 115 Connecting to a Headphone 
- 116 Connecting the Wireless Media Box
- 117 SIMPLINK Connection
- 117 - Activating and Using the SIMPLINK menus

## **118 MAINTENANCE**

---

- 118 Updating the TV Firmware
- 119 Cleaning Your TV
- 119 - Screen and frame
- 119 - Cabinet and stand
- 119 - Power cord
- 119 Preventing "Image burn" or "Burn-in" on your TV screen

## **120 TROUBLESHOOTING**

---

## **122 SPECIFICATIONS**

---

## **130 IR CODES**

---

## **132 EXTERNAL CONTROL DEVICE SETUP**

---

## **140 OPEN SOURCE LICENSE**

---

# ASSEMBLING AND PREPARING

## Unpacking

Check your product box for the following items. If there are any missing accessories, contact the local dealer where you purchased your product. The illustrations in this manual may differ from the actual product and item.



### CAUTION

- Do not use any unapproved items to ensure the safety and product life span.
- Any damages or injuries by using unapproved items are not covered by the warranty.
- In case of some model, the thin film on screen is a part of TV, So don't take it off.



### NOTE

- The items supplied with your product may vary depending on the model.
- Product specifications or contents of this manual may be changed without prior notice due to upgrade of product functions.
- New features may be added to this TV in the future.

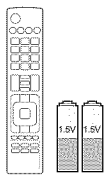

Remote control,  
Batteries (AAA)

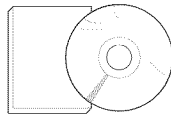

Owner's manual,  
CD manual

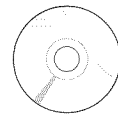

Nero MediaHome 4 Essentials  
CD



Polishing cloth<sup>1</sup>  
(Depending on model)



Cleansing Cloths (Mitt)<sup>2</sup>  
(Depending on model)

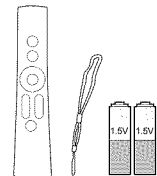

Magic Motion Remote Control<sup>3</sup>,  
Strap,  
Batteries (AA)  
(Except LV3700, LV5400,  
LW5700, LK530, LK550 series)

- 1 Gently wipe the spots on the cabinet with the polishing cloth.
- 2 Wipe spots on the exterior only with the cleansing cloths. Do not wipe roughly when removing stains. Excessive pressure may cause scratches or discoloration. For cleaning front frame, please slowly wipe in one direction after spraying water 1-2 times on cleansing cloths. Please remove excessive moisture after cleaning. Excessive moisture may cause water stains on the frame.
- 3 Sold separately for LV3700, LV5400, LW5700, LK530, LK550 series.



Water

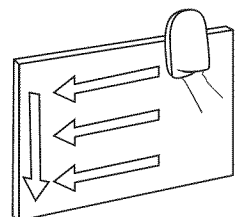

PZ750, PZ950, PZ950U series

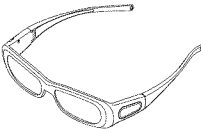
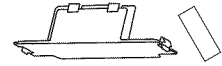
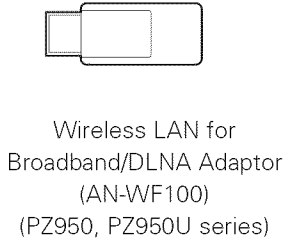
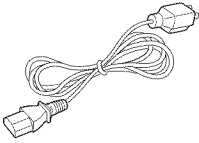
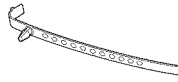
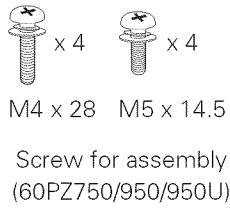
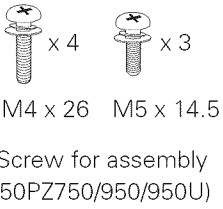

ENGLISH

LV3700, LV5400, LV5500, LV9500, LW5600, LW5700, LW6500, LW9800 series

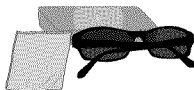
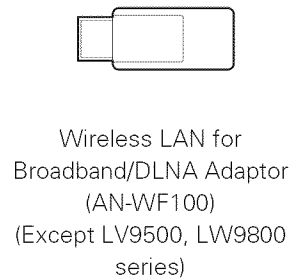
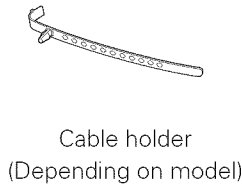
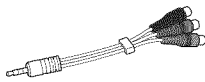
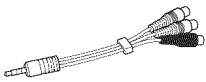
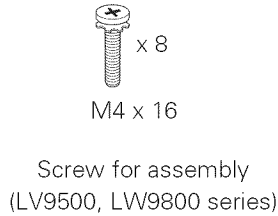
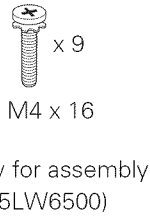
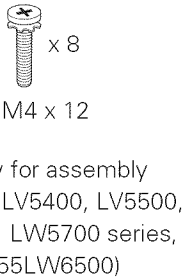

(LW5600, LW5700, LW6500, LW9800 series)

<sup>1</sup> The number of 3D glasses may differ depending on the model or country.

LK530, LK550 series



M4 x 20

Screw for assembly



Protection cover

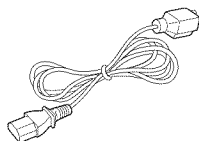

Power cord



Screw for fixing  
(42LK530, 42LK550)

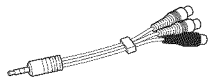

Composite gender cable

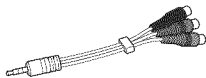

Component gender cable

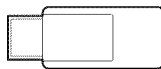

Wireless LAN for  
Broadband/DLNA Adaptor  
(AN-WF100)

**NOTE**

- How to use the ferrite core

1 Use the ferrite core to reduce the electromagnetic interference in the LAN cable.  
Wind the LAN cable on the ferrite core once. Place the ferrite core close to the TV.



2 Use the ferrite core to reduce the electromagnetic interference in the PC audio cable.  
Wind the PC audio cable on the ferrite core thrice. Place the ferrite core close to the TV.

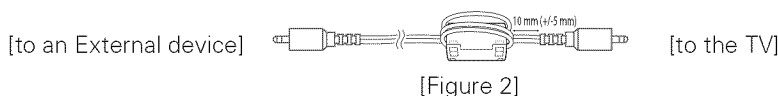

3 Use the ferrite core to reduce the electromagnetic interference in the power cable.  
Wind the power cable on the ferrite core once. Place the ferrite core close to the TV and a wall plug.



- If there is one ferrite core, follow as shown in Figure 1.
- If there are two ferrite cores, follow as shown in Figures 1 and 2.
- If there are three ferrite cores, follow as shown in Figures 1 and 3.
- If there are four ferrite cores, follow as shown in Figures 1, 2 and 3.

- For an optimal connection, HDMI cables and USB devices should have bezels less than 10 mm (0.39 inch) thick and 18 mm (0.7 inch) width.

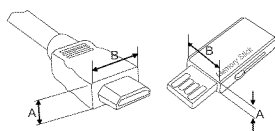

\*A 10 mm (0.39 inch)  
\*B 18 mm (0.7 inch)

## Optional Extras

Optional extras can be changed or modified for quality improvement without any notification.

Contact your dealer for buying these items.

These device only works with compatible LG LED LCD TV, LCD TV, or Plasma TV.

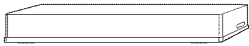

Wireless Media Box<sup>1</sup>  
(AN-WL100W)



3D Glasses<sup>2</sup>  
(AG-S230, AG-S250, AG-S270)



Wireless LAN for Broadband/DLNA  
Adaptor<sup>3</sup>  
(AN-WF100)



Magic Motion Remote  
(AN-MR200)

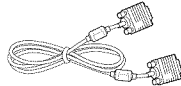

D-sub 15 pin signal cable<sup>4</sup>

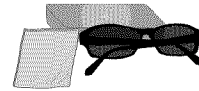

FPR 3D Glasses<sup>5</sup>  
(AG-F2\*\*)

- 1 Supports for LV3700, LV5400, LV5500, LV9500, LW5600, LW5700, LW6500, LW9800, PZ750, PZ950, PZ950U series
- 2 Supports for PZ750, PZ950, PZ950U series
- 3 Unnecessary for LV9500, LW9800 series
- 4 When using the VGA (D-sub 15 pin signal cable) PC connection, use the shielded signal interface cable with a ferrite core to maintain standards compliance for the product.
- 5 Supports for LW5600, LW5700, LW6500, LW9800 series  
The model name or design of 3D glasses may be changed without prior notice due to upgrade of product functions.

## Parts and buttons

PZ750, PZ950, PZ950U series

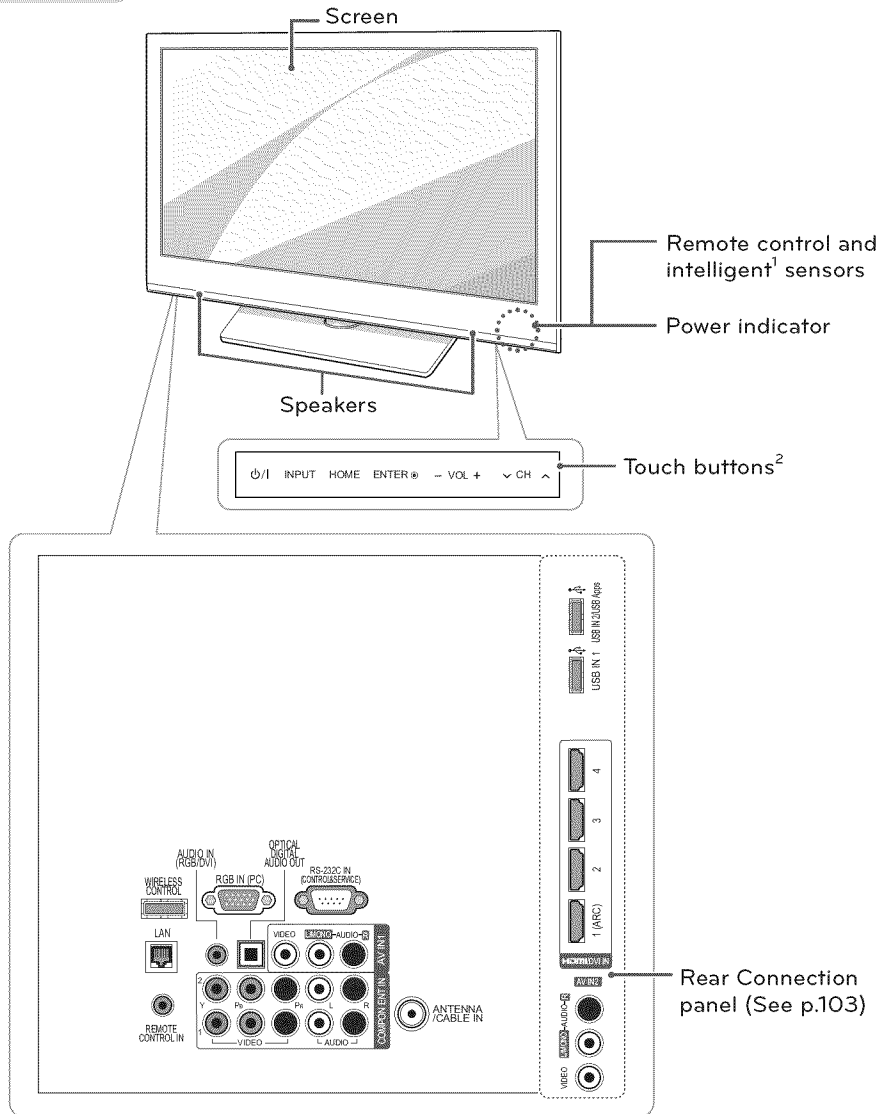

ENGLISH

Touch button <sup>2</sup>	Description
⏻ / I	Turns the power on or off.
INPUT	Changes the input source.
HOME	Accesses the Home menu, or saves your input and exits the menus.
ENTER ●	Selects the highlighted menu option or confirms an input
- VOL +	Adjusts the volume level.
∨ CH ^	Scrolls through the saved channels.

- 1 Intelligent sensor - Adjusts the image quality and brightness based on the surrounding environment.
- 2 All of the buttons are touch sensitive and can be operated through simple touch with your finger.

LV5400, LV5500, LW6500 series

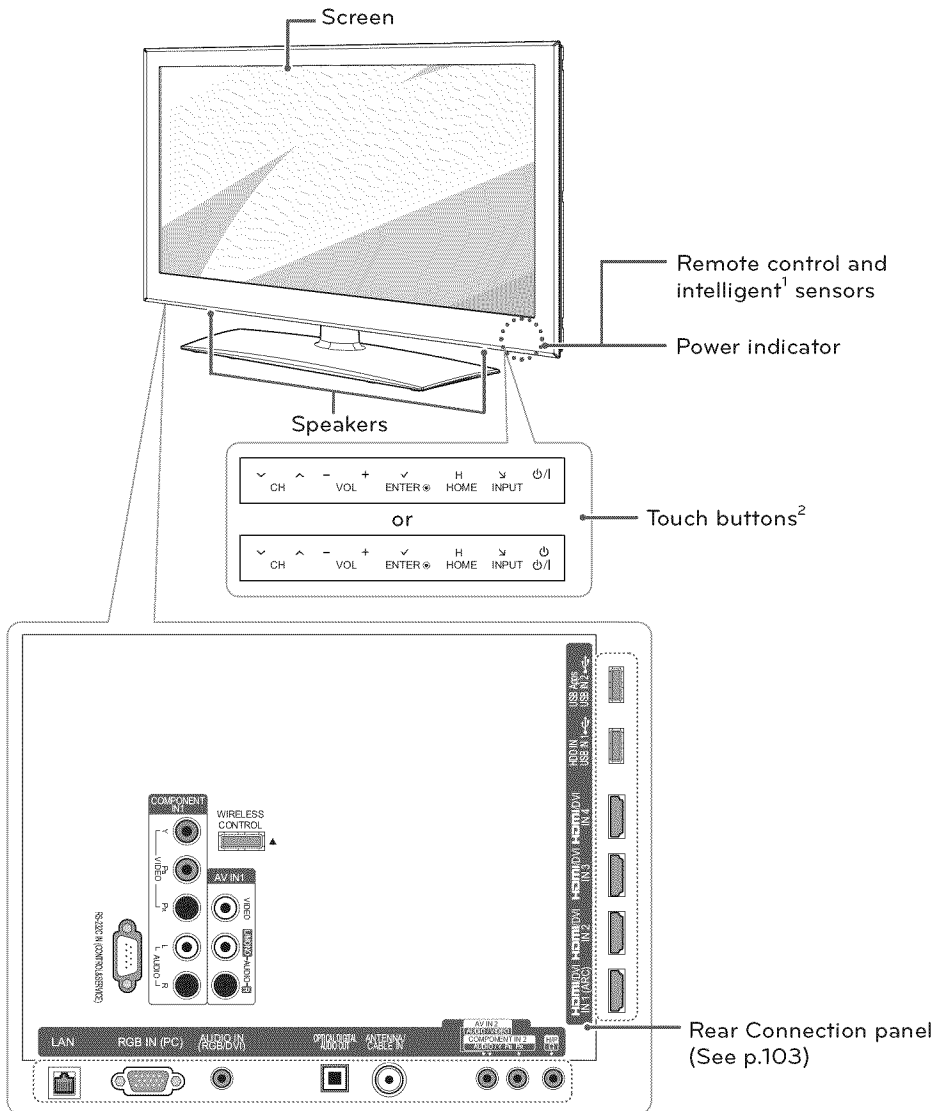

ENGLISH

Touch button <sup>2</sup>	Description
⏻ / ⏻	Turns the power on or off.
INPUT	Changes the input source.
HOME	Accesses the Home menu, or saves your input and exits the menus.
ENTER ●	Selects the highlighted menu option or confirms an input
- VOL +	Adjusts the volume level.
√ CH ^	Scrolls through the saved channels.

- 1 Intelligent sensor - Adjusts the image quality and brightness based on the surrounding environment.
- 2 All of the buttons are touch sensitive and can be operated through simple touch with your finger.

**NOTE**

- You can set the power indicator light to on or off by selecting **OPTION** in the Home menu - SETUP.

LW5700 series

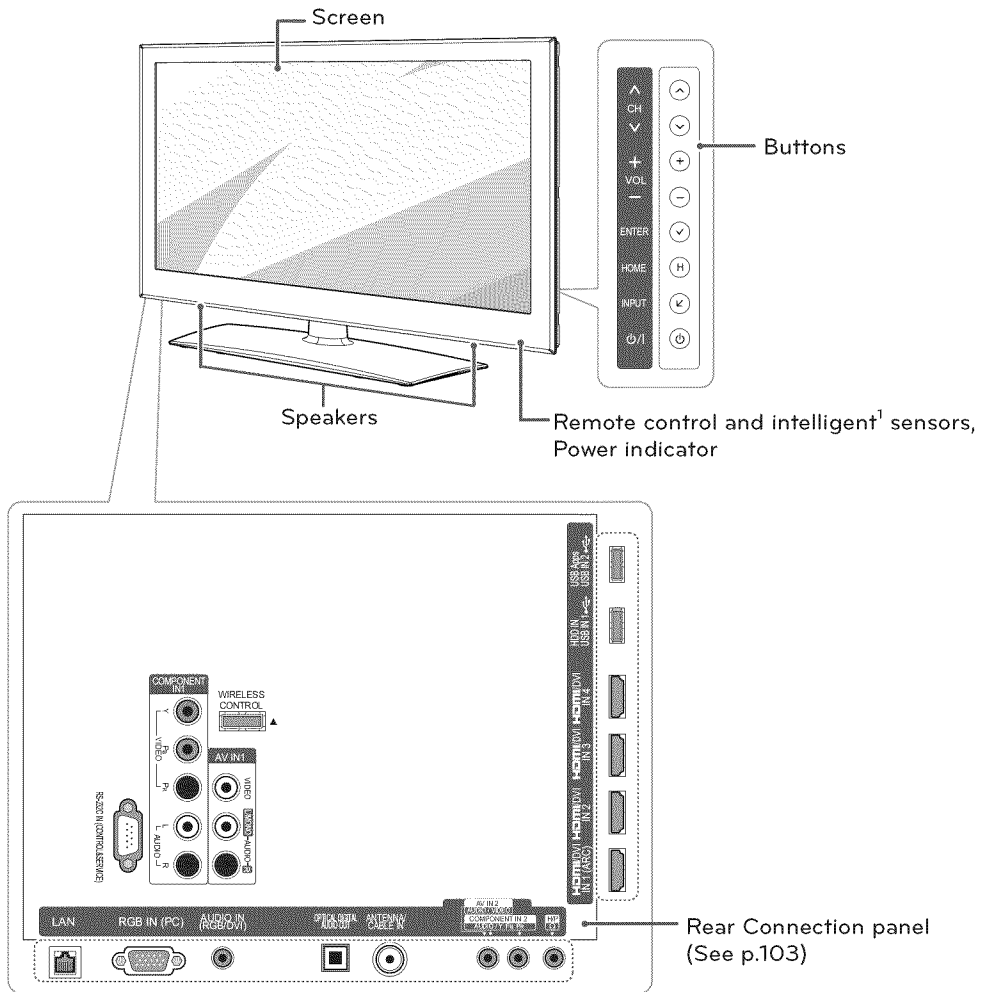

ENGLISH

Button	Description
Power / I	Turns the power on or off.
INPUT	Changes the input source.
HOME	Accesses the Home menu, or saves your input and exits the menus.
ENTER ●	Selects the highlighted menu option or confirms an input
- VOL +	Adjusts the volume level.
∨ CH ^	Scrolls through the saved channels.

1 Intelligent sensor - Adjusts the image quality and brightness based on the surrounding environment.

**NOTE**

- You can set the power indicator light to on or off by selecting **OPTION** in the Home menu - SETUP.



LW5600 series

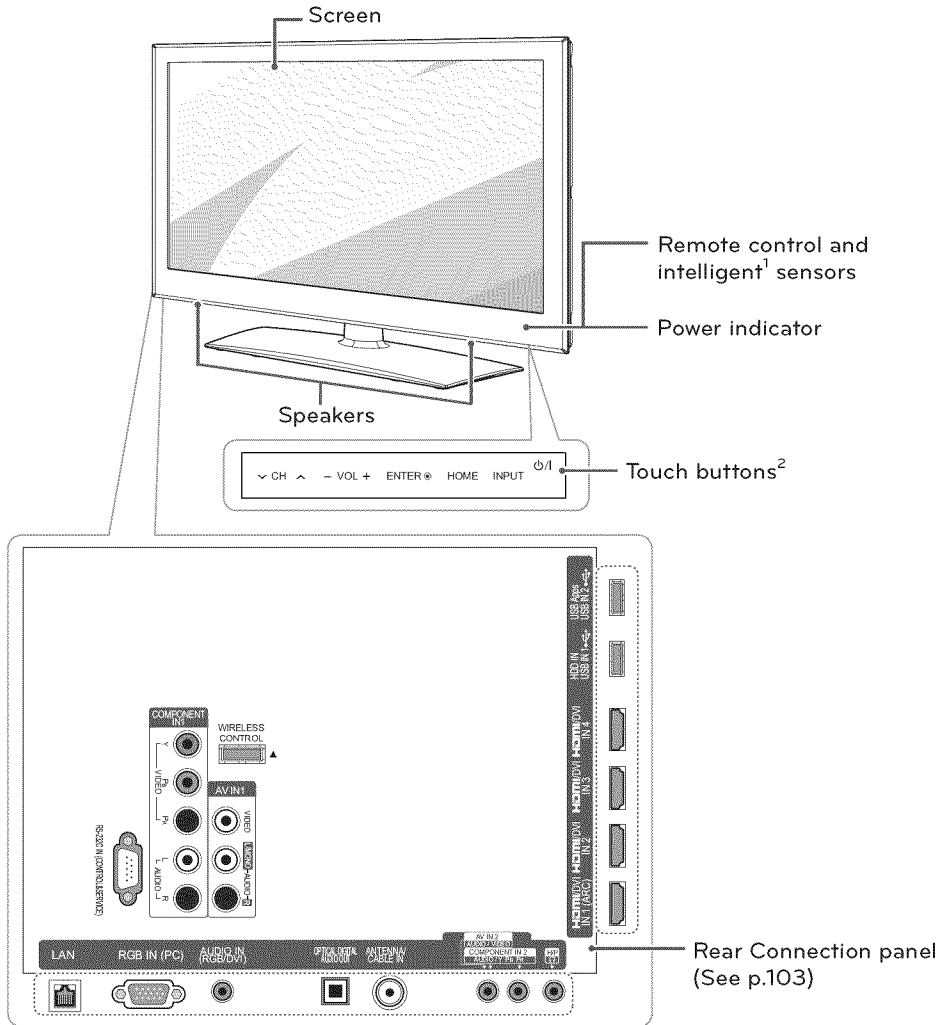

ENGLISH

Touch button <sup>2</sup>	Description
⏻ / I	Turns the power on or off.
INPUT	Changes the input source.
HOME	Accesses the Home menu, or saves your input and exits the menus.
ENTER ●	Selects the highlighted menu option or confirms an input
- VOL +	Adjusts the volume level.
∨ CH ^	Scrolls through the saved channels.

- 1 Intelligent sensor - Adjusts the image quality and brightness based on the surrounding environment.
- 2 All of the buttons are touch sensitive and can be operated through simple touch with your finger.

**NOTE**

• You can set the power indicator light to on or off by selecting **OPTION** in the Home menu - SETUP.

LV9500, LW9800 series

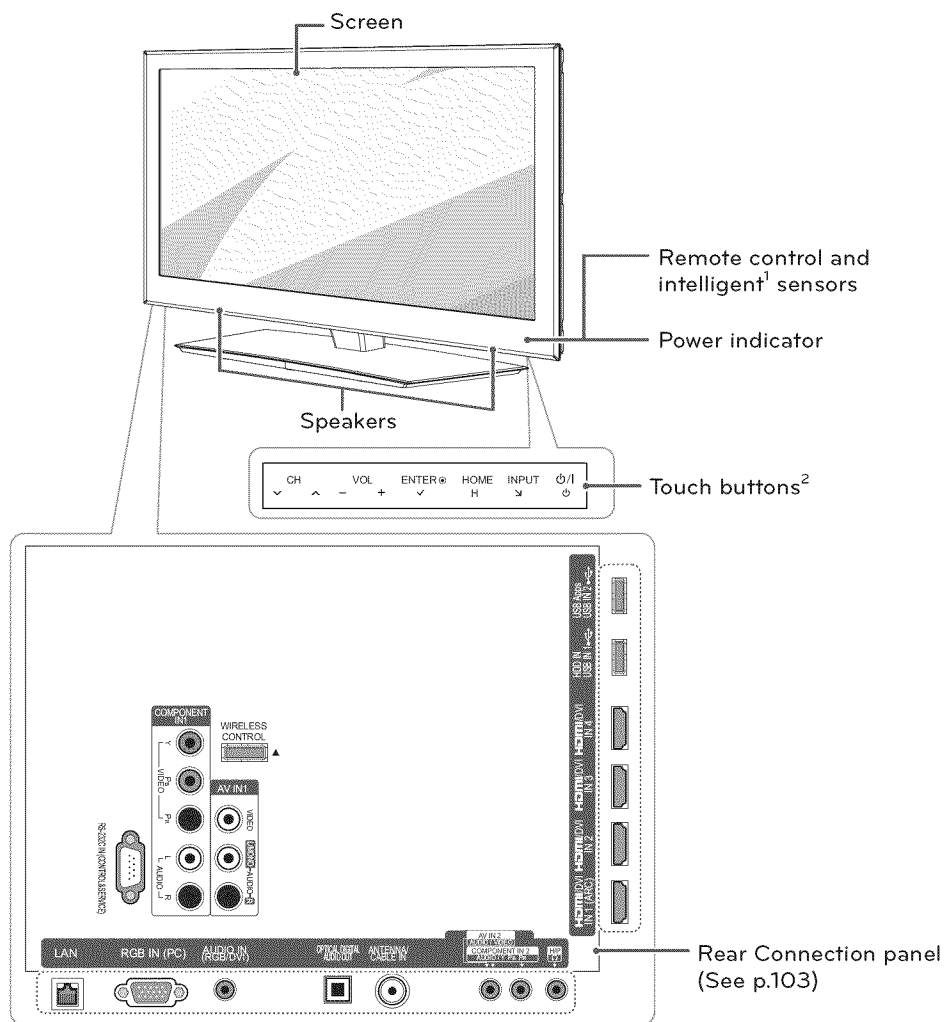

ENGLISH

Touch button <sup>2</sup>	Description
⏻ / I	Turns the power on or off.
INPUT	Changes the input source.
HOME	Accesses the Home menu, or saves your input and exits the menus.
ENTER ●	Selects the highlighted menu option or confirms an input
- VOL +	Adjusts the volume level.
∨ CH ^	Scrolls through the saved channels.

- 1 Intelligent sensor - Adjusts the image quality and brightness based on the surrounding environment.
- 2 All of the buttons are touch sensitive and can be operated through simple touch with your finger.



**NOTE**

- You can set the power indicator light to on or off by selecting **OPTION** in the Home menu - SETUP.

LV3700 series

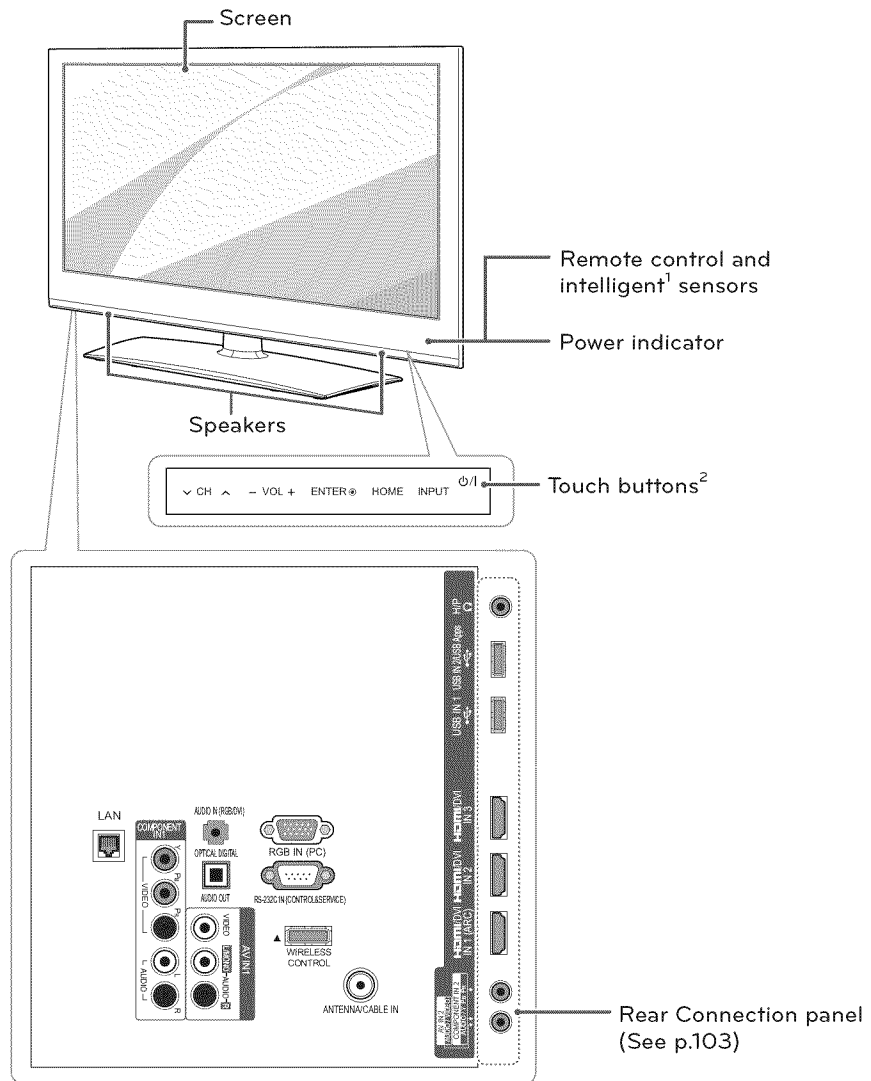

ENGLISH

Touch button <sup>2</sup>	Description
⏻ / I	Turns the power on or off.
INPUT	Changes the input source.
HOME	Accesses the Home menu, or saves your input and exits the menus.
ENTER ●	Selects the highlighted menu option or confirms an input
- VOL +	Adjusts the volume level.
√ CH ^	Scrolls through the saved channels.

- 1 Intelligent sensor - Adjusts the image quality and brightness based on the surrounding environment.
- 2 All of the buttons are touch sensitive and can be operated through simple touch with your finger.

**!** NOTE

- You can set the power indicator light to on or off by selecting **OPTION** in the Home menu - SETUP.

LK550 series

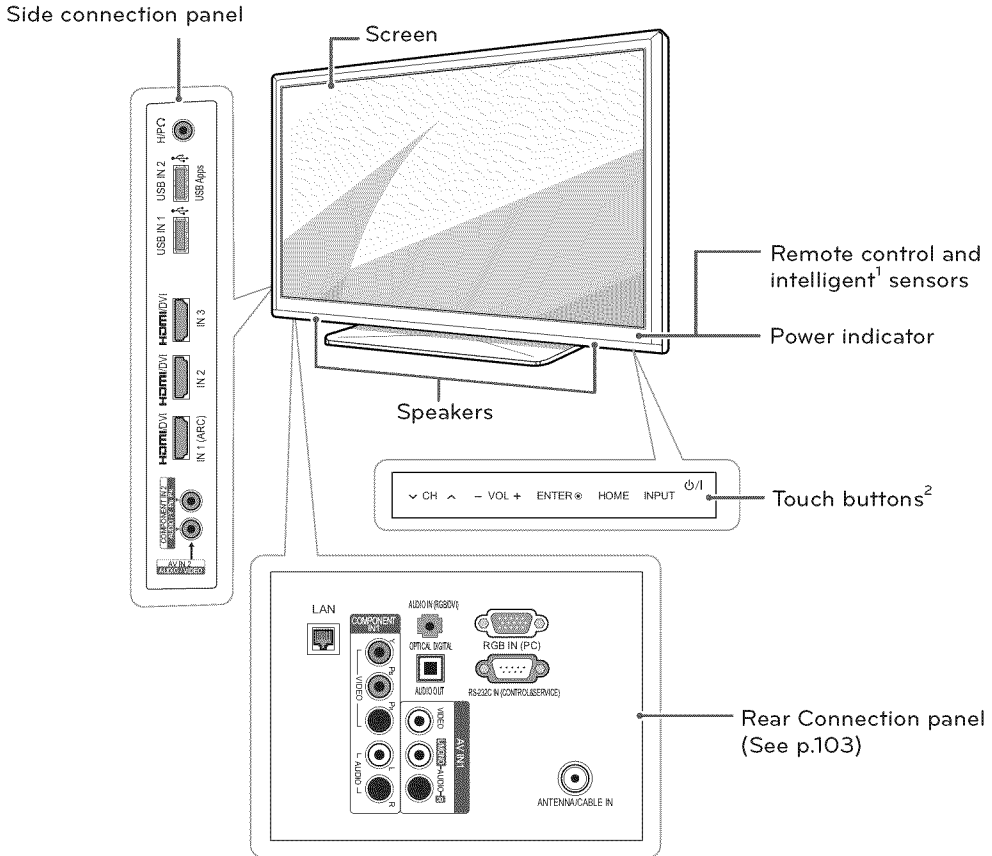

ENGLISH

Touch button <sup>2</sup>	Description
⏻ / I	Turns the power on or off.
INPUT	Changes the input source.
HOME	Accesses the Home menu, or saves your input and exits the menus.
ENTER ●	Selects the highlighted menu option or confirms an input
- VOL +	Adjusts the volume level.
∨ CH ^	Scrolls through the saved channels.

- 1 Intelligent sensor - Adjusts the image quality and brightness based on the surrounding environment.
- 2 All of the buttons are touch sensitive and can be operated through simple touch with your finger.



**NOTE**

- You can set the power indicator light to on or off by selecting **OPTION** in the Home menu - SETUP.

LK530 series

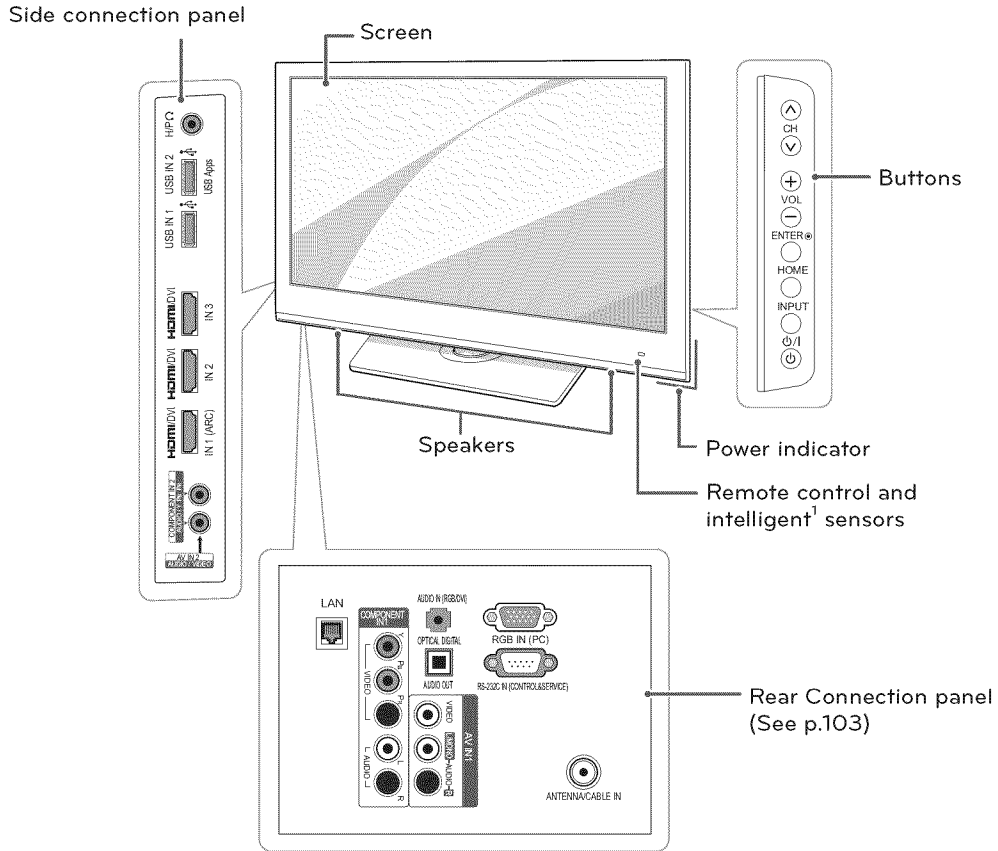

ENGLISH

Button	Description
⏻/I	Turns the power on or off.
INPUT	Changes the input source.
HOME	Accesses the Home menu, or saves your input and exits the menus.
ENTER ●	Selects the highlighted menu option or confirms an input
- VOL +	Adjusts the volume level.
v CH ^	Scrolls through the saved channels.

1 Intelligent sensor - Adjusts the image quality and brightness based on the surrounding environment.

## Lifting and moving the TV

When moving or lifting the TV, read the following to prevent the TV from being scratched or damaged and for safe transportation regardless of its type and size.

**CAUTION**

- Avoid touching the screen at all times, as this may result in damage to the screen.

- It is recommended to move the TV in the box or packing material that the TV originally came in.
- Before moving or lifting the TV, disconnect the power cord and all cables.
- When holding the TV, the screen should face away from you to avoid damage.



- Hold the top and bottom of the TV frame firmly. Make sure not to hold the transparent part, speaker, or speaker grill area.

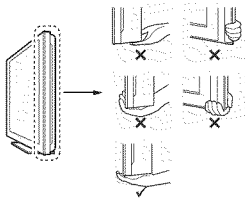

- When transporting a large TV, there should be at least 2 people.
- When transporting the TV by hand, hold the TV as shown in the following illustration.

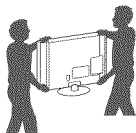

- When transporting the TV, do not expose the TV to jolts or excessive vibration.
- When transporting the TV, keep the TV upright, never turn the TV on its side or tilt towards the left or right.

## Setting up the TV

Put your TV on a pedestal stand and mount the TV on a table or wall.

### Attaching the stand

If you are not mounting the TV to a wall, use the following instructions to attach the stand.

**PZ750, PZ950, PZ950U series**

- 1 Lay the TV with the screen side down on a flat surface.

**CAUTION**

- Lay a foam mat or soft protective cloth on the surface to protect the screen from damage. Make sure no objects press against the screen.

- 2 Assemble the parts of the stand body with the stand base of the TV.

Model	Screw for assembly	Number of screws
50PZ750, 50PZ950, 50PZ950U	M5 x 14.5	3
60PZ750, 60PZ950, 60PZ950U	M5 x 14.5	4

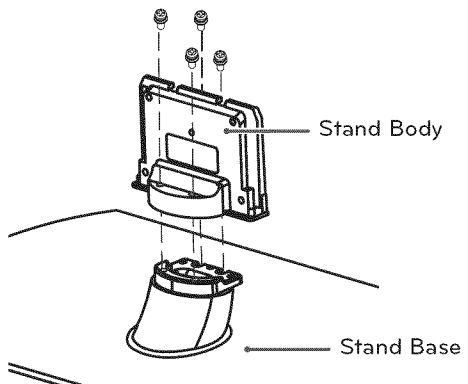
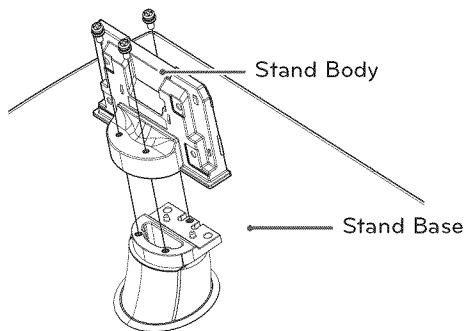

- 3 Secure the TV and the stand with the 4 screws.

Model	Screw for assembly	Number of screws
50PZ750, 50PZ950, 50PZ950U	M4 x 26	4
60PZ750, 60PZ950, 60PZ950U	M4 x 28	4

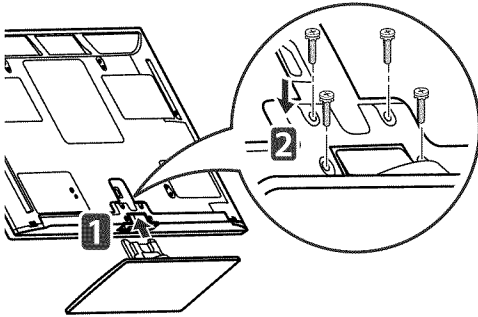

**CAUTION**

- Tighten the screws firmly to prevent the TV from tilting forward. Do not over tighten.

To detach the stand,

- 1 Lay the TV with the screen side down on a flat surface.
- 2 Remove the 4 screws and pull the stand away from the TV.

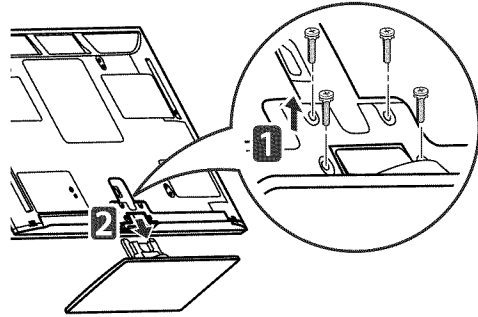

- 3 Push the supplied protection cover into the opening at the bottom of the TV until it locks in place.

Attach the protection cover tape.

- This will protect the opening from accumulating dust and dirt.
- When installing the wall mounting bracket, use the protection cover.

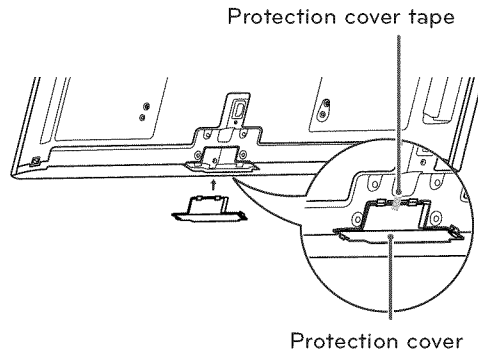

ENGLISH

LV3700, LV5400, LV5500, LW5600,  
LW5700, LW6500 series

- 1 Lay the TV with the screen side down on a flat surface.

**CAUTION**

- Lay a foam mat or soft protective cloth on the surface to protect the screen from damage. Make sure no objects press against the screen.

- 2 Assemble the parts of the stand body with the stand base of the TV.

Model	Screw for assembly	Number of screws
LV3700, LV5400, LV5500, LW5600, LW5700 series, 47/55LW6500	M4 x 12	4
65LW6500	M4 x 16	4

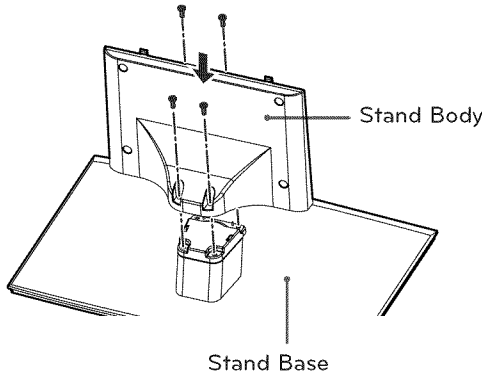

- 3 Assemble the TV as shown.

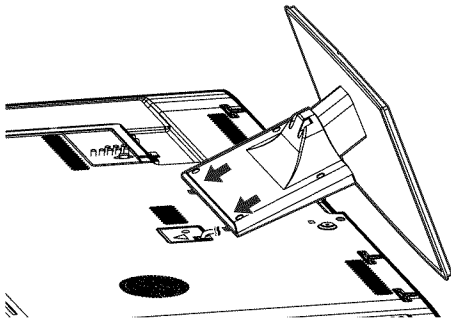

- 4 Secure the TV and the stand with the screws.

Model	Screw for assembly	Number of screws
LV3700, LV5400, LV5500, LW5600, LW5700 series, 47/55LW6500	M4 x 12	4
65LW6500	M4 x 16	5

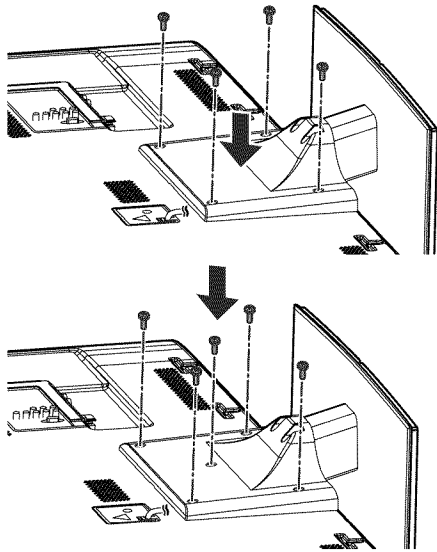

**CAUTION**

- Tighten the screws firmly to prevent the TV from tilting forward. Do not over tighten.

To detach the stand,

- 1 Lay the TV with the screen side down on a flat surface.
- 2 Remove the 4 screws and pull the stand away from the TV.

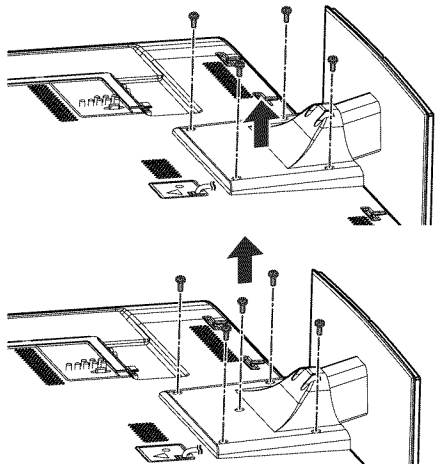



LV9500, LW9800 series

- 1 Lay the TV with the screen side down on a flat surface.



**CAUTION**

- Lay a foam mat or soft protective cloth on the surface to protect the screen from damage. Make sure no objects press against the screen.

- 2 Assemble the parts of the stand body with the stand base of the TV.

Screw for assembly	Number of screws
M4 x 16	4

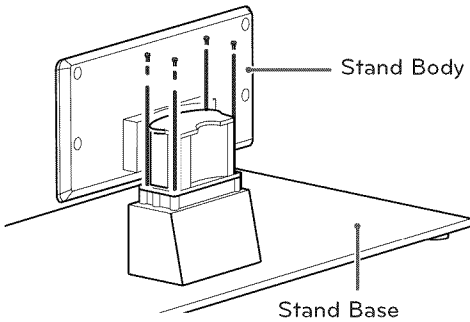

- 3 Assemble the parts of the stand rear cover with the TV.

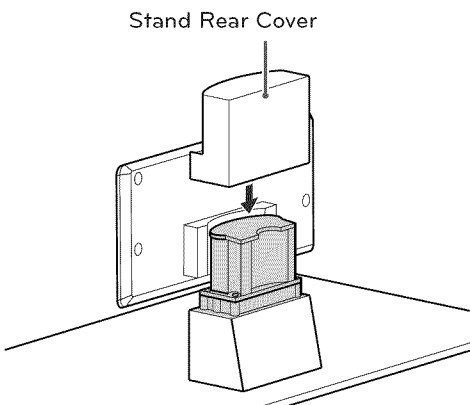

- 4 Secure the TV and the stand with the 4 screws.

Screw for assembly	Number of screws
M4 x 16	4

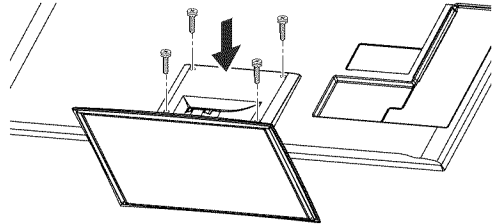

**CAUTION**

- Tighten the screws firmly to prevent the TV from tilting forward. Do not over tighten.

To detach the stand,

- 1 Lay the TV with the screen side down on a flat surface.
- 2 Remove the 4 screws and pull the stand away from the TV.

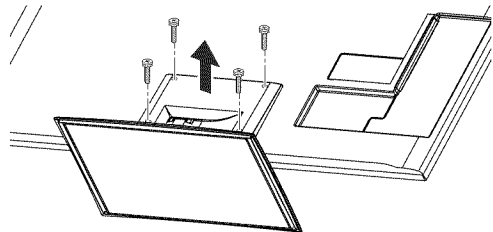

ENGLISH

LK530, LK550 series

- 1 Lay the TV with the screen side down on a flat surface.



**CAUTION**

- Lay a foam mat or soft protective cloth on the surface to protect the screen from damage. Make sure no objects press against the screen.

- 2 Assemble the parts of the stand body with the stand base of the TV.

Screw for assembly	Number of screws
M4 x 20	4

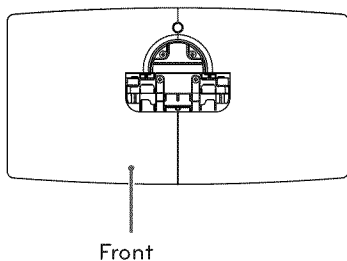
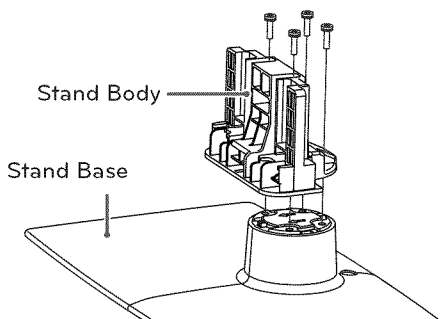
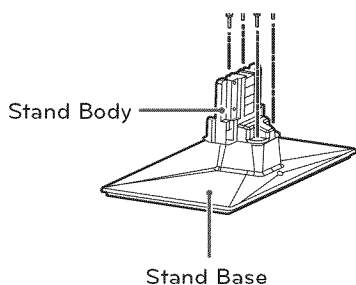

- 3 Assemble the TV as shown.

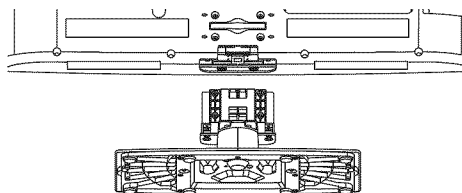

- 4 Secure the TV and the stand with the 4 screws.

Screw for assembly	Number of screws
M4 x 20	4

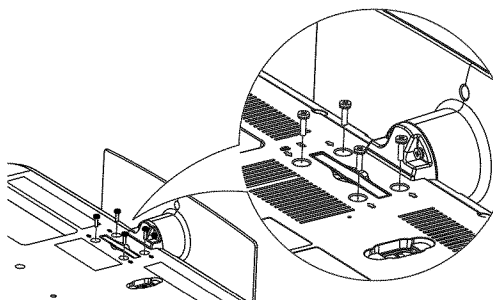

**CAUTION**

- Tighten the screws firmly to prevent the TV from tilting forward. Do not over tighten.

To detach the stand,

- 1 Lay the TV with the screen side down on a flat surface.
- 2 Remove the 4 screws and pull the stand away from the TV.

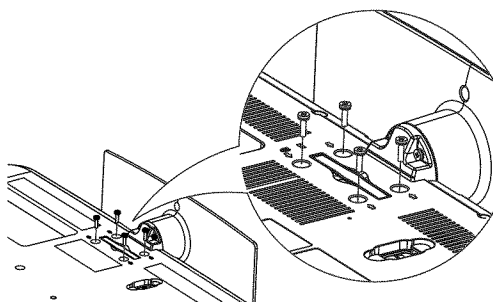

- 3 Push the supplied protection cover into the opening at the bottom of the TV until it locks in place.

This will protect the opening from accumulating dust and dirt.

When installing the wall mounting bracket, use the Protection cover.

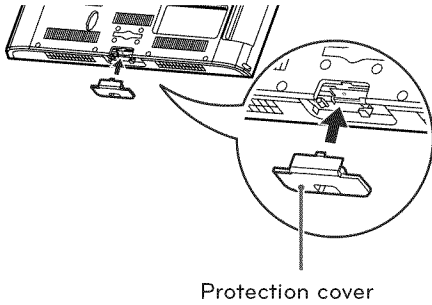

## Mounting on a table

- 1 Lift and tilt the TV into its upright position on a table.
  - Leave a 10 cm (4 inch) (minimum) space from the wall for proper ventilation.

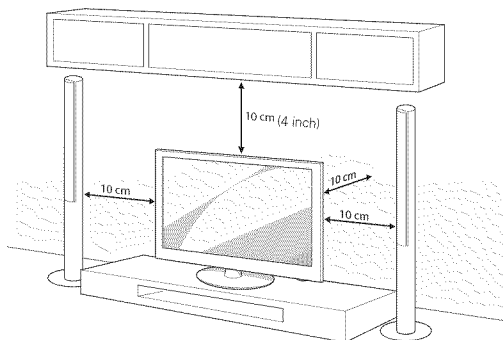

- 2 Connect the power cord to a wall outlet.



### CAUTION

- Do not place the TV near or on sources of heat, as this may result in fire or other damage.



### NOTE

- Swivel 20 degrees to the left or right and adjust the angle of the TV to suit your view.

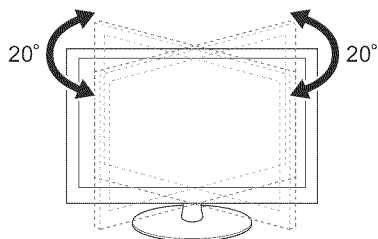

### Securing the TV to a table

(For 32LW5700, 42LK530, 42LK550)

Fix the TV to a table to prevent from tilting forward, damage, and potential injury.

Mount the TV on a table, and then insert and tighten the supplied screw on the rear of the stand.

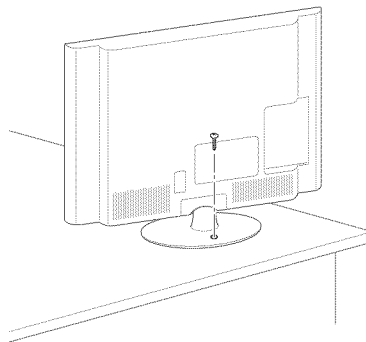

### WARNING

- To prevent TV from falling over, the TV should be securely attached to the floor/wall per installation instructions. Tipping, shaking, or rocking the TV may cause injury.

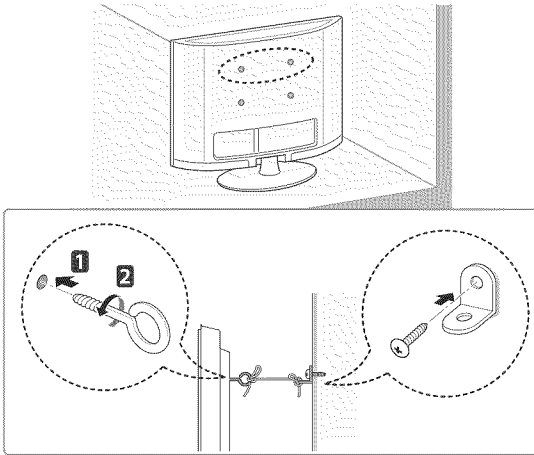
**Securing the TV to a wall (optional)**

- 1 Insert and tighten the eye-bolts, or TV brackets and bolts on the back of the TV.  
- If there are bolts inserted at the eye-bolts position, remove the bolts first.
- 2 Mount the wall brackets with the bolts to the wall.  
Match the location of the wall bracket and the eye-bolts on the rear of the TV.
- 3 Connect the eye-bolts and wall brackets tightly with a sturdy rope.  
Make sure to keep the rope horizontal with the flat surface.

**! CAUTION**

- Make sure that children do not climb on or hang on the TV.

**! NOTE**

- Use a platform or cabinet that is strong and large enough to support the TV securely.
- Brackets, bolts and ropes are optional. You can obtain additional accessories from your local dealer.

**Using the Kensington security system (optional)**

The Kensington security system connector is located at the rear of the TV. For more information of installation and using, refer to the manual provided with the Kensington security system or visit <http://www.kensington.com>.

Connect the Kensington security system cable between the TV and a table.

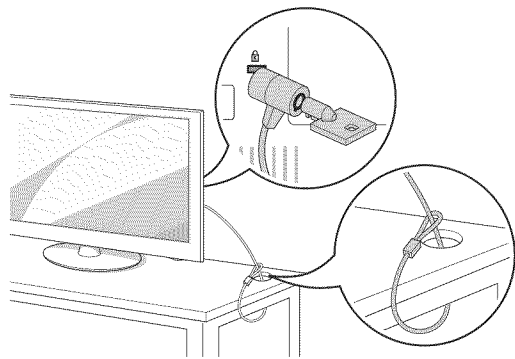
**! NOTE**

- The Kensington security system is optional. You can obtain additional accessories from your local dealer.

## Mounting on a wall

Attach an optional wall mount bracket at the rear of the TV carefully and install the wall mount bracket on a solid wall perpendicular to the floor. When you attach the TV to other building materials, please contact qualified personnel. LG recommends that wall mounting be performed by a qualified professional installer.

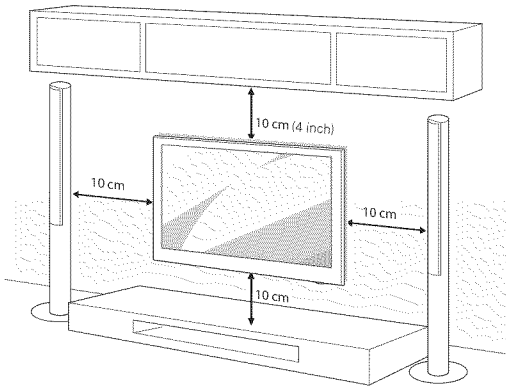

Make sure to use screws and wall mount bracket that meet the VESA standard. Standard dimensions for the wall mount kits are described in the following table.

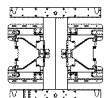
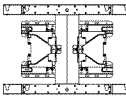
<b>Model</b>	50PZ750 50PZ950 50PZ950U	60PZ750 60PZ950 60PZ950U
<b>VESA</b>	400 x 400	600 x 400
<b>Standard screw</b>	M6	M8
<b>Number of screws</b>	4	4
<b>Wall mount bracket (optional)</b>	PSW400B, PSW400BG, DSW400BG 	PSW600B, PSW600BG 

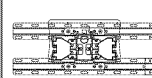
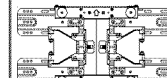
<b>Model</b>	32LW5700	42/47LK550 42/47LK530
<b>VESA</b>	200 x 100	200 x 200
<b>Standard screw</b>	M4	M6
<b>Number of screws</b>	4	4
<b>Wall mount bracket (optional)</b>	LSW100B, LSW100BG 	LSW200B, LSW200BG 

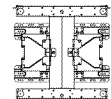
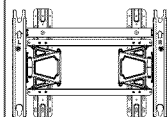
<b>Model</b>	42/47/55LV3700 42/47/55LV5400 42/47/55LV5500 55LV9500 42/47/55LW5600 42/47/55LW5700 47/55LW6500 47/55LW9800 55LK530	65LW6500
<b>VESA</b>	400 x 400	600 x 400
<b>Standard screw</b>	M6	M8
<b>Number of screws</b>	4	4
<b>Wall mount bracket (optional)</b>	LSW400B, LSW400BG, DSW400BG 	LSW600B 

### ! CAUTION

- Disconnect the power first, and then move or install the TV. Otherwise electric shock may occur.
- If you install the TV on a ceiling or slanted wall, it may fall and result in severe injury. Use an authorized LG wall mount bracket and contact the local dealer or qualified personnel.
- Do not over tighten the screws as this may cause damage to the TV and void your warranty.
- Use the screws and wall mount bracket that meet the VESA standard. Any damages or injuries by misuse or using an improper accessory are not covered by the warranty.

### ! NOTE

- Use the screws that are listed on the VESA standard screw specifications.
- The wall mount kit includes an installation manual and necessary parts.
- The wall mount bracket is optional. You can obtain additional accessories from your local dealer.
- The length of screws may differ depending on the wall mount. Make sure to use the proper length.
- For more information, refer to the manual supplied with the wall mount bracket.

## Tidying cables

### PZ750, PZ950, PZ950U series

- 1 Install the power cord holder and power cord.
  - It will help prevent the power cable from being removed by accident.

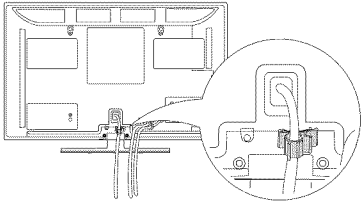

- 2 Gather and bind the cables with the cable holder.
  - Install the LAN cable as shown to reduce the electromagnetic wave.

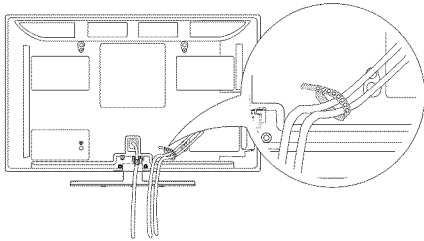

### ! CAUTION

- Do not move the TV by holding the cable holder and power cord holder, as the cable holders may break, and injuries and damage to the TV may occur.

### LV3700, LV5400, LV5500, LV9500, LW5600, LW5700, LW6500, LW9800 series

- 1 Gather and bind the cables with the cable holder on the TV back cover.

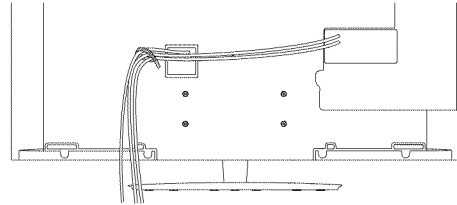

or

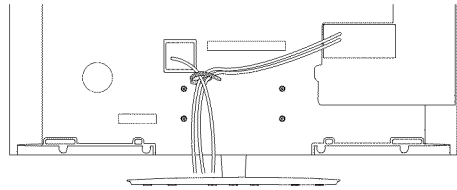

### LK530, LK550 series

- 1 Gather and bind the cables with the cable management clip.
- 2 Fix the cable management clip firmly to the TV.

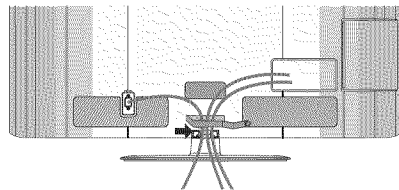

# REMOTE CONTROL

The descriptions in this manual are based on the buttons on the remote control. Please read this manual carefully and use the TV correctly.

To replace batteries, open the battery cover, replace batteries (1.5 V AAA) matching the ⊕ and ⊖ ends to the label inside the compartment, and close the battery cover. To remove the batteries, perform the installation actions in reverse.

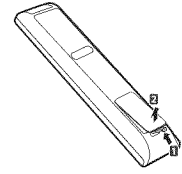

## CAUTION

- Do not mix old and new batteries, as this may damage the remote control.

Make sure to point the remote control toward the remote control sensor on the TV.

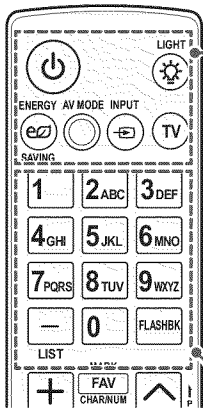

### ⏻ (POWER)

Turns the TV on or off.

### LIGHT (Depending on model)

Illuminates the remote control buttons.

### ENERGY SAVING (See p.88)

Adjusts the brightness of the screen to reduce energy consumption.

### AV MODE (See p.46)

Selects an AV mode.

### INPUT (See p.46)

Changes the input source; Turns the TV on.

### TV

Returns to the last TV channel.

### Alphanumeric buttons

Enters letters and numbers.

### LIST (See p.43)

Accesses the saved channel list.

### - (Dash)

Inserts a dash between numbers such as 2-1 and 2-2.

### FLASHBK

Alternates between the two last channels selected (pressing repeatedly).



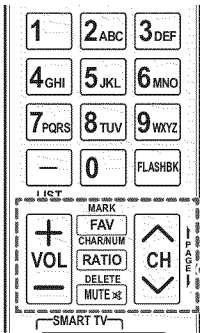

**VOL**  
Adjusts the volume level.

**MARK**  
Selects a menu or option.  
**FAV** (See p.43)  
Accesses your favorite channel list.

**CHAR/NUM**  
Switches between Letter and Number input modes.

**RATIO** (See p.45)  
Resizes an image.

**MUTE**  
Mutes all sounds.  
**DELETE**  
Deletes letters and numbers.

**CH**  
Scrolls through the saved channels.  
**PAGE**  
Moves to the previous or next screen.

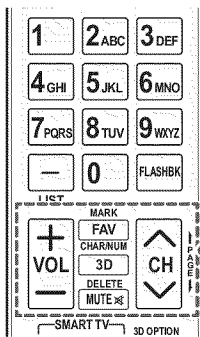

**VOL**  
Adjusts the volume level.

**MARK**  
Selects a menu or option.  
**FAV** (See p.43)  
Accesses your favorite channel list.

**CHAR/NUM**  
Switches between Letter and Number input modes.

**3D** (for 3D TV) (See p.84)  
Uses for viewing 3D video.

**MUTE**  
Mutes all sounds.  
**DELETE**  
Deletes letters and numbers.

**CH**  
Scrolls through the saved channels.  
**PAGE**  
Moves to the previous or next screen.

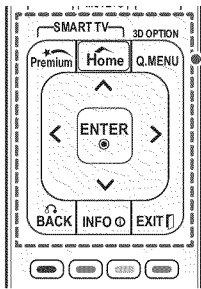
**Premium**

Accesses the Premium menus.

**Home** (See p.41)

Accesses the Home menu.

**Q. MENU** (See p.47)

Accesses the quick menu.

**3D OPTION** (for 3D TV)

Used for viewing 3D video.

**Navigation buttons** (up/down/left/right)

Scrolls through menus or options.

**ENTER**

Selects menus or options and confirms your input.

**BACK**

Returns to the previous level.

**INFO**

Views the information of the current program and screen.

**EXIT**

Clears all on-screen displays and returns to TV viewing.

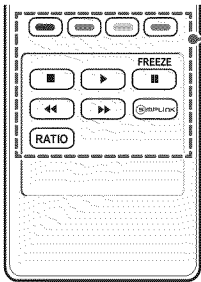

**Color buttons**

These access special functions in some menus.

**Control buttons**

Controls the Premium contents, Smart Share menus, or the SIMPLINK compatible devices (USB, SIMPLINK).

**FREEZE** (  )

Freezes the current frame (Not supported when using USB Mode and Simplink).

**SIMPLINK** (See p.117)

Accesses the AV devices connected to the TV;  
Opens the SIMPLINK menu.

**RATIO** (See p.45)

Resizes an image.

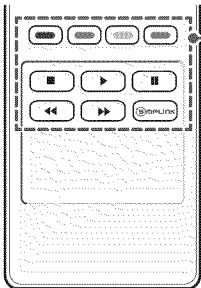

## Magic Motion Remote Control Functions

LV3700, LV5400, LW5700, LK530, LK550 series: Supports the Magic Motion remote control, which is sold separately. Refer to the Magic Motion Remote Control manual for operating instructions.

Please read this manual carefully and use the TV correctly.

When the message "Magic motion remote control battery is low. Change the battery." is displayed, replace the battery.

To replace batteries, open the battery cover, replace batteries (1.5 V AA) matching ⊕ and ⊖ ends to the label inside the compartment, and close the battery cover. Be sure to point the remote control at the remote control sensor on the TV.

To remove the batteries, perform the installation actions in reverse.

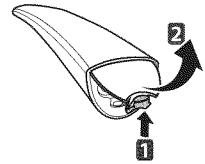

### CAUTION

- Do not mix old and new batteries, as this may damage the remote control.

Make sure to point the remote control at the remote control sensor on the TV.

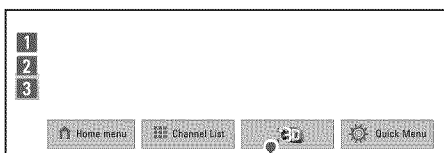
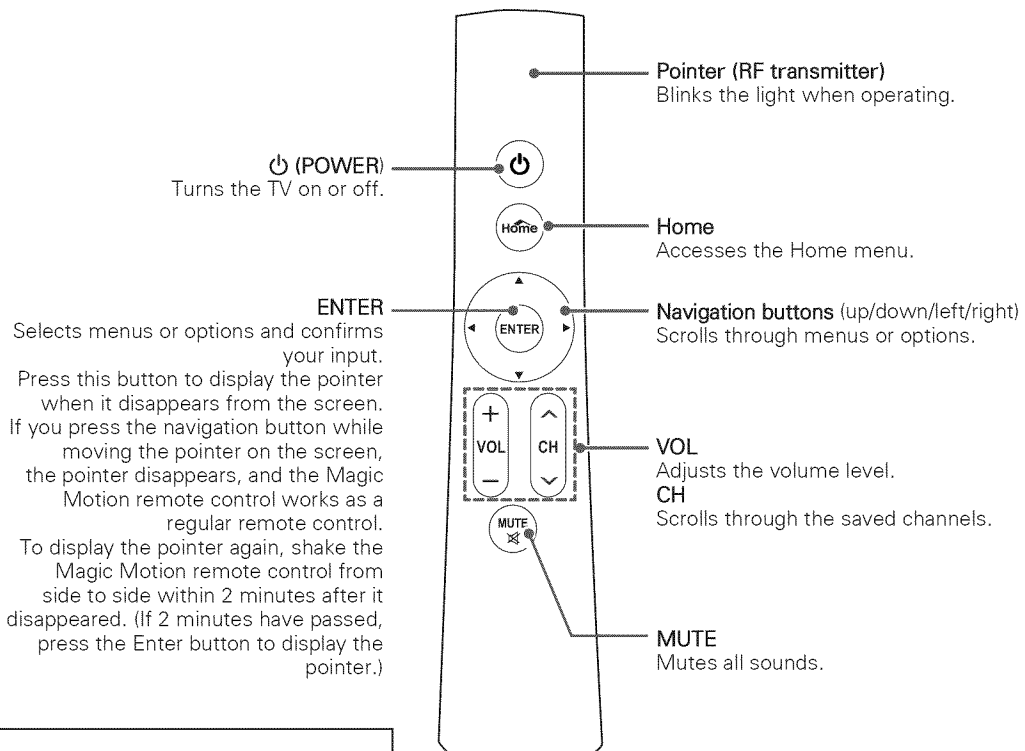

For 3D TV

## Registering Magic Motion Remote Control

The Magic Motion Remote Control operates by pairing with your TV. Register the Magic Motion Remote Control to use it.

### How to register the Magic Motion Remote Control

To register the remote control, press the **ENTER** button on the remote control while aiming it at your TV.

### How to Re-register the Magic Motion Remote Control after Registration Failure

Reset the remote control by pressing and holding both the **ENTER** and **MUTE** buttons for 5 seconds. (Once the reset is complete, the light on the Pointer blinks.) Then repeat the above procedure to register the remote control.

## How to use Magic Motion Remote Control

- 1 Press **ENTER** button if there is no pointer on your TV screen. The pointer will then appear on the screen.  
If the pointer has not been used for a certain period of time, it will disappear.
- 2 You can move the pointer by aiming the Pointer Receiver of the remote control at your TV then move it left, right, up or down.  
If the pointer does not work properly after clicking the **ENTER** button, leave the remote control for 10 seconds then use it again.

## Precautions to Take when Using the Magic Motion Remote Control

- Use the remote control within the maximum communication distance (10 m, 32.8ft). Using the remote control beyond this distance, or with an object obstructing it, may cause a communication failure.
- A communication failure may occur due to nearby devices. Electrical devices such as a microwave oven or wireless LAN product may cause interference, as this will use the same bandwidth (2.4 GHz) as the Magic Motion Remote Control.
- The Magic Motion Remote Control may be damaged or may malfunction if it is dropped or receives a heavy impact.
- When playing a game using the Magic Motion Remote Control, hold it securely by wrapping its strap around your wrist and adjusting the length with the adjustable ring.
- Take care not to bump into nearby furniture or other people when using the Magic Motion Remote Control.
- Manufacturer and installer cannot provide service related to human safety as the applicable wireless device has possibility of electric wave interference.
- It is recommended that an Access Point (AP) be located more than 1 m (3.28 ft) away from the TV. If the AP is installed closer than 1 m (3.28 ft), the magic motion remote control may not perform as expected due to frequency interference.

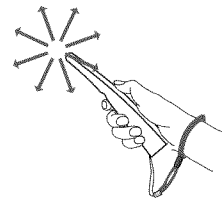

# WATCHING TV

## Connecting to an antenna or cable

Connect an antenna, cable, or cable box to watch TV while referring to the following. The illustrations may differ from the actual items and a RF cable is optional.

### Connecting an antenna or basic cable

Connect the TV to a wall antenna socket with an RF cable (75  $\Omega$ ).

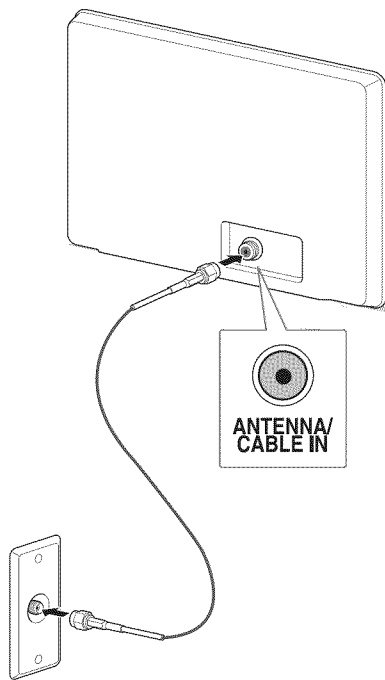

#### NOTE

- Use a signal splitter to use more than 2 TVs.
- Visit <http://gknowledgebase.com> for more information about the antenna and cable connection. Search for antenna.

## Connecting a cable box

Connect the TV to a cable box and the cable box to a wall antenna socket with 2 RF cables (75  $\Omega$ ).

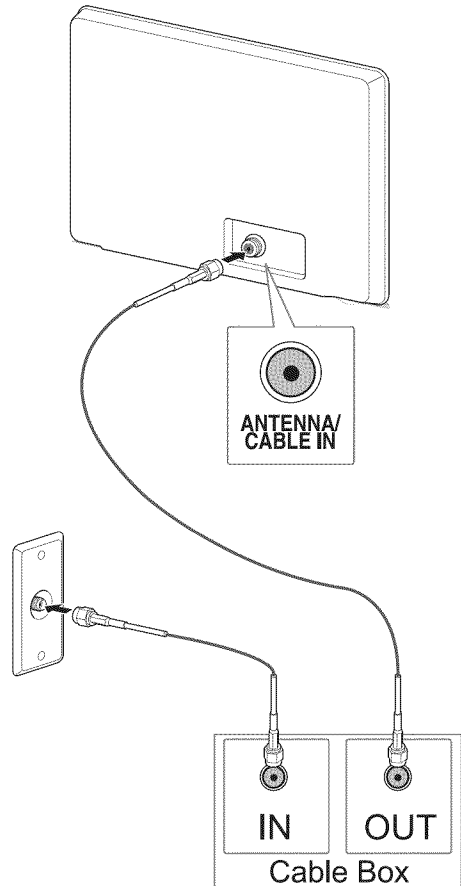

#### CAUTION

- Make sure not to bend the copper wire of the RF cable.

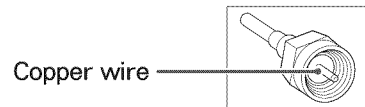

- Complete all connections between devices, and then connect the power cord to the power outlet to prevent damage to your TV.

## Turning the TV on for the first time

When you turn the TV on for the first time, the Initial setting screen appears. Select a language and customize the basic settings.

- 1 Connect the power cord to a power outlet.
- 2 In Standby mode, press the power button on the remote control to turn the TV on.  
The Initial setting screen appears if you turn the TV on for the first time.

### ! NOTE

- You can also access **Initial Setting** by accessing **OPTION** in the Home menu - SETUP.

- 3 Follow the on-screen instructions to customize your TV settings according to your preferences.

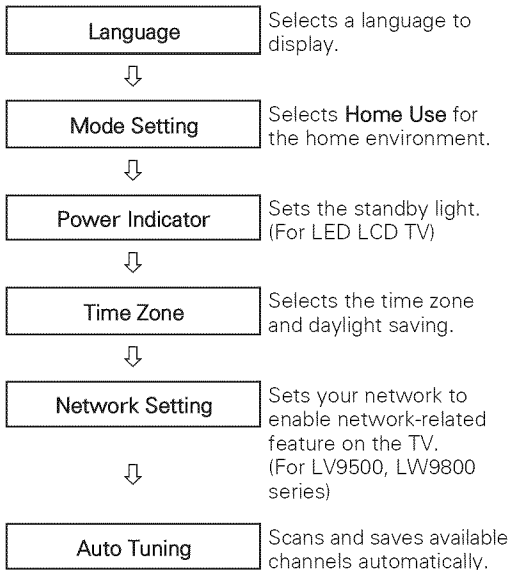

### ! NOTE

- To display images in the best quality for your home environment, select **Home Use**.
- **Store Demo** is suitable for the retail environment.
- If you select **Store Demo**, the any customized settings will switch back to the default settings of **Store Demo** in 5 minutes.
- Power Indicator feature is disabled in Store Demo mode.

- 4 When the basic settings are complete, press **ENTER**.

### ! NOTE

- If you do not complete the Initial setting, it will appear whenever the TV turns on.
- Disconnect the power cord from the power outlet when you do not use the TV for a long period of time.

- 5 To turn the TV off, press the power button on the remote control.

## Watching TV

- 1 In Standby mode, press the power button on the remote control to turn the TV on.
- 2 Press **INPUT** and select **TV**.
- 3 Control the TV using the following buttons while you are watching TV.

Button	Description
CH (^, v)	Scrolls through saved channels.
LIST	Selects a channel on the saved or recent watched channel list.
0 - 9	Selects a channel by entering numbers.
VOL (+, -)	Adjusts the volume level.
MUTE	Mutes all sounds.
AV MODE <sup>1</sup>	Selects an AV mode (See p.46).
Q.MENU	Accesses the quick menus (See p.47).
FLASHBK	Alternates between the last two channels selected.
RATIO	Resizes an image (See p.45).
FREEZE (  )	Freezes the current frame while you are watching TV

- 1 Each **AV mode** has the optimized image and sound settings. If you select **Off**, the image and sound settings will be restored to the previously customized settings.
- 4 To turn the TV off, press the power button on the remote control.  
The TV switches to Standby mode.



## Accessing Home Menu

- 1 Press **Home** to access the Home menu.
- 2 Press the Navigation buttons to scroll to one of the following menus and press **ENTER**.
- 3 Press the Navigation buttons to scroll to the setting or option you want and press **ENTER**.
- 4 When you are finished, press **EXIT**.

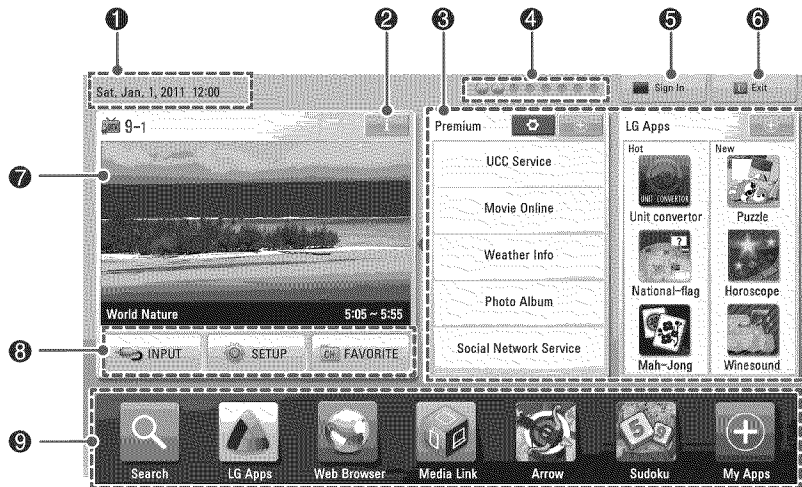

Option	Description
①	Current Date, Time
②	Channel program info
③	Function card: You can enjoy various content files by selecting each card and you can edit the premium card by selecting 5 items.
④	Function card position
⑤	Sign In
⑥	Exit
⑦	Current watching channel screen
⑧	INPUT, SETUP, FAVORITE menu.
⑨	Launcher bar

## Managing channels

\* The Digital broadcasting (DTV, Cable DTV) is not available for Philippines.

### Setting up channels

#### Storing channels

To store channels automatically,

- 1 Press **Home** to access the Home menu.
- 2 Press the Navigation buttons to scroll to **SETUP** and press **ENTER**.
- 3 Press the Navigation buttons to scroll to **CHANNEL** and press **ENTER**.
- 4 Press the Navigation buttons to scroll to **Auto Tuning** and press **ENTER**.
- 5 Select **Start** to start automatic tuning. The TV scans and saves available channels automatically.
- 6 When you are finished, press **EXIT**. When you return to the previous menu, press **BACK**.

To store channels manually,

- 1 Press **Home** to access the Home menu.
- 2 Press the Navigation buttons to scroll to **SETUP** and press **ENTER**.
- 3 Press the Navigation buttons to scroll to **CHANNEL** and press **ENTER**.
- 4 Press the Navigation buttons to scroll to **Manual Tuning** and press **ENTER**.
- 5 Scroll through the channel types, and then add or delete channels.
- 6 When you are finished, press **EXIT**. When you return to the previous menu, press **BACK**.

#### ! NOTE

- If the TV scans a blocked channel, you will be prompted to enter your password to keep the channel scanned.
- You can store up to 1000 channels. The number of channels that you can store differs depending on the broadcasting signal environment.
- The channels are stored in the order of DTV, TV, Cable DTV and Cable TV.

#### Editing your channel list

- 1 Press **Home** to access the Home menu.
- 2 Press the Navigation buttons to scroll to **SETUP** and press **ENTER**.
- 3 Press the Navigation buttons to scroll to **CHANNEL** and press **ENTER**.
- 4 Press the Navigation buttons to scroll to **Channel Edit** and press **ENTER**.
- 5 Edit channels using the following buttons.

Button	Description	
^	Highlight the channel type (DTV, TV, Cable DTV, Cable TV).	
^, v, <, >	Scrolls through channel types or channels.	
ENTER	Edits channels.	
	Watch	Selects the highlighted channel to view.
	Set as Favorite	Registers or cancels the current channel in favorite channel list.
	Add/Delete	Adds or deletes a channel. The deleted channel displays in blue.
	Block	Blocks or unblocks a channel.
CH (^, v)	Moves to the previous or next page.	
Red button	Selects your desired favorite channel group.	

- 6 When you are finished, press **EXIT**. When you return to the previous menu, press **BACK**.

### Selecting a channel on the channel list

- 1 Press **LIST** to access the channel list.

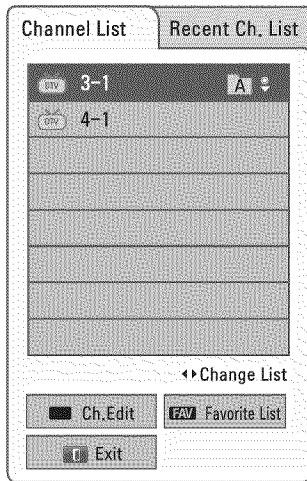

Button	Description
<, >	Selects Channel list or Recent channel list.
^, v	Scrolls through channel.
ENTER	Selects the highlighted channel to view.
CH (^, v)	Moves to the previous or next page.
Red button	Edits Channel.
FAV	Moves to the favorite channel list.

- 2 When you are finished, press **EXIT**.  
When you return to the previous menu, press **BACK**.

#### NOTE

- If you select the blocked channel, you will be prompted to enter your password.

## Using favorite channels

Add the channels that you watch frequently to the favorite list.

- 1 Select a channel to add to the favorite list.
- 2 Press **FAV**.

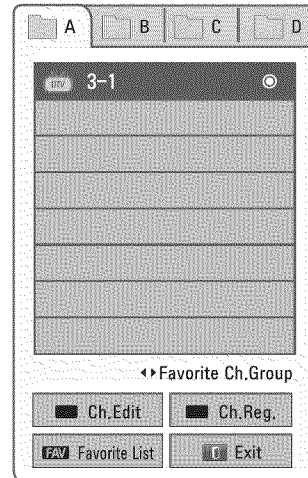

Button	Description
<, >	Selects a desired favorite channel group.
CH (^, v)	Moves to the previous or next page
Red button	Moves to the <b>Channel Edit</b> .
Green button	Registers or cancels the current channel.
FAV	Moves to the <b>Channel List</b> .

- 3 When you are finished, press **EXIT**.

## Checking current program info

Press **INFO** to view the information of the currently program while you are watching. The following information appears at the bottom of the screen.

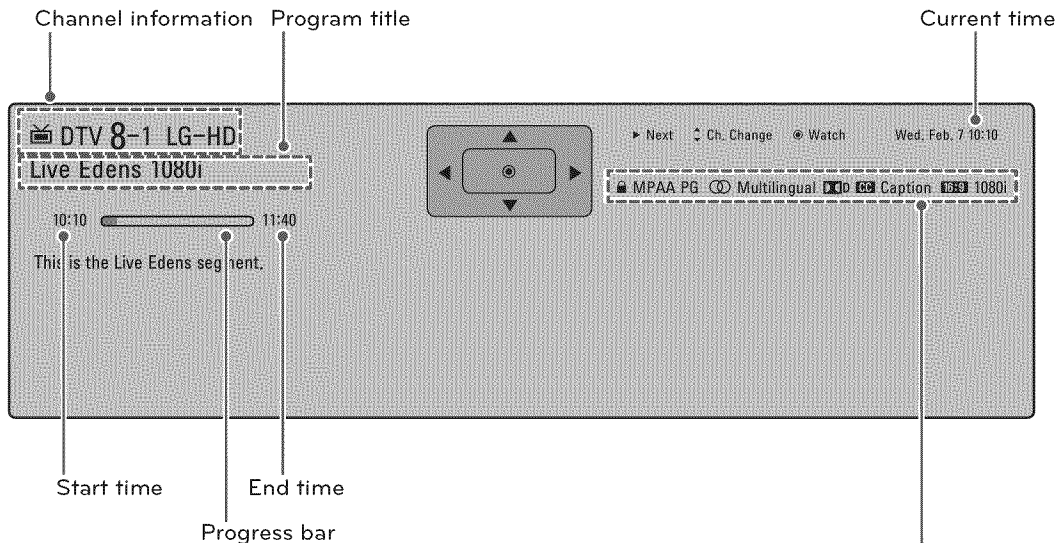

Icon		Description
Multilingual		The program contains two or more audio language services. You can change the audio language using the quick menu.
Dolby Digital		The program contains a Dolby Digital audio signal in TV and HDMI input sources.
Dolby Digital Plus		The program contains a Dolby Digital Plus audio signal in TV and HDMI input sources.
Caption		The program contains one or more language caption services. You can select a closed caption you want by using the quick menu.
Aspect ratio		The original aspect ratio of the video is 4:3. The original aspect ratio of the video is 16:9 (wide).
Resolution	480i 480p 720p 1080i 1080p	The video resolution is 720 x 480i. The video resolution is 720 x 480p. The video resolution is 1280 x 720p. The video resolution is 1920 x 1080i. The video resolution is 1920 x 1080p.
V-Chip		The program contains Lock information. Refer to the "TV Rating-General" (See p.97)

## Using additional options

### Adjusting aspect ratio

Resize an image to view at its optimal size by pressing **RATIO** while you are watching TV.

#### ! NOTE

- You can also change the image size by pressing **Q. MENU** or accessing **Aspect Ratio** in the **PICTURE** menu.
- The available ratio varies depending on the input source.
  - The input sources: HDMI-PC and RGB-PC support 4:3 and 16:9.
  - The input sources: HDMI-PC 1920 X 1080 supports all of the aspect ratios.

- **16:9:** Resizes images to fit the screen width.

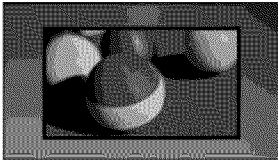

- **Just Scan:** Displays video images in the original size without cutting off the edges.

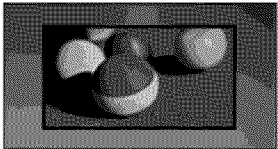

#### ! NOTE

- If you select Just Scan, you may see image noises at the edge or edges of the screen.
- The input sources: DTV, CADTV, Component, HDMI-DTV, and DVI-DTV (720p/1080i/1080p) support Just Scan.

- **Set By Program:** Displays images in the same aspect ratio as the original image.

- **4:3:** Resizes images to the previous standard.

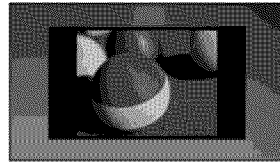

- **Cinema Zoom:** Formats an image to the cinemascope ratio, 2.35:1.
  - To change the ratio of the cinema zoom, press **<** or **>** and its range is from 1 to 16.
  - To move the zoom focus up or down, press **▲** or **▼**.

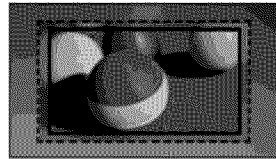

#### ! NOTE

- If you enlarge or reduce an image, the image may be distorted.

## Changing AV modes

Each **AV mode** has optimized image and sound settings.

Press **AV MODE** repeatedly to select an appropriate mode.

Mode	Description
Off	Changes to the previously customized settings
Cinema or THX Cinema	Use the optimized image and sound settings for the cinematic look
Sport (  )	Use the optimized image and sound settings for dynamic action sports.
Game	Use the optimized image and sound settings for fast gaming. When playing a video game using PlayStation or Xbox, it is recommended to use the Game mode. When in Game mode, functions related to picture quality will be optimized for playing games.

Input source	Description
USB	Play media files from a thumb drive.
NETWORK	Play media files from your home network.
AV	Watch video from a VCR or other external devices.
Component	Watch video from a DVD or other external devices, or through a digital set-top box.
RGB-PC	Use the TV as a computer monitor.
HDMI	Watch video from a HTS or other high definition devices.

The disconnected input sources will be gray.

- To add an input label, press the Green button. You can easily identify a device connected to each input source.
- If you connect a new external device to the TV, a pop-up window appears. Select **Yes** on the pop-up window to select an input source.
- To access the SIMPLINK, press the Red button. If you select "SIMPLINK and On", the pop-up window for the HDMI input will not display.

## Using the input list

### Selecting an input source

- 1 Press **INPUT** to access the input sources.
  - The connected device displays on each input source.

**NOTE**

- You can also access the input source list by selecting **INPUT** in the **Home** menu.

- 2 Press the Navigation buttons to scroll to one of the input sources and press **ENTER**.

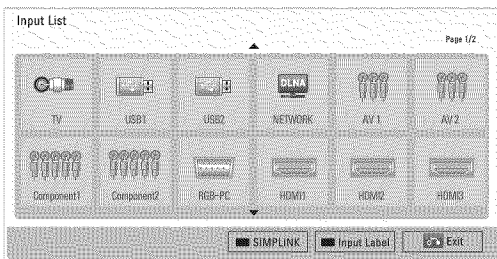

Input source	Description
TV	Watch TV over the air, cable, and digital cable broadcast.

### Adding an Input label

Add a label to an input source so that you can easily identify a device connected to each input source.

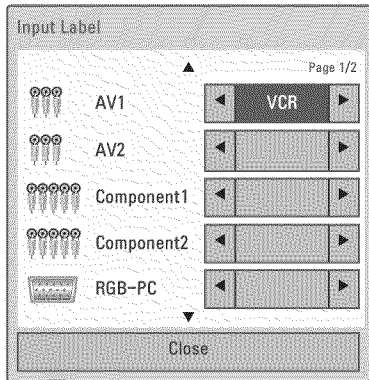

- 1 Press **INPUT** to access the input sources.
- 2 Press the Green button.
- 3 Press the Navigation buttons to scroll to one of the input sources.
- 4 Press the Navigation buttons to scroll to one of the input labels.
- 5 When you are finished, press **EXIT**.  
When you return to the previous menu, press **BACK**.

## Using the quick menu

Customize frequently used menus.

- 1 Press **Q. MENU** to access the quick menus.
- 2 Press the Navigation buttons to scroll through the following menus and press **ENTER**.

Menu	Description
<b>Aspect Ratio</b>	Changes the image size.
<b>Picture Mode</b>	Changes the image mode.
<b>Sound Mode</b>	Changes the sound mode.
<b>Sleep Timer</b>	Sets the length of time until the TV to turns off.
<b>Caption</b>	Activates or deactivate the subtitles
<b>Multi Audio</b>	Changes the audio language (Digital signal)
<b>SAP</b>	Changes the MTS sound (Analog signal)
<b>Energy Saving</b>	Reduces the power consumption by adjusting the screen brightness.
<b>AV Mode</b>	Sets the optimized image and sound settings.
<b>Del/Add</b>	Edits the channels to add or delete the channel.
<b>USB Device</b>	Eject a USB device. The menu is displayed only when the USB device is connected.

### NOTE

- The available menus and options may differ from the input source or product model that you are using.

- 3 Press the Navigation buttons to scroll to the option you want.
- 4 When you are finished, press **Q. MENU**.

# ENTERTAINMENT

## Network Connection

### Connecting to a wired network

Connect the TV to a local area network (LAN) via the LAN port as shown in the following illustration and set up the network settings.

If wired and wireless networks are both available, wired is the preferred method.

After making a physical connection, a small number of home networks may require the TV network settings to be adjusted. For most home networks, the TV will connect to automatically without any adjustments.

For detail information, contact your internet provider or router manual.

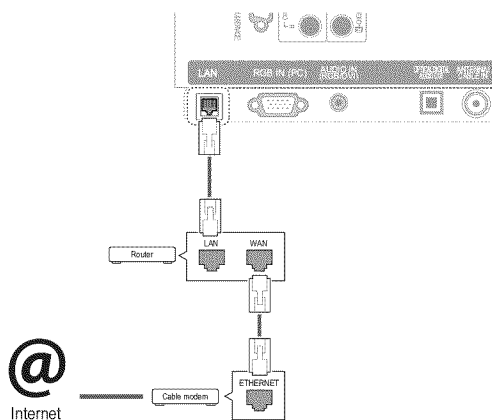

#### ! CAUTION

- Do not connect a modular phone cable to the LAN port.
- Since there are various connection methods, please follow the specifications of your telecommunication carrier or internet service provider.
- After connecting the LAN port, use the Premium or LG Apps menu.

To set up the network settings: (Even if your TV has already connected automatically, running setup again will not harm anything)

- 1 Press **Home** to access the Home menu.
- 2 Press the Navigation buttons to scroll to **SETUP** and press **ENTER**.
- 3 Press the Navigation buttons to scroll to **NETWORK** and press **ENTER**.
- 4 Press the Navigation buttons to select **Network Setting** and press **ENTER**.
- 5 If wired and wireless are simultaneously connected, press the Navigation buttons to select **Wired** and press **ENTER**.
- 6 If you have already set the Network Setting, select **Resetting**. The new connection settings will reset the current network settings.
- 7 Select **IP Auto Setting** or **IP Manual Setting**.
  - If selecting **IP Manual Setting**, press the Navigation and Number buttons. IP addresses will need to be input manually.
  - **IP Auto Setting**: Select this if there is a DHCP server (Router) on the local area network (LAN) via wired connection, the TV will automatically be allocated an IP address. If you're using a broadband router or broadband modem that has a DHCP (Dynamic Host Configuration Protocol) server function. The IP address will automatically be determined.
  - **IP Manual Setting**: Select if there is no DHCP server on the network or you want to set the IP address manually.
- 8 When you are finished, press **EXIT**.



**!** NOTE

- If you want to access the Internet directly on your TV, the broadband internet connection should always be on.
- If you cannot access the Internet, check the network conditions from a PC on your network.
- When you use **Network Setting**, check the LAN cable or check if DHCP in the router is turned on.
- If you do not complete the network settings, the network may not work properly.

**Connecting to a wireless network**

The LG Wireless LAN for Broadband/DLNA Adaptor, which is sold separately, allows the TV to connect to a wireless LAN network.

The network configuration and connection method may vary depending on the equipment in use and the networking environment. Refer to the setup instructions supplied with your access point or wireless router for detailed connection steps and network settings.

Setting up the AP (Access Point) or the wireless router is required before connecting the TV to the network. The easiest method is the WPS button method (Third method in this section).

(LV9500, LW9800 series: Built-in the Wi-Fi Module, Unnecessary **Wireless LAN for Broadband/DLNA adaptor** setup)

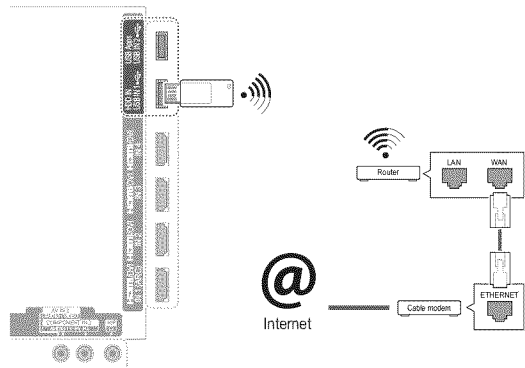
**!** NOTE

- For enjoying pictures, music, or video stored on a PC using the router, a wired connection is recommended.
- When the wireless port of the router is used, there may be restrictions on some functions.
- It is recommended that an Access Point (AP) be located more than 1 m (3.28 ft) away from the TV. If the AP is installed closer than 1 m, the magic motion remote control may not perform as expected due to frequency interference.

To set up the network settings,

- 1 Press **Home** to access the Home menu.
- 2 Press the Navigation buttons to scroll to **SETUP** and press **ENTER**.
- 3 Press the Navigation buttons to scroll to **NETWORK** and press **ENTER**.
- 4 Press the Navigation buttons to select **Network Setting** and press **ENTER**.
- 5 Press the Navigation buttons to select **Wireless** and press **ENTER**.
- 6 If you already set Network Setting, select **Resetting** and press **ENTER**.  
The new connection settings resets the current network settings.
- 7 Press the Navigation buttons to select **Setting from the AP list** and press **ENTER**.  
- Scan the all available AP (Access Point) or wireless routers within range and display them as a list.

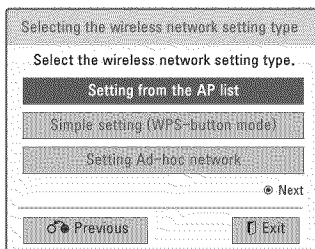

- 8 Press the Navigation buttons to select an AP (Access Point) or wireless router on the list. (If your AP is secured, you will be prompted for the key.) And press **ENTER**.

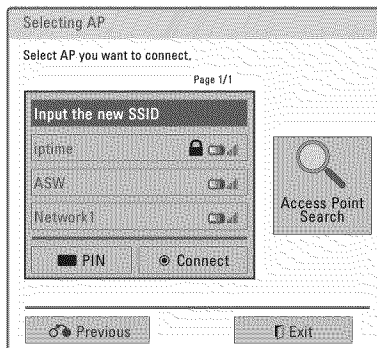

- 9 Press the Number buttons to Input the security key of AP and press **ENTER**.

## When a security code is already set

### PIN (Personal Identification Number)

If your router is set to use a PIN, use the following instructions.

- 1 Repeat step 1-7 on "Connecting to a wireless network".
- 2 Press the Red button to connect the access point with **PIN** mode.
- 3 You can see the Network ID and Security Key on your TV screen.  
Enter the PIN number to your device.  
PIN number is the unique 8 digit number of the dongle.
- 4 Press **ENTER** to select **Connect**.

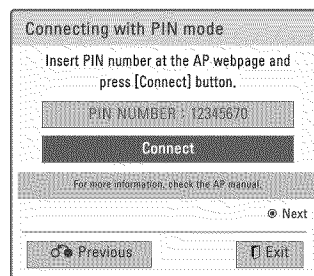

- 5 Repeat step 6-7 on "Connecting to a wired network".

**WPS (Wi-Fi Protected Setup)**

If your router or AP has a WPS button, it is the easiest connection method. You simply press the button on the router and then select the WPS on the TV within 120 seconds.

- 1 Repeat step 1-7 on "Connecting to a wireless network".
- 2 Press the Navigation buttons to select the **Simple setting (WPS-button mode)**.
- 3 Press the WPS button on your router.
- 4 Go back to the TV and select **Connect**.
- 5 Repeat step 6-7 on "Connecting to a wired network".

**Ad-hoc Mode**

Ad-hoc mode allows the TV to use a wireless to connect to a computer without using a router or access point.

- 1 Repeat step 1-5 on "Connecting to a wireless network".
- 2 Press the Navigation buttons to select **Setting Ad-hoc network** and press **ENTER**.
- 3 Press the Navigation buttons to select **Enter** and press **ENTER**.
- 4 Press **ENTER** to select **Connect** to connect Ad-hoc network.
  - You can see the Network ID and Security Key on your TV screen.
  - Enter this Network ID and Security Key to your device.
  - When needed, you can change the setting information using the Red button.

**NOTE**

When searching for wireless networks on your PC using ad-hoc, the TV is named LGTV10.

- LGTV10 that appears in the list. (Select the same name as the network ID that appears on your TV screen.)

- 5 Press the Navigation buttons to type in an IP address and press **ENTER**.

Option	Description
PC Setting	<ul style="list-style-type: none"> <li>• Internet Protocol(TCP/IP) of PC needs to be set manually. IP address, Subnet Mask, and default Gateway can be set with your own discretion.               <ul style="list-style-type: none"> <li>» e.g.) IP address: 192.168.0.1 / Subnet Mask: 255.255.255.0 / default Gateway: 192.168.0.10</li> </ul> </li> </ul>
TV Setting	<ul style="list-style-type: none"> <li>• Verify IP address and gateway of PC. Input Gateway address of PC to IP Address, and IP Address of PC to Gateway, and select Enter.               <ul style="list-style-type: none"> <li>» e.g.) IP address: 192.168.0.10 / Subnet Mask: 255.255.255.0 / default Gateway: 192.168.0.1</li> </ul> </li> </ul>

- 6 Press the Navigation buttons to select **Close** after Network setting is completed.
- 7 Press the **ENTER**.

**Tips for Network setting**

- Use a standard LAN cable with this TV. Cat5 or better with a RJ45 connector.
- Many network connection problems during set up can often be fixed by re-setting the router or modem. After connecting the player to the home network, quickly power off and/or disconnect the power cable of the home network router or cable modem. Then power on and/or connect the power cable again.
- Depending on the internet service provider (ISP), the number of devices that can receive internet service may be limited by the applicable terms of service. For details, contact your ISP.
- LG is not responsible for any malfunction of the TV and/or the internet connection feature due to communication errors/malfunctions associated with your broadband internet connection, or other connected equipment.
- LG is not responsible for problems within your internet connection.
- Some content available through the network connection may not be compatible with the TV. If you have questions about such content, please contact the producer of the content.
- You may experience undesired results if the network connection speed does not meet the requirements of the content being accessed.
- Some internet connection operations may not be possible due to certain restrictions set by the Internet service provider (ISP) supplying your broadband Internet connection.
- Any fees charged by an ISP including, without limitation, connection charges are your responsibility.
- A 10 Base-T or 100 Base-TX LAN port is required when using a wired connection to this TV. If your internet service does not allow for such a connection, you will not be able to connect the TV.
- A DSL modem is required to use DSL service and a cable modem is required to use cable modem service. Depending on the access method of and subscriber agreement with your ISP, you may not be able to use the internet connection feature contained in this TV or you may be limited to the number of devices you can connect at the same time. (If your ISP limits sub-cription to one device, this TV may not be allowed to connect when a PC is already connected.)
- The use of a "Router" may not be allowed or its usage may be limited depending on the policies and restrictions of your ISP. For details, contact your ISP directly.
- The wireless network operates at 2.4 GHz radio frequencies that are also used by other household devices such as cordless telephone, Bluetooth® devices, microwave oven, and can be affected by interference from them. It can be interrupted by the device using 5 Ghz radio frequencies. It is same device with LG wireless media box, cordless telephone, other Wi-Fi device.
- It may decrease the service speed using Wireless network by surrounding wireless condition.
- Turn off all unused network equipment in your local home network. Some devices may generate network traffic.
- In some instances, placing the access point or wireless router higher up away from the floor may improve the reception.
- The reception quality over wireless depends on many factors such as type of the access point, distance between the TV and access point, and the location of the TV.
- To connect wireless AP, an AP that supports the wireless connection is necessary, and the wireless connection function of the AP needs to be activated. Please enquire to the AP supplier for the possibility of AP wireless connections.
- Please verify the security settings of AP SSID for wireless AP connection, and enquire to the AP supplier for the AP SSID security settings.
- The TV can become slower or malfunction with wrong settings of network equipments (wired/wireless router, hub, etc). Please install correctly by referring to the manual of the equipment, and set the network.
- When AP is set to include 802.11 n, and if Encryption is designated as WEP(64/128bit) or WPA(TKIP/AES), the connection may not be possible. There may be different connection methods according to the AP manufacturers.

## Network Status

- 1 Press **Home** to access the Home menu.
- 2 Press the Navigation buttons to scroll to **SETUP** and press **ENTER**.
- 3 Press the Navigation buttons to scroll to **NETWORK** and press **ENTER**.
- 4 Press the Navigation buttons to select **Network Status**.
- 5 Press **ENTER** to check the network status.

Option	Description
Setting	Return to the network setting menu or wireless network setting type menu.
Test	Test the current network status after setting the network.
Close	Return to the previous menu.

## Premium Account Function

LG's Premium technology allows you to access a variety of online services or content directly on your TV. Your TV offers instant streaming of movies, weather, videos, and photo album services with a Premium account and an Internet connection.

Enjoy entertainment including not only entertainment content, but also up-to-the minute news, weather updates, photo management, and more by simply using the TV's remote control without a separate PC.

- 1 Press **Premium** to access the Premium option.
- 2 Press the Navigation buttons to scroll to the content you want and press **ENTER**.

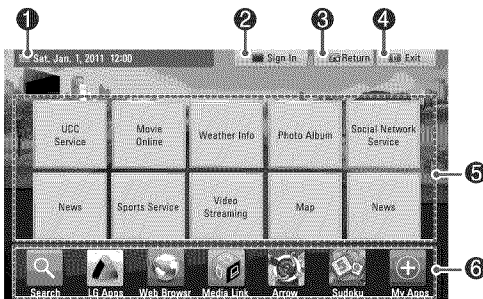

Option	Description
①	Moves to the weather setting screen.
②	Sign into the premium service.
③	Moves to the previous menu screen.
④	Returns to TV viewing.
⑤	Selects your desired online service. • If a service requires you to log in, you must first sign up for the service on your computer and then log into the service on the TV.
⑥	Launcher bar

- 3 Enjoy the premium features.

## Notice

- These services are provided by separate content providers.
- Please visit the content providers web site for specific information on their service.
- Premium menu can differ by country.
- Note that content may be updated automatically depending on the service provider, so the content layout or operation method may change without notice. Please refer to the help menu on the screen.
- All information, data, documents, communications, downloads, files, text, images, photographs, graphics, videos, webcasts, publications, tools, resources, software, code, programs, applets, widgets, applications, products and other content ("Content") and all services and offerings ("Services") provided or made available by or through any third party (each a "Service Provider") is the sole responsibility of the Service Provider from whom it originated.
- The availability of and access to Content and Services furnished by the Service Provider through the LGE Device are subject to change at any time, without prior notice, including, but not limited to the suspension, removal or cessation of all or any part of the Content or Services.
- Should you have any inquiry or problem related to the Content or Services, you may refer to the Service Provider's website for the most up-to-date information. LGE is neither responsible nor liable for customer service related to the Content and Services. Any question or request for service relating to the Content or Services should be made directly to the respective Content and Service Providers.
- Please note that LGE is not responsible for any Content or Services provided by the Service Provider or any changes to, removal of, or cessation of such Content or Services and does not warrant or guaranty the availability of or access to such Content or Services.

- Some content may be harmful to minors depending on the service provider. Parental guidance is necessary.
- The service may be interrupted if the Internet connection is unstable. Please check the connection status if you experience this problem.
- The videos list searched from the TV may differ with the list searched from a web browser on PC.
- The playback of videos may pause, stop, or buffer depending on your broadband speed.
- For service that requires log in, join the applicable service on the website using a PC and log in through the TV to enjoy various additional functions.
- For Plasma TV: If there is no user action 2 minutes following freezing image or video on screen, the screensaver will activate itself preventing a fixed image remaining on screen.

#### Legal Notice

#### IMPORTANT NOTICE RELATING TO NETWORK SERVICE

All content and services accessible through this device belong to third parties and are protected by copyright, patent, trademark and/or other intellectual property laws. Such content and services are provided solely for your personal noncommercial use. You may not use any content or services in a manner that has not been authorized by the content owner or service provider. Without limiting the foregoing, unless expressly authorized by the applicable content owner or service provider, you may not copy, upload, post, transmit, translate, sell, modify, create derivative works, or distribute in any manner or medium any content or services displayed through this device.

YOU EXPRESSLY ACKNOWLEDGE AND AGREE THAT THE DEVICE AND ALL THIRD PARTY CONTENT AND SERVICES ARE PROVIDED "AS IS" WITHOUT WARRANTY OF ANY KIND, EITHER EXPRESS OR IMPLIED. LG ELECTRONICS EXPRESSLY DISCLAIMS ALL WARRANTIES AND CONDITIONS WITH RESPECT TO ANY CONTENT AND SERVICES, EITHER EXPRESS OR IMPLIED, INCLUDING BUT NOT LIMITED TO, WARRANTIES OF MERCHANTABILITY, OF SATISFACTORY QUALITY, FITNESS FOR A PARTICULAR

PURPOSE, AND NON-INFRINGEMENT OF THIRD PARTY RIGHTS. LG DOES NOT GUARANTEE THE ACCURACY, VALIDITY, TIMELINESS, LEGALITY, OR COMPLETENESS OF ANY CONTENT OR SERVICE MADE AVAILABLE THROUGH THIS DEVICE AND DOES NOT WARRANT THAT THE DEVICE OR SERVICES WILL MEET YOUR REQUIREMENTS, OR THAT OPERATION OF THE DEVICE OR SERVICES WILL BE UNINTERRUPTED OR ERROR-FREE. UNDER NO CIRCUMSTANCES, INCLUDING NEGLIGENCE, SHALL LG BE LIABLE, WHETHER IN CONTRACT OR TORT, FOR ANY DIRECT, INDIRECT, INCIDENTAL, SPECIAL OR CONSEQUENTIAL DAMAGES, OR ANY OTHER DAMAGES ARISING OUT OF, ANY INFORMATION CONTAINED IN, OR ANY CONTENT OR SERVICE ACCESSED BY YOU OR ANY THIRD PARTY, EVEN IF ADVISED OF THE POSSIBILITY OF SUCH DAMAGES.

Third party services may be changed, suspended, removed, terminated or interrupted, or access may be disabled at any time, without notice, and LG makes no representation or warranty that any content or service will remain available for any period of time. Content and services are transmitted by third parties by means of networks and transmission facilities over which LG has no control. LG may impose limits on the use of or access to certain services or content, in any case and without notice or liability. LG expressly disclaims any responsibility or liability for any change, interruption, disabling, removal of or suspension of any content or service made available through this device.

LG is neither responsible nor liable for customer service related to the content and services. Any question or request for service relating to the content or services should be made directly to the respective content and service providers.

## LG Apps function

This feature is not available for all country.

Additional applications can be downloaded from the LG App Store.

These functions may be not available for a certain period of time depending on country or product model. In such cases, the buttons may be disabled.

They are enabled when the services are available.

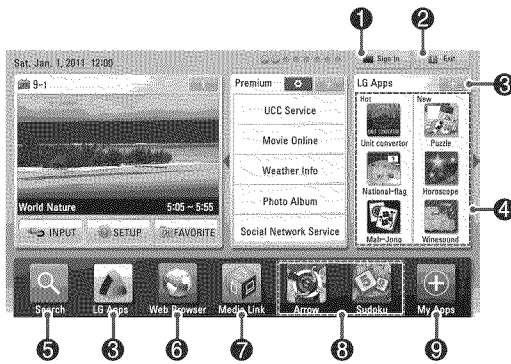

Option	Description
① Sign In, Sign out	Sign in or sign out to the premium service.
② Exit	Returns to TV viewing.
③ LG Apps	Moves to the LG Apps.
④	Moves to the LG Apps you want directly.
⑤ Search	These functions may be not available for a certain period of time depending on country or product model. In such cases, the buttons may be disabled. They are enabled when the services are available.
⑥ Web Browser	
⑦ Media Link	
⑧ Quick Apps.	Stores the most frequently used apps among all downloads. To change the list of Quick Apps, see "Using My Apps".
⑨ My Apps.	Moves to My Apps. You can browse all apps installed, change the list of Quick Apps, and select and play the app you want.

## Registration LG Apps

- 1 Press **Home** to access the Home menu.
- 2 Press Red button to register.  
- You can only register as a free member from your TV.
- 3 Create your ID and password.  
Press the Navigation buttons to select alphabet and number and select **OK**.
- 4 The registration is completed.

### NOTE

- If you wish to become a paid member or change your information, please use your PC and visit <http://www.lgappstv.com>.



## Sign in with LG Apps account

To enjoy the LG Apps with your account, you need sign in with the LG Apps account.

- 1 Press **Home** to access the Home menu.
- 2 Press Red button to sign in.  
It displays the keyboard menu for entering ID and password.
  - If you are not a member, press **Red** button again. You can only register as a free member from your TV.
- 3 Press the Navigation buttons to scroll to the alphabet or number and press **ENTER**.
  - If you check "Auto Sign In", you are automatically logged in whenever you turn on TV.
- 4 Enjoy the LG Apps.  
You can enjoy Premium service, LG Apps, My Apps and much more.

### ! NOTE

- You can download a paid app on up to five TVs.

## ID Management

- 1 After sign in, press **Red** button again.  
A pop-up window will appear.
- 2 Press the Navigation buttons to scroll to the desired menu option and press **ENTER**.

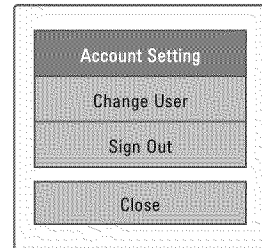

- 3 Manage the ID by using following menu.

Option	Description
Account Setting	Checks basic information, apps you purchased and apps installed on your TV.
Change User	Changes your account.
Sign Out	Sign out the premium service.

## Using LG Apps

- 1 Press **Home** to access the Home menu.
- 2 Sign in on your TV.
- 3 Press the Navigation buttons to scroll to the LG Apps and press **ENTER**.
- 4 Edit the Apps by using following menu.

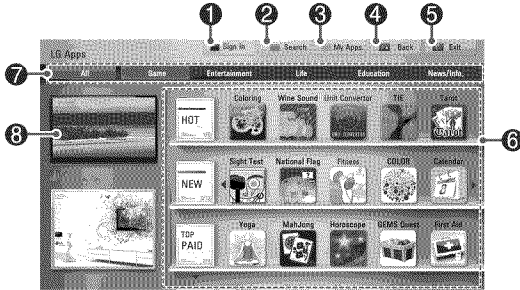

Option	Description
1 Sign in/out	Sign in or out to use the LG Apps.
2 Search	Search the LG Apps.
3 My Apps.	Move to My Apps.
4 Back	Move to the previous screen.
5 Exit	Exit the LG Apps.
6 Apps Sorting	<ul style="list-style-type: none"> <li>• Hot: Most downloaded apps in the past 7 days</li> <li>• New: Most recently released apps</li> <li>• Top Paid: Most downloaded paid apps</li> <li>• Top Free: Most downloaded free apps</li> <li>• All: Alphabetical order</li> <li>• Moves to the previous or next page using CH (^, v) button.</li> </ul>
7 Apps Category	Shows the LG Apps category (All, Game, Entertainment, Life, Education, News/Info.)
8 Live TV	Watches the current channel.

## Purchasing and Installing Apps.

Log in first to purchase apps.

- 1 Press the Navigation buttons to select Apps you want and press **ENTER**.  
You can see the information of the App.
- 2 Press **Purchase** to buy a App.

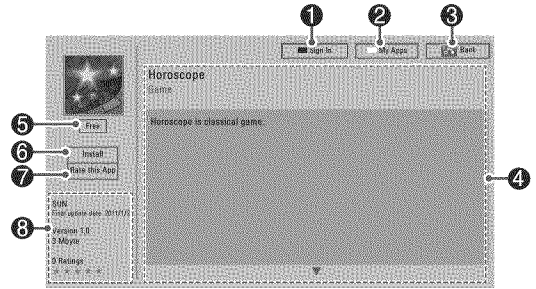

Option	Description
1 Sign in/out	Sign in or out to use the LG Apps.
2 My Apps.	Move to My Apps.
3 Back	Move to the previous screen.
4 App description	Shows the description of the current Apps.
5 Fee	Shows the fee of the current app.
6 Install	<p>Install or purchase the App. You can purchase an app on either your PC or TV, but it can be installed and played only on the TV.</p> <ul style="list-style-type: none"> <li>• If you want to purchase a paid app, you need to sign up as a paid member on <a href="http://www.lgappstv.com">www.lgappstv.com</a>.</li> <li>• If the available space of your TV is not enough, you can download apps in the USB storage device by connecting it to the USB IN 2 port.</li> <li>• You can play, delete or move the apps stored in the USB storage device on the My Apps screen.</li> </ul>
7 Rate this App	Rate the app you purchased with stars.
8 App info.	Shows the creator/program version/update date/volume/rating of the current Apps.

### NOTE

- To store apps in the USB storage device, make sure that it is connected to the USB IN 2/USB Apps port.
- Up to 1000 apps can be stored as USB apps.
- The USB storage device containing apps cannot be used for storing other types of data.

## Using My Apps

- 1 Enter the LG Apps after sign in.
- 2 Press the Navigation buttons to scroll to **My Apps.** and press **ENTER**.

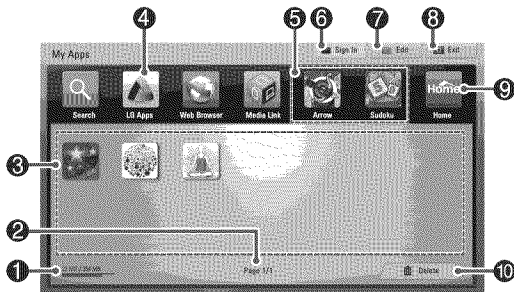

Option	Description
①	Shows the amount of used and available memories.
②	Current page number/total number of pages of My Apps.
③	Shows the downloaded apps. Moves to the previous or next page using CH (^, v) button.
④	Moves the LG Apps.
⑤	Quick Apps.
⑥	Sign In the LG Apps. After sign in, manage the ID option (Account Setting, Change User, Sign Out).
⑦	Edit the My Apps.
⑧	Exit the My Apps.
⑨	Move to the Home menu.
⑩	Delete the Apps.

## Search

(This feature is not available for all country.)  
 The search option supports LG apps and PLEX content. It will also work with some premium services that provide metadata.

- 1 Connect to the network.
- 2 Press **Home** to access the Home menu.
- 3 Press the Navigation buttons to scroll to **Search** and press **ENTER**.
- 4 Use the on-screen keyboard to type in your desired search term and press **Q**.

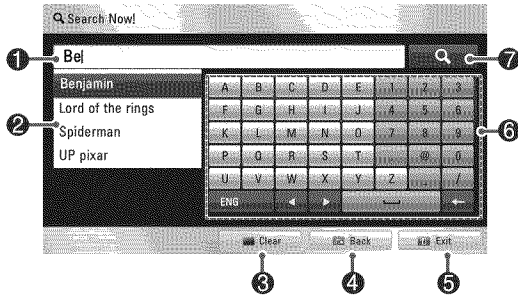

Option	Description
1	Input the word you would like to search here.
2	Show words similar to the input words. Select one of the similar words to enter it in the input field and search for it.
3	Clear the search term.
4	Move to the previous screen.
5	Exit the search.
6	On-screen keyboard.
7	Start the search after inputting the search term.

- 5 Press the Navigation buttons to select the desired searched results.

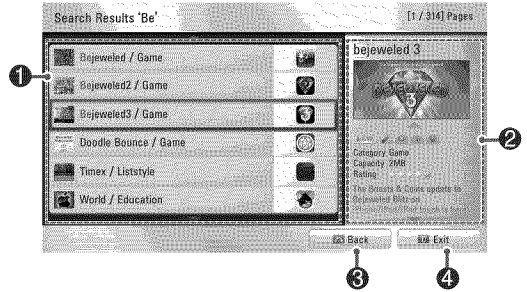

Option	Description
1	Show the searched results. This option is available only for LG apps, PLEX content and some premium services.
2	Shows detailed information on the selected search result.
3	Move to the previous screen.
4	Exit the Search.

# Web Browser Function

(This feature is not available for all country.)  
 The Web Browser allows you to view Web pages on your TV.

### More information about the Web Browser

- The web browser on this device supports Flash 8 and earlier.
- The web browser on this device does not support platform-dependent technologies such as ActiveX.
- The web browser on this device only supports preinstalled plug-ins.
- The web browser on this device may not support media formats other than the following: JPEG / PNG / GIF / WMV (ASF) / WMA / MP3 / MP4
- Some Web pages may exceed the memory allotment of the Web Browser. The Web Browser will close when this happens.
- The web browser on this device uses a single built-in font. Some text may not be displayed as intended.
- The web browser on this device does not support downloading of files or fonts.
- The web browser on this device is a TV browser. It may work differently to PC browsers.

## Using Web Browser

- 1 Connect to the network.
- 2 Press **Home** to access the Home menu.
- 3 Press the Navigation buttons to scroll to the **Web Browser** and press **ENTER**.
- 4 Press the Navigation buttons to scroll to the **URL** and press **ENTER**.

- 5 Press the Navigation buttons to scroll to the desired the URL and press **ENTER**.



- 6 You can browse websites on your TV.  
 Select the browser input window to display the keyboard at the bottom of the screen.

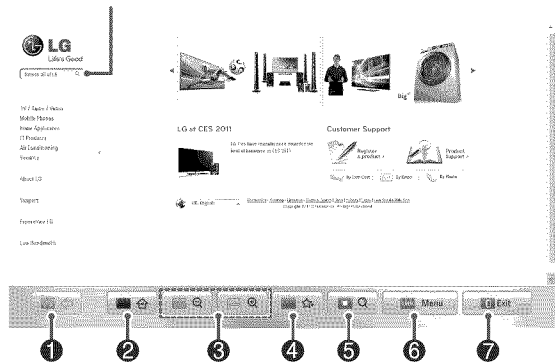

Option	Description
①	Move to the previous screen.
②	Move to the Favorites screen.
③	Zoom the screen in or out.
④	Add the current web page to Favorites.
⑤	Move to the search screen.
⑥	Move to the previous/next page in the list of recently viewed web pages. You can change the URL address to move to other websites. You can delete the list and cookies of recently viewed web pages.
⑦	Exit the web browser.

ENGLISH

## Browsing Favorite Websites

- 1 Connect to the network.
- 2 Press **Home** to access the Home menu.
- 3 Press the Navigation buttons to scroll to the **Web Browser** and press **ENTER**.
- 4 Press the Navigation buttons to scroll to the **Favorites** and press **ENTER**.
  - By adding frequently visited websites to Favorites, you can browse them easily.

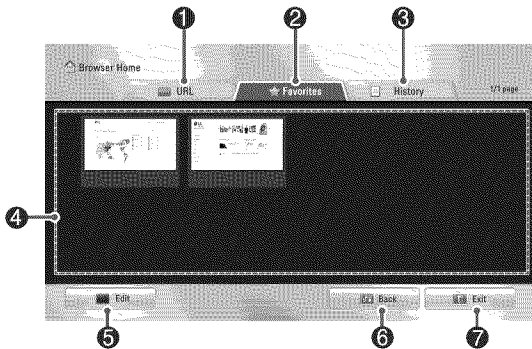

Option	Description
①	Browse a website by directly entering the URL address.
②	Select a website in Favorites.
③	View the list of recently viewed web pages.
④	Select a site to browse.
⑤	Edit Favorites. <ul style="list-style-type: none"> <li>• Move: Change the order in Favorites.</li> <li>• Rename: Rename the sites added to Favorites.</li> <li>• Delete: Remove the sites from Favorites.</li> </ul>
⑥	Move to the previous screen.
⑦	Exit the web browser.

## Browsing Websites by Directly Entering Address

- 1 Connect to the network.
- 2 Press **Home** to access the Home menu.
- 3 Press the Navigation buttons to scroll to the **Web Browser** and press **ENTER**.
- 4 Press the Navigation buttons to scroll to the **URL** and press **ENTER**.
  - You can browse a website by directly entering the URL address.

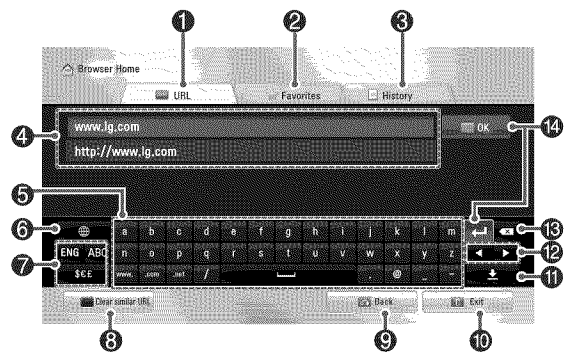

Option	Description
①	Browse a website by directly entering the URL address.
②	Select a website in Favorites.
③	View the list of recently viewed web pages.
④	Enter the URL address. If the address entered is similar to any of the sites previously visited, a drop-down list will be displayed.
⑤	Use the keyboard to enter the address. Select characters to enter.
⑥	Select the keyboard language.
⑦	Change the keyboard.
⑧	Clear the similar addresses appearing below the address input field.
⑨	Move to the previous page.
⑩	Exit the web browser.
⑪	Hide the keyboard. Select the address input field to display the keyboard again.
⑫	Move the cursor left or right.
⑬	Delete the text before the cursor, one character at a time.
⑭	Press this after entering the address to go to the website.

## Viewing Visited Website List

- 1 Connect to the network.
- 2 Press **Home** to access the Home menu.
- 3 Press the Navigation buttons to scroll to the **Web Browser** and press **ENTER**.
- 4 Press the Navigation buttons to scroll to the history and press **ENTER**.
  - You can view the addresses of the websites you visited previously. Select an item to move to the page.

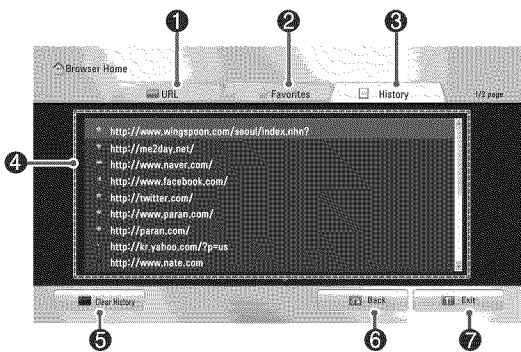

Option	Description
①	Browse a website by directly entering the URL address.
②	Select a website in Favorites.
③	View the list of recently viewed web pages.
④	Display a list of recently visited pages. Select an item to move to the page.
⑤	Clear the visited website list.
⑥	Move to the previous screen.
⑦	Exit the web browser.





## Connecting DLNA DMP (Digital Living Network Alliance, Digital Media Player)

This TV can display and play many types of movie, photo and music files from your DLNA server and has been certified by DLNA.

The Digital Living Network Alliance (DLNA) is a cross-industry organization of consumer electronics, computing industry and mobile device companies. Digital Living provides consumers with easy sharing of digital media through a wired or wireless network in the home.

The DLNA certification logo makes it easy to find products that comply with the DLNA Interoperability Guidelines. This unit complies with DLNA Interoperability Guidelines v1.5. When a PC running DLNA server software or other DLNA compatible device is connected to this TV, some setting changes of software or other devices may be required. Please refer to the operating instructions for the software or device for more information.

Please refer to "Smart Share Function" for additional information on supported file types and other instructions.

### NOTE

- The supplied Nero MediaHome 4 Essentials CD-ROM is a customized software edition only for sharing files and folders to this TV.
- The supplied Nero MediaHome 4 Essentials software does not support following functions: Transcoding, Remote UI, TV control, Internet services and Apple iTunes
- This manual explains operations with the English version of Nero MediaHome 4 Essentials as examples. Follow the explanation referring to the actual operations of your language version.
- If there are too many folders and files in one folder, it may not operate properly.
- For the DLNA option, use the Nero MediaHome program that is provided with the TV. However, we cannot guarantee that third party program will work perfectly.
- You can select a channel while viewing the small preview channel list on your TV screen.
- Check your network settings when the DLNA option does not work properly.
- If there is an abnormal operation or an error occurs in Nero Media Home, the DLNA option may not work properly. In this case, exit Nero Media Home and restart the program. You can download the latest version of Nero Media Home by clicking the question mark at the bottom-left of the program.
- When the network is unstable, the device may be slower or may need to load during playback.
- When playing a video in DLNA mode, the Multi Audio and Closed Caption features are not supported.
- When selecting Full Screen in DLNA mode, the ratio of the outputted screen may differ from the original.
- When more than one TV is connected to a single server in DLNA mode, a file may not play properly, depending on the server performance.
- If the play time information is not provided by the server, it is displayed as "- -."

### Installing Nero MediaHome 4 Essentials

Nero MediaHome 4 Essentials is an easy to use DLNA server software for Windows.

#### Computer requirements for Nero MediaHome 4 Essentials

- Windows® XP (Service Pack 2 or higher), Windows Vista® (no Service Pack required), Windows® XP Media Center Edition 2005 (Service Pack 2 or higher), Windows Server® 2003 (Service Pack 1 or higher)
- Windows® 7 Home Premium, Professional, Enterprise or Ultimate (32 and 64-bit)
- Windows Vista® 64-bit edition (application runs in 32-bit mode)
- Windows® 7 64-bit edition (application runs in 32-bit mode)
- Hard drive space: 200 MB hard drive space for a typical installation of Nero MediaHome stand-alone
- 1.2 GHz Intel® Pentium® III or AMD Sempron™ 2200+ processors
- Memory: 256 MB RAM
- Graphics card with at least 32 MB video memory, minimum resolution of 800 x 600 pixels, and 16-bit color settings
- Windows® Internet Explorer® 6.0 or higher
- DirectX® 9.0c revision 30 (August 2006) or higher
- Network environment: 100 Mb Ethernet, WLAN (IEEE 802.11g), or faster

- 1 Start up your computer.
- 2 Close all Microsoft Windows programs and exit any anti-virus software that may be running.
- 3 Insert the Nero MediaHome 4 Essentials CD-ROM into your computer's CD-ROM drive.
- 4 Click **Nero MediaHome 4 Essentials**. The installation wizard will appear.
- 5 Click the **Next** button to display the serial number input screen. Click **Next** to go to the next step.
- 6 If you accept all conditions, click **I accept the License Conditions** check box and click **Next**. Installation is not possible without this agreement.

- 7 Click **Typical** and click **Next**. The installation process is started.
- 8 If you want to take part in the anonymous collection of data, select the check box and click the **Next** button.
- 9 Click the **Exit** button to complete the installation.

### Sharing files and folders

After installing Nero MediaHome, you must add folders you wish to share.

- 1 Double-click the Nero MediaHome 4 Essentials icon on the desktop.
- 2 Click Network icon on the left and define your network name in the Network name field. The Network name you enter will be recognized by your TV.
- 3 Click Shares icon on the left.
- 4 Click Local Folders tab on the Shared screen.
- 5 Click Add icon to open the Browse Folder window.
- 6 Select the folder containing the files you want to share. The selected folder is added to the list of shared folders.
- 7 Click Start Server icon to start the server.

### ! NOTE

- If the shared folders or files are not displayed on the TV, click the folder on the Local Folders tab and click **Rescan Folder** at the **More** button.
- Visit <http://www.nero.com> for more information and software tools.

### Playing Shared Media

You can display and play movie, photo and music content stored on your computer or other DLNA media servers.

- 1 Press **Home** to access the Home menu.
- 2 Press the Navigation buttons to scroll to **Smart Share** and press **ENTER**.
- 3 Press the Navigation buttons to scroll to the device you want and press **ENTER**.
- 4 Press the Navigation buttons to select **DLNA**. Depending on the media server, this TV may need to get the permission from the server.

### Tips for using DLNA DMP

- To play the file on the media server, the TV and the media server must be connected to the same access point.
  - File requirements and playback functions on the Smart Share may differ depending on the media server used.
  - There may be some restrictions by file features and the media server that restrict playback.
  - Movie thumbnail is only supported when DLNA server supports a Movie thumbnail.
  - If there is an unplayable music file in the Smart Share menu, the TV will skip the file and play next file.
  - Files in a folder can be played only when they are of the same type.
  - The file information indicated on the screen may not always correct for music and movie files in Smart Share menu
  - This TV only supports movie subtitle files supplied by Nero MediaHome 4.
  - The subtitle file name and movie file name have to be the same and located in the same folder.
  - If subtitle files have been added after a directory has been indexed already, the user has to remove and re-add the folder to the list of shares.
  - The DRM/\*.tp/\*.trp file in DLNA server is not played while Movie List is in operation.
  - MPO files are not played when Photo List is in operation.
- The playback and operating quality of the Smart Share function may be affected by your home network condition.
  - The files from removable media such as USB drive, DVD-drive etc. on your media server may not share properly.
  - When playing the Media through DLNA connection, it does not support files protected by DRM.
  - Up to 1000 including folders and files can be recognized.
  - If there are too many folders and files in one folder, it may not operate properly.
  - The DLNA function is not available in some routers which do not support multicasting. For more information, refer to your router manual or contact the manufacturer.

## Connecting DLNA DMR (Digital Living Network Alliance, Digital Media Render)

This supports remote playing of media files. Media from a compatible device (Windows 7, Mobile Phone with PlayTo, or other compatible DLNA-DMC device) can be "pushed" to the TV.

The DMR function only works properly when the TV and PC are on the same local network.

- 1 To play a file, select the file by using the "Remote Play" feature in Windows 7.  
To do this, right-click on the file you want to play.
- 2 You can play a file only on a single TV set or device even though multiple devices are connected. The playback speed depends on the network status.

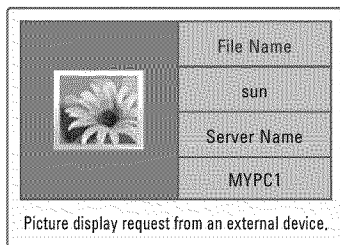

### ! NOTE

- Subtitle is supported only on some DMC devices.
- The DMR function may not work properly in a wireless network.
- The seek function of the DMC only works on video files.
- The DMR is not available when another function is operating (recording, playback or Smart Share work etc.).
- Refer to the owner's manual of the mobile phone or other device to find out how to use it to play a file.
- You can change the name of a connected TV by double-clicking the item you want to change in Control Panel > Network and Internet > View network computers and devices (For Windows 7).
- You cannot change the name of a TV while DMR media is playing. Change it when playback is stopped.

## Browsing files

Access the photo, music, or movie lists and browse files.

- 1 Connect a USB storage device.
- 2 Press **Home** to access the Home menu.
- 3 Press the Navigation buttons to scroll to **Smart Share** and press **ENTER**.
- 4 Press the Navigation buttons to scroll to the device you want and press **ENTER**.
- 5 Press Navigation buttons to scroll to **All Media**, **Movie List**, **Photo List**, or **Music List** and press **ENTER**.
  - **All Media**: Shows all files in the file list.
  - **Movie List**, **Photo List**, or **Music List**: Shows only one type of file in the file list.
- 6 Press Navigation buttons to select a folder or file you want.

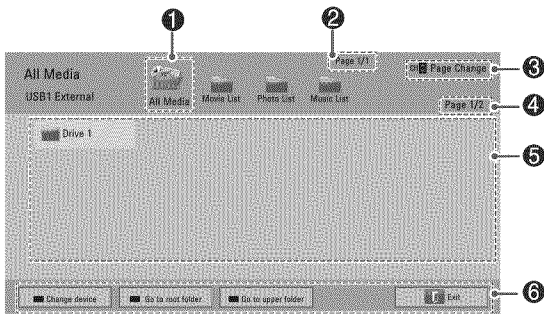

No.	Description
1	Shows all media folders.
2	Current page number/total number of pages.
3	Moves to the previous or next page.
4	Current page number/total number of pages.
5	Files info or thumbnail.
6	Available buttons on the remote control.

### Thumbnail information

Type	Abnormal files	Non-supported files
Video		
Photo		
Music		

### Tips for using USB storage devices

Type	Supported File Formats		
Video	<ul style="list-style-type: none"> <li>• MPG, MPEG, DAT, TS, TRP, TP, VOB, MP4, MOV, MKV, DivX, AVI, ASF, WMV, M4V</li> <li>• Max bitrate of playable movie file: 20 Mbps (Mega bit per second)</li> <li>• Bit rate of audio format: within 32 kbps to 320 kbps (MP3)</li> <li>• Supported external subtitle format: *.smi, *.srt, *.sub (MicroDVD, SubViewer 1.0/2.0), *.ass, *.ssa, *.txt (TMPlayer), *.psb (PowerDivX)</li> <li>• Supported Internal subtitle format: only XSUB (It is the subtitle format made in DivX files), Text UTF-8, SRT, ASS, SSA (It is the subtitle format used in DivX-Plus HD files)</li> </ul>		
	<ul style="list-style-type: none"> <li>• Do not use the progressive option when saving JPG files on your PC.</li> <li>• It may take some time to open high-resolution images in full screen.</li> </ul>		
Photo	File Extensions	Item	Profile
	2D	jpeg jpg jpe	Supported file format
3D (For 3D TV)	mpo	Supported file format	• mpo
		Photo size	<ul style="list-style-type: none"> <li>• 4:3 size: 3,648 x 2,736, 2,592 x 1,944, 2,048 x 1,536</li> <li>• 3:2 size: 3,648 x 2,432</li> </ul>
Music	<ul style="list-style-type: none"> <li>• MP3</li> <li>• Bit rate range: 32 Kbps - 320 Kbps</li> <li>• Sampling rate (Sampling Frequency)                             <ul style="list-style-type: none"> <li>MPEG1 layer 3: 32 kHz, 44.1 kHz, 48 kHz</li> <li>MPEG2 layer 3: 16 kHz, 22.05 kHz, 24 kHz</li> </ul> </li> <li>* A copy-protected file will not play.</li> </ul>		

## Viewing Videos

Play video files on the TV. Your TV can display video files from a USB storage device.

- 1 Press **Home** to access the Home menu.
- 2 Press the Navigation buttons to scroll to **Smart Share** and press **ENTER**.
- 3 Press the Navigation buttons to scroll to the device you want and press **ENTER**.
- 4 Press the Navigation buttons to scroll to **Movie List** and press **ENTER**.
- 5 Press Navigation buttons to select a folder or file you want and press **ENTER**.
- 6 Play a movie by using the following menus/ buttons.

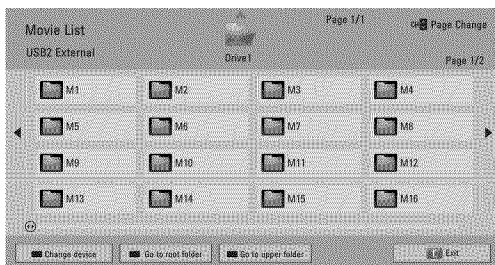

Button	Description
Navigation button	Scrolls through the files.
<b>ENTER</b>	Plays the highlighted file.
<b>CH</b> (▲, ▼)	Moves to the previous or next page.
Red button	Change device: Changes to a different input.
Green button	Go to root folder.
Yellow button	Go to upper folder.

- 7 Control playback by using the following buttons.

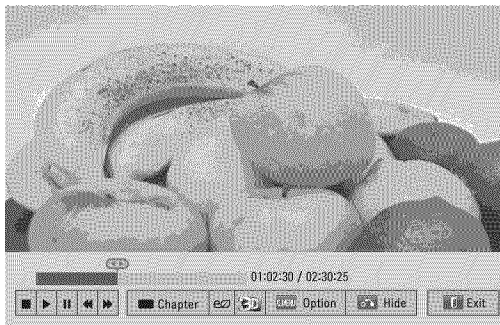

Button	Description
■	Stops the playback.
▶	Plays a video.
⏸	Pauses or resumes the playback
◀	Scans backward in a file
▶	Scans forward in a file
⏪ and ⏩	Plays videos in slow motion
Red button and < or >	Selects the frame directly. The entire file is divided into 10 frames. Frames may not be displayed depending on the file.
<b>ENERGY SAVING</b>	Increases or decreases the brightness of your screen.
<b>Q.MENU</b>	Shows the Option menu (See p.72).
<b>3D</b> (For 3D TV)	Views the 3D imaging.
<b>AV MODE</b>	Select the desired source
<b>BACK</b>	Hides the menu on screen. To see the menu again, press <b>ENTER</b> button to display.
<b>EXIT</b>	Moves to the previous menu screen.

**Tips for playing video files**

- The TV does not support the files encoded in Motion JPEG.
- Some user-created subtitles may not work properly.
- Subtitles may not display some special characters or HTML tags.
- Changing font and color in subtitles is not supported.
- Subtitles in non-supported languages are unavailable.
- Video files with subtitle files of 1 MB or larger may not be played properly.
- The screen may suffer from temporary interruptions such as image stoppage or faster playback when you change the audio language.
- If you play a damaged video file, the video file may not be played correctly or some player functions may not be unavailable.
- The TV may not properly play the video files produced with certain encoders.
- If the recorded file does not have video or audio, either video or audio is not outputted.
- If the TV plays the recorded file without video or audio, either video or audio is not outputted.
- The TV may not smoothly play the video files with a resolution higher than the supported resolution for each frame.
- The TV may not properly play the video files not included on the specified type and format.
- The TV may not play the files encoded with GMC (Global Motion Compensation) or quarter-pel motion estimation.
- The TV supports the only 10,000 sync blocks within the subtitle file.
- The TV supports the H.264/AVC codec up to the profile level 4.1.
- The TV does not support DTS audio codec.
- The TV cannot play a video file whose size is larger than 30 GB.
- If you play a video file through the USB connection that does not support the high speed, the video player may not work properly.
- The video file and its subtitle should be in the same folder and the name of the video file and subtitle should be identical.
- The TV may not play the video files in the supported file format depending on the encoded condition.
- Trick Mode does not support other functions than ► if video files do not have index information.
- Video file names that contain special characters may not be playable.
- For 3D WMV files encoded in dualstream, 3D mode is not supported. (For 3D TV)

**Q.MENU options for movie list**

- 1 Press **Q. MENU**.  
A pop-up window will appear.
- 2 Press the Navigation buttons to scroll to the option and press **ENTER**.
- 3 Press the Navigation buttons to scroll to one of the following options and press **ENTER**.

**Set Video Play.**

Option	Description	
Picture Size	Selects your desired picture format for videos. <ul style="list-style-type: none"> <li>• <b>Full Mode:</b> Files are played in full screen mode according to the aspect ratio of video.</li> <li>• <b>Original Mode:</b> Files are played in their native size.</li> </ul>	
Audio Language	Changes the Language Group of the audio for video files. Files with a single audio track cannot be selected.	
Subtitle Language	The subtitles can be turned on or off.	
Language	Activated for SMI subtitles and can select the language within the subtitle.	
Code Page	Subtitle font selection. When set to default, contents are displayed in the language set in "Option - Language - Menu Language."	
	<b>Option</b>	<b>Description</b>
	Subtitle Language Group	Latin1: English, Spanish, French Korean: English, Korean
	Sync	If the video is not synchronized with the captions, it can be adjusted by 0.5 second.
	Position	Move the location of the subtitles.
	Size	Changes the subtitle font size.
Repeat	Turn on/off repeat function of movie playback. When turned on, the file within the folder will be played back repeatedly. When turned off, if the next file name is similar to the previous file, it can be played sequentially.	

**NOTE**

- Option values changed in Movie List does not affect Photo List and Music List.
- Option value changed in Photo List and Music List are changed likewise in Photo List and Music List excluding Movie List.
- When replaying a video file after stopping, select "Yes" to restart where it previously stopped.
- If continuous series files exist within the folder, the next file will automatically be played. But, this excludes cases when the Repeat function of Movie List Option is turned "On".

**Set Video.**

Allows you to change Video presets (Refer to "PICTURE Settings" on page 88).

**Set Audio.**

Allows you to change Audio presets (Refer to "AUDIO Settings" on page 93).

**Set DivX PLUS HD**

These options are enabled only when the movie file being played has the title, edition and authored chapter information.

Option	Description
Title	For files with more than one title, select the title you want to play.
Edition	For files with more than one edition, select the edition you want to play. <ul style="list-style-type: none"> <li>• An edition refers to the playback order set based on the chapters.</li> </ul>
Authored Chapter	Select and play the chapter you want.



## DivX registration code

### Registering the DivX code

The DivX registration code allows you to rent or purchase the latest movies at [www.divx.com/vod](http://www.divx.com/vod). To play a rented or purchased DivX file, the file's registration code should be same as your TV's DivX registration code.

- 1 Press **Home** to access the Home menu.
- 2 Press the Navigation buttons to scroll to **SETUP** and press **ENTER**.
- 3 Press the Navigation buttons to scroll to **OPTION** and press **ENTER**.
- 4 Press the Navigation buttons to scroll to **Smart Share Setting** and press **ENTER**.
- 5 Press the Navigation buttons to scroll to **DivX VOD Registration** and press **ENTER**.
- 6 View the registration code of your TV.



- 7 When you are finished, press **EXIT**.

### ! NOTE

- While you are checking the registration code, some buttons may not work.
- If you use the DivX registration code of another device, you cannot play the rented or purchased DivX file. Make sure to use the DivX registration code assigned to your TV.
- The video or audio files that are not converted by the standard DivX codec may be corrupted or not be played.
- The DivX VOD code allows you to activate up to 6 devices under one account.

### Deactivating the DivX feature

You can deactivate all of the devices through the web server and block devices from activating. Delete the existing authentication information to receive a new DivX user authentication for the TV. Once this function is executed, a DivX user authentication is required again to see DivX DRM files.

- 1 Press **Home** to access the Home menu.
- 2 Press the Navigation buttons to scroll to **SETUP** and press **ENTER**.
- 3 Press the Navigation buttons to scroll to **OPTION** and press **ENTER**.
- 4 Press the Navigation buttons to scroll to **Smart Share Setting** and press **ENTER**.
- 5 Press the Navigation buttons to scroll to **DivX Deregistration** and press **ENTER**.
- 6 Select **Yes** to confirm.

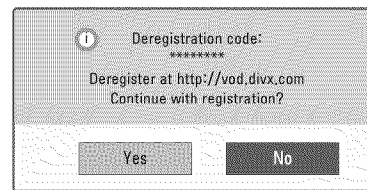

- 7 When you are finished, press **EXIT**.

## Viewing Photos

You can view image files saved on a USB storage device. The displays on the screen may based on the from the model.



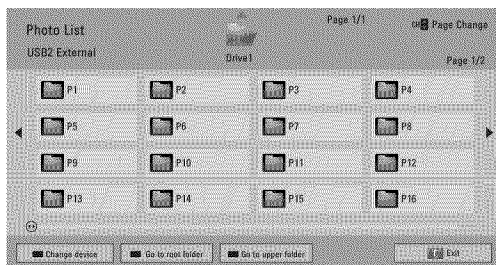

- 1 Press **Home** to access the Home menu.
- 2 Press the Navigation buttons to scroll to **Smart Share** and press **ENTER**.
- 3 Press the Navigation buttons to scroll to the device you want and press **ENTER**.
- 4 Press the Navigation buttons to scroll to **Photo List** and press **ENTER**.
- 5 Press Navigation buttons to select a folder or file you want and press **ENTER**.
- 6 View a photo by using the following menus/ buttons.



Button	Description
Navigation button	Scrolls the file.
<b>ENTER</b>	Views the highlighted file.
<b>CH</b> (▲, ▼)	Moves to the previous or next page.
Red button	Change device: Changes to a different input.
Green button	Go to root folder.
Yellow button	Go to upper folder.

- 7 The following options are available while viewing photos.



Option	Description
<b>Slideshow</b>	<ul style="list-style-type: none"> <li>Starts or stops a slideshow.</li> <li>All photos saved in the current folder display during a slideshow.</li> <li>To set a slideshow speed, select Option.</li> </ul>
<b>BGM (Background Music)</b>	<ul style="list-style-type: none"> <li>Turns the background music on or off. To set the background music folder, select Option.</li> </ul>
 (Painting)	Displays the current photo in Original, Monotone, Sepia, Oil Painting and Vignetting.
 (Rotate)	Rotates photos clockwise (90°, 180°, 270°, 360°). <div style="border: 1px solid black; padding: 5px; margin-top: 10px;"> <p><b>NOTE</b></p> <ul style="list-style-type: none"> <li>The supported photo size is limited. You cannot rotate a photo if the resolution of the rotated width is larger than the supported resolution size.</li> </ul> </div>
	Views the photo in full mode or original mode.
 (ENERGY SAVING)	Increases or decreases the brightness of your screen.
<b>3D (For 3D TV)</b>	Views the 3D images.
<b>Option</b>	Shows the Option menu (See p.75).
<b>Hide</b>	Hides the option window. To display the options, press <b>ENTER</b> .
<b>Exit</b>	Moves to the previous menu screen.

**Q.MENU options for photo list**

- 1 Press **Q. MENU**.  
A pop-up window will appear.
- 2 Press the Navigation buttons to scroll to the option and press **ENTER**.
- 3 Press the Navigation buttons to scroll to one of the following options and press **ENTER**.

**Set Photo View.**

Option	Description
Slide Speed	Selects a slideshow speed (Fast, Medium, Slow).
BGM	Selects a music folder for the background music. Select Repeat or Random option.  <div style="border: 1px solid black; padding: 5px;"> <p><b>!</b> <b>NOTE</b></p> <ul style="list-style-type: none"> <li>• You cannot change the music folder while the background music is playing.</li> </ul> </div>

**!** **NOTE**

- Option values changed in Photo List do not affect Movie List and Music List.
- Option values changed in Photo List or Music List are changed likewise in Photo List and Music List, but not Movie List

**Set Video.**

Allows you to change Video settings. (Refer to "PICTURE Settings" on page 88).

**Set Audio.**

Allows you to change Audio settings. (Refer to "AUDIO Settings" on page 93).

## Listening to music

- 1 Press **Home** to access the Home menu.
- 2 Press the Navigation buttons to scroll to **Smart Share** and press **ENTER**.
- 3 Press the Navigation buttons to scroll to the device you want and press **ENTER**.
- 4 Press the Navigation buttons to scroll to **Music List** and press **ENTER**.
- 5 Press Navigation buttons to select a folder or file you want and press **ENTER**.
- 6 Play music by using the following menus/ buttons.

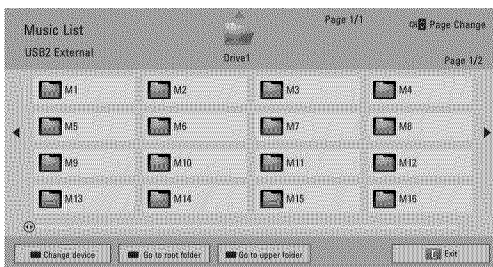

Button	Description
Navigation button	Scrolls through the files.
ENTER	Plays the highlighted file.
CH (▲, ▼)	Moves to the previous or next page.
Red button	Change device: Changes to a different input.
Green button	Go to root folder.
Yellow button	Go to upper folder.
Blue button	Open music player. It is enabled during palying music.

- 7 Control playback by using the following buttons.

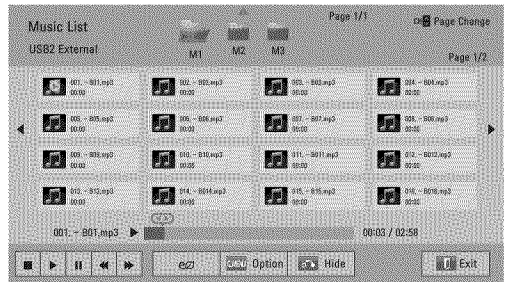

Button	Description
■	Stops playback.
▶	Plays a music file.
⏸	Pauses or resumes playback.
◀	Skips to the previous file.
▶	Skips to the next file.
< or >	Indicates a cursor.
eO (ENERGY SAVING)	Increases or decreases the brightness of your screen.
Q.MENU	Shows the Option menu (See p.76).
BACK	Hides the option window. To display the options, press ENTER.
EXIT	Moves to the previous menu screen.

### Tips for playing music files

- The TV cannot support the ID3 Tag embedded MP3 files.

### Q.MENU options for music list

- 1 Press **Q. MENU**.  
A pop-up window will appear.
- 2 Press the Navigation buttons to scroll to the option and press **ENTER**.
- 3 Press the Navigation buttons to scroll to one of the following options and press **ENTER**.

### NOTE

- Option values changed in Movie List does not affect the Photo List and Music List.
- Option value changed in Photo List and Music List are changed likewise in Photo List and Music List.

### Set Audio Play.

Select Repeat or Random option.

### Set Audio.

Allows you to change Audio settings. (Refer to "AUDIO Settings" on page 93).

#### ! NOTE

- The TV will not play copy protected files.
- If the TV is not in use for some time during playback, the information box as a screensaver will appear to prevent image burn.

To return to the Music list screen, press **ENTER**.

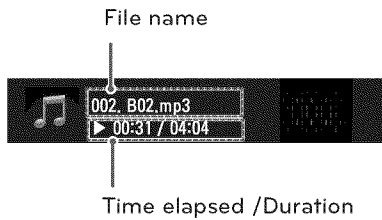

## Media Link Function

(This feature is not available for all country.)

The Media Link program allows you to connect to a Plex Media Server. The Plex Media Server is free download from [www.plexapp.com](http://www.plexapp.com). It will allow to play media files and download Plex apps. The Plex apps download to your computer and do not use any space on the TV.



### NOTE

- We recommend that you install version 0.9.1.14 or later of PLEX Media Server on your Mac or PC. (Download the installation file at <http://www.plexapp.com/medialink>)
- GUI is displayed in English and the data transmitted will not be displayed when using the following languages: Thai, Arabic, Persian, Hebrew, Kurdish.
- When using the video plug-in, initial buffering may take a while if the TV does not support a file to be played and conversion needs to be performed on the computer. The conversion performance may vary depending on the computer's performance and the network speed.
- When playing the files stored on the computer (movies, TV shows, music), the formats supported are the same as those for the DLNA function. The skip to content function is not supported when playing music. (Same for DLNA)
- You may experience problems when playing HD movies over Wi-Fi due to the network slowing down.
- When using a router, the TV may not detect the computer due to the router settings. (For example, when using the multicast forward function in some routers, TVs cannot detect computers via Wi-Fi.)
- Some plug-ins may not work, depending on the media format.
- Plug-ins are subject to change and may stop working without prior notice, at the providers' discretion.

## Media Link Connection

- 1 Your TV must be connected to your home network. Either using a wired or wireless connection.
- 2 Download the Plex Media Server and install it.
  - You can download it at <http://www.plexapp.com/medialink>.
  - For more information on how to install it, please visit the website above.
- 3 When running PLEX for the first time, the wizard guides you through the steps to set up the program.
  - For information on how to use the wizard, please visit the website above.

## Using Media Link

- 1 Press **Home** to access the Home menu.
- 2 Press the Navigation buttons to scroll to the **Media Link** and press **ENTER**.
- 3 The Media Link sections of the connected computer are displayed. Select an icon to view the shared media in that category.

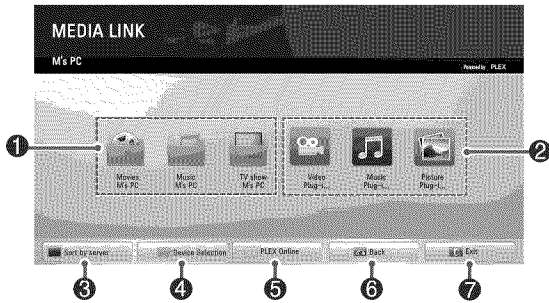

Option	Description
1	This is a list of categories you set on the connected computer.
2	This is a list of plug-ins for online content.
3	Change the section sorting. <ul style="list-style-type: none"> <li>• By server name: Sort the list by server name.</li> <li>• By item name: Sort the list by item name.</li> </ul>
4	Select another device.
5	Using PLEX Online, you can install, remove or update applications on the computer.
6	Move to the previous screen.
7	Exit Media Link.

## Viewing Movies

Media Link will retrieve information on shared movies as described below.

- 1 Press **Home** to access the Home menu.
- 2 Press the Navigation buttons to scroll to the **Media Link** and press **ENTER**.
- 3 Press the Navigation buttons to scroll to the Video and press **ENTER**.

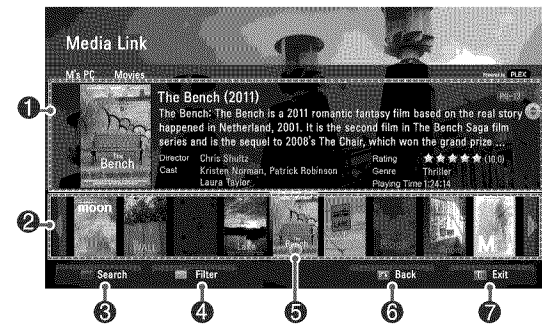

Option	Description
1	Show information for the selected movie.
2	Show images captured from the movie file.
3	Search movies within the section.
4	Display the list according to the selected filter.
5	Select to play the movie in full screen mode. If the movie has already been played, you can continue from the last scene.
6	Move to the previous screen.
7	Exit Media Link.

ENGLISH

## Using Music Section

You can view information for the music files set for the Music section and enjoy them.

- 1 Press **Home** to access the Home menu.
- 2 Press the Navigation buttons to scroll to the **Media Link** and press **ENTER**.
- 3 Press the Navigation buttons to scroll to the Music section and press **ENTER**.

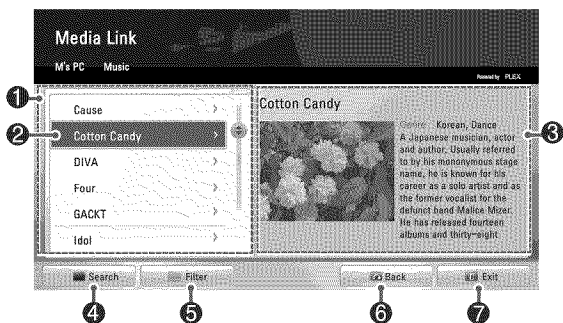

Option	Description
①	Sort the music files in the selected section in the order of artist > album > song title.
②	Select a folder or a song.
③	Show the artist, album and information for the selected music.
④	Search music files within the section.
⑤	Display the list according to the selected filter.
⑥	Move to the previous screen.
⑦	Exit Media Link.

## Using TV Program Section

You can view information for the programs contained in the TV Show section and enjoy them.

- 1 Press **Home** to access the Home menu.
- 2 Press the Navigation buttons to scroll to the **Media Link** and press **ENTER**.
- 3 Press the Navigation buttons to scroll to the TV Show section and press **ENTER**.

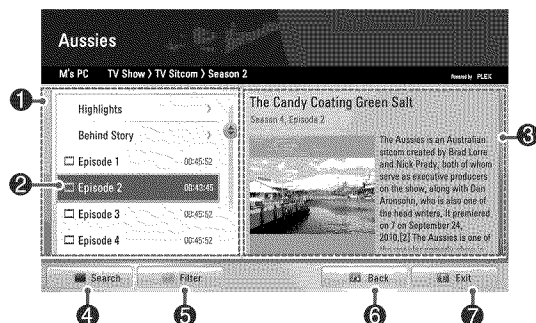

Option	Description
①	Sort the TV program files in the selected section in the order of Program name > season > episode.
②	Select a folder or a program.
③	Show information for the selected program.
④	Search TV Programs within the section.
⑤	Display the list according to the selected filter.
⑥	Move to the previous screen.
⑦	Exit Media Link.



## Installing Plug-Ins

Media Link allows you to install plug-ins to enjoy media content on the web.

- 1 Press **Home** to access the Home menu.
- 2 Press the Navigation buttons to scroll to the **Media Link** and press **ENTER**.
- 3 Press the yellow button to select **PLEX online**.



Option	Description
1	Move the cursor to a plug-in to view the plug-in information on the right pane. Plug-ins already installed: You can run, update, reinstall or remove them. Plug-ins not yet installed: You can install them. Once installed, you can run the plug-in by selecting Video, Music or Picture Plug-in from the Media Link main screen.
2	A list of plug-ins available for installation.
3	Move to the previous screen.
4	Exit Media Link.

# 3D IMAGING (FOR 3D TV)

## 3D Technology

This TV can display in 3D via 3D broadcasting or when the TV is connected to a compatible device, such as a Blu-ray 3D Player. The viewer must wear compatible 3D glasses in order to see these images in 3D format.

## When watching 3D imaging

- We recommend that you maintain a distance of at least twice the screen diagonal length when watching 3D videos (  ).
- To watch the TV in 3D, you must put on your 3D glasses. For best results, you should wear LG Brand 3D glasses. The 3D imaging may not display properly when using another brand of 3D glasses. Please see the 3D glasses manual for instructions on how to use the 3D glasses.
- When watching 2D images, it is recommended to take off the 3D glasses. If you watch 2D images with the 3D glasses on, you may see distorted images.

(  )

- After powering on the TV, a few seconds may be needed for your TV to calibrate.
- The TV may flicker slightly if the 3D imaging is displayed under 3 wavelength fluorescent light (50 Hz - 60 Hz) or magnetic fluorescent lamp (50Hz - 60 Hz). In such instances, it is recommended to turn the lights off.
- If there is an obstacle between the TV and the 3D glasses, the 3D imaging may not display properly.
- Do not use the TV in close proximity to other electronic equipments and RF equipments.
- The 3D imaging may not display if it is viewed while you are lying down.
- It may take a moment for you to see the 3D imaging if you look away from the TV and then revert your eyes back to the 3D program.

## When using 3D Glasses

- Do not use the 3D glasses to replace your corrective glasses, sunglasses or protective goggles.
- Do not store the 3D glasses in hot or cold locations.
- Do not drop objects onto the 3D glasses. Do not drop or bend the glasses.
- Since the lenses of the 3D glasses are easily scratched, make sure to clean only with a soft cloth. Shake off any dust before using the cloth since the glasses are easily scratched.
- A communication failure may occur if the glasses are near electronic devices that use the same bandwidth (2.4 GHz), such as a microwave oven or wireless LAN product.





## 3D Imaging Viewing Range (📺)

TV size, viewing angle & other circumstances may change the viewing distance and the angle of view.

Viewing Distance	Maximum Viewing Distance
2 m - 7 m (6.5 ft - 22.9 ft)	10 m (32.8 ft)

## Viewing 3D Imaging

- 1 Play the video produced in 3D.
- 2 Press **3D** to watch 3D imaging.
- 3 Wear the 3D glasses.
- 4 Press the Navigation buttons to scroll the **OK** and press **ENTER**.
- 5 Press the Navigation buttons to select the shape and press **ENTER**.

Mode	Description
2D » 3D	Changed from 2D imaging to 3D imaging. 2D-to-3D converted videos may appear less realistic than titles originally produced as 3D videos. 
Side by Side	
Top & Bottom	
Checker Board	
Frame Sequential	

- 6 Press **3D** button to **2D Off** or **3D Off**.

Option	Description
3D -> 2D	Displays images in 2D without any 3D effects.
3D Off	Displays images in original format.
2D -> 3D	Displays images in 3D.
Cancel	Close the pop-up window.

## Setting 3D Imaging

- 1 Press the **3D OPTION** while viewing 3D imaging.  
A pop-up window will appear.
- 2 Press the Navigation buttons to scroll to one of the following options and press **ENTER**.

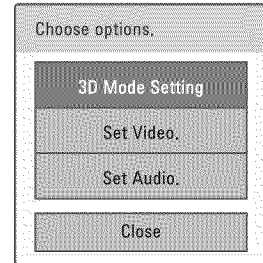

### 3D Mode Setting

Option (Depending on model)	Description
3D Picture Size	Cuts off the outer edges of the picture and stretch it to fit the full screen in 3D mode.
3D Picture Correction	Select <b>Left/Right</b> or <b>Right/Left</b> . Select the screen with 3D video with better visibility.
3D Depth	Adjusts the stereoscopic effect of the 3D image converted from 2D image.
3D Viewpoint	Moves the 3D image to front and back to adjust the 3D perspective view.
3D Picture Balance	Adjusts the color and brightness difference between the right and left sides of the picture in 3D mode.
3D Optimization	Optimizes the 3D image screen for the viewing environment.

### Set Video.

Allows you to change Video settings (Refer to "PICTURE Settings" on page 88).

### Set Audio.

Allows you to change Audio settings (Refer to "AUDIO Settings" on page 93).



#### CAUTION

- Some menus may not work while viewing 3D imaging.
- The 3D imaging is disabled automatically when switching input source or DTV channel.
- The screen may not be displayed properly if you view 2D images in 3D imaging mode.
- 3D effect can be seen when 3D Mode is selected appropriately for the 3D input signal supplied to the TV.
- For \*.mpo files (3D camera files), the 3D imaging mode is enabled automatically.



#### NOTE



- If viewing 3D imaging, "Power indicator" is turned off automatically.
- You can only choose "**Off** or **Cinema**" with the **AV MODE** button on the remote control.
- Energy Saving is disabled while playing in 3D.
- Home menu is not available while playing in 3D.
- You cannot enter the Home menu while watching 3D imaging.



The model and serial numbers of the TV is located on the back of the TV  
Record it below should you ever need service.

MODEL \_\_\_\_\_

SERIAL \_\_\_\_\_

## Free Manuals Download Website

<http://myh66.com>

<http://usermanuals.us>

<http://www.somanuals.com>

<http://www.4manuals.cc>

<http://www.manual-lib.com>

<http://www.404manual.com>

<http://www.luxmanual.com>

<http://aubethermostatmanual.com>

Golf course search by state

<http://golfingnear.com>

Email search by domain

<http://emailbydomain.com>

Auto manuals search

<http://auto.somanuals.com>

TV manuals search

<http://tv.somanuals.com>