



High Definition Television Receiver

OWNER'S MANUAL

MODEL NO: LST-4200A



Before connecting, operating or adjusting this product,
please read this owner's manual carefully and completely.



Safety Precautions



CAUTION
RISK OF ELECTRIC SHOCK
DO NOT OPEN



CAUTION:

TO REDUCE THE RISK OF ELECTRIC SHOCK DO NOT REMOVE COVER (OR BACK). NO USER SERVICEABLE PARTS INSIDE. REFER TO QUALIFIED SERVICE PERSONNEL.



THE LIGHTNING FLASH WITH ARROWHEAD SYMBOL, WITHIN AN EQUILATERAL TRIANGLE, IS INTENDED TO ALERT THE USER TO THE PRESENCE OF UNINSULATED "DANGEROUS VOLTAGE" WITHIN THE PRODUCT'S ENCLOSURE THAT MAY BE OF SUFFICIENT MAGNITUDE TO CONSTITUTE A RISK OF ELECTRIC SHOCK TO PERSONS.



THE EXCLAMATION POINT WITHIN AN EQUILATERAL TRIANGLE IS INTENDED TO ALERT THE USER TO THE PRESENCE OF IMPORTANT OPERATING AND MAINTENANCE (SERVICING) INSTRUCTIONS IN THE LITERATURE ACCOMPANYING THE APPLIANCE.

WARNING

TO PREVENT FIRE OR SHOCK HAZARDS, DO NOT EXPOSE THIS PRODUCT TO RAIN OR MOISTURE.

Apparatus shall not be exposed to dripping or splashing and no object filled with liquids, such as vases, shall be placed on the apparatus.

WARNING: Do not install this equipment in a confined space such as a bookcase or similar unit.

CAUTION: TO PREVENT ELECTRIC SHOCK, MATCH WIDE BLADE OF PLUG TO WIDE SLOT AND FULLY INSERT.

ATTENTION: POUR ÉVITER LES CHOC ÉLECTRIQUES, INTRODUIRE LA LAME LA PLUS LARGE DE LA FICHE DANS LA BORNE CORRESPONDANTE DE LA PRISE ET POUSSER JUSQU'AU FOND.

NOTE TO CABLE/TV INSTALLER

This reminder is provided to call the cable TV system installer's attention to Article 820-40 of the National Electric Code (U.S.A.). The code provides guidelines for proper grounding and, in particular, specifies that the cable ground shall be connected to the grounding system of the building, as close to the point of the cable entry as practical.

REGULATORY INFORMATION: FCC Part 15

This product has been tested and found to comply with the limits for a Class B digital device, pursuant to Part 15 of the FCC Rules. These limits are designed to provide reasonable protection against harmful interference when the product is operated in a residential installation. This product generates, uses and can radiate radio frequency energy and, if not installed and used in accordance with the instruction manual, may cause harmful interference to radio communications. However, there is no guarantee that interference will not occur in a particular installation. If this product does cause harmful interference to radio or television reception, which can be determined by turning the product off and on, the user is encouraged to try to correct the interference by one or more of the following measures:

- Reorient or relocate the receiving antenna.
- Increase the separation between the product and receiver.
- Connect the product into an outlet on a circuit different from that to which the receiver is connected.
- Consult the dealer or an experienced radio/TV technician for help.

COMPLIANCE: The responsible party for this product's compliance is:

LG Electronics U.S.A., Inc., 1000 Sylvan Avenue, Englewood Cliffs, NJ 07632 Phone: 1-201-816-2000

CAUTION

DO NOT ATTEMPT TO MODIFY THIS PRODUCT IN ANY WAY WITHOUT WRITTEN AUTHORIZATION FROM LG ELECTRONICS CORPORATION. UNAUTHORIZED MODIFICATION COULD VOID THE USER'S AUTHORITY TO OPERATE THIS PRODUCT. THIS EQUIPMENT IS INTENDED TO RECEIVE AND DECODE SIGNALS TRANSMITTED ACCORDING TO ATSC DIGITAL TELEVISION STANDARD A/53, SPECIFICATION AND IS INTENDED TO BE USED WITH AN APPROPRIATE ANTENNA AND DISPLAY DEVICE THAT YOU MUST PROVIDE.



As an ENERGY STAR® Partner, LG has determined that this product or product models meets the ENERGY STAR® guidelines for energy efficiency.

ENERGY STAR® is a U.S. registered mark.

Marketed and Distributed in the United States by LG Electronics U.S.A., Inc.
1000 Sylvan Avenue, Englewood Cliffs, NJ 07632
Phone: 1-201-816-2000

IMPORTANT SAFETY INSTRUCTIONS

CAUTION: PLEASE READ AND OBSERVE ALL WARNINGS AND INSTRUCTIONS IN THIS INSTALLATION AND OPERATING GUIDE AND THOSE MARKED ON THE UNIT. RETAIN THIS GUIDE FOR FUTURE REFERENCE.

This set has been designed and manufactured to assure personal safety. Improper use can result in electric shock or fire hazard. The safeguards incorporated in this unit will protect you if you observe the following procedures for installation, use, and servicing.

This unit does not contain any parts that can be repaired by the user.

DO NOT REMOVE THE CABINET COVER, OR YOU MAY BE EXPOSED TO DANGEROUS VOLTAGE. REFER SERVICING TO QUALIFIED SERVICE PERSONNEL ONLY.

- 1. Read these instructions.** - All these safety and operating instructions should be read before the product is operated.
- 2. Keep these instructions.** - The safety, operating and use instructions should be retained for future reference.
- 3. Heed all warnings.** - All warnings on the product and in the operating instructions should be adhered to.
- 4. Follow all instructions.** - All operating and use instructions should be followed.
- 5. Do not use this apparatus near water.** - For example: near a bath tub, wash bowl, kitchen sink, laundry tub, in a wet basement; near a swimming pool; etc.
- 6. Clean only with dry cloth.** - Unplug this product from the wall outlet before cleaning. Do not use liquid cleaners.
- 7. Do not block any ventilation openings. Install in accordance with the manufacturer's instructions.** - Slots and openings in the cabinet are provided for ventilation, to ensure reliable operation of the product, and to protect it from over-heating. The openings should never be blocked by placing the product on a bed, sofa, rug or other similar surface. This product should not be placed in a built-in installation such as a bookcase or rack unless proper ventilation is provided and the manufacturer's instructions have been adhered to.
- 8. Do not install near any heat sources such as radiators, heat registers, stoves, or other apparatus (including amplifiers) that produce heat.**
- 9. Do not defeat the safety purpose of the polarized or grounding-type plug.** A polarized plug has two blades with one wider than the other. A grounding type plug has two blades and a third grounding prong. The wide blade or the third prong are provided for your safety. If the provided plug does not fit into your outlet, consult an electrician for replacement of the obsolete outlet.
- 10. Protect the power cord from being walked on or pinched particularly at plugs, convenience receptacles, and the point where they exit from the apparatus.**
- 11. Only use attachments/accessories specified by the manufacturer.**
- 12. Use only the cart, stand, tripod, bracket, or table specified by the manufacturer, or sold with apparatus. When a cart is used, use caution when moving the cart/ apparatus combination to avoid injury from tip-over.**
- 13. Unplug this apparatus during lightning storms or when unused for long periods of time.**
- 14. Refer all servicing to qualified service personnel. Servicing is required when the apparatus has been damaged in any way, such as power-supply cord or plug is damaged, liquid has been spilled or objects have fallen into the apparatus, the apparatus has been exposed to rain or moisture, does not operate normally, or has been dropped.**



Setup Checklist

1. **Unpack HDTV Receiver and all accessories.**
2. **Connect your HDTV Receiver to antenna and TV/Monitor.**
(See pages 10 - 14)
3. **Connect all external video and audio equipment.**
(See pages 15 - 16)
4. **Install batteries in Remote Control.**
(See page 7)
5. **Plug the HD TV Receiver, TV/Monitor, and source equipment into standard power outlets.**
6. **Turn HDTV Receiver and TV/Monitor on.**
7. **Choose on screen menu language.**
(See page 25) (English is pre-selected.)
8. **Use EZ Scan* to search for all channels in your area.**
(See page 19)
9. **Fine-tune source's image and sound to personal preference or as required of the source.**
(See pages 23 & 26)
10. **Additional features Setup**
(See Table of Contents)

* EZ Scan/Channel Search Notes -Available Channels/Active Channels/DTV Channels

EZ Scan finds channels which have a signal present and are actively being broadcast. Some broadcasters may not provide, or send, or broadcast a signal continuously. As a result, some DTV channels may not be found by EZ Scan. If you know that there is a DTV channel that was not found by EZ Scan, run EZ Add when the DTV channel is actually sending out a program.

Table of Contents

Introduction

Safety Precautions	2
IMPORTANT SAFETY INSTRUCTIONS	3
Setup Checklist	4
Table of Contents	5
Front Panel Controls and Display Window	6
Remote Control Key Functions	7
Unpacking HDTV Receiver and Accessories/Connection Overview	8
Connection Panel	9

INSTALLATION

Connections	10-17
Antenna Connections	10
Analog Monitor Connections	11
HD Monitor Component (YPbPr) Connections ..	12
HD Monitor RGB Connections	13
HD Monitor DVI-HDTV Connections	14
VCR Connections	15
Audio Amplifier (Receiver) Connections	16
Display Format Setup	17

MENU OPERATION

Menu Overview	18
Typical Menu Operation	18
Help Function	18
Setup Menu Options	19-21
EZ Scan (Channel Search)	19
EZ Add	19
Ch. Edit (Channel Edit)	20
Manual Add	21
EZ Demo	21
Option Menu Features	22-25
Clock	22
Aspect Ratio	23
Use the RATIO button to choose Aspect Ratios .	24
Menu Language	25
Audio Language	25
Analog Audio	25
Audio Output	26
Audio Variable	26
Caption Menu Options	27-29
DTV Captions	27
DTV Caption Style	28
Analog Captions	29

Lock (Parental Control) Menu Options

Lock System	30
Set Password	30
Block Ch. (Channel)	31
Movie Rating	32-33
TV Rating-Children	34
TV Rating-General	35-36
GUIDE Options	37
Program Guide	37
Station Guide	37
Information Displays	38-39
Channel Banner Display	38
Program Information Display	39



NORMAL OPERATION

Program and Station Guide	40-41
Normal Operation	42
Channel Selection	42
Sound Level Adjustment	42
Signal	42
Freeze	42

REFERENCE

Programming the Remote Control to Operate Other Devices	43
Remote Control Codes for Other Devices	44-45
Troubleshooting	46
Specifications	47
Warranty	Back Cover

About the symbols for instructions

-  Indicates hazards likely to cause harm to the unit itself or other material damage.
-  Indicates special operating features of this unit.
-  Indicates tips and hints for making the task easier.

Manufactured under license from Dolby Laboratories. Dolby, and the double-D symbol are trademarks of Dolby Laboratories. Confidential unpublished works. Copyright 1992-1997 Dolby Laboratories. All rights reserved.

Front Panel Controls and Display Window

Directional Arrow Buttons (▲/▼/◀/▶)

Use to navigate within the on-screen menus and to adjust the system settings and preferences.

Use the Arrow Keys to move to a menu option and then use the SELECT button to access it. If no menu is displayed, the LEFT/RIGHT arrows control the volume setting and the UP/DOWN arrows select channels.

Remote Control Sensor

Receives signals from the Remote Control.

POWER

Turns the HDTV Receiver on or off.

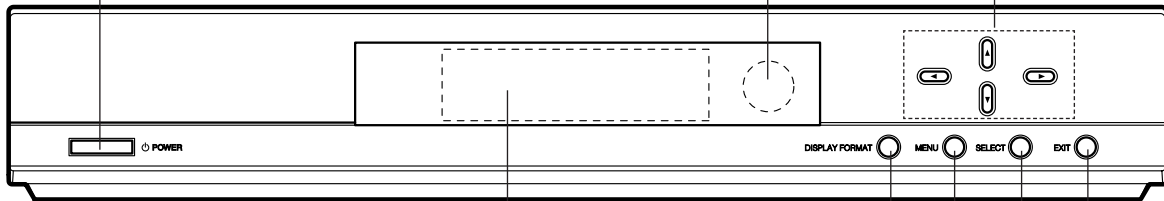

Display Window

DISPLAY FORMAT

Sets the output resolution to 1080i, 720p, 480p, or 480i formats and chooses the correct display format for your TV. (Refer to page 17)

MENU

Shows the main menu on the screen. You can return to normal viewing by pressing the EXIT button.

SELECT

If the main menu is displayed, pressing the SELECT button will activate the selected MENU option. If the SELECT button is pressed while you are in normal viewing, the channel banner will be displayed.

EXIT

Clears all on-screen displays and returns to normal viewing from any menu.

Resolution Indicator

Indicates output resolution.

Connection Indicator

Indicates output connection.

Standby Indicator

Lights when the HDTV Receiver is turned off.

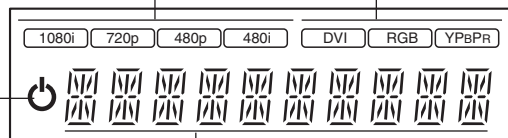

Character Indicators

Indicates channel number, volume level, etc.

Remote Control Key Functions

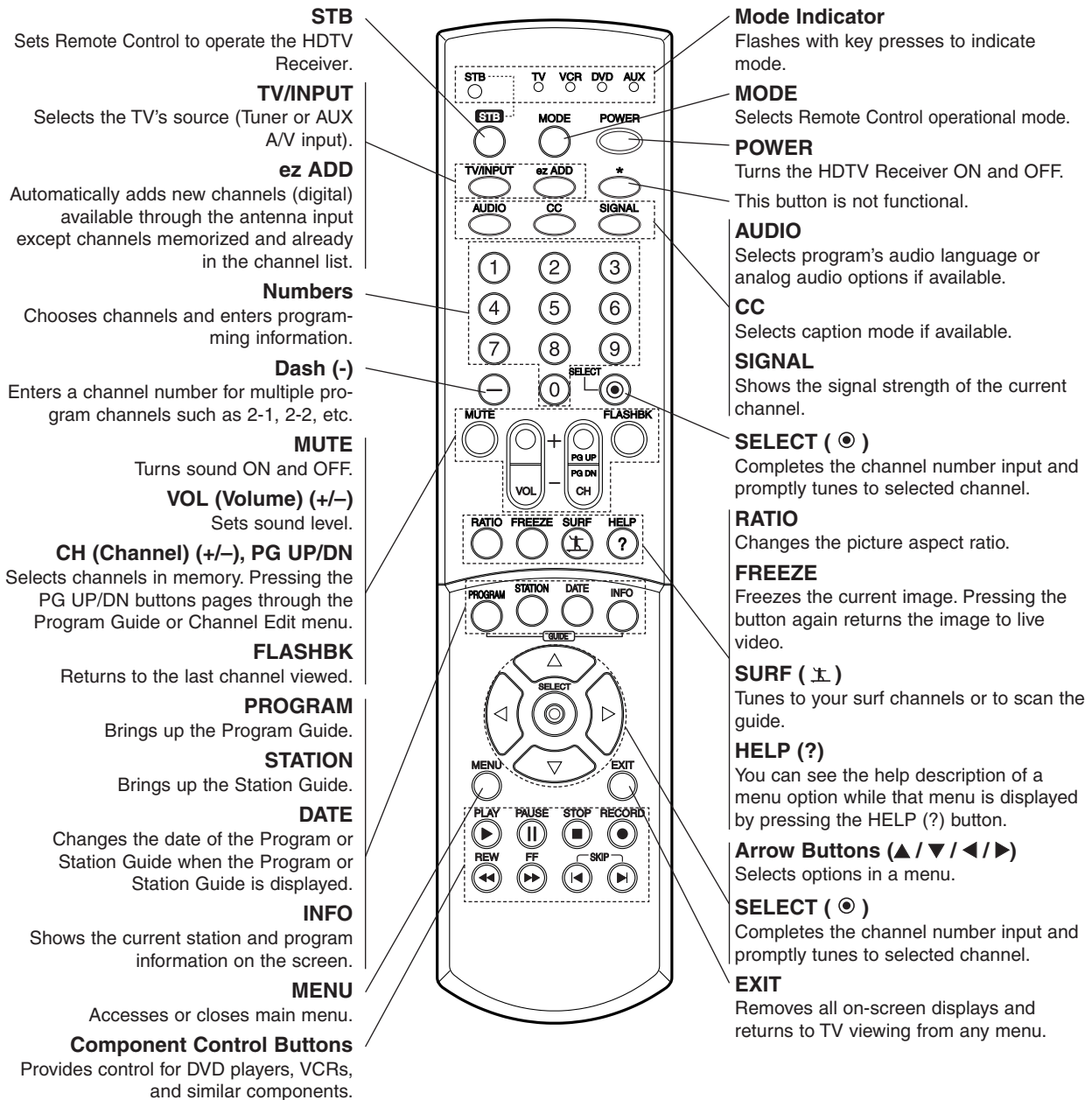

Remote Control Operation Range

Point the Remote Control at the remote sensor and press the buttons.

- **Distance:** About 23 ft (7 m) from the front of the remote sensor.
- **Angle:** About 30° in each direction of the front of the remote sensor.

Remote Control Battery Installation

Remove the battery cover on the rear of the Remote Control, and insert two batteries (size AA) with **+** and **-** matched correctly. Reinstall cover.

Caution

Do not mix old and new batteries. Never mix different types of batteries (standard, alkaline, etc.).

Unpacking HDTV Receiver and Accessories/Connection Overview

Make sure you have received all the accessories listed below with the High Definition Television Receiver.

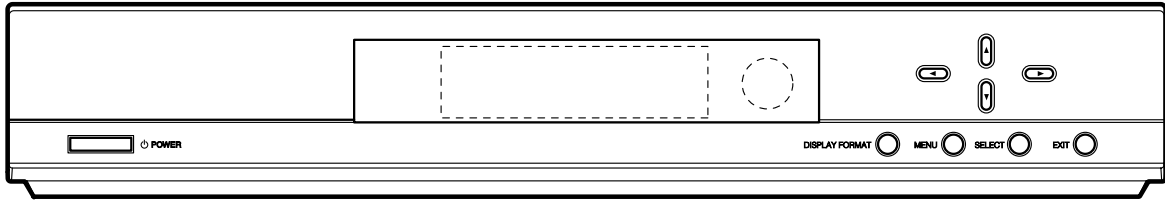

High Definition Television Receiver

The HDTV Receiver is capable of receiving signals from cable and/or over-the-air antenna sources and sending the signals to your TV/Monitor.

Included with the Receiver are the following accessories.

- | | |
|-------------------------|----------------|
| Audio Cable | Video Cable |
| Component (YPbPr) Cable | DVI Cable |
| RF Cable | Remote Control |
| 2 AA Batteries | |

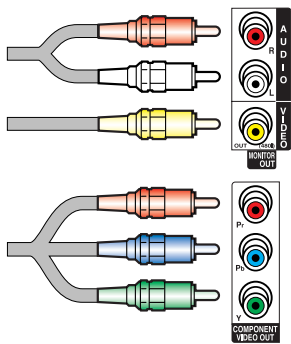

Audio/Video Jacks and Cables

The Audio/Video jacks provide excellent picture and sound quality. They are used for making most Audio/Video connections between A/V devices. The Audio/Video jacks may be color coded (yellow for video, red for right audio, and white for left audio). If an A/V device has only one input for audio (mono), connect it to the left (white L/mono) audio jack on the HDTV Receiver.

Component Out Jacks and Cables

Component Cables are used to connect the HDTV Receiver to an industry standard YPbPr compatible HD Monitor (green for Y, blue for Pb, and red for Pr). Since the YPbPr Component jacks carry only the picture and not the sound, remember to also connect the left and right audio cables.

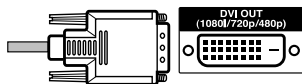

DVI-HDTV Cable

DVI cable is used to connect the HDTV Receiver to an industry standard DVI-HDTV compatible HD monitor. Remember to also connect the left and right audio cables. A DVI jack carries only the video signals, not the audio.

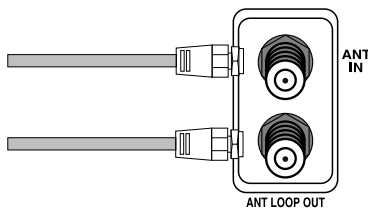

ANT LOOP OUT Jack, and RF Cable

ANT LOOP OUT provides an RF connection between the HDTV Receiver and the TV and provides the signal from the ANT IN jack to the TV/Monitor.

Remote Control

In addition to the HDTV Receiver, the Remote Control can be programmed to control many other devices.

Batteries

To install the batteries, slide open the battery compartment and insert the two AA batteries provided.

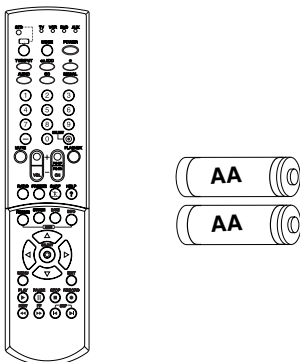

Connection Panel Overview

Note

Your HDTV Receiver can be connected to use a TV as the viewing device. Since the receiver has a built-in tuner, a monitor can be used instead for the viewing device.

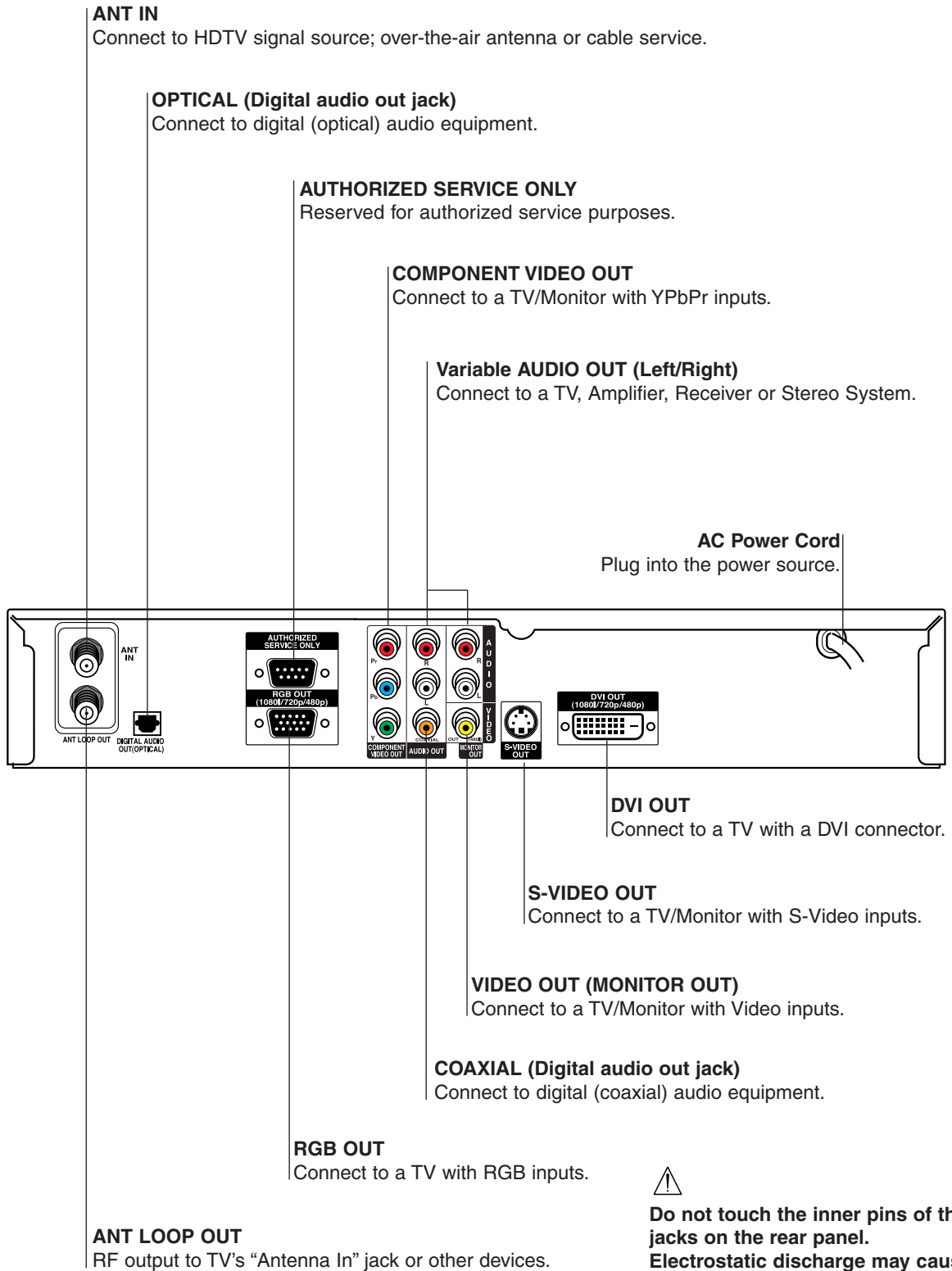

Do not touch the inner pins of the jacks on the rear panel. Electrostatic discharge may cause permanent damage to the unit.

Connections

Antenna Connections

- 1 Connect the “Antenna” to the “ANT IN” jack on the HDTV Receiver using a coaxial RF cable.

Note

There might be some areas where the signal strength could be too high. If so, you may need to connect the antenna to an attenuator. Screw the attenuator onto the “ANT IN” jack.

- 2 Connect the “ANT LOOP OUT” jack from the HDTV Receiver to the “Antenna In” jack on your TV using a coaxial RF cable.

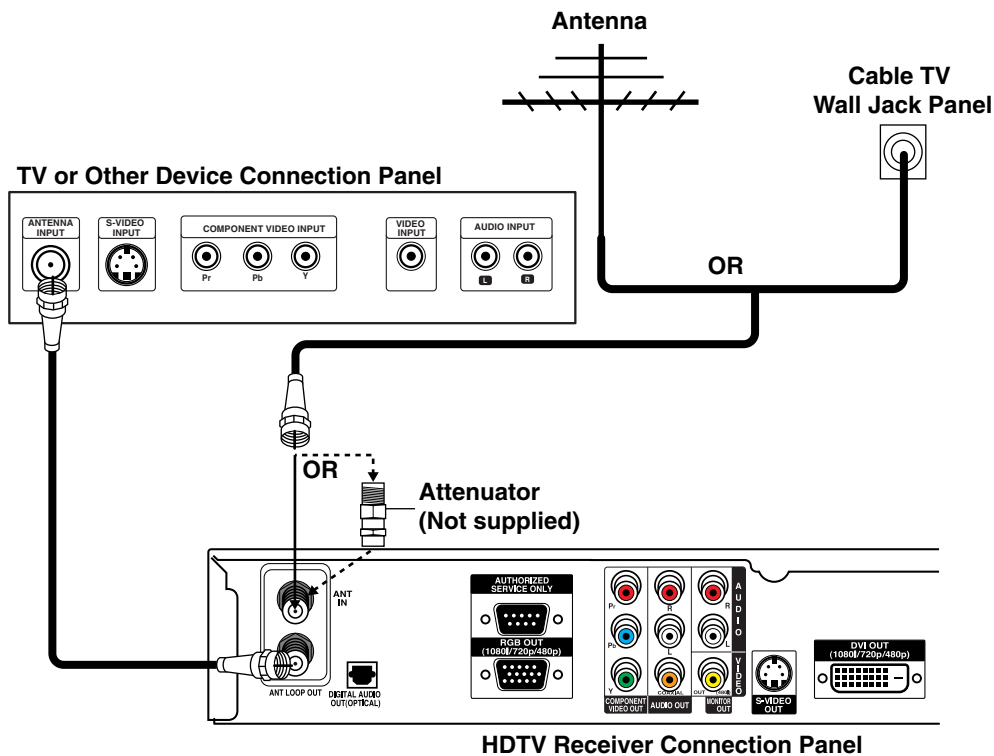

Tip

Before Connecting Your Antenna

During initial installation and setup of your HDTV Receiver, you may need to install a 10 dB attenuator to the Antenna input “ANT IN” on the LST-4200A. The LST-4200A is a high performance, high-gain system intended for operation under normal and weak signal conditions, providing the best reception with its optimum gain. However, there might be some reception areas where the signal strength is too high (e.g. due to close proximity to an undesirable signal or transmitter), so you need an attenuator that lowers the incoming signal strength (from the undesirable transmitter) to more normal levels. This 10 dB attenuator should be used only in a reception area where the undesired signal strength is too high.

Connections (Continued)

Display Formats Overview

- The HDTV Tuner offers various display formats and multiple video outputs. If the HDTV Tuner is connected to A/V systems, the HDTV Tuner can provide video signal formats 1080i, 720p, 480p, and 480i.
- 1080i, 720p, 480p, and 480i modes are available for component video (YPbPr) outputs.
- 1080i, 720p, and 480p modes are available for RGB and DVI outputs.
- 480i mode is available for VIDEO, S-VIDEO, and COMPONENT VIDEO outputs.
- The HDTV Tuner has two digital audio outputs; Dolby Digital 5.1 and PCM. The HDTV Tuner sends out a digital audio signal to OPTICAL and COAXIAL audio outputs if digital broadcasts are being received by the HDTV Tuner.

Analog Monitor Connections

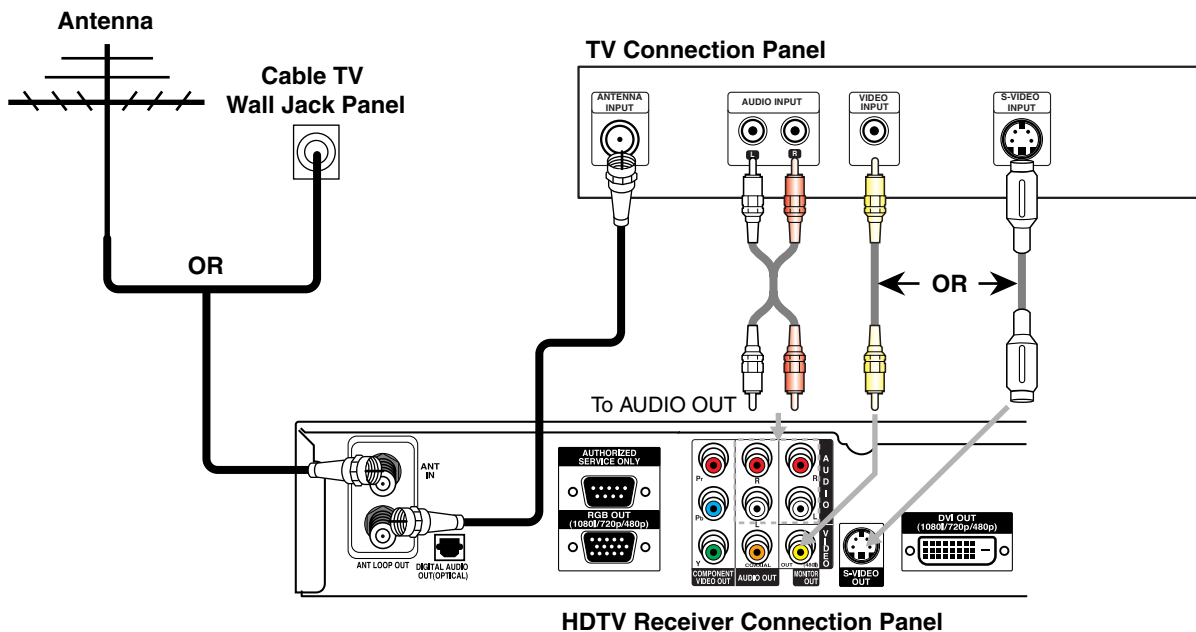

1 Connect the “Antenna/Cable” to the “ANT IN” jack on the HDTV Receiver using a coaxial RF cable.

Note

There might be some areas where the signal strength could be too high. If so, you may need to connect the antenna to an attenuator. Screw the attenuator onto the “ANT IN” jack. (Refer to page 10.)

2 Connect the “ANT LOOP OUT” jack from the HDTV Receiver to the “Antenna In” jack on your TV using a coaxial RF cable.

3 Connect the “AUDIO OUT” and “VIDEO OUT (MONITOR OUT)” jacks from the HDTV Receiver to the “A/V IN” jacks on your TV using RCA-type cables. If your TV is equipped with an S-Video jack, use the S-VIDEO OUT jack.

(The Output Selection must be set to YPbPr, refer to Display Format Setup on page 17.)

Note

On-Screen display and Menus are only seen on these connections if the display format settings are set to 480i and YPbPr. (Refer to page 17.)

Connections (Continued)

HD Monitor Component (YPbPr) Connections

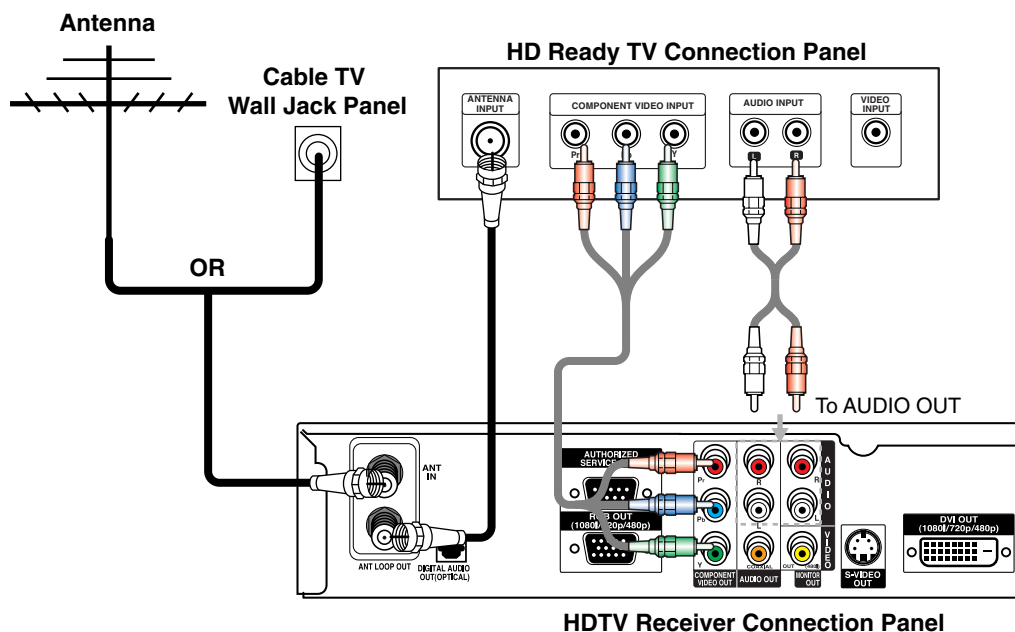

- 1 Connect the “Antenna/Cable” to the “ANT IN” jack on the HDTV Receiver using a coaxial RF cable.

Note

There might be some areas where the signal strength could be too high. If so, you may need to connect the antenna to an attenuator. Screw the attenuator onto the “ANT IN” jack. (Refer to page 10.)

- 2 Connect the “ANT LOOP OUT” jack from the HDTV Receiver to the “Antenna In” jack on your TV using a coaxial RF cable.
- 3 Connect the “COMPONENT OUT” jacks from the HDTV Receiver to the “COMPONENT IN” jacks on your TV using RCA-type cables. (The Output Selection must be set to YPbPr, refer to Display Format Setup on page 17.)
- 4 Connect the L/R “AUDIO OUT” jacks from the HDTV Receiver to the L/R “AUDIO IN” jacks on your TV using RCA-type cables.

Note

1080i, 720p, 480p, and 480i modes are available for component video (YPbPr) outputs.

Connections (Continued)

HD Monitor RGB Connections

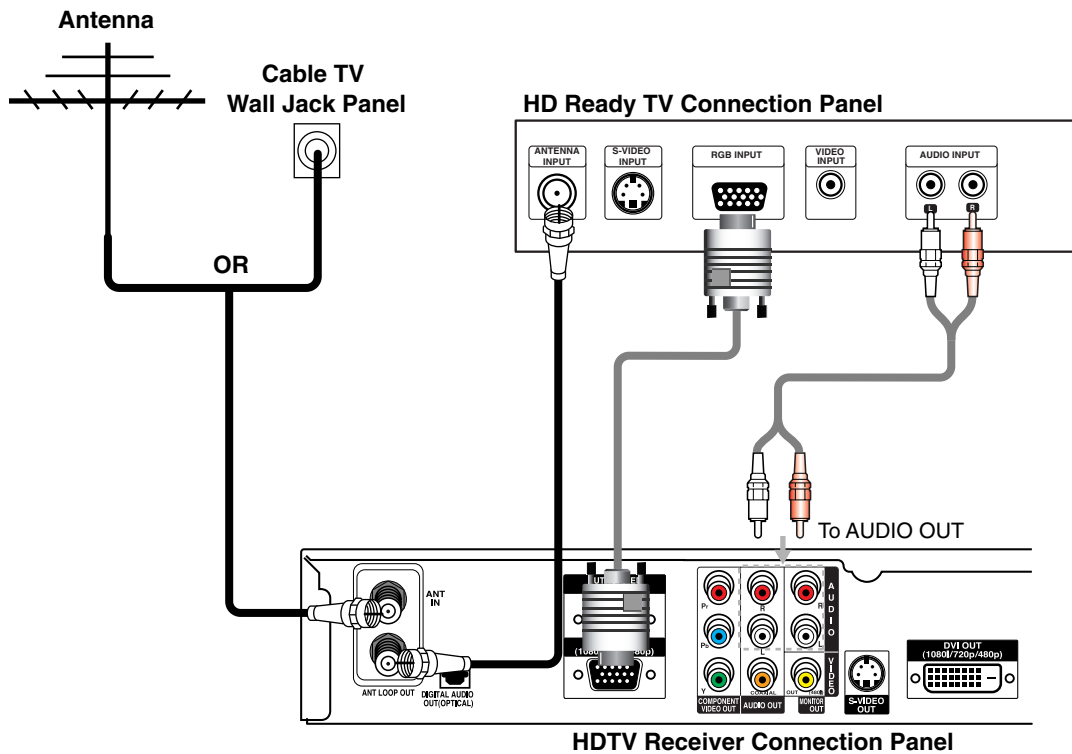

- 1 Connect the "Antenna/Cable" to the "ANT IN" jack on the HDTV Receiver using a coaxial RF cable.

Note

There might be some areas where the signal strength could be too high. If so, you may need to connect the antenna to an attenuator. Screw the attenuator onto the "ANT IN" jack. (Refer to page 10.)

- 2 Connect the "ANT LOOP OUT" jack from the HDTV Receiver to the "Antenna In" jack on your TV using a coaxial RF cable.

- 3 Connect the "RGB OUT" jack from the HDTV Receiver to the "RGB IN" jack on your TV using VGA-type connector. (The Output Selection must be set to RGB, refer to Display Format Setup on page 17.)

- 4 Connect the L/R "AUDIO OUT" jacks from the HDTV Receiver to the L/R "AUDIO IN" jacks on your TV using RCA-type cables.

Note

1080i, 720p, and 480p modes are available for RGB outputs.

Connections (Continued)

HD Monitor DVI-HDTV Connections

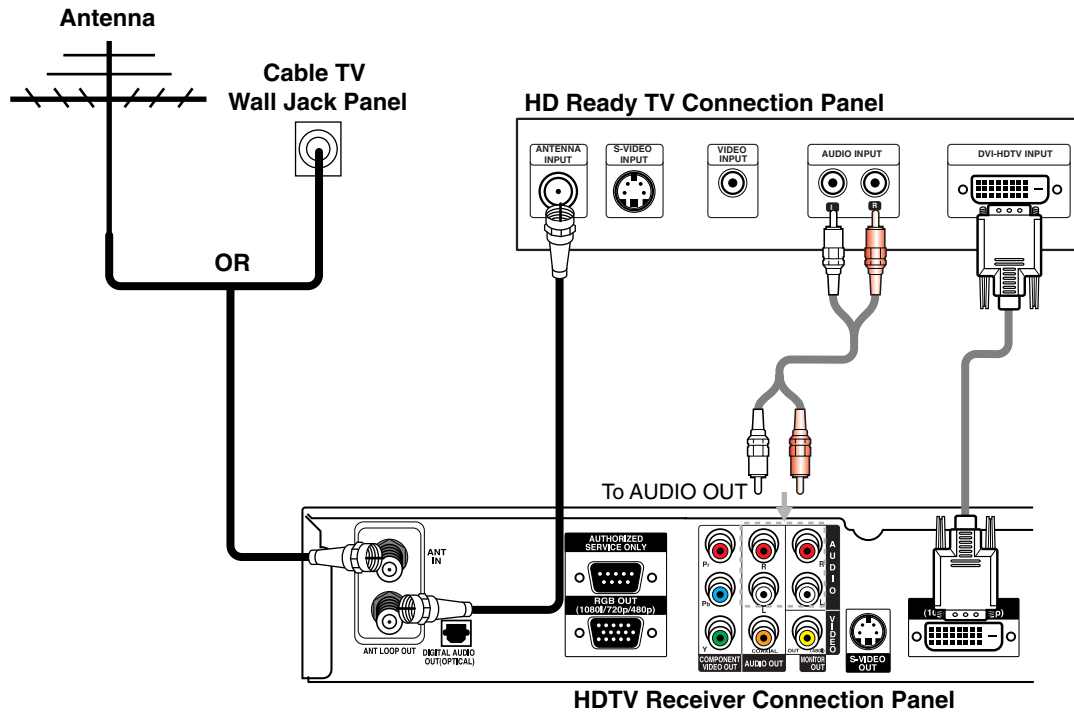

1 Connect the “Antenna/Cable” to the “ANT IN” jack on the HDTV Receiver using a coaxial RF cable.

Note

There might be some areas where the signal strength could be too high. If so, you may need to connect the antenna to an attenuator. Screw the attenuator onto the “ANT IN” jack. (Refer to page 10.)

2 Connect the “ANT LOOP OUT” jack from the HDTV Receiver to the “Antenna In” jack on your TV using a coaxial RF cable.

3 Connect the “DVI OUT” jack from the HDTV Receiver to the “DVI IN” jack on your TV using DVI-D type connector. (The Output Selection must be set to DVI, refer to Display Format Setup on page 17.)

4 Connect the L/R “AUDIO OUT” jacks from the HDTV Receiver to the L/R “AUDIO IN” jacks on your TV using RCA-type cables.

Note

- 1080i, 720p, and 480p modes are available for DVI outputs.
- A DVI-HDTV input is one that is compliant with EIA-861 and HDCP specifications. Check your TV or monitor's user manual to find out if the TV or monitor's DVI input is compliant with these specifications.
- Some HD Monitors designed for PC applications using DVI-D may not work with this connection.

Connections (Continued)

VCR Connections

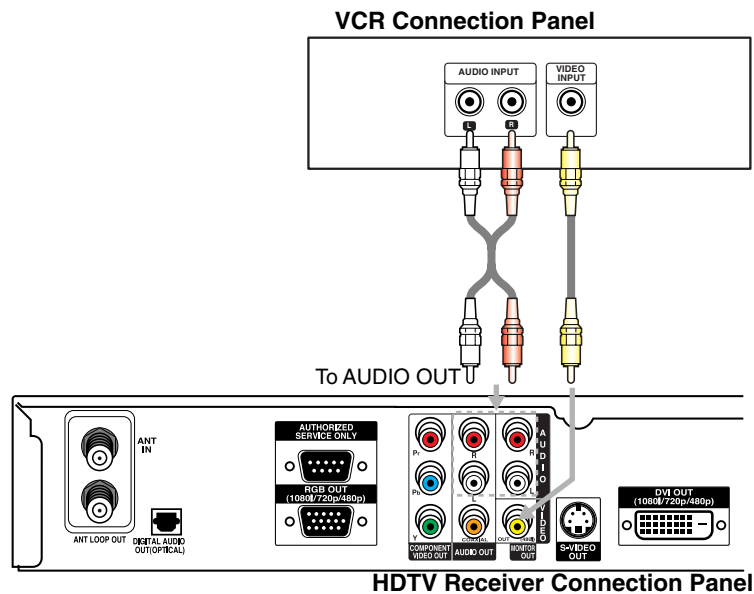

Connect the L/R “AUDIO OUT” jacks and “VIDEO OUT (MONITOR OUT)” jack from the HDTV Receiver to the “A/V in” jacks on your VCR using RCA-type cables. (If your VCR is equipped with an S-Video jack, use the “S-Video” jack instead.)



Caution

If 480i display format is selected, the VCR will record an onscreen display onto the tape during recording if:

- the channel is changed with CH (+/-)
- the sound level is adjusted with VOL (+/-)
or by pressing the SELECT button, etc.



Note

The caption signal is recorded if the display format settings are set to 480i and YPbPr. (Refer to page 17.)

Connections (Continued)

Audio Amplifier (Receiver) Connections

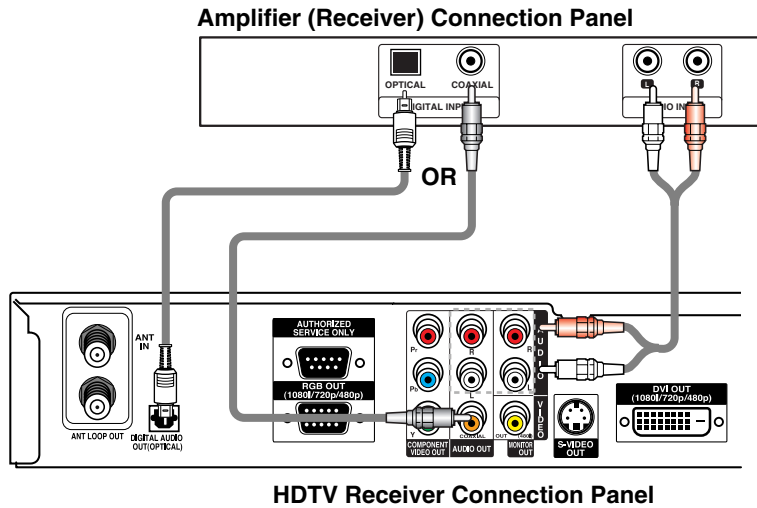

Connecting to an amplifier equipped with two-channel analog stereo or Dolby Surround

Connect the Left and Right AUDIO OUT jacks from the HDTV Receiver to the audio left and right in jacks on your Amplifier, Receiver, or Stereo System, using the supplied Audio Cables.

Connecting to an Amplifier equipped with two-channel digital stereo (PCM) or to an Audio/ Video Receiver equipped with a multi-channel decoder (Dolby Digital™)

Connect one of the HDTV Receiver's DIGITAL AUDIO OUT jacks (OPTICAL or COAXIAL) to the corresponding input jack on your Amplifier. Use an optional digital (optical or coaxial) audio cable.

Digital Multi-channel sound

A digital multi-channel connection provides the best sound quality. For this, you need a multi-channel Audio/Video Receiver that supports one or more of the audio formats supported by your HDTV Receiver (Dolby Digital). Check the Receiver's Manual and the logos on the front of the Receiver.

Display Format Setup

The HDTV Receiver provides several display formats. The DISPLAY FORMAT button on the front panel changes the output connector and resolution. The output resolution may be converted from the original broadcast format.

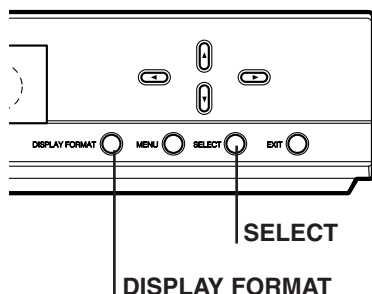

Display Format Setup

- 1** Press **DISPLAY FORMAT** once on the front panel.
The current output signal will appear in the display window.
- 2** Depending on the type of Monitor that the HDTV Receiver is connected to, press **DISPLAY FORMAT** or **◀/▶** repeatedly on the front panel to select desired output connector. (YPbPr, RGB, or DVI.)
Press **MENU** button if you wish to exit the display format setting.
- 3** Use **SELECT** on the front panel to confirm your output connector selection.
The current output resolution will appear in the display window.
- 4** Depending on the type of Monitor that the HDTV Receiver is connected to, press **DISPLAY FORMAT** or **◀/▶** repeatedly on the front panel to select desired output resolution. (1080i, 720p, 480p, 480i, native, variable 1, variable 2, or variable 3.)
Press **MENU** button if you wish to return to the output connector setting mode.
- 5** Press **SELECT** on the front panel your output connector selection.
Display Format setup is finished.

Note

You can exit Display Format Setup mode by pressing **EXIT** on the front panel.

Display Format modes	Input Signal format	Output Signal format
1080i	all formats	1080i
720p	all formats	720p
480p	all formats	480p
480i	all formats	480i
native	1080i	1080i
	720p	720p
	480p	480p
	480i	480i (YPbPr), 480p (RGB, DVI)
variable 1	1080i	1080i
	720p	720p
	480p/480i	480p
variable 2	1080i/720p	1080i
	480p/480i	480p
variable 3	1080i/720p	720p
	480p/480i	480p

OUTPUT CONNECTION	AVAILABLE FORMATS
COMPONENT VIDEO OUT	1080i/720p/480p/480i/native/variable 1/variable 2/variable 3
RGB OUT	1080i/720p/480p/native/variable 1/variable 2/variable 3
DVI OUT	1080i/720p/480p/native/variable 1/variable 2/variable 3
VIDEO OUT (MONITOR OUT)	All formats converted to 480i
S-VIDEO OUT	All formats converted to 480i

Menu Overview

In this menu system, there are several ways to customize the menu settings provided. Most menus consist of three levels to set up the options, but some require greater depth for the variety of settings. If you press the MENU button, only the first and second level of the menu system will appear on the TV screen. The third level can be displayed by pressing **⊙** (SELECT). If a menu has more than three levels, the pop-up dialogue box will be displayed as the fourth or fifth level. For navigating the menu levels, you will see “▶” on the right side of the menu label to help you go to the next level.

To show and remove the Menu:

Press the MENU button on the Remote Control to display the menu. A second press of the MENU button or a press of the EXIT button will take you back to TV viewing.

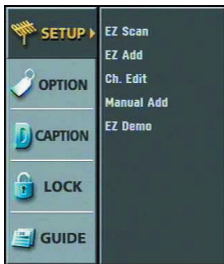

To go to the next level:

Press “⊙” (or “▶”) on the Remote Control.

To go back to the previous level:

Press MENU (or “◀”) on the Remote Control.

Typical Menu Operation

- 1 Press MENU.**
The main menu will appear.
- 2 Use ▲ / ▼ to select the desired menu option.**
- 3 While the desired menu option is selected, press ▶ or ⊙ (SELECT) to move to the second level.**
- 4 Use ▲ / ▼ to select the second menu option.**
- 5 Press ▶ or ⊙ (SELECT) to move to the third level.**
Some menu options require additional steps.
- 6 Press MENU to return to the previous menu or press EXIT on the Remote Control to return to TV viewing.**

Help Function

The Help feature is designed to let you understand each function of the Menu in an easy and convenient way. As you navigate through the Menu, press **HELP (?)** button on your Remote Control if you want information about the highlighted option. The information will be displayed on the right side of the highlighted option.

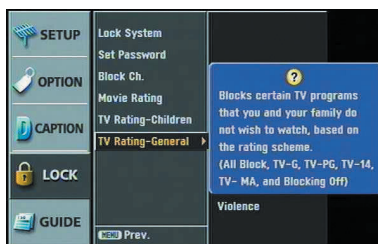
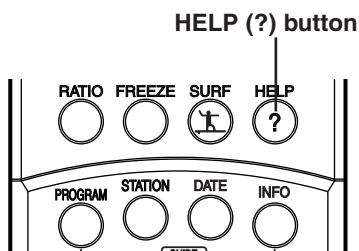

Setup Menu Options

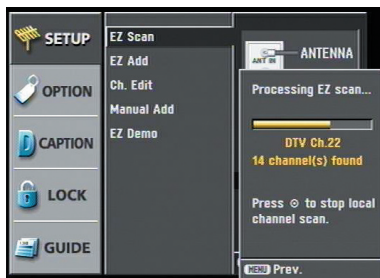
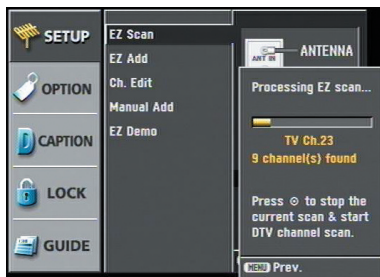
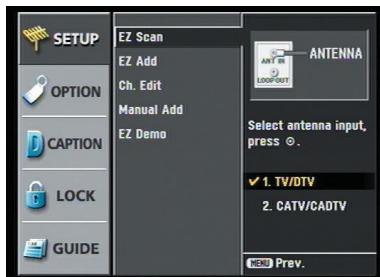
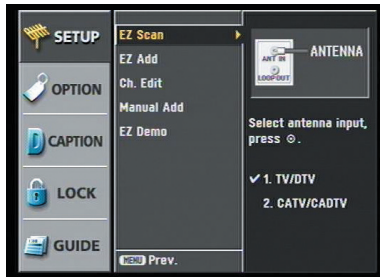

ez ADD button

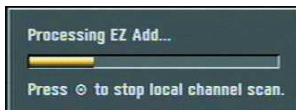
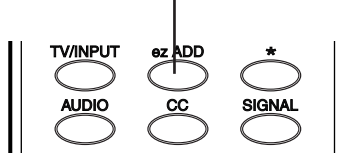

EZ Scan (Channel Search)

Automatically finds all channels (analog and digital) available through the 'ANT IN' source. The unit stores all the active channels found, on the channel list. Inactive or weak channels may not appear on the list. In that case, add missing channels manually with the Manual Add menu. The channel list created here can be seen in the Ch. Edit menu.

- 1** Press MENU to display the on-screen menu.
- 2** Select the SETUP menu using ▲ / ▼ then press Ⓞ (SELECT) or ► to move to the second level.
- 3** Select the EZ Scan using ▲ / ▼ then press Ⓞ (SELECT) or ►.
- 4** Select the signal source (TV/DTV or CATV/CADTV).
TV/DTV is for over-the-air antenna reception.
CATV/CADTV is for cable subscribers.

Notes

- If you have already scanned channels, the menu will ask, "Do you really want to re-scan Antenna/Cable Channels?". Select "Yes" to re-scan channels or select "No" to scan channels except current source (antenna or cable), then press Ⓞ (SELECT).
- Some scrambled channels may not be stored.

- 5** Press Ⓞ (SELECT).
The channel search process begins.
You can skip the current scanning by pressing Ⓞ (SELECT).
You can stop the process by pressing MENU or EXIT.
- 6** After the channel search is complete, the lowest channel number found appears on the TV screen.

EZ Add

Automatically adds new channels available through the antenna input (ANT IN) except memorized channels already in the channel list.

- 1** Press MENU to display the on-screen menu.
- 2** Select the SETUP menu using ▲ / ▼ then press Ⓞ (SELECT) or ► to move to the second level.
- 3** Select EZ Add using ▲ / ▼ then press Ⓞ (SELECT) or ►.
EZ Add channel search process begins.
You can skip the current scanning by pressing Ⓞ (SELECT).
You can stop the process by pressing MENU or EXIT.
- 4** After EZ Add channel search is complete, the lowest channel number found appears on the TV screen.

Tip

You can also start EZ Add channel search by pressing ez ADD then Ⓞ (SELECT) button on the Remote Control.

Setup Menu Options (Continued)

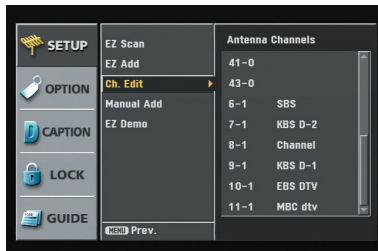

Ch. Edit (Channel Edit)

Channel Edit allows you to manually add or delete channels from the channel list in memory and create your own surf list of favorite channels. Press SURF ($\underline{\text{S}}$) on the Remote Control when a channel is highlighted.

- 1** Press MENU to display the on-screen menu.
- 2** Select the SETUP menu using \blacktriangle / \blacktriangledown then press \odot (SELECT) or \blacktriangleright to move to the second level.
- 3** Select the Ch. Edit using \blacktriangle / \blacktriangledown then press \odot (SELECT) or \blacktriangleright . Channel Edit menu appears.

To move one by one:

Use \blacktriangle / \blacktriangledown to move one step on the channel-editing menu.

To move page by page:

Use PG UP or PG DN button to move to the next or previous page on the channel editing menu.

To add or delete a channel:

Press \odot (SELECT) to add or delete the channel on the channel editing menu.

To create a Surf Channel list:

Press SURF ($\underline{\text{S}}$) to add the channel as a Surf channel.

- 4** Press MENU to return to the previous menu or press EXIT on the Remote Control to return to TV viewing.

Note

Deleted channels can not be selected with the CH (+/-) buttons.

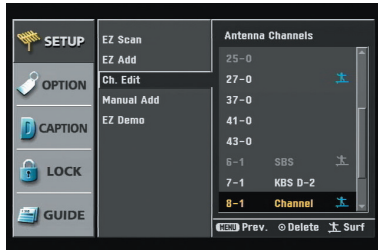
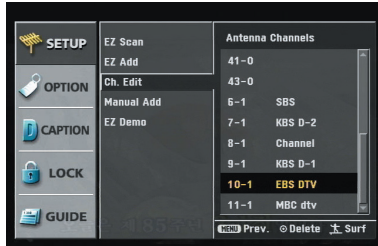

Setup Menu Options (Continued)

Manual Channel Add/Delete

This feature manually adds or deletes channels.

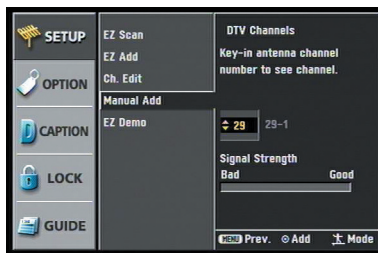
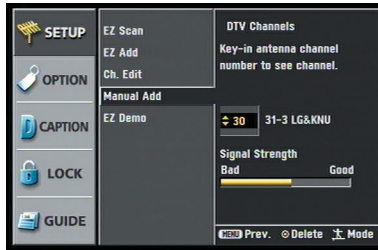

- 1** Press MENU to display the on-screen menu.
- 2** Select the SETUP menu using ▲ / ▼ then press Ⓞ (SELECT) or ► to move to the second level.
- 3** Select the Manual Add option using ▲ / ▼ then press Ⓞ (SELECT) or ►.
Manual Add menu appears.
- 4** You can toggle between DTV and TV channels by pressing SURF (↔) repeatedly.
- 5** Select a channel to add or delete using ▲ / ▼ or the numbered buttons.
- 6** Press Ⓞ (SELECT) to confirm your selection.
- 7** Repeat steps 4-6 to add or delete additional channels with the Manual Add menu.
- 8** Press MENU to return to the previous menu or press EXIT on the Remote Control to return to TV viewing.

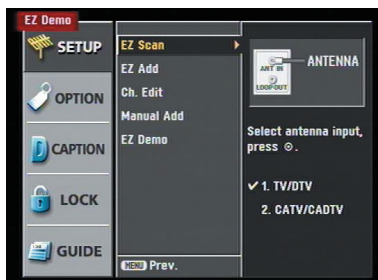
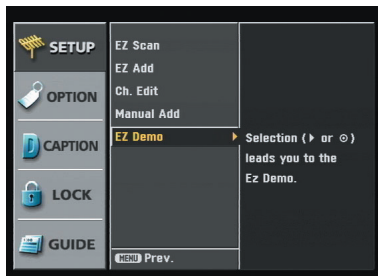

EZ Demo

Shows you how to navigate through the on-screen menus available on the HDTV Receiver.

- 1** Press MENU to display the on-screen menu.
- 2** Select the SETUP menu using ▲ / ▼ then press Ⓞ (SELECT) or ► to move to the second level.
- 3** Select EZ Demo using ▲ / ▼ then press Ⓞ (SELECT) or ► to start EZ Demo.
- 4** Press any button on the Remote Control to return to TV viewing.

Option Menu Features

Clock

Enables the user to set up the clock information. Normally, your clock is set using signals transmitted by DTV stations. Choosing your time zone sets the current time automatically. But if the Ant In jack on the connection panel is connected to a cable service, you must set the clock manually.

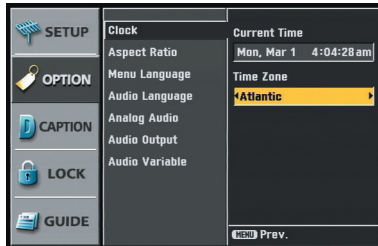

Clock Setup for over-the-air antenna reception.

- 1** Press MENU to display the on-screen menu.
- 2** Select the OPTION menu using ▲ / ▼ then press Ⓞ (SELECT) or ►.
- 3** Use ▲ / ▼ to select the Clock option then press ► or Ⓞ (SELECT) to move to the third level.
- 4** Use ◀ / ▶ to set Time Zone: (New F.land, Atlantic, Eastern, Central, Mountain, Pacific, Alaska, Hawaii)
- 5** Press MENU to return to the previous menu or press EXIT on the Remote Control to return to TV viewing.

Note

There are cases where the TV station does not send, or sends wrong date and/or time information causing the HDTV Receiver to set an incorrect time.

Clock Setup for CATV/CADTV service.

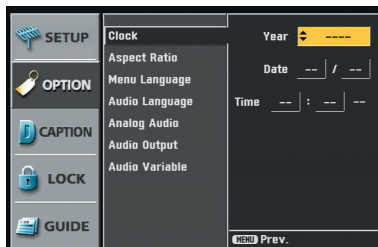

Note

You cannot manually set the clock using the TV/DTV band.

- 1** Press MENU to display the on-screen menu.
- 2** Select the OPTION menu using ▲ / ▼ then press Ⓞ (SELECT) or ►.
- 3** Use ▲ / ▼ to select the Clock option then press ► or Ⓞ (SELECT) to move to the third level.
- 4** Use ▲ / ▼ to set Year, then press ► to move to the next option.
- 5** Set the Year, Date and Time using ▲, ▼, and ► buttons then press Ⓞ (SELECT) to confirm your changes.
- 6** Press MENU or ◀ to return to the previous menu or press EXIT on the Remote Control to return to TV viewing.

Option Menu Features (Continued)

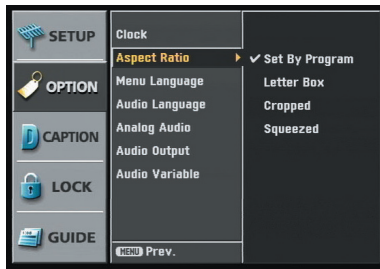

Options to view a picture with a wide (16:9) aspect ratio at 480i or 480p mode output format.



Options to view a picture with a normal (4:3) aspect ratio at 720p or 1080i mode output format.

RATIO button

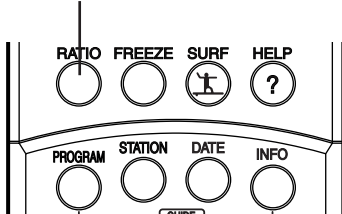

Adjustable Cinema Zoom mode
Use to adjust zooming. The picture will be enlarged to appear like a cinema screen.

Aspect Ratio

Selects the screen format. To view a picture with a wide (16:9) aspect ratio at 480i or 480p mode output format, you can choose Letter Box, Cropped, or Squeezed. To view a picture with a normal (4:3) aspect ratio at 720p or 1080i mode output format, you can choose Normal, Wide, Horizon, Zoom, or Cinema Zoom.

- 1** Press **MENU**.
The main menu appears.
- 2** Use **▲ / ▼** to select the **OPTION** menu then press **▶** or **⊙** (**SELECT**) to move to the second level.
- 3** Use **▲ / ▼** to select the **Aspect Ratio** option.
- 4** Press **▶** or **⊙** (**SELECT**) to move to the third level.
- 5** Use **▲ / ▼** to select an option then press **⊙** (**SELECT**) to confirm your selection.
- 6** Press **MENU** to return to the previous menu or press **EXIT** on the Remote Control to return to TV viewing.



Letter Box Cropped Squeezed



Normal Wide Horizon Zoom Cinema Zoom

Notes

- If the program format is High Definition (16:9) and the display format selected is 1080i or 720p, the Aspect Ratio is set to Wide .
- If the program format is Standard Definition (4:3) and the display format selected is 480p or 480i, the Aspect Ratio is set to Squeezed.

Tip

While watching TV, you can change the picture aspect ratio using **RATIO** on the Remote Control. To view a high definition picture with 480i or 480p format setting, use the **RATIO** button on the Remote Control to change the wide mode in the following cycle: Letterbox, Cropped, to Squeezed.

To view a standard definition picture with 720p or 1080i format setting, use the **RATIO** button on the Remote Control to change the wide mode in the following cycle: Normal, Wide, Horizon, Zoom, to Cinema Zoom. (Refer to Choosing the Aspect Ratio on next page).

Option Menu Features (Continued)

Use the **RATIO** button to choose Aspect Ratios

Aspect Ratio Descriptions

Aspect Ratios available for viewing high definition content (16:9) if output format is 480i or 480p Mode:

Letter Box

Use for a picture with an original 16:9 aspect ratio (in a wide format). Letterbox mode will shrink the picture to fill the screen, with black/gray (or blank) bars appearing at the top and bottom of the screen.

Cropped

Use for a picture filling the entire screen by cropping (removing) the left and right portions of the picture.

Squeezed

Use for a full picture filling the entire screen with no black/gray bars. The picture in a 16:9 format will be horizontally adjusted or squeezed to fit the 4:3 ratio Monitor. This setting can also be useful when used with 16:9 aspect ratio monitors or with 4:3 aspect ratio Monitors that have a "16:9 enhancement" feature.

Aspect Ratios available for viewing standard definition content (4:3) if output format is 720p or 1080i Mode:

Normal

Use for a picture with an original 4:3 aspect ratio on your 16:9 Monitor, with black/gray bars appearing at the left and right sides.

Wide

Use for a picture adjusted horizontally (in a linear proportion) to fill the entire screen.

Horizon

Use to adjust a picture in a non-linear proportion (more at both sides) to create a spectacular view.

Zoom

Use when you want to fill the entire screen with no black/gray bars appearing. The image will be altered both horizontally (stretched) and vertically (cropped). The top and bottom portions of the picture will be removed.

Cinema Zoom (Adjustable)

Use to adjust zooming (1-16). The picture will be enlarged like a cinema screen.

Aspect Ratios available for temporarily viewing high definition content (16:9) when output format is 720p or 1080i Mode:

Standard

Choose when you want to view a picture with no adjustment.

Expand

Choose when you want to view a picture in the 16:9 ratio size. The picture will be horizontally adjusted or extended to fit 16:9 ratio. Left and right portions of the picture will not be shown.

Shrink

Choose when you want to view a picture in the 4:3 ratio size. The picture will be horizontally adjusted or squeezed to fit 4:3 ratio. Black or gray bars will show at the left and right side.

Aspect Ratio Summary

Program Format	Output Format	Available Aspect Ratios
HD (720p/1080i) 16:9	HD (720p/1080i) 16:9	Three temporary Aspect Ratio controls (Standard, Expanded, Shrink)
HD (720p/1080i) 16:9	SD (480i/p) 4:3	Letter Box, Cropped, Squeezed
SD (480i/p) 4:3	HD (720p/1080i) 16:9	Five Aspect Ratio controls (Normal, Wide, Horizon, Zoom, Cinema Zoom)
SD (480i/p) 4:3	SD (480i/p) 4:3	No Adjustment Options

Option Menu Features (Continued)



Menu Language

Select a language for the menus to appear in.

- 1** Press **MENU** to display the on-screen menu.
- 2** Select the **OPTION** menu using **▲ / ▼** then press **⊙** (SELECT) or **▶**.
- 3** Select the **Menu Language** option using **▲ / ▼** then press **⊙** (SELECT) or **▶**.
- 4** Select the desired language using **▲ / ▼** then press **⊙** (SELECT).
- 5** Press **MENU** to return to the previous menu or press **EXIT** on the Remote Control to return to TV viewing.



Audio Language

Digital channels sometimes provide multiple audio tracks, often in a different language. You can set a default audio language with the Audio Language menu.

- 1** Follow Steps 1-2 as described above for (Menu Language).
- 2** Select the **Audio Language** option using **▲ / ▼** then press **⊙** (SELECT) or **▶**.
- 3** Select the desired language using **▲ / ▼** then press **⊙** (SELECT).
- 4** Press **MENU** to return to the previous menu or press **EXIT** on the Remote Control to return to TV viewing.

Tip

- If provided by the broadcaster, you can also select a different audio language while viewing TV by pressing **AUDIO** repeatedly.
- If multiple audio tracks are available, the audio icon (Ⓜ) appears on the program information display or Program guide. You can select one of the other languages with the **AUDIO** button.

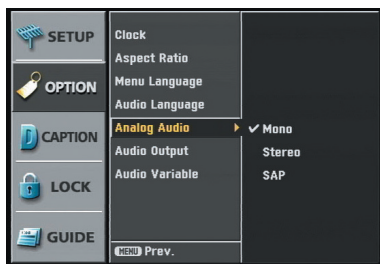

Analog Audio

Chooses the default audio mode when a program is broadcast in analog format. If you view a program broadcast in mono, you will hear only mono sound, even though Stereo mode is set. If Second Audio Program "SAP" mode is set, the program's second audio program is broadcast in mono, if provided.

- 1** Follow Steps 1-2 as described above for (Menu Language).
- 2** Select the desired mode using **▲ / ▼** then press **⊙** (SELECT).
- 3** Press **MENU** to return to the previous menu or press **EXIT** on the Remote Control to return to TV viewing.

Tip

If provided by the broadcaster, you can also select a different audio mode while viewing TV by pressing **AUDIO** repeatedly.

AUDIO button

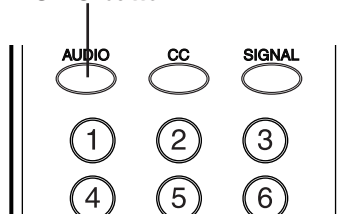

Option Menu Features (Continued)

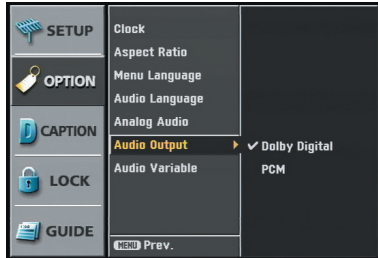

Audio Output

Sets the HDTV Receiver's Digital Audio Output according to the type of audio system you use.

Note

Audio Output setting is available only for digital broadcast, an analog broadcast is output only in PCM.

- 1 Press MENU to display the on-screen menu.
- 2 Select the OPTION menu using ▲ / ▼ then press Ⓞ (SELECT) or ►.
- 3 Select the Audio Output option using ▲ / ▼ then press Ⓞ (SELECT) or ►.
- 4 Select the desired audio output using ▲ / ▼ then press Ⓞ (SELECT).

Dolby Digital: Select "Dolby Digital" if you connected the HDTV Receiver's DIGITAL OUT jack to a Dolby Digital Decoder (or an Amplifier or other equipment with a Dolby Digital Decoder).

PCM: Select if the HDTV Receiver's DIGITAL OUT jack is connected to a 2-channel Digital Stereo Amplifier.

- 5 Press MENU to return to the previous menu or press EXIT on the Remote Control to return to TV viewing.

Audio Variable

If the audio variable menu is set to On, audio volume can be increased/decreased by pressing VOL (+/-) on the Remote Control or ◀/▶ on the front panel. If set to Off, audio volume can not be controlled by the HDTV receiver.



- 1 Follow Steps 1-2 as above (Audio Output).
- 2 Select Audio Variable using ▲ / ▼ then press Ⓞ (SELECT) or ►.
- 3 Select an Audio Variable option (On or Off) using ▲ / ▼ then press Ⓞ (SELECT).
- 4 Press MENU to return to the previous menu or press EXIT on the Remote Control to return to TV viewing.

Note

Before setting Audio Variable to Off, make sure that you have turned down the TV's volume to the minimum. Otherwise, sudden high volume sound may cause hearing or speaker damage.

Caption Menu Options



DTV Captions

Selects a default Caption language.

The caption language options are English, French, and Spanish. Use the menu to select a language. If the selected language is not available on the current program, the caption language for the program is not displayed.

Options are:

Off: DTV Caption is not displayed.

English: English is selected for DTV captions.

French: French is selected for DTV captions.

Spanish: Spanish is selected for DTV captions.

Notes

- DTV Caption (Standard EIA /CEA 708) will appear only if provided by the broadcaster.
- If DTV and Analog Captions are received simultaneously, you can only select DTV Caption.

Tip

- If available, you can also select a caption language while viewing TV, press **CC** repeatedly.
- If captions are available, the DTV caption icon (**CC**) appears on the program information display, Program Guide, or Station Guide to indicate that you can select one of those caption options with the CC button. The caption icon will not appear on the program information display or Program Guide for analog caption.

Caption Menu Options (Continued)

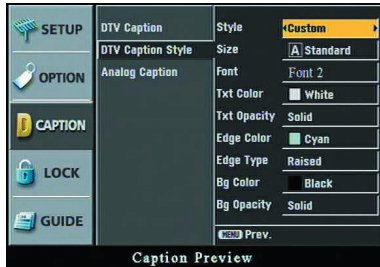

DTV Caption Style

Selects DTV Captions appearance menu options.

Style

Use caption feature defaults as provided by the program or customize caption appearance with the Custom menu options.

Set By Program: Default text provided by a broadcaster is shown when captions appear.

Custom: Customized text is shown when captions appear.

Size

Selects the font size for captions.

Standard: The standard text size is used for the caption display (15 pixels).

Large: The large text size is used for the caption display (21 pixels).

Small: The small text size is used for the caption display (11 pixels).

Font

Selects the font type for captions.

Txt. (Text) Color

Selects the font color for captions.

Txt. (Text) Opacity

Selects the font opacity for captions.

Solid: The text is solid (without any transparency).

Flash: The text blinks twice a second.

Translucent: The text is translucent.

Transparent: The text is transparent (In this case, whatever the color is, the color does not affect the captions display).

Edge Color

Selects the edge color for captions (If the edge type is selected as None, the edge color does not have any effect on the captions display).

Edge Type

Selects the edge type for captions.

None: The text has no edge.

Raised: The text is raised.

Depressed: The text is depressed.

Uniform: The text has a uniform edge.

Left Shadow: The text has a left-shadow edge.

Right Shadow: The text has a right-shadow edge.

Bg. (Background) Color

Selects the background color for captions.

Bg. (Background) Opacity

Selects the background opacity for captions.

Solid: The text background color is solid (without any transparency).

Flash: The text background color blinks twice a second.

Translucent: The text background color is translucent.

Transparent: The text background color is transparent (In this case, whatever the background color is, the color does not affect the captions.).

Caption Menu Options (Continued)

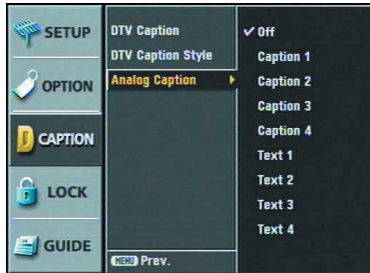

Analog Captions

Allows you to select a mode for displaying Analog Caption Data. In the Analog Caption Service, Caption 1-4 display program's dialog, and Text 1-4 display data service information.

Note

Analog Captions will appear if they are provided by the broadcaster.

Off

Analog Caption is not displayed.

Caption 1

Caption 1 is the primary caption service that synchronizes the captioning language with the sound, used by most broadcasters. Captioning is displayed in the same language as the program's dialog.

Caption 2

Caption 2 is the special non-synchronous caption service that does not need to be in sync with the sound and may provide simplified captioning, which is usually delayed.

Caption 3

Caption 3 serves as an alternate captioning service channel. Captioning is often a secondary language translation such as French, Spanish, simplified English or displayed at a slower rate.

Caption 4

Caption 4 is another special non-synchronous caption service that does not need to be in sync with the sound and may provide simplified captioning, usually delayed.

Text 1 - 4

Text 1-4 usually displays information on the lower portion of the screen and is used for a data service, generally not program related.

Tip

If available, press **CC** repeatedly to select a caption language while viewing TV.

Note

If DTV and Analog Caption are received simultaneously, you can only select DTV Captions, analog captions will not appear.

Lock (Parental Control) Menu Options

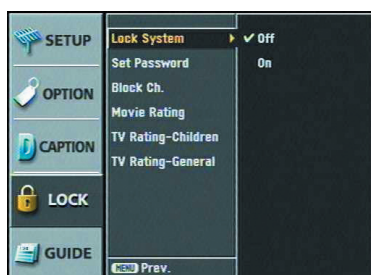

Lock System

Allows you to set up specific channels and ratings through blocking schemes. Also allows you to activate or disable all of the lock schemes previously set up. A password is required to gain access to the LOCK menus. If the Lock System is set to Off, the Channel and Program Ratings are not functional.

- 1 Press MENU.**
The main menu appears.
- 2 Use ▲ / ▼ to select the LOCK then press ► or ● (SELECT) to move to the second level.**
If you have not entered a password yet;
Key-in the "0000" password using the numbered buttons to create a personal 4-digit security password.
If you have already entered a password;
Key-in the 4-digit password using the numbered buttons to confirm the personal 4-digit security password.
- 3 Use ▲ / ▼ to select the Lock System option.**
- 4 Press ► or ● (SELECT) to move to the third level.**
- 5 Use ▲ / ▼ to select an option (On or Off) then press ● (SELECT) to confirm your selection.**
- 6 Press MENU to return to the previous menu or press EXIT on the Remote Control to return to TV viewing.**

Set Password

Changes the password.



- 1 Follow steps 1-2 as shown above (Lock System).**
- 2 Use ▲ / ▼ to select the Set Password option.**
- 3 Press ► or ● (SELECT) to move to the third level.**
- 4 Enter the new 4-digit password.**
- 5 Enter the same password again.**
- 6 Press MENU to return to the previous menu or press EXIT on the Remote Control to return to TV viewing.**

Lock (Parental Control) Menu Options (Continued)

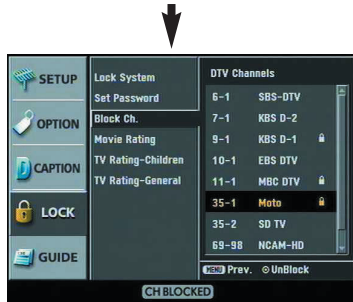
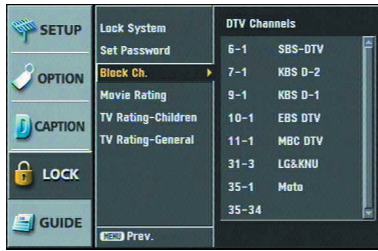

Block Ch. (Channel)

Blocks any channel that you do not want to view or that you do not want your children to watch. If you tune in a blocked channel, a black screen with a pop-up box will appear. Block Ch can override Channel Edit menu settings (see page 20).

- 1 Press MENU.**
The main menu appears.
- 2 Use ▲ / ▼ to select the LOCK then press ► or Ⓞ (SELECT) to move to the second level.**

If you have not entered a password yet;

Key-in the "0000" password using the numbered buttons to create a personal 4-digit security password.

If you have already entered a password;

Key-in the 4-digit password using the numbered buttons to confirm the personal 4-digit security password.

- 3 Use ▲ / ▼ to select the Block Ch. (channel).**
The channel list menu appears.

To move one-by-one:

Use ▲ / ▼ to move by one step on the block channel menu.

To move page-by-page:

Use PG UP or PG DN button to move to the next or previous page on the block channel menu.

To lock or unlock a channel:

Use Ⓞ (SELECT) to block or unblock the channel on the block channel menu.

The 🔒 mark will appear to the right of the station name to indicate the blocked channel.

- 4 Repeat step 2 to block or unblock additional channels on the channel list menu.**
- 5 Press MENU to return to the previous menu or press EXIT on the Remote Control to return to TV viewing.**

Lock (Parental Control) Menu Options (Continued)

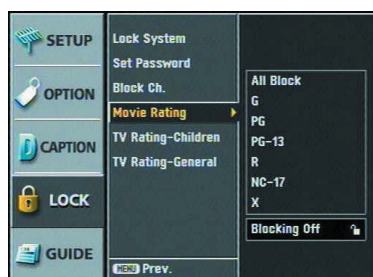

Movie Rating

Blocks movies according to the movie ratings restrictions so children cannot view certain movies. You can set the ratings to block out all the movies with ratings above a specified level. Keep in mind that the movie ratings apply only to movies shown on TV, not TV programs such as soap operas.

- 1 Press MENU.**
The main menu appears.
- 2 Use ▲ / ▼ to select the LOCK then press ► or Ⓞ (SELECT) to move to the second level.**

If you have not entered a password yet;

Key-in the “0000” password using the numbered buttons to create a personal 4-digit security password.

If you have already entered a password;

Key-in the 4-digit password using the numbered buttons to confirm the personal 4-digit security password.

- 3 Use ▲ / ▼ to select the Movie Rating option.**
- 4 Press ► or Ⓞ (SELECT) to move to the third level.**
- 5 Use ▲ / ▼ to select a rating then press Ⓞ (SELECT) to confirm your selection.**

All Block: All programs with a rating are blocked.

G (General Audiences): Content is not offensive to most viewers.

This is a film which contains nothing in theme, language, nudity and sex, violence, etc. which would be offensive to parents whose younger children view the film. The G rating is not a “certificate of approval,” nor does it signify a children’s film.

Some snippets of language may go beyond polite conversation but they are common everyday expressions. No stronger words are present in G-rated films. The violence is at a minimum. Nudity and sex scenes are not present; nor is there any drug use content.

PG: “Parental Guidance Suggested. Some Material May Not Be Suitable For Children.”

The PG rating, suggesting parental guidance, is an alert for examination of a film by parents before deciding on its viewing by their children. This is a film which clearly needs to be examined or inquired into by parents before they let their children see it. The label PG plainly states that parents may consider some material unsuitable for their children, but the parent must make the decision. Parents are warned against allowing their children to see PG-rated movies. The theme of a PG-rated film may itself call for parental guidance. There may be some profanity in these films. There may be some violence or brief nudity. But these elements are not deemed so intense as to require that parents be strongly cautioned beyond the suggestion of parental guidance. There is no drug use content in a PG-rated film.

Continued →

Lock (Parental Control) Menu Options (Continued)

PG-13: PG-13 Parents Strongly Cautioned. Some Material May Be Inappropriate For Children Under 13.

PG-13 is a sterner warning to parents to determine for themselves the attendance in particular of their younger children as they might consider some material not suited for them. Parents, by the rating, are alerted to be very careful about viewing by their under-teenage children.

A PG-13 film is one which leaps beyond the boundaries of the PG rating in theme, violence, nudity, sensuality, language, or other contents, but does not quite fit within the restricted R category. Any drug use content will initially require at least a PG-13 rating. In effect, the PG-13 cautions parents with more stringency than usual to give special attention to this film before they allow their 12-year olds and younger to see it.

PG-13 places larger responsibilities on parents for their children's movie viewing. The rating system is not a surrogate parent, nor should it be. It cannot, and should not, insert itself in family decisions that only parents can, and should, make. Its purpose is to give prescreening advance informational warnings, so that parents can form their own judgments. PG-13 is designed to make these parental decisions easier for films between PG and R.

R (Restricted viewing): Not for children under age 17. Strong elements of sex and/or violence.

Requires Accompanying Parent Or Adult Guardian. The film definitely contains some adult material. Parents are strongly urged to find out more about the film before they allow their children to see it.

An R-rated film may include hard language, or tough violence, or nudity within sensual scenes, or drug abuse or other elements, or a combination of some of the above, so that parents are counseled, in advance, to take this advisory rating very seriously. Parents must find out more about an R-rated movie before they allow their teenagers to view it.

NC-17 (Restricted Viewing): Not for children under age 17 under any circumstances. Strong sexual content.

This rating declares that this is a film that most parents will consider patently too adult for their youngsters under 17. No children should see the film. NC-17 does not necessarily mean "obscene or pornographic" in the oft-accepted or legal meaning of those words. The reasons for the application of an NC-17 rating can be violence or sex or aberrational behavior or drug abuse or any other elements which, when present, most parents would consider too strong and therefore off-limits for viewing by their children.

X (Hard Core Films): Same as NC-17 rating.

6 Press **MENU** to return to the previous menu or press **EXIT** on the Remote Control to return to TV viewing.

Lock (Parental Control) Menu Options (Continued)

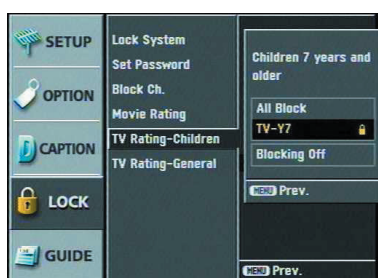
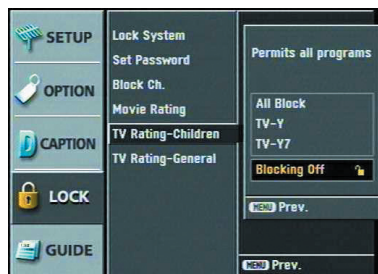

TV Rating-Children

Prevents children from watching certain children's TV programs according to the ratings limit set. This rating applies only to TV programs for children. Unless you block TV programs intended for mature audiences in the TV Rating – General menu, your children could view those programs.

- 1 Press MENU.**
The main menu appears.
- 2 Use ▲ / ▼ to select the LOCK then press ► or ● (SELECT) to move to the second level.**

If you have not entered a password yet;

Key-in the "0000" password using the numbered buttons to create a personal 4-digit security password.

If you have already entered a password;

Key-in the 4-digit password using the numbered buttons to confirm the personal 4-digit security password.

- 3 Use ▲ / ▼ to select the TV Rating-Children option.**
- 4 Press ► or ● (SELECT) to move to the third level.**
- 5 Use ▲ / ▼ to select the Age or Fantasy Violence option then press ► or ● (SELECT).**

Age: Selection applies regardless of content category of rating.

Fantasy Violence: Selection applies if TV programs include rating for Fantasy Violence.

- 6 Use ▲ / ▼ to select a rating then press ● (SELECT) to confirm your selection.**

All Block: All programs with a rating are blocked.

TV-Y: All Children.

This program is designed to be appropriate for all children. Whether animated or live-action, the themes and elements in this program are specifically designed for a very young audience, including children from ages 2 - 6. This program is not expected to frighten younger children.

TV-Y7: Directed toward children age 7 and older.

This program is designed for children age 7 and older. It may be more appropriate for children who have acquired the developmental skills needed to distinguish between make-believe and reality. Themes and elements in this program may include mild fantasy violence or comedic violence, or may frighten children under the age of 7. Therefore, parents may wish to consider the suitability of this program for their very young children.

Note: For those programs where fantasy violence may be more intense or more combative than other programs in this category, such programs will be designated TV-Y7-FV.

- 7 Press MENU to return to the previous menu or press EXIT on the Remote Control to return to TV viewing.**

Lock (Parental Control) Menu Options (Continued)

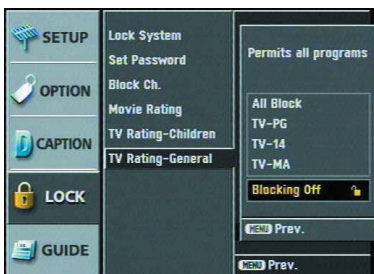
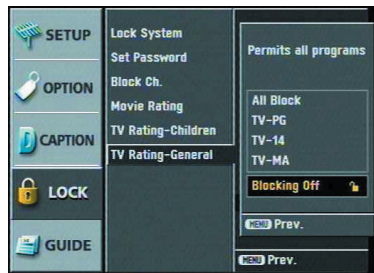
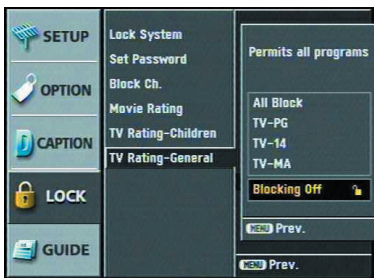

TV Rating-General

Blocks TV programs that you or your family may not wish to watch, based on the rating scheme set.

- 1 Press MENU.**
The main menu appears.
- 2 Use ▲ / ▼ to select the LOCK then press ► or ○ (SELECT) to move to the second level.**

If you have not entered a password yet;

Key-in the "0000" password using the numbered buttons to create a personal 4-digit security password.

If you have already entered a password;

Key-in the 4-digit password using the numbered buttons to confirm the personal 4-digit security password.

- 3 Use ▲ / ▼ to select the TV Rating-General option.**
- 4 Press ► or ○ (SELECT) to move to the third level.**
- 5 Use ▲ / ▼ to select Age, Dialogue, Language, Sex, or Violence then press ► or ○ (SELECT).**

Age: Selection applies regardless of content category of rating.

Dialogue: Selection applies if TV programs have rating for Dialogue.

Language: Selection applies if TV programs have rating for Language.

Sex: Selection applies if TV programs have rating for Sex.

Violence: Selection applies if TV programs have rating for Violence.

- 6 Use ▲ / ▼ to select a rating then press ○ (SELECT) to confirm your selection.**

All Block: All programs with a ratings are blocked.

TV-G: General Audience.

Most parents would find this program suitable for all ages. Although this rating does not signify a program designed specifically for children, most parents may let younger children watch this program unattended. It contains little or no violence, no strong language and little or no sexual dialogue or situations.

TV-PG: Parental Guidance Suggested.

This program contains material that parents may find unsuitable for younger children. Many parents may want to watch it with their younger children. The theme itself may call for parental guidance and/or the program contains one or more of the following: moderate violence (V), some sexual situations (S), infrequent coarse language (L), or some suggestive dialogue (D).

Continued →

Lock (Parental Control) Menu Options (Continued)

TV-14: Parents Strongly Cautioned.

This program contains some material that many parents would find unsuitable for children under 14 years of age. Parents are strongly urged to exercise greater care in monitoring this program and are cautioned against letting children under the age of 14 watch unattended. This program contains one or more of the following: intense violence (V), intense sexual situations (S), strong coarse language (L), or intensely suggestive dialogue (D).

TV-MA: Mature Audience Only.

This program is specifically designed to be viewed by adults and therefore may be unsuitable for children under 17. This program contains one or more of the following: graphic violence (V), explicit sexual activity (S), or crude indecent language (L).

7 Press **MENU** to return to the previous menu or press **EXIT** on the Remote Control to return to TV viewing.

GUIDE Options

Program Guide

The Program Guide contains schedule and program information for all channels. It also provides local over-the-air channels information including conventional digital channels.

Use the Program Guide to find programs easily and conveniently and view schedule and descriptive program information by Time and General classifications.

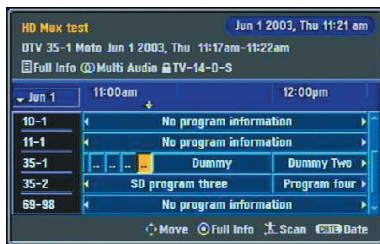
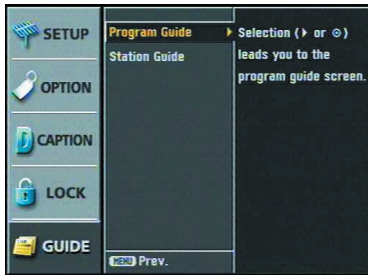

Tip

You can also display the Program Guide by pressing the **PROGRAM** button on the Remote Control. Refer to Program and Station Guide on pages 40-41 for detailed information.

- 1 Press **MENU**.
The main menu appears.
- 2 Use **▲/▼** to select the **GUIDE** menu then press **▶** or **◉** (**SELECT**) to move to the second level.
- 3 Use **▲/▼** to select the Program Guide option.
- 4 Press **▶** or **◉** (**SELECT**) to display the Program Guide.
- 5 Use **◀/▶/▲/▼** to select a program then press **◉** (**SELECT**) to get more information for the program.
- 6 Press **EXIT** to return to TV viewing.

Note

The information for program guide and time may differ depending on the TV station.

Station Guide

Use the Station Guide to find programs easily and conveniently and view schedule and descriptive program information with channel number.

Tip

You can also display the Station Guide by pressing the **STATION** button on the Remote Control. Refer to Program and Station Guide on pages 40-41 for detailed information.

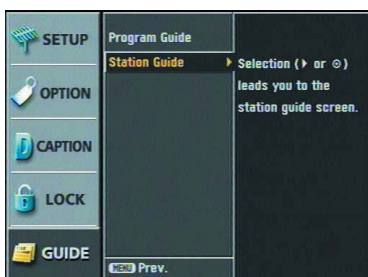

- 1 Follow Steps 1-2 as shown as above.
- 2 Use **▲/▼** to select the Station Guide option.
- 3 Press **▶** or **◉** (**SELECT**) to display the Station Guide.
- 4 Use **◀/▶/▲/▼** to select a program then press **◉** (**SELECT**) to get more information for the program.
- 5 Press **EXIT** to return to TV viewing.

Information Displays

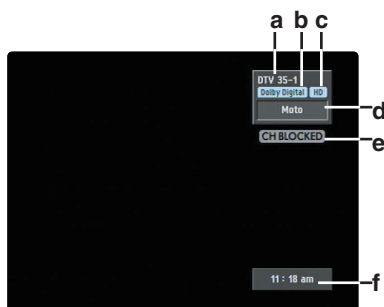

Channel Banner Display

The Channel Banner appears whenever you tune to a new channel or press the **⊙** (SELECT) button on the Remote Control while viewing a program.

1 Press **⊙** (SELECT) while watching a program.

The Channel Banner appears on the TV screen (Channel number, audio, station name, and current time).

- The Channel Banner can be seen displayed on the TV screen for a moment.

- a. Channel Number
Displays the current channel number.
- b. Audio Information
Indicates audio information (Dolby Digital, Stereo, SAP, Mono, etc.)
- c. Digital Picture Definition (only for digital broadcast)
Displays the digital picture grade such as HD (High Definition) or SD (Standard Definition).
- d. Station Name
Displays the station name of the current channel.
- e. Block Information
Displays the block information such as No Signal, Rating Blocked, Channel Blocked, Audio Only or Scrambled.
- f. Time
Displays the current time.

2 Press **⊙** (SELECT) again while the Channel Banner is displayed.

The Channel Banner disappears from the TV screen.

Notes

- Station name and clock are displayed only if they are provided by broadcaster.
- If the channel is scrambled, you may not be able to see the program.

Information Displays (Continued)

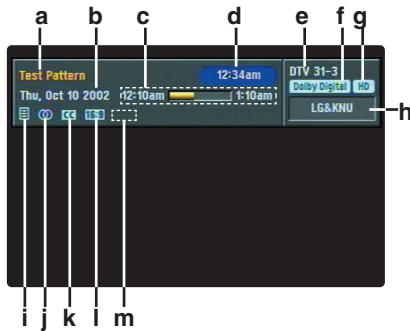

Program Information Display

The Program Information Display appears if you press the INFO button on the Remote Control while viewing a program.

1 Press INFO while watching a program

Program Information appears on the TV screen.

- a. Program Title
Indicates title of current program.
- b. Date
Displays the current date.
- c. Start Time, End Time, and Elapsed Time Indicator
Displays the start time, end time and the elapsed time indicator bar for the current program.
- d. Time
Shows current time.
- e. Channel Number
Displays the current channel number.
- f. Audio Information
Indicates audio information (Dolby Digital, Stereo, SAP, Mono, etc.)
- g. Digital Picture Grade (only for digital broadcast)
Displays the digital picture grade such as HD (High Definition) or SD (Standard Definition).
- h. Station Name
Displays the station name of the current channel.
- i. Extended Text Message Icon (☐)
Indicates that there is an Extended Text Message available to provide detailed descriptions of the program (see page 41).
- j. Multiple Audio Icon (Ⓞ)
Channels sometimes provide multiple audio tracks, often in a different language. When multiple audio tracks are available, the Multiple Audio Icon is displayed that you can select one of those other audio tracks with the AUDIO button.
- k. DTV Caption Icon (CC)
Indicates that the current program contains Digital Closed Caption Data Service.
- l. Wide Icon (16:9)
Indicates that the current program is shown in wide picture format.
- m. Content Advisory Icon (Ⓜ)
Content Advisory data is used for the parental guide control to block programs that are beyond predefined rating criteria set by users. This icon means that the current program contains content advisory data, and displays rating value of program.

2 Press INFO or EXIT while the Program Information is displayed.

The Program Information disappears from the TV screen.

Note

Station name and clock are displayed only if they are provided by the broadcaster.

Program and Station Guide

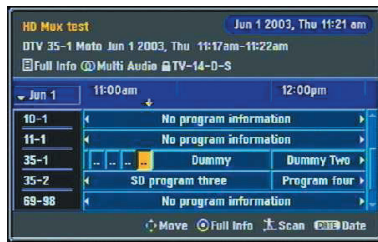

Program Guide



Station Guide

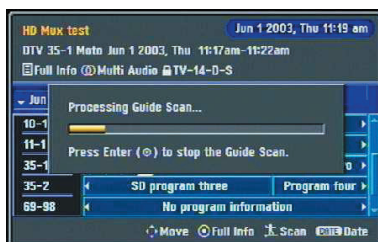
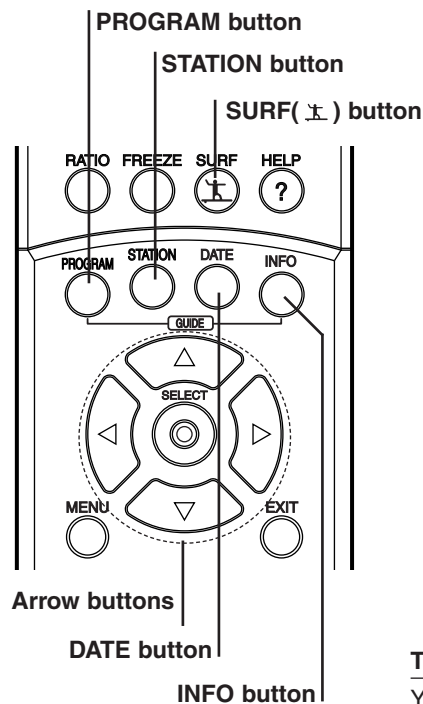

Guide Scan

The Program and Station Guide contains schedule and program information for all channels. They also provide local over-the-air channels information including conventional digital channels. Use the Program and Station Guide to find programs easily and conveniently and to view schedule and descriptive program information for the channels.

To Display the Program or Station Guide

- Press the PROGRAM or STATION button on your Remote Control.
- or
- Press the MENU button on the Remote Control and select the GUIDE menu. Guide options will appear. Choose the Program or Station Guide option [MENU → GUIDE → Program Guide (or Station Guide)]

To Exit the Program or Station Guide

Press the EXIT button to return to the last channel you tuned to.

To Navigate through programs on the Guides

The Program and Station Guide are operated based on a simple straightforward “Highlight and Select” process.

1. Use ◀/▶/▲/▼ on your Remote Control to navigate the guide screen.
2. Press SELECT to select or execute the highlighted menu or function (see page 41).

The On-Screen Guide shows you program listings for five channels within a one and a half hour time slot. For example: 6:00-7:30. In order to view a list of future programs or other channels, you may continuously press ◀/▶/▲/▼ to scroll horizontally or vertically. This may take a while to reach a specific channel or program, if the channel or program is listed far from the currently highlighted program. The Program and Station Guide thus offers you shortcuts to minimize your effort in navigating channels and time slots.

Line Scrolling

You can reach other time slots or channels that are currently hidden from the screen using the arrow buttons “◀/▶/▲/▼”. Move horizontally to reach other channels and move vertically to reach other time slots on the Station Guide.

Date Scrolling

When the Program or Station Guide is displayed, you can also change the date of the Program Guide by pressing the DATE button then use ▲/▼ to select date.

Page Scrolling (Program Guide only)

You can move faster through channels by scrolling page-by-page using the PG UP or PG DN buttons on the Remote Control. Each button stroke scrolls one page up or down.

To update the guide information (Guide Scan)

You can update the guide information by pressing SURF (±). The Guide Scan will update the available guide information through all channels; this may take a few minutes.

Program and Station Guide (Continued)

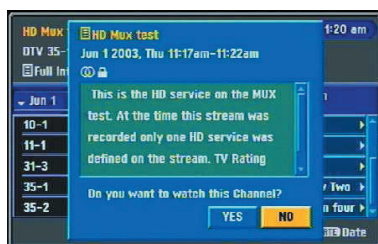
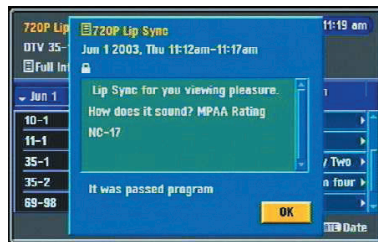
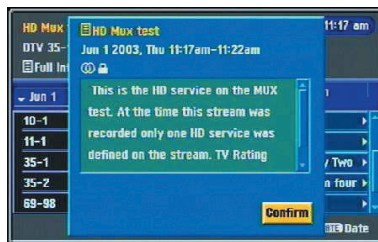

To show all Information available on the Extended Text Message

Pressing the SELECT button will display the full information window about the highlighted program with Extended Text Message Icon (see page 39). Depending on the broadcaster and service provider, the Extended Text Message may include actor and role relationships, original material, production studio, the date on which the program was first shown, and so on.

Tips

- If you select a TV program currently being broadcasted, “Confirm” appears on the bottom of the full information window. Press **SELECT** to remove the full information window.
- If you select a past or future TV program on the currently tuned channel, “OK” appears on the bottom of the full information window. Press **SELECT** to remove the full information window.
- You can view hidden information on the full information window. Use **▲ / ▼** to scroll vertically.

To Tune to another channel on the Full Information window

You can also tune in other channels on the Full Information window. If you select a TV program that is not on the currently tuned channel, the “Do you want to watch this Channel” message appears on the bottom of the full information window. Select “YES” then press **SELECT** to tune to the channel of the selected program. Select “NO” then press **SELECT** to remove the full information window.

Normal Operation

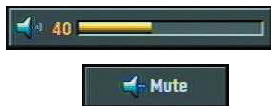
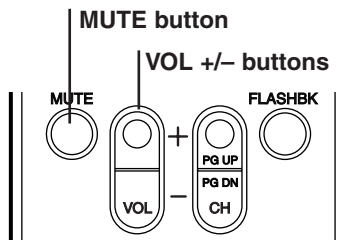
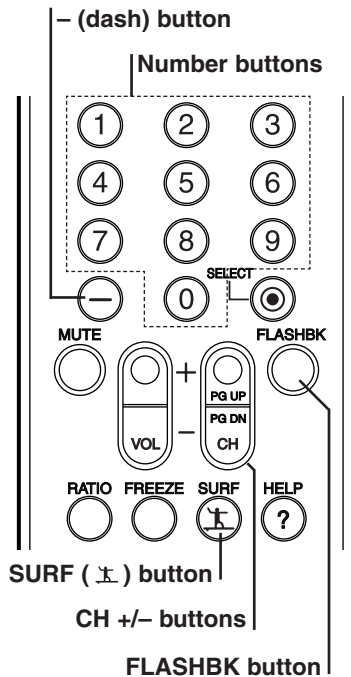

Channel Selection

You can select channels as described below.

Number and - (dash) buttons (on the Remote Control)

Use **Number (0-9)** and **- (dash)** buttons to select a channel directly.

FLASHBK button (on the Remote Control)

Press to return to the previous channel you viewed. For example, if the DTV Receiver is tuned to channel 55 and then you change to channel 56, pressing FLASHBK will return to channel 55.

SURF (±) button (on the Remote Control)

Press to scroll through your favorite channels.

CH +/- buttons (on the Remote Control) or ▲ / ▼ (on the front panel)

Use CH +/- on the Remote Control or ▲ / ▼ on the front panel to cycle the HDTV Receiver through the channels in memory.

Volume Adjustment

Adjusts the sound level for analog audio out on the HDTV Receiver. You must set Audio Variable to On in the OPTION menu to use the Volume Adjustment. See page 26.

VOL +/- buttons (on the Remote Control) or ◀ / ▶ (on the front panel)

Use VOL +/- on the Remote Control or ◀ / ▶ on the front panel to adjust the sound level for analog audio out on the HDTV Receiver.

MUTE (on the Remote Control)

Press **MUTE** to turn off the volume for audio out on the HDTV Receiver.

Notes

- Before setting Audio Variable to Off, make sure that you have turned down the TV's volume to the minimum. Otherwise, sudden high volume sound may cause hearing or speaker damage.
- The volume for digital audio out on HDTV Receiver can not be adjusted on the HDTV Receiver front panel.

Signal

Shows the signal strength bar for incoming signal to help you adjust the antenna to the correct position for your location. You can view the signal strength bar by pressing SIGNAL on the Remote Control.

Tip

Refer to www.antennaweb.org for antenna position.

AntennaWeb.org, will help you determine the proper outdoor antenna to use in order to receive television channels that are broadcast locally.

Freeze

Pressing the FREEZE button freezes the current image. Pressing the FREEZE button once again returns the image to live video.

Note

The frozen image returns to live video after 5 minutes.

Programming the Remote Control to Operate Other Devices

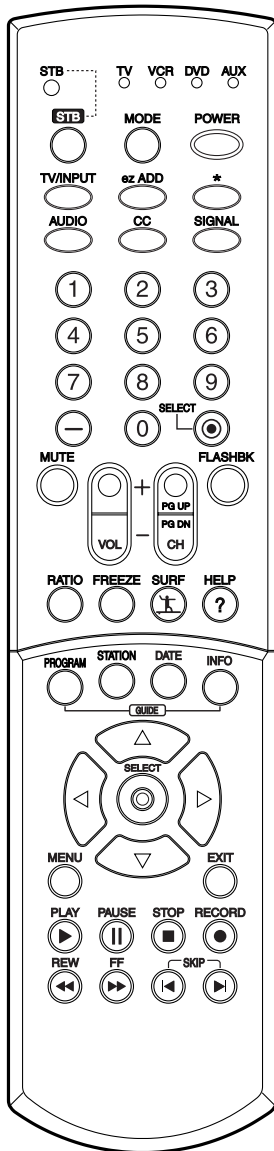

The HDTV Receiver Remote Control is a multi-brand or universal Remote Control that can be programmed to operate most remote-controllable devices from other manufacturers.

Note

The Remote Control may not be able to control all models of other brands.

1 Test your Remote Control.

To find out whether your Remote Control can operate a device without programming, turn on the device such as a VCR and select the corresponding mode (VCR) by pressing MODE on the Remote Control while pointing at the device. Use the POWER and CH +/- buttons to see if the device responds properly. If not, the Remote Control requires programming.

2 Turn on the device to be programmed. Then select the corresponding mode (VCR, AUX, TV, DVD or STB) by pressing MODE on the Remote Control.

3 Press the POWER button and the MUTE button simultaneously.

The Remote Control is now ready to program the code for the device.

4 There are two ways to find the correct code for the device.

First, if you press the CH + buttons repeatedly, the codes will change one at-a-time. If the right code is found, the device will turn off.

Second, enter the code number using the number buttons on the Remote Control. The right code numbers for the corresponding device can be found on the following pages. If the code is correct, the device will turn off.

5 Press the EXIT button to store the programming code.

6 Test the Remote Control functions to see if the device responds properly. If not, repeat from step 2.

Remote Control Codes for Other Devices

TV Codes

Brands	Codes
A MARK	112 143
ADMIRAL	072 081 161
AKAI	006 146
AMPRO	073 167
AMSTRAD	052
ANAM	043 054 056 080 104 108 112 115 118 121 131
AOC	004 006 058 112
BLAUPUNKT	088
CANDLE	002 003 004 006
CAPEHART	058
CETRONIC	043
CITIZEN	002 003 004 006 043 101 103 143
CLASSIC	043
CONCERTO	004
CONTEC	039 043 050 051
CORONADO	143
CRAIG	043 054
CROWN	043 143
CURTIS MATHES	004 006 101 116 143
CXC	043
DAEWOO	004 016 017 043 044 055 071 076 103 107 111 114 117 120 123 125 127 128 136 143
DAYTRON	004 116 143
DYNASTY	043
DYNATECH	062
ELECTROHOME	024 077 143
EMERSON	004 005 006 028 043 047 048 050 051 096 116 143 151 153 154 155
FISHER	007 057
FUNAI	028 043
FUTURETECH	043
GE	004 006 008 009 034 056 073 074 091 116 130 144 155 160 161 165
HALL MARK	004 116
HITACHI	004 006 009 010 011 012 023 041 075 143 158 163 166
INFINITY	164
INKEL	129
JBL	164
JCPENNY	004 006 008 009 024 030 065 101 143 156 160
JENSEN	013
JVC	034 038 070 083 145
KEC	043
KENWOOD	006 070
KLOSS	002 059
KMC	143
KTV	006 043 143 154
LG	001 004 102 106 110 112 113 116 119 122 127 137 143
LODGENET	072
LOGIK	072
LUXMAN	004
LXI	007 015 052 081 160 164 166

Brands	Codes
MAGNAVOX	003 004 006 022 059 060 061 063 064 127 143 160 164
MARANTZ	006 077 164
MATSUI	164
MEMOREX	004 007 072 116
METZ	088
MGA	004 006 024 028 042 049 077 116
MINERVA	088
MITSUBISHI	004 006 024 028 040 042 109 116 124 146
MTC	004 006 062 101
NAD	015 025
NEC	006 007 016 019 024 040 056 130 132 134
NIKEI	043
ONKING	043
ONWA	043
OPTONICA	019 081
PADIO SHACK	004
PANASONIC	034 056 080 092 164
PHILCO	003 004 006 024 043 056 059 060 063 064 127 143 164
PHILIPS	003 004 005 006 038 059 070 093 143 160 164
PIONEER	006 018 023 025 027 116 135 176
PORTLAND	004 143
PROSCAN	144 160 161 165 167
PROTON	004 058 116 131 143 171 173
QUASAR	034 056 092
RADIO SHACK	019 043 047 116 127 143
RCA	004 006 023 024 056 065 074 144 152 156 160 161 165
REALISTIC	007 019 043 047
ROCTEC	186
RUNCO	168 169
SAMPO	004 006 058 116
SAMSUNG	004 050 089 101 105 113 116 127 133 137 143 160
SANYO	007 020 021 033 039 053 057 082 166
SCOTT	004 028 043 048 116 143
SEARS	004 007 015 028 030 057 082 094 101 116 143 160
SHARP	004 014 019 022 028 029 081 143 170 175
SIEMENS	088
SIGNATURE	072
SONY	041 070 079 085 126 139 147 185
SOUNDESIGN	003 004 028 043 116
SPECTRICON	112
SSS	004 043
SUPRE MACY	002
SYLVANIA	003 004 006 044 059 060 063 064 116 127 140 160 164
TANDY	081

Brands	Codes
TATUNG	056 062
TECHNICS	034 080 084
TECHWOOD	004
TEKNIKA	002 003 004 006 024 028 031 043 072 077 101 103 143
TELEFUNKEN	037 046 086 087
TELERENT	072
TERA	172
TMK	004 116
TOSHIBA	007 015 030 040 051 062 101 138
TOTEVISION	143
UNIVERSAL	008 009
VIDEO CONCEPTS	146
VIDIKRON	174
VIDTECH	004 116
YAMAHA	004 006
YORK	004 116
YUPITERU	043
ZENITH	072 073 095 103 157
ZENITH/LG	001
ZENITH/HITACHI	187
ZONDA	112

VCR Codes

Brands	Codes
AIWA	034
AKAI	016 043 046 124 125 146
AMPRO	072
ANAM	031 033 103
AUDIO DYNAMICS	012 023 039 043
BROKSONIC	035 037 129
CANON 028	031 033
CAPEHART	108
CRAIG	003 040 135
CURTIS MATHES	031 033 041
DAEWOO	005 007 010 064 065 108 110 111 112 116 117 119
DAYTRON	108
DBX	012 023 039 043
DYNATECH	034 053
ELECTROHOME	059
EMERSON	006 017 025 027 029 031 034 035 036 037 046 101 129 131 138 153
FISHER	003 008 009 010
FUNAI	034
GE	031 033 063 072 107 109 144 147
GO VIDEO	132 136
HARMAN KARDON	012 045
HITACHI	004 018 026 034 043 063 137 150
INSTANTREPLAY	031 033
JCL	031 033
JCPENNY	012 013 015 033 040 066 101
JENSEN	043
JVC	012 031 033 043 048 050 055 060 130 150 152
KENWOOD	014 034 039 043 047 048
LG	001 012 013 020 101 106 114 123

Remote Control Codes for Other Devices (Continued)

VCR Codes

Brands	Codes
LLOYD	034
LXI	003 009 013 014 017 034 101 106
MAGIN	040
MAGNAVOX	031 033 034 041 067 068
MARANTZ	012 031 033 067 069
MARTA	101
MATSUI	027 030
MEI	031 033
MEMOREX	003 010 014 031 033 034 053 072 101 102 134 139
MGA	045 046 059
MINOLTA	013 020
mitsubishi	013 020 045 046 049 051 059 061 151
MTC	034 040
MULTITECH	024 034
NEC	012 023 039 043 048
NORDMENDE	043
OPTONICA	053 054
PANASONIC	066 070 074 083 133 140 145
PENTAX	013 020 031 033 063
PHILCO	031 034 067
PHILIPS	031 033 034 054 067 071 101
PILOT	101
PIONEER	013 021 048
PORTLAND	108
PULSAR	072
QUARTZ	011 014
QUASAR	033 066 075 145
REALISTIC	003 008 010 014 031 033 034 040 053 054 101
RICO	058
RUNCO	148
SALORA	014
SAMSUNG	032 040 102 104 105 107 109 112 113 115 120 122 125
SANSUI	022 043 048 135
SANYO	003 007 010 014 102 134
SCOTT	017 037 112 129 131
SEARS	003 008 009 010 013 014 017 020 031 042 073 081 101
SHARP	031 054 149
SHINTOM	024
SONY	003 009 031 052 056 057 058 076 077 078 149
SOUNDESIGN	034
STS	013
SYLVANIA	031 033 034 059 067
SYMPHONIC	034
TANDY	010 034
TATUNG	039 043
TEAC	034 039 043
TECHNICS	031 033 070
TEKNIKA	019 031 033 034 101
THOMAS	034

Brands	Codes
TMK	006
TOSHIBA	008 013 042 047 059 082 112 131
TOTEVISION	040 101
UNITECH	040
VECTOR RESEARCH	012
VICTOR	048
VIDEO CONCEPTS	012 034 046
VIDEOSONIC	040
WARDS	003 013 017 024 031 033 034 040 053 054 131
YAMAHA	012 034 039 043
ZENITH	034 048 056 058 072 080 101 001

DVD Codes

Brands	Codes
APEX DIGITAL	022
DENON	020 014
GE	005 006
HARMAN KARDON	027
JVC	012
LG	001 010 016 025
MAGNAVOX	013
MARANTZ	024
MITSUBISHI	002
NAD	023
ONKYO	008 017
PANASONIC	003 009
PHILIPS	013
PIONEER	004 026
PROCEED	021
PROSCAN	005 006
RCA	005 006
SAMSUNG	011 015
SONY	007
THOMPSON	005 006
TOSHIBA	019 008
YAMAHA	009 018
ZENITH	001 010 016 025

AUX (AUDIO) Codes

Brands	Codes
HITACH	010
JVC	006 039 049 050
KENWOOD	001 013 029 031 044
LUXMAN	017
MARANTZ	002 021 028 030 032 035
NAD	014
NAKAMICHI	051 052
ONKYO	008 009 025 040 041
OPTIMUS	011 013 022
PANASONIC	003 015 036 046
PIONEER	007 016 020 023 024 026 033 037 047
QUASAR	003 036
RCA	004
SHARP	013 029 043 045
SHERWOOD	012 019
SONY	027 034 038 048 053
SOUNDESIGN	018
TOSHIBA	042
VICTOR	006 039

AUX (CD) Codes

Brands	Codes
ADC	104
AIWA	149 178 189 202 212
AKAI	134 165 200
DENON	101 190 221 222 223
EMERSON	133 136 152 166 175
FISHER	113 122 138 140 168
GE	209
HITACHI	133 166
JVC	117 196 227 228
KENWOOD	105 110 113 118 144 154 155 198 200 216 217
LUXMAN	108 123 153 173
MAGNAVOX	127 135 172 179 180
MARANTZ	129 135 141 159 224 225 226
MCS	111 147 156 169
MITSUBISHI	120 179 229 230 231
ONKYO	125 126 130 131 213 215 232
OPTIMUS	100 107 110 124 139 140 145 146 162 163 164 165 170
PANASONIC	106 151 176 184 203 219 233
PHILIPS	127 135 195 199 237
PIONEER	107 124 167 171 179 187 191 205 206 207
QUASAR	106 176
RADIO SHACK	186 188
RCA	114 133 157 166 114
SANYO	121 140 158 168
SEARS	147
SHARP	110 141 150 181 200 204 210 150 217
SHERWOOD	102 115 116 128 141 193
SONY	100 142 168 174 182 183 192 208 234 235 236
TECHNICS	106 148 151 176 184 203 214 218
TEAC	103 112 132 141 160 161 132 177 185 161 197 201
YAMAHA	109 119 137 143 194 211

STB Codes

Brands	Codes
LG	001
Zenith	001 002

Troubleshooting

Check the following guide for the possible cause of a problem before contacting service.

Symptom	Solution(s)
HDTV Receiver does not turn on.	<ul style="list-style-type: none"> ● Plug the power cord into a wall power outlet securely.
Fragmented picture and unclear sound.	<ul style="list-style-type: none"> ● Check your antenna input, location, and signal strength.
No picture.	<ul style="list-style-type: none"> ● Make sure the correct video display format is selected. ● Make sure that the right component type is selected. ● If HDTV Receiver is connected to your monitor or TV via the YPbPr port on the back panel, the output connector setting must be set to the YPbPr position (see page 17). Otherwise, you will probably see an abnormal picture. ● If HDTV Receiver is connected to your monitor or TV via the RGB port on the back panel, the output connector setting must be set to the RGB position. Otherwise, you may not be able to see a picture. ● Select the EZ Scan or Manual Add functions if you have not already done so. ● Check to make sure all the cables are installed correctly and that the proper source is selected on your TV. For example, Video 1 or 2. ● The antenna signal strength may be low. Check the signal strength and adjust the antenna location and direction. ● Due to copyright restrictions, you may not be able to view some high definition programs in the high definition format. ● For more information about connections, please refer to connections on pages 10-14.
Normal picture but no sound.	<ul style="list-style-type: none"> ● Check volume levels. ● Make sure the TV is not muted. ● Check that the HDTV receiver is connected properly.
Picture is distorted.	<ul style="list-style-type: none"> ● Make sure the proper format is selected. ● Make sure the proper aspect ratio is selected. ● Make sure the video output is connected to the TV.
Available channels are missing.	<ul style="list-style-type: none"> ● You can find all the available channels is by running the "EZ Scan" or "EZ Add" in the SETUP menu.
You forgot your password.	<ul style="list-style-type: none"> ● Enter the master password "7777".
The Remote Control does not work properly.	<ul style="list-style-type: none"> ● Use Mode button to select STB operational mode. ● Point the Remote Control at the remote sensor on the HDTV Receiver. ● Operate the Remote Control within 23 ft (7 m). ● Remove any obstacles blocking the signal. ● Replace exhausted batteries with new ones.

Specifications

Television System		NTSC, DTV standard ATSC (1080i, 720p, 480p, 480i)
Channel Coverage		Terrestrial: 2-69, Cable: 1-135
Input/Output	ATSC/NTSC RF Inputs	ANT IN (1) (NTSC, ATSC or Clear QAM over cable)
	ANT Loop Out	Out To TV (1)
	DVI Output	DVI-HDTV Out (1), DVI-D Single Link connector 1080i, 720p, 480p digital RGB
	Component Video Output	Component Out (1 Set), Typical RCA type Jack connectors 1080i, 720p, 480p, 480i YPbPr
	RGB Output	RGB Out (1), 15-pin connector 1080i, 720p, 480p RGB
	S-Video Output	S-Video Out (1), 4-pin Mini-DIN 480i Y/C
	Video Output	Video Out (1), Typical RCA type Jack connector 480i Composite
	Digital Audio Output	Coaxial, Optical (Dolby Digital output)
	Analog Audio Output	Audio Out (2) (Variable Output Level)
	Authorized Service Port	9-pin Serial Port (1)
Dimension (W x H X D)		14.2 x 2.4 x 10.4 inches (360 x 60 x 265 mm)
Weight		7.7 lbs (3.5 kg)
Power Requirements		AC 120V, 60Hz
Power Consumption		15W
Environment	Humidity	0 to 99 percent non condensing
	Storage Temperature	-20 to 60 degrees Celsius (-4 to 140 degrees Fahrenheit)
	Operating Temperature	0 to 40 degrees Celsius (32 to 104 degrees Fahrenheit)
Accessories	RF cable	1
	Video cable	1
	Audio (L/R) cable	1
	Component (YPbPr) cable	1
	DVI cable	1
	Remote Control	1
	Batteries (size AA)	2

REFERENCE

- Design and specifications are subject to change without prior notice.



LG Electronics, Inc. Limited Warranty - USA

This LG Electronics product, will be repaired or replaced, at LG's option, if it proves to be defective in material or workmanship, under normal use, during the warranty period ("Warranty Period") listed below, effective from the date ("Date of Purchase") of original consumer purchase of the product. This warranty is good only to the original purchaser of the product and effective only when used in the United States, excluding U.S. Territories.

WARRANTY PERIOD: LABOR: 90 days from the Date of Purchase. PARTS: One Year from the Date of Purchase. * Parts replaced are warranted for the remaining portion of the original warranty period.	HOW SERVICE IS HANDLED: Call 1-800-243-0000 for instructions on getting the defective unit repaired or replaced. Please retain dated sales receipt and your box to return the unit to LG for repair or replacement. Shipping both ways will be paid by LG during the first 90 days of the Warranty Period. During the remainder of the Warranty Period (91-365 days), you pay inbound shipping charges and LG pays return shipping charges. Visit our website at: http://www.lgservice.com
---	--

THIS WARRANTY IS IN LIEU OF ANY OTHER WARRANTIES, EXPRESS OR IMPLIED, INCLUDING WITHOUT LIMITATION, ANY WARRANTY OF MERCHANTABILITY OR FITNESS FOR A PARTICULAR PURPOSE. TO THE EXTENT ANY IMPLIED WARRANTY IS REQUIRED BY LAW, IT IS LIMITED IN DURATION TO THE EXPRESS WARRANTY PERIOD ABOVE. LG ELECTRONICS WILL NOT BE LIABLE FOR ANY INCIDENTAL, CONSEQUENTIAL, INDIRECT, SPECIAL OR PUNITIVE DAMAGES OF ANY NATURE, EVEN IF ADVISED OF THE POSSIBILITY OF SUCH DAMAGES, INCLUDING WITHOUT LIMITATION, LOST REVENUES OR PROFITS, LOST OR CORRUPTED PROGRAMMING OR DATA, OR ANY OTHER DAMAGE WHETHER BASED IN CONTRACT, TORT OR OTHERWISE. Some states do not allow the exclusion or limitation of incidental or consequential damages or limitation on how long an implied warranty lasts, so the above exclusion or limitation may not apply to you. This warranty gives you specific legal rights and you may also have other rights that may vary from state to state.

THIS LIMITED WARRANTY DOES NOT APPLY TO:

- Damages or operating problems that result from shipping, installation, adjustment of user controls, calibration, maintenance or failure to maintain, or separate system components; and
- Damages or operating problems that result from normal wear and tear, misuse, abuse, operation outside environmental specifications or contrary to the requirements or precautions in the Operating Guide, accident, lightning strikes or other natural causes, unauthorized modification or alteration, incorrect electrical current or voltage, signal reception or input, software not licensed directly by LG, software errors that do not disable functionality, operating and software protocols adopted after the date of manufacture or for outside the US, institutional or commercial use, or other causes not arising out of defect in material or workmanship.

The cost of repair or replacement under these excluded circumstances shall be borne by the consumer.

CUSTOMER INTER-ACTIVE CENTER NUMBERS:

For Warranty Service, Where to buy, Product Assistance, or Customer Assistance	Call 1-800-243-0000 (24 hours a day, 365 days per year) and select appropriate options from the menu. Or visit our website at http://www.lgservice.com
---	---

Marketed and distributed in the United States by LG Electronics U.S.A., Inc.

LG ELECTRONICS U.S.A., INC.
1000 SYLVAN AVENUE
ENGLEWOOD CLIFFS, NJ 07632

P/N : 3835RB0001P
Printed in Korea
Issue O

Free Manuals Download Website

<http://myh66.com>

<http://usermanuals.us>

<http://www.somanuals.com>

<http://www.4manuals.cc>

<http://www.manual-lib.com>

<http://www.404manual.com>

<http://www.luxmanual.com>

<http://aubethermostatmanual.com>

Golf course search by state

<http://golfingnear.com>

Email search by domain

<http://emailbydomain.com>

Auto manuals search

<http://auto.somanuals.com>

TV manuals search

<http://tv.somanuals.com>