

Digital Wireless Key Telephone System

Installation Manual

MODEL: GDK-20W

REVISION HISTORY

ISSUE	DATE	DESCRIPTION
ISSUE 1.0	1999. 08	Initial Release(Field Test)
ISSUE 1.1	1999. 10	- . Revised Admin Programming. - . Added Section 4. ISDN Description
ISSUE 1.2	1999.12	Revised Page 60 ~ 63.
ISSUE 2.0	2001.04	- . Added notice of [Commission Decision CTR21]. - . Added contents of supplementary sheet
ISSUE 2.1	2001.11	Added GDC-340H wireless terminal and New LCOBs.

Table of Contents

SECTION 1. INTRODUCTION	7
1.1 Purpose	7
1.2 Regulatory Information	7
1.3 Abbreviations	9
SECTION 2. GENERAL DESCRIPTION	10
2.1 Introduction	10
2.2 System Capacity	11
2.3 System Specifications	13
2.4 System Components	15
SECTION 3. INSTALLATION	19
3.1 Introduction	19
3.2 Site Preparation	19
3.3 KSU & POWER Installation	21
3.4 PCB Installation	24
3.5 System Wiring	33
3.6 DECT Installation	37
3.6.1 Overview of the DECT system	37
3.6.2 System Configuration	46
3.6.3 Hardware Installation	56
3.6.4 User subscription/desubscription	60
3.6.5 Summary of the DECT Installation	66
SECTION 4. ISDN DESCROPTION	67
4.1 ISDN Boards in GDK-20W	67
4.2 The Basic Features of ISDN Device(S-Interface)	68
4.3 The Features of ISDN CO Line(T-Interface)	70
SECTION 5. CAPACITIES & FEATURE CODES	72

5.1	System Capacities	72
5.2	Feature Codes	73
5.2.1	Number Plan	73
5.2.2	Basic and Extended Numbering Plans	75
5.2.3	LCD Months	75
5.2.4	Audible Signals	76
5.2.5	Frequencies and Tones	77
5.2.6	GDK-20W Configuration	79
5.2.7	GDK-20W Station Configuration with LKD 2B	79
5.2.8	Maximum Number of Stations in GDK-20W	79
5.2.9	Maximum Number of CO Lines in GDK-20W	79
5.2.10	Maximum Number of Ports(Station/CO) in GDK-20W	80
5.2.11	Wireless Cell / Terminal Configuration	80
5.2.12	Gain Control.....	80

SECTION 6. ADMIN PROGRAMMING 84

6.1	General Description	84
6.1.1	Introduction	84
6.1.2	To Enter the Programming Mode.....	84
6.1.3	How to Program	85
6.1.4	Button Definition	87
6.2	Admin Programming	88
6.2.1	Admin Programming Index	88
6.2.2	Default Values	91

SECTION 1. INTRODUCTION

1.1 PURPOSE

This manual provides the information necessary to install, program, operate, and maintain the LG Digital Wireless Key Telephone System, GDK-20W.

1.2 REGULATORY INFORMATION

TELEPHONE COMPANY NOTIFICATION

Before connecting the GDK-20W to the telephone network, you may be required to notify your local servicing telephone company of your intention to use "customer provided equipment". You may further be required to provide any or all of the following information;

- Number of telephone lines to be connected to the system
- Model name GDK-20W
- Local regulatory agency registration number
- Ringer equivalence
- Registered jack

The necessary information is available from your local LGE representative.

INCIDENCE OF HARM

If the telephone company determines that the customer provided equipment is faulty any possibly causing harm or interruption in service to the telephone network, it should be disconnected until repair can be effected. If this is not done, the telephone company may temporarily disconnect service.

CHANGES IN SERVICE

The local telephone company may make changes in its communication facilities or procedures. If these changes could reasonably be expected to affect the use of the GDK-20W system or compatibility with the network, the telephone company is required to give advanced written notice to user, allowing the user to take appropriate steps to maintain telephone service.

MAINTENANCE LIMITATIONS

Maintenance on the GDK-20W Digital Wireless Key Telephone System must only be performed by the LGE or its authorized agent. The user may not make any changes and/or repairs except as specifically noted in this manual. Unauthorized alternations or repairs may affect the regulatory status of the system and may void any remaining warranty.

NOTICE OF RADIATED EMISSIONS

The GDK-20W Digital Wireless Key Telephone System complies with rules regarding radiation and radio frequency emission as defined by local regulatory agencies. In accordance with these agencies, you may be required to provide information such as the following to the end user.

WARNING :

"This equipment generates and uses R.F. energy, and if not installed and used in accordance with the Instruction Manual, it may cause interference to radio communications. It has been tested and found to comply with the appropriate limits for a telecommunication device. The limits are designed to provide reasonable protection against such interference, when operated in a commercial environment.

Operation of this equipment in a residential area could cause interference, in which case the user, at his own expense, will be required to take whatever measures may be required to correct the interference."

HEARING AID COMPATIBILITY

The GDK-20W Digital Wireless Key Telephone System has been designed to comply with the Hearing Aid Compatibility requirements as defined in Section 68.316 of Part 68 FCC Rules.

Pictures

The pictures in this manual are for illustrative purposes only; your actual hardware may look slightly different.

Interference and Attenuation

The presence of another unsynchronized DECT system(including GDK-20W) or similar system in adjacent buildings may cause a strong interference and disconnection.

A base station and a wireless terminal may interfere with sensitive laboratory equipment, medical equipment, etc.

Interference from unsuppressed engines or electric motors may cause problems. In general, signals are attenuated to some low degrees when they have to pass through any barrier, however, some materials such as metal attenuate much degree.

Electrostatic Sensitive Devices

Boards which contain Electrostatic Sensitive Device(ESD) are indicated by the  sign. The following information is ESD handling:

Service personnel should ground themselves by using a wrist strap when exchanging system boards.

When repairs are made to a system board, they should spread the floor with anti-static mat which is also grounded. Use a suitable, grounded soldering iron. Keep system boards and sensitive parts in the protective package until these are used. When returning system boards or parts like EEPROM to the factory, use the protective package as described.

REPLACEMENT OF LITHIUM BATTERIES

The GDK-20W Digital Wireless Key Telephone System is provided with replaceable Lithium Batteries on PMU for the purpose of protecting SRAM data including the system database and the real-time-clock from power loss. When the authorized Serviceman replaces them, it has to be carefully considered as followings,

CAUTION :

- . Danger of explosion if battery is incorrectly replaced.
- . Replace only with the same or equivalent type recommended by the manufacturer.
- . Dispose of used batteries according to the manufacturer's instructions.

1.3 ABBREVIATIONS

For the purposes of this manual, following abbreviations are applied:

330-SSC, 340-SSC Single-Slot Charger

AC	Authentication Code
ADPCM	Adaptive Differential Pulse Code Modulation
BER	Bit Error Ratio
CCITT	International Telegraph and Telephone Consultative Committee
dBm	dB relative to 1 milliwatt
DECT	Digital Enhanced Cordless Telecommunications
ESD	Electrostatic Sensitive Discharge
FP	Fixed Part
GAP	Generic Access Profile
GDC-200B	Base Station

GDC-335H, GDC-340H Wireless Terminal

GFSK	Gaussian Frequency Shift Keying
IPEI	International Portable Equipment Identity
IPUI	International Portable User Identity
KSU	Key Service Unit
LED	Light Emitting Diode
MBU	Main Board Unit
PARK	Portable Access Right Key
PCB	Printed Circuit Board
PP	Portable Part
PSTN	Public Switched Telephone Network
RF	Radio Frequency
RFPI	Radio Fixed Part Identity
TDD	Time Division Duplex
TDMA	Time Division Multiple Access
WTIB	Wireless Terminal Interface Board

Notice 1:

If this equipment is not equipped with a standby battery supply it will not be possible to make calls to the emergency services when the power fails. Alternative arrangements should be made for access to emergency services.

Notice 2:

The equipment has been approved to [Commission Decision "CTR21"] for pan-European single terminal connection to the Public Switched Telephone Network(PSTN). However, due to differences between the individual PSTNs provided in different countries the approval does not, of itself, give an unconditional assurance of successful operation on every PSTN network termination point.

In the event of problems, you should contact your equipment supplier in the first instance."

SECTION 2. GENERAL DESCRIPTION

2.1 INTRODUCTION

The GDK-20W Digital Wireless Key Telephone System is a fully digital hybrid Key Telephone System, designed to meet the telecommunication needs of small sized business offices & home base.

The GDK-20W System incorporates state-of-the-art digital technology for command processing and voice switching, utilizing a Pulse Code Modulation/Time Division Multiplexing (PCM/TDM) distributed switching matrix. The system supports both "A" and "Mu" law voice encoding rule based on the requirements of local regulations and the ADPCM voice coding to support DECT(Digital Enhanced Cordless Telecommunications) services.

The GDK-20W KSU(Key Service Unit) is wall mounted cabinet that house the MBU(Main Board Unit) and contain card slots for the CO line boards, extension boards and other useful PCBs. There are 6 slots in the system, the 1st fixed slot(slot1) is used to install only the DVIB/DVIBE(Digitized voice interface board) card, the 2nd,3rd fixed slots(slot2, slot3) are used to install one of the LCOB/LCOB2/LCOBE/LCOBA/LCOB4 or STIB/STIB2, the 4th fixed slot(slot 4) is used to install only the PMU(Program Module Unit) card and the 5th fixed slot(slot 5) is used to install the WTIB(Wireless terminal interface board) card. And the 6th fixed slot(slot6) is used to install only the MFB(Multi function board) card.

The GDK-20W System achieves a high level of flexibility by providing support for different types of instrumentation.

The system architecture has been designed to allow a high level of software control over the system's hardware. The software incorporates a vast array of features and capabilities including PC Database Administration, ISDN feature, Remote software downloading, etc.

The GDK-20W System supports a combination of Digital Keysets(LKD, KD, KD/E, KD/S, KD/C series), DECT terminals(GDC-335H, GDC-340H), and various kinds of ISDN terminals as well as analogue single line devices. With the keysets, commonly used features are activated by direct button selection. Additionally, many functions may be accessed by dialing specific codes or optionally, by assigning these dial codes to Flexible Buttons on the keyset. In addition to key telephones, an array of optional terminals is available including Intercom/Door Box

With the flexibility of the GDK-20W extensive feature content and the capability to use an array of instruments, the GDK-20W can be tailored to meet the short and long term needs of the most demanding customer requirements.

* **Note** : The CO board(LCOB/LCOB2/LCOBE/LCOBA/LCOB4/STIB/STIB2), DVIB/DVIBE and MFB are used in common with GDK-16 Digital Key Telephone System.

2.2 SYSTEM CAPACITY

The following Table and Chart provide system capacities and display the system's configuration flexibility.

Table 2.2.1 System Capacities

Description	Basic & Expansion	Total
Time Slots		96
CO Line Ports		Max. 8 (analog CO and/or ISDN BRI)
Max direct Station connections		6(+4 via 2B modules)
Max Stations via 2B modules		4
Max Stations via ISDN So bus		4
Max DECT terminals		20
DSS/DLS Consoles per station		0
Attendant Positions	1-System	
Intercom Links		Non-blocking
Paging		
- All Call		1 zone
- Internal		2 zones
Station Speed Dial	20/station, 24 digits each	20
System Speed Dial	24 digits each	79
Last Number Redial		32 digits
Music Source Inputs	2/PMU	2
External Control Contacts	1/MBU, 1/MFB	2
Alarm Input	1/MBU	1
RS-232C Ports	1/MFB	1
DTMF Receivers	2/PMU	2
CO Line Groups		4
Intercom Groups		4
Conference	3-party	no limit

*** Note**

1. Not all maximum capacities may be achieved simultaneously.
2. DECT terminals can be registered and used up to 20 stations. But GDK-20W system supports the only four(4) simultaneous calls basically because the MBU has one wireless terminal interface circuit. When WTIB card is installed to SLOT5, the number of simultaneous calls is increased up to the twelve(12)(One base station provides the four(4) simultaneous calls.). The WTIB has the two(2) wireless terminal interface ports.
3. One RS-232C port can be installed in the position of the MFB. The purpose of RS-232C port can be programmable in Admin station programming. It is recommended that the RS-232C serial cable whose length is below 10 meters is used.

Note : This Configuration Chart is made up according to the physical capacity of system.

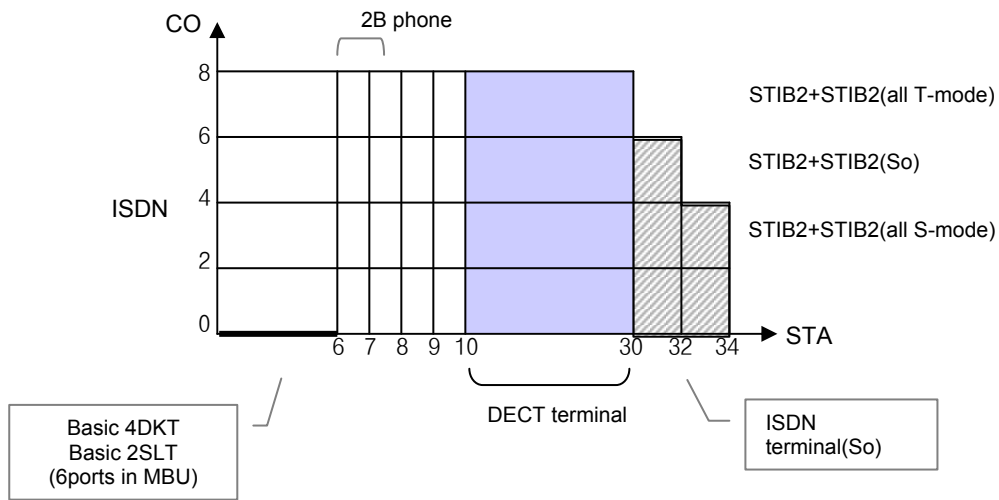

1) GDK-20W System Configuration Chart with STIB/STIB2(ISDN Board)

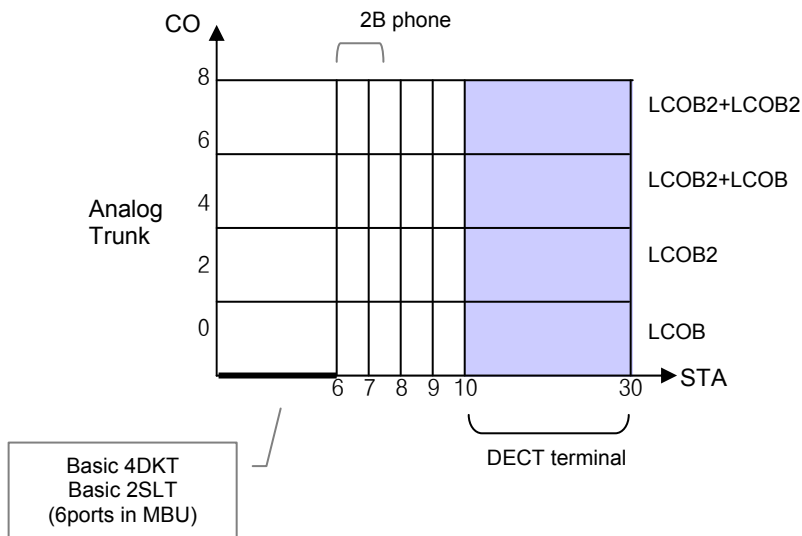

2) GDK-20W System Configuration Chart with LCOB(or LCOBE, LCOBA)/LCOB2(or LCOB4)

FIGURE 2.2.1 GDK-20W System Configuration Chart

2.3 SYSTEM SPECIFICATIONS

The following Tables provide general system specifications.

Table 2.3.1 Dimensions & Weights

Item	Height	Width	Depth	Weight
Key Service Unit	346mm 13.6in	246mm 9.7in	90mm 3.5in	3.6Kg
Digital Key Set	236mm 9.3in	192mm 7.6in	84mm 3.3in	1.5 Kg
Digital ICM/Door Box	45mm 1.8in	140mm 5.5in	100mm 3.9in	0.5 Kg
Base station	170mm 6.7in	220mm 8.7in	57mm 2.2in	420g
DECT terminal	145mm 5.7in	50mm 2.0in	35mm 1.4in	169g

Table 2.3.2 Environmental Specifications

Item	Degrees C	degrees F
Operating Temperature	0-50	32-122
Optimum Operating Temperature	20-26	68-78
Storage Temperature	0-70	32-158
Relative Humidity	0-85% non-condensing	

Table 2.3.3 Electrical Specifications

Power Supply : * Note 1. -. AC Voltage Input -. AC Power -. AC Input Fuse -. DC Output Voltages	220~240 Volts AC @ 50~60Hz. 60W T800mAH 250 V +5, -5, +30Volts(28-35V)
Back-up Battery : -. Battery Back-up Voltage -. Battery Back-up Fuse -. Charging Current -. Battery load Current	24 Volt DC T5AH 250V Max. 100mA Max. 1A(with Analog CO or ISDN CO)
Ext. Relay Contacts	3 A @ 30 Volt DC
Music Source Input	600 ohm @ 0 dBm
STIB & STIB2 Power	Max. 3W(40Volt DC, 80mA)

*** Note 1. For European Countries : This product is also designed for IT power system with Phase to Phase 230V.**

Table 2.3.4 Electrical Specifications

Item	22 AWG Wire	24 AWG Wire
Digital Keypad / Base station - 2-wire loop	500 m (1.6K feet)	300 m (1K feet)
2B modules(with Power Adapter,24Vdc/200mA) - System – Primary Keypad - Primary Keypad – Secondary Keypad - Primary Keypad – Secondary SLT	Refer to Installation Manual of 2B-SLIU30/DTIU30	
2B modules(without Power Adapter) - Primary Keypad – Secondary Keypad - Primary Keypad – Secondary SLT	Refer to Installation Manual of 2B-SLIU30/DTIU30	
Single Line Telephone	1,600 m (5.3K feet)	1,000 m (3.3K feet)

Table 2.3.5 CO Loop Specifications

Ring Detect Sensitivity	@ 20-60 Hz, 38 Vrms
DTMF Dialing - Frequency Deviation - Signal Rise time - Tone Duration, on-time - Interdigit time	less than $\pm 1\%$ 3 msec, maximum 75 msec, minimum 75 msec, minimum
Pulse Dialing - Pulse Rate - Break/Make Ratio	10 pps 60/40% or 66/33%

Table 2.3.6 Miscellaneous Specifications

Main System Memory	
Program Memory, (FLASH MEMORY)	1 Mwords Max. PMU U1 : 512Kwords U2 : 512Kwords
Random Access Memory, SRAM (Battery Backed-up)	512Kbytes Max. PMU U3 : 256Kbytes U4 : 256Kbytes

2.4 SYSTEM COMPONENTS

Item	Slot Position	Circuit Number	Description	Remark
GDK-20W KSU(MBU)			4DKT + 2SLT + 1 WTI	
DVIB	1	2	Digital Voice Interface	
DVIBE	1	2	Digital Voice Interface + DTMF Receiver 2EA	
LCOB4	2,3	4	Loop Start CO Interface	PRU4, PRCPTU
LCOBA	2,3	2	Loop Start CO Interface	PRU4, PRCPTU
PRU4	LCOB4/ LCOBA	4	Polarity Detect 4 ports	
PRCPTU4	LCOB4/ LCOBA	4	Polarity Detect 4 ports + Call Progress Tone Detect 4 ports	
LCOB	2,3	2	Loop Start CO Interface	
LCOBE(SP)	2,3	2	Loop Start CO Interface (Call Progress Tone Detect 2 ports)	
LCOBE(w/PRU)	2,3	2	Loop Start CO Interface (Polarity Detect 2 ports)	
LCOB2	2,3	4	Loop Start CO Interface	
STIB	2,3	1(2B)	ISDN 1So/To Interface	
STIB2	2,3	2(4B)	ISDN 1So/To + 1To Interface	
PMU	4		Program Module Unit	
WTIB	5	2	Wireless Terminal Interface(2 WTI)	
MFB	6		Battery Changing, RS-232C, Auto FAX	
DVEU	DVIB/ DVIBE		Voice Memory Expansion Unit	

Key Service Unit (KSU)

The KSU is a plastic cabinet designed for wall mounting. The KSU contains a MBU(Main Board Unit) and POWER Transformer and Mechanical parts.

Main Board Unit (MBU)

A Power Supply Circuit is required in the Key Service Unit. The Power Supply Circuit converts local AC power(220~240V AC @ 50~60Hz) to DC voltages, regulates the voltages, and provides the appropriate DC voltages to the MBU for distribution to other system components. Three DC outputs are provided : $\pm 5V$ DC, +30V DC.

The MBU, incorporates, master clock, one alarm detection circuit, one general purpose relay, watchdog circuitry and 4 ports digital terminal interface circuits and 2 ports SLT circuits as well as the system's PCM voice processing and main micro-processor. And the MBU contains one wireless terminal interface circuit that is used to install one base station to support 4 simultaneous DECT calls.

The micro-processor is a 16 bit high speed CPU that receives and transmits signaling information from/to other PCBs, controls feature activation, and PCM time-slot interchange. For digital voice processing, two ROM's contain PCM tone, gain table, etc.

There are two commonly used slots, SLOT2 and SLOT3, and four fixed slots for extending the system capacity. From the left side, the SLOT1 is used to install the DVIB/DVIBE. The SLOT2 and SLOT3 are used to install LCOB2/LCOB/LCOBE/LCOBA/LCOB4 and STIB2 / STIB. The SLOT4 is used to install the PMU basically. The SLOT5 is used to install the WTIB and the SLOT6 is used to install the MFB.

The permitted terminals are as following.

Keypad: KD-36D, KD-36N, KD-24D, KD-24N
KD/E-36EXE, KD/E-36ENH, KD/E-24EXE, KD/E-24ENH, KD/E-8BTN
LKD-2NS, LKD-8DS, LKD-30DS, etc

DECT terminal: GDC-330H, GDC-335H, GDC-340H

Program Module Unit (PMU)

The PMU is installed to SLOT4 basically and incorporates the system's memory, one internal and one external MOH ports, Real time clock circuit and two DTMF receivers. Each receiver is time-shared under the control of the system software.

The LEDs in upper side of the PMU panel indicates system's power on/off state and data communication state. Also, the PMU contains 512Kbytes of RAM and 1Mwords of Flash memory.

The RAM associated with the system database and the real-time-clock is protected from power loss by a long life high energy lithium battery.

Two(2) Flash memory(U1 & U2, 512Kwords respectively) contains the basic system operating software.

Ring Generation Unit(RGU)

The GDK-20W system provides two kinds of ring signals. One is 50Hz sine wave signal generated from power transformer, another is 25Hz square wave signal from RGU.

The RGU is installed to connector, CN23, of MBU and generates 75Vrms ring signal that can be applied to the two(2) SLTs simultaneously.

Multi Function Board (MFB)

The Multi Function Board(MFB) Provides a RS-232C interface port with 9 pin connector. The maximum baud rate is 38400bps. The MFB is useful for system maintenance, PC based admin, SMDR print out and local software up-grade. It is recommended that the RS-232C serial cable whose length is below 10 meters is used.

The MFB includes circuitry for float charging an externally connected 24 volt battery and controls the operation of the battery back-up circuits. And the MFB will provide system operating voltages from the

battery if local AC power fails. In addition, circuitry is incorporated in the MFB to disconnect the battery when it is in deep discharge.

The MFB includes circuitry for Fax Tone Detection. By Admin-program, User use the MBU SLT Port 1 as Fax port instead of Analog CO port.

Fax Tone Detection Circuit & Function is supported from the MFB Issue 2.

The MFB includes one External Relay for General purpose.

MFB can be installed on the SLOT6.

Wireless Terminal Interface Board (WTIB)

The WTIB provides two(2) base station interface circuits and two(2) DSP circuits.

Base station interface circuits are used to connect base stations which interface wireless terminals(GDC-330H, GDC-335H, GDC-340H) based on DECT specifications.

The DSP circuits perform 8 channels of ADPCM conversion with integral echo canceling and echo suppression.

WTIB can be installed on the SLOT5.

CO Line Interface Board – Loop Start (LCOB2/LCOB/LCOBE/LCOBA/LCOB4)

There are Analog CO/PABX Line interface(Loop-start line interface) boards that is installed at the SLOT2 & SLOT3.

These boards has 2 CO/PABX Loop Start Lines and 4CO/PABX Loop Start Lines with ring and loop current detection, A/D and D/A conversions, and pulse signaling.

S/T Interface Board (STIB2)

The S,T interface is based on the existing interface described in ETSI 300. 012 which is based upon ITU_T Recommendations I.430 and provides modifications and further requirements.

This is applied at the S or T reference points for the basic interface structure defined in ITU_T I.412. Layer 1 interfacing requires a balanced metallic transmission medium, for each direction of transmit capability to support 192Kbps(2B+D). For interface circuits, one per transmission direction, are used for transmit digital signals. Data & bit clock are transmitted by the NT master and extracted by TE slave. The GDK-20W system can be positioned at reference point Ia or Ib on ETS 300. 012 that is TE-slave without power feeding or NT-master with power feeding. By selecting the short pin and DIP switch on each line interface, the STIB can support either S0-interface (Line card function) or T-interface (Trunk function).

The board line's specific circuitry contains PEB2086 for Physical layer and data link layer.

This board is comprised of one T only port and one S/T Switchable port.

STIB2 can be installed on the SLOT2 and SLOT3.

S/T Interface Board (STIB)

The S,T interface is based on the existing interface described in ETSI 300. 012 which is based upon ITU_T Recommendations I.430 and provides modifications and further requirements.

This is applied at the S or T reference points for the basic interface structure defined in ITU_T I.412. Layer 1 interfacing requires a balanced metallic transmission medium, for each direction of transmit capability to support 192Kbps(2B+D). For interface circuits, one per transmission direction, are used for transmit digital signals. Data & bit clock are transmitted by the NT master and extracted by TE slave. The GDK-20W system can be positioned at reference point Ia or Ib on ETS 300. 012 that is TE-slave without power feeding or NT-master with power feeding. By selecting the short pin and DIP switch on each line interface, the STIB can support either S0-interface (Line card function) or T-interface (Trunk function).

The board line's specific circuitry contains PEB2086 for Physical layer and data link layer.

This board is comprised of one S/T Switchable port.

STIB can be installed on the SLOT2 and SLOT3.

DVIB (Digitized Voice Interface Board)

- DVIB provides 2 channel Record/Play
- DVIB provides Time & System prompt
- All message are saved in Flash memory
- Max record time : Without DVEU (68 Minutes), With DVEU(136 Minutes)
(DVIB: 68 Min, DVEU: 68Min)
System/time stamp: 8 Min
User record time: 128 Min
- Max. Number of User Voice Message : 400ea(With DVEU)
(DVIB: 200ea, DVEU: 200ea)
- DVEU(Digitized Voice Expansion Unit) : Optional PCB of DVIB

* **Note:** User Greeting does not lost by system power off or reset because of this message is stored in FLASH memory
MBU SW1-1 controls the protection of recorded messages.

DVIB should be installed on SLOT1.

SECTION 3. INSTALLATION

3.1 INTRODUCTION

As with any sophisticated communications device, installation of the GDK-20W System requires the care and fore-thought of a competent technician. Installation proceeds in 4 major steps:

- Site Preparation
- KSU Installation
- PCB Installation
- System Wiring
- DECT Installation

3.2 SITE PREPARATION

General Site Considerations

The first step is to locate an acceptable site for the common equipment.(KSU, boards, etc.)
When locating a mounting site for the KSUs, the following points must be considered:

1. The KSUs are designed for wall mounting and should not be mounted directly to a masonry or plaster board wall. It is recommended that a ½ inch thickness plywood back-board be firmly mounted to the wall first and then the KSU.
2. The location must have access to 220~240 Volt AC, 50 - 60 Hz with a circuit breaker or fuse rated at 15 amps. A 3-wire parallel blade grounded outlet should be within approximately 2 meters (6 feet).
3. The location must have access to a good earth ground, such as a metallic cold water pipe with no non-metallic joints. The ground source should be located as close as possible to the system.
4. The system should be located in an area which is well ventilated with a recommended temperature of 20 - 26 degrees C (68 - 78.8 degrees F) and a relative humidity of 5 - 85 % (non-condensing).
5. The system should be located within 8 meters (25 feet) of the telephone company's termination point. Also, the location should be within the prescribed station loop lengths for all keysets and terminals. If existing cabling is to be employed, the location of existing cabling and conduits should be considered.
6. The location should have adequate accessibility, space and lighting for future servicing and should consider the need for future expansion.
7. The site should be away from radio transmitting equipment, arc-welding devices, copy machines, and other electrical equipment capable of generating electrical interference. The system should be protected from flooding and heavy machinery as well as excessive dust and vibration.

Back-Board Installation

A wooden backboard is recommended for all installations and must be installed when the location has masonry or plasterboard walls. A $\frac{1}{2}$ inch plywood material is sufficient for most installations. The back-board should be mounted at a convenient height, about 1 meter above the floor, and be bolted in two number of places to distribute the weight of the system.

Verify On-Site Equipment

Once the equipment installation site has been identified and a dedicated earth ground, and lighting and ventilation are available, verify that all equipment required are on-site and have not been damaged during shipment. Assure there is no shipping damage. Note that a mounting template is packed with KSU and this template will be required later in the installation. Check that the type and quantity of boards received is correct and optional equipment are on-site.

If any equipment is damaged or missing, notify appropriate personnel to correct the situation.

3.3 KSU & POWER INSTALLATION

GDK-20W system consists of KSU, some optional boards, and peripheral instruments. The exterior view of the GDK-20W is shown in Figure 3.3.1.

Figure 3.3.1 GDK-20W Exterior View

Mounting the KSU

The KSU is a plastic frame cabinet designed for wall mounting. Employing the KSU mounting template provided with the KSU, mark the location of the two screws to mount the KSU. Again, the KSU must not be mounted on a masonry or dry-wall surface, in this case a wooden backboard is required, refer to paragraph **[Back Board Installation]**. The distance between mounting holes is shown in Figure 3.3.2.

The KSU is mounted with two #10 or larger, 1.5 inch or longer screws. First, drill pilot holes in the two locations marked, insert the screws and tighten leaving about 0.5 inch exposed. Hang up the KSU on the screws and tighten the KSU.

Figure 3.3.2 KSU Mounting Holes & Installation layout

Power Installation

The Power Supply Circuit of the MBU provides power for the system boards and telephones, converting the AC Input Voltage to appropriate DC voltages. Before installation, assure that the AC power cord is **NOT** plugged into the AC INLET. The Power Supply Circuit is located on the left upper side of the MBU.

The GDK-20W Power can only operate 220~240V AC based on the connection of the cable(4-wired) by the CN22 from transformer and the connection of the cable(2-wired) by the CN21 to transformer.

Input Voltage	Connect to	Fuse
230V(+10%, -15%)	CN21	T800mAH 250V

* **Caution : the GDK-20W Power can not operate with 110~127V AC.**

KSU Grounding

The GDK-20W mains lead must be connected to a building mains supply that includes an earth connection in conformance with current IEE requirements.

Earthing is required for user safety and to minimize EMC interference.

If does not connected mains earth, to ensure proper system operation and for safety purpose, a good earth ground is required. A metallic COLD water pipe usually provides a reliable ground. Carefully check that the pipe does not contain insulated joints that could isolate the ground path. If insulated joints exist, another earth ground source must be used or, if allowed, the joints may be bridged.

A #14 AWG or larger copper wire should be used between the ground source and the connector, CN27, of the KSU. The wire should be kept as short as possible, it is recommended that the wire be no longer than 8 meters.(about 25 feet)

3.4 PCB INSTALLATION

PCB Handling & General Installation

All boards should not be installed or removed while power applied.

Power must be turned off prior to insertion or removal of the PCB.

The system PCBs contain digital circuitry which can be damaged by exposure to excessive static electricity. When handling PCBs, a grounded wrist strap should be used to protect the boards from static discharges. Also, use common sense when handling the PCBs. For example, do not place a PCB in locations where heavy objects might fall on the PCB and damage components.

To insert a PCB, hold the PCB and, with component side facing right, insert the card into the MBU's din connector firmly and tighten. To remove a PCB, reverse the procedure. Installation method of PCB is shown in Figure 3.4.1.

Figure 3.4.1 PCB Installation

There are 6 slots in the GDK-20W system for extend or modify the system configuration. But, there are some restrictions when optional board installation. Note that the system can not operate properly with wrong installation. The SLOT1 of the MBU is reserved only for DVIB/DVIBE, the SLOT2 & SLOT3 is reserved for LCOBs or STIB2/STIB, the SLOT4 are reserved only for PMU and the SLOT5 and SLOT6 is reserved for WTIB and MFB, respectively. To summarize, see the following table 3.4.1.

Slot No.	Cards	Remark
SLOT1	DVIB, DVIBE	Fixed slot for DVIB
SLOT2	LCOB2, LCOB, LCOBE, LCOBA, LCOB4, STIB2, STIB	Option board for LCO, ISDN
SLOT3		
SLOT4	PMU	Fixed slot for PMU(Basic)
SLOT5	WTIB	Fixed slot for WTIB
SLOT6	MFB	Fixed slot for MFB

[Table 3.4.1] Option Boards Installation Table

When the system power on, the default slot assignment is automatically redefined according to board installation status.

Main Board Unit (MBU) Installation

The MBU is installed in the KSU default. It comprised of main processor, four(4) Digital Terminal interface circuits, two(2)

Single Line Telephone interface circuits, six(6) card slots for optional boards, one(1) Wireless terminal interface circuit and data communication circuit which transmits and receives to/from other cards. The MBU is equipped with one basic card; a PMU for program memory, data memory, and etc. Refer to Figure 3.4.2.

Figure 3.4.2 MBU Installation

The MBU provides screw-down terminal blocks that is used to connect the peripheral instruments; Keyset, SLT, Base station, and etc. Four(4) DKTUs are connected to MBU through terminal block, CN18, and two(2) SLTs are connected to the **SLT1** & **SLT2** ports of terminal block, CN19. The connection between MBU and base station is performed through the **WTI1** port of terminal block, CN19. All of peripheral instruments are installed by using twisted one pair copper line.

Figure 3.4.3 RGU connector and protection switch setting

Following table shows the connector and switch on GDK-20W MBU.

Switch		Description	Remark
ISSUE 1	Manufacturer setting		
CN23		Pin 1&2 short: 50Hz ring signal(sine wave)	Dependent on country adaptation.
		RGU plugged: 25Hz ring signal(square wave)	
SW 1	1-1 (OFF)	ON: For database protection.	Turn ON the switch after system power on.
		OFF: For system default.	
	1-2 (OFF)	OFF : Loop back OFF	OFF (Always)

The MBU has a two position DIP switch(SW1). The following is the function of each switch position :

- Knob 1 System data base initialization when power on**
 - On : Do not initialize system data base when power on.
 - Off : Initialize system data base when power on.
- Knob 2 ISDN Loop Back on**
 - On : Loop Back on
 - Off : Loop Back off

Before programming the system, SW1(knob 1) should be placed in the Off position and turn the system power off and on to initialize the system database to default. Once the database has been initialized, SW(knob 1) should be placed in the on position to protect the database in the memory. Refer to Figure 3.4.3.

PMU Installation

The PMU must be installed to SLOT4 on the MBU basically for the system operation. Refer to Figure 3.4.2. The PMU contains a lithium dry-cell to keep the memory contents and real-time clock functions during power off. The battery is soldered to the PMU, and connected circuitry by an on/off DIP switch(SW2). So **the DIP switch knob must be ON** position before the PMU installation.

The PMU provides two kinds of MOH sources, internal MOH and external MOH. External MOH source is input through black screw-down terminal, CN5, on the PMU. Refer to Figure 3.4.4.

And there are five red LEDs on the PMU, the function of them are as follows.

- LD1 Display system software operation**
-. This LED will turn on and turn off at every 100 msec.
- LD2 Display task changing (software testing purpose)**
-. This LED will be turn on/off toggle when call task changing.
- LD3 Display task changing (software testing purpose)**
-. This LED will be turn on/off toggle when timer task changing.
- LD4 Indication for DKT data comm. error**
-. This LED will be turn on/off toggle for keyset data comm. Error.
- LD5 Display task changing**
-. This LED will be turn on/off toggle when DECT task changing.

Figure 3.4.4 PMU Installation

RGU Installation

The RGU generates 25Hz square wave ring signal.

The RGU is installed to connector, CN23, of the MBU and generates 75Vrms ring signal that can be applied to the two(2) SLTs simultaneously.

Figure 3.4.5 RGU Installation

MFB Installation

The RS-232C of MFB board is used for the function of system maintenance, PC based Admin, SMDR print local software up-grade.

The Followings are the list of the system's output.

- . Administration data base
- . Off-Line SMDR(on-demand)
- . On-Line SMDR
- . Statistical Information
- . System Trace data

The installation method is shown in Figure 3.4.6.

Figure 3.4.6 MFB installation

Analog CO/PABX Line Interface Boards (LCOB: Loop-start) Installation

The LCOB2, LCOB, LCOBE, LCOBA, and LCOB4 can be installed on the SLOT2 & SLOT3

The exterior of them are shown in Figure 3.4.7.

This board provides two(2) Loop Start ports and four(4) Loop Start ports.

Board	Slot	Port No.
LCOB2, LCOB4	SLOT2 & 3	4
LCOB, LCOBE, LCOBA	SLOT2 & 3	2

[Table 3.4.2] LCOBs

Figure 3.4.7 Analog CO Interface Boards

ISDN STIB2 & STIB (S/T Interface Board) Installation

It should be noted that the STIB2 & STIB board should be installed on the SLOT2&SLOT3 of the MBU.

The STIB2 provides 1 port of BRI(Basic Rate Interface-'T' mode only) and 1port of 'S' and 'T' mode Switchable interface and STIB provides 1 port of 'S' and 'T' mode Switchable interface.

Select the jumpers and DIP switches for S0 or T0 interface. **Be sure to connect ISDN trunk to T0 interface port and ISDN extension to S0 interface port.** Check if ISDN trunk is not connected to S0 interface port and ISDN extension is not connected to T0 interface port.

The mode selection method is shown in table 3.4.3.

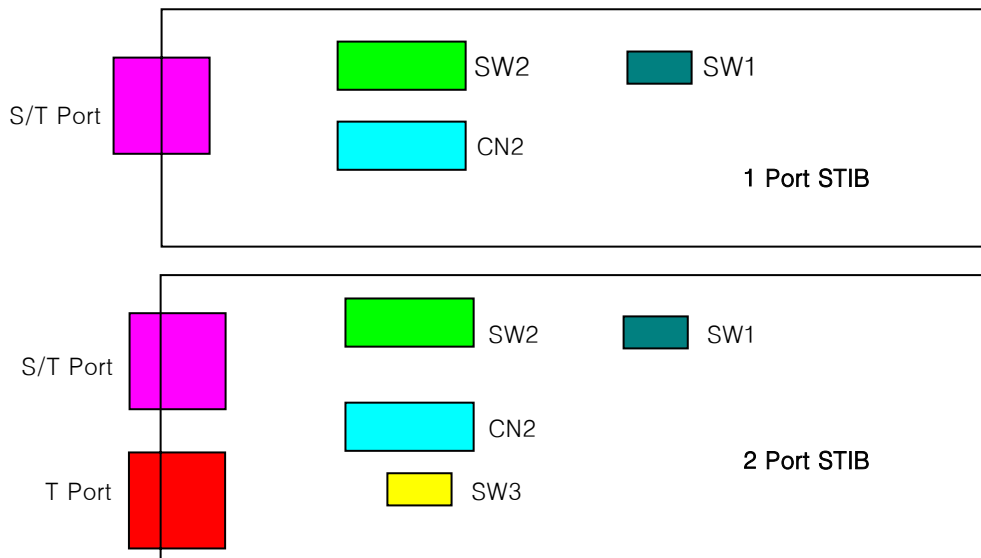

Figure 3.4.8 Switches and connector for the STIB

Jumper/ Switch	Manufacture Setting (T mode)	Description	Remark
SW1 & CN2	SW1 :OFF CN2 : T position	S0 or T0 interface mode selection for the port and PEB2086 device respectively.	
SW2	Pin1-2: OFF Pin3-4 : ON	#1 and #2 : External Power feeding ON/OFF. #3 and #4 : Termination Resistor ON/OFF	
SW3	ON	Termination Resistor ON/OFF	Only for T0 interface.

(a) Selection Method

Port	Connector & Switch	Mode	Selection Method
So/To (CO1-2 or 2So station 130-131)	SW1 SW2 CN2	T	Move short pins to CN2's 'T' position Move SW1, SW2 to 'T' position(OFF)
		S	Move short pins to CN2's 'S' position Move SW1, SW2 to 'S' position(ON)
To (CO3-4 or 1-2)	SW3	T only	Move SW3 to ON position

(b) Port meaning for STIB2 of SLOT2

[Table 3.4.3] S/T Mode Selection Method

Figure 3.4.9 STIB2

It is noted that the 'PWR' and the 'R' markings on the STIB2 & STIB card are switched with above figure.

WTIB (Wireless Terminal Interface Board) Installation

The WTIB provides 2 ports of base station interfaces. The connection between the WTIB and base stations(GDC-200B) are performed through TERMINAL BLOCK(CN1) by using twisted one pair copper line.

The exterior of the board is shown in Figure 3.4.10.

It should be noted that the WTIB board could be installed on the SLOT5.

Figure 3.4.10 WTIB

DVIB (Digitized Voice Interface Board) Installation

The DVIB provides 2 voice channels. The maximum record time of a DVIB without DVEU(Digitized Voice Expansion Unit) is 68 minutes and if a DVEU is installed, additional 70 minutes is added to the maximum record time. And the protection of recorded messages is controlled by MBU SW1-1.

MBU	Description	System message	User message
SW1-1	OFF : for system default	Not deleted	Deleted
	ON : for database protection	Not deleted	Not deleted

[Table 3.4.4] Protection of recorded messages

The DVIB board should be installed on the SLOT1 of MBU. And the DVEU board should be installed correctly on the CN4 and CN5 of DVIB. If the boards are incorrectly installed, DVIB or DVEU may be operated abnormally or damaged.

The connectors of a DVIB board is shown in figure 3.4.11. CN2 is used for the trace of a DVIB board using a trace data monitor tool(GDK-TRC1). CN4 and CN5 are used for a DVEU installation. CN1 is inserted on SLOT1 of MBU and CN3 is used for a test.

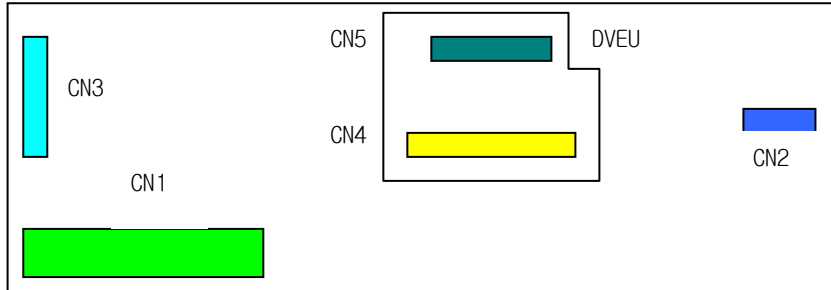

Figure 3.4.11 Connectors of the DVIB

Figure 3.4.12 DVIB

3.5 SYSTEM WIRING

Battery Back-Up Wiring Installation

The system can be equipped with external batteries for proper operation when local AC power fails. The Back-Up batteries are connected to the connector(CN3) of the MFB.

The External batteries must provide 24 Volts DC. This is generally accomplished by connecting two 12 volts batteries in a series arrangement. Battery operation is controlled by the MFB. The MFB will provide charging current(maximum 0.5 amp) to the batteries during normal AC power operation. The MFB will automatically stop the battery operation when AC power re-applied or low battery voltage detected.

The system operating time by external batteries is depend on several elements as follows, battery charge state, condition of the batteries, capacity of the batteries, and the system configuration(number of station ports).

The MFB has one industry standard 9 pin RS-232C connector. The RS-232C ports are connected by 9-pin connectors as shown Figure 3.5.2. Note that the communication settings are 9600bps(Max 38400bps), 8 bit data, no parity bit and 1 stop bit.

The RS-232C port only provides three(3) control signals such as TXD, RXD and ground.

It is recommended that the RS-232C serial cable whose length is below 10 meters is used.

Batteries are connected to the connector(CN3) of the MFB, as shown in Figure 3.5.1.

Warning :

- Carefully check the battery polarity with cable colors(RED and BLUE) when connecting the battery to system.
- It is recommended to use a fuse(5A @250V) between battery and system.
- Recommended battery capacity is 24V/10AH MF battery. The system will operate more than 5 hours with this battery.

Figure 3.5.1 Battery Back-Up Wiring

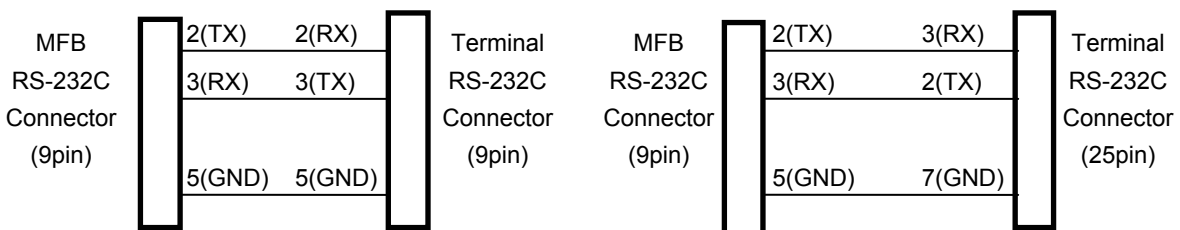

Figure 3.5.2 RS-232C 9-pin Connector Wiring

But, for ISDN line connection, it is done by using the RJ45 type connector on the ISDN interface cards(STIB2, STIB).

Music on Hold (MOH) Wiring

The GDK-20W System sends internal or external music signal to CO lines that are in hold state. The default music source input is assigned to internal source. And the external music source can be used by changing the system database and connect a external music source to the blue colored TERMINAL BLOCK(CN2) of the PMU.

General Purpose Relays Wiring

There are two general purpose relays in the GDK-20W system. One contact is provided in the MBU and is connected through CN22 pin#1,2 (RELAY1) and another contact is prepared in the MFB and is connected through CN2 pin #1, 2(RELAY2). The control of these relays are done by system programming..

Also, this dry relay contact can be used to Loud Bell Control function, Door Open function, etc. under the software control. Note that the maximum rating of the relay contact is 30Volt/3A, so, do not use over this rating.

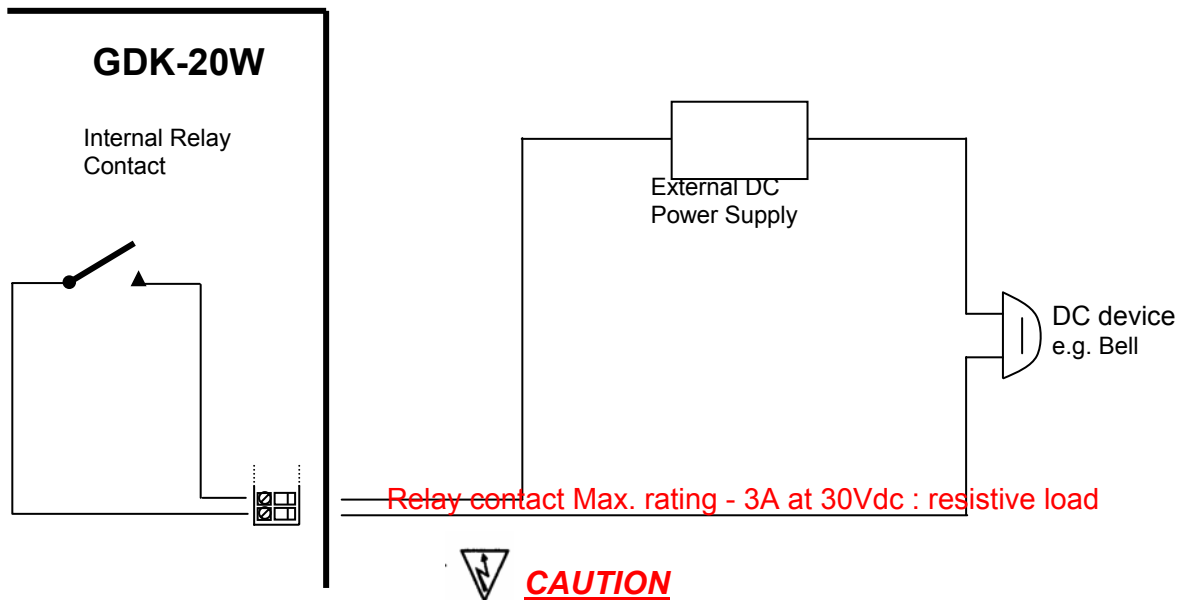

- It is possible to cause danger of high voltage and electric shock.
- "From external source - take all appropriate safety precaution if over 50V AC"

Alarm Detect Port Wiring

One external alarm detect input port is provided from the TERMINAL BLOCK CN22(pin#3,4) of the MBU. This port is used for notify to extensions when the external switch on/off. The connection example is shown in Figure 3.5.3. Close or open detection is programmable by administration programming.

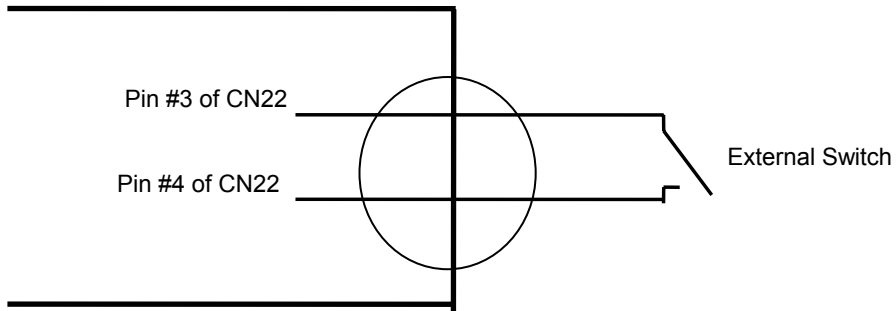

Figure 3.5.3 External Switch Wiring Example

Ferrite Core Installation

A ferrite core is provided in the package of the KSU. Ferrite core should be installed when wiring MBU, CO board, and WTIB.

Ferrite core is used to proof the EMI and to protect the system from the impulse noises.

Ferrite core should be installed on signal wires as **Figure 3.5.4 Ferrite core on signal wires.**

Figure 3.5.4 Ferrite core on signal wires

3.6 DECT Installation

3.6.1 Overview of the DECT system

The wireless standard of the GDK-20W system is DECT(Digital Enhanced Cordless Tele-communications).

The components of the DECT system are a WTIB, base stations and wireless terminals. The GDK-20W system has the three wireless terminal interface ports that is used to connect three(3) base stations. One port is prepared in the MBU, the others are provided by WTIB that is installed to SLOT5 of the MBU optionally.

Base stations are installed throughout a facility to relay calls between wireless terminals and the GDK-20W office telephone system. **The GDC-335H and GDC-340H are wireless terminals.** The wireless terminal users have access right to the office telephone system (GDK-20W) feature in addition to being free to make and calls away from their desks. The wireless terminal is small, light and easy to use. It also provides a display for alphanumeric information .

3.6.1.1 Components of the DECT system

The components of a DECT system are;

- GDK-20W Digital Wireless Key Telephone System
- WTIB(option) card
- Base Station (GDC-200B)
- **Wireless Terminal (GDC-335H, GDC-340H)**
- **Charger (330-SSC, 340-SSC)**

Figure 3.6.1 shows components of the DECT system. The GDK-20W Digital Wireless Key Telephone system includes WTIB card.

GDK-20W Digital KSU

GDC-335H, GDC-340H
(Wireless terminal)

330-SSC, 340-SSC
(Single-Slot Charger)

GDC-200B
(Base Station)

Figure 3.6.1 Components of a DECT system

A. GDK-20W Digital Wireless Key Telephone System

The MBU has one(1) wireless terminal interface port that is used to connect one base station.

B. WTIB (Wireless Terminal Interface Board)

The WTIB has two(2) wireless terminal interface(WTI) ports and can support the two(2) base stations. The WTIB should be plugged into the **SLOT5** of the MBU.

C. Base Station (GDC-200B)

The base station should be installed indoors and protected by surge because it is designed for indoor station. It has a RF(Radio Frequency) Module(transmitter and receiver) that handles communication with wireless terminals through the air link. It can be connected to a GDK-20W system via Wireless terminal interface ports. Each base station provides similar coverage for a particular area call as a cell, and supports four(4) simultaneous calls (four traffic channels). However, since individual wireless terminals are not continuously in call, the system may support more than four wireless terminals:

In the GDK-20W system, Maximum 20 wireless terminals can be registered.

Base stations may be mounted on walls or desktops up to 300 meters away from the GDK-20W system using twisted one pair cable (0.5 ϕ , AWG 24). They are remotely powered (DC 30 volts) by the wireless terminal interface circuit.

The number of base stations used in a system depends on the area to be covered and the traffic density. The typical in-house coverage is a 40 meter radius. In practice the cell size may vary between 10 meter indoors in worst case situation, up to 200 meters outdoor in free space.

D. Wireless Terminal (GDC-335H, GDC-340H)

It is designed for ease-to-use. The LCD shows various call-information, and the keypad has a 12-dial pad and additional keys that facilitate wireless terminal.

E. Single Slot Charger (330-SSC, 340-SSC)

The battery of a GDC-335H is charged by a 330-SSC and the battery of a GDC-340H is charged by a 340-SSC.

3.6.1.2 How to make Calls

A. Before Making Initial Call

It is similar to other calls in a telephone system to make a call in the DECT system except that every call to or from a wireless terminal involves establishing a RF link to the wireless terminal through a base station. In an idle status, a wireless terminal scans a dummy bearer from base stations and locks to the base station with the strongest signal. The dummy bearer is similar to the control channel in a cellular telephone system. If the wireless terminal can not synchronize to a dummy bearer, it can not make a call.

System ID(PARK) is very important in the DECT calls. The Base stations should be assigned to a unique GDK-20W DECT ID(PARK). Wireless terminals should be programmed with a system ID that matches a particular GDK-20W DECT system before communicating with a base station in the system.

Calls to Wireless Terminal

The DECT system receives a call from an extension of the system.

To locate the called party, the DECT system sends a request containing the ID of the called wireless terminal to all base stations.

The called wireless terminal responds to the base station onto which it is locked.

The RF link is established. The call then proceeds like other calls in the office telephone system.

Initiated Call from a Wireless Terminal

The wireless terminal locks onto a base station and initiates a RF link.

The base station transmits call information to the DECT system. The call then proceeds like other calls in the office telephone system.

B. Controlling a Call

During a call, interaction occurs mainly between the wireless terminal and a DECT. The wireless terminal accepts input at the keypad by user and sends the information to a DECT via base station. The DECT handles most of signaling functions and controls the display of wireless terminal.

C. Terminating a Call

Call termination involves releasing a voice channel and transiting a wireless terminal to a standby status. When DECT recognizes that a call has terminated, it sends a release message to a base station. The base station and wireless terminal are released.

In some cases, the base station should initiate call termination by sending a message to the DECT. Loss of wireless terminal power and interference with the RF signal are examples of events that cause the base station to terminate a call abruptly.

3.6.1.3 GDK-20W DECT

A. WTIB

The WTIB is installed to the SLOT5 of the MBU and has the two(2) wireless terminal interface ports. Figure 3.6.2 shows the layout of the WTIB.

Figure 3.6.2 WTIB

B. Base Station

Figure 3.6.3 shows a base station.

Figure 3.6.3 Base Station

Base stations may be mounted on wall or desktop up to 300 meters away from the wireless terminal interface ports using a twisted one pair cable(0.5 ϕ). The system supports max. three base stations.

In typical office environments, each base station has a broadcast range of 50 meters and supports an area of 8,000 square meters. In settings where the absence of any obstruction provide perfect line of sight conditions between a base station and wireless terminal users and there are no atmospheric limitations, the range may increase to max.200 meters.

LEDs on the PCB of a base station provide diagnostic information for base station status.

Antenna Diversity

Spatial diversity at the base station is implemented by using two antennas. The antenna providing the best signal for each time slot is selected. This is performed on the basis of the RF power level and alternatively the quality information.

In DECT, the BER(Bit Error Ratio) is affected by multi-path propagation not only in terms of signal fading but in terms of time dispersion, which leads to ISI(Inter Symbol Interference). Antenna diversity not only reduces the fading probability but mitigates the effect of time dispersion.

Power Feeding

The base station is DC powered from the WTI ports by phantom power feeding circuit between a WTI port and a base station.

Roaming

Roaming is the movement of a wireless terminal from one base station coverage area to another base station coverage area, where the base stations enable the wireless terminal to make or receive calls in both areas. The system supports roaming function.

Hand-over

The GDK-20W DECT provides a seamless hand-over, almost undetectable by users as they move from one radio cell to another.

Digital Voice Quality

The GDK-20W DECT uses advanced digital technology to provide high sound quality as almost equal to fixed line telephones. Speech coding uses 32kbps ADPCM(Adaptive Differential Pulse Code Modulation) conforming to CCITT recommendation G.721.

Multiple Simultaneous Users

The GDK-20W DECT accommodates multiple users(12 users) in simultaneous conversation with no degradation in performance.

C. Wireless Terminal (GDC-335H, GDC-340H)

The wireless terminal is designed for ease-of-use at the desks of users or moving throughout a facility.

- It is small and light for ease-of-use.
- The LCD displays call information and the status of terminal.
- The keypad contains specially labeled keys assisting users to make calls and operate telephone features.

Figure 3.6.4 Wireless Terminal (GDC-335H, GDC-340H)

Subscription

The wireless terminals associate unique identities, to prevent unauthorized use of the PSTN line. See the User Guide of the **GDC-335H and GDC-340H** for the subscription of wireless terminals.

LCD Display

The LCD of GDC-335H has six icons and 2 x 10 Dot matrix and the LCD of GDC-340H has eight icons and 2 x 12 Dot matrix.

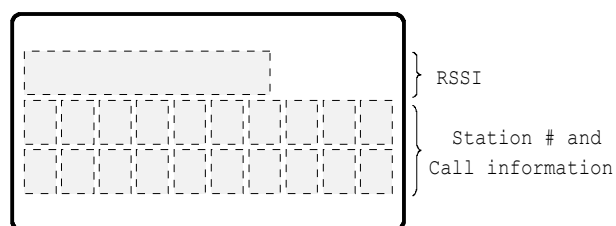

Figure 3.6.5 The LCD of GDC-335H & GDC-340H

Security

The wireless terminal ciphers voice information before transmitting it. It ensures that the conversations are private and inaccessible to electronic eavesdropping.

Ringling

There are various types of ring signal in the wireless terminal and users can select the ring signal and control the volume of ring signal. **Seven volume levels are available in GDC-335H and four volume levels are available in GDC-340H.**

Key Pad Tone

A beep is heard when the wireless terminals recognize a dial input from dial pad.

Low Battery Alarm

When the battery is discharged to low battery state, the low battery message is displayed in the display LCD of the wireless terminal (except GDC-340H) and warning tone is heard (both GDC-33xH and GDC-340H).

Low Power Consumption

The GDC-335H supports 15 hours for continuous use and 50 hours for standby mode on fully charged battery and The GDC-340H supports 9 hours for continuous use and 50 hours for standby mode on fully charged battery.

Removable Battery Pack

The GDC-335H has one type of battery pack (330-SBP, 600mAh). It is standard battery pack. The 330-SBP supports 15 hours for continuous use and 50 hours for standby mode. The GDC-340H has standard rechargeable battery (1.2V rechargeable NiMH AAA size 2 cell). The battery of GDC-340H supports 9 hours in talking mode and 50 hours in standby mode.

Figure 3.6.6 Battery Pack (330-SBP, AAA size battery)

Antenna

The antenna of the GDC-335H is an wire and non-retractable antenna. Do not extract it. If you try to pull it out, it may be destroyed. The antenna of the GDC-340H is embedded.

Holes of Top and Bottom Side

There are two holes in the top and bottom side of a GDC-335H. The GDC-340H has two holes in only bottom side. The holes are special purpose and are covered with covers. Do not take off these covers. Figure 3.6.7 shows the location of the holes.

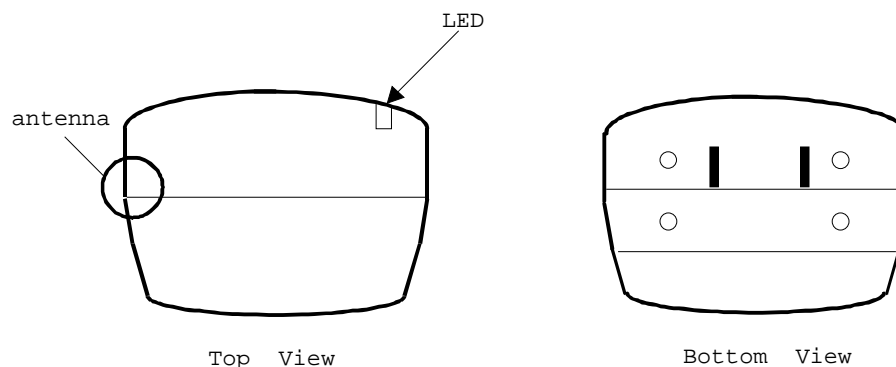

Figure 3.6.7 Holes in the Top and Bottom Side

Charger (330-SSC, 340-SSC)

The GDC-335H comes with a charger that accommodates GDC-335H and one type of battery pack. And the GDC-340H comes with a charger that accommodates GDC-340H and standard rechargeable battery. The 330-SSC & 340-SSC is supplied with the adapter (330-HAP). 330-HAP adapter is used for the charger, 330-SSC & 340-SSC. There are two types of adapter.

It is dependent on country adaptation.

Type - I

- Input : Only AC 230V ~ 50Hz 50mA
- Output : DC12V 200mA 2.4VA

Type - II

- Input : Both AC 220V and 110V ~ 50/60Hz
- Output : DC12V 200mA

Figure 3.6.8 shows the 330-SSC and 340-SSC.

Figure 3.6.8 Single-Slot Charger (330-SSC, 340-SSC)

LED (red) on the charger indicates that charging is in progress.

In the GDC-335H, when a battery is almost consumed during a call or in an idle state, warning tone will be heard more 3 times in every 20 second with "LOW BATT." message on the LCD, and a low-battery icon () will be twinkling at the right corner of the LCD.

In the GDC-340H, when a battery is almost consumed during a call or in an idle state, warning tone will be heard once in every 5 second, and a low-battery icon () will be blinking at the right corner of the LCD.

The battery inside of GDC-33xH, GDC-340H is Nickel Metal Hydride (NI-MH) and can be charged any time. **To increase the lifetime of the battery, use the wireless terminal without charging until the battery alarm is heard.**

3.6.2 System Configuration

The GDK-20W DECT is used in single cell or multi-cell.

3.6.2.1 Before Installation

Followings are the factors that affect the quality of service for the GDK-20W DECT.

- Location of base station
- Number of wireless terminal users within a base station range
- Obstructions between base station and wireless terminal
- Coverage area
- Desired quality of service

The purpose of this section is to provide you with information and explain tasks that you should complete to ensure the best operation of the system.

The following procedure is very helpful to check the coverage region and install the base station:

1. Site survey (see the sub-clause A)
2. Judge where to place bases on plan drawing (see the sub-clause B).
3. For each base, check coverage tool (see the sub-clause C and CRS Tool Manual).
4. Plot limit line for each base station.
5. Check for shadow area.
6. Adjust base position for shadow area or add base if not possible.
7. Consider traffic 5 calls per cell add to plan.
8. Install the base station (see the 3.6.3 Hardware Installation).
9. Check with 335H GAP (except 340H GAP) handset using RSSI (displays only one base station at a time, limit is -80 dbm: see the sub-clause D)
10. Walk with 2 handsets, monitor for voice quality and 'OUT OF RANGE' message.
11. If it is OK, finish it.

A. Site Survey

1. Get building blue prints.
2. Check building material and thickness.
Note the general construction materials used in walls and doors between multi-story buildings, and window coatings and coverings, if any. Also note any large metal objects, such as equipment, doors, and fluorescent lamp shades.
In general, signals are attenuated to some lower degrees when they should pass through any barrier, however, some materials such as metal attenuate much degree.

Note

- a. Consider high traffic areas, such as conference rooms, cafeterias, and manufacturing floors.
- b. Consider office locations and number of wireless terminal users within the site.

B. Base Station Broadcast Range and Location

1. Base Station Requirements

To determine the number of base station in a system, you should consider base station broadcast range.

2. Base Station Range

In a typical office environment, each base station has a broadcast range of 50 meters and supports an area of 8,000 square meters, but a broadcast range depends entirely upon office environment. Where the absence of any obstruction provides perfect line of sight conditions between the base station and wireless terminal users and if there are no atmospheric limitations, the range may increase to 200 meters.

The following base station broadcast ranges can be used as a rough guide to plan the base station positions:

- In line of sight, the base station has a range of about 200m.
- In hall, the base station has a range of 40-70m.
- In buildings, the base station has a range of about 25-40m. It assumes that walls are made of light brick, plasterboard or wallboard with metal frames. Normal electrical wiring, central heating pipes, office furniture and desktop computer equipment have no significant effect.

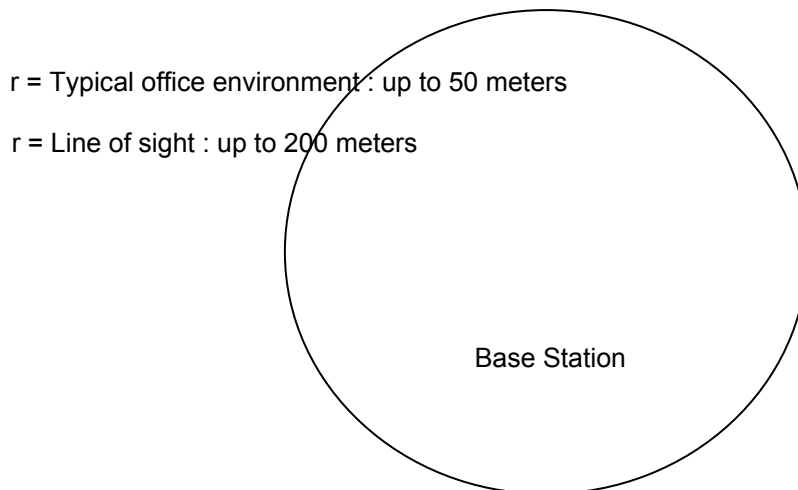

Figure 3.6.9 Base Station Service Area

The characteristic antenna field pattern is a torus(doughnut) centered on the antenna.

Figure 3.6.10 Base Station Antenna Field Pattern (Vertical)

3. Base Station Location on the Plan Drawing

Determine the location of the base station on the plan drawing according to the previous information based on the base station broadcast range.

Once you have completed the steps described in Site Survey on sub-clause A and determined the number of base stations you need, you should determine where to install the base stations for optimum coverage and operation of the GDK-20W DECT.

C. CRS(Cell-Coverage Region Survey) Tool

This section provides general guidelines and examples for determining location of base station in the site. For more information, *see the CRS Tool Manual*.

For the easy installation, LGE prepares the portable tools which consist of the base station and the wireless terminal.

Figure 3.6.11 Installation Configuration using the CRS Tool

General Guidelines

1. Place the base stations to maximize direct line of sight between wireless terminals and base station antennas. Mounting base stations as high as possible will satisfy this guideline.
2. Place the base stations to minimize obstructions near antennas. If you mount a base station on a wall, place it higher than the average tall person and do not mount it near doors that could temporarily obstruct antennas when the door is opened.
3. Antennas on wall-mounted base stations should be parallel to the wall.
4. Centralize base stations within the area that you intend to cover.
5. When rule 1 cannot be observed, place base stations so that signals begin their paths with a clear line of sight and then bend at the end of their travel to a receiving antenna. It limits the affect of signal fading.
6. To minimize blocking in high traffic area, install the base stations required to meet the estimated traffic demand. When multiple base stations are needed in the same location, you may mount base stations as close as one meter apart (to avoid one obstruction to the other according to the rule 2).
7. The base stations are designed to use frequencies that are not in use yet, so there is no problem of interference between base stations that are mounted near each other.

8. In multi-story environments, it is the best to plan coverage for each floor separately. However, because RF signals can travel between floors, a single base station could support multiple floors as long as base station broadcast area, traffic requirements, and other general guidelines are kept in mind. Usually, DECT wave is attenuated by reflection indoors. In order to minimize attenuation, when you install a base station on the wall, give at least three-wave-length intervals. The intervals should be at least 45 centimeters because the wavelength is 15 centimeters at DECT frequency. The best communication environment is when a base station and a user are in the same height. In office environment, however, it is desirable to consider office furniture to minimize reflection, diffraction and scattering of DECT wave when you set the position of a base station. The appropriate position for a base station is where 1.8meter above from the floor and 0.5 meter below from the ceiling. The top of iron office furniture such as a cabinet or a desk is not a good position. Keep away from electronic equipment such as a copy machine, a printer or a computer. And the lower wall of a corridor where many people pass by, corner of a wall, and narrow indoors also should be avoided.

Attenuation

When determining the location of base station, you should consider the effects of attenuation. Attenuation is the loss of strength of a RF signal due to distance, antenna positioning, and obstructions. The guidelines provided in Location of Base Station on sub-clause C take attenuation into account, but this section provides additional important concepts.

The magnitude of change in signal strength is measured in decibel(dB). Increasing or reducing of 3dB results in doubling or halving signal power strength.

Distance

[Table 3.6.1] shows the signal attenuation caused by distance in direct line of sight condition.

Distance	Attenuation (dB)
1 meter	0
10 meters	20
100 meters	40
1000 meters	60

[Table 3.6.1] Signal Attenuation in Direct Line of Sight Condition

Obstructions

RF signals are also attenuated by obstructions in their paths. [Table 3.6.2] shows the attenuation caused by common materials in a building. You should try to limit the loss to 60dB.

Object	Approximate Loss in dB
Concrete	15
with metal siding	30
with window	8 to 9
Venetian blinds	
Open	10
Closed	20
Soft partitioning	3 to 4

[Table 3.6.2] Signal Attenuation Caused by Building Materials

Although signals can travel through obstacles, you should place base stations so that signals begin their travel with a clear line of sight and travel through obstacles afterwards. In the example shown in Figure 3.6.12, the base station is placed to maximize line of sight in both corridors.

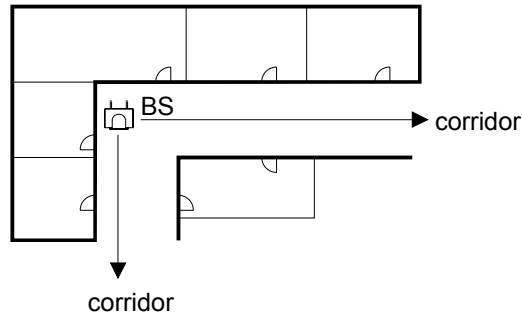

Figure 3.6.12 Maximizing Line of Sight

Fading

Fading refers to the attenuation caused when a signal is reflected and receiving antenna receives multiple instances of the signal. A direct signal is always stronger than a reflected signal.

Base station is designed with two antennas and the capacity to choose the best suited antenna for carrying the strongest signal. This design minimizes chances of fading.

Although signals can travel around corners, you should place base stations so that signals begin their paths with a clear line of sight as illustrated in **Figure 3.6.12** and then bend to travel to a receiving antenna. It limits the effect of signal fading.

Shadowing of the radio signal

The following items may well cause shadowing of the radio signal:

- Thickness of walls, especially cavity walls and reinforced concrete walls.
- Windows or glass in doors with steel wire reinforcement or metallic reflection film.
- Steel doors, lift shafts, partitions or walls.
- Fire resistant doors
- A wall of steel cabinets, large computer equipment or machinery.
- Thickness of concrete floors.

Traffic Guidelines

Each base station supports four simultaneous calls, but because all users are not simultaneously in call statistically, a base station can support a greater number of wireless terminal users in practice.

Number of Cell (Base station)	Recommended Number of Registered Wireless Terminals	Number of maximum Simultaneous Wireless Conversation
1	20	4
2		8
3		12

[Table 3.6.3] Suitable Wireless Terminal Number according to Base Station Number

D. RSSI Monitoring (Possible in GDC-335H only)

This function helps that the dealer can install base stations without CR instrument. The RSSI (Received Signal Strength Indicator) level of a base station of which the wireless terminal is locked is displayed as dBm value on the LCD (The limit is -80dbm.). This value is updated periodically.

- Press **FUNCTION**(↔) button.
- Press *.
- To enter Technician menu, press PIN code ('L','G','G','A','P' = '5','4','4','2','7').
- Press **FUNCTION**(↔) button.
- Technician Main Menu is displayed on the LCD.
- Press 4 (Or set '<' mark to '4 ShowRSS' to press **UP**(▲) button or **DOWN**(▼) button and press **FUNCTION**(↔) button.).
(The RSSI value is displayed on the LCD and the value is updated periodically.)
- Press **FLASH** button to return to Main Menu.

E. Reporting Results

It is important to make a comprehensive survey report that records test results and provides useful information for the engineer who actually install the equipment. The following information should be included in the survey report (see Survey Template):

- A description of the site, explaining which buildings and grounds are to be included in the report. A description of the topography of outdoor areas may be useful.
- A specification of the construction of the buildings and construction materials.
- Determine the customer requirements for;
 - ✓ the number of wireless terminals
 - ✓ required coverage
 - ✓ performance requirements (traffic density, grade of service, etc.)
- The location of the GDK-20W System.
- Cabling details. Include a specification of cables already present on the site and a list of new cabling required. Include the distance between a base station and a WTIB for existing and new cabling.
- Copies of the maps of the site with the positions of base stations and the cell boundaries. Different cell boundaries can be marked with different patterns to avoid confusion, i.e. dotted, dashed, dot dash, etc. Do not use colors as these may be lost when photocopying.

Use the following numbering conventions:

xwyy refers to the identity of the base station, where;

x is the level (-1 is basement, 0 is ground floor, 1 is 1st floor, etc.)

w is the base station number.

yy is the base station position number. This number should be unique.

xcyy refers to the identity of the cell, where;

x is the level at which the measurement was made. (-1 is basement, 0 is ground floor, 1 is 1st floor, etc.)

c is the cell number.

yy is the base station position number that is being measured.

A list of possible configurations will help the customer to decide exactly what is required. A specification of where base stations should be placed. This can be marked on the survey map, but additional information such as height and fixing instructions should be included where appropriate.

A specification of the areas that will be covered by the base station and the areas that may cause problems. This can be useful when testing the system.

The theoretical maximum number of overlapping cells is 10, if all time slots and frequencies are used. If not all time slots and frequencies are used, this value is higher. However this is unlikely to be reached in practical situations.

For a large site where a thorough survey has been impossible, it may be prudent to add additional base stations to the product offer to allow for unforeseen problem areas.

Check list for Survey Data

- Building characteristics (list for each building); Building identification (refer to maps if available); Type of use....
- Dimensions (refer to maps if available)
- Number of floors (refer to maps if available)
- Height per floor
- Partitioning per floor (refer to floor plans if available)
- Construction details (type of construction and materials used)
- Radio coverage requirements....
- List areas which are to be excluded from radio coverage, or where radio coverage is not absolutely required.
- List areas where radio coverage is not feasible or requires specific base stations.
- Objects inside buildings
- Details of furniture, cupboards, machinery, etc. in the interior of buildings per floor.
- Position of GDK-20W DECT.
- Connection between a WTI port and a base station....
- For each base station, the following details of its connection to a WTI port are required:
 - ✓ The length of cable between WTI port and base station
 - ✓ Whether existing cabling is present that might be used and if so, the type of cabling (twisted pair, star quad, wire diameter, etc.)
 - ✓ Presence of free pairs, etc. cabling layout (risers, horizontal wiring, distribution frames) and whether existing cabling can be used or new wiring is required.

DECT Survey Report Template

Number:

Date:

From :
[Engineer doing the survey]

To :
[LGE Sales Manager]

Copy to:
KOREA
[Always send a copy to LGE, Korea]

- Site :
[Full address of site]
- Execution of survey Engineers :
Survey carried out by: [Names and addresses of engineers who executed the survey]
- Customer engineer(s) : [Name and address of customer engineer(s)]
- Date : [Date of survey]

- Outline description of site
[Short description of site (dimensions, environment, number and type of buildings, etc.)]
- Number of wireless terminals and expected traffic
[Description of expected traffic and indication of above or below average traffic areas]
- Test results.
[This should include the site maps and any additional information that may be useful]
- Connections WTI ports - base stations
- Existing cabling
[Indicate what cabling is available and how it is distributed across the site]
- Connection of base stations and cable lengths
[List for planned base station approximate cable length, and whether existing wiring can be used or new cabling is required]
- Base station installation
[For each base station indicate exactly where it can be installed, e.g. "in the corridor against the wall of room 32, 2.5m high") and whether customer restrictions apply as to where base stations may be installed]
- Possible configurations
[List alternative configurations regarding the deployment of base stations. Refer to coverage maps and detail areas where coverage cannot be guaranteed]

3.6.2.2 Examples

A. Example 1 - Centralizing Base Stations

Figure 3.6.13 shows a site with factory and adjoining office area. Both base stations are placed in the manufacturing area to accommodate with more users in that area. However, base station BS2 is placed closer to the office area to provide coverage in the office area and maximize line of sight through the doorway. This is especially important if the wall between the office and manufacturing area is concrete. To satisfy guidelines 1 and 2, the base stations are mounted on the ceilings and away from any potential obstructions to the antennas.

If there is another area to the left of the manufacturing area, moving the base station BS1 to the left is probably allowed to support users in that area as well. If the manufacturing area does not obstruct base station antennas, their broadcast ranges could reach up to 200 meters.

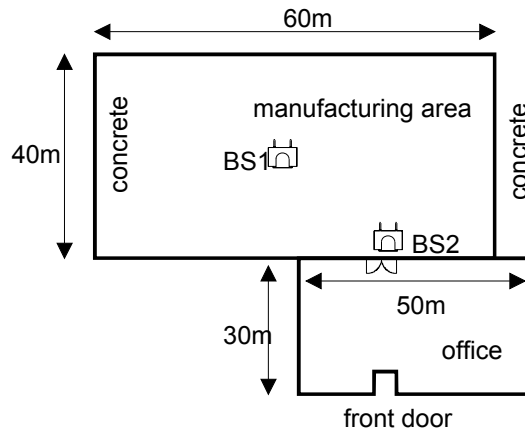

Figure 3.6.13 Centralized Base Station Placement

B. Example 2 - Base Station Coverage in Adjoining Areas

The corridors can act as natural pathways for RF signals. When you are trying to cover two types of area, placing a base station near a corridor may optimize coverage in both areas.

In the site shown in **Figure 3.6.14**, the entrance from the manufacturing area into the café is a high traffic area. Placing a base station in the entry area of the cafe will block line of sight to other areas in the cafe. Therefore, BS2 should be centrally located in the cafe area. BS1 is centrally located in the manufacturing floor area, but aligned with the entrance into the cafe to provide coverage into the cafe.

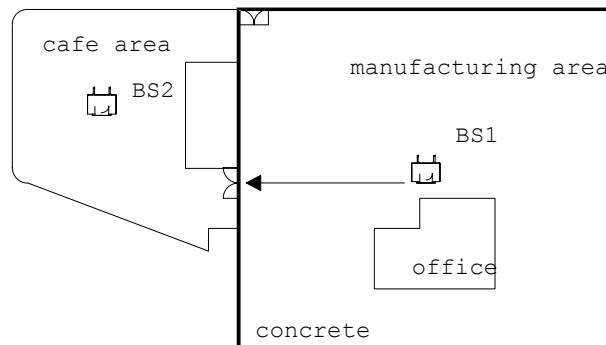

Figure 3.6.14 Base Station Aligned with Corridor to Adjoining Area

C. Example 3 - Maximizing Line of Site

Figure 3.6.15 shows an office area containing walled offices, cubicles, and conference rooms. Although the number of base stations in this environment would depend on the number of wireless terminal users, the base stations in the example are aligned with corridors to maximize line of sight instead of placing both base stations close to each other. BS1 is placed near the conference rooms and entrance area to accommodate more potential traffic in these areas.

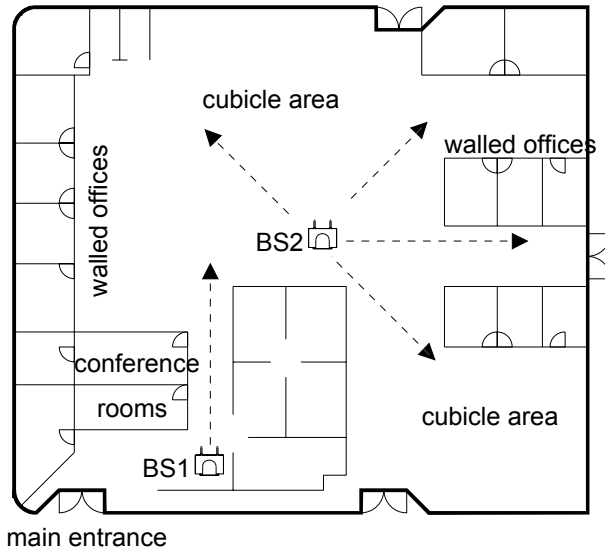

Figure 3.6.15 Location of Base Station in Office Environment

3.6.3 Hardware Installation

A. Equipment Check

GDK-20W DECT provided Equipment

- WTIB (option)
Base stations (GDC-200B) , Connecting block and Line cord
Wireless terminals (GDC-335H, **GDC-340H**), Single-slot charger (330-SSC, **340-SSC**), Battery (330-SBP, **rechargeable battery AAA size 2 cell**) and Adapter (330-HAP)

GDC-200B, GDC-335H, **GDC-340H**, Single-slot Charger (330-SSC, **340-SSC**), and adapter (330-HAP) are shown at **Figure 3.6.16** and **Figure 3.6.17** in each.

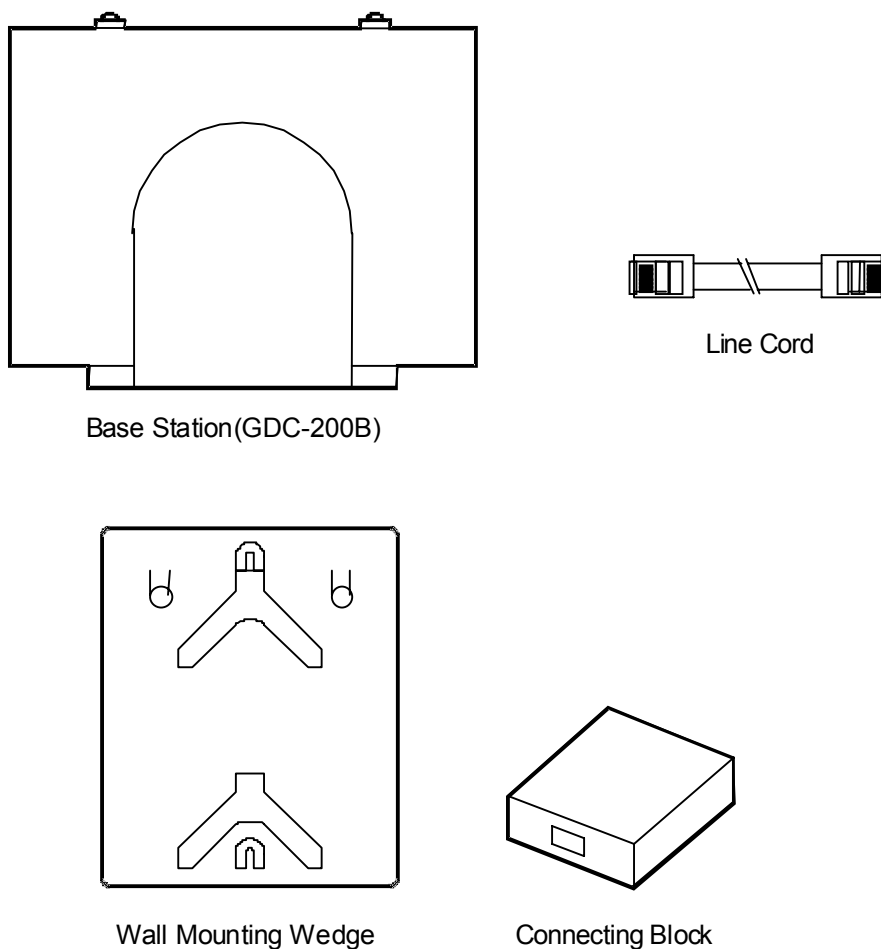

Figure 3.6.16 Packing Components of GDC-200B

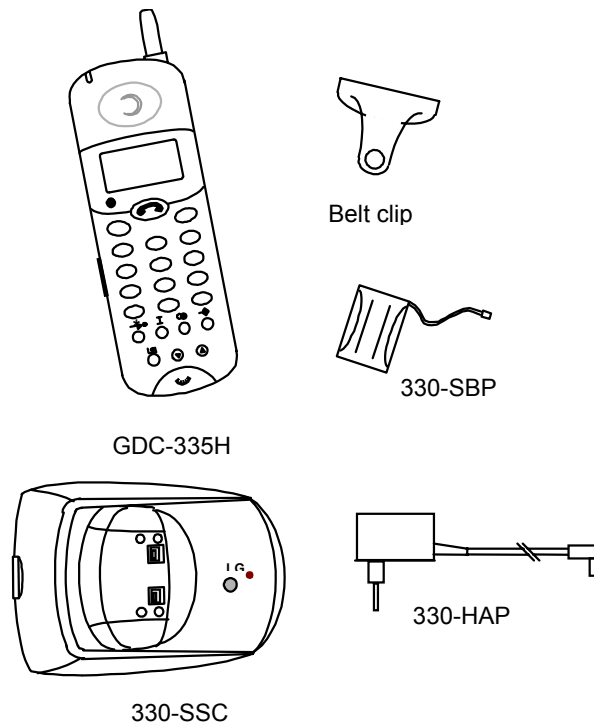

Figure 3.6.17 Packing Components of GDC-335H and GDC-340H

B. Unit Installation

WTIB Installation

In a GDK-20W Digital Wireless Key Telephone System, the WTIB is a base station interface board that is installed in the SLOT5.

If the WTIB is installed in a power-on system, the system and/or WTIB can be damaged. Thus after system power is off, the WTIB should be plugged in/out to/from the system.

Base Station Installation

Before mounting base station permanently, you should determine a suitable location providing the best coverage.

Employing the GDC-200B **mounting template** attached at the last sheet of installation manual, mark the location of the two screws to mount the Base.

Mounting Base Station - 1

The weight of a base station is light as approx. 420g, so it can be mounted on a masonry or dry-wall surface, wooden wall, or partition wall. The distance between mounting holes is 121mm as shown in **Figure 3.6.18**. The base station is mounted with 1 1/2 inch or longer screws. Drill pilot holes in the two locations, insert the screws and tighten leaving about 3mm gap between the wall and screw head. Mount the base station on the screws and tighten the screws securely.

Figure 3.6.18 Wall Mounting of Base Station (without wedge)

Before mounting base station permanently, you should determine locations that provide the best coverage. The wall mounting procedure of a base station is as follows:

Drill two 3.5 mm holes in a fixed wall. To properly position the holes, you can measure the tags on the base station or mark the surface through the tag eyelets while holding the base station in place.

Insert anchors into the drilled holes. Then insert screws in the anchors, leaving a 3 mm gap between the wall and screw head.

Mount the base station eyelets on the screws.

Mounting Base Station - 2 (Using Wedge)

Installing the Base Station using the wedge,

Determine at first the location on wall where the wedge prepared for mounting the base station is to be fixed.

The wedge should be settled by using two screws on the wall.

And insert the base station pulling down into the wedge.

Figure 3.6.19 Wall Mounting of Base Station using Wedge

Base Station Cabling

The Base Station is connected to the WTI(wireless terminal interface) ports of GDK-20W KSU by a twisted one pair copper line. The following rules should be obeyed:

The cable for connecting the KSU with a base station should be a twisted pair cable.

The cable for connecting the KSU with a base station shall be separately cabled. This connection shall be cabled separate to the building cabling using one pair CAT5 cabling.

Twisted pair shielded cables should be used with all outdoor configurations.

The following characteristics should be observed for all cables:

DC resistance: The resistance of a conductor should not exceed 73.4 ohm per km for a temperature of 20 degree.

Attenuation: The attenuation of any pair should not exceed 17 dB per km on condition of a temperature of 20 degree and frequency of 1 MHz.

Characteristic impedance: Characteristic impedance should remain in the range of 100 ohm \pm 15% for a frequency of 1 MHz.

Crosstalk: The total crosstalk of any pair (Far-end and Near-end crosstalk), measured over a line length of 1800 metres should not exceed 40 mV.

The maximum connection length depends upon cable size(ϕ). [Table 3.6.4] shows the resistance and the maximum cable length.

Cable Type	Resistance	Maximum Cable Length
0.4 mm cable (Awg26)	0.27 Ω /m	150m
0.5 mm cable (Awg24)	0.18 Ω /m	300m
0.6 mm cable (Awg22)	0.11 Ω /m	450m

[Table 3.6.4] Cable Resistance and Maximum Cable Length

Wireless Terminal Installation

To install GDC-335H (GAP) and GDC-340H (GAP), simply take out the handset and batteries (330-SBP, rechargeable battery), charger (330-SSC, 340-SSC) and AC/DC adapter (330-HAP) from the package and assemble it. Before using the GDC-335H and GDC-340H, you should recharge the battery fully.

After inserting a battery, press the power button of GDC-335H (GAP) and GDC-340H (GAP). **Figure 3.6.20** shows the initial LCD. The two icons in the left upside of the LCD are blinking until the GDC-335H is subscribed. (In GDC-340H, these icons are not displayed until the GDC-340H is subscribed)

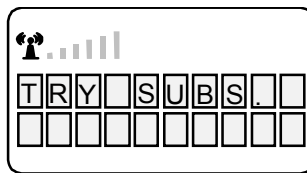

Figure 3.6.20 LCD Message of Unsubscribed GDC-335H (GAP) and GDC-340H(GAP)

Before using the GDC-335H(GAP) and GDC-340H(GAP), it should be subscribed. **Figure 3.6.21** shows the LCD message of the subscribed GDC-335H(GAP) and GDC-340H(GAP).

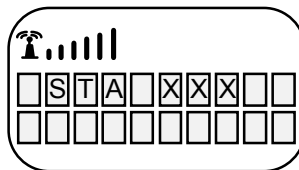

Figure 3.6.21 LCD Message of Subscribed GDC-335H (GAP) and GDC-340H (GAP)

Refer to the User Guide of the GDC -335H and GDC-340H for the detail information.

3.6.4 User subscription/desubscription

A. System ID

Description

System ID is given to the GDK-20W system attached the wireless GAP terminal for identification. System ID, which is PARK(Potable Access Rights Key), is written on MBU.

PARK: 31100013411604

Authentication Code is entered at only attendant station, before you begin to subscribe wireless terminal (GAP) to GDK-20W system. You should get AC code PARK from a system manager. In addition to the above, you should get station number of the wireless terminal to be subscribed from a system manager.

Operation

✧ In case of confirming system ID

1) At attendant station

[Trans/Pgm]

 + ## + Flex. Button 4

- ① If you press the [Trans/Pgm] button, [Trans/Pgm] LED will flash(60 IPM Flash) and [On/Off] LED will be turned on.. Then you can enter then user program mode.
- ② Dial '##'
- ③ Press Flexible Button 4
- ④ Current PARK code will be displayed in LCD

✧ In case of changing system ID

1) At attendant station

[Trans/Pgm]

 + ## + Flex. Button 6 + System ID(PARK) + [Hold/Save]

CAUTION: Normally you should not change the system ID. If you should change it, please contact LG or local dealer in your country.

- ① If you press the [Trans/Pgm] button, [Trans/Pgm] LED will flash(60 IPM Flash) and [On/Off] LED will be turned on. Then you can enter then user program mode.
- ② Dial '##'
- ③ Press Flexible Button 6
- ④ Enter the system ID(PARK code)
- ⑤ After entering the PARK code, press [Hold/Save] button. Then you can hear confirm tone.

The key sequence of the PARK : LLP_____PC

LL : Two digits decimal representation of PARK length (Bit count)

P_____P : 11 octal digits representation of PARK

C : Check digit (It is calculated as the sum of each digit in the input stream multiplied by its position in the input stream , modulo 11; if the result if 10, this is represented by the “*”.)

Conditions

- 1) You must program for system ID when you install the system.
- 2) If you program system ID, all data that were related to wireless features will be erased.
- 3) The initial PARK value is 00000000000000. So the value will be display in LCD at first

B. Authentication Code

Description

Authentication Code is entered at only attendant station before you begin to subscribe wireless terminal(GAP) to GDK-20W.

Operation

◇ In case of confirming AC code

- 1) At attendant station

[Trans/Pgm] + ## + Flex. Button 3

- ① If you press the [Trans/Pgm] button, [Trans/Pgm] LED will flash(60 IPM Flash) and [On/Off] LED will be turned on.. Then you can enter then user program mode.
- ② Dial '##'
- ③ Press Flexible Button 3
- ④ Current AC code will be displayed in LCD

◇ In case of changing AC code

- 1) At attendant station

[Trans/Pgm] + ## + Flex. Button 3 + AC Code(Max 8 Digits) + **[Hold/Save]**

The key sequence of the AC code : D_____D

D_____D : Up to 8 digits decimal representation.

- ① If you press the [Trans/Pgm] button, [Trans/Pgm] LED will flash(60 IPM Flash) and [On/Off] LED will be turned on.. Then you can enter then user program mode.
- ② Dial '##'
- ③ Press Flexible Button 3
- ④ Enter the AC code
- ⑤ If you press the [Hold/Pgm] button, you will be heard confirm tone.

Condition

- 1) AC code is must be programmed for user subscription.
- 2) AC code must be programmed one time after system was installed. If you change AC code under system operation, it may not operate properly.
(Ex : Subscribed terminal may not receive the incoming call or not make an outgoing call)
- 3) If PARK value are changed, you must enter the AC code again.
- 4) The initial AC code is 000000.
- 5) AC code change will not affect the system operation except subscribing new wireless terminal

C. User Subscription

Description

This procedure is for subscribing the wireless terminal to GDK-20W system.

Operation

1) Attendant station

[Trans/Pgm] + ## + Flex. Button 1 + Station Number + Phone Type + [Hold/Save]

- ① If you press the [Trans/Pgm] button, [Trans/Pgm] LED will flash(60 IPM Flash) and [On/Off] LED will be turned on.. Then you can enter then user program mode.
- ② Dial “##”
- ③ Press Flexible Button 1
- ④ Enter the station number.
- ⑤ Enter the phone type (LG-GAP for GDK system or standard GAP for any other system). In case of LG-GAP terminal, press [1] button. Otherwise press [2] button.
- * **Note** : In case of GDC-340H, If MPB version is 3.0Aa above, press [3] button.
- ⑥ Press [Hold/Save] button and confirmation tone is heard.
- ⑦ If succeeded, the attendant station will display “ SUBSCRIBED: SUCCESS” on the LCD display.
- ⑧ **If failed(ether at attendant or at wireless terminal), repeat ③ ~ ⑥ steps of the attendant.**

2) At the GDC-335H

[Function] + 0 + PARK code + [Redial] + AC code + [Redial] + FT No. + [Function]

- ① Press [Function(→)] button
- ② Press 0
- ③ Enter system ID(PARK)
- ④ Press [Redial (●)] button
- ⑤ Enter AC code
- ⑥ Press [Redial (●)] button.
- ⑦ ‘1’,‘2’,‘3’,‘4’ or ‘_’ are displayed on the LCD. A number means FT number that it is not occupied yet. The under-bar means the wireless terminal is already subscribed to the system. Therefore, the number of ‘_’ means the number of subscribed system. If 4 under-bar are displayed on the LCD, that means no subscription is allowed any more. Enter FT number by pressing numeric key if any number exists. After selecting, it is possible to re-select FT number by pressing [Flash(R)] button to cancel selection.
- ⑧ Press [Function(→)] button
- ⑨ Success or failure of the subscription is notified with confirmation tone to the attendant and the wireless terminal.
- ⑩ If succeeded, the wireless terminal goes to an idle state and its station number is displayed.
- ⑪ **If failed, repeat ③~⑥ steps of the attendant and ①~⑧ steps of wireless terminal.**

The key sequence of the PARK : LLP_____PC

LL : Two digits decimal representation of PARK length (Bit count)

P_____P : 11 octal digits representation of PARK

C : Check digit (It is calculated as the sum of each digit in the input stream multiplied by its Position in the input stream, modulo 11; if the result is 10, this is represented by the “*”.)

The key sequence of the AC code : D_____D

D_____D : AC value : Up to 8 digits decimal representation.

FTID : 1 ~ 4

3) At the GDC-340H

[MEMU/UP/DOWN] + 5 1 + select **Base No** + [OK] + **AC code** + [OK] +
 Display **SEARCHING** + Display **PARK**(last 12Digit) + [OK]

- ① Press **MENU (UP or DOWN)** button.
- ② Press **5**.
- ③ Press **1**.
- ④ Select base number (1~4) using **UP** or **DOWN** button and press **OK** button.
- ⑤ Enter AC code (up to 8 digits decimal representation) and press **OK** button
- ⑥ The wireless terminal tries to search for the registerable system and ‘**SEARCHING**’ is displayed on the LCD. After searching the registerable system, **PARK(last 12digits)** value is displayed on the LCD.
- ⑦ If the **PARK** value displayed is right, press **OK** button. If the **PARK** value displayed isn’t right press **UP** or **DOWN** button. And then the wireless terminal retries to search for the registerable system and ‘**SEARCHING**’ is displayed again.
- ⑧ Success or failure of the subscription is notified with confirmation tone to the attendant and the wireless terminal.
- ⑨ If succeeded in subscription, the wireless terminal goes to an idle state and its station number is displayed.
- ⑩ If failed, repeat 3) ~ 6) steps of the attendant and 1) ~ 7) steps of wireless terminal.

Condition

- 1) Wireless terminal must be subscribed to system for normal service.
- 2) Only attendant can subscribe the wireless terminals(GAP).
- 3) Attendant can subscribe another wireless terminal after one subscribing procedure.
- 4) If attendant want to subscribe wireless terminal that was subscribed already, it will be heard error tone.

D. User Desubscription

Description

This procedure makes a wireless terminal loose access right to the GDK-20W system. To de-subscribe the wireless terminal, it should be in an idle state.

Operation

1) Attendant station

[Trans/Pgm] + ## + Flex. Button 2 + Station Number + [Hold/Save]

- ① If you press the [Trans/Pgm] button, [Trans/Pgm] LED will flash(60 IPM Flash) and [On/Off] LED will be turned on.. Then you can enter then user program mode.
- ② Dial "##"
- ③ Press Flexible Button 2
- ④ Enter the station number.
- ⑤ Press [Hold/Save] button and confirmation tone is heard.
- ⑥ Success or failure of the subscription is notified with confirmation tone to the attendant and the wireless terminal.
- ⑦ If succeeded in de-subscription, the below LCD message will be displayed. Power-off the wireless terminal

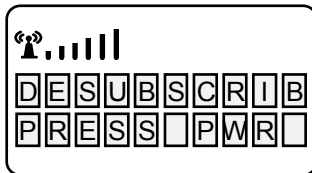

- ⑧ In case of the GDC-340H, If succeeded in de-subscription, GDC-340H tries to synchronize to next registered system. If there isn't next registered system, GDC-340H displays "UNREGISTERED" on LCD.

Condition

- 1) Only attendant can de-subscribe wireless terminal
- 2) Attendant can de-subscribe wireless terminals those were subscribed already.(If attendant try to de-subscribe un-subscribed wireless terminal, it will be heard error tone.
- 3) Attendant can de-subscribe another wireless terminal after one de-subscribing procedure.
- 4) Attendant can do de-subscribing procedure only when wireless terminal is at the idle state.

* **Notes** : If you want to do de-subscribe procedure at wireless terminal and attendant station independently, Follow the procedure that described below.

1) At attendant station

✧ To erase all data those were subscribed.

[Trans/Pgm] + ## + Flex. Button 7 + Password(147*) + [Hold/Save]

- ① Press the [Trans/Pgm] button, [Trans/Pgm] LED will flash(60 IPM Flash) and [On/Off] LED will be turned on.. Then you can enter then user program mode.
 - ② Press ##
 - ③ Press flexible button 7
 - ④ Enter password.
 - ⑤ Press [Hold/Save], you will be heard confirmation tone.
- ✧ To erase a special wireless terminal

[Trans/Pgm] + ## + Flex. Button 8 + Station Number + [Hold/Save]

- ① Press the [Trans/Pgm] button, [Trans/Pgm] LED will flash(60 IPM Flash) and [On/Off] LED will be turned on.. Then you can enter then user program mode.
- ② Press ## .
- ③ Press flexible 8
- ④ Dial station number that you want to de-subscribe.
- ⑤ Press [Hold/Save], you will be heard confirmation tone.

Condition

- 1) Wireless terminal must be de-subscribed to system for normal service.
- 2) Only attendant can de-subscribe the wireless terminals.
- 3) Attendant can de-subscribe another wireless terminal after one subscribing procedure.
- 4) If attendant want to de-subscribe wireless terminal that was subscribed already, it will be heard error tone.

2) At the GDC-335H

[Function] + 9 + 0000 + [Function] + Select Park number + [Function]

- ① Press [Function(↔)] button
- ② Press 9
- ③ Enter User PIN number "0000"
- ④ Press [Function(↔)] button
- ⑤ Select PARK number with UP(▲), DOWN(▼) key.
- ⑥ Press [Function(↔)] button
- ⑦ If the below LCD message is displayed. Power-off the wireless terminal

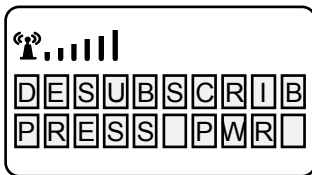

3) At the GDC-340H

[MENU(UP or DOWN)] + 5 + 2 + PIN Code + [OK] + ▲ or ▼ (To select FP#) + [OK]

- ① Press **MENU**(UP or DOWN) button.
- ② Press **5** (Or set '>' mark to '5 System' by pressing **UP**(▲) button or **DOWN**(▼) button and press **OK** button).
- ③ Press **2** (Or set '>' mark to '5 UnRegister' by pressing **UP**(▲) button or **DOWN**(▼) button and press **OK** button).
- ④ Enter PIN code(0,0,0,0) *If a user has changed PIN code before, the changed one should be entered.*
- ⑤ Press **OK** button.
- ⑥ If necessary, press **UP**(▲) button or **DOWN**(▼) button to select FT number which is desubscribed. If the desubscribed FT number is displayed on the second line of LCD, stop pressing **UP**(▲) button or **DOWN**(▼) button.
- ⑦ Press **OK** button.

*** Note**

- ① GDC-340H tries to synchronize to next registered system.
- ② If there isn't next registered system, handset displays "UNREGISTERED" on LCD.

3.6.5 Summary of DECT Installation

1. Check and prepare the equipment.
2. Install a GDK-20W Digital Key Telephone System.
If necessary, Install the WTIB(optional card)
3. Determine location of base stations.
4. Install base stations.
5. Connect the WTI ports with base stations by twisted one pair cables.
Wireless terminal interface ports are prepared at the MBU & WTIB.
6. Program of the PARK at the attendant station.
7. Register wireless terminal.
8. Make an initial call.

SECTION 4. ISDN DESCRIPTION

4.1 ISDN Boards in GDK-20W

1. There are two kinds of ISDN Cards on GDK-20W system, as follows.

Board Type	STIB	STIB 2	Remark
Option	1 Port	2 Ports	
Interface	S/T	Up: S/T Down: T	S/T Interface in STIB can be selected by changing the Jump Switch on the STIB Board.
Maximum number of cards on GDK-20W.	2 Card	2 Card	

2. You can install STIB within the station and CO line capacity of the system.

MODEL	Max. Stations	Max. CO Lines
GDK-20W	34	8

3. The maximum 8 ISDN devices can be connected to the single S-Interface port, and any kind of ISDN devices, which are compatible with ETSI ISDN specification, can be connected to the S-Interface. For example, ISDN phone, G4 Fax, video terminal, ISDN PC card, etc. can be connected.

4.2 The Basic Features of ISDN Device (S-Interface)

1. ISDN Devices

- 1) There are many ISDN Devices. (ex. ISDN Phone, Video-Phone, G4 Fax, PC-Card, etc.) GDK-20W supports all ISDN Devices which is compatible with Euro-ISDN (ETSI ISDN Specification) till now on.
- 2) ISDN Devices can call another station on the GDK-20W and access ISDN CO Lines.
- 3) Current LCD Display on ISDN Device is its own Device Feature, not GDK-20W System's Feature.

2. Supplementary Service for ISDN Device

- 1) In GDK-20W, ISDN Station can access the following features,
 - A. ISDN Sub Addressing
 - B. MSN
 - C. Intercom Call
 - D. CO Line Access
 - E. CO Line Hold.
 - F. CO Line Transfer.
 - G. Etc.

2) ISDN Sub Addressing.

Sub Addressing can be programmed by Station Base Program(Main Menu2) - ISDN Station Attribute(Sub Menu2) - Sub Address(Terminal Menu1), its range is YES/NO(Default: NO).

If ISDN Station is allowed sub addressing by admin. program, in any station user who wants to call to ISDN station has to dial the station No and sub address for that ISDN station.

For using ISDN Station's Sub Address, there is further program on the ISDN Devices. Please consult your ISDN Devices manual for programming ISDN Device's Sub Address.

Sub Address is useful to the following Features for decoding the single ISDN Device from ISDN Devices on the same S-Interface (bus),

- (1) Intercom Call to ISDN Station
- (2) DID Call to ISDN Station
- (3) DISA Call to ISDN Station

On the other features, Sub Addressing does not effect ISDN Station's behavior.

3) ISDN MSN Addressing.

MSN Addressing can be programmed by Station Base Program (Main Menu2) - ISDN Station Attribute(Sub Menu2) - MSN (Terminal Menu3), its range is YES/NO(Default: NO).

If ISDN station is allowed MSN addressing by admin. program, in any station user who wants to call to ISDN station has to dial the station No and MSN address for that ISDN station.

For using ISDN Station's MSN Address, there is further program on the ISDN Devices. Please consult your ISDN Devices manual for programming ISDN Device's MSN Address.

MSN Address is useful to the following Features for decoding the single ISDN Device from ISDN Devices on the same S-Interface (bus),

- (1) Intercom Call to ISDN Station
- (2) DID Call to ISDN Station
- (3) DISA Call to ISDN Station

On the other features, MSN Addressing does not effect ISDN Station's behavior.

4) ISDN Intercom Call.

Any station can call ISDN Devices by dialing station no. S-Interface has two stations no. So, user can call ISDN Devices by dialing one of two pre-assigned stations no. There is no difference between calling ISDN Devices with the two stations no which is assigned the same S-Interface.

If ISDN Device is set to Sub Addressable ISDN, it needs further one digit for calling that ISDN Device.

5) ISDN CO Line Access.

CO Line Access of ISDN Device is the same as that of Single Line Telephone (SLT)

6) CO Line Hold.

In GDK-20W, system does not use DTMF Receiver for recognizing user's dialing digit. So if user want to use Hold/Transfer Feature on ISDN Device, ISDN Device has the capability of sending Keypad Facility Information on the Information Message.

If possible, holding CO Line Call, send "*" (Keypad Facility), then connected CO Line Call is held and user can hear Intercom Dial Tone.

Retrieving Held CO Line, send "*" (Keypad Facility), then the held CO Line Call is retrieved.

Please consult your ISDN Device's Manual for sending "Keypad Facility" after connection.

7) CO Line Transfer.

In GDK-20W, system does not use DTMF Receiver for recognizing user's dialing digit. So if user want to use Hold/Transfer Feature on ISDN Device, ISDN Device has the capability of sending Keypad Facility Information on the Information Message.

If possible, holding CO Line Call, send "*" (Keypad Facility) and dial the station No to transfer the call, then connected CO Line Call is held and user can hear Intercom Dial Tone.

Retrieving Held CO Line, send "*" (Keypad Facility), then the unanswered CO Line Transfer Call is retrieved.

Please consult your ISDN Device's Manual for sending "Keypad Facility" after connection.

8) Etc.

ISDN station accesses the above features. Other features are not supported currently.

- ISDN station cannot be the master of Conference.
- ISDN station cannot call Station which is activated Off-net Call Forward.
- ISDN station cannot be Attendant Station.
- ISDN station cannot accept additional ring when it is involved in a call whether the ring is external or internal.

4.3 The Features of ISDN CO Line (T-Interface)

1. Normal CO Line Features

Normal CO Line Features of STIB/BRI is the same as Analog CO Line. Normal CO Line Features are described GDK-20W Manual. Consult your GDK-20W for normal CO Line Features.

2. MSN

GDK-20W will receive some called party number from PX via DID line, then looks up the MSN address TABLE, ISDN Program (Main Menu 4) - MSN Table (Sub Menu 9) to provide ring signal to an ISDN internal port.

GDK-20W will send the information including the called party number to the ISDN station that is ringing.

- (1) Maximum table entry : 24.
- (2) The CO line should be programmed as DID Line, CO Base Program (Main Menu 3) – ISDN Attribute(Sub Menu 2) - DID Use(Terminal Menu 4).
- (3) If the called party number is not matched with MSN table then GDK-20W will treat the call like as DID.
- (4) If the called CO line number is not programmed then search all tables.
- (5) If there is matched CO line number in MSN address table then search only matched entry of the table.
- (6) Maximum 8 device can be connected to a S0 port.
- (7) MSN Table. ISDN Program (Main Menu 4) - MSN Table (Sub Menu 9)

Item	CO Line Number	Telephone Number	Station Number	MSN Number
Flex	1	4	2	3
Range	1-8	Max 20 Digits	2 or 3 Digit Station Number	1-8
Default	None	None	None	None

3. D.I.D. (Direct Inward Dialing)

The system operates DID CO, if ISDN CO assigns DID CO through CO Base Program (Main Menu3) – ISDN Attribute (Sub Menu2) – DID Use (Terminal Menu 4). If you want to call to a ISDN station which assigns sub-addressing of DID or DISA, you should dial station numbers and sub-address or MSN number (1-8).

If your PX send full called party number(area code + prefix number of DID, real DID number(for station number)) and then please set CO Base Program (Main Menu3) - ISDN CO Attribute (Sub Menu2) - DID_RN(Terminal Menu2) to length of (area code + prefix did number)).

4. CLIP (Calling Line Identification Presentation)

When a call exists through DISA or DID, Calling line identification(CLI) of the incoming call will be displayed on the internal called station’s keyset if PX provide CLI information.

- Calling line identification (CLI) or name which is matched with the speed dial list is displayed to original called party extension.
- First, The system search station speed dial buffer to find out the programmed name, and if there is not matched then search system speed dial buffer.(Not implemented Yet)
- CLI information will be printed in SMDR record through RS-232 port.

5. COLP (Connected Line Identification Presentation)

Each station user can send CLI information to called party through ISDN line if PX service this supplementary service.

There are 8 type of calling party number, But at this moment GDK only support four kinds of type. (UNKNOWN / NATIONAL TYPE / INTERNATIONAL / SUBSCRIBER)

- COLP field determines what is used to generate my CLI information in setup message, it indicate entry of CO Base Program (Main Menu3) - ISDN Line Attribute(Sub Menu2) - OLP(00)(Terminal Menu1).
- When a internal user seize a ISDN(DID) line which is programmed for COLP, GDK system will make calling party number using ISDN COLP TABLE and extension number in setup message.
- UNKNOWN TYPE :
 - Insert the calling station number at calling party number information field in setup message.
- NATIONAL TYPE :
 - ① Insert my area code if exist. ISDN Program (Main Menu4) - My Area Code (Sub Menu6)
 - ② Insert prefix of COLP number. ISDN Program(Main Menu4) - COLP Table(Sub Menu8)
 - ③ Insert the calling station number.

Ex) The calling station(100) seize a ISDN line 01 which is programmed as COLP(01), COLP Table(Main Menu4 - Sub Menu 8) (01 : "5001", prefix of COLP number) and MY AREA CODE(0343).
CLI in setup message : "03435001100"
- INTERNATIONAL TYPE :
 - ① Insert my nation code if exist. ISDN Program (Main Menu4) - My Nation Code (Sub Menu7)
 - ② Insert my area code if exist. ISDN Program (Main Menu4) - My Area Code (Sub Menu6)
 - ③ Insert prefix of COLP number. ISDN Program(Main Menu4) - COLP Table(Sub Menu8)
 - ④ Insert the calling station number.

Ex) The calling station(100) seize a ISDN line 01 which is programmed as COLP(01), COLP Table(Main Menu4 - Sub Menu 8) (01 : "5001", prefix of COLP number) ,MY AREA CODE(0343) and MY Nation Code(82).
CLI in setup message : "8203435001100"
- SUBSCRIBER TYPE :
 - ① Insert prefix of COLP number. ISDN Program(Main Menu4) - COLP Table(Sub Menu8)
 - ② Insert the calling station number.

Ex) The calling station(100) seize a ISDN line 01 which is programmed as COLP(01), COLP Table(Main Menu4 - Sub Menu 8) (01 : "5001", prefix of COLP number), MY AREA CODE(0343) and MY Nation Code(82).
CLI in setup message : "5001100"

SECTION 5. CAPACITIES & FEATURE CODES

5.1 SYSTEM CAPACITIES

ITEM	FP II	GDK-20W	REMARK
Max No of Stations	67	34	
Max No of CO lines	34	8	
Max DSS/DLS Console per station	2	0	
No of CO line Groups	9	4	
No of Attendants	5	1	
No of Internal Page Zones	5	2	
No of System Speed Dial Bins	200	79	
No of Station Speed Dial Bins Per Station	20	20	
No of SMDR Records	100 (Option 1900)	-	
No of External Relays	2	2	
No of Power Failure Circuit	2	0	
Number of Automatic Fax Transfer	-	1	
Number of DVIB	2	1	
Number of Channel / DVIB	8	2	
Max Record Time	System : 3 Minutes User : 17 Minutes 30 Seconds	68 Minutes (Basic)	Additional 70-minute record time is available with the optional board installed. Total number of messages is 400 with the option.
Number of User Voice Messages	250 EA	200 EA (Basic)	
Default Voice Data	Prompts	Prompts	
Battery Backup Voice Messages	System Announcements	All the messages	All the messages are saved with the backup switch on. When backup switch is set off, only system greetings and prompts are saved. Recorded user messages are deleted after reset.
Number of Station Group	8	4	
Max Number of Member in Group	32 Stations	10 Stations	

5.2 FEATURE CODES

5.2.1 NUMBERING PLAN*¹

FEATURES	CODES	REMARKS
Station Intercom Number	100 - 133	Programmable 100 - 499
CO Line Access ,Group	81-84	
CO Line Access ,Individual	881-888	
Retrieve a Held CO Line - Individual	8#1 - 8#8	SLT
Retrieve a Held CO Line	8##	SLT
Attendant	0	
CO Line Access, First Accessible Group	9	
Call Waiting (Camp-on)	*	ICM Busy Tone
Page, All Call	#0	B
Page, Internal Zone	#1 - #2	B
External Page	#3	
Page, Meet Me	#6, [HOLD/SAVE]	B (#6)
SLT, Last Number Redial (LNR)	52	SLT
SLT, DND	53	SLT, WHTU
SLT, Call Forward	54	SLT, WHTU
SLT, Speed Dial, Program	55	SLT
SLT, Speed Dial, Access	58	SLT
Alarm Reset	65	B
Pick-Up	66	B
UNA	69	B
2/8 Btn, Message Wait / Call Back - Request	[PGM]+56	2/8 Button
2/8 Btn, Message Wait - Answer	57	2/8 Button
SLT, CO Flash	Hook Flash + 51	SLT
SLT, Call Waiting (Camp-on)	Hook Flash + *	SLT, ICM Busy Tone
SLT, Message Wait / Call Back	Hook Flash + 56	SLT
SLT, CO Hold	Hook Flash + 59	SLT
Attendant, Clock Set	[PGM]+#1	Attendant
Admin Program Start	[PGM]+*#	100
Attendant, Date Format Change	[PGM]+*5	Attendant
Attendant, Time Format Change	[PGM]+*6	Attendant
Attendant, WHTU Subscribe/ De-subscribe	[PGM]+##	Attendant
Version Display	[PGM]+40	
Wake-Up Program	[PGM]+41	Station, Attendant
Wake-Up Cancel	[PGM]+42	Station, Attendant
ICM Signal Mode - HF/TN/PV	[PGM]+49 + 1/2/3	Keypad only
Differential Ring	[PGM]+50+1/2/3/4	Keypad only
COLR Key	[PGM]+58	B Only
BGM	[PGM]+73	B
Loop Key	[PGM]+84	B Only
Call Wait Key	[PGM]+85	B Only
SPEED Key	[PGM]+90	B Only, 2/8 Button Only
CONF Key	[PGM]+91	B Only, 2/8 Button Only
CALL BK Key	[PGM]+92	B Only, 2/8 Button Only
DND Key	[PGM]+93	B Only, 2/8 Button Only
MUTE Key	[PGM]+95	B Only, 2/8 Button Only
REDIAL Key	[PGM]+97	B Only, 2/8 Button Only
Last Number Redial (LNR)	[SPEED]+*, [REDIAL]	
Door Open	#*1-2	

FEATURES	CODES	REMARKS
DVIB – Recording System Announcements	[TRANS/PGM]+#4	Attendant
DVIB – Recording User Greeting (With DVIB Station Forward Timer)	[MON]+[DND/FOR]+7+#	Note 1)
DVIB – Recording User Greeting (With fixed 4 seconds timer)	-	Note 1)
Call Forward to DVIB Port (With DVIB Station Forward Timer)	[MON]+[DND/FOR]+7	Note 2)
Call Forward to DVIB Port (With fixed 4 seconds timer)	-	Note 2)
DVIB – Delete User Greeting	[MON]+[DND/FOR]+7+*	Note 3)
Call Forward – Cancel	[MON]+[DND/FOR]+#	Note 4)
To Set Current Time - 1 Hour early	[TRANS/PGM]+*1	Attendant
To Set Current Time - 1 Hour late	[TRANS/PGM]+*2	Attendant
Station Pilot Number	61-64	
VM MSG Wait Enable	*8	
VM MSG Wait Disable	*9	
ISDN Supplementary HOLD	[TRANS/PGM]+*75#	Button Only
ISDN Supplementary CONF	[TRANS/PGM]+*77#	Button Only
Two Way Recording	[TRANS/PGM]+#4	Button Only

*1: Numbering Plan can be changed according to nation.

*2: B - Button program is available.

*3: WHTU : Wireless Handset Telephone Unit.

Note 1) Call Forward to DVIB is activated after recording User Greeting. When user dials forward type “7” and if there is recorded User Greeting already, then user may not record User Greeting again and recorded User Greeting is used.

Note 2) User Greeting should be recorded before Call Forward to DVIB port. When user hangs up after the forward type “7” and if there is no recorded User Greeting, then forward is not activated.

Note 3) If a station is forwarded to DVIB port, Call Forward is canceled after deleting User Greeting.

Note 4) Only Call Forward to DVIB port is canceled and recorded User Greeting is not deleted. User can delete User Greeting by [MON]+[DND/FOR]+7+*.

Note 5) WHTU is able to support some features in Numbering Plan. To access feature codes in numbering plan, you should press **[ON/OFF (↔)]** button at first. If the **[FUNCTION(→)]** button is pressed (in case of GDC-340H, **OK button is pressed longer than 1 second**) at first, WHTU(LG GAP phone) will enter WHTU local program mode. So you are going to program or access features in system, you should press **[ON/OFF(↔)]** button at first. The **[FUNCTION(→)]** button (in case of GDC-340H, **OK button pressed longer than 1second**) is same as the [TRANS/PGM] button of DKTU.

5.2.2 BASIC AND EXTENDED NUMBERING PLANS

FEATURES	BASIC	EXTENSION	REMARKS
Station Intercom Number	10-49 or 100 - 499	10-99 or 100-999	2 or 3 digit station numbers by Admin
CO Line Access ,Group	81-84	*81-*84	
CO Line Access, Loop	85	*85	
CO Line Access ,Individual	881-888	*881-*888	
Retrieve a Held CO Line - Individual	8#1 - 8#8	*8#1 - *8#8	SLT
Retrieve a Held CO Line	8##	*8##	SLT
Attendant	0	0	
CO Line Access, First Accessible Group	9	*9	
Call Waiting (Camp-on)	*	*	ICM Busy Tone
Page, All Call	#0	#0	B ^{*1}
Page, Internal Zone	#1 - #2	#1 - #2	B
External Page	#3	#3	
Page, Meet Me	#6, [HOLD/SAVE]	#6, [HOLD/SAVE]	B (#6)
SLT, Last Number Redial (LNR)	52	*52	SLT
SLT, DND	53	*53	SLT/WHTU ^{*2}
SLT, Call Forward	54	*54	SLT/WHTU
SLT, Speed Dial, Program	55	*55	SLT
SLT, Speed Dial, Access	58	*58	SLT
Alarm Reset	65	*65	B
Pick-Up	66	*66	B
UNA	69	*69	B
2/8 Btn, Message Wait / Call Back - Request	[PGM] + 56	[PGM] + #56	2/8 Button
2/8 Btn, Message Wait - Answer	57	*57	2/8 Button
SLT, CO Flash	Hook Flash + 51	Hook Flash + #51	SLT
SLT, Call Waiting (Camp-on)	Hook Flash + *	Hook Flash + *	SLT, ICM Busy Tone
SLT, Message Wait / Call Back	Hook Flash + 56	Hook Flash + #56	SLT
SLT, CO Hold	Hook Flash + 59	Hook Flash + #59	SLT

*1: B - Button program is available.

*2: WHTU - Wireless Handset Telephone Unit

Remark) Extension Numbering Plan will be selected by Admin Program.

5.2.3 LCD MONTHS

	1	2	3	4	5	6	7	8	9	10	11	12
English	JAN	FEB	MAR	APR	MAY	JUN	JUL	AUG	SEP	OCT	NOV	DEC
Italian	GEN	FEB	MAR	APR	MAG	GIU	LUG	AGO	SET	OTT	NOV	DIC
Finnish	01	02	03	04	05	06	07	08	09	10	11	12
Danish	JAN	FEB	MAR	APR	MAJ	JUN	JUL	AUG	SEP	OKT	NOV	DEC
Dutch	JAN	FEB	MRT	APR	MEI	JUN	JUL	AUG	SEP	OKT	NOV	DEC
Swedish	JAN	FEB	MAR	APR	MAJ	JUN	JUL	AUG	SEP	OKT	NOV	DEC
Norwegian	JAN	FEB	MAR	APR	MAI	JUN	JUL	AUG	SEP	OKT	NOV	DES
German	JAN	FEB	MAR	APR	MAI	JUN	JUL	AUG	SEP	OKT	NOV	DEZ
Spanish	ENE	FEB	MAR	ABR	MAY	JUN	JUL	AGO	SEP	OCT	NOV	DIC

* Finnish example of date:

- 30-07-98 (In case of DDMMYY order, System Base Program(Main Menu5) - LCD Display Mode (Sub Menu4)

5.2.4 AUDIBLE SIGNALS

TONE / RING	CADENCE	
Alarm Ring, Continuous		0.2 sec ON / 0.2 sec OFF Repeat
Alarm Ring, Single		1 sec ON
All Call Page Tone		1 sec ON
Busy Tone	Australia	0.35 sec ON / 0.35 sec OFF Repeat
	Finland, EU	0.3 sec ON / 0.3 sec OFF Repeat
	Spain	0.2 sec ON / 0.2 sec OFF Repeat
	Sweden Denmark	0.25 sec ON / 0.25 sec OFF Repeat
	Others	0.5 sec ON / 0.5 sec OFF Repeat
CO Ring Back Tone	New Zealand	1 sec ON / 3 sec OFF Repeat
	Others	1 sec ON / 2 sec OFF Repeat
CO Ring	Finland Italy	1 sec ON / 4 sec OFF Repeat
	Others	0.4 sec ON / 0.4 sec OFF / 0.4 sec ON / 2 sec OFF Repeat
LCR Dummy CO Dial Tone		Continuous
Confirm Tone		1.2 sec ON
DND Tone		0.2 sec ON / 0.2 sec OFF / 0.2 sec ON / 0.2 sec OFF / 0.2 sec ON / 0.5 sec OFF Repeat
Dial Tone	Finland	0.2 sec ON / 0.3 sec OFF / 0.2 sec ON / 0.3 sec OFF / 0.2 sec ON / 0.8 sec OFF Repeat
	EU	0.2 sec ON / 0.3 sec OFF / 0.7 sec ON / 0.8 sec Off Repeat
	Others	Continuous
Error Tone	Australia	2.5 sec ON / 0.5 sec OFF Repeat
	Finland Italy	0.2 sec ON / 0.2 sec OFF Repeat
	Spain	0.6 sec ON / 1 sec OFF Repeat
	Sweden	0.25 sec ON / 0.75 sec OFF Repeat
	Others	0.25 sec ON / 0.25 sec OFF Repeat
HFTB Warning Tone		0.2 sec ON / 0.2 sec OFF 3 Times
Intercom Ring	Finland	0.6 sec ON / 0.2 sec OFF / 0.6 sec ON / 4 sec OFF Repeat
	Italy	0.6 sec ON / 0.2 sec OFF / 0.2 sec ON / 4 sec OFF Repeat
	Others	0.8 sec ON / 2.4 sec OFF Repeat
Reminder Tone		0.5 sec ON / 0.5 sec OFF 3 Times
Ring Back Tone	Australia New Zealand	0.4 sec ON / 0.2 sec OFF / 0.4 sec ON / 2 sec OFF Repeat
	Denmark Finland EU Italy Netherlands Norway	1 sec ON / 4 sec OFF Repeat
	Spain	1.5 sec ON / 3 sec OFF Repeat
	Sweden	1 sec ON / 5 sec OFF Repeat
	Others	1 sec ON / 2 sec OFF Repeat

- SLT

SLT RING	CADENCE	
SLT CO Ring	Finland, Italy	1 sec ON / 4 sec OFF Repeat
	New Zealand	0.4 sec ON / 0.2 sec OFF / 0.4 sec ON / 2 sec OFF Repeat
	Spain	1 sec ON / 3 sec OFF Repeat
	Others	0.4 sec ON / 0.2 sec OFF / 0.4 sec ON / 4 sec OFF Repeat
SLT Intercom Ring	Finland	0.4 sec ON / 0.2 sec OFF / 0.4 sec ON / 4 sec OFF Repeat
	Italy	0.6 sec ON / 0.2 sec OFF / 0.2 sec ON / 4 sec OFF Repeat
	New Zealand	1 sec ON / 2 sec OFF Repeat
	Spain	0.4 sec ON / 0.2 sec OFF / 0.4 sec ON / 3 sec OFF Repeat
	Others	1 sec ON / 4 sec OFF Repeat

5.2.5 FREQUENCIES AND TONES

5.2.6 GDK-20W CONFIGURATION

Basic STA	Basic Base Station	WTIB SLOT Base Station	CO SLOT1	CO SLOT2	TOTAL
4 key + 2 slt (4 port with 2B)	1 Base Station (4 Simultaneous Wireless Calls)	2 Base Station (8 Simultaneous Wireless Calls)	LCOB /LCOB2/STIB/STIB2 LCOB : 2LCO LCOB2 :4LCO STIB : 1T0 STIB2 : 1T0 + 1T0/1S0		STA : 100-103 (DKTU) 104-105(SLT) STA : 106-109(LKD 2B DKTU In primary 100-103) WHTU :110-129 CO : CO1 – CO8 or CO : CO1-CO4 and 4 S0 Station (130-133)

5.2.7 GDK-20W STATION CONFIGURATION WITH LKD 2B

BASIC	DEFAULT STA NUMBER
4 LKD 2B + 2 slt	100 -105 : 4 LKD 2B Primary devices and 2 slts 106 -109 : Secondary devices of 100-103 (LKD 2B DKTU) 110 -129 : Wireless Telephones 130 -133 : 4 S0 stations in two STIB2 SLOTS

- 1) LKD 2B occupies 4 station numbers, one for the Primary device and the other for the Secondary device. ***It can be connected to Basic 4 DKT ports.***
- 2) If LKD 2B is connected to any 4 DKT port in MBU, it occupies only 1 station number, for the Primary device. It means that the station can not have any Secondary device even if there is DTIU or SLIU for the Secondary device in it.
- 3) LKD 2B without either DTIU or SLIU(Basic LKD 2B) occupies 1 station number, for the Primary device.
- 4) Note: DTIU, SLIU are the sub boards in LKD 2B for the Secondary device DKTU or SLT.

5.2.8 MAXIMUM NUMBER OF STATIONS IN GDK-20W : 34 PORTS

NUMBER OF PORTS	DEFAULT STATION NUMBER	DESCRIPTION
6	100-105	4 Basic DKT ports and 2 Basic slt ports
4	106-109	4 Secondary devices for 4 basic DKT ports
20	110-129	Registrable Max. Wireless Telephones (Max. Simultaneous Wireless Call : 12)
4	130-133	4 S0 stations in STIB second S0 (When STIB2 is installed in SLOT2 and 3)

5.2.9 MAXIMUM NUMBER OF CO LINES IN GDK-20W : 8 PORTS

NUMBER OF PORTS	DEFAULT CO NUMBER	DESCRIPTION
8	CO 1-8	STIB2 or LCOB2 in SLOT 2 and 3 (4 BRI in STIB 2T0 or 4 LCO in LCOB2)

5.2.10 MAXIMUM NUMBER OF PORTS (STATION / CO) IN GDK-20W : 38 PORTS

NUMBER OF PORTS	DEFAULT NUMBER	DESCRIPTION
6	100-105	4 Basic DKT ports and 2 Basic slt ports.
4	106-109	for 4 basic DKT ports
20	110 -129	20 Wireless Terminals
8	CO 1-8	8 BRI or 8 LCO
	CO 1-4 or 130-133	4 BRI / 4 S0 stations in STIB2 on SLOT2 and 3

5.2.11 WIRELESS CELL / TERMINAL CONFIGURATION

Number of Cell (Base station)	Recommended Number of Registered Wireless Terminals	Number of maximum Simultaneous Wireless Conversation
1	20	4
2		8
3		12

5.2.12 GAIN CONTROL(SYSTEM BASE(MAIN MENU 5) - (SUB MENU 14))

- Digital Keypad RX Gain

Country	DKTU	SLT	CO	DCO	DTMF	Tone	DVU	Int Music	Ext Music	WHTU
Australia	22	19	14	30	8	32	20	22	22	22
Belgium	33	27	21	21	8	33	20	33	33	33
CIS	25	24	29	32	8	32	32	29	29	25
Denmark	17	13	16	26	8	33	32	26	26	17
Finland	25	27	30	29	8	32	32	29	29	25
Germany	25	35	29	29	8	15	32	26	26	25
Italy	17	13	16	26	8	33	20	26	26	17
Netherlands	32	24	10	21	8	33	32	33	33	32
New Zealand	10	12	16	32	8	32	20	32	32	10
Norway	30	24	38	32	8	33	32	26	26	30
Spain	26	28	28	33	8	32	32	29	29	26
Sweden	26	21	31	26	8	33	32	25	25	26
UK	25	35	29	15	8	15	32	26	26	25
EU	25	35	16	15	8	15	32	29	29	25
Others	21	36	33	33	8	32	32	29	29	21

GDK-20W DIGITAL WIRELESS KEY TELEPHONE SYSTEM

- SLT Rx Gain

Country	DKTU	SLT	CO	DCO	DTMF	Tone	DVU	Int Music	Ext Music	WHTU
Australia	36	32	32	32	4	46	32	36	36	36
Belgium	27	21	26	26	4	36	32	29	29	27
CIS	32	32	32	32	4	53	32	32	32	32
Denmark	27	32	32	32	4	30	32	37	37	27
Finland	26	16	32	23	4	32	32	29	29	26
Germany	36	38	32	23	4	27	32	29	29	36
Italy	27	32	32	32	4	30	32	37	37	27
Netherlands	39	32	32	26	4	38	32	32	32	39
New Zealand	28	32	32	29	4	50	32	50	50	28
Norway	15	32	36	32	4	45	32	18	18	15
Spain	26	32	32	24	4	32	32	32	32	26
Sweden	28	32	32	28	4	39	32	31	31	28
UK	36	32	32	23	4	27	32	29	29	36
EU	32	32	32	32	4	32	32	32	32	36
Others	10	30	21	24	4	32	32	20	20	10

- CO Line Rx Gain

Country	DKTU	SLT	CO	DCO	DTMF	Tone	DVU	Int Music	Ext Music	WHTU
Australia	34	32	24	32	31	29	32	32	32	34
Belgium	21	29	26	26	38	36	32	37	37	21
CIS	35	32	24	32	43	32	32	32	32	35
Denmark	34	32	16	20	32	39	32	32	32	34
Finland	23	32	28	32	32	32	32	32	32	23
Germany	35	31	32	32	19	29	32	29	29	35
Italy	34	32	26	30	38	39	32	32	32	34
Netherlands	28	32	24	26	31	43	32	32	32	28
New Zealand	33	32	24	31	27	33	32	50	50	33
Norway	38	32	24	32	38	37	32	27	27	38
Spain	30	28	28	24	36	32	32	32	32	30
Sweden	31	32	32	32	34	41	32	27	27	31
UK	35	32	32	32	23	10	32	29	29	35
EU	35	32	24	32	30	32	32	32	32	34
Others	19	36	24	24	28	32	32	32	32	19

* Note : In Italy, all tones provided during conversation should be decreased by 5db.

GDK-20W DIGITAL WIRELESS KEY TELEPHONE SYSTEM

- CO Gain Table

Country	DKTU	SLT	CO	DCO	DTMF	Tone	DVU	Int Music	Ext Music	WHTU
Australia	31	32	26	32	28	32	32	32	32	31
Belgium	21	29	26	32	38	36	32	37	37	21
CIS	32	32	26	32	25	32	32	32	32	32
Denmark	32	32	20	32	32	37	32	38	38	32
Finland	35	32	32	32	25	37	32	29	29	35
Germany	35	32	32	32	25	37	32	29	29	35
Italy	32	32	28	32	32	37	32	38	38	32
Netherlands	21	29	26	32	26	36	32	37	37	21
New Zealand	32	27	26	32	28	32	32	50	50	32
Norway	36	32	26	32	32	37	32	27	27	36
Spain	26	37	30	32	32	32	32	32	32	26
Sweden	30	37	32	32	32	40	32	26	26	30
UK	30	32	32	29	25	37	32	29	29	30
EU	32	32	26	32	25	32	32	32	32	30
Others	26	37	24	32	32	32	32	32	32	26

- DVU Rx Gain

Country	DKTU	SLT	CO	DCO	External Music	WHTU
Australia	26	32	32	32	32	32
Belgium	26	32	32	32	32	32
CIS	26	32	31	32	32	26
Denmark	26	32	32	32	32	32
Finland	26	32	32	32	32	32
Germany	26	32	32	32	32	32
Italy	26	32	32	32	32	32
Netherlands	26	32	32	32	32	32
New Zealand	26	32	32	32	32	32
Norway	26	32	32	32	32	32
Spain	26	32	32	32	32	32
Sweden	26	32	32	32	32	32
UK	26	32	32	32	32	32
EU	26	32	32	32	32	32
Others	26	32	32	32	32	32

- DTMF RECEIVER Rx Gain

Country	SLT	CO	DCO
Australia	32	16	32
Belgium	24	24	24
CIS	20	24	24
Denmark	35	24	34
Finland	26	24	32
Germany	32	32	32
Italy	35	24	34
Netherlands	21	11	24
New Zealand	34	16	32
Norway	32	32	32
Spain	20	24	24
Sweden	36	34	18
UK	32	32	32
EU	20	24	24
Others	37	24	24

- Conversion detected pulse to digit

Country \ # of Pulse	1	2	3	4	5	6	7	8	9	10
New Zealand	9	8	7	6	5	4	3	2	1	0
Sweden	0	1	2	3	4	5	6	7	8	9
Others	1	2	3	4	5	6	7	8	9	0

- Conversion dialed digit to pulse

Country \ Digit	1	2	3	4	5	6	7	8	9	0
New Zealand	9	8	7	6	5	4	3	2	1	10
Sweden	2	3	4	5	6	7	8	9	10	1
Others	1	2	3	4	5	6	7	8	9	10

- Wireless Handy Terminal Unit

Country	DKTU	SLT	CO	DCO	DTMF	Tone	DVU	Int Music	Ext Music	WHTU
Australia	22	19	14	30	8	32	20	22	22	22
Belgium	33	27	21	21	8	33	20	33	33	33
CIS	25	24	29	32	8	32	32	29	29	25
Denmark	17	13	16	26	8	33	32	26	26	17
Finland	25	27	30	29	8	32	32	29	29	25
Germany	25	35	29	29	8	15	32	26	26	25
Italy	17	13	16	26	8	33	20	26	26	17
Netherlands	32	24	10	21	8	33	32	33	33	32
New Zealand	10	12	16	32	8	32	20	32	32	10
Norway	30	24	38	32	8	33	32	26	26	30
Spain	26	28	28	33	8	32	32	29	29	26
Sweden	26	21	31	26	8	33	32	25	25	26
UK	25	35	29	15	8	15	32	26	26	25
EU	25	35	16	15	8	15	32	29	29	25
Others	21	36	33	33	8	32	32	29	29	21

SECTION 6. ADMIN PROGRAMMING

6.1 GENERAL DESCRIPTION

6.1.1 INTRODUCTION

The GDK-20W Key Telephone System can be programmed to meet each customer's individual need. All programming is done at station 100(DKT 1) using KD-24D, KD-36D, LKD-30D digital key telephone.

Upon entering the program mode, the key telephone at station 100 cannot operate as a normal telephone but as a programming instrument with all of the buttons redefined. The keys of the dial pad are used to enter the various data fields and to enter numerical information. The 24 buttons located at the top of the phone (Flex Buttons) are used to indicate the specific data field and to enter information. Sometimes **[SPEED]** button is used to delete the data.

See **TABLE 6.2.2.1 - 6.2.2.10** for default data. If this pre-programming suits the customer, additional Admin program is not necessary. To change admin data, the user enter the admin. programming mode and select program code. During Admin programming, other keysets in the system operate normally.

When Admin programming, LCD and LED's indicate current programmed data and status. If the programmer enters correct data, then LCD and LED's show the entered data and the data is stored in the temporary buffer area. Real system databases is not changed and has no effect on telephone operation unless permanent updating procedure is executed. Pressing **[HOLD/SAVE]** button, all data in the temporary buffer (same as LCD and LED's show their status) is saved into permanent memory. Tones are provided to let the programmer know whether data entry is correct (confirmation tone) or not (error tone).

6.1.2 TO ENTER THE PROGRAMMING MODE

1. Lift handset or press the **[MON]** button on the admin station, and hear ICM dial tone (optional),
2. Press **[TRANS/PGM]** button and dials ***#** (confirmation tone heard),
3. Enter Admin. Password if the password has been set. This procedure places the station into the Admin. programming mode (confirmation tone heard). And LCD will displays the first step of Admin. programming.(below LCD)

ADMIN PROGRAM START PRESS FLEX KEY(1-12)

6.1.3 HOW TO PROGRAM

1. There are 12 main-menus in the Admin. Programming mode.
2. Each main program has several sub-menus and each sub-menu can have several terminal menus(sub-menus of a sub-menu), but some sub-menus don't have any terminal-menus(It means that sub-menus are terminal-menus in this case). Refer the followings.

MAIN-MENU

- A main-menu has several sub-menus.
- To select a sub-menu, press a flex-key responding to the sub-menu number.



SUB-MENU

- A sub-menu may have several terminal-menus, but some sub-menus may not.
- To select a terminal-menu, press a flex-key responding to the terminal-menu number.



TERMINAL-MENU

- Enter data at the terminal-menu with dialing digits or flex-keys.

6.1.3.1 Example of Admin. Program

PROCEDURE

-
- | | |
|--|--|
| ADMIN PROGRAM START
PRESS FLEX KEY(1-12) | (1) When the user enter Admin. mode, LCD displays the first message. Press a flex-key to select a main-menu among 12 main-menus.(If the user program does not include LCR-package, the user cannot enter main-menu 10) |
| STA PGM
ENTER STA RANGE | (2) The user selected the 2 nd main-menu, "STATION BASE PROGRAM", by pressing the 2 nd flex-key in step 1. Dial station range. (The second station number must be more than or equal to the first station number) |
| STA PGM,100-100
PRESS FLEX KEY(1-8) | (3) And then, press a flex key(1-8) or ▲/▼.
① Flex key(1-8):Select a sub-menu of STA BASE PROGRAM .
②▲:Move to the next main-menu, CO LINE BASE PROGRAM .
▼:Move to the previous main-menu, INITIALIZATION . |
| STA PGM,100-115,ATTRIBUT
PRESS FLEX KEY(1-10) | (4) If the user press a flex key 1, the LCD displays as the left side. |
| STA PGM,100-115, DND
YES | (5) If the user press a flex key 1, the LCD displays as the left side. And then press a flex key 1 to change the current value. Press [HOLD/SAVE] to update the database permanently.
: ▲/▼ : Go to the other same level menu.
- [TRANS/PGM] : Go to the Admin. start menu.
- [REDIAL] : Go to the 1 level upper menu. |
-

6.1.4 BUTTON DEFINITION

Buttons are used for the following purposes in the Admin. program mode.

- (1) **[HOLD/SAVE]** : Update the system database permanently.
- (2) **[TRANS/PGM]** : Move to the start of admin program menu.
- (3) **[REDIAL]** : Move to the 1 level upper level menu.
(SUB-MENU → MAIN-MENU or TERMINAL-MENU → SUB-MENU)
- (4) **▲**: Move to the next menu in the same level.(Round-robin)
(Ex : DND(1st terminal-menu of STATION ATTRIBUTE) → SPEED DIAL ACCESS(2nd terminal-menu of STATION ATTRIBUTE)
▼: Move to the previous menu in the same level.(Round-robin)
(Ex 1 : INITIALIZATION(1st main-menu) → PRINT DATABSE(last main-menu)
Ex 2 : STATION CLASS OF SERVICE(3rd sub-menu of 2nd main-menu) → ISDN STATION ATTRIBUTE(2nd sub-menu of 2nd main-menu))
- (5) **[SPEED]** : Clear database of the current terminal menu.
- (6) **FLEX-KEY** : 1. Used for selecting a menu (main/sub/terminal) responding to the number.
2. Also used as toggle key for entering data, if entered value has only 2 case number. (i.e: Yes/No, Enable/Disable)
- (7) **DIGIT** : Used for entering data by dialing.

6.2 ADMIN PROGRAMMING

6.2.1 ADMIN PROGRAMMING INDEX

FLEX KEY	MAIN MENU	FLEX KEY	SUB MENU
1	Initialization (DB INIT)	1 2 3 4 5 6 7 8 9 10 11	Station Database Initialization CO Line Database Initialization ISDN Tables Database Initialization System Feature Database Initialization System Timer Database Initialization Toll Table Database Initialization Authorization Code Table Database Initialization Flexible Station Number Initialization Flexible Button Program Initialization LCR Database Initialization All Database Initialization
2	Station Base Program (STA PGM)	1 2 3 4 5 6 7 8	Station Attribute ISDN Station Attribute Station Class-Of-Service CO Line Group Access Preset Call Forward Flex Buttons Assignment Warm Line Selection Page Zone
3	CO Line Base Program (CO PGM)	1 2 3 4 5 6 7	CO Line Attribute ISDN CO Line Attribute Group Assignment DISA Type CO Flash Timer CO Loop Supervision Timer CO Line Ring Assignment
4	ISDN Program (ISDN PGM)	1 2 3 4 5 6 7 8 9 10 11 12 13 14	TEI Type Calling Sub-Address Incoming Zero Insertion Outgoing Zero Insertion Outgoing Check Digit My Area Code My Nation Code Internal Code COLP Table (Entry no:01-10) MSN Table (Entry no:01-24) DID Digit Conversion Table Transfer Code Supplementary Service Loopback

GDK-20W DIGITAL WIRELESS KEY TELEPHONE SYSTEM

FLEX KEY	MAIN MENU	FLEX KEY	SUB MENU
5	System Base Program (SYS PGM)	1	System Attribute
		2	Attendant Assignment
		3	Setting System Date/Time
		4	LCD Date/Time Display Mode
		5	PBX Access Code
		6	DID/DISA Destination
		7	DISA Retry Counter
		8	SMDR Attributes
		9	Pulse Dial / Speed Ratio
		10	Alarm Attributes
		11	External Control Contact
		12	BGM(Background Music) Type
		13	MOH(Music On Hold) Type
		14	System Gain Control
		15	Fax Transfer CO Line
		16	External Page Port
		17	DID/DISA Forward to DVU
6	System Timers (SYS TMR)	Timer - 1	1 Exclusive Hold Recall Timer
			2 System Hold Recall Timer
			3 Transfer Hold Recall Timer
			4 I-Recall Timer
			5 Attendant Recall Timer
			6 CO Ring Detect Timer
			7 CO Ring Stop Detect Timer
			8 Pause Timer
			9 CO Release Guard Timer
			10 CO Dial Delay Timer
			11 Preset Forward Timer
			12 Call Forward Busy/No Answer Timer
			13 DID/DISA No Answer Timer
			14 Unsupervised Conference Timer
			15 MSG Wait Reminder Tone Timer
			16 Hook Switch Flash Timer
			17 Door Open Timer(Enhanced)
			18 Inter Digit Timer
			19 Warm Line Timer
			20 SMDR Timer
			21 Wake-up Fail Ring Timer
			22 Fax Tone Detect Timer
			23 Fax CO Call Timer
			24 DVU User Record Timer
Timer - 2	1 DVU Forward Answer Timer		
	2 Valid User Message Timer		
	3 Hunt User Record Timer		

FLEX KEY	MAIN MENU	FLEX KEY	SUB MENU		
7	Toll Table	1 2 3 4 5	Toll Exception Table – Allow A (Entry no:01-20) Toll Exception Table – Deny A (Entry no:01-10) Toll Exception Table – Allow B (Entry no:01-20) Toll Exception Table – Deny B (Entry no:01-10) 1. Canned Toll Table –Allow (Entry no:01-10) 2. Canned Toll Table –Deny (Entry no:01-10)		
8	Authorization Code Table (Author Code Table)	-	Authorization Code Table (Entry no:01-30)		
9	Flexible Numbering Plan	1	Numbering Plan Type(Extension / Basic)		
		2	Station Number Digit Size (3 / 2)		
		3	Flexible Station Number Assignment		
		1	Flexible number for port 1-24(flex 1-24)		
		2	Flexible number for port 25-34(flex 1-10)		
10	LCR Program	1 2 3 4 5	LCR Access Mode Day Zone Time Zone of Day Zone LDT Table DMT Table		
11	Station Group Program	Hunt Group	1	Group Type(Cir/Term/UCD/VM/Ring/None)	
			2	Group Member	
			3	Attribute of Hunt Group Type	
				Cir/Term	1
				2	Ring Timer
			UCD	1	First Announcement Timer
				2	Second Announcement Timer
				3	Announcement Timer
			VM	1	Ring Timer
				2	Put Mail Index
		3	Get Mail Index		
		VM Dialing Table	1 Put Mail 2 Get Mail 3 Busy 4 No Answer 5 Error 6 DND 7 Disconnect		
12	Print Database	1 2 3 4 5 6 7 8 9 10 11	Station Database Print CO Line Database Print ISDN Database Print System Feature Database Print System Timer Database Print Toll Table Print Authorization Code Table Print Flexible Station Number Print LCR Database Print Hunt Group/Voice Mail Table Print All Database Print		

6.2.2 DEFAULT VALUES

TABLE 6.2.2.1 STATION BASE PROGRAM (MAIN MENU 2)

NO	SUB MENU	FLEX KEY	TERMINAL MENU	RANGE	DEFAULT	REMARK
1	Station Attribute	1	DND (Do-Not-Disturb)	YES / NO	YES	
		2	Speed Dial Access	YES / NO	YES	
		3	Page Access	YES / NO	YES	
		4	Call Forward Access	YES / NO	YES	
		5	PLA (Preferred Line Answer)	YES / NO	YES	
		6	Speaker-Phone/Headset	SP / HEAD	Speaker-Phone	
		7	Auto Speaker Selection	YES / NO	YES	
		8	ICM Box Signaling	YES / NO	YES	
		9	Automatic Hold	YES/NO	Station1:YES Station2-34:NO	
		10	Data Line Security	YES/NO	NO	
		11	DVU Access	YES/NO	NO	
		12	Two Way Recording	YES/NO	NO	
				13	Bearer Capability 3.1KHz	YES/NO
2	ISDN Station Attribute	1	Sub Address	YES/NO	NO	If this field is set to YES, then GDK sends the called extension number in called party sub address information of setup message to ISDN extension.
		2	Long/Short	Long/Short	Short	
		3	MSN	YES/NO	NO	If this field is set to YES, then GDK sends the called extension number in called party number information of setup message to ISDN extension.
		4	COLR	YES/NO	NO	
		5	COLP	YES/NO	YES	
		6	CLIP	YES/NO	NO	
		7	CLIS	YES/NO	NO	
3	Station COS	-	Day COS/Night COS	11 - 77	11	2 Digit 1 st Digit-Day COS 2 nd Digit-Night COS
4	CO Group Access	1- 4	CO Line Group	1-4	1-4	1 st Flex : CO GRP 1 : 4 th Flex : CO GRP 4

NO	SUB MENU	FLEX KEY	TERMINAL MENU	RANGE	DEFAULT	REMARK
5	Preset Call Forward	-		Station No (2 Digit or 3 Digit)	Not Assigned	The ISDN station or ICM box cannot be assigned as preset call forward station.
6	Flex Buttons Assignment			1-6		Type
				-- 1-8 1-4 - STA No. SPD Bin No. (01-99)		1: User Button 2: CO x 3: Reserved 4: LOOP 5: STA xxx 6: SPD xx
7	Warm Line Selection	-		1-4	Not Assigned	1:Flex Button ¹⁾ 2:CO Line 3:CO Group 4:Station
8	Page Zone	-		1-2	1	1:Page Zone 1 2:Page Zone 2
9	Language Code	-		1-8	Each Nation's Language	Except for UK, IT, SP version

- 1) Under following conditions, flex. button cannot be assigned as warm line.
- If any station among entered range is SLT or 2B-SLT, you cannot save input value.
 - If you entered the bigger flex. button number than stations have, you cannot save input value.

TABLE 6.2.2.2 CO LINE BASE PROGRAM (MAIN MENU 3)

NO	SUB MENU	FLEX KEY	TERMINAL MENU	RANGE	DEFAULT	REMARK	
1	CO Line Attribute	1	CO Line Type	PBX / CO	CO		
		2	CO Line Signal Type	DTMF / Pulse	DTMF		
		3	Universal Night Answer (UNA)	Yes / No	No		
		4	Flash Type	Ground / Loop	Loop	Ground type is not available	
		5	DISA Account	Yes/No	No		
		6	Loop Supervision	Yes/No	No		
		7	DVU Announcement	Yes/No	No		
2	ISDN CO Line Attribute	1	COLP	00-10	00	00:Not Assigned 01-10:indicate an entry of Outgoing COLP table	
		2	DID_RN	00-99	00	00:Do not ignore 01-99:indicate an ignored called party number (DID_RN : DID removes number from called party information)	
		3	Type of Calling Number	0-8	2	0:Unknown number 1:International type 2:National number 3:Not used 4:Subscriber number 5:Not used 6:Not used 7:Not used 8:No send COLP	
		4	DID Line Use	Yes/No	No		
3	CO Line Group Assign	-		1 - 4	1		
4	DISA Type	-		U/Day/Night/Both	U	0/1/2/3	
5	CO Flash Timer	-	Ring to Hunt Group 1	000 - 300	008	10msec base	
6	CO Loop Supervision Timer	-		0 - 20	0	100msec base	
7	CO Line Ring Assignment	1	Ring to Station	No/Day/Night/Both	Station 1 : All ring Station 2-16: No ring	Flex key : Round-robin	
		2	1				Ring to Hunt Group1
			2				Ring to Hunt Group2
			3				Ring to Hunt Group3
			4				Ring to Hunt Group4

TABLE 6.2.2.3 ISDN PROGRAM (MAIN MENU 4)

FLEX KEY	SUB MENU	TERMINAL MENU	RANGE	DEFAULT	REMARK
1	TEI Type	-	Auto / Fixed	Auto (4 Ports)	After you changing TEI, press RESET button on MBU to operate with the new TEI type.
2	Calling Sub-Address	-	Yes / No	No	If this field is set to YES, then GDK sends the calling extension number in calling party sub address information of setup message.
3	Incoming Zero Insertion	-	Yes / No	No	
4	Outgoing Zero Insertion	-	Yes / No	Yes	
5	Outgoing Check Digit	-	0 – 9	0	
6	My Area Code	-	-	Not Assigned	
7	My Nation Code	-	-	Not Assigned	
8	International Code	-	4 Digits	Not Assigned	
9	COLP Table	-	Entry No (01-10)	Not Assigned	Max : 10 digits
10	MSN Table	-	Entry No (01-24)	Not Assigned	Flex key 1: CO line No.(1-8) Flex key 2: Station No (2 or 3 digits) Flex key 3: MSN No. (1-8) Flex key 4: Night destination (Station no(2digit/ 3digit) Or Station Group no(61-64)) Flex key 5:Night MSN (1-8) Flex key 6: Telephone No. (max: 20 digits)
11	DID Digits Conversion	1.DID Received Digit from PX	2 - 4	3	
		2.DID First Two Digits Conversion	DID Received Digit No	***	0 - 9 # : Ignore digit * : using received digit
		3.DID Second Digit Conversion	10 Digits	1234567890	
12	Transfer Code	-	2 Digits	* #	
13	Supplementary Service	1.Service Type	1. Hold/ Retrieve 2. 3-party Conf.	Keypad/ Functional	Keypad
		2.Hold Code		10 digits	Not Assigned
		3.Retrieve Code		10 digits	Not Assigned
		4.3-Party Conf. Code		10 digits	Not Assigned
14	Loop Back	-	Yes/No	No	

TABLE 6.2.2.4 SYSTEM BASE PROGRAM (MAIN MENU 5)

NO	SUB MENU	FLEX KEY	TERMINAL MENU	RANGE	DEFAULT	REMARK
1	System Attributes	1	Hold Preference	SYS / EXC	SYS	
		2	Privacy	YES / NO	YES	
		3	External Night Ring	YES / NO	NO	
		4	Multi-line Conference	YES / NO	NO	
		5	CO Line Choice	Last Choice / Round-robin	Last Choice	
		6	Override 1 st CO Group	YES / NO	NO	
		7	Night DVU	YES / NO	NO	
		8	Music on Camp-on	YES / NO	NO	Flex Key is not 8, but 9 in Spain ver.
2	Attendant Assignment	-		Station No. (2 Digits or 3 Digits)	100 (1 st Station)	ICM box cannot be assigned as attendant station.
3	Set System Date/Time	-				
4	LCD Display Mode	-		1-4	3 (12-DD/MM/YY)	1:24- DD/MM/YY 2:24- MM/DD/YY 3:12- DD/MM/YY 4:12- MM/DD/YY
5	PBX Access Code	-		MAX 2 Digits	Not Assigned	Max 4 PBX Access Codes
6	DID/DISA Destination	1	Busy Destination	Tone / ATD	Tone	
		2	Error Destination	Tone / ATD	Tone	
7	DISA Retry Counter		DISA Retry Counter	1-9	3	
8	SMDR Attributes	1	SMDR Print Enable	YES / NO	NO	
		2	SMDR Recording Call Type	All Call / Long Distance	All Call	
		3	Print Incoming Call	YES / NO	NO	
		4	SMDR Print Baud Rate (RS-232C)	1-8	6	
9	Dial Speed Ratio	-		60/40 or 66/33	66/33 (10 PPS Only)	
10	Alarm Attribute	1	Alarm Enable	YES / NO	NO	
		2	Alarm Contact Type	Close / Open	Close	
		3	Alarm Signal Mode	Repeat / Once	Repeat	
11	External Control Contact	1	First Contact	1-2 (Loud Bell /Door)	None	
		2	Second Contact		None	
12	BGM Type	-	-	1-3	1	1:Inetrnal 2:External 3:Both
13	MOH Type	-	-	1-2	1	1:Inetrnal 2:External

NO	SUB MENU	FLEX KEY	TERMINAL MENU	RANGE	DEFAULT	REMARK
14	System Gain Control	1	Digital Keypad Rx Gain	00-60		1. DKTU
						2. SLT
						3. CO
						4. DCO
						5. DTMF RX
						6. TONE
						7. DVU
						8. MUSIC1
						9. MUSIC2
						10.WHTU
		2	SLT Rx Gain	00-60		1. DKTU
						2. SLT
						3. CO
						4. DCO
						5. DTMF RX
						6. TONE
						7. DVU
						8. MUSIC1
						9. MUSIC2
						10.WHTU
		3	CO Line Rx Gain	00-60		1. DKTU
						2. SLT
						3. CO
						4. DCO
5. DTMF RX						
6. TONE						
7. DVU						
8. MUSIC1						
9. MUSIC2						
10.WHTU						
4	Digital CO Line (DCO) Rx Gain	00-60		1. DKTU		
				2. SLT		
				3. CO		
				4. DCO		
				5. DTMF RX		
				6. TONE		
				7. DVU		
				8. MUSIC1		
				9. MUSIC2		
				10.WHTU		
5	DVU Rx Gain	00-60		1.DKTU		
				2.SLT		
				3.CO		
				4.DCO		
				5.MUSIC2		
				6.WHTU		
6	DTMF Rx Gain	00-60		1.SLT		
				2.CO		
				3.DCO		

GDK-20W DIGITAL WIRELESS KEY TELEPHONE SYSTEM

NO	SUB MENU	FLEX KEY	TERMINAL MENU	RANGE	DEFAULT	REMARK
14	System Gain Control	7	WHTU Rx Gain	00-60		1. DKTU
						2. SLT
						3. CO
						4. DCO
						5. DTMF RX
						6. TONE
						7. DVU
						8. MUSIC1
						9. MUSIC2
						10. WHTU
15	Fax Transfer CO Line	-	-	1-8	None	
16	External Page Port	-	-	Station No.	None	Only SLT port
17	DID/DISA Forward To DVU	1	Busy	YES/NO	NO	
		2	No Answer	YES/NO	NO	

TABLE 6.2.2.5 SYSTEM TIMER PROGRAM (MAIN MENU 6)

NO	SUB MENU	FLEX KEY	SUB MENU	RANGE	DEFAULT	REMARK
1	TIMER 1	1	Exclusive Hold Recall Timer	000 - 300	060	1 sec base
		2	System Hold Recall Timer	000 - 300	030	1 sec base
		3	Transfer Recall Timer	000 - 300	030	1 sec base
		4	I-Hold Recall Timer	000 - 300	030	1 sec base
		5	Attendant Recall Timer	00 - 60	01	1 min base
		6	CO Ring Detect Timer	1 - 9	2	100 msec base
		7	CO Ring Stop Detect Timer	01 - 15	06	1 sec base
		8	Pause Timer	1 - 9	1	1 sec base
		9	CO Release Guard Timer	01 - 15	01	1 sec base
		10	CO Dial Delay Timer	00 - 99	05	100 msec base
		11	Preset Call Forward Timer	00 - 99	10	1 sec base
		12	Call Forward Busy/No Answer Timer	00 - 99	10	1 sec base
		13	DID/DISA No answer Timer	00 - 99	20	1 sec base
		14	Unsupervised Conference Timer	00 - 99	10	1 min base
		15	Message Reminder Tone Timer	00 - 60	00	1 min base
		16	Hook Switch Flash Timer	001 - 250	050	10 msec base This is max. Hook Flash time.
		17	Door Open Timer	05 - 99	20	100 msec base
		18	Inter-Digit Timer	01 - 20	05	1 sec base
		19	Warm Line Timer	01 - 20	05	1 sec base
		20	SMDR Start Timer	000 - 250	000	1 sec base
		21	Wake-up Fail Ring Timer	00 - 99	20	1 sec base
		22	FAX Tone Detect Timer	01 - 10	05	1 sec base
		23	FAX CO Call Timer	1 - 5	1	1 min base
		24	DVU User Record Timer	010 - 255	20	1 sec base
2	TIMER 2	1	DVU Forward Answer Timer	04 - 40	04	1 sec base
		2	Valid User Message Timer	00 - 10	04	1 sec base
		3	Hunt Disconnect Timer	01 - 10	03	1 min base

TABLE 6.2.2.6 TOLL TABLE (MAIN MENU 7)

FLEX KEY	SUB MENU	TERMINAL MENU	DEFAULT	REMARK
1	Allowed Table A	Entry No (01 - 20)	Not Assigned	Max : 8 digit
2	Denied Table A	Entry No (01 - 10)		Max : 8 digit
3	Allowed Table B	Entry No (01 - 20)		Max : 8 digit
4	Denied Table B	Entry No (01 - 10)		Max : 8 digit
5	Canned Toll Table : Allow	Entry No (01 - 10)		Max : 8 digit
	Canned Toll Table : Deny	Entry No (01 - 10)		Max : 8 digit

TABLE 6.2.2.7 AUTHORIZATION CODE TABLE (MAIN MENU 8)

SUB MENU	FLEX KEY	TERMINAL MENU	RANGE	DEFAULT	REMARK
Authorization Code Tables	-	Entry No (01-30)	5 Digit	Not Assigned	

TABLE 6.2.2.8 FLEXIBLE STATION NUMBERING PLAN (MAIN MENU 9)

SUB MENU	FLEX KEY	TERMINAL MENU	RANGE	DEFAULT	REMARK
Numbering Plan Type	-	-	Extension / Basic	Basic	
STA Number Digit Size	-	-	3 / 2	3	
Flexible Station Number	1	Flex number for port 1-24	FLEX KEY 1-24	100-123	Each flex key denotes corresponding station.
	2	Flex number for port 24-34	FLEX KEY 1-10	124-133	

TABLE 6.2.2.9 LCR PROGRAM (MAIN MENU 10)

FLEX KEY	SUB MENU	RANGE	DEFAULT	REMARK
1	LCR Access	3-way toggle - DISABLE - OVERRIDE - ALWAYS	Disable	
2	Day Zone	F1: Zone 1. Day : 1 - 7	1-7	Each day belongs to only one day zone.
		F2: Zone 2. Day : 1 - 7	-	
		F3: Zone 3. Day : 1 - 7	-	
3	Time Zone	F1: Zone 1. Time : 00 – 24	00-24	Each hour belongs to only one time zone.
		F2: Zone 2. Time : 00 – 24	-	
		F3: Zone 3. Time : 00 – 24	-	
4	LDT (Leading Digit Table)	00 – 99 (total:100)	None	F1: LCR type, BOTH / INT / COL. F2: CD 12 digits F3: DMT index. 6 digits. Total three DMT indices for each time zone1/2/3 • F1 – Day zone 1 index to the DMT. • F2 – Day zone 2 index to the DMT. • F3 – Day zone 3 index to the DMT.
5	DMT (Digit Modification Table)	00 – 99 (total:100)	None	F1: A (Added digit stream). 25digits. F2: RP (Removal Position). 2digits. F3: RN (Removal Number of digits of CODE in each table) 2 digits F4: AP (Add Position). 2digits. F5: CG (CO group). 1 digit. F6: ALT(Alternative DMT index). 2digits.

TABLE 6.2.2.10 HUNT GROUP/VOICE MAIL PROGRAM (MAIN MENU 11)

NO	SUB MENU	FLEX KEY	TERMINAL MENU	RANGE	DEFAULT	REMARK	
1	Hunt Group Program	1	Type	Cir/Term/UCD /VM/Ring/None	None	Deletion by [SPD] key.	
		2	Group Member	Station No.	None	Max 10 stations Deletion by [SPD] key	
		3	Attribute			None	
			Cir/ Term	1.No Answer Timer	0-99	15	1 second
				2.Ring Timer	0-99	60	1 second
			UCD	1.First Announcement Timer	0-99	15	1 second
				2.Second Announcement Timer	0-99	15	1 second
				3.Announcement Repeat Timer	0-99	15	1 second
			VM	1.Ring Timer	0-99	99	1 second
				2.Put Mail Index	1-4	1	
3.Get Mail Index	1-4			2			
2	VM Dialing Table	1	Put Mail	1-2	Prefix : P# Suffix : -	Flex 1 for Prefix, 2 for Suffix. Max 12 digits. Deletion by [SPD] key	
		2	Get Mail	1-2	Prefix : P## Suffix : -		
		3	Busy	1-2	Prefix : P##3P Suffix : -		
		4	No Answer	1-2	Prefix : P##4P Suffix : -		
		5	Error	1-2	Prefix : P##5P Suffix : -		
		6	DND	1-2	Prefix : P##6P Suffix : -		
		7	Disconnect	-	*****		

Free Manuals Download Website

<http://myh66.com>

<http://usermanuals.us>

<http://www.somanuals.com>

<http://www.4manuals.cc>

<http://www.manual-lib.com>

<http://www.404manual.com>

<http://www.luxmanual.com>

<http://aubethermostatmanual.com>

Golf course search by state

<http://golfingnear.com>

Email search by domain

<http://emailbydomain.com>

Auto manuals search

<http://auto.somanuals.com>

TV manuals search

<http://tv.somanuals.com>