



website : <http://www.LGservice.com>
e-mail : <http://www.LGService.com/techsup.html>

WD-3274RHD
WD-3276RHD

Washing Machine

OWNER'S MANUAL

Please read this manual carefully, it provides instructions on safe installation use, and maintenance. Retain it for future reference.

Record the model and serial numbers of your machine. Quote this information to your dealer if you require service.

Lave-linge

MANUEL D'UTILISATION

Nous vous remercions de l'achat du Lave-Linge Automatique LG. Lire ce manuel attentivement avant d'utiliser l'appareil. Il contient, en effet, des instructions relatives à l'installation, l'utilisation et l'entretien, en toute sécurité, de ce dernier.

Le conserver pour toute consultation ultérieure.

Noter le numéro de modèle et le numéro de série du lave-linge.

Product Feature



■ Automatic Process From Washing To Drying.

Automatic process from washing to drying can be selected easily.



■ More economical by Intelligent Wash System

Intelligent Wash System detects the amount of load and water temperature, and then determines the optimum water level and washing time to minimize energy and water consumption.

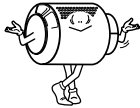

■ Direct Drive System

The advanced Brushless DC motor rotates the drum directly without belt and pulley.

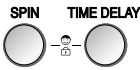

■ Child-Lock

The Child-Lock system has been used to prevent children from pressing any button to change the program during operation.



■ Low noise speed control system

By sensing the amount of load and balance, it evenly distributes load to minimize the spinning noise level.



■ Auto Restart

If the washing machine is turned off by a power failure, it will restart automatically from the position it stopped at adjusting accordingly.

C ontents

Important Safety Information	3
Specification	4
Installation.....	5
Preparation Before Washing.....	10
Adding detergent	11
Cycles	12
How to Use Washer.....	13
Maintenance	21
Troubleshooting Guide	24
Warranty	27

Important Safety Information

READ ALL INSTRUCTIONS BEFORE USE



WARNING!

For your safety, the information in this manual must be followed to minimize the risk of fire or explosion, electric shock, or to prevent property damage, personal injury, or loss of life.

IMPORTANT SAFETY INSTRUCTIONS

WARNING : To reduce the risk of fire, electric shock, or injury to persons when using the washer, follow basic precautions, including the following:

- Read all instructions before using the washer.
- Do not wash articles that have been previously cleaned in, washed in, soaked in, or spotted with gasoline, dry cleaning solvents, or other flammable or explosive substances, as they give off vapors that could ignite or explode.
- Do not add gasoline, dry cleaning solvents, or other flammable or explosive substances to the wash water. These substances give off vapors that could ignite or explode.
- Under certain conditions, hydrogen gas may be produced in a hot water system that has not been used for 2 weeks or more. **HYDROGEN GAS IS EXPLOSIVE.** If the hot water system has not been used for such a period, before using the washing machine, turn on all hot water faucets and let the water flow from each for several minutes. This will release any accumulated hydrogen gas. As the gas is flammable, do not smoke or use an open flame during this time.
- Do not allow children to play on or in the washer. Close supervision of children is necessary when the washer is used near children.
- Before the washer is removed from service or discarded, remove the door to prevent children from hiding inside.
- Do not install or store the washer where it will be exposed to the weather.
- Do not tamper with controls.
- Do not repair or replace any part of the washer or attempt any servicing unless specifically recommended in the user-maintenance instructions or published user-repair instructions that you understand and have the skills to carry out.
- See Installation Instructions for grounding requirements.
- Do not use heat to dry articles containing foam rubber or similarly textured rubber-like materials.
- Interior of washer and condensing duct should be cleaned periodically by qualified service personnel.
- ALWAYS follow the fabric care instructions supplied by the garment manufacturer.
- Do not place items exposed to cooking oil in your dryer. Items contaminated with cooking oils may contribute to a chemical reaction that could cause a load to catch fire.
- Do not use fabric softeners or products to eliminate static unless recommended by the manufacturer of the fabric softener or product.

SAVE THESE INSTRUCTIONS

GROUNDING INSTRUCTIONS

This appliance must be grounded. In the event of malfunction or breakdown, grounding will reduce the risk of electric shock by providing a path of least resistance for electric current. This appliance is equipped with a cord having an equipment-grounding conductor and grounding plug. The plug must be plugged into an appropriate outlet that is properly installed and grounded in accordance with all local codes and ordinance.

- Do not use an adapter or otherwise defeat the grounding plug.
- If you don't have the proper outlet, consult an electrician.

WARNING : Improper connection of the equipment-grounding conductor can result in risk of electric shock. Check with a qualified electrician or serviceman if you are in doubt as to whether the appliance is properly grounded. Do not modify the plug provided with the appliance - if it does not fit the outlet, have a proper outlet installed by a qualified electrician.

S pecification

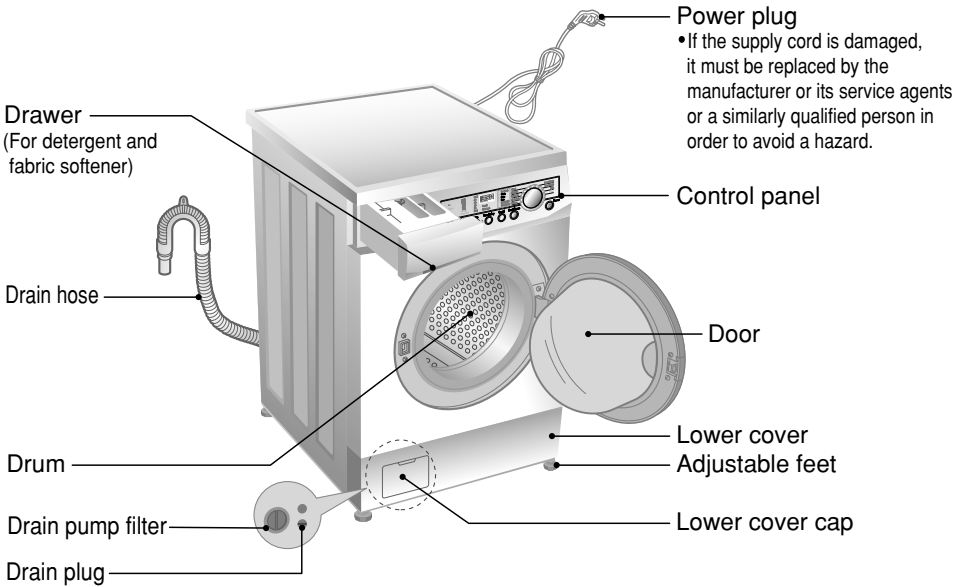

- Name : Front-loading Washing Machine
- Power supply : 120V~, 60Hz
- Size : 23⁵/₈ × 23⁵/₈ × 33¹/₂ (inches)
600 × 600 × 850 (mm)
- Weight : 156¹/₂ lbs. (71 kg)
- Wash capacity : 15²/₅ lbs. (7.0 kg)
- Dry capacity : 8⁴/₅ lbs. (4.0 kg)
- Max. Watt : 1200 W
- Spin speed : No Spin/400/800/1000/1400
- Water consumption : 18 gal. (67 l)
- Permissible water pressure : 4.5 ~ 145 PSI (30 ~ 1000 kPa)

* The appearance and specifications may be varied without notice to raise the unit's quality.

■ Accessories

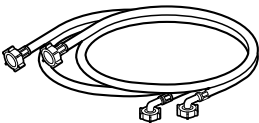

Hot/Cold (1 each)



Wrench

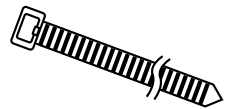

Tie strap

to secure drain hose to standpipe, inlet hose, or laundry tub

I nstallation

Install or store where it will not be exposed to temperatures below freezing or exposed to the weather.

Properly ground washer to conform with all governing codes and ordinances.

The base opening must not be obstructed by carpeting when the washing machine is installed on a carpeted floor.

In countries where there are areas which may be subject to infestation by cockroaches or other vermin, pay particular attention to keeping the appliance and its surroundings in clean condition at all times.

Any damage which may be caused by cockroaches or other vermin will not be covered by the appliance guarantee.

■ Shipping

The appliance is fitted with shipping bolts to prevent internal damage during transport.

■ Removing shipping bolts

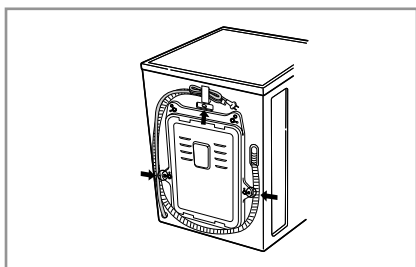

1. To prevent internal damage during transport, the special 3 bolts are locked. Before operating the washer, remove the bolts along with the rubber bungs.

- If they are not removed, it may cause heavy vibration, noise and malfunction.

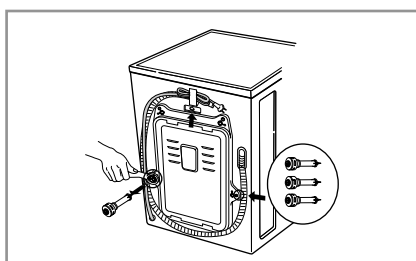

3. Take out the 3 bolts along with the rubber bungs by slightly twisting the bung. Keep the 3 bolts and the spanner for future use.

- Whenever the appliance is transported, the transit bolts must be refitted.

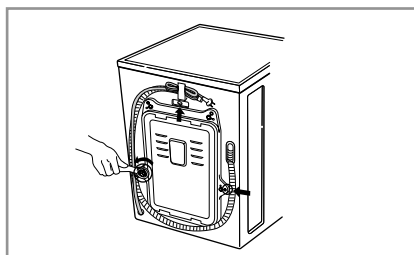

2. Unscrew the 3 bolts with the spanner supplied.

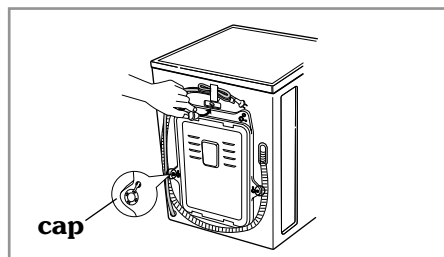

4. Close the holes with the caps supplied.

I nstallation

■ Installation place requirement

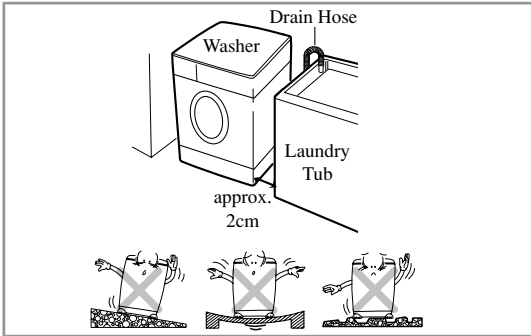

Level floor :

Allowable slope under entire washer is 1°.

Power outlet :

Must be within 60 inches (1.5 m) of either side of the washer. Do not overload the outlet with more than one appliance.

Additional Clearance :

If the washer is installed inside a closet or alcove, the following clearances are required:

4 inches (10 cm) rear, 1 inch (2.5 cm) side

Do not place or store laundry products on top of washer at any times.

They can damage the finish or controls.

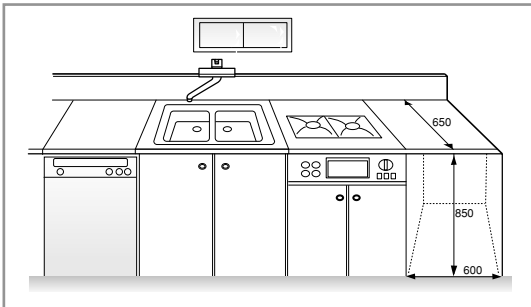

Installation

■ Electrical connection

1. Do not use an extension cord or double adapter.
 2. If the supply cord is damaged, it must be replaced by the manufacturer or its service agents or similarly qualified person in order to avoid a hazard.
 3. Always unplug the machine and turn off the water supply after use.
 4. Connect the machine to an earthed socket in accordance with current wiring regulations.
 5. The appliance must be positioned so that the plug is easily accessible.
- Repairs to the washing machine must only be carried out qualified personnel. Repairs carried out by inexperienced persons may cause injury or serious malfunctioning. Contact your local service center
 - Do not install your washing machine in rooms where temperatures below freezing may occur. Frozen hoses may burst under pressure. The reliability of the electronic control unit may be impaired at temperatures below freezing point.
 - If the appliance is delivered in the winter months and temperatures are below freezing : Store the washing machine at room temperature for a few hours before putting it into operation.

■ Washing Machine is to be connected to the water mains using new hoses Old hoses should not be used.

■ Connecting water supply hose

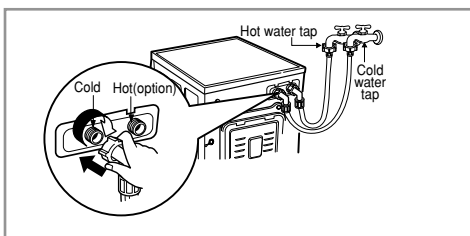
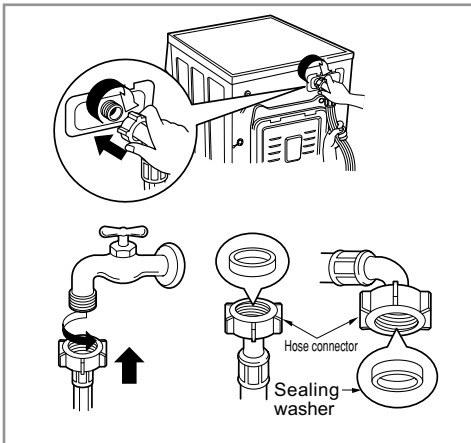

■ *Water supply pressure must be between 4.5 ~ 145 PSI (30~1000 kPa)*

■ *Don't strip or crossthread when connecting Inlet hose to the valve.*

■ *If the water supply pressure is more than 1000 kPa, a pressure reducer device should be installed.*

- Two Sealing washer are supplied with the water inlet hoses to prevent water leaks.
- Check water tightness of washing machine connections by turning the tap completely on.
- Periodically check the condition of the hose and replace the hose if necessary.
- Make sure that there is no kink in the hose and that it is not crushed.
- The Inlet hose which has red connector is for the hot water tap.
- Hot and cold water faucets **Must** be installed of your washer's water inlet.

Installation

This equipment is not designed for maritime use or for use mobile installations such as caravans, aircraft etc.

Turn off the stopcock if the machine is to be left for any length of time (e.g. holiday), especially if there is no floor drain(gully) in the immediate vicinity.

When disposing of the appliance, cut off the mains cable, and destroy the plug Disable the door lock to prevent young children being trapped inside.

Packaging material (e.g. Films, Styrofoam) can be dangerous for children. There is a risk of suffocation !

Keep all packaging well away from children

■ Installation of drain hose

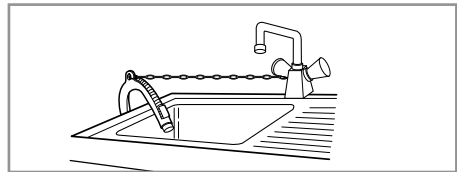
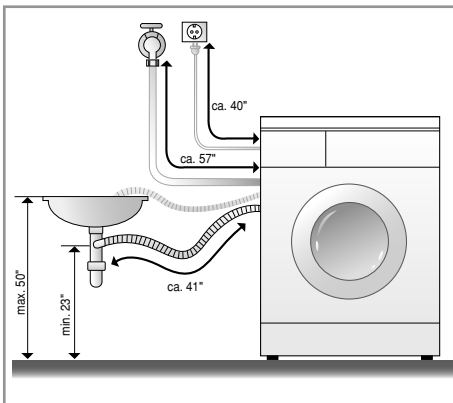

- When installing the drain hose at a sink, secure it so it cannot break away, causing flooding and damage.
- Proper securing the drain hose will protect the floor from damage due to water leakage.

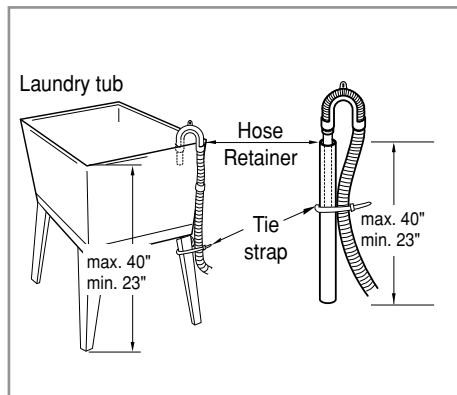
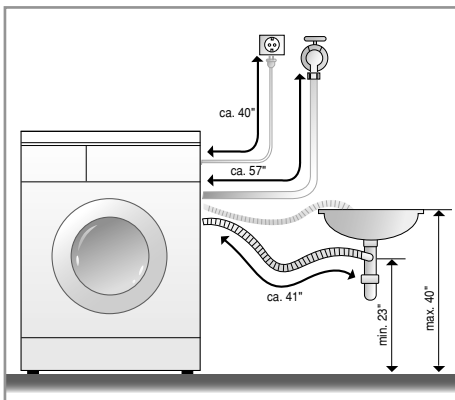

- The drain hose should not be placed higher than 40" above the floor.
- Proper securing the drain hose will protect the floor from damage due to water leakage.

Installation

■ Level adjustment

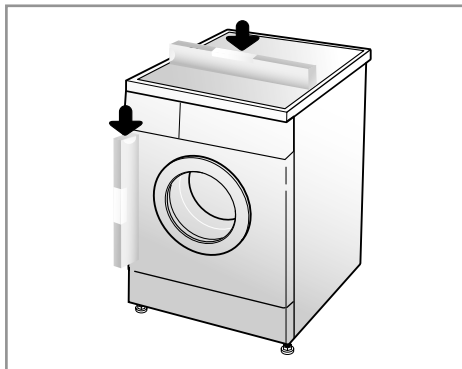

1. Leveling a the washing machine properly prevents excessive noise and vibration. Install the appliance on a solid and level floor surface, preferably in a corner of the room.

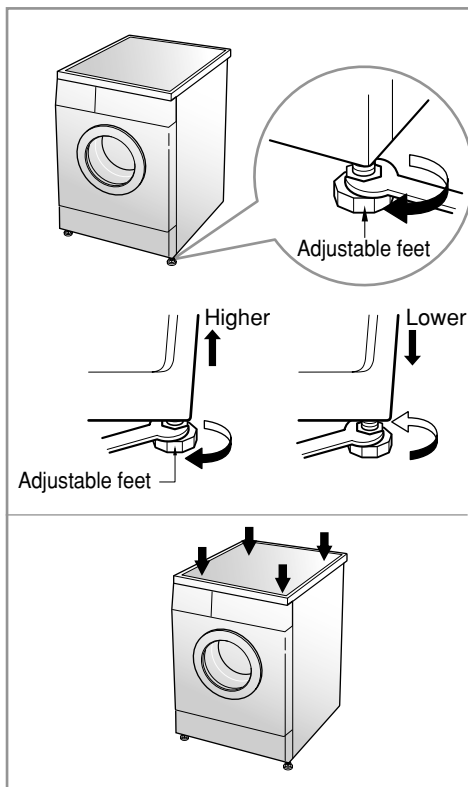

2. If the floor is uneven, adjust the adjustable feet as required. (Do not insert pieces of wood, etc. under the feet)
Make sure that all four feet are stable and resting on the floor and then check that the appliance is perfectly level. (use a spirit level)

* Diagonal Check

When pushing down the edges of the washing machine top plate diagonally, the machine should not move up and down at all. (Please, check both directions)

If machine rocks when pushing the machine top plate diagonally, adjust the feets again.

P reparation Before Washing

WARNING - To reduce the risk of fire, electric shock, or injury to persons, read the **IMPORTANT SAFETY INSTRUCTIONS** before operating this appliance.

1. Care Labels

Look for a care label on your clothes. This will tell you about the fabric content of your garment and how it should be washed.

2. Sorting

To get the best results, Sort clothes into loads that can be washed with the same wash cycle. Water temperature and spin speed and different fabrics need to be washed in different ways. Always sort dark colors from pale colors and whites. Wash separately as dye and lint transfer can occur causing discoloration of white etc. If possible, do not wash heavily soiled items with lightly soiled one.

Soil (Heavy, Normal, Light)
Color (White, Lights, Darks)
Lint (Lint Producers, Collectors)

Separate clothes according to amount of soil.
Separate white fabrics from colored fabrics.
Wash lint producers and lint collectors separately.

3. Check before loading

- **Combine large and small items in a load. Load large items first. Large items should not be more than half the total wash load.**
Do not wash single items. This may cause an out-of-balance load. Add one or two similar items.

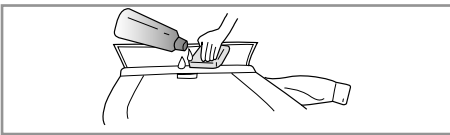
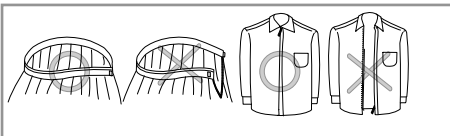
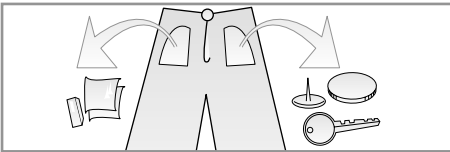

- Check all the pockets to make sure that they are empty. Things such as nails, hair clip, matches, pens, coins, and keys can damage both your washer and your clothes.
- Close zippers, hooks, and strings to make sure that these items don't snag on other clothes.
- Pre-treat dirt and stains by brushing a little detergent dissolved in water onto stains like collars and cuffs to help shift dirt.

Adding detergent

■ Adding detergent and fabric softener

1. The Dispenser Drawer

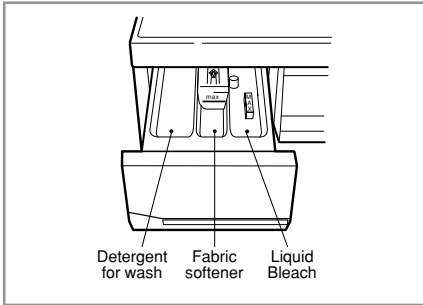

2. Adding Fabric Softener

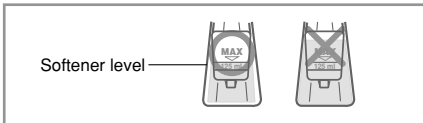

- Do not exceed the maximum fill line. Overfilling can cause early dispensing of the fabric softener which could stain clothes.
- Do not leave the fabric softener in the detergent drawer for more than 2 days. (Fabric softener could harden)
- Softener will automatically be added during last rinse cycle.
- Do not open the drawer when water is supplied.
- Solvents (benzene, etc.) are not allowable.

NOTE Do not pour fabric softener directly on the clothes

3. The liquid bleach drawer.

- Do not open the detergent drawer during water fill cycle.
- Bleach will be dispensed automatically after the detergent has had time to work.
- Do not fill past MAX indicator.

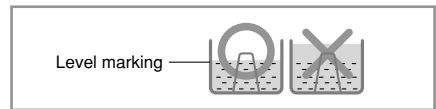

4. Detergent usage

- *The detergent should be used according to the instruction of the detergent manufacture.*
- *If too much detergent is used more than the recommended amount, too many suds can occur and this will decrease the washing result or cause heavy load to the motor, causing a malfunction.*
- *Use powder detergent only for the front loading washer.*
- Detergent usage may need to be adjusted for water temperature, water hardness, size, and soil level of the load. For best results, avoid oversudsing.
- Detergent is dispensed at the beginning of the cycle.

■ Recommended courses according to the laundry type

Program		Fabric Type	Proper Temp. (Wash/Rinse)	Maximum Load	Option	Drying (Option)	Time in Minutes
SANITARY	WASH	First check if laundry is machine washable. (white cotton, linen towel and sheets...)	HOT/COLD	Wash 15 ² / ₅ lbs. (7.0kg)	EXTRA RINSE EXTRA WASH	—	97
	WASH/ DRY			Wash/Dry 8 ⁴ / ₅ lbs. (4.0kg)	EXTRA RINSE EXTRA WASH DRY ONLY	AUTO (TIME)	286
COTTON	WASH	Color fast gaments (Jeans, Tshirts, Shorts, pajamas...) and lightly soiled white cotton	WARM/COLD (WARM/WARM, HOT/COLD, TAP COLD/COLD, COLD/COLD)	Wash 15 ² / ₅ lbs. (7.0kg)	EXTRA RINSE EXTRA WASH	—	82
	WASH/ DRY			Wash/Dry 8 ⁴ / ₅ lbs. (4.0kg)	EXTRA RINSE EXTRA WASH DRY ONLY	AUTO (TIME)	271
PERM. PRESS	WASH	Polyamide, Acrylic, Polyester	WARM/COLD (WARM/WARM, TAP COLD/COLD, COLD/COLD)	Wash 8 ⁴ / ₅ lbs. (4.0kg)	EXTRA RINSE EXTRA WASH	—	77
	WASH/ DRY			—	EXTRA RINSE EXTRA WASH DRY ONLY	AUTO (TIME)	265
RINSE + SPIN	WASH	If you wish to rinse more, the Extra Rinse function will remove any trace of detergents.	COLD/COLD (WARM/COLD, WARM/WARM, TAP COLD/COLD)	Wash 15 ² / ₅ lbs. (7.0kg)	EXTRA RINSE	—	32
	WASH/ DRY			Wash/Dry 8 ⁴ / ₅ lbs. (4.0kg)	EXTRA RINSE DRY ONLY	AUTO (TIME)	221
WOOL / SILK	WASH	Machine washable woolens with pure new wool only	COLD/COLD (WARM/COLD, WARM/WARM, TAP COLD/COLD)	4 ² / ₅ lbs. (2.0kg)	EXTRA RINSE	—	56

* EXTRA WASH : If the laundry is heavily soiled, "EXTRA WASH" course is recommended. EXTRA WASH is available in COTTON, SANITARY and PERM. PRESS Program.

How to use washer

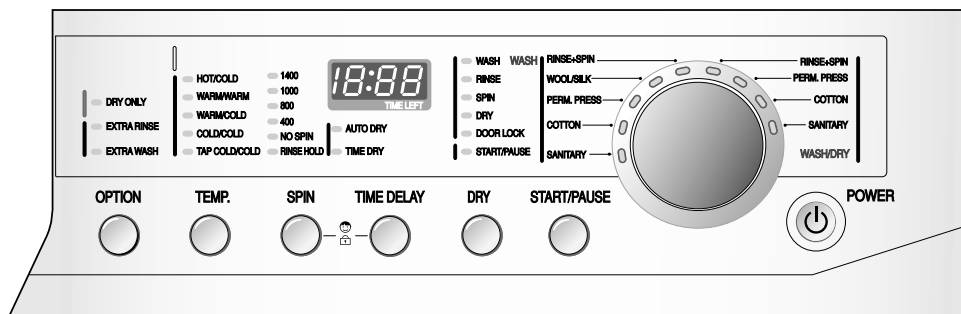

1. Cotton automatically selected upon Power on

- To start, press the **POWER** button.
- Press the **START/PAUSE** button.
- Initial condition
 - Wash *Main Wash Only*
 - Rinse *3 times*
 - Spin *800 rpm*
 - Temp. *Warm/Cold(Wash/Rinse)*
 - Program *Cotton*

2. Manual Selecting

- To start, press the **POWER** button.
 - Select the conditions which you want to use, by pressing each button.
- For selecting the correct cycle, please refer to pages 14 ~ 20.*
- Press the **START/PAUSE** button.

3. Beep On/Off

- The Beep On/Off function can be set by pressing and holding the **OPTION** and **DRY** button simultaneously.
- The Beep On/Off function can be set at any time and it is automatically canceled when power failure occur. Also the Beep On/Off function works when power is off.

How to use washer

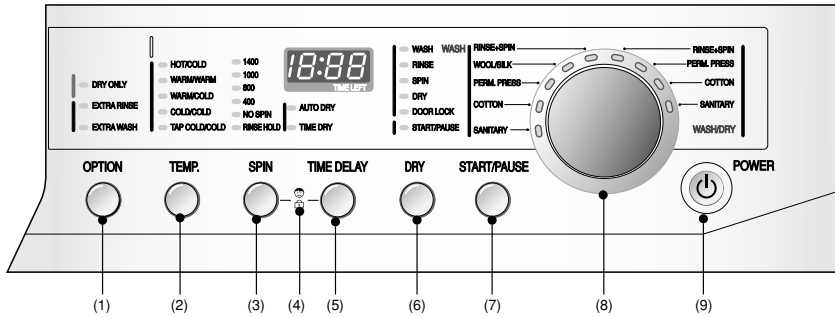

- | | | |
|--------------------------|-------------------------|--------------------------|
| (1) BUTTON : OPTION | (4) CHILD LOCK | (7) BUTTON : START/PAUSE |
| (2) BUTTON : WATER TEMP. | (5) BUTTON : TIME DELAY | (8) DIAL : PROGRAM |
| (3) BUTTON : SPIN | (6) BUTTON : DRY | (9) BUTTON : POWER |

OPTION

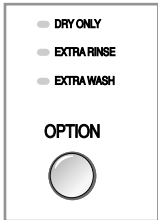

- By pressing the OPTION button, the wash type can be selected.
- **EXTRA RINSE**
- **EXTRA WASH**
- **EXTRA RINSE +EXTRA WASH**
- **DRY ONLY[WASH/DRY]**

1. EXTRA WASH

- If the laundry is heavily soiled, “EXTRA WASH” course is effective.
- EXTRA WASH is available in SANITARY, COTTON and PERM. PRESS.

The required lamp will light up for identification.

2. EXTRA RINSE

- This option can be used to add a rinse for people with sensitive skin. Selecting the **EXTRA RINSE** button is also recommended when washing heavily soiled fabrics which needs a lot of detergent, or when the wash load contains towelling fabrics that have a greater tendency to retain detergent.

If lamp turns on, that function has been selected.

3. DRY ONLY

- **DRY ONLY** option can be used when you want to only dry without any other programs such as wash, spin, etc.
- Select any of the programs **SANITARY COTTON, PERM. PRESS, RINSE+SPIN** in **WASH/DRY** and then **DRY ONLY** by pressing the option button.

How to use washer

WASH/RINSE TEMPERATURE.

- Press **TEMP.** to cycle through the temperature choices.
- Select a water temperature based on the type of load you are washing. Use the warmest water safe for fabrics. Follow garment label instructions.
- Warm rinses leave the loads dryer than cold rinses. Warm rinses increase wrinkling. In cold climates, a warm rinse makes the load more comfortable to handle. Cold rinses save energy.
- Warm rinses are regulated at approximately 75° F (24° C). This is a cooler warm rinse than you are used to, but it saves energy and gives proper rinsing. The load is a comfortable temperature remove from the washer.

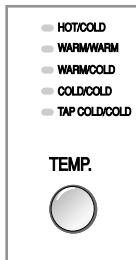

1. Wash/Rinse Temperature

- Water temperature can be selected as below according to the program.
- **SANITARY**
HOT/COLD
- **COTTON**
WARM/COLD → WARM/WARM → HOT/COLD → TAP COLD/COLD → COLD/COLD
- **PERM. PRESS**
WARM/COLD → WARM/WAR → TAP COLD/COLD → COLD/COLD
- **WOOL/SILK & RINSE+SPIN**
COLD/COLD → WARM/COLD → WARM/WARM → TAP COLD/COLD

Selected temperature's lamp turns on.

For the more detailed information, please refer to the page 12.

Temperature Guide

Wash Water Temperature	Suggested Fabrics
Hot 111° F (44° C) or above	Whites and pastels Heavy and greasy soils
Warm 90°-110° F (32° - 43° C)	Bright colors Moderate to light soils
Cold 70°-90° F (21°-32° C)	Colors that bleed or fade Light soils

In wash water temperatures colder than 70° F (21° C), detergents do not dissolve well. Soils may be difficult to remove.

SPIN

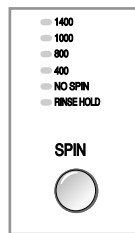

- By pressing the **SPIN** button, the spin rpm can be chosen.
- **RINSE HOLD**
- **NO SPIN**
- **400**
- **800**
- **1000**
- **1400**

1. Spin selection

- Spin rpm is available according to the program as follows.

[Wash Programs]

- **SANITARY & COTTON & RINSE+SPIN**
800 → 1000 → 1400 → Rinse Hold → No Spin → 400
- **PERM. PRESS**
800 → 1000 → Rinse Hold → No Spin → 400
- **WOOL/SILK**
400 → 800 → 1000 → Rinse Hold → No Spin

[Wash/Dry Programs]

- **SANITARY & COTTON & RINSE+SPIN**
1400 → 800 → 1000
- **PERM. PRESS**
1000 → 800

2. No spin

- If **NO SPIN** is selected, the washer stops after draining water.

The required lamp will light up for identification.

3. Rinse Hold

- If selected by pressing the **SPIN** button repeatedly this function leaves clothes in the washer; suspended in the water after a rinse without entering into spin.
- To proceed through to a drain or spin, once the rinse hold function is completed using to program dial scroll to the required program. (Spin or Pump)

The required lamp will light up for identification.

How to use washer

CHILD LOCK

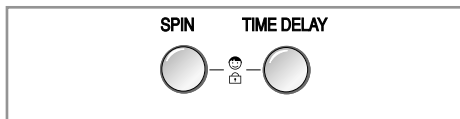

If you choose to lock the buttons on the control assembly to prevent tampering, this function may be selected.

1. Child Lock

- Child Lock can be set by pressing and holding the **SPIN** button and **TIME DELAY** button simultaneously.

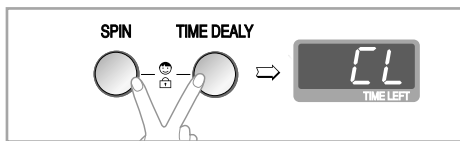

- When child lock is set, all buttons are inoperable.
- To deactivate Child Lock system, press and hold the **SPIN** and **TIME DELAY** button simultaneously again.

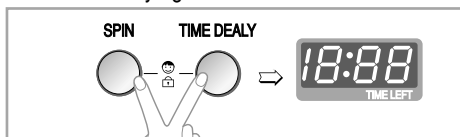

- To change to the desired program, whilst in child lock mode.

1. Press and hold both **SPIN** and **TIME DELAY** together once again.
2. Press the **START/PAUSE** button.
3. Select the desired program and press the **START/PAUSE** button again.

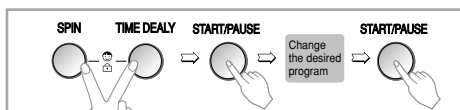

- The child lock can be set at any time and it is automatically canceled when operational errors occur. Also *Child Lock* works when power is off.

TIME DELAY



1. Time Delay

Preparing washing before starting "Time Delay"

- Turn on the water tap.
- Load laundry and close the door.
- Place the detergent and fabric softener in the drawer.

- How to set "TIME DELAY"

- Press **POWER** button.
- Turn the **PROGRAM** dial to select the program you require.
- Press **TIME DELAY** button and set the desired time.
- Press the **START/PAUSE** button. ("." blinks.)

- If **TIME DELAY** button is pressed, "3:00" is displayed. The maximum delayed time is 19:00 hours and the minimum time is 3:00 hours.

- Each pressing of the button advances on time delay by one hour.

- To cancel the time delay, press the **POWER** button.

- **TIME DELAY** is 'expected time' from the present to the completion of washing cycle or selected process (Wash, Rinse or Spin).

- According to the condition of water supply and temperature, the delayed time and the actual washing time may vary.

How to use washer

DRY



- This washer-dryer's automatic process from washing to drying can be selected easily.
- For most even drying, make sure all articles in the clothes load are similar in material and thickness.
- Do not overload dryer by stuffing too many articles into drum. Items must be able to tumble freely.
- If you open door and remove load before dryer has finished its cycle, remember to press the START/PAUSE button.

1. Drying Automatic guide

- Use your Automatic Cycles to dry most loads. Electronic sensors measure the temperature of the exhaust to increase or decrease drying temperatures for faster reaction time and tighter temperature control.
- If a load is not as dry as you like, complete drying using a time cycle.

2. Drying Time Guide (Manual Operation)

- By pressing the DRY button, the drying time can be selected.
- These drying times are given as a guide to help you set your dryer for manual drying. Drying times can vary greatly depending on dampness, room temperature and type of fabric and your own experience will be your best guide.
- AUTO (NORMAL) Cotton 8⁴/₅ lbs. (4.0 kg)
- TIME DRY From 15 min. to 150 min. selectable
15 min. is added by pressing DRY button.
30 min. Cotton 2¹/₅ lbs. (1.0 kg)
60 min. Cotton 4³/₇ lbs. (2.0 kg)
150 min. Cotton 6⁵/₈ lbs. (3.0 kg)

NOTE The Estimated drying time varies from the actual drying time with an Automatic. The type of fabric, size of the load, and the dryness selected affect drying time.

3. Drying guide

- Your dryer can handle a load of up to 8⁴/₅ lbs. (4 kg) dry weight of articles.
- When loading, shake out each handful of clothes so that they can tumble freely. Items should not be loaded in a tangled condition, as this will lengthen the drying time.

Woolen Articles

- Do not tumble dry woolen articles. Pull them to their original shape, and dry them flat.

Woven and Loopknit Materials

- Some woven and loopknit materials may shrink, by varying amounts, depending on their quality.
- Always stretch them out immediately after drying.

Permanent Press and Synthetics

- Do not overload your dryer
- Take out permanent press articles as soon as the dryer stops to reduce wrinkles.

Fiber or Leather Materials

- Always check the manufacture's instructions.

Baby Clothes and Night Gowns

- Always check the manufacture's instructions.

Rubber and Plastics

- Do not dry any items made from or containing rubber or plastics, such as:

- a) aprons, bibs, chair covers
- b) curtains and tablecloths
- c) bathmats

Fiberglass

- Do not dry fiberglass articles in your dryer. Glass particles left in the dryer could be picked up by your clothes the next time you use the dryer and irritate your skin.

How to use washer

PROGRAM

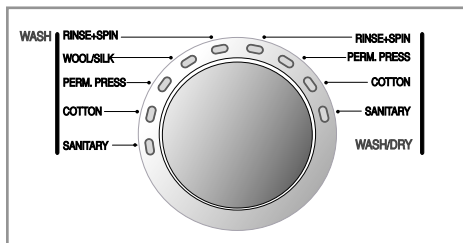

- 9 programs are available according to the laundry type.
- Lamp will light up to indicate selected program.

1. Program

- When **START/PAUSE** button is pressed, the Cotton program is automatically selected.
- By turning the Program dial, the program is selected in order of “COTTON→ PERM. PRESS→WOOL/SILK→ RINSE+SPIN→*RINSE+SPIN→ *PERM. PRESS→*COTTON→ *SANITARY→SANITARY”.
[*:WASH/DRY]

Regarding to the laundry type for each program Please refer to the page12.

2. Course

[WASH]	[WASH/DRY]
-RINSE+SPIN	-RINSE+SPIN
-WOOL/SILK	-PERM. PRESS
-PERM. PRESS	-COTTON
-COTTON	-SANITARY
-SANITARY	

START/PAUSE

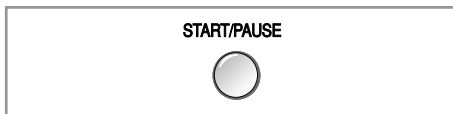

1. Start

- This **START/PAUSE** button is used to start wash cycle or pause the wash cycle.

2. Pause

- If temporary stop of wash cycle is needed, press the **START/PAUSE** button.
- When in Pause, the power is turned off automatically after 4 minutes.
- **NB.** The door will not open before 1 to 2 minutes when Pause is selected, or at the end of the wash cycle.

POWER



1. Power

- Press the Power button to turn power on and off
- To cancel the **TIME DELAY** function, the Power button should be pressed.

2. Initial Program

- When the Power button is pressed, the washer is ready for Cotton program.
- If you want to advance into the washing cycle without changing the program, just press **START/PAUSE** button and then the washer will proceed.

Initial program

- Cotton Program, Main wash, Normal Rinse, 800rpm, Warm/Cold

How to use washer

DISPLAY



1. Special function display

- When child lock is selected, the “**CL**” is displayed.
- When time delay is selected, it shows the remaining times to finish the selected program.

2. Self diagnose display

- If the washer encounters a fault during operation, the associated fault will be displayed.

“**PE**” : Water pressure sensing error

“**FE**” : Problem of overfilling water

“**dE**” : Door is not closed

“**LE**” : Over load in motor.

“**LE**” : Over load in motor.

“**IE**” : Water inlet trouble

“**DE**” : Drainage trouble

“**UE**” : Unbalanced load

“**TE**” : Water temperature trouble

“**dHE**” : Dry heater or thermostat trouble

If these error letters are displayed, please refer to the troubleshooting page 26 and follow the guide.

3. Completion of washing

- When washing cycle is completed, “**End**” is displayed on the “*Multi display*”.

4. Time left

- During washing cycle, the remaining washing time is displayed.
- Recommended program by manufacturer.

[WASH]

- SANITARY : Approx. 1 hour and 37 minutes

- COTTON : Approx. 1 hour and 22 minutes

- PERM. PRESS : Approx. 1 hour and 17 minutes

- WOOL/SILK : Approx. 56 minutes

- RINSE+SPIN : Approx. 32 minutes

[WASH/DRY]

- SANITARY : Approx. 4 hours and 46 minutes

- COTTON : Approx. 4 hours and 31 minutes



- PERM. PRESS : Approx. 4 hours and 25 minutes

- RINSE+SPIN : Approx. 3 hours and 41 minutes

- The washing time may vary by the amount of laundry, water pressure, water temperature and other washing conditions.
- If an unbalanced load is detected or if the suds removing program operates, the wash time may be extended. (Max. increasing time is 45minutes.)

How to use washer

5. Completion of Drying

- When drying cycle is completed, “ [COOL DOWN] is displayed on the *Multi display*.
- The COOL DOWN is setting automatically when a drying cycle is complete.
- When you are not remove a load of clothes from the dryer as soon as it stops, wrinkles can form.
- The COOL DOWN operating periodically tumbles, rearranges and fluffs the load to avoid wrinkles without heat for up to 4 hours.
- The “ ” message will continue to display until the clothes are removed or the START/PAUSE button is pressed.

6. Drying Time

It is impossible to give exact drying times. Conditions from home to home vary and directly affect drying times. The length of time it takes to dry loads will depend on several variables.

- These cycles have a longer cool down period to reduce wrinkling.
- The automatic cycle will determine the time needed and often provides the best results.
- Modifiers allow you to further customize your cycles and save energy.

Maintenance

- * Before cleaning the washer interior, unplug the electrical power cord to avoid electrical shock to avoid electrical shock hazards.
- * When disposing of the appliance, cut off the mains cable, and destroy the plug Disable the door lock to prevent young children being trapped inside.

■ The water inlet filter

- " iE " error message will blink on the control panel when water does not enter the detergent drawer.
 - If your water is very hard or contains traces of lime deposit, the water inlet filter may become clogged.
- It is therefore a good idea to clean it from time to time.

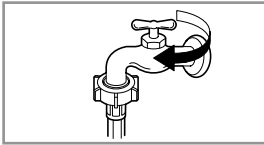

1. Turn off the water tap.

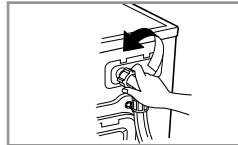

2. Unscrew the water inlet hose.

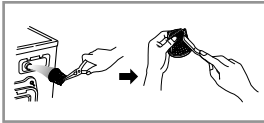

3. Clean the filter using a hard bristle brush.



4. Tighten up the inlet hose.

■ The drain pump filter

- * The drain filter collects threads and small objects left in the laundry.
- Check regularly that the filter is clean to ensure smooth running of your machine.

⚠ CAUTION First drain using the drain hose and then open the pump filter to remove whatever any threads or objects.

Be careful when draining if the water is hot.

- * Allow the water to cool down before cleaning the drain pump, carrying out emergency emptying or opening the door in an emergency.

1. Open the lower cover cap (①) by using a coin. Turn the drain plug (②) to pull out the hose.
2. Unplug the drain plug (②), allowing the water to flow out. At this time use a vessel to prevent water flowing on to the floor. When water does not flow any more, turn the pump filter (③) open to the left.
3. Remove out any foreign material from the pump filter (③). After cleaning, turn the pump filter (③) clockwise and insert the drain plug (②) to the original place. close the lower cover cap.

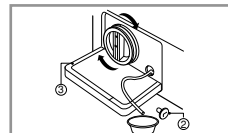
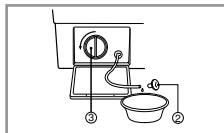
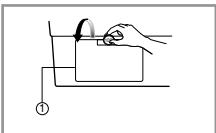

Maintenance

■ Dispenser drawer

- * After a while detergents and fabric softeners leave a deposit in the drawer.
- It should be cleaned from time to time with a jet of running water.
- If necessary it can be removed completely from the machine by pressing the catch downward and by pulling it out.
- To facilitate cleaning, the upper part of the fabric softener compartment can be removed.

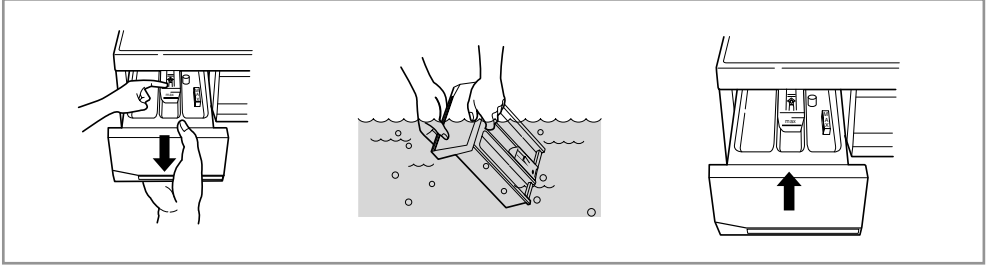

■ The drawer recess

- * Detergent can also accumulate inside the recess which should be cleaned occasionally with an old toothbrush.
- Once you have finished cleaning, replace the drawer and run a rinse cycle without laundry.

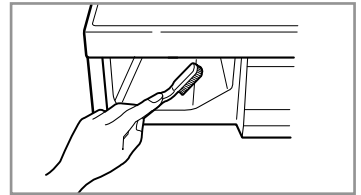

■ The washing drum

- If you live in a hard water area, limescale may continuously build up in places where it cannot be seen and thus not easily removed.
Over time the build up of scale clogs appliances, and if it is not kept in check these may have to be replaced.
- Although the washing drum is made of Stainless steel, specks of rust can be caused by small metal articles (paper clips, safety pins) which have been left in the drum.
- The washing drum should be cleaned from time to time.
- If you use descaling agents, dyes or bleaches, make sure they are suitable for washing machine use.
- * Descaler may contain chemicals that may damage part of your washing machine.
- * Remove any spots with a stainless steel cleaning agent.
- * Never use steel wool.

Maintenance

■ Cleaning your washer

1. Exterior

Proper care of your washer can extend its life.

The outside of the machine can be cleaned with warm water and a neutral non abrasive household detergent.

Immediately wipe off any spills. Wipe with damp cloth.

Try not to hit surface with sharp objects.

* IMPORTANT: Do not use methylated spirits, diluents or similar products.

2. Interior

Dry around the washer door opening, flexible gasket and door glass.

Run washer through a complete cycle using hot water.

Repeat process if necessary.

NOTE Remove hard water deposits using only cleaners labeled as washer safe.

■ Cold condition

If the washer is stored in an area where freezing may occur or moved in freezing temperatures, follow these instructions to prevent damage to the washer:

1. Turn off water supply tap.
2. Disconnect hoses from water supply and drain water from hoses.
3. Plug electrical cord into a properly grounded electrical outlet.
4. Add 1gallon(3.8L) of nontoxic recreational vehicle(RV) antifreeze into an empty wash drum.
Close the door.
5. Set spin cycle and let washer spin for 1 minute to drain out all water.
Not all of the RV antifreeze will be expelled.
6. Unplug electrical power cord, dry the drum interior, and close the door.
7. Remove dispenser drawer, drain and dry excessive water from the compartments.
8. Store washer in an upright position.
9. To remove antifreeze from washer after storage, run empty washer through a complete cycle using detergent. Do not add wash load.

Troubleshooting guide











* This washing machine is equipped with automatic safety functions which detect and diagnose faults at an early stage and react appropriately.
 When the machine does not function properly or does not function at all, check the following points before you contact your service provider.

Symptom	Possible Cause	Solution
Rattling and clanking noise	<ul style="list-style-type: none"> Foreign objects such as coins or safety pins maybe in drum or pump. 	<p>Stop washer and check drum and drain filter. If noise continues after washer is restarted, call your authorized service centre.</p>
Thumping sound	<ul style="list-style-type: none"> Heavy wash loads may produce a thumping sound. This is usually normal. 	<p>If sound continues, washer is probably out of balance. Stop and redistribute wash load.</p>
Vibrating noise	<ul style="list-style-type: none"> Have all the transit bolts and packing been removed? Are all the feet resting firmly on the ground? 	<p>If not removed during installation, refer to Installation guide for removing transit bolts. Wash load may be unevenly distributed in drum. Stop washer and rearrange wash load.</p>
Water leaks.	<ul style="list-style-type: none"> Fill hoses or drain hose are loose at tap or washer. House drain pipes are clogged. 	<p>Check and tighten hose connections. Unclog drain pipe. Contact plumber if necessary.</p>
Oversudsing		<p>Too much detergent or unsuitable detergent may cause excessive foaming which may result in water leaks.</p>
Water does not enter washer or it enters slowly	<ul style="list-style-type: none"> Water supply is not adequate in area. Water supply tap is not completely open. Water inlet hose(s) are kinked. The filter of the inlet hose(s) are clogged. 	<p>Check another tap in the house. Fully open tap. Straighten hose(s). Check the filter of the inlet hose(s).</p>
Water in the washer does not drain or drains slowly.	<ul style="list-style-type: none"> Drain hose is kinked or clogged. The drain filter is clogged. 	<p>Clean and straighten the drain hose. Clean the drain filter.</p>

Troubleshooting guide

Symptom	Possible Cause	Solution
Washer does not start	<ul style="list-style-type: none"> • Electrical power cord may not be plugged in or connection may be loose. • House fuse blown, circuit breaker tripped, or a power outage has occurred. • Water supply tap is not turned on. 	<p>Make sure plug fits tightly in wall outlet.</p> <p>Reset circuit breaker or replace fuse. Do not increase fuse capacity. If problem is a circuit overload, have it corrected by a qualified electrician.</p> <p>Turn on water supply tap.</p>
Washer won't spin	<ul style="list-style-type: none"> * Check that the door is firmly shut. 	<p>Close the door and press the Start/Pause button. After pressing the Start/Pause button, it may take a few moments before the clothes washer begins to spin. The door must lock before spin can be achieved.</p>
Door does not open		<p>Once started, the door can not be opened for safety reasons. Wait one or two minutes before opening the door to give the electric locking mechanism time to release.</p>
Wash cycle time delayed		<p>The washing time may vary by the amount of laundry, water pressure, water temperature and other using conditions. If the imbalance is detected or if the suds removing program works, the wash time shall be increased.</p>
Dry problem	<ul style="list-style-type: none"> • Does not dry 	<p>Do not overload. Check that the washer is draining properly to extract adequate water from the load. Clothes load is too small to tumble properly. Add a few towels.</p>

Troubleshooting guide

Symptom	Possible Cause	Solution
	<ul style="list-style-type: none"> Water supply is not adequate in area Water supply taps are not completely open. Water inlet hose(s) are kinked. The filter of the inlet hose(s) are clogged. 	<p>Check another tap in the house. Fully open tap.</p> <p>Straighten hose(s). Check the filter of the inlet hose(s).</p>
	<ul style="list-style-type: none"> Drain hose is kinked or clogged. The drain filter is clogged. 	<p>Clean and straighten the drain hose. Clean the drain filter.</p>
	<ul style="list-style-type: none"> Load is too small. Load is out of balance. The appliance has an unbalance detection and correction system. If individual heavy articles are loaded (ex. bath mat, both robe, etc.), this system may stop spinning or even interrupt the spin cycle altogether. If the laundry is still too wet at the end of the cycle, add smaller articles of laundry to balance the load and repeat the spin cycle. 	<p>Add 1 or 2 similar items to help balance the load. Rearrange load to allow proper spinning</p>
	 <ul style="list-style-type: none"> Is the door opened? 	<p>Close the door. * If “dE” is not released, call for service.</p>
		<p>Unplug the power plug and call for service.</p>
	<ul style="list-style-type: none"> Water overfills due to the faulty water valve. 	<p>Close the water tap. Unplug the power plug. Call for service.</p>
	<ul style="list-style-type: none"> Water level sensor has malfunctioned. 	
	<ul style="list-style-type: none"> Over load in motor. 	
	<ul style="list-style-type: none"> Over load in motor. 	
	<ul style="list-style-type: none"> Check water supply. 	<p>Turn the tap on. * If “dHE” is not released, unplug power plug and call for service.</p>

Visit our web site at <http://www.lgservice.com>

LG Electronics

LIMITED WARRANTY United States of America

LG Electronics will repair or at its option replace, without charge, your product which proves to be defective in material or workmanship under normal use during the warranty period listed below from the date of original purchase.

This warranty is good only to the original purchaser of the product during the warranty period as long as it is in the U.S. including Alaska, Hawaii, and U.S. Territories, and all Canadian Provinces.

LG Washing Machine Warranty Period

<u>Product</u>	<u>Parts</u>	<u>Labor</u>
All Parts	1 Years	1 Years (In-Home Service)
Drum Tub, Motor	7 Years	1 Years (In-Home Service)

No other express warranty is applicable to this product. THE DURATION OF ANY IMPLIED WARRANTIES, INCLUDING THE IMPLIED WARRANTY OF MERCHANTABILITY, IS LIMITED TO THE DURATION OF THE EXPRESS WARRANTY HEREIN. LG ELECTRONICS SHALL NOT BE LIABLE FOR THE LOSS OF USE OF THE PRODUCT, INCONVENIENCE, LOSS OR ANY OTHER DAMAGES, DIRECT OR CONSEQUENTIAL, ARISING OUT OF THE USE OF OR INABILITY TO USE, THIS PRODUCT OR FOR ANY BREACH OF ANY EXPRESS OR IMPLIED WARRANTY, INCLUDING THE IMPLIED WARRANTY OF MERCHANTABILITY APPLICABLE TO THIS PRODUCT.

Some States / Provinces do not allow the exclusion or limitation of incidental or consequential damages or limitations on how long an implied warranty lasts; so these limitations or exclusions may not apply to you. This warranty gives you specific legal rights and you may also have other rights which vary from state to state or province to province.

THE ABOVE WARRANTY DOES NOT APPLY TO:

1. Service trips to your home to deliver and pickup, install, instruct, or replace house fuses or correct house wiring or plumbing, or correction of unauthorized repairs.
2. Damage to the product caused by accident, vermin, fire, floods, or acts of God.
3. Repairs when your LG product is used in other than normal, single-family household use.
4. Damage resulting from accident, alteration, misuse, abuse, or improper installation.

Therefore, these costs are paid by the consumer.

If the product is installed outside the normal service area, any cost of transportation involved in the repair of the product, or the replacement of defective parts, shall be borne by the owner.

CUSTOMER ASSISTANCE NUMBERS:

To obtain Warranty Coverage:

Retain your Bill of Sales to prove date of purchase.

A Copy of your Sales Receipt must be submitted at the time warranty service is provided.

To obtain Product or Customer Service Assistance:

Call 1-800-243-0000 (Mon. ~ Fri. 7 AM ~ 8 PM CT)(Sat. 8AM ~ 5PM CT)
Press the appropriate menu option, and have your product type (Washer,) model number, serial number, and ZIP/Postal Code ready.

To obtain the nearest Authorized Service Center:

Call 1-800-243-0000 (24 hrs a day, 7 days per week)
Press the appropriate option, and have your product type (Washer,) model number, serial number, and ZIP/Postal Code ready.



LG Electronics Inc.

Free Manuals Download Website

<http://myh66.com>

<http://usermanuals.us>

<http://www.somanuals.com>

<http://www.4manuals.cc>

<http://www.manual-lib.com>

<http://www.404manual.com>

<http://www.luxmanual.com>

<http://aubethermostatmanual.com>

Golf course search by state

<http://golfingnear.com>

Email search by domain

<http://emailbydomain.com>

Auto manuals search

<http://auto.somanuals.com>

TV manuals search

<http://tv.somanuals.com>