

INSTALLATION MANUAL

# VIP 1003

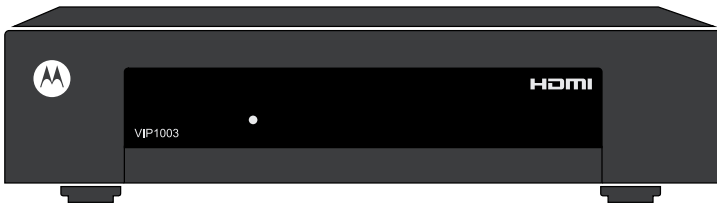



### Caring for the Environment by Recycling

When you see this symbol on a Motorola product, do not dispose of the product with residential or commercial waste.

### Recycling your Motorola Equipment

Please do not dispose of this product with your residential or commercial waste. Some countries or regions, such as the European Union, have set up systems to collect and recycle electrical and electronic waste items. Contact your local authorities for information about practices established for your region. If collection systems are not available, call Motorola Customer Service for assistance.



Please recycle this document.



### Declaration of Conformity

We Motorola, Inc.  
Teknikringen 20  
SE 583 30 Linköping, Sweden

declare under our sole responsibility that the product to which this declaration relates are in conformity with the following directives:

EMC Directive 2004/108/EC  
Low Voltage Directive 2006/95/EC  
WEEE Directive 2002/96/EC  
RoHS Directive 2002/95/EC

according to the following standards:

EN55022, EN55024, EN60950.

© 2009 Motorola, Inc. All rights reserved. No part of this publication may be reproduced in any form or by any means or used to make any derivative work (such as translation, transformation, or adaptation) without written permission from Motorola, Inc.

MOTOROLA and the Stylized M logo are registered in the US Patent and Trademark Office. All other product or service names are the property of their respective owners.

Motorola reserves the right to revise this publication and to make changes in content from time to time without obligation on the part of Motorola to provide notification of such revision or change. Motorola provides this guide without warranty of any kind, implied or expressed, including, but not limited to, the implied warranties of merchantability and fitness for a particular purpose. Motorola may make improvements or changes in the product(s) described in this manual at any time.

## WARNING

TO REDUCE THE RISK OF FIRE OR ELECTRICAL SHOCK, DO NOT EXPOSE THIS APPLIANCE TO RAIN OR MOISTURE.

### IMPORTANT SAFETY INSTRUCTIONS

- Read these instructions.
- Keep these instructions.
- Heed all warnings.
- Follow all instructions.
- Do not use this apparatus near water.
- Clean only with dry cloth.
- Install in accordance with the manufacturer's instructions.
- Do not install near any heat sources such as radiators, heat registers, stoves, or other apparatus (including amplifiers) that produce heat.
- Battery pack or batteries installed shall not be exposed to excessive heat such as sunshine, fire or the like.
- Do not defeat the safety purpose of the polarized or grounding-type plug. If the provided plug does not fit into your outlet, consult an electrician for replacement of the obsolete outlet.
- Protect the power cord from being walked on or pinched, particularly at plugs, convenience receptacles, and the point where they exit from the apparatus.
- Use only attachments and accessories specified by the manufacturer.
- Unplug this apparatus during lightning storms or when unused for long periods of time.
- Refer all servicing to qualified service personnel. Servicing is required when the apparatus has been damaged in any way, such as when the power-supply cord or plug is damaged, liquid has been spilled or objects have fallen into the apparatus, the apparatus has been exposed to rain or moisture, does not operate normally, or has been dropped.

#### POWER SUPPLY

- Keep distances around the power supply for sufficient ventilation.
- No naked flame sources, such as lighted candles, should be placed near the apparatus.
- Do not expose the power supply to dripping or splashing and do not place objects filled with liquids, such as vases, on the power supply.
- Ensure that the mains plug remains readily operable.

## CAUTION

TO PREVENT ELECTRICAL SHOCK, DO NOT USE THIS PLUG WITH AN EXTENSION CORD, RECEPTACLE, OR OTHER OUTLET UNLESS THE BLADES CAN BE FULLY INSERTED TO PREVENT BLADE EXPOSURE.



The lightning flash with arrowhead within an equilateral triangle is intended to alert the user to the presence of uninsulated dangerous voltage within the product's enclosure that may be of sufficient magnitude to constitute a risk of electric shock.



The exclamation point within an equilateral triangle is intended to alert the user to the presence of important operating and maintenance (servicing) instructions in the literature accompanying the product.

## Repairs

If you find the unit in need of repair, contact your system operator for repair or replacement.

# YOUR VIP 1003 PACKAGE

## Enclosed material

The following material should be present in your package.



IP set-top box



Remote control with 2 AAA batteries



Ethernet cable



SCART cable



AC adaptor



Installation guide

## PREPARING THE REMOTE CONTROL FOR USE

In order to prepare your remote control for use, insert the batteries.

Carefully place the terminals (+ and -) of the batteries as indicated on the back of the battery compartment.



# PLACEMENT

## Do not cover

Do not place anything on top of the set-top box, instead leave a free space of 20 cm above it for proper ventilation and cooling.

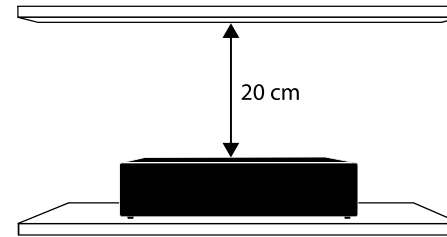

When using the remote control, point it to the IR-receiver in the center of the front panel. Make sure that there is no obstacle between the remote control and the set-top box, such as for example a table.

For best reception of the IR-signals from the remote control to the set-top box, make sure to place the set-top box close to the edge of the shelf.

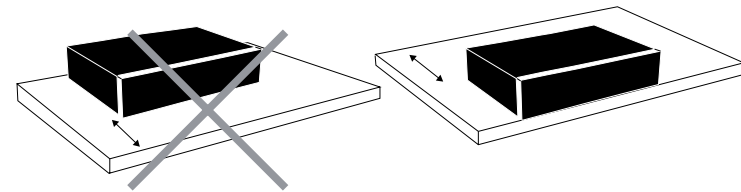

# VIP1003 OVERVIEW

Front panel of models without display

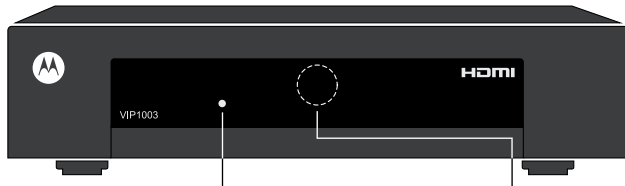

**Indicator LED:s**

- Green light - the set-top box is operational.
- Flashing green light - the set-top box receives a signal from the remote control or a keyboard.
- Red light - the set-top box is in stand-by mode.

**IR receiver**

Receives signals from remote control and keyboard.

The marking plate is located on exterior of the bottom of the apparatus.

Rear panel

**ETHERNET**  
for broadband connection

**USB**  
for connection to external devices.

**SCART (TV)**  
for connection to TV set (analog Standard Definition video)

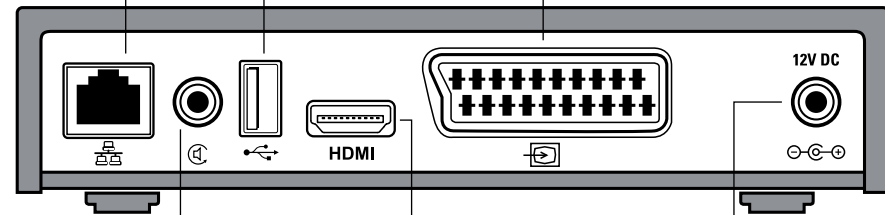

**SPDIF**  
for connection to digital audio equipment

**HDMI**  
for connection to TV set (digital High Definition video)

**POWER**  
for connection of external power supply

# INSTALLING

**1** Connecting to broadband

Connect one end of the Ethernet cable to the connector marked ETHERNET on the rear panel of the set-top box and the other end to a hub or the Ethernet wall connector provided by your broadband operator.

**2** Connecting to the TV set

Connect one end of the enclosed SCART cable to the SCART connector marked TV on the set-top box and the other end to your TV set. Both analog audio and standard definition video are sent to the TV set through this connection.

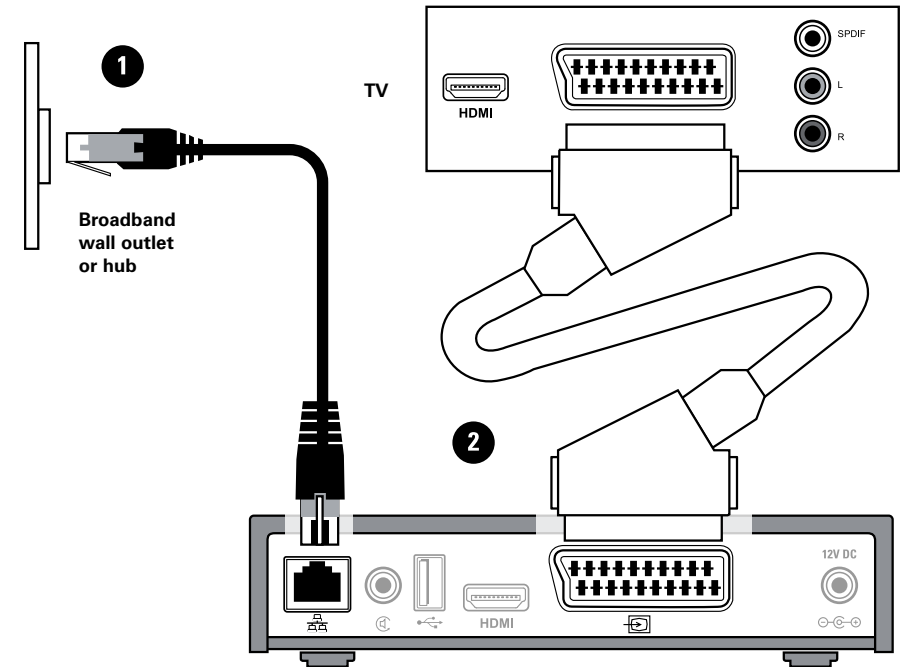

## INSTALLING

### Optional: Connecting High definition Video

If your TV set is HDTV compatible, you can connect the set-top box to the TV set using the HDMI connector instead of the SCART connector to receive and display HDTV, i.e. skip installation step 2 and replace it with installation step 3.

#### 3 Using the HDMI connector

If your TV set has a HDMI connector, you can connect it to the HDMI connector on the set-top box with a HDMI cable (not included) to receive digital high definition video and digital audio.

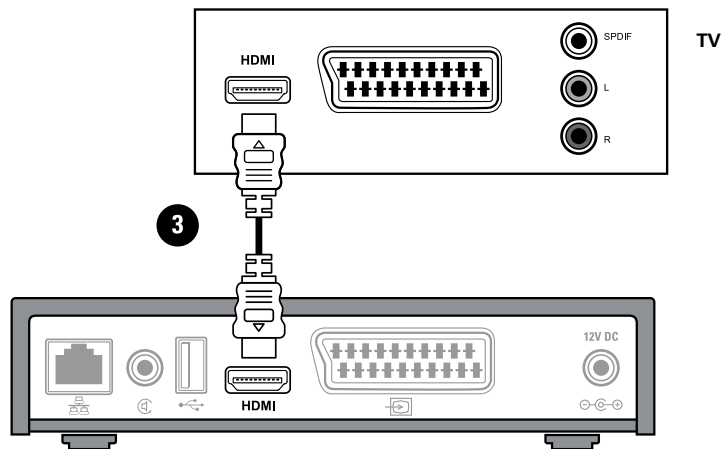

## INSTALLING

### Optional: Connecting to external audio

If you want to use an external source to play audio such as a stereo or home cinema equipment.

#### 4 Digital audio: Using the SPDIF connector

Connect an RCA cable (not included) to the SPDIF connector on the set-top box and connect the other end to your stereo or TV set.

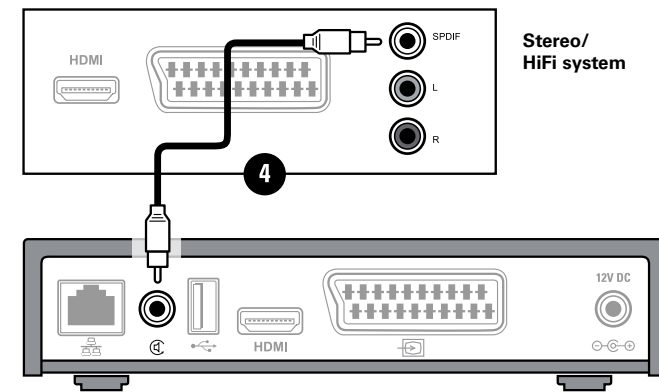

## INSTALLING

### Connecting to power

#### 5 Connecting to power

When all other cables are connected, connect the power cord to the power connector on the set-top box and to mains power.

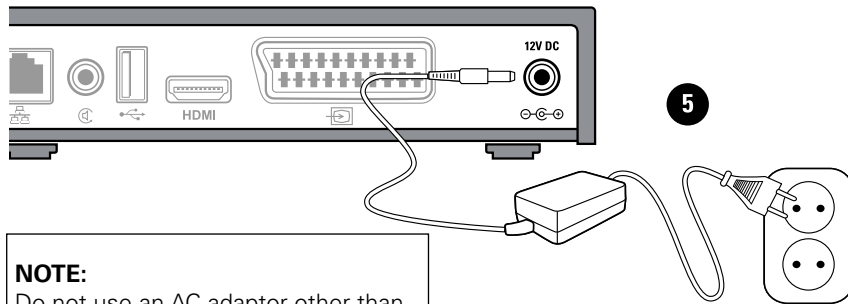

#### NOTE:

Do not use an AC adaptor other than the one that is supplied with the product. Doing so may cause fire or seriously damage the set-top box.

## DISPLAYING PICTURE

To display the signal from the set-top box on the TV set, switch to an external input. (On some TV sets this is done automatically.) There is often a button on the TV remote control for this purpose. Otherwise, see your TV User's Guide for instructions.

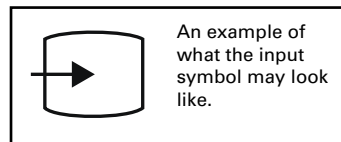

## NAVIGATING USING THE REMOTE CONTROL

The navigation buttons (the inner ring comprised by four arrow buttons and an OK button) are used to move around on Service portal pages and in menus, and to select the highlighted alternative.

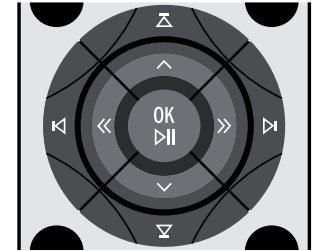

The navigation buttons are also used to navigate web pages, as the buttons of the inner ring will move the indicator between the different links. Use the **OK** button to select links to be opened.

The scroll buttons, the outer ring, are used when a web page contains more information than can be displayed on a TV screen.

For information about the functionality of the other buttons on the remote control, please see the information provided by your IPTV provider.

#### NOTE:

The remote control distributed by your service provider may differ from the standard Motorola remote control.

## OPEN SOURCE SOFTWARE INFORMATION

For instructions on how to obtain a copy of any source code being made publicly available by Motorola related to software used in this Motorola set-top box you may send your request in writing to:

Motorola, Inc.  
OSS Management  
2450 Walsh Avenue  
Santa Clara, CA 95051  
USA

The Motorola website [opensource.motorola.com](http://opensource.motorola.com) also contains information regarding Motorola's use of open source.

Motorola has created the [opensource.motorola.com](http://opensource.motorola.com) to serve as a portal for interaction with the software community-at-large.

To view additional information regarding licenses, acknowledgments and required copyright notices for open source packages used in this Motorola set-top box, please navigate to the Open Source Notices section in the user interface.

# STARTING UP

When the set-top box is connected to the TV set, Ethernet and power, you will see an image similar to the one to the right on the TV screen.



The set-top box is now connecting to the network and downloading the software needed. Please wait until the loading is finished.

Five circles will indicate the download progress during the start up of the system. From the start, all circles are dark grey. As the set-top box searches for software or is processing downloaded software, one circle at a time starts blinking yellow. When software is being downloaded, a progress bar of ten small dots appear and the corresponding circle blinks green.

When each of the five steps in the start up process is completed, the corresponding circle turns green. When all circles are green, the system is ready to run. If the software in any of the steps could not be loaded, the circle representing this step turns red and remaining steps are cancelled.

# TROUBLE SHOOTING

If you encounter any problems during start up, please note which of the circles (1 - 5) that has not turned green before you contact your support personnel.

# ON-LINE HELP

When your set-top box is up and running, please see the instructions provided by your IPTV provider on how to reach the services and how to access the User's Guide.



**MOTOROLA**

Motorola, Inc.  
Teknikringen 20  
SE 583 30 Linköping, Sweden  
<http://www.motorola.com>

11/09



5 7 1 7 5 6 - 0 0 1 - a

## Free Manuals Download Website

<http://myh66.com>

<http://usermanuals.us>

<http://www.somanuals.com>

<http://www.4manuals.cc>

<http://www.manual-lib.com>

<http://www.404manual.com>

<http://www.luxmanual.com>

<http://aubethermostatmanual.com>

Golf course search by state

<http://golfingnear.com>

Email search by domain

<http://emailbydomain.com>

Auto manuals search

<http://auto.somanuals.com>

TV manuals search

<http://tv.somanuals.com>