

Motorola

iDEN®

Digital Multi-Service Phone

i700plus™ Phone User's Guide

TTY Access

TTY access is available on your phone. See the *Wireless Data Services User's Guide* for complete instructions.

Large-Print Manuals

A large-print version of your user's guide is available. For information on Motorola products for people with disabilities, contact Motorola Customer Care at 1-800-453-0920 or TTY 1-877-483-2840.

Patent & Trademark Information

This product is protected under one or more of the following patents:

4817157, 4896361, 4857928, 5041793, 5060294, 5066923, 5134718, 5140156, 5239963, 5257411, 5287387, 5265219, 5289504, 5316168, 5317247, 5338396, 5389927, 5406588, 5424921, 5457376, 5460906, 5551063, 5557079, 5596487, 5615412, 5638403, 5559468, 5469465, 5170413, 5140615, 5519730, 5241544, 5584059, 5574992, 5396656, 5487091, 5533004, 5299199, 5343499, 5369501, 5509031, 5515379, 5528723, 5598417, 5066923, 5241650, 5278833, 5359696, 5548631, 5410632, 5440582, 5457735, 5457818, 5471670, 5477550, 5481537, 5566181, 5229767, 5208804, 5295140, 5381449, 5440590, 5467398, 5490230, 5620242, 5623523, 5655913, 5715240, 5771440, 5854578, 5675281, 5721787, 5729539, 5788523, 5869204, 5911124, 5946620, 5949774, 5949821, 5951317, 5987332, 6002948

Additional patents are pending.

MOTOROLA, the stylized M and all other trademarks indicated as such herein are trademarks of Motorola, Inc. ©Reg. U.S. Pat. & Tm. Off.

© 2000, Motorola, Inc. All rights reserved.

Manufactured under one or more of the U.S. patents listed in the User Guides.

T9 is a trademark owned by Tegic Communications, Inc.

All other product or service names are the property of their respective trademark owners.

Important!

Be sure to read "*Safety and General Information*" on page 66 before using your phone.

Table of Contents

TTY Access	2
Large-Print Manuals	2
Patent & Trademark Information	2
Table of Contents.....	iii
Welcome	9
TTY Access	10
Large-Print Manuals	10
Features of your <i>i700plus</i>	10
Attaching and Charging the Battery	12
Attaching the Battery	12
Detaching the Battery	12
Charging the Battery with the Standard Travel Charger	12
Battery and Charging Status	12
Turning On Your <i>i700plus</i> phone	13
Turning Off your <i>i700plus</i> phone	13
Keypad Lock	14
Activating Keypad Lock	14
Deactivating Keypad Lock	14
Receiving Incoming Calls	14
Receiving New Mail Messages	14
Receiving Voice Mail	15
Receiving Private (Two-Way Radio) Calls	15
Display Icons	16
About Modes and Menus	17
Setting the Time and Date	17
Changing the Display Language	19
Selectable Backlight Timer	19
Making Phone Calls	20
Using Other Dialing Methods	20
Scroll	20
Speed Dial	20
Emergency Dial	21
Automatic Redial	21
Last Number Redial	21
Turbo Dial® feature	21
Plus Dialing	22

Receiving a Phone Call	22
Ending a Phone Call	22
What Is My Phone Number?	22
VibraCall™	22
Selecting VibraCall™ feature for All Incoming Calls and Messages ..	23
Selecting VibraCall™ feature for Individual Services	23
Setting the Ringer Volume	24
Selecting a Ring Style	24
Additional phone services	25
Call Waiting	25
Turning Off Call Waiting	25
Call Hold	25
3-Way Calling	25
Alternate Phone Line	26
Setting the Active Line	26
Receiving a Call	26
Receiving a Call on Your Alternate Line	27
Phone Only Mode	27
Missed Call Indicator	28
Call Forwarding	28
Unconditional Call Forwarding	28
Conditional Call Forwarding	29
Hands-Free Speakerphone	30
Receiving a Phone Call Using Speakerphone	30
Creating, Editing, and Using Stored Lists	31
Combined Phone Number and Private ID List	31
Last 10 Calls Received and Sent Lists	34
Quickstore of Phone Numbers	35
Making Private Calls	37
Receiving a Private Call	37
Private/Group Mode Speaker	38
Call alert	38
Sending a call alert	38
Receiving a call alert	38
Call alert Queuing	38
Clearing or Queueing a call alert	39
Responding to a Queued call alert	39
Quickstore of Private IDs	39
Storing Your Private ID	40

Table of Contents

Making Group Calls.....	41
Receiving a Group Call	41
Adding and Storing a Talkgroup	41
Area Selection	42
Private/Group Mode Speaker	42
Using Mail Services	43
Net mail	43
Voice Mail.....	44
Message Mail	45
Saving and Erasing Mail	45
Auto Call Back	46
Mail Memory Full	46
Using Your Phone as a Modem	47
Setting Programming Menus.....	48
About Status Messages.....	53
Accessories.....	55
Batteries	55
Charging the Battery	55
Battery Operating Instructions	55
Travel Chargers	56
Using the Rapid Travel Charger (110V/220V/240V)	56
Standard Travel Charger Operating Specifications.....	56
Rapid Travel Charger Operating Specifications	56
Vehicular Battery Charger.....	57
Using the Vehicular Battery Charger.....	57
Removing the Vehicular Battery Charger:.....	57
Operating Specifications	57
Desktop Dual-Pocket Charger.....	58
Charging a battery:	58
Data Operation	58
Adding and removing a battery from the rear pocket	59
Desktop Charger Status.....	59
Desktop Charger Troubleshooting	59
Audio Adapter	61
Using the Audio Adapter.....	61
Attaching/Detaching the Earpiece Microphone or Headset	61
Swivel Belt Clip	62
Leather Carry Case with Clear Plastic Cover.....	62

Hands-Free Car Kit	63
Using the Hands-Free Car Kit	64
Dash Mount Holder	65
Using the Dash Mount Holder	65
Safety and General Information	66
For the safe and efficient operation of your radio, observe these guidelines:	66
Exposure To Radio Frequency Energy	66
Interference to Medical and Personal Electronic Devices	67
Pacemakers	67
Hearing Aids	67
Other Medical Devices	68
Interference to Other Electronic Devices	68
Safety and General	68
Use While Driving	68
Operational Warnings	69
Potentially Explosive Atmospheres	69
Batteries	69
Blasting Caps and Areas	69
For Vehicles Equipped with an Air Bag	69
Operational Cautions	70
Damaged Antennas	70
Batteries	70
Cleaning and Drying Considerations	70
Antenna Considerations	71
Accessory Safety Information	72
Warranty	74
Limited Warranty Motorola Communication Products	74
I. What This Limited Warranty Covers and For How Long:	74
II. General Provisions:	75
III. State Law Rights:	75
IV. How to Get Warranty Service:	75
V. What This Warranty Does Not Cover:	75
VI. Patent and Software Provisions:	76
Limited Warranty Motorola Communication Products (International)	78
I. What This Limited Warranty Covers and For How Long:	78
II. General Provisions:	79
III. State Law Rights:	79
IV. How to Get Warranty Service:	79

Table of Contents

V. What This Warranty Does Not Cover:79
VI. Patent and Software Provisions:..... 80
Owner’s Information..... 82

i700 plus

Welcome

Congratulations on purchasing your Motorola iDEN *i700plus* data-capable, multi-service, digital portable phone. Superior features and state-of-the-art technology help to keep you in constant touch with all your business and personal contacts.

Your *i700plus* phone has so many new and exciting features! With wireless access to the Internet, you can check on the latest news and weather, get stock quotes, send and receive e-mail, and download information from your computer.

A missed-call indicator lets you know that you received calls while you were away.

And, new ease-of-dialing features, such as Turbo Dial[®] and the Last 10 Calls Received and Sent lists, help you to quickly make and return phone calls. The *i700plus* phone offers:

NOTE: Some features may be network dependent or subscription only, and may not be available in all areas. Contact your Service Provider for more information.

- Phone Mode—for cellular phone operation.
See Page 20.
- Private Mode—for two-way radio use to talk with one person.
See Page 37.
- Group Mode—for two-way radio use to talk with several people. *See Page 41.*
- Net Mode—for accessing the built-in micro-browser.
See the Net Mode User's Guide.
- Mail Services—for message, voice, and net mail.
See Page 43.
- Fax and Data Transfer—for circuit data faxes and file transfers. *See Page 47.*
- TTY Access—See the *Wireless Data Services User's Guide* for information about data calls and TTY access.

NOTE: This manual describes the features of your phone as they were set up at the factory. However, your carrier or your organization may have changed or added features. For more information, check with you carrier or your organization.

This manual provides information about how Net Mode works with various features of your *i700plus* phone. For information on using the micro-browser and other components of Net Mode, see the *Net Mode User's Guide*.

TTY Access

TTY access is available on your phone. See the *Wireless Data Services User's Guide* for complete instructions.

Large-Print Manuals

A large-print version of the phone's *User's Guide* is available. For more information on Motorola products for people with disabilities, contact Motorola Customer Care at 1-800-453-0920 or TTY 1-877-483-2840.

Features of your *i700plus*

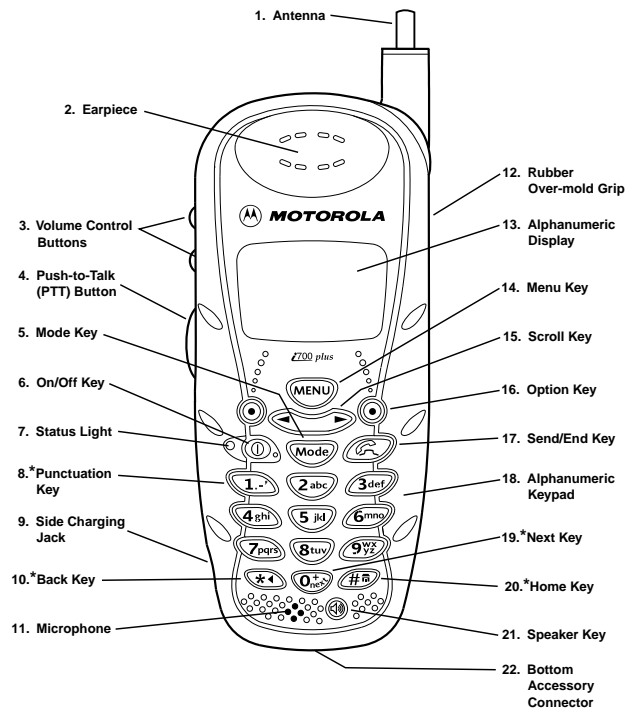

***These features are available in the Net Mode micro-browser.
(Subscription dependent features not available in all areas)**

NOTE: Remove the plastic film lens protector from the display before you use your phone for the first time.

NOTE: Some keys have multiple uses. For more information, see the Net Mode User's Guide.

NOTE: Press any key or button to turn on the keypad backlight.

1.	Antenna	Extend for optimal signal.
2.	Earpiece	Hold to your ear to hear the other party.
3.	Volume Control Buttons	Press to adjust volume levels in Phone, Private, and Group modes.
4.	Push-To-Talk (PTT) Button	Transmit a Private or Group Call, or a Call Alert. Press and hold the PTT button to talk; release it to listen.
5.	Mode Key	Press to change modes.
6.	On/Off Key	Press and hold to turn your <i>i700plus</i> phone on or off.
7.	Status Light	Check the phone's status. See <i>Table 2 on page 13</i> for more information.
8.	Punctuation Key	Add punctuation in the Net Mode micro-browser (within T9™ Text Input).
9.	Side Charging Jack	Attach charging accessories.
10.	Back Key	Return to the previous micro-browser screen.
11.	Microphone	Use to speak during calls.
12.	Rubber Over-Mold Grip	Hold the phone more securely and comfortably with the rubberized grip.
13.	Alphanumeric Display	View up to four lines (12 characters per line) or six lines (16 characters per line) on the display.
14.	Menu Key	Press to scroll through menu options.
15.	Scroll Key	Press the left key to scroll backward or the right key to scroll forward through menu options and lists.
16.	Option Key	Press the right or left option key to select the menu option that appears directly above the key.
17.	Send/End Key	Press to answer an incoming Phone call. After entering a phone number, press to begin an outgoing Phone call or to redial the entered phone number. Press to end Phone calls.
18.	Alphanumeric Keypad	Enter telephone numbers, Private Call IDs, and alphanumeric characters.
19.	Next Key	Press to display the next word choice in the micro-browser (within T9 Text Input).
20.	Home Key	Press to return to the micro-browser Home menu.
21.	Speaker Key	Press to hear incoming calls through the earpiece or the speaker during private and group conversations.
22.	Bottom Accessory Connector	Connect accessories and the data cable.

Attaching and Charging the Battery

Attaching the Battery

1. Release the lock located at the bottom of the battery door by pressing up on the latch, and remove the door.
2. Insert the battery with the “+” and “-” at the top, per the figure. Install the battery bottom first, then press down on the battery to secure it.
3. Replace the battery cover and lock by pressing down on the latch.

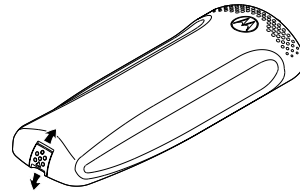

Detaching the Battery

1. Release the battery door by sliding the battery door latch upward.
2. Remove the battery door housing and remove the battery from the phone.

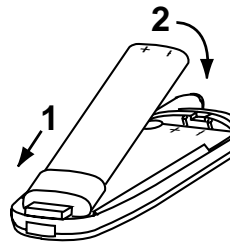

Charging the Battery with the Standard Travel Charger

Attach the Charger to the *i700plus* phone via the Side Charging Jack, and plug the Charger into an electrical outlet. For more information about Chargers, see “Accessories” on page 55.





To get the maximum use from the battery, charge it overnight before you use it for the first time. See *Table 1* for battery charging status.

Battery and Charging Status

A low battery is indicated by a short, chirp-like sound through the speaker. The battery strength indicator icon shows the remaining charge in your battery.

Three bars indicate full charge. As the charge is reduced through use, the bars disappear. The indicator flashes when you have less than five minutes of talk time.

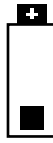
Table 1: Battery Charging Status

						
	Icon Flashes					
Charging	Low Battery	0-30%	31-60%	61-90%	91-100%	
Discharging	Low Battery	0-10%	11-40%	41-70%	71-100%	

Turning On Your *i700plus* phone

Press the On/Off button  until a set of icons appears on your display. Next, a welcome message displays while the *i700plus* phone connects to your carrier’s network.

The Status Light indicator on the *i700plus* phone shows the service state. See *Table 2*.

Table 2: Status Light Indicator

Status Light Indicator	<i>i700plus</i> phone status
Flashing Red	Registering—your <i>i700plus</i> phone is signing on to your carrier’s network. Please wait.
Solid Red	No service—your <i>i700plus</i> phone cannot sign on because it is outside your carrier’s service area.
Flashing Green	In service—your <i>i700plus</i> phone is ready to use. You can now place and receive calls.
Solid Green	In use—your <i>i700plus</i> phone is currently being used. To make sure that you ended the last call, press  .

Turning Off your *i700plus* phone

Press and hold the On/Off button  until you see the message “Powering Off”.



Keypad Lock

The i700plus includes a Keypad Lock feature that enables you to quickly lock the phone's keypad to avoid inadvertently pressing keys or placing calls. Once Keypad Lock is activated, you can only perform the following tasks (unless you receive an incoming call, page, etc.):

- Turn your phone On/Off
- Unlock the keypad

Activating Keypad Lock



Before locking your phone's keypad, you may want to read this entire section to learn how to respond to incoming calls, pages, etc.

From the **Phone Ready** screen, simultaneously press  and . The message **Keypad Locked** displays on your phone.

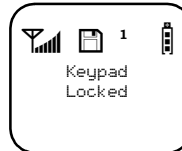
NOTE: Whenever a key is pressed, while in Keypad Lock mode, the “Keypad Locked” message displays as a reminder.



Deactivating Keypad Lock

From the **Phone Ready** screen, simultaneously press  and . The message **Keypad Unlocked** displays on your phone.



Receiving Incoming Calls

When you receive an incoming phone call, keypad lock will be temporarily disabled. You may perform the following:





Press  to answer the call. Or,

- Press  under “End” to send the call to voice mail and reactivate keypad lock.

Receiving New Mail Messages

When you receive a new mail message (see “Using Mail Services” on page 43 for more information), the keypad lock will be temporarily disabled. You may perform the following:



- Press  under “Later” to return to **Phone Ready** and reactivate the lock. Or,

- Press  under “Now”. Press  under “Read”. Press  under “Save” or “Erase”. Once you have finished, press  under “Exit” to return to **Phone Ready** and reactive the lock.

NOTE: If you have disabled the Message Mail Notification feature, only the  icon will display. You will not receive the read Now/Later options.

Receiving Voice Mail

When you receive a new voice mail (see “Voice Mail” on page 44) keypad lock will be temporarily disabled. You may perform the following:

- When **New Voice Mail Waiting** displays, press  under “Exit” to return to **Phone Ready** and reactivate the lock. Or,
- Press  under “Dial” to access Voice Mail service. Once you have finished, press  to exit Voice Mail, return to **Phone Ready** and reactivate the lock.

NOTE: If you have disabled the Message Mail Notification,  icon will display, however, “New Voice Mail Waiting” will not appear.

Receiving Private (Two-Way Radio) Calls

When you receive an incoming private (two-way radio) call (see “Receiving a Private Call” on page 37) the phone will automatically activate the applicable mode (i.e., Group, Private, etc.). Once the call is terminated and the Display Timer has expired, the phone will return to **Phone Ready** and reactivate the lock.

Display Icons

Display icons appear on the screen to inform you of existing conditions. See the following list.

The following icons may appear along the top of the display.



Signal Strength Indicator
Shows the signal strength. Six bars indicate the strongest signal. Calls and messages may not be sent or received in weak signal areas.



Battery Strength Indicator
Shows the remaining charge in your battery. Three bars show full charge. The indicator flashes when you have less than five minutes of talk time remaining.



Voice Mail
Indicates that unplayed messages are waiting in your voice mail box.



New Message Mail
Indicates that you have new text messages in your mail box.



Unread Message Mail
Indicates that you have unread Message Mail.



VibrateCall™ alert
Indicates that the Vibrate All option is turned on. You will not hear a ring tone.



Call Forward
Indicates that incoming phone calls are being forwarded.



Active Line Indication
Displays the active phone line (1 or 2).



Private/Group Speaker
Indicates that the Private/Group speaker is off. You will hear calls through the earpiece.



Packet Data
Indicates packet data registration. The blinking arrows indicate send and receive activity. For more information, see the Wireless Data User's Guide.

Some of the following icons may appear in the micro-browser.





Secure Packet Data Connection
Indicates that your packet data information is encrypted during transmission.



More Information
Indicates that there is more text to read above, below, or above and below the current screen.

About Modes and Menus

Modes and menus are the navigational tools, providing access to the various features of your *i700plus* phone. Pressing the Mode key  takes you through the mode choices. Pressing the Menu key  takes you through the menu options within each mode.



There are four modes:

- **Phone**—for cellular phone calls. See Page 20.
- **Private**—for one-to-one radio calls. See Page 37.
- **Group**—for radio calls with all individuals in a designated talkgroup. See Page 41.
- **Net**—for micro-browser use. See the *Net Mode User's Guide*.

To change modes:

Press  until you see the desired mode.

To select menu options:

Press  until you see the desired menu option, then press  under the desired menu option to select it.

Setting the Time and Date

If your carrier provides this option, you can set your phone to display the current time and date. Unless the phone is turned off, it continues to display the current time during a loss of service.

You have a choice of a 12- or a 24-hour clock format. See Table 3.

NOTE: When this feature is activated, your phone automatically displays local time.

Table 3: Time Display Options

12-Hour Display	24-Hour Display
12:00a	00:00
6:25a	06:25
12:00p	12:00
6:25p	18:25

You have a choice of either a MM/DD (month/day) or a DD/MM (day/month) date format. See Table 4:

Table 4: Date Display Options

Date	Month/Day Format (MM/DD)	Day/Month Format (DD/MM)
January 2nd	01/02	02/01
January 31st	01/31	31/01
October 9th	10/09	09/10
December 31st	12/31	31/12

If your carrier activates the time and date, they are displayed on the third line in all modes (Phone, Private, Group, Net). The time of day is also shown during an active Phone call. The time and date are not displayed in Group mode when you select an Area option.

To set the time and date format:

1. Press ***←**, **#↵**, **7para**, **1.-**.
2. Select "Ok". The Time/Date screen displays.



The default (preset) time and date format that displays depends on your carrier. You can accept the default format or select an alternate format.

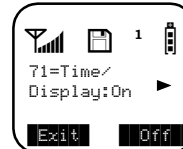

3. Press **▶** until you see the Time Format screen.
4. Do one of the following:
 - To use the 12-hour format, go to the next step.
 - To use the 24-hour format, select "24hr". (See Table 3 on page 17.)
5. Press **▶** until you see the Date Format screen.
6. Do one of the following:
7. To use the MM/DD format, select "Exit".
8. Or to use the DD/MM format, select "DD/MM", then "Exit". (See Table 4 on page 18.)

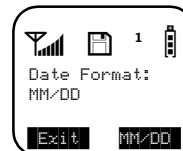
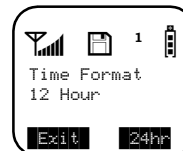

9. Select "Exit" again to leave the Time/Date Programming option. The Ready screen for each mode (Phone, Group, Private, and Net) now displays the selected time and date formats.

Changing the Display Language

You can customize your *i700plus* phone to display one of four languages: English, French, Spanish, or Portuguese.

To change the displayed language:

1. Press ***←**, **#↵**, **7pfrs**, **1.-'**.
2. Select "Ok".

Press **←** or **→** to scroll through the language options.

Selecting "Exit" at any time retains the current language selection.

3. When the desired language appears on your display, select "Ok". The displayed text immediately changes to the selected language.
4. Select "Exit".



The language that you select will be the displayed language.





Selectable Backlight Timer

Your phone's backlight is what illuminates the display when you, for example, first receive or make calls. Through your Programming Menu (***←**, **#↵**, **1.-'**, **6mno**), you can customize the amount of time that your backlight remains illuminated, either 10, 20, or 30 seconds. See "Setting Programming Menus" on page 48 for more information.

Making Phone Calls

In addition to making and receiving phone calls in Phone mode, you can forward calls, use call waiting, put calls on hold, and create and use stored lists. Phone Ready is the main screen.

You can place a call by entering the phone number on the keypad.





1. From the “Phone Ready” screen, using the keypad, enter the desired number.
If you make a mistake, press   once to move back one digit, or select “Cancel” to start over.
2. Press  to place the call.
3. To end the call, press .





Using Other Dialing Methods

To use other dialing methods such as Scroll, Speed Dial, or Name Search, names and numbers must be programmed into your phone. See “Creating, Editing, and Using Stored Lists” on Page 31.





Scroll

1. From the Phone Ready screen, press   to scroll backward or forward through the stored list of numbers and names.
2. Press  to place the call.
3. To end the call, press .

Speed Dial



1. From the Phone Ready screen, press  until you see the “Spd#” option on the last line of your display.
2. Select “Spd#”.
3. Enter the assigned speed-dial number (1-100). You will see the stored name and phone number associated with the speed dial number.
4. Press  to place the call.
5. To end the call, press .

Name Search

1. From the Phone Ready screen, select “Name”.
2. Using the keypad, enter the first letter of the desired name, for example, to search for the name Bob:
3. Enter “B” by pressing  twice.
4. Press  to scroll through all the names starting with “B” until you see “Bob”.
5. Press  to place the call.
6. To end the call, press .

Emergency Dial

You can dial the emergency phone number even if the keypad is locked. If you are on an active call, you must end it before using the emergency number.

1. From any mode (Phone, Private, Group, or Net), press and hold  for two seconds until the phone displays “EMERGENCY”. The phone then automatically dials the emergency number.
2. To end the call, press . *The emergency phone number will not be saved as the last number dialed.*

NOTE: For more information on the Emergency Dial feature, contact your carrier.

Automatic Redial

If you receive a “System Busy, Try Later” message, press  to have your phone automatically redial the number. You will hear a ring-back tone when the call is successful.

Last Number Redial

To redial the last number that you called, press .

Turbo Dial® feature

The Turbo Dial® feature enables you to quickly place a phone call by simply pressing and holding the numeric key on the keypad that corresponds to the stored entry in your Phone list directory. There are eight Turbo Dial positions, 1 through 8.

NOTE: If you are on a Phone call, place the call on hold before using Turbo Dial.

From the Phone Ready screen:

1. Select one of the first eight entries in the Phone list using key numbers 1 through 8. For example, press **1** for speed dial #1. *Keypad numbers 0 and 9 are not available for Turbo Dialing.*



2. Press and hold the desired key for two seconds to activate Turbo Dial. The phone begins to dial the number and "Phone Ready" changes to "Phone-In Use".



Plus Dialing

This feature enables you to place an International call from any country -- without entering the local international access code.

1. Press and hold **0+** for two seconds. A "0" appears, then changes to a "+" into the appropriate international access code needed to place the call.
2. Enter the international telephone number.
3. Press **Call**.

Receiving a Phone Call

Press one of the following keys: **Call**, or ***1**, or **#1**. Or press any numeric key (0 through 9).



Ending a Phone Call

Press **Call**.

What Is My Phone Number?

Press ***1**, **#1**, or **1** to display your own phone number.



VibraCall™

The VibraCall™ alert is a vibration alert system that notifies you of incoming Messages, Phone, Private, Group, and Data calls. You can set a vibration alert for all services or for individual services.

NOTE: When you set vibration alerts, they are set only for the current line. If you have a second phone line, you must select that line and repeat the procedure for selecting all services or selecting individual services to vibrate.

The alert choices are:

- Vibe All—produces a vibration alert for all incoming calls and messages.
- Phone Vibrate—produces a vibration alert for incoming phone and circuit-data calls.
- Phone Vibrate/Ring—produces a vibration alert followed by a ring tone for phone and circuit-data calls.
- Mail Vibe—produces a vibration alert for mail messages and net alerts.
- Group/Prvt Vibe—produces a vibration alert for incoming group and private calls.

NOTE: If VibraCall is set for incoming calls and messages, the power-up sequence includes a brief vibrate cycle.

Selecting VibraCall™ feature for All Incoming Calls and Messages

To set a vibration alert for all incoming calls and messages:

1. Press ***#9**.



2. Select "All". You will receive a brief vibration alert.

After you set the alert, the display returns to the previous mode and  (the Vibrate All icon) appears at the top of your display.



Selecting VibraCall™ feature for Individual Services

To set a vibration alert for specific phone or mail services:

1. Press ***#9**.

2. Press **MENU** until you see the "Selct" menu option.



3. Select "Selct". The first choice is Phone Vibrate.

4. To view the Vibe/Ring vibration alert choices, press **MENU** on the keypad.



5. To view other choices, press **▶**.

- To receive vibration alerts only for Mail, select "Mail Vibe", then select "On".
- To receive vibration alerts for Group and Private calls, select "Group/Prvt", then select "On".



6. Select "Exit" to return to the Vibrate Alert menu.
7. Select "Exit" again to return to the previous mode.



Setting the Ringer Volume

You can adjust the ringer volume for incoming calls. If you have a second phone line, you must set each line separately. Be sure to select the desired line before setting the volume.

1. Press ***←**, **#m**, **3def**, **0+_{msk}**. The "30=Ringer Volume" screen displays. The display shows your current ringer volume.
2. Press the Volume Control buttons on the side of the phone to listen as you raise or lower the volume. At the lowest setting, the screen displays "Volume Silent".
3. When you reach the desired level, select "Exit".



Selecting a Ring Style

Your phone has nine selectable ring styles. Phones with two phone lines can use the same or different ring styles for each phone line.

Incoming circuit data calls have a unique, preset ring style which you cannot change.

Setting a Ring Style

1. Press ***←**, **#m**, **3def**, **1.-'**.
1. The display shows your current ring style.
2. Select "Ok".
3. Press **←** and **→** to scroll through the available Ring Styles.
4. To listen to the selected ring style, press the Volume buttons on the side of the phone.
5. Select "Ok" to select the Ring Style shown.



To leave the ring style unchanged, select "Cancel"

6. Select "Exit".

Setting a Ring Style for the Alternate Line

1. From the Phone Ready screen, press **MENU** until you see "Line2".
2. Select "Line2".
3. Repeat the procedure for "Setting a Ring Style", above.

Additional phone services

NOTE: Some features may be network dependent or subscription only, and may not be available in all areas. Contact your service provider for more information.

Call Waiting

Using the Call Waiting feature, you can answer an incoming call when you are on another call. Call Waiting is on unless you turn it off for a particular call.

1. After the alert tone, your display shows the incoming number and asks “Accept Call?”. To accept the call, select “Yes”. To decline the call, select “No”.
2. Press **MENU**, then select “Hold” to place the second call on hold and return to the first call. Selecting “Hold” switches you between the two calls.
3. To end the active call, press **END CALL**.

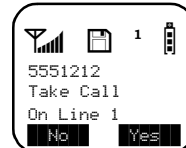

Turning Off Call Waiting

You can turn off Call Waiting if you do not want to be interrupted during a call.

1. Press **MENU** until you see “Wait”, then select “Wait”.
2. Select “Off”. Call Waiting will be disabled for one call—but will automatically reset to “On” after that call.

Call Hold

When you are on a call, you can place the call on hold and make a second call.

1. To place the active call on hold, press **MENU**, then select “Hold”. You may then answer or place another call.
2. To remove the call from hold, press **MENU**, then select “Hold” again.

3-Way Calling

If your carrier provides 3-way calling, you can combine two ongoing phone calls into one conversation. This option is available only when you initiate the second call.

After you place or receive a phone call:

1. Select “3way”. This action places the current call on hold.
2. Enter the phone number for the second call and press **END CALL**.



3. When the second call is connected, select “3way” to join the calls. Both phone numbers and “3way” appear on your screen.
4. To end the 3-way call, press .

Alternate Phone Line

If your phone is activated with two phone lines, you can switch between them. To change phone lines, your phone must be at the Phone Ready screen. The following settings are independent for each phone line. When you enable a setting, it applies only to the active line.

- Ringer Volume
- Auto Answer
- One-minute Beep
- Automatic Display Timer
- Resettable Timer
- Total Call Timer
- Selectable Ring Styles
- Call Forwarding

Setting the Active Line

At the “Phone Ready” screen:

1. Press  until you see “Line2”. (If you are on Line 2, you will see “Line1”.)
2. Do one of the following:
 - Select “Line2” to activate Line 2 when Line 1 is the active line.
 - Or, select “Line1” to activate Line 1 when Line 2 is the active line.





Outgoing calls will be made on the selected line.

Receiving a Call

You can receive calls on either line, regardless of the active line setting.

- If you receive a call on the currently active line, that icon simply flashes.
- If you receive a call on the line that is not currently active, the active line icon remains lit and the alternate line icon flashes.

Receiving a Call on Your Alternate Line

1. Select "Yes" to answer the call on the other line. Your previous call will be placed on hold.
2. Do one of the following:
 - To end the call, press .
 - Or, to place the current call on hold, or to toggle between calls, press , then select "Hold".

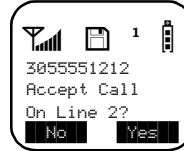





When the call ends, the phone remains active in the last active line selected.

Phone Only Mode

If your carrier provides this option and you subscribe to it, you can turn off Private, Group, and micro-browser services. You can still make and receive phone calls and receive Message Mail and circuit-data calls.

Placing the phone in Phone Only mode increases the standby battery life. Make sure that the status light is blinking green, which indicates that you are in a coverage area.

To turn on Phone Only mode:

1. Press , , , .
2. Select "On".



3. Select "Exit".



The "Phone ONLY" message displays. Group call, Private call and micro-browser services are now suspended.



To restore all services:

1. Press , , , .



2. Select "Off".
Select "Exit". The display returns to Phone Ready.
All services are now available.



Missed Call Indicator

Your i700plus phone notifies you of received, but unanswered phone calls. If you subscribe to Caller ID, the caller's phone number is stored in your Last 10 Calls Received list. Your screen displays a flashing message, for example, "2 Rcvd Calls", with the number of missed calls.



Press any key to clear the flashing indicator.

To retrieve the missed calls:

1. From the Phone Ready screen, press **MENU**. The menu options change to "Calls" and "Spd#".
2. Select "Calls". The Rcvd Calls screen opens with the number, time, and date of the last call that you received.
3. Scroll to continue viewing the list.



Call Forwarding

Call forwarding lets callers reach you when you are not available via your iDEN phone. You have two options: forward all incoming calls (unconditional) or select those circumstances (conditional) when you want your calls forwarded.

Unconditional Call Forwarding

Unconditional call forwarding sends all incoming calls to the designated number.

NOTE: When you set unconditional call forwarding, you phone does not ring.

1. From the Phone Ready screen, press **MENU** until you see "Forwd" on the last line of the display.
2. Select "Forwd".



3. To select the number where you want your calls forwarded, do one of the following:
 - Enter a number.
 - Or, press the scroll keys to select a number from your stored list.
4. Select “On”.
5. After the “Please Wait” message displays, select “Exit”.
6. Notice that the Call Forward icon  appears on your display when Unconditional Call Forwarding is set.





Conditional Call Forwarding

You may want to forward your calls when your *i700plus* phone is:

- Busy on another call or the micro-browser (Busy)
- Not answered (NoAns)
- Outside the service area (NoRch).

NOTE: You must turn off Unconditional Call Forwarding before you can set Conditional Call Forwarding options.

1. From the Phone Ready screen, press  until you see “Forwd” on the last line of your display, then select it.
2. Press  once again until you see “Busy” and “NoAns” on the last line of your display.
3. To forward your calls when your phone is in use, select “Busy”.
4. To forward your calls when you do not want to answer them, select “NoAns”.
5. Press  again until you see “NoRch” and “Rcl#”.
 - To forward your calls when you cannot be reached, select “NoRch”.
 - To see the call forward number, select “Rcl#”.
6. After you select the call forward option, either enter the number where you want your calls to be forwarded, or press the scroll buttons and select a number.
7. Select “On”.
8. Select “Exit”.
9. You can set more than one condition by repeating steps 2 through 6.



Hands-Free Speakerphone

NOTE: Hands-Free Speakerphone is an optional upgrade to your phone. For more information, please contact your carrier.



Your phone provides the convenience of a speakerphone for holding impromptu meetings or listening to your voice mail messages.

During speakerphone operation, you may either speak or listen, but you cannot do both at the same time.

To use the speakerphone:

1. Select "Spkr". The "Spkr" option flashes while the speakerphone is on.
2. Place the phone 15-30 inches (380 - 760 millimeters) away from you. In a noisy environment, you may want to move your phone closer to you for better transmission.

NOTE: If there is background noise in your area, you may have difficulty hearing a caller's voice or messages. To resolve this problem:

- (1) Press  until you see the "Mute" menu option.
- (2) To listen, press  under "Mute". The display changes from "Phone in Use" to "Phone Mute", indicating that the microphone is muted.
- (3) To speak, press  under "Mute" again. The display changes from "Phone Mute" to "Phone In Use", indicating that the microphone is on.

While the microphone is muted, you can hear incoming audio, but a caller cannot hear any speech coming from your phone.

Receiving a Phone Call Using Speakerphone

Select "Spkr" to activate the speakerphone.

Creating, Editing, and Using Stored Lists

A stored list is a directory of phone numbers and Private IDs and their related names. Stored lists are convenient because you do not have to remember names and numbers—you simply scroll through your stored list.

Combined Phone Number and Private ID List

You can set a combined Phone and a Private ID with the associated name, which eliminates the need to program the Private ID separately. You can add up to 100 numbers to your Phone list, store them with names, and assign them to speed-dial numbers.

Entering Numbers

To enter a number, press the corresponding key on the keypad.

Entering Names



To enter a letter, press the key the required number of times, which is related to the letter's position on the key. Table 5 describes how to enter each letter on the  key.

Table 5: Entering Letters and Numbers on the Keypad

To enter:	Press 
P	once.
Q	twice.
R	three times.
S	four times.
7	five times.

To shift to lowercase letters, press and hold  after a letter is entered.

Storing Names and Numbers

1. Press ***←**, **#**, **2^{abc}**, **0⁺**.



2. Select "Ok".

The next screen briefly displays the remaining number of phone numbers and private IDs that you can store.



3. Enter the name that you wish to store.

Select "Store".

See Figure 4. for an example of entering a name.



Example

To store the name "TIM":

1. Enter "T" by pressing **8^{tuv}** once.
2. Enter "I" by pressing **4^{ghi}** three times.
3. Enter "M" by pressing **6^{mno}** once.

Figure 4. Entering a Name

5. Enter the phone number that you want to associate with this name and select "Store".

To skip the Phone Number entry, select "Skip". You will go directly to the "Enter Prvt ID Number" screen.



The next screen displays the name that you entered and a flashing speed-dial number where the entry will be stored.

6. Do one of the following:

- To accept the speed-dial number shown, select "Store".
- To change the speed-dial number, enter the desired speed-dial number. The speed-dial number stops flashing.



7. At the next screen, enter the Private ID number associated with the name that you entered then select "Store".

To skip the Private ID number entry, select "Skip".



Pause Digit Entry

When storing a number, you can program your phone so that it will not only dial a number but also pause and enter another series of numbers such as a personal identification number (PIN) or password. This feature is particularly useful for automated services such as voice mail and banking systems.

Here's how it works. Let's say you have a company voice mail account that you frequently check while on travel. And, to access that account you must do the following:

- Dial your work number;
- Press ***⏪** while the voice mail greeting is being played; and
- Enter your PIN to access your messages.

You can program your i700plus to enter all of the above information for you. All you have to do is separate each entry with a pause. If you were to program your phone to input the above information, the stored data would look like this: 17035551234P1234. In this example, the first eight digits represent the number that must be dialed to access your voice mail. The P represents a 3 second pause. The last four digits represent your PIN.

You can use this feature not only to enter PINs and passwords but also to have the phone automatically select menu options (i.e., press **1.->** to hear messages).

To create a three-second pause follow the steps below:

- Press and hold ***⏪** for two seconds. The pause symbol (P) will appear.







NOTE: You can enter up to 20 numbers/characters in a single entry, stored or dialed. If you use a system that will not let you enter an option until the automated message has played in its entirety, you can program your phone to pause for more than 3 seconds. For example, performing the above step twice will program two pauses and cause your phone to wait 6 seconds before entering the next set of numbers.

Editing and Erasing Phone List Entries

1. Press ***⏪**, **#n**, **2abc**, **1.->**.
2. Select "Ok". The "Edit Entry?" screen displays.
3. Do one of the following:
 - a. To edit an entry, select "Ok".
 - (1). At the "Edit Entry" screen, press **▶** until the desired entry appears, then select "OK".
 - (2). At the "Edit Number" screen, edit the phone number, if you wish, then select "Store".
 - (3). At the "Edit Name" screen, edit the name, if you wish, then select "Store".
 - (4). At the "Edit Spd#" screen, edit the speed number, if you wish, then

- select "Store".
- b. To erase an entry:
 - (1). At the "Edit Entry" screen, press .
 - (2). At the "Erase Entry" screen, select "Ok".
 - (3). Scroll to the desired entry, then select "Ok". At the "Erase Entry?" screen, select "Yes".
- 4. Select "Exit" to close the Phone List Edit screen.

Editing and Erasing Private ID List Entries

- 1. Press , , , .
- 2. Select "Ok". The "Edit Entry?" screen displays.
- 3. Do one of the following:
 - a. To edit an entry, select "Ok".
 - (1). At the "Edit Entry" screen, press  until the desired entry appears, then select "OK".
 - (2). At the "Edit ID" screen, edit the number, if you wish, then select "Store".
 - (3). At the "Edit Name" screen, edit the name, if you wish, then select "Store".
 - b. To erase an entry at the "Edit Entry" screen, press  once, then select "Ok". Press  to scroll to the desired entry, then select "Ok". At the "Erase Entry?" screen, select "Yes".
- 4. Select "Exit" to close the Private ID List Edit screen.

Last 10 Calls Received and Sent Lists

If you subscribe to your carrier's Caller ID service, you can view, dial, and store the list of the last ten phone numbers received and the last ten phone numbers dialed.

The most recent call sent or received appears first in your call list.

From the Phone Ready screen:

- 1. Press . The menu options change to "Calls" and "Spd#".
- 2. Select "Calls". The Rcvd Calls screen opens.



Creating, Editing, and Using Stored Lists

If the “Store” option appears, the number currently displayed is not in your Phone list. To add the number to your list, select “Store”.

If you want to see the Sent list but the “Store” option is on your display, press **MENU** until you see the “Sent” menu option.

3. Do one of the following:
 - To view the Calls Received list, use the Scroll key to view each entry.
- If the “Store” option is on your display, press **MENU** until you see the “Rcvd” menu option.
- Or, to view the Calls Sent list, select “Sent”. Use the Scroll key to view each entry.
- (4) To view the Calls Received list again, select “Rcvd”.
 - (5) To close the Calls list, select “Cancel”.



Quickstore of Phone Numbers

If you subscribe to your carrier’s Caller ID service, you can use Quickstore to store the last number that you dialed or quickly store a number from the Last 10 Calls Received and Sent Lists without having to enter the programming menu.

NOTE: As you scroll through the Last 10 Calls Received or Sent List, only the name displays. If the name is not available, the phone number displays.

To use Phone Number Quickstore, from either the Phone Ready screen or from the Last 10 Calls Received or Sent List:

1. Do one of the following:
 - To go to the last call that you dialed, press **▶**.
 - To view the Received and Sent Calls list, press **MENU** until you see “Calls”, then select it.
2. Select “Store”. The Enter Name screen displays.
3. Enter the name then select “Store”.



The combined name and number entry is stored in the first available storage space.

The Stored message displays with the name that you stored.



Making Private Calls

A Private call is a one-to-one conversation between two people. In Private mode, each *i700plus* phone is identified by a name or a number called a Private ID.

To make a Private Call:

1. Press **Mode** until you see “Prvt Ready” on your display.
2. Use the keypad to enter the Private ID of the person that you want to reach.
3. To speak, press and hold the PTT button, wait for the chirp, then speak into the microphone.
4. To listen, release the PTT button.



To use Scroll or Name Search, you must have a Private ID list.

Scroll

1. Press **Mode** until you see “Prvt Ready” on your display.
2. Press **Left Arrow** to scroll through the stored Private ID list.
3. Press and hold the PTT button, wait for the chirp, then speak into the microphone.

Name Search

1. Press **Mode** until you see “Prvt Ready” on your display.
2. Select “Name”.
3. Press the key with the first letter of the name you are searching for.
4. Press **Left Arrow** to scroll through other stored names associated with the letter you entered.
5. Press and hold the PTT button, wait for the chirp, then speak into the microphone.

Receiving a Private Call

When you receive an incoming Private call, you hear a brief chirp-like tone. Your *i700plus* phone automatically switches to Private mode, and the Private ID or the name of the caller displays.

1. Your phone must be idle, that is, not busy in an active call or on the microphone.
2. Wait for the caller to finish speaking.
3. Press and hold the PTT button. Begin speaking after you hear the chirp.

Private/Group Mode Speaker

You can hear Private calls through either the earpiece or the speaker. Press the Speaker button (🔊) on your *i700plus* phone to turn the Private/Group Mode Speaker on or off.

- With the Speaker on, you will hear incoming calls through the speaker.
- With the Speaker off, you will hear incoming calls through the earpiece.

Call alert

Call alert enables you to page an individual by sending an audible tone. A Call Alert allows the individual to respond when it is convenient. The alert plays intermittently until the individual clears it.

Sending a call alert

1. Press **Mode** to go to the “Prvt Ready” screen.
2. Select “Alert”.
3. Enter the Private ID, or press  to scroll to the desired name. You may also select the name by pressing **MENU** and using Name Search.
4. Press the PTT button.

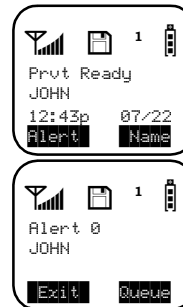

Receiving a call alert

When you receive a call alert, you will hear an alert tone and see a message on your display.

- To answer the call alert, press the PTT button.
- To clear the call alert without answering it, select “Clear”.
- To silence the call alert without clearing it, press any key other than the PTT button.

NOTE: Until the call alert is cleared or returned, the alert plays intermittently and you will not be able to receive any additional Phone, Private, Group, or Net calls.

Call alert Queuing

If your carrier provides call alert Queuing, you can save up to eight call alerts in a queue for later use.

After you respond to the call alert, it is removed from the queue.

Clearing or Queuing a call alert

When you receive a call alert, do one of the following:

- To clear a call alert, select “Clear”.
- To place the call alert into the queue, select “Queue”. Pressing **Mode** also queues the call alert.

If you receive multiple call alerts, the last received call alert displays and the remaining call alerts are stacked at the beginning of the queue.



Responding to a Queued call alert

You can respond to the call alerts in any order. To select a call alert for response:

1. Select “Queue”.
2. Press **Left Arrow** to scroll to the desired call alert.
3. Press the PTT button to respond to the call alert.

Quickstore of Private IDs

Quickstore allows you to quickly store a received or sent Private ID, without having to enter the programming menu.

The ID is added as the last number received or sent in Private mode.

From the Private Ready screen, with the Private ID displayed:

1. Select “Store”.

If an ID is greater than 12 characters in length, the ID wraps to the third line.

2. Enter the name associated with the Private ID.

3. Select “Store”. The Stored message displays.

If the list is full with the maximum 100 entries, you will get the message, “Prvt List Full”. You cannot add names until you remove some names from the list.



- Next, the display returns to the Private Ready mode.



Storing Your Private ID

To store your Private ID in your i700plus phone:

- Press ***←**, **#↵**, **2abc**. The screen displays the message, “2=Own Pvt ID”.
- Select “Ok”.
- Enter the Private ID provided by your carrier.
- Select “Store”.

To view your Private ID at any time after you store it:

- Press ***←**, **#↵**, **2abc**. The screen displays the message, “2=Own Pvt ID”. The next line displays your Private ID. *This is the number supplied by your carrier that you store in your phone.*
- Select “Exit”.

Making Group Calls

A Group Call allows you to communicate instantly with members of a selected Talkgroup—a pre-defined set of people who share a communication need.

Talkgroups appear on your display as numbers or programmed names, such as Talkgrp10 or Sales Team.

To make a Group Call:

1. Press **Mode** until “Group Ready” displays. Your most recently used talkgroup displays, for example, “Talkgrp 10”.
2. To place a call, do one of the following:
 - To speak to this talkgroup, press and hold the PTT button. Wait for the chirp, then speak into the microphone.
 - To speak to another talkgroup, press **Left Arrow** until you see the desired talkgroup name. Press and hold the PTT button. Wait for the chirp, then speak into the microphone.
3. To listen, release the PTT button.



Receiving a Group Call

When you receive an incoming Group call, you will hear a brief chirp-like tone. Your *i700plus* phone automatically switches to Group mode, and the Talkgroup name displays.

1. Your phone must be idle, that is, not busy in an active call or on the microphone.
2. Wait for the caller to finish speaking, then press and hold the PTT button. Begin speaking after you hear the chirp.
3. To listen, release the PTT button.

You can receive group calls only in the Talkgroups that you have predefined. For more information, see “Adding or Storing a Talkgroup” on Page 41.



Adding and Storing a Talkgroup

To add and store a talkgroup name to your *i700plus* phone:

1. Press ***Left Arrow**, **#**, **2abc**, **3def**.
2. Select “Ok”.
3. At “Add New Entry?”, select “Ok”.
4. At “Enter ID”, enter the desired talkgroup number and select “Store”.
5. At “Enter Name”, enter a name for the talkgroup and select “Store”.

Area Selection

In Group mode, you can call only those talkgroup members in a specific location. This is useful when you know where the individuals are located within the service area.

1. Press  until you see “Group Ready” on your display.
2. Press , then select “Area”.
3. Press  to scroll through the targeted areas specified by your local carrier.
4. Select “Ok” to select the targeted area.

Private/Group Mode Speaker

You can hear Group calls through either the earpiece or the speaker.

Press the Speaker button  on the *i700plus* phone to turn the Private/Group Mode Speaker on or off.

With the Speaker on, you will hear incoming calls through the speaker. This is useful to monitor talkgroup activity in Group mode.

With the Speaker off, you will hear incoming calls through the earpiece.

Using Mail Services

NOTE: Some features may be network dependent or subscription only, and may not be available in all areas. Contact your service provider for more information.

Your *i700plus* phone provides the following mail services:

- Net mail
- Voice Mail
- Message Mail

When you receive a new message, the  icon appears and flashes.

- To read your new mail immediately, select “Now”.
- To read your new mail later, select “Later”.

An asterisk  next to a mail service indicates new mail.

To use message services, select “Mail” from any Ready screen. The inbox screen opens with your message services listed.

To select a message service, scroll to highlight the service or press the corresponding number. For example, to access your Message Mail, press .

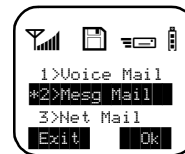

Net mail

Net mail alerts you when you receive alerts from the micro-browser, for example, notification of an e-mail or fax.

From any mode:

1. Select “Mail”.
2. Select “Net Mail”, then select “Ok”.

The Alerts inbox opens and displays the type of Net Mail alerts.



The Inbox screen opens.

3. Scroll to the type of alert that you wish to view, then select “Ok”.

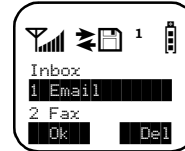

- To read the message, select “View”.



- After you read the message, do one of the following:

- Select “Menu” to view a list of actions that you can take for this message, such as reply, delete, save, and so forth.
- Or, select “Next” to read the next message.



Voice Mail

When your *i700plus* phone receives a Voice Mail message:

- The icon appears on your display.
- The Voice Mail alert tone sounds (if Mail Notification is turned on).
- The message, “New Voice Mail Waiting” appears on your display.
- An exclamation point (!) on the display indicates that you have at least one urgent message.

From any mode:

- Select “Mail”.
- Select “Voice Mail”.



The Voice Mail inbox opens and displays the number of your new and total Voice Mail messages.

To retrieve your voice mail immediately:

- Select “Dial”. This action automatically places a call to your voice mailbox. The most recent message is retrieved first.
- To close your voice mailbox, select “Exit”.



Alert Receipt

Through your programming menu (*← , #Ⓜ , 1→ , 5 jkl) you can delay Voice Mail and Message Mail Alerts so that you are not interrupted by the alert tone while on a call. You can choose the following:

- Receive All Alerts
- Delay All Alerts
- Receive Message Mail Alerts only

See “Setting Programming Menus” on page 48 for more information.

Message Mail

Message Mail can be either a numeric page or a text message of up to 140 characters. Your phone can receive and store 16 mail messages at any time.

1. To postpone reading your mail and to clear the display, select “Later”. The icon stops flashing but remains on your display to remind you that you have unread messages.

To read you mail now:

2. To read your mail now, select “Now”. The screen will briefly display the number of new and saved messages in your mailbox.
3. A list of all your messages will display. Highlight the message that you wish to read and select “Read”.

To read you mail later:

4. From any mode, select “Mail”. The Mailbox opens.
5. Select “Mesg Mail”.

Your message mailbox opens and briefly displays the number of new and saved messages currently in your mailbox.

Next, a list of all messages will display. Select the message that you wish to read and select “Read”.

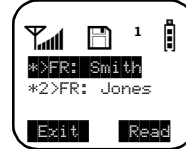

Saving and Erasing Mail

Your message shows the time and date that the sender entered it in the network

After you read a text or numeric message, you can either Save or Erase the message. Press  under the desired option.



Auto Call Back

You can respond to numeric pages and text messages containing a call-back number. To automatically dial a number contained within a Message Mail, press .

Mail Memory Full

If all 16 message registers are full, your phone displays the message “Mail Waiting, Memory Full”. You cannot receive new Message Mail until you empty register space by erasing saved or unread messages.

Using Your Phone as a Modem

NOTE: Some features may be network dependent or subscription only, and may not be available in all areas. Contact your service provider for more information.

You can use your *i700plus* phone as a modem for data transfer from your laptop, handheld device, or desktop computer. This is particularly useful when there is no wired phone line (wall jack) available.

You simply attach a data cable to your phone and your computer. From that point, your phone is your modem. This allows you to send or receive time-critical information such as e-mail, a field service report, or files. In addition, you can also send or receive faxes.

This type of wireless connection uses one of two types of data connection: circuit-switched data and packet data.

- Circuit-switched data is typically used for sending and receiving faxes and for transferring large files.
- Packet data is used for small file transfers such as e-mail.

To use these services, you must install the iDEN Wireless Data Services software. For more information on setting up your computer and your *i700plus* phone for Packet and Circuit Data calls, see the *Wireless Data Services User's Guide* and contact your carrier.

TTY Users

You can use your phone and computer in TTY mode. Your computer screen and keyboard replace the standard TTY device. For more information, please see the *Wireless Data Services User's Guide*.

Setting Programming Menus

You can customize the settings on your phone using the Programming Menu.

1. Press **MENU** until you see “Prgm” on the display.
2. Select “Prgm”.
3. Select “Ok”.
4. Press **←** or **→** to scroll to the desired Programming Menu Option or enter the number of the Option.

NOTE: You can press ***←**, **#→**, and then the corresponding keypad number to get to the desired programming menu.

Table 6: Programming Menu Options

Keypad Number	Menu Option	Function
1	Own Ph #	Automatically store the telephone number of your phone after you receive the first incoming call (Line1). You can also enter the number and view it.
2	Own Pvt ID	Display the private number of your phone.
3	Mail Display:Off	Turn on and off the New Mail message that is displayed with incoming Voice, Message, or Net mail.
4	Manual Lock:Off	Lock your phone to prevent unauthorized use. You must enter a pass code to unlock it. Even with the manual lock on, you can reach emergency help by pressing and holding the emergency key designated by your carrier.
5	Auto Lock:Off	Automatically lock your phone each time it is powered off to prevent unauthorized use.

Table 6: Programming Menu Options (Continued)

Keypad Number	Menu Option	Function
6	Auto Answer:Off	Turn on or off automatic answering of incoming phone calls after 1-4 rings.
9	Vibrate Alert:Off	Receive a non-audible alert for incoming phone and circuit data calls and messages. See “ <i>VibraCall™</i> ” on page 22.
10	Last Call Timer	Display the duration of the most recent phone call.
11	Display Timer:Off	Turn on or off automatic display of the Last Call Timer at the end of each phone call.
12	Reset Timer	Display cumulative airtime of all phone calls since last reset.
13	Total Timer	Display cumulative airtime of all phone calls.
14	1 Minute Beep:Off	Automatically signal each minute of elapsed phone airtime with an audible beep.
15	Alert Receipt	Delay Voice Mail and Message Mail Alerts so that users are not interrupted by the alert tone while on a call. Users can choose to: Delay All Alerts; Receive All Alerts; Receive Message Mail Alerts only. See “ <i>Alert Receipt</i> ” on page 45.
16	Selectable Backlight Timer	Specify the duration of the Backlight Timer (10, 20, or 30 seconds).
20	Phone/Prvt List	Add phone and private numbers in one procedure. See “ <i>Combined Phone Number and Private ID List</i> ” on page 31.

Table 6: Programming Menu Options (Continued)

Keypad Number	Menu Option	Function
21	Phone List Edit	Edit and erase up to 100 frequently called phone numbers and associated names. See <i>"Editing and Erasing Phone List Entries"</i> on page 33.
22	Prvt ID List Edit	Edit and erase up to 100 Private numbers and associated names. See <i>"Editing and Erasing Private ID List Entries"</i> on page 34.
23	Talkgrp List Program	Add/Edit/Erase numbers and associated names for up to 10 pre-programmed talkgroups. See <i>"Adding and Storing a Talkgroup"</i> on page 41
24	Area List Program	Add/Edit/Erase numbers and associated names for up to 50 targeted areas.
30	Ringer Volume	Set the ringer volume using the volume control keys, or lower the volume to silence the ringer. See <i>"Setting the Ringer Volume"</i> on page 24.
31	Set Ring Style	Select a distinct ring style for incoming phone calls. See <i>"Selecting a Ring Style"</i> on page 24.
32	Mail Volume	Set the volume of incoming Message Mail, Voice Mail, and Net alert tones using the volume control keys, or lower the volume to silence the mail alert tones.
33	Earpiece Volume	Set the default earpiece volume using the volume control keys.

Table 6: Programming Menu Options (Continued)

Keypad Number	Menu Option	Function
34	Keypad Volume	Set the volume of the keypad tones using the volume control keys, or to silence the keypad tones.
35	Speaker Volume	Temporarily adjust the Group/Private Speaker volume for noisy environments.
36	Spkr Vol Set Tone	Turn the speaker volume set tones on or off.
38	Silent Group	Silence all incoming Group call alerts and voice activity. When set, your screen displays the message, Group Silent.
40	Change Passcode	Change your secret four-digit passcode from the initial setting 0000.
60	Set Baud Rate	Set the modem baud rate between the phone and the PC. See the <i>Wireless Data Services User's Guide</i> .
61	Data Ring Volume	Set the default data ringer volume using the volume control buttons. See the <i>Wireless Data Services User's Guide</i> .
62	Pgm Data #	View your circuit data (fax) number. See the <i>Wireless Data Services User's Guide</i> .

Table 6: Programming Menu Options (Continued)

Keypad Number	Menu Option	Function
63	IP Address	Use the scroll keys to view the Internet Protocol (IP) Address-1 for your micro-browser, as programmed in your phone. If your phone is cabled to a computer, view IP Address-2, the stored IP address of your computer. See the <i>Wireless Data Services User's Guide</i> .
64	Reset KBytes Tx/Rx	View the number of Kilobytes sent and received for packet data. See the <i>Wireless Data Services User's Guide</i> .
65	Lines per Screen <i>(micro-browser and Mail menu)</i>	View the display in 4 lines, 12 characters or 6 lines, 16 characters.
70	Language	Select one of four languages for your display text. <i>The default is English.</i> See "Changing the Display Language" on page 19.
71	Time/Date	Select the format for the time and date display. See "Setting the Time and Date" on page 17.
80	Phone Only	Turn on or off incoming Private, Group, and micro-browser data services. See "Phone Only Mode" on page 27.

NOTE: Important! Do not perform the following shaded menu options unless you are instructed to do so by your carrier. You could damage your phone.

NOTE: In the micro-browser, do not select the "Advanced Encryption New" key. Instead, contact your carrier.

Table 7: Other Programming Menu Options

Option Number	Menu Option	Function
41	Feature Reset	Returns all feature settings to their original defaults.
42	Master Clear	Performs Feature Reset and erases all stored lists.
43	Master Reset	Resets the phone's identification number.
44	Change Service Key	Changes or resets the fraud prevention service key.
50	NAM	Selects alternate Numeric Assignment Module (NAM). See local carrier for information.
51	Network ID	Edits the pre-programmed Network number list and selects roaming options.

About Status Messages

You may receive status messages under certain conditions. Before contacting your carrier, note the message, numeric code, and the conditions under which it appeared. Table 8 lists and describes the error messages.

Table 8: Status Messages

Status Messages	Message Description
Number Not in Service	The number that you entered is not valid.
User Not Available	The party that you called is either busy, out-of-range, or turned off. Please try again later.
User Not Authorized	The party that you called has not purchased this service.

Table 8: Status Messages (Continued)

Status Messages	Message Description
Please Try Later	This service is temporarily not available. Please try again later.
User Busy in Private	The party that you called is busy in a Private call.
Service Restricted	This service was restricted by your carrier or it was not purchased.
Service Not Available	This feature is not available on the current network.
System Busy Try Later	The system is experiencing heavy traffic. Please try again later.
Service Conflict	This service cannot be enabled because an incompatible service has already been turned on.
Please Try Again	An error occurred. Note the error code and try again.
User Busy in Data	The party that you called is busy in a data call.
Self Check Error	A fault was detected with your phone. If this error recurs, note the error code and contact your carrier.
Self Check Fail	An operational fault was detected with your phone. Note the numeric code, turn your phone off, and contact your carrier immediately.

Accessories

Batteries

NOTE: For best results, charge the batteries within the temperature range of 10° C to 40° C (50° F to 104° F).

NOTE: Prolonged charging is not recommended. See Table 9 for battery charging guidelines.

Charging the Battery

To get the maximum use from the battery, charge it overnight before you use it for the first time. See Table 9 for battery charging times.

Attach the Charger to the *i700plus* phone via the Side Charging Jack, and plug the charger into an electrical outlet.

Table 9: Battery Charging Times

Motorola Battery		Charging Time to 90%:	
Kit Number	Description Chemistry	Standard Travel Charger	Rapid Charger
NTN8971	Standard NiMH	7 hours	105 minutes
NTN8970	Slim NiMH	3.5 hours	50 minutes

Battery Operating Instructions

- Extreme temperatures will degrade battery performance. Do not store your battery where temperatures exceed 60°C (140°F) or fall below -20°C (4°F).
- The battery capacity will be degraded if stored for long periods while fully charged. If long term storage is required, store at half capacity.
- For optimal battery life, use a Motorola iDEN approved NiMH Charger with your Motorola iDEN NiMH battery. Other chargers may not fully charge your NiMH or may yield a reduced number of charge cycles.

Travel Chargers

Using a Travel Charger, you can charge a battery from an electrical outlet.

You can use:

- The SPN4474 Standard Travel Charger
- The NTN1680 Rapid Travel Charger (110V/220V/240V) with U.S. Plug Adapter

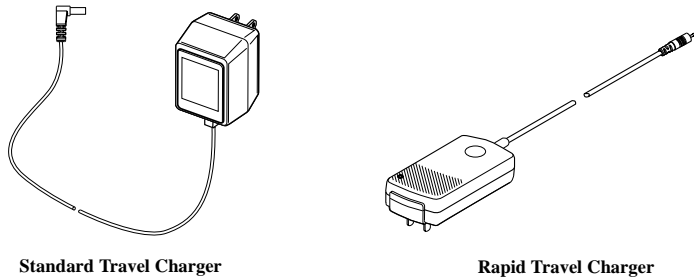

Standard Travel Charger

Rapid Travel Charger

Figure 5. Using the Travel Chargers

Using the Standard Travel Charger

1. Insert the Standard Travel Charger's power supply plug into an electrical outlet (110V U.S.).
2. Insert the Charger's DC plug into the Side Charging Jack on your *i700plus* phone.

Using the Rapid Travel Charger (110V/220V/240V)

1. Insert the wall plug adapter into the Rapid Travel Charger's power supply.
2. Insert the Charger's power supply into an electrical outlet.
3. Insert the DC plug into the Side Charging Jack of your *i700plus* phone.
4. The power light (green LED) turns on when the Rapid Travel Charger is receiving power.

Standard Travel Charger Operating Specifications

Input voltage range: 110V - U.S.

Operating temperature range: 0°C to +50°C.

Rapid Travel Charger Operating Specifications

Input voltage range: 110V/220V/240V.

Operating temperature range: 0°C to +50°C.

Vehicular Battery Charger

The NTN8978 Vehicular Battery Charger enables in-vehicle communications by charging the NiMH battery and providing power to your *i700plus* phone.

The power light (green LED) will light when the Vehicular Battery Charger is receiving power.

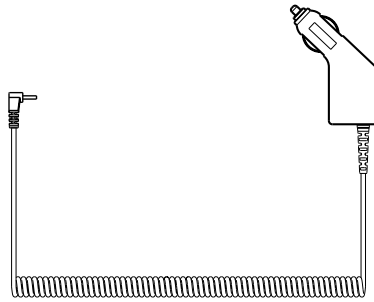

Figure 5. Using the Vehicular Battery Charger

Using the Vehicular Battery Charger

1. Insert the Vehicular Battery Charger's DC plug into the Side Charging Jack of your *i700plus* phone. Push firmly until the plug rests securely in the Side Charging Jack.
2. Remove the vehicle's cigarette lighter plug (if one exists) from the cigarette lighter receptacle.
3. Plug the Vehicular Battery Charger into the cigarette lighter receptacle. The power light (green LED) will turn on.

While your *i700plus* phone is attached to the Vehicular Battery Charger, you can leave the phone off, turn it on, or use it. For best charging results, leave it off.

Removing the Vehicular Battery Charger:

1. Unplug the Vehicular Battery Charger from the vehicle's cigarette lighter receptacle.
2. Gently pull the plug from the Side Charging Jack of your *i700plus* phone Vehicular Battery Charger.

Operating Specifications

Operating voltage range: 10.8 - 33.0 Vdc.

Operating temperature range: -30°C to +60°C.

Desktop Dual-Pocket Charger

The NTN1690 Desktop Dual-Pocket Charger charges Motorola authorized batteries, as listed on Page 55, for the *i700plus* phone.

NOTE: The Desktop Dual-Pocket Charger should only be powered by the included Rapid Power Supply. The Charger will flash both LEDs red if the Standard Travel Charger is attached.

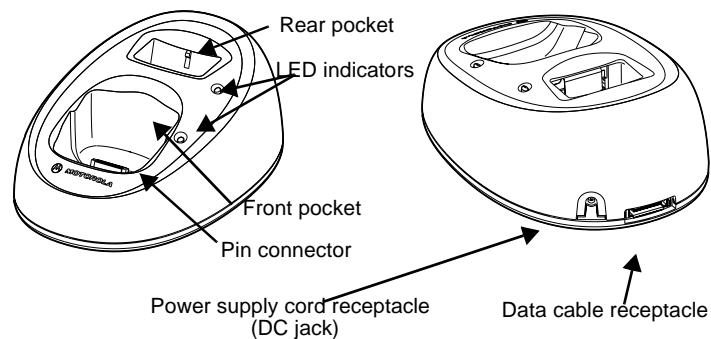

Figure 3. Desktop Dual-Pocket Charger

Charging a battery:

1. Insert the power supply's DC jack plug into the DC jack receptacle on the back of the Charger. *Use only with the Motorola rapid charger included with your Desktop Charger package.*
2. Plug the power supply end of the power-supply cord into any standard AC outlet. The Charger performs a quick power-up self-test during which both LED indicators flash green once to indicate a successful power-up.
3. Attach a battery to your *i700plus* phone. Place the *i700plus* phone onto the pin connector located in the charger's front pocket.

Data Operation

1. Insert the round end of the iDEN Data Cable (NKN6522) into the data cable receptacle located on the back of the charger, with the Motorola logo facing upwards.
2. Connect the opposite end of the data cable to the PC.

NOTE: Charging times may vary when performing data operations.

Adding and removing a battery from the rear pocket

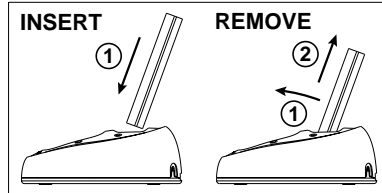

Figure 3. Adding and Removing a Battery from the Rear Pocket

1. Insert the battery with the Motorola label facing forward and the (+ and -) symbols pointing downward.
2. To remove the battery, pull it forward, then up and out of the Charger.

NOTE: If a battery is in the rear pocket... and the phone with a battery is inserted into the front pocket, the battery in the front pocket will charge to full capacity before the battery in the rear pocket is charged. The LED for the rear pocket flashes yellow, indicating that its battery is waiting to be charged.

NOTE: To remove the battery from the rear pocket, hold the base of the charger and pull the battery forward, then straight up.

Desktop Charger Status

The Charger displays the battery's charge status. The indicator will show one of the following:

solid red =1-30%; solid yellow =31-60%; flashing green =61-90%; solid green =91-100%.

Desktop Charger Troubleshooting

If the battery is not charging and you see:

A flashing yellow indicator -

- The flashing yellow LED is used to indicate that the Charger's pocket is in a wait state.
- If a battery is in the rear pocket, the rear pocket's LED continues to flash yellow until the battery in the front pocket is more than 90% charged (front pocket's LED is solid green). This is normal operation.
- To protect your battery's life expectancy, the Charger does not rapid charge a battery when its temperature is below 5°C (41°F) or above 45°C (113°F).

No LED indication -

- Check that the *i700plus* phone with battery, or a battery alone, is inserted correctly.
- Make sure that the power supply is plugged into an appropriate AC outlet and that the connector is properly seated.
- *Rear pocket only:* Remove the battery from the Charger. Use an ordinary pencil eraser to clean the three metal contacts on the battery and then place the battery in the Charger.
- If the LED indicator remains turned OFF, the battery may be defective and should be replaced.

Flashing red LED indicator -

- Remove the battery from the Charger. Use an ordinary pencil eraser to clean the three metal contacts on the battery and then place the battery in the Charger.
- If the LED indicator remains turned OFF, the battery may be defective and should be replaced.

Both LEDs flash red -

- This indicates that the incorrect power supply is plugged in.

Audio Adapter

NOTE: The use of wireless devices and their accessories (“devices”) may be prohibited or restricted in certain areas. Always obey the laws and regulations on the use of these devices.

The NTN8654 Audio Adapter connects an earpiece microphone or headset to your *i700plus* phone for privacy and hands-free operation.

The Audio Adapter fits onto the bottom of the *i700plus* phone and provides a standard 2.5mm jack connection for an earpiece microphone or headset.

The following audio accessories are compatible with the audio adapter:

- Earpiece with Microphone (NTN8367)
- Headset with Boom Microphone (NTN8513)
- Lightweight Headset with Microphone (NTN8496)
- Over-the-Ear Style Headset (NTN8497)

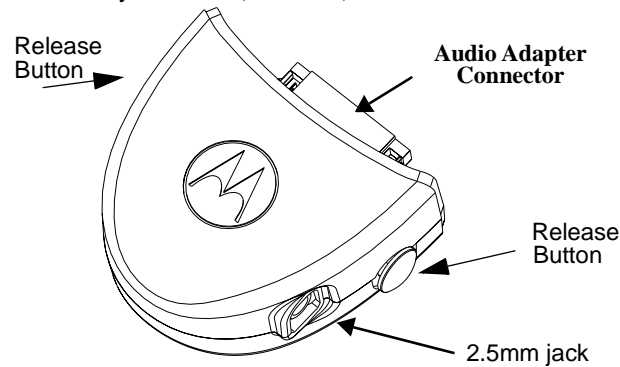

Figure 3. Using the Audio Adapter

Using the Audio Adapter

1. Hold the phone and the Audio Adapter facing you so that you see the Motorola logo on the adapter.
2. Insert the Audio Adapter's connector into the *i700plus* phone Bottom Accessory Connector. You will hear the connector snap into place.

NOTE: When the audio adapter and earpiece or headset are connected, all audio, including tones, will be routed to the audio accessory's earpiece.

Attaching/Detaching the Earpiece Microphone or Headset

1. Insert the 2.5mm plug of the earpiece microphone or headset cord into the jack of the Audio Adapter.
2. Pull on the plug, not on the cord, to remove the earpiece microphone.

Removing the Audio Adapter

1. Simultaneously press the release buttons located on either side of the Audio Adapter.
2. Pull the Audio Adapter from the *i700plus* phone.

Swivel Belt Clip

The NTN9152 Swivel Belt Clip provides a convenient means by which to carry your *i700plus* phone with you.

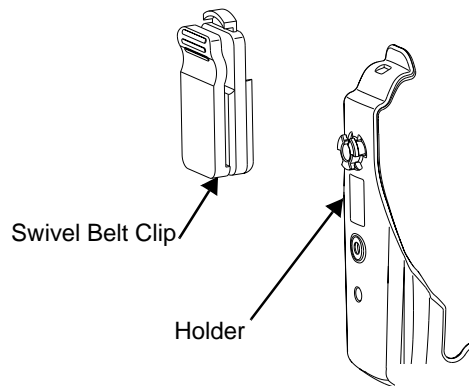

Figure 3. Using the Swivel Belt Clip

Using the Swivel Belt Clip

1. Attach the Swivel Belt Clip to your belt.
2. Insert your *i700plus* phone into the belt clip holder and attach the holder to the Swivel Belt Clip.
3. To remove your *i700plus* phone from the holder, push the holder tab inward while pulling the phone outward.
4. To remove your *i700plus* phone and the holder from the Swivel Belt Clip, push down on the button on top of the Swivel Belt Clip and lift the phone out. Or, rotate the phone and the holder 180°, then pull the phone straight up and out of the Swivel Belt Clip.

Leather Carry Case with Clear Plastic Cover

- The NTN9151 Leather Carry Case helps protect your *i700plus* phone while on the go.
- Includes a leather belt clip for easy attachment to a belt or purse.
- Accommodates most *i700plus* phone accessories including travel chargers, audio accessories, vehicle accessories, and data accessories.

Hands-Free Car Kit

 <p>Caution</p>	<p>The Hands-Free Car Kit is also a charger. Therefore, DO NOT operate this kit and the Vehicular Battery Charger at the same time.</p>
---	--

NOTE: The use of wireless devices and their accessories (“devices”) may be prohibited or restricted in certain areas. Always obey the laws and regulations on the use of these devices.

The NTN1719 Hands-Free Car Kit enables in-vehicle communications by providing a built-in speaker, a power supply for the phone’s internal battery charger, hands-free visor microphone, dash-mount holder, and power to the phone.

An external Push-To-Talk (PTT) switch is also included. When the phone is turned off, the Hands-Free Car Kit charges the Standard battery in 105 minutes to 90% capacity. Charging time will be longer if the phone is operational during charge time.

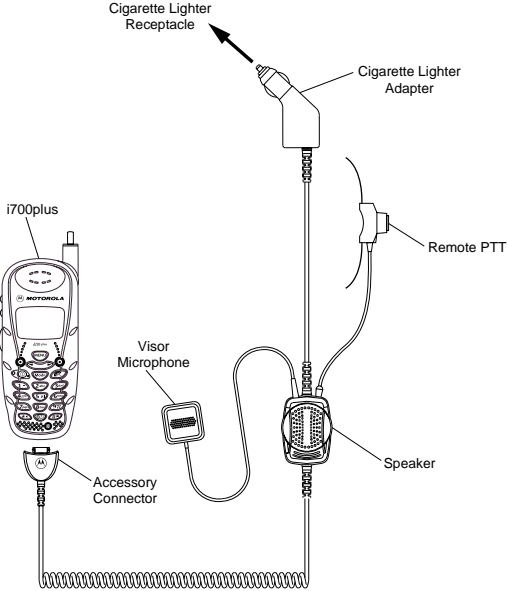

Figure 5. Using the Hands-Free Car Kit

Using the Hands-Free Car Kit

1. Hold the *i700plus* phone with its front toward you. Insert the accessory connector (with the Motorola logo facing you) into the phone's bottom accessory connector until it clicks into place.
2. Remove the vehicle's cigarette lighter from the cigarette lighter receptacle.
3. Plug the Hands-Free Car Kit's Vehicular Battery Charger into the cigarette lighter receptacle. The power light (green LED) will come on.
4. Selecting the correct position for the hands-free visor microphone is vital for the performance of the hands-free circuitry. It is recommended that the microphone be mounted either on the sun visor directly above (and facing) the driver, or on the headliner just above (and facing) the driver.

The visor microphone:

- Should NOT be located within 12 inches of the speaker box.
 - Should never be mounted near the vehicle's window, or in a spot where road and ambient noise are substantially high.
 - Should be mounted so that it does not come into contact with the air bag, or interfere with air bag deployment.
5. Turn on your *i700plus* phone.
 6. Adjust the speaker volume using the volume control buttons on your *i700plus* phone.

To remove the *i700plus* phone:

1. Push the Motorola logo button on the accessory connector and remove the connector from the phone.

NOTE: Your phone should only be used with a Hands-Free Car Kit that has a gray button on the accessory connector. The use of any other hands-free car kit will result in an "incompatible accessory" message on the phone's display.

Dash Mount Holder

The NTN9025 Dash Mount Holder provides a convenient holder for your *i700plus* phone. The Dash Mount Holder can be installed either horizontally or vertically.

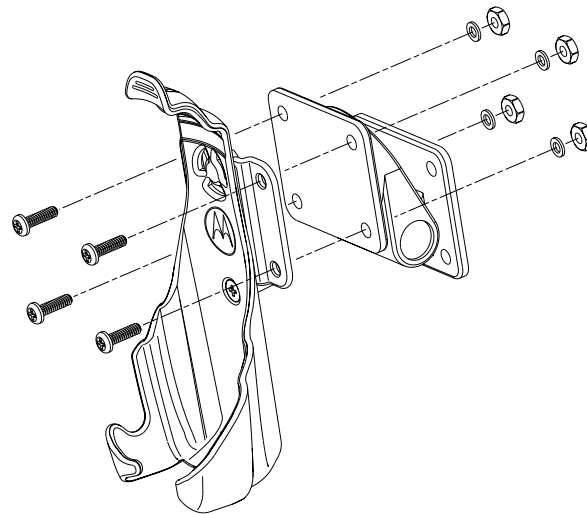
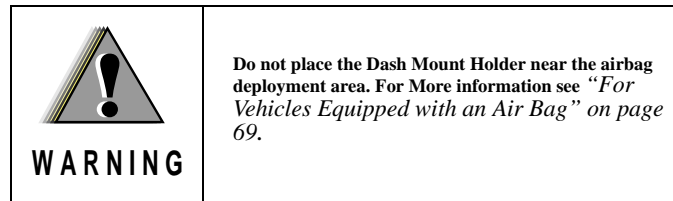

Figure 2. Installing the Dash Mount Holder

Using the Dash Mount Holder

1. Mount the Dash Mount Holder to the dash of your vehicle by securing the four self-tapping screws to the base of the Holder. Or, for a semi-permanent installation, use the included adhesive strip.
2. Snap your phone securely into the holder.

Safety and General Information

IMPORTANT INFORMATION ON SAFE AND EFFICIENT OPERATION.

READ THIS INFORMATION BEFORE USING YOUR INTEGRATED MULTI-SERVICE PORTABLE RADIO.

For the safe and efficient operation of your radio, observe these guidelines:

Your radio product contains a transmitter and a receiver. When it is *ON*, it receives and transmits radio frequency (RF) energy. The radio operates in the frequency range of 806 MHz to 870 MHz and employs digital modulation techniques. When you communicate with your radio product, the system handling your call controls the power level at which your radio product transmits. The output power level typically may vary over a range from 0.00024 watts to 0.6 watts.

Exposure To Radio Frequency Energy

Your Motorola Radio Product is designed to comply with the following national and international standards and guidelines regarding exposure of human beings to radio frequency electromagnetic energy:

- United States Federal Communications Commission, Code of Federal Regulations; 47 CFR part 2 sub-part J
- American National Standards Institute (ANSI) IEEE. C95. 1-1992
- National Council on Radiation Protection and Measurements (NCRP). Report 86
- International Commission on Non-Ionizing Radiation Protection (ICNIRP) 1998
- National Radiological Protection Board of the United Kingdom, GS 11, 1988
- Verband Deutscher Elektrotechniker (VDE) DIN-0848
- Department of Health and Welfare Canada. Safety Code 6

To assure optimal radio product performance and make sure human exposure to radio frequency electromagnetic energy is within the guidelines set forth in the above standards, always adhere to the following procedures:

When placing or receiving a phone call, or using the group and private call functions with a Group/Private Speaker OFF (muted speaker icon visible in the display), hold your radio product as you would a telephone. Speak directly into the microphone and position the antenna up and over your shoulder.

Safety and General Information

When using your radio product as a traditional two-way radio while making group or private calls with the Group/Private Speaker ON (no speaker icon visible in the display), hold the radio product in a vertical position with the microphone one to two inches (2.5 to 5 cm) away from the lips.



For body-worn operation, with or without an earpiece or any other accessory, the antenna should be kept at least one inch (2.5 cm) from the body when transmitting. A Motorola plastic carry holder with a belt clip is an accessory to this radio product for body-worn use.

When using any data feature of the radio product, with or without an accessory cable, position the antenna of the radio product at least one inch (2.5 cm) from the body.

DO NOT hold the antenna when the radio is "IN USE". Holding the antenna affects call quality and may cause the radio product to operate at a higher power level than needed.

Interference to Medical and Personal Electronic Devices

Most electronic equipment is shielded from RF energy. However, certain equipment may not be shielded against the RF signals from your radio product.

Pacemakers

The Health Industry Manufacturers Association recommends that a minimum separation of 6 inches (15 cm) be maintained between a handheld wireless phone and a pacemaker to avoid potential interference with the pacemaker. These recommendations are consistent with the independent research by and recommendations of Wireless Technology Research.

Persons with pacemakers should:

- ALWAYS keep the radio product more than six inches from the pacemaker when the radio product is turned ON.
- Not carry the radio product in a breast pocket.
- Use the ear opposite the pacemaker to minimize the potential for interference.
- Turn the radio product OFF immediately if you have any reason to suspect that interference is taking place.

Hearing Aids

Some radio products may interfere with some hearing aids. In the event of such interference, you may want to consult your hearing aid manufacturer to discuss alternatives.

Other Medical Devices

If you use any other personal medical device, consult the manufacturer of your device to determine if it is adequately shielded from external RF energy. Your physician may be able to assist you in obtaining this information.

Turn your radio product OFF in health care facilities when any regulations posted in these areas instruct you to do so. Hospitals or health care facilities may be using equipment that could be sensitive to external RF energy.

Interference to Other Electronic Devices

- RF energy may affect improperly installed or inadequately shielded electronic operating and entertainment systems in motor vehicles. Check with the manufacturer or representative to determine if these systems are adequately shielded from external RF energy. Also check with the manufacturer of any equipment that has been added to the vehicle.
- Turn your radio product OFF before boarding any aircraft to prevent possible interference to aircraft systems. Regulations of the United States Federal Communications Commission prohibit use when the plane is airborne. The United States Department of Transportation regulations require you have permission from a crew member to use your radio product while the plane is on the ground.

Safety and General

Use While Driving

Check the laws and regulations on the use of wireless telephones in the area where you drive. Always obey them.

When using the radio product while driving, please:

- Give full attention to driving and to the road
- Use hands-free operation, if available
- Pull off the road and park before making or answering a call if driving conditions so require.



Operational Warnings

WARNING

Potentially Explosive Atmospheres

Turn off your radio product when you are in any area with a potentially explosive atmosphere, unless it is a radio product type especially qualified for use in such areas (for example, Factory Mutual Approved). Sparks in a potentially explosive atmosphere can cause an explosion or fire resulting in bodily injury, or even death.

NOTE: The areas with potentially explosive atmospheres referred to above include fueling areas such as: below decks on boats; fuel or chemical transfer or storage facilities; areas where the air contains chemicals or particles such as grain, dust or metal powders; and any other area where you would normally be advised to turn off your vehicle engine. Areas with potentially explosive atmospheres are often, but not always posted.

Batteries

Do not replace or charge batteries in a potentially explosive atmosphere. Contact sparking may occur while installing or removing batteries and cause an explosion.

Blasting Caps and Areas

To avoid possible interference with blasting operations, turn off your radio product when you are near electrical blasting caps, in a blasting area, or in areas posted: "Turn off two-way radio". Obey all signs and instructions.

For Vehicles Equipped with an Air Bag

Do NOT place objects, including both installed and portable wireless equipment, in the area over the air bag or in the air bag deployment area. An air bag inflates with great force. If in-vehicle wireless equipment is improperly installed and the air bag inflates, serious injury could result.



Operational Cautions

Caution

Damaged Antennas

Do not use any portable radio product that has a damaged antenna. If a damaged antenna comes into contact with your skin, a minor burn can result.

Batteries

All batteries can cause property damage and/or bodily injury such as burns if a conductive material such as jewelry, keys, or beaded chains touch exposed terminals. The conductive material may complete an electrical circuit (short circuit) and become quite hot. Exercise care in handling any charged battery, particularly when placing it inside a pocket, purse, or other container with metal objects.

Cleaning and Drying Considerations

Using a leather carry case may help protect the surfaces and help prevent liquids (e.g., rain) from entering into the interior of the radio product. This product is not water proof, and exposing the unit to liquids may result in permanent damage to the unit.

If your radio product interior gets wet, then do not try to accelerate drying with the use of an oven or a dryer as this will damage the radio product and void the warranty. Instead, do the following:

1. Immediately power off the radio product.
2. Remove Battery from radio product.
3. Shake excess liquid from phone.
4. Place phone and battery in an area that is at room temperature and has good air flow.
5. Let phone and battery dry for 72 hours before reconnecting the battery and/or powering on the phone.

If the phone does not work after following the steps listed above, contact your dealer for servicing information.

Safety and General Information

Clean the external surfaces of the radio product with a damp cloth, using a mild solution of dishwashing detergent and water. Some household cleaners may contain chemicals that could seriously damage the radio product. Avoid the use of any petroleum-based solvent cleaners. Also, avoid applying liquids directly on the radio product.

Antenna Considerations

Use only the supplied or an approved antenna. Unauthorized antennas, modifications, or attachments could impair call quality, damage the radio product, or result in violation of local agency regulations.

Accessory Safety Information

IMPORTANT: SAVE THESE ACCESSORY SAFETY INSTRUCTIONS

- Before using any battery or battery charger, read all the instructions for and cautionary markings on (1) the battery, (2) the battery charger, which may include a separate wall-mounted power supply or transformer, and (3) the radio product using the battery.
- Do not expose any battery charger to water, rain, or snow as they are designed for indoor or in-vehicle use only.

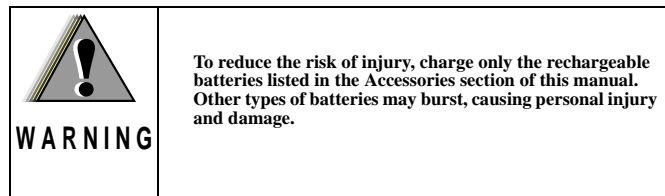

- To reduce the risk of damage to the cord or plug, pull by the plug rather than the cord when you disconnect the battery charger from the power source outlet.
- Do not operate any battery charger with a damaged cord or plug - replace them immediately.
- Battery chargers may become warm during operation, but not hot. If it becomes hot to the touch, unplug it from the power outlet immediately and discontinue its use.
- Use of a non-recommended attachment to a battery charger may result in a risk of fire, electric shock, or injury to persons.
- Make sure the battery charger power cord is located so that it will not be stepped on, tripped over, or subjected to damage or stress.
- An extension cord should not be used with any battery charger unless absolutely necessary. Use of an improper extension cord could result in a risk of fire and electric shock. If an extension cord must be used, make sure that:
 - The pins on the plug of the extension cord are the same number, size, and shape as those on the plug of the charger.
 - The extension cord is properly wired and in good electrical condition.
 - The cord size is 18AWG for lengths up to 100 feet and 16AWG for lengths up to 150 feet.
- Do not operate any battery charger if it has received a sharp blow, has been dropped, or has been damaged in any way; take it to a qualified service technician.
- Do not disassemble a battery charger; take it to a qualified service technician when service or repair is required. Incorrect reassembly may result in a risk of electric shock or fire.

Accessory Safety Information

- Maximum ambient temperature around the power supply or transformer of any battery charger should not exceed 40°C (104°F).
- The output power from the power supply or transformer must not exceed the rating given on the Desktop Dual-Pocket Charger.
- The disconnection from the line voltage is made by unplugging the power supply from the AC receptacle.
- To reduce risk of electric shock, unplug any battery charger from the outlet before attempting any maintenance or cleaning.
- For optimum charging performance, turn off the radio product while charging it in any battery charger.

Warranty

Limited Warranty Motorola Communication Products

NOTE: This Warranty applies within the fifty (50) united states and the District of Columbia.

I. What This Limited Warranty Covers and For How Long:

MOTOROLA, INC. ("MOTOROLA") warrants the MOTOROLA manufactured iDEN Communication Products listed below ("Product") against defects in material and workmanship under normal use and service for a period of time from the date of purchase as scheduled below:

iDEN Subscriber Digital Mobile and Portable Units	One (1) Year
Product Accessories	One (1) Year
Batteries	One (1) Year

Rechargeable Batteries will be replaced during the applicable warranty period if:

- a. the battery capacity falls below 80% of rated capacity, or
- b. the battery develops leakage.

MOTOROLA, at its options, will at no charge either repair the Product (with new or reconditioned parts), replace it (with a new or reconditioned Product), or refund the purchase price of the Product during the warranty period provided it is returned in accordance with the terms of this warranty. Replaced parts or boards are warranted for the balance of the original applicable warranty period. All replaced parts of Product shall become the property of MOTOROLA.

This express limited warranty is extended by MOTOROLA to the original end user purchaser only and is not assignable or transferable to any other party. This is the complete warranty for the Product manufactured by MOTOROLA. MOTOROLA assumes no obligations or liability for additions or modifications to this warranty unless made in writing and signed by an officer of MOTOROLA. Unless made in a separate agreement between MOTOROLA and the original end user purchaser, MOTOROLA does not warrant the installation, maintenance or service of the Product.

MOTOROLA cannot be responsible in any way for any ancillary equipment not furnished by MOTOROLA which is attached to or used in connection with the Product, or for operation of the Product with any ancillary equipment, and all

such equipment if expressly excluded from this warranty. Because each system which may use the Product is unique, MOTOROLA disclaims liability for range, coverage, or operation of the system as a whole under this warranty.

II. General Provisions:

This warranty sets forth the full extent of MOTOROLA'S responsibilities regarding the Product. Repair, replacement or refund of the purchase price, at MOTOROLA'S options, is the exclusive remedy. THIS WARRANTY IS GIVEN IN LIEU OF ALL OTHER EXPRESS WARRANTIES. IMPLIED WARRANTIES, INCLUDING WITHOUT LIMITATION, IMPLIED WARRANTIES OF MERCHANTABILITY AND FITNESS FOR A PARTICULAR PURPOSE, ARE LIMITED TO THE DURATION OF THIS LIMITED WARRANTY. IN NO EVENT SHALL MOTOROLA BE LIABLE FOR DAMAGES IN EXCESS OF THE PURCHASE PRICE OF THE PRODUCT, FOR ANY LOSS OF USE, LOSS OF TIME, INCONVENIENCE, COMMERCIAL LOSS, LOST PROFITS OR SAVINGS OR OTHER INCIDENTAL, SPECIAL OR CONSEQUENTIAL DAMAGES ARISING OUT OF THE USE OR INABILITY TO USE SUCH PRODUCT, TO THE FULL EXTENT SUCH MAY BE DISCLAIMED BY LAW.

III. State Law Rights:

SOME STATES DO NOT ALLOW THE EXCLUSION OR LIMITATION OF INCIDENTAL OR CONSEQUENTIAL DAMAGES, OR LIMITATION ON HOW LONG AN IMPLIED WARRANTY LASTS, SO THE ABOVE LIMITATIONS OR EXCLUSIONS MAY NOT APPLY.

This warranty gives specific legal rights, and there may be other rights which may vary from state to state.

IV. How to Get Warranty Service:

You must provide proof of purchase (bearing the date of purchase and Product item serial number) in order to receive warranty service and, also, deliver or send the Product item, transportation and insurance prepaid, to an authorized warranty service location. Warranty service will be provided by MOTOROLA through one of its authorized warranty service locations. If you first contact the company which sold you the Product (e.g., dealer or communication service provider), it can facilitate your obtaining warranty service. You can also call MOTOROLA at 1-800-453-0920 for warranty service location information.

V. What This Warranty Does Not Cover:

- a. Defects or damage resulting from use of the Product in other than its normal and customary manner.
- b. Defects or damage from misuse, accident, water, or neglect.

- c. Defects or damage from improper testing, operation, maintenance, installation, alteration, modification, or adjustment.
- d. Breakage or damage to antennas unless caused directly by defects in material workmanship.
- e. A Product subjected to unauthorized Product modifications, disassemblies or repairs (including, without limitation, the addition to the Product of non-MOTOROLA supplied equipment) which adversely affect performance of the Product or interfere with MOTOROLA'S normal warranty inspection and testing of the Product to verify any warranty claim.
- f. Product which has had the serial number removed or made illegible.
- g. Rechargeable batteries if:
 - (1). Any of the seals on the battery enclosure of cells are broken or show evidence of tampering.
 - (2). The damage or defect is caused by charging or using the battery in equipment or service other than the Product for which it is specified.
- h. Freight costs to the repair depot.
- i. A Product which, due to illegal or unauthorized alteration of the software/firmware in the Product, does not function in accordance with MOTOROLA'S published specifications or the FCC type acceptance labeling in effect for the Product at the time the Product was initially distributed from MOTOROLA.
- j. Scratches or other cosmetic damage to Product surfaces that does not affect the operation of the Product.
- k. Normal and customary wear and tear.

VI. Patent and Software Provisions:

MOTOROLA will defend, at its own expense, any suit brought against the end user purchaser to the extent that it is based on a claim that the Product or parts infringe a United States patent, and MOTOROLA will pay those costs and damages finally awarded against the end user purchaser in any such suit which are attributable to any such claim, but such defense and payments are conditioned on the following:

- a. that MOTOROLA will be notified promptly in writing by such purchaser of any notice of such claim;
- b. that MOTOROLA will have sole control of the defense of such suit and all negotiations for its settlement or compromise; and
- c. Should the Product or parts become, or in MOTOROLA'S opinion be likely to become, the subject of a claim of infringement of a United States patent, that such purchaser will permit MOTOROLA, at its

Warranty

option and expense, either to procure for such purchaser the right to continue to using the Product or parts or to replace or modify the same so that it becomes non-infringing or to grant such purchaser a credit for the Product or parts as depreciated and accept its return. The depreciation will be an equal amount per year over the lifetime of the Product or parts as established by MOTOROLA.

MOTOROLA will have no liability with respect to any claim of patent infringement which is based upon the combination of the Product or parts furnished hereunder with software, apparatus or devices not furnished by MOTOROLA, nor will MOTOROLA have any liability for the use of ancillary equipment or software not furnished by MOTOROLA which is attached to or used in connection with the Product or any parts thereof.

Laws in the United States and other countries preserve for MOTOROLA certain exclusive rights for copyrighted MOTOROLA software, such as the exclusive rights to reproduce in copies and distribute copies of such MOTOROLA software. MOTOROLA software may be used in only the Product in which the software was originally embodied and such software in such Product may not be replaced, copied, distributed, modified in any way, or used to product any derivative thereof. No other use including, without limitation, alteration, modification, reproduction, distribution, or reverse engineering of such MOTOROLA software or exercise or rights in such MOTOROLA software is permitted. No license is granted by implication, estoppel or otherwise under MOTOROLA patent rights or copyrights.

**Limited Warranty Motorola Communication Products
(International)**

NOTE: This Warranty applies within Singapore and the Philippines.

I. What This Limited Warranty Covers and For How Long:

MOTOROLA, INC. (“MOTOROLA”) warrants the MOTOROLA manufactured iDEN Communication Products listed below (“Product”) against defects in material and workmanship under normal use and service for a period of time from the date of purchase as scheduled below:

iDEN Subscriber Digital Mobile and Portable Units	One (1) Year
Product Accessories	One (1) Year
Batteries	One (1) Year

Rechargeable Batteries will be replaced during the applicable warranty period if:

- a. the battery capacity falls below 80% of rated capacity, or
- b. the battery develops leakage.

MOTOROLA, at its options, will at no charge either repair the Product (with new or reconditioned parts), replace it (with a new or reconditioned Product), or refund the purchase price of the Product during the warranty period provided it is returned in accordance with the terms of this warranty. Replaced parts or boards are warranted for the balance of the original applicable warranty period. All replaced parts of Product shall become the property of MOTOROLA.

This express limited warranty is extended by MOTOROLA to the original end user purchaser only and is not assignable or transferable to any other party. This is the complete warranty for the Product manufactured by MOTOROLA.

MOTOROLA assumes no obligations or liability for additions or modifications to this warranty unless made in writing and signed by an officer of MOTOROLA. Unless made in a separate agreement between MOTOROLA and the original end user purchaser, MOTOROLA does not warrant the installation, maintenance or service of the Product.

MOTOROLA cannot be responsible in any way for any ancillary equipment not furnished by MOTOROLA which is attached to or used in connection with the Product, or for operation of the Product with any ancillary equipment, and all such equipment if expressly excluded from this warranty. Because each system which may use the Product is unique, MOTOROLA disclaims liability for range, coverage, or operation of the system as a whole under this warranty.

II. General Provisions:

This warranty sets forth the full extent of MOTOROLA'S responsibilities regarding the Product, Repair, replacement or refund of the purchase price, at MOTOROLA'S options, is the exclusive remedy. THIS WARRANTY IS GIVEN IN LIEU OF ALL OTHER EXPRESS WARRANTIES. IMPLIED WARRANTIES, INCLUDING WITHOUT LIMITATION, IMPLIED WARRANTIES OF MERCHANTABILITY AND FITNESS FOR A PARTICULAR PURPOSE, ARE LIMITED TO THE DURATION OF THIS LIMITED WARRANTY. IN NO EVENT SHALL MOTOROLA BE LIABLE FOR DAMAGES IN EXCESS OF THE PURCHASE PRICE OF THE PRODUCT, FOR ANY LOSS OF USE, LOSS OF TIME, INCONVENIENCE, COMMERCIAL LOSS, LOST PROFITS OR SAVINGS OR OTHER INCIDENTAL, SPECIAL OR CONSEQUENTIAL DAMAGES ARISING OUT OF THE USE OR INABILITY TO USE SUCH PRODUCT, TO THE FULL EXTENT SUCH MAY BE DISCLAIMED BY LAW.

III. State Law Rights:

SOME STATES DO NOT ALLOW THE EXCLUSION OR LIMITATION OF INCIDENTAL OR CONSEQUENTIAL DAMAGES, OR LIMITATION ON HOW LONG AN IMPLIED WARRANTY LASTS, SO THE ABOVE LIMITATIONS OR EXCLUSIONS MAY NOT APPLY.

This warranty gives specific legal rights, and there may be other rights which may vary from state to state.

IV. How to Get Warranty Service:

You must provide proof of purchase (bearing the date of purchase and Product item serial number) in order to receive warranty service and, also, deliver or send the Product item, transportation and insurance prepaid, to an authorized warranty service location. Warranty service will be provided by MOTOROLA through one of its authorized warranty service locations. If you first contact the company which sold you the Product (e.g., dealer or communication service provider), it can facilitate your obtaining warranty service. You can also call MOTOROLA at 1-800-453-0920 for warranty service location information.

V. What This Warranty Does Not Cover:

- a. Defects or damage resulting from use of the Product in other than its normal and customary manner.
- b. Defects or damage from misuse, accident, water, or neglect.
- c. Defects or damage from improper testing, operation, maintenance, installation, alteration, modification, or adjustment.

- d. Breakage or damage to antennas unless caused directly by defects in material workmanship.
- e. A Product subjected to unauthorized Product modifications, disassemblies or repairs (including, without limitation, the addition to the Product of non-MOTOROLA supplied equipment) which adversely affect performance of the Product or interfere with MOTOROLA'S normal warranty inspection and testing of the Product to verify any warranty claim.
- f. Product which has had the serial number removed or made illegible.
- g. Rechargeable batteries if:
 - (1). Any of the seals on the battery enclosure of cells are broken or show evidence of tampering.
 - (2). The damage or defect is caused by charging or using the battery in equipment or service other than the Product for which it is specified.
- h. Freight costs to the repair depot.
- i. A Product which, due to illegal or unauthorized alteration of the software/firmware in the Product, does not function in accordance with MOTOROLA'S published specifications or the FCC type acceptance labeling in effect for the Product at the time the Product was initially distributed from MOTOROLA.
- j. Scratches or other cosmetic damage to Product surfaces that does not affect the operation of the Product.
- k. Normal and customary wear and tear.

VI. Patent and Software Provisions:

MOTOROLA will defend, at its own expense, any suit brought against the end user purchaser to the extent that it is based on a claim that the Product or parts infringe a United States patent, and MOTOROLA will pay those costs and damages finally awarded against the end user purchaser in any such suit which are attributable to any such claim, but such defense and payments are conditioned on the following:

- a. that MOTOROLA will be notified promptly in writing by such purchaser of any notice of such claim;
- b. that MOTOROLA will have sole control of the defense of such suit and all negotiations for its settlement or compromise; and
- c. Should the Product or parts become, or in MOTOROLA'S opinion be likely to become, the subject of a claim of infringement of a United States patent, that such purchaser will permit MOTOROLA, at its option and expense, either to procure for such purchaser the right to continue to using the Product or parts or to replace or modify the same

Warranty

so that it becomes non-infringing or to grant such purchaser a credit for the Product or parts as depreciated and accept its return. The depreciation will be an equal amount per year over the lifetime of the Product or parts as established by MOTOROLA.

MOTOROLA will have no liability with respect to any claim of patent infringement which is based upon the combination of the Product or parts furnished hereunder with software, apparatus or devices not furnished by MOTOROLA, nor will MOTOROLA have any liability for the use of ancillary equipment or software not furnished by MOTOROLA which is attached to or used in connection with the Product or any parts thereof.

Laws in the United States and other countries preserve for MOTOROLA certain exclusive rights for copyrighted MOTOROLA software, such as the exclusive rights to reproduce in copies and distribute copies of such MOTOROLA software. MOTOROLA software may be used in only the Product in which the software was originally embodied and such software in such Product may not be replaced, copied, distributed, modified in any way, or used to product any derivative thereof. No other use including, without limitation, alteration, modification, reproduction, distribution, or reverse engineering of such MOTOROLA software or exercise or rights in such MOTOROLA software is permitted. No license is granted by implication, estoppel or otherwise under MOTOROLA patent rights or copyrights.

Owner's Information

Mobile Equipment Identifier (IMEI)

Own Phone Number

Own Private Number

Date Purchased

Dealer Telephone Number

Customer Service Number

Owner's Information

Private Number Directory

Private Number	Name
1	
2	
3	
4	
5	
6	
7	
8	
9	

Talkgroup Directory

Talkgroup Number	Name
1	
2	
3	
4	
5	
6	
7	
8	
9	

i700 plus

Free Manuals Download Website

<http://myh66.com>

<http://usermanuals.us>

<http://www.somanuals.com>

<http://www.4manuals.cc>

<http://www.manual-lib.com>

<http://www.404manual.com>

<http://www.luxmanual.com>

<http://aubethermostatmanual.com>

Golf course search by state

<http://golfingnear.com>

Email search by domain

<http://emailbydomain.com>

Auto manuals search

<http://auto.somanuals.com>

TV manuals search

<http://tv.somanuals.com>