

**ML900**  
**Operation Manual**

**Part Number:** 7990 0114 3001 R03  
(April 2004)



**TRADEMARKS**

All brand and product names are trademarks or registered trademarks of their respective companies.

**NOTE**

Information in this manual is subject to change without notice.



# Regulations Information

## Class B Regulations

### USA

#### **Federal Communications Commission Radio Frequency Interference Statement**

##### **NOTE:**

This equipment has been tested and found to comply with the limits for a Class B digital device pursuant to Part 15 of the FCC Rules. These limits are designed to provide reasonable protection against harmful interference in a residential installation. This equipment generates, uses, and can radiate radio frequency energy and, if not installed and used in accordance with the instructions, may cause harmful interference to radio communications. However, there is no guarantee that interference will not occur in a particular installation. If this equipment does cause harmful interference to radio or television reception, which can be determined by turning the equipment off and on, the user is encouraged to try to correct the interference by one or more of the following measures:

- Reorient or relocate the receiving antenna.
- Increase the separation between the equipment and receiver.
- Connect the equipment into an outlet on a circuit different from that to which the receiver is connected.
- Consult the dealer or an experienced radio/TV technician for help.

Any changes or modifications not expressly approved by the manufacturer could void the user's authority to operate the equipment.

##### **Please note:**

The use of a non-shielded interface cable with this equipment is prohibited.

#### **Wireless LAN Module Statement**

##### **FCC CAUTION:**

This device complies with Part 15 of the FCC Rules. Operation is subject to the following two conditions: (1) this device may not cause harmful interference, and (2) this device must accept any interference received, including interference that may cause undesired operation.

### **FCC RF Radiation Exposure Statement**

This equipment complies with FCC RF radiation exposure limits set forth for an uncontrolled environment. This equipment should be installed and operated with a minimum distance of 20 cm between the radiator and your body.

To assure continued compliance (example – use only shielded interface cables when connecting to computer or peripheral devices), any changes or modifications not expressly approved by the party responsible for compliance could void the user's authority to operate this equipment.

## Canada

### **Canadian Department of Communications Radio Interference Regulations Class B Compliance Notice**

This digital apparatus does not exceed the Class B limits for radio noise emissions from digital apparatus set out in the Radio Interference Regulations of the Canadian Department of Communications.

Le présent appareil numérique n'émet pas de bruits radioélectriques dépassant les limites applicables aux appareils numériques de la classe B prescrites dans le Règlement sur le brouillage radioélectrique édicté par le ministère des Communications du Canada.

### **SAFE USAGE NOTIFICATION:**

For reason of personal safety and optimal radio performance, Motorola has designed the ML900 with an intended purpose and position of use either in a secured vehicle docking station or on the top of an office desk.

Motorola strongly recommends using this product in a vehicle only when it is physically-secured in a lock or assured-stationary location as failure to do so may cause the product to cause harm in accidents or other conditions. Similarly, Motorola strongly recommends that the unit not be situated for a prolonged period in a position that places the antennas directly against the human body (for example, by "tucking" an operational, radio-equipped unit under one's arm). NOTE: The radio modems in the ML900 may continue to transmit and receive signals even while the laptop is in a closed position. Failure to follow any part of this notification could cause degraded radio performance or harm to the user".

## **COMPUTER SOFTWARE COPYRIGHTS**

The Motorola products described in this instruction manual may include copyrighted Motorola computer programs stored in semiconductor memories or other media. Laws in the United States and other countries preserve for Motorola certain exclusive rights for copyrighted computer programs, including the exclusive right to copy or reproduce in any form the copyrighted computer program. Accordingly, any copyrighted

Motorola computer programs contained in the Motorola products described in this instruction manual may not be copied or reproduced in any manner without the express written permission of Motorola. Furthermore, the purchase of Motorola products shall not be deemed to grant either directly or by implication, estoppels or otherwise, any license under the copyrights, patents or patent applications of Motorola, except

for the normal non-exclusive, royalty free license to use that arises by operation of law in the sale of a product.

This Warranty applies within the fifty(50) United States' the District of Columbia and Canada.

## **LIMITED WARRANTY**

### **MOTOROLA COMMUNICATION PRODUCTS**

If the affected product is being purchased pursuant to a written

Communications System Agreement signed by Motorola, the warranty contained in that written agreement will apply. Otherwise, the following warranty applies.

### **I. WHAT THIS WARRANTY COVERS AND FOR HOW LONG:**

Motorola Inc. or if applicable, Motorola Canada Limited ("Motorola",) warrants the Motorola manufactured radio communications product, including original equipment crystal devices and channel elements ("Product"), against material defects in material and workmanship under normal use and service for a period of Three (3) Years from the date of shipment.

Motorola, at its option, will at no charge either repair the Product (with new or reconditioned parts), replace it with the same or equivalent Product (using new or reconditioned Product), or refund the purchase price of the product during the warranty period provided purchaser notifies Motorola according to the terms of this warranty. Repaired or replaced Product is warranted for the balance of the original applicable warranty period. All replaced parts of the Product shall become the property of Motorola.

This express limited warranty is extended by Motorola to the original end user purchaser purchasing the Product for purposes of leasing or for commercial, industrial, or governmental use only, and is not assignable or transferable to any other party. This is the complete warranty for the Product manufactured by Motorola. Motorola assumes no obligations or liability for additions or modifications to this warranty unless made in writing and signed by an officer of Motorola. Unless made in a separate written agreement between Motorola and the original end user purchaser, Motorola does not warrant the installation maintenance or service of the Product.

Motorola cannot be responsible in any way for any ancillary equipment not furnished by Motorola which is attached to or used in connection with the product, or for operation of the Product with any ancillary equipment, and all such equipment is expressly excluded from this warranty. Because each system which may use the Product is unique, Motorola disclaims liability for range, coverage, or operation of the system as a whole under this warranty.

## **II. GENERAL PROVISIONS:**

This warranty sets forth the full extent Motorola's responsibilities regarding the product. Repair replacement or Refund of the purchase price, at Motorola's option, is the exclusive is the exclusive remedy. THIS WARRANTY IS GIVEN IN LIEU OF ALL OTHER EXPRESS WARRANTIES.

Motorola, at its option, will at no charge either repair the Product (with new or reconditioned parts), replace it with the same or equivalent Product (using new or reconditioned Product), or refund the purchase price of the product during the warranty period provided purchaser notifies Motorola according to the terms of this warranty. Repaired or replaced Product is warranted for the balance of the original applicable warranty period. All replaced parts of the Product shall become the property of Motorola.

This express limited warranty is extended by Motorola to the original end user purchaser purchasing the Product for purposes of leasing or for commercial, industrial, or governmental use only, and is not assignable or transferable to any other party. This is the complete warranty for the Product manufactured by Motorola. Motorola assumes no obligations or liability for additions or modifications to this warranty unless made in writing and signed by an officer of Motorola. Unless made in a separate written agreement between Motorola and the original end user purchaser, Motorola does not warrant the installation maintenance or service of the Product.

Motorola cannot be responsible in any way for any ancillary equipment not furnished by Motorola which is attached to or used in connection with the product, or for operation of the Product with any ancillary equipment, and all such equipment is expressly excluded from this warranty. Because each system which may use the Product is unique, Motorola disclaims liability for range, coverage, or operation of the system as a whole under this warranty.

## **II. GENERAL PROVISIONS:**

This warranty sets forth the full extent Motorola's responsibilities regarding the product. Repair replacement or Refund of the purchase price, at Motorola's option, is the exclusive is the exclusive remedy. THIS WARRANTY IS GIVEN IN LIEU OF ALL OTHER EXPRESS WARRANTIES.

MOTOROLA DISCLAIMS ALL OTHER WARRANTIES OR CONDITIONS, EXPRESS OR IMPLIED INCLUDING THE IMPLIED WARRANTIES OR CONDITIONS OF MERCHANTABILITY AND FITNESS FOR A PARTICULAR PURPOSE. IN NO EVENT SHALL MOTOROLA BE LIABLE FOR DAMAGES IN EXCESS OF THE PURCHASE PRICE OF THE PRODUCT FOR ANY LOSS OF USE, LOSS OF TIME, INCONVENIENCE, COMMERCIAL LOSS, LOST PROFITS OR SAVINGS OR OTHER INCIDENTAL, SPECIAL INDIRECT OR CONSEQUENTIAL DAMAGES ARISING OUT OF THE USE OR INABILITY TO USE SUCH PRODUCT TO THE FULL EXTENT SUCH MAY BE DISCLAIMED BY LAW.

**III. How TO GET WARRANTY SERVICE:**

Purchaser must notify Motorola's representative or call Motorola's Customer Response Center at 1.800.247.2346 within the applicable warranty period for information regarding warranty service.

**IV. WHAT THIS WARRANTY DOES NOT COVER:**

- A) Defects or damage resulting from use of the Product in other than its normal and customary manner.
- B) Defects or damage from misuse, accident, water, or neglect.
- C) Defects or damage from improper testing, operation, maintenance, installation, alteration, modification, or adjustment.
- D) Breakage or damage to antennas unless caused directly by defects in material workmanship.
- E) A Product subjected to unauthorized Product modifications, disassemblies or repairs (including, without limitation, the addition to the Product of non-Motorola supplied equipment) which adversely affect performance of the Product or interfere with Motorola's normal warranty inspection and testing of the Product to verify any warranty claim.
- F) Product which has had the serial number removed or made illegible.
- G) Accessories, including batteries carry their own separate limited One (1) year warranty.
- H) Freight costs to the repair depot.



- I) A Product which, due to illegal or unauthorized alteration of the software/firmware in the Product, does not function in accordance with Motorola's published specifications or with the FCC type acceptance labeling in effect for the Product at the time the Product was initially distributed from Motorola.
- J) Scratches or other cosmetic damage to Product surfaces that do not affect the operation of the Product.
- K) That the software in the product will meet the purchaser's requirements or that the operation of the software will be uninterrupted or error-free.
- L) Normal and customary wear and tear.
- M) Non-Motorola manufactured equipment unless bearing a Motorola Part Number in the form of an alphanumeric number (i.e.,TDE6030B).

#### **V. GOVERNING LAW**

In the case of a Product sold in the United States and Canada, this Warranty is governed by the laws of the State of Illinois and the Province of Ontario respectively.

#### **VI. PATENT AND SOFTWARE PROVISIONS:**

Motorola will defend, at its own expense, any suit brought against the end user purchaser to the extent that it is based on a claim that the Product or its parts infringe a United States patent, and Motorola will pay those costs and damages finally awarded against the end user purchaser in any such suit which are attributable to any such claim, but such defense and payments are conditioned on the following:

- A) That Motorola will be notified promptly in writing by such purchaser of any notice of such claim;
- B) That Motorola will have sole control of the defense of such suit and all negotiations for its settlement or compromise; and

C) Should the Product or its parts become, or in Motorola's opinion be likely to become, the subject of a claim of infringement of a United States patent, that such purchaser will permit Motorola, at its option and expense, either to procure for such purchaser the right to continue using the product or its parts or to replace or modify the same so that it becomes non-infringing or to grant such purchaser a credit for the Product or its parts as depredated and accept its return. The depreciation will be an equal amount per year over the lifetime of the product or its parts as established by Motorola.

Motorola will have no liability with respect to any claim of patent infringement which is based upon the combination of the Product or its parts furnished hereunder with software, apparatus or devices not furnished by Motorola, nor will Motorola have any liability for the use of ancillary equipment or software not furnished by Motorola which is attached to or used in connection with the Product. The foregoing states the entire liability of Motorola with respect to infringement of patents by the Product or any of its parts thereof.

## About the Battery

### Caution Texts Concerning Lithium Batteries

#### **DANISH**

**ADVARSEL!**

Lithiumbatteri – Eksplosionsfare ved fejlagtig håndtering. Udskiftning må kun ske med batteri af samme fabrikat og type. Levér det brugte batteri tilbage til leverandøren.

#### **NORWEGIAN**

**ADVARSEL:**

Ekspløsjonsfare ved feilaktig skifte av batteri. Benytt samme batteritype eller en tilsvarende type anbefalt av apparatfabrikanten. Brukte batterier kasseres i henhold til fabrikantens instruksjoner.

#### **SWEDISH**

**VARNING:**

Explosionsfara vid felaktigt batteribyte. Använd samma batterityp eller en ekvivalent typ som rekommenderas av apparattillverkaren. Kassera använt batteri enligt fabrikantens instruktion.

#### **FINNISH**

**VAROITUS:**

Paristo voi räjähtää, jos se on virheellisesti asennettu. Vaihda paristo ainoastaan valmistajan suosittelemaan tyyppiin. Hävitä käytetty paristo valmistajan ohjeiden mukaisesti.

#### **ENGLISH**

**CAUTION:**

Danger of explosion if battery is incorrectly replaced. Replace only with the same or equivalent type recommended by the equipment manufacturer. Discard used batteries according to manufacturer's instructions.

#### **DEUTSCH**

**VORSICHT:**

Explosionsgefahr bei unsachgemäßem Austausch der Batterie. Ersatz nur durch denselben oder einen vom Hersteller empfohlenen gleich-wertigen Typ. Entsorgung gebrauchter Batterien nach Angaben des Herstellers.

## FRENCH

### **ATTENTION:**

Il y a danger d'explosion s'il y a remplacement incorrect de la batterie. Remplacer uniquement avec une batterie du même type ou d'un type équivalent recommandé par le constructeur. Mettre au rebut les batteries usagées conformément aux instructions du fabricant.

### Attention (for USA Users)

The product that you have purchased contains a rechargeable battery. The battery is recyclable. At the end of its useful life, under various state and local laws, it may be illegal to dispose of this battery into the municipal waste stream. Check with your local solid waste officials for details in your area for recycling options or proper disposal.

## About the Modem

### Caution

1. Never install telephone wiring during a lightning storm.
2. Never install telephone jacks in wet locations unless the jack is specifically designed for wet locations.
3. Never touch uninsulated telephone wires or terminals unless the telephone line has been disconnected at the network interface.
4. Use caution when installing or modifying telephone lines.
5. Avoid using the telephone function (other than a cordless-type) during an electrical storm. There may be a remote risk of electric shock from lightning.
6. Do not use the telephone function to report a gas leak in the vicinity of the leak.

### Caution (for USA Users)

To reduce the risk of fire, use only No.26 AWG or larger telecommunication line cord.



# ***Table of Contents***

<b>Preface</b> .....	<b>v</b>
<b>Chapter 1 Getting Started</b> .....	<b>1-1</b>
Getting the Computer Running.....	1-2
Unpacking .....	1-2
Connecting to AC Power .....	1-3
Opening the Cover .....	1-4
Turning On and Off the Computer.....	1-5
Taking a Look at the Computer .....	1-6
Right-Side Components .....	1-6
Left-Side Components .....	1-7
Rear Components.....	1-8
Front Components.....	1-10
Bottom-Side Components .....	1-11
Top-open Components.....	1-13
Where to Go from Here .....	1-16
<b>Chapter 2 Operating Your Computer</b> .....	<b>2-1</b>
Starting and Stopping the Computer.....	2-2
Starting the Computer .....	2-2
Stopping the Computer .....	2-2
Using the Keyboard .....	2-4
Typewriter Keys.....	2-4
Cursor-Control Keys .....	2-5

Numeric Keypad .....	2-5
Euro Symbol .....	2-6
Windows Keys .....	2-6
Function Keys .....	2-6
Fn Key .....	2-7
Hot Keys .....	2-7
Using the Touchpad .....	2-9
Configuring the Touchpad .....	2-11
Using the Touchscreen (option).....	2-12
Using the Hard Disk Drive .....	2-13
Using the CD / DVD/Combo Drive.....	2-14
Installing the CD / DVD/Combo Drive.....	2-15
Inserting and Removing a CD.....	2-16
Using the Video Features.....	2-17
Configuring the Display Modes .....	2-17
Using the Audio Features .....	2-19
Connecting Audio Devices .....	2-20
Using the Communication Features.....	2-21
Using the LAN.....	2-21
Using the Wireless LAN .....	2-22
Using the Wireless Modem.....	2-23
Using the GPS .....	2-24
<b>Chapter 3 Managing Power .....</b>	<b>3-1</b>
AC Adapter .....	3-2
Battery Pack .....	3-3
Charging the Battery Pack .....	3-3
Initializing the Battery Pack.....	3-4
Checking the Battery Level.....	3-4
Replacing the Battery Pack .....	3-5
Battery Low Signals and Actions.....	3-6
Power Management .....	3-7
Hibernation.....	3-8
Power-Saving Tips.....	3-9

<b>Chapter 4 Expanding Your Computer</b>	<b>4-1</b>
Connecting an External Monitor	4-2
Connecting a USB Device	4-3
Connecting a Serial Device-	4-4
Connecting an IR Device	4-5
Connecting an IR or Bluetooth-compliant Device	4-7
Connecting an IEEE 1394 Device	4-9
Connecting a Video Capture Device	4-10
System Memory Upgrade	4-10
<b>Chapter 5 Setup Configuration Utility (SCU)</b>	<b>5-1</b>
When and How to Use the SCU Program	5-2
When to Use	5-2
Starting SCU	5-2
Moving Around and Making Selections	5-4
Startup Menu	5-5
Disks Menu	5-8
Components Menu	5-9
Power Menu	5-13
Exit Menu	5-14
<b>Chapter 6 Installing Software Drivers</b>	<b>6-1</b>
How to Use the CD	6-2
Installing Drivers for Windows 2000	6-3
Touchscreen Driver	6-6
Installing Drivers for Windows XP	6-7
Touchscreen Driver	6-10
Touchscreen Utility	6-16
<b>Chapter 7 Caring for the Computer</b>	<b>7-1</b>
Protecting the Computer	7-2
Using the Password	7-2
Using an Anti-Virus Strategy	7-2
Taking Care of the Computer	7-3
General Guidelines	7-3



Cleaning Guidelines .....	7-4
Battery Pack Guidelines .....	7-4
When Traveling .....	7-5
<b>Chapter 8 Troubleshooting.....</b>	<b>8-1</b>
Preliminary Checklist .....	8-2
Solving Common Problems .....	8-3
Battery Problems .....	8-4
CD / DVD/Combo Drive Problems.....	8-4
Display Problems .....	8-5
Fingerprint Recognition Problems .....	8-7
Hardware Device Problems.....	8-7
Hard Disk Drive Problems .....	8-7
Infrared Problems.....	8-8
Keyboard, Mouse, and Touchpad Problems .....	8-8
LAN Problems .....	8-9
WLAN Problems.....	8-9
Modem Problems .....	8-9
Power Management Problems (for Windows) .....	8-11
Printer Problems.....	8-12
Software Problems .....	8-12
Sound Problems .....	8-13
Startup Problems .....	8-14
Other Problems.....	8-15
Resetting the Computer .....	8-16
<b>Appendix A Specifications .....</b>	<b>A-1</b>
<b>Appendix B Fingerprint Recognition System .....</b>	<b>B-1</b>
Finger Placement .....	B-2
Using the Fingerprint Recongnition System Utility .....	B-3

# Preface

This manual contains information that will help you operate the computer. It is divided into 8 chapters and an appendix.

- Chapter 1, **Getting Started**, takes you through the process of setting up the computer and identifying its external components.
- Chapter 2, **Operating Your Computer**, tells you how to use the computer's components and features.
- Chapter 3, **Managing Power**, provides information on power.
- Chapter 4, **Expanding Your Computer**, provides information on installing and using peripheral devices.
- Chapter 5, **SCU (Setup Configuration Utility)**, describes the SCU program that configures the computer's BIOS settings.
- Chapter 6, **Installing Software Drivers**, describes how to install the drivers and utilities supplied with the computer.
- Chapter 7, **Caring for the Computer**, gives you tips in care and maintenance.
- Chapter 8, **Troubleshooting**, gives solutions to common problems you may encounter when using the computer.
- Appendix A, **Specifications**, gives a brief specification of the computer.

- Appendix B, **Fingerprint Recognition System**, provides information on using the system's fingerprint recognition system.

## Notational Conventions

Throughout this manual, the following conventions are used to distinguish elements of text.

▮ **NOTE:** identifies additional information that requires special attention.

▮ **CAUTION:** identifies important information which, if not followed, may result in loss of data or damage to the computer.

Keyboard keys are shown in a bold typeset. For example:

Press **Enter** to complete.

When keys are joined by a plus sign (+), press the first key, and, while keeping the first key down, press the remaining keys, finally release all the keys. When necessary, keys are also shown in graphics.

A title, command, setup item, or button that you can see on the screen is shown in boldface. A value or an option that you can select for a setup item is shown in italic. For example:

Select **Power Management**, set it to *Enabled*, and then click the **OK** button.

# ***Getting Started***

Congratulations on purchasing this computer.

This high performance notebook computer is especially designed for the practical applications of warehouses, automobiles, vehicles, public security, repairing, assisting the handicapped, and other demanding situations where conventional notebook computers just cannot measure up.

This chapter first tells you step by step how to get the computer up and running. You will find instructions for these procedures:

- Unpacking
- Connecting to AC power
- Opening the cover
- Turning on the computer
- Turning off the computer

Then, you will find a section briefly introducing the external components of the computer. And the last section navigates you to the information you may need after the computer is ready for use.

# Getting the Computer Running

This section guides you through the procedures for getting the computer ready for operation.

## Unpacking

After unpacking the shipping carton, you should find these standard items:

- Notebook computer
- Accessories:
  - AC adapter (100~240 VAC, 50/60 Hz)
  - AC power cord (US, CE, UK, SA)
  - Driver CD
  - Fingerprint recognition scanner in main system (includes software)
  - *This Operation Manual*

Inspect all the items. If any item is damaged or missing, notify your dealer immediately.

Keep the shipping carton and packing materials in case you need to ship or store the computer in the future.

## Connecting to AC Power

The computer operates either on the external AC power or internal battery power. It is suggested that you use AC power when you start up the computer for the first time.

**CAUTION:** Use only the AC adapter included with your computer. Using other AC adapters may damage the computer.

**NOTE:**

**Power Supply Cord:** (optional) Detachable, minimum 1.5 m long. Listed, rated minimum 125 V, 7 A, having a 2/18 AWG, type SVT flexible cord. One end terminates with a parallel blade, molded-on, attachments plug with a 7 A, 125 V (NEMA 1-15P) configuration; other end terminates with a molded-on appliance coupler.

**Alternative:** (optional) Detachable, maximum 4.5 m (14.76 ft) long. Listed, rated minimum 250 V, 6 A, having a 3/18 AWG, type SVT flexible cord. One end terminates with a Tandem blade, grounding, listed molded-on, attachments plug with a 6 A, 250 V (NEMA 6-15P) configuration; other end terminates with a molded-on appliance coupler.

1. Make sure the computer is turned off.
2. Plug the DC cord of the AC adapter to the power connector on the rear side of the computer.
3. Plug the female end of the AC power cord to the AC adapter and the male end to an electrical outlet.

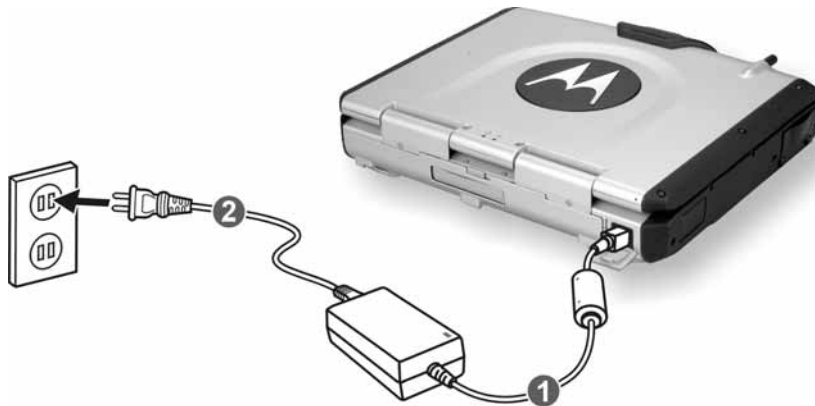

4. When the AC adapter is connected, the indicator on the AC adapter lights up, indicating that power is being supplied from the electrical outlet to the AC adapter and onto your computer. Now, you are ready to turn on the computer.

**CAUTION:**

- When you disconnect the AC adapter, disconnect from the electrical outlet first and then from the computer. A reverse procedure may damage the AC adapter or the computer.
- When unplugging the connector, always hold the plug head. Never pull on the cord.

**NOTE:** When the AC adapter is connected, it also charges the battery pack. For information on using battery power, see Chapter 3.

## Opening the Cover

**CAUTION:** Be gentle when opening and closing the cover. Opening it vigorously or slamming it shut could damage the computer.

1. Open the top cover by pulling on the handle, inserting your index finger, and then pulling on the cover latch.



2. Lift up the cover. You can tilt the cover forward or backward for optimal viewing clarity.

## Turning On and Off the Computer

### Turning On

1. Make sure the computer is connected to AC power.
2. Press the power button.



3. Each time the computer is turned on, it performs a Power-On Self Test (POST), and the operating system such as Windows should start.

## Turning Off

To turn off the computer power, use the “Shut Down” command of your operating system.

**NOTE:** There are other ways you can stop the computer so that you will be back to where you left off when you next turn on the computer. (See “Stopping the Computer” in Chapter 2 for information.)

**CAUTION:** If you have to turn the computer on again immediately after turning it off, wait for at least five seconds. Turning the computer off and on rapidly can damage it.



## Taking a Look at the Computer

This section identifies the external components of the computer and briefly describes the function of each component.

**NOTE:** Depending on the model you purchased, the appearance of your computer may not exactly be the same as those shown in this manual.

### Right-Side Components

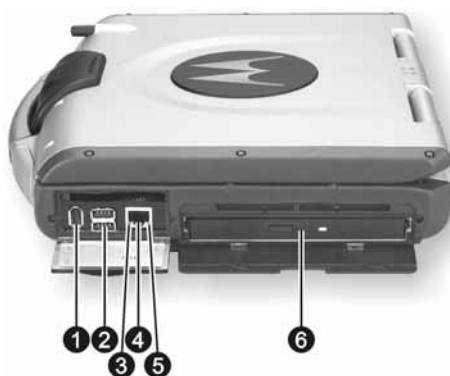

Ref	Component	Description	See Also
①	<b>IEEE 1394 Port</b>	Connects a 1394 device, such as a scanner, printer, digital camera, joystick, and more.	P. 4-7
②	<b>USB Ports</b>	Each of the two ports connects a USB device, such as a USB floppy drive, printer, digital camera, joystick, and more.	P. 4-3
③	<b>RJ-45 (LAN) Link Indicator</b>	Glows green when the system has an available connection to LAN (Local Area Network).	P. 2-24
④	<b>RJ-45 Connector</b>	Connects the LAN cable.	P. 2-24
⑤	<b>RJ-45 Active Indicator</b>	Blinks green when the system is accessing the LAN.	P. 2-24
⑥	<b>CD R-W/ DVD-Combo</b>	Accepts a compact disc (CD) for installing or loading software, accessing data, and playing	P. 2-17



## Left-Side Components

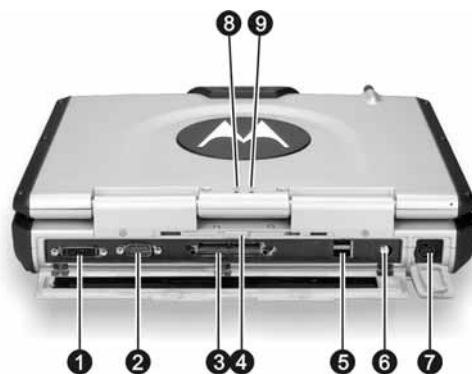

Ref	Component	Description	See Also
①	<b>IR Port</b>	Connects an IrDA-compliant device for wireless data transfer.	P. 4-5
②	<b>Bluetooth Port</b>	Connects a bluetooth-capable device for wireless data transfer.	P. 4-5
③	<b>Microphone Connector</b>	Connects an external microphone.	P. 2-23
④	<b>Keyboard BIOS Reset Switch</b>	Use this to turn off the system when resetting the system using Ctrl+Alt+Del does not work.	P. 8-17
⑤	<b>Audio Output Connector</b>	Connects a set of headphones, external speakers with amplifier, or an audio recording device.	P. 2-23

## Rear Components



Ref	Component	Description	See Also
❶	<b>DVI-I Port</b>	Connects an external monitor.	P. 4-2
❷	<b>Serial Port</b>	Connects a serial device, such as an external modem.	P. 4-4
❸	<b>Docking Port</b>	For connecting to a Port Replicator / car mount.	
❹	<b>Rear Cover Latch</b>	Locks the rear cover.	
❺	<b>USB Ports</b>	Each of the two ports connects a USB device, such as a floppy disk drive, printer, digital camera, joystick, and more.	P. 4-3
❻	<b>AV Input Port</b>	Connects to a video recording device.	P. 4-8
❼	<b>Power Connector</b>	Connects the AC adapter.	P. 1-3
❽	<b>AC Power Indicator</b> 	Glows green when the computer is using AC power. Blinks amber (orange) when the computer, using AC power, is in Standby mode.	
❾	<b>Battery Charge Indicator</b> 	Glows green when the battery is fully charged and connected to AC power. Glows amber (orange) when the battery is being charged.	P. 1-4

## Front Components

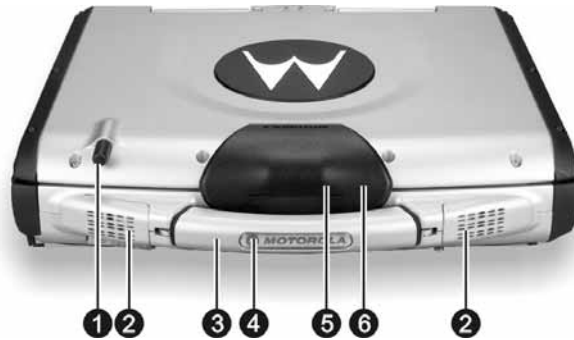

Ref	Component	Description	See Also
①	<b>Wireless Modem Antenna</b>	Serves as the antenna for the wireless modem (RDLAP, GPRS, iDEN, and CDMA).	P. 2-27
②	<b>Stereo Speaker Set</b>	Sends out sound and voice from the computer.	P. 2-22
③	<b>Handle</b>	Allows you to carry your computer for an easy grip.	
④	<b>Wireless LAN Antenna</b>	Serves as the antenna for the WLAN. It is built-in the handle.	P. 2-25
⑤	<b>GPS Antenna (option)</b>	Serves as the antenna for the Global Positioning System (GPS). It is built-in the top cover latch.	P. 2-27
⑥	<b>Top Cover Latch</b>	Locks the top cover.	P. 1-4

## Bottom-Side Components

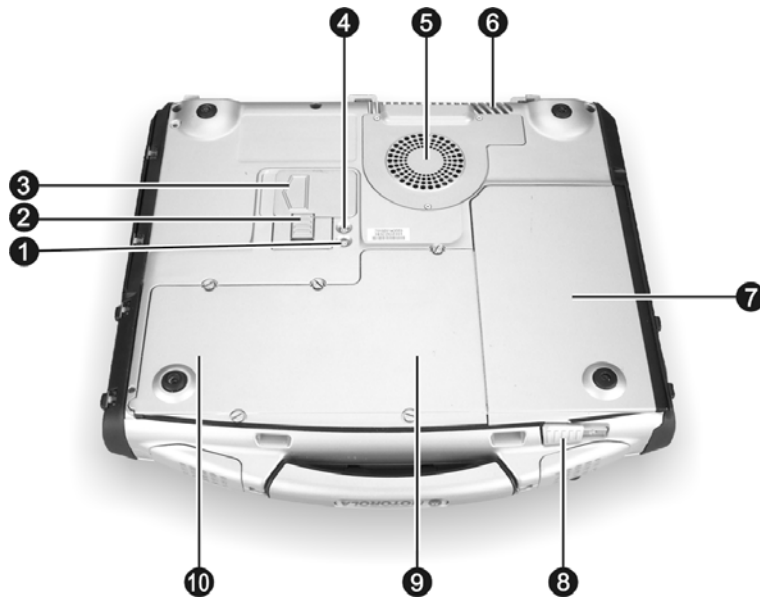











Ref	Component	Description	See Also
①	<b>X-bay Module Antenna Connector</b>	Serves as the interface between the system and antenna of the X-bay module.	
②	<b>CD Drive Lock/Unlock Switch</b>	Allows you to lock the CD drive in place (can also contain the floppy disk drive or secondary battery).	P. 2-13, 2-17
③	<b>CD/DVD Drive Eject Latch</b>	Allows you to remove the CD drive (can also contain the CD R-W or DVD drive).	P. 2-13
④	<b>GPS Connector</b>	Serves as the interface between the system and external GPS antenna.	
⑤	<b>CPU Socket and Sealed CPU Cooling Fan</b>	Inside is the CPU of your computer and cooling fan to protect it from overheating.	
⑥	<b>Ventilation Openings</b>	Do not cover or block the ventilation openings for air circulation thus preventing overheating.	

Ref	Component	Description	See Also
⑦	<b>Primary Battery Pack</b>	Supplies power to your computer when external power is not connected.	P. 3-3
⑧	<b>Primary Battery Release Latch</b>	Secures the primary battery compartment cover in place.	P. 3-5
⑨	<b>X-Bay Interface (top)</b> <b>Mini PCI Slot (bottom)</b>	Connects additional wireless modem (GPRS/GSM or iDEN). Inside is the Mini PCI slot for using an optional Mini PCI card.	
⑩	<b>Hard Disk Drive Compartment (top)</b> <b>Memory Slot (bottom)</b>	Contains the hard disk drive of your computer. Contains the memory slot for expanding the memory size of your computer.	P. 2-15 P. 4-9

## Top-open Components



Ref	Component	Description	See Also
①	<b>Fingerprint Scanner</b>	Contains the fingerprint sensor.	P. B-1
②	<b>Keyboard</b>	Serves as the data input device of the computer.	P. 2-4
③	<b>Power Button</b>	Turns the computer power ON and OFF.	P. 1-5

<b>4</b>	<b>Device Indicators</b>	Show the current status of the computer's devices.	
		Power on / Standby mode indicator	P. 1-3
		Hard disk drive in-use indicator	P. 2-15
		Num Lock indicator	P. 2-6
		Caps Lock indicator	P. 2-4
		Scroll Lock indicator	P. 2-4
<b>5</b>	<b>LCD Screen</b>	Displays the output of the computer.	P. 2-20
<b>6</b>	<b>Light Sensor</b>	Automatic light sensor for dimming the display's backlight.	P. 2-20
<b>7</b>	<b>Touchpad</b>	Serves as the pointing device of the computer.	P. 2-9
<b>8</b>	<b>Device Indicators</b>	Show the current status of the computer's devices.	
		CD/DVD drive in-use indicator	P. 2-19
		Battery power indicator – Glow green when the computer is using battery power. Blinks green when the computer, using battery power, is in Standby mode. Blinks amber (orange) when the battery is almost completely discharged.	P. 3-3
		Battery charge indicator – Glow green when the battery is fully charged and connected to AC power. Glow amber (orange) when the battery is being charged.	P. 3-3
		Glow green when the touchpad is enabled. Can be enabled/disabled using the hot keys Fn+F7.	P. 2-9
		AC in and HDD heater on indicator – Glow green when the computer is connected to AC power. Blink red when the hard disk heater is below 2° C, and can't power on.	P. 1-4 P. 2-13



## Where to Go from Here

As your computer is ready for operation, you may want to do any of the following now:

<b>For this purpose...</b>	<b>Do this...</b>
To know more about the computer...	Go on to the next chapter.
To install the operating system if your dealer has not already done so...	See the operating system manual.
To know more about the operating system...	Read the operating system manual.
To install the drivers if your dealer has not already done so...	See Chapter 6.
To set a power-on password...	See "Startup Menu" in Chapter 5.
To charge the battery pack for the first time...	See "Charging the Battery Pack" in Chapter 3.

# *Operating Your Computer*

This chapter provides information about the use of the computer.

If you are new to computers, reading this chapter will help you learn the operating basics. If you are already a computer user but are new to notebook computers, you may choose to read only the parts containing information unique to your computer.

Described in this chapter are the operating basics of these components:

- Keyboard
- Touchpad
- Touchscreen
- Floppy disk drive
- Hard disk drive
- CD/DVD drive

And these features:

- Starting and stopping the computer
- Video features
- Audio features
- Communication features

# Starting and Stopping the Computer

There are a number of ways to start and stop the computer.

## Starting the Computer

You always start the computer using the power button.

A computer starts up with an operating system (OS) existing on the storage device such as the hard disk; or from a floppy disk or CD if you have the respective modules installed. The computer will automatically load the OS after you turn it on. This process is called booting.

**NOTE:** An operating system is the platform for all your software application programs to run on. The most widely used operating system today is Microsoft Windows.

## Stopping the Computer

When you finish a working session, you can stop the computer by turning off the power or leaving the computer in Standby or Hibernation mode:

To stop in this mode...	Do this...	To start up or resume again
Off	Follow the shutdown procedure of your operating system. This can prevent loss of unsaved data or damage to your software programs.  If the system is locked up because of hardware or software problems, press the power button to turn off the computer.	Press the power button.
Standby	Depending on your settings in Windows, you can place the computer in Standby mode by: <ul style="list-style-type: none"><li>• Closing the display cover</li><li>• Pressing the power button</li></ul>	Press any key.

To stop in this mode...	Do this...	To start up or resume again
Hibernation	Depending on your settings in Windows, you can place the computer in Hibernation mode by: <ul style="list-style-type: none"><li>• Closing the display cover.</li><li>• Pressing the power button</li></ul>	Press the power button.

If you choose to stop in Standby or Hibernation mode, you can return to where you left off the next time you start up the computer. (See “Power Management” in Chapter 3 for more information.)

## Using the Keyboard

Your keyboard has all the standard functions of a full-sized computer keyboard plus a Fn key added for specific functions.

The standard functions of the keyboard can be further divided into four major categories:

- Typewriter keys
- Cursor-control keys
- Numeric keys
- Function keys

### Typewriter Keys

Typewriter keys are similar to the keys on a typewriter. Several keys are added such as the Ctrl, Alt, Esc, and lock keys for special purposes. When the lock keys (Caps Lock, Num Lk, and Scroll Lk) are pressed, their corresponding indicators light up.

The Control key is normally used in combination with other keys for program-specific functions. The Alternate key is normally used in combination with other keys for program-specific functions. The Escape key is usually used for stopping a process. Examples are exiting a program and canceling a command. The function depends on the program you are using.

## Cursor-Control Keys

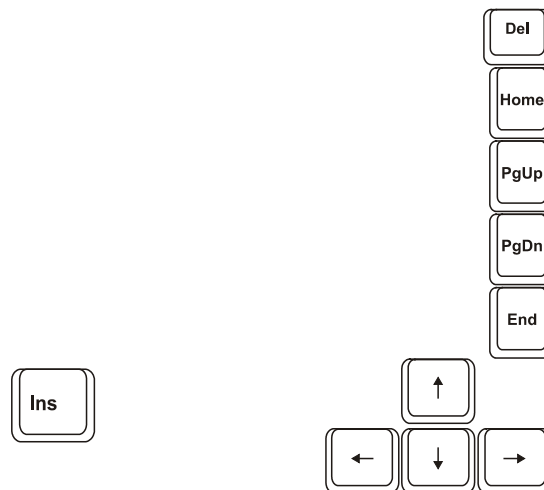

**NOTE:** The word “cursor” refers to the indicator on the screen that lets you know exactly where on your screen anything you type will appear. It can take the form of a vertical or horizontal line, a block, or one of many other shapes.

## Numeric Keypad

A 15-key numeric keypad is embedded in the typewriter keys as shown next:

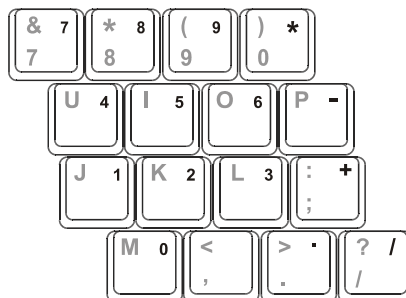

Numeric keys facilitate entering of numbers and calculations. When Num Lock is on, the numeric keys are activated; meaning you can use these keys to enter numerals.

**NOTES:**



- When the numeric keypad is activated and you need to type the English letter in the keypad area, you can turn Num Lock off or you can press **Fn** and then the letter without turning Num Lock off.
- Some software may not be able to use the numeric keypad on the computer. If so, use the numeric keypad on an external keyboard instead.



## Euro Symbol

You can press the Euro dollar sign € on the keyboard.

- To press the Euro sign on the keyboard, hold down either of the **Alt** keys and type **0128** on the numeric keypad of your keyboard.
- To press the Euro sign on an UK keyboard, hold down the **Alt Gr** key and press **4** (which has an Euro sign on it).

## Windows Keys

The keyboard has two keys that perform Windows-specific functions:  Windows Logo key and  Application key.

The  Windows Logo key opens the Start menu and performs software-specific functions when used in combination with other keys. The  Application key usually has the same effect as a right mouse click. (See your Windows manual for more information.)

## Function Keys

On the top row of the keys are the function keys: F1 to F12. Function keys are multi-purpose keys that perform functions defined by individual programs.













## Fn Key

The Fn key, at the lower left corner of the keyboard, is used with another key to perform the alternative function of a key. The letter “Fn” and the alternative functions are identified by the color of blue on the keytop. To perform a desired function, first press and hold Fn, then press the other key.



## Hot Keys

Hot keys refer to a combination of keys that can be pressed any time to activate special functions of the computer. Most hot keys operate in a cyclic way. Each time a hot key combination is pressed, it shifts the corresponding function to the other or next choice.

You can easily identify the hot keys with the icons imprinted on the keytop. The hot keys are described next.

Key	Description
 	Toggles keyboard backlight on/off. (Brightness will be controlled by ambient light sensor.)
 	Decreases the sound volume.
 	Increases the sound volume.
 	Decreases the LCD brightness.
 	Increases the LCD brightness.
 	Switches LCD on and off.

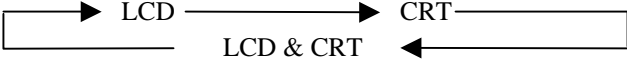

Key	Description
	<p>Switches the display output to one of the following when an external device is connected.</p> <p>Upon booting the system with CRT:</p>  <p>NOTES:</p> <ul style="list-style-type: none"> <li>• If the display mode is set to 256 colors or lower, or in DOS mode, there will be only two modes for selecting: CRT only and LCD &amp; CRT.</li> <li>• This function only applies to Plug &amp; Play CRT monitors.</li> </ul>
	<p>Serves as the sleep button that you can define with Windows' <b>Power Management</b>. (See the "Power Management" in Chapter 3.)</p>
	<p>Switches GPS function on and off.</p>

## Using the Touchpad

**CAUTION:** Do not use a sharp object such as a pen on the touchpad. Doing so may damage the touchpad surface.

**NOTES:**

- A touchpad indicator is found on the keyboard panel, use the **Fn+F7** hot keys to enable/disable this function.
- For optimal performance of the touchpad, keep your fingers and the pads clean and dry. When tapping on the pad, tap lightly. Do not use excessive force.

The touchpad is a pointing device that allows you to communicate with the computer by controlling the location of the pointer on the screen and making selection with the buttons.



The touchpad consists of a rectangular pad and four buttons. To use the touchpad, place your forefinger or thumb on the pad. The rectangular pad acts like a miniature duplicate of your display. As you slide your fingertip across the pad, the pointer (also called cursor) on the screen moves accordingly. When your finger reaches the edge of the pad, simply relocate yourself by lifting the finger and placing it on the other side of the pad.

Here are some common terms that you should know when using the touchpad:

Term	Action
Point	Move your finger on the pad until the cursor points to the selection on the screen.
Click	Press and release the left button. –or– Tap gently anywhere on the pad.
Double-click	Press and release the left button twice in quick succession. –or– Tap twice on the pad rapidly.
Drag and drop	Press and hold the left button, then move your finger until you reach your destination (drag). Finally, release the button (drop) when you finish dragging your selection to the destination. The object will drop into the new location. –or– Gently tap twice on the pad and on the second tap, keep your finger in contact with the pad. Then, move your finger across the pad to drag the selected object to your destination. When you lift your finger from the pad, the selected object will drop into place.
Scroll	To scroll is to move up and down or left and right in the working area on the screen.  To move vertically, place your finger on the right edge of the pad and slide your finger up and down along the edge To move horizontally, place your finger on the bottom edge of the pad and slide your finger left and right.  This function works only after you install the touchpad driver supplied with the computer and it may not work for all applications.

**TABLE NOTE:** If you swap the left and right buttons, “tapping” on the touchpad as an alternative method of pressing the left button will no longer be valid.

## Configuring the Touchpad

You may want to configure the touchpad to suit your needs. For example, if you are a left-handed user, you can swap the two buttons so that you can use the right button as the left button and vice versa. You can also change the size of the on-screen pointer, the speed of the pointer, and so on.

To configure the touchpad, you can use the standard Microsoft or IBM PS/2 driver if you are using Windows. However, you can install the touchpad driver supplied with your computer to take advantage of more powerful features. (For information on installing the driver, see “How to Use the Driver CD” in Chapter 6.)

## Using the Touchscreen (option)

**CAUTION:** Do not use a sharp object such as a ballpoint pen or pencil on the touchscreen. Doing so may damage the touchscreen surface.

The touchscreen is a touch-sensitive device that allows you to communicate with the computer by controlling the location of the pointer on the screen and making selection with the buttons.

The touchscreen needs a special device driver support that allows you to easily use the computer without any external pointing device. (For information on installing the driver, see Chapter 6.)

Here are some common terms that you should know when using the touchscreen:

Term	Action
Point	Move your finger on the touchscreen until the cursor points to the selection on the screen.
Click	Tap gently anywhere on the touchscreen.
Double-click	Tap twice on the touchscreen rapidly.
Drag and drop	Press lightly on the touchscreen and move your finger until you reach your destination (drag). Finally, release your finger (drop) when you finish dragging your selection to the destination. The object will drop into the new location.
Scroll	<p>To scroll is to move up and down or left and right in the working area on the screen.</p> <p>To move vertically, place your finger on the right edge of the touchscreen and slide your finger up and down along the edge. To move horizontally, place your finger on the bottom edge of the touchscreen and slide your finger left and right.</p> <p>This function works only after you install the touchscreen driver supplied with the computer and it may not work for all applications.</p>

## Using the Hard Disk Drive

Your computer comes with a hard disk drive as drive C. The system has a built-in heater that automatically turns on for low temperature operation. The AC in / HDD heater on indicator blinks red when heater is on.



A hard disk drive is a storage device with non-removable, rotating, magnetic storage platters inside it. It is where your operating system and application software programs are stored.

Your hard disk drive is a 2.5-inch IDE (Integrated Drive Electronics) hard disk drive. This type of drive embodies the latest in fast, reliable mass storage by integrating all the control circuitry necessary for operation directly onto the drive itself. This allows the drive manufacturer to carefully optimize drive performance.

**CAUTION:**

- Make regular backups of your data files from your hard disk drive to floppy disks or other storage media.
- Never try to remove or install the hard disk drive while the computer is powered on. Doing so can result in loss of data, and can damage the computer and the hard disk drive's sensitive circuitry.
- Never turn off or reset the computer while the hard disk drive in-use indicator is on.

## Using the CD/DVD Drive (option)

Depending on the model, your computer comes with a CD R-W or DVD-Combo drive. This drive is usually configured as drive D and is connected through the CD drive bay located on the right side of the computer.

The drive uses removable 5.25-inch silver discs, which look like standard music CDs. It is an ideal medium to use for distributing multimedia because of the huge amount of data that a disc can store.

Depending on the model, your drive is one of the following:

- **CD R-W drive** not only read CDs, audio CDs, CD-R, and CD-RW discs but also write to CD-R and CD R-W discs.
- **DVD-Combo drive** can work both as a DVD drive and CD R-W drive.

**NOTE:** If the CD R-W / DVD-Combo drive would be operating for more than half an hour (such as showing a DVD title), use the AC power source instead of the battery. If not, the battery may run out of power before the operation is complete.

**CAUTION:**

1. When inserting a CD, do not use force.
2. Make sure the CD is correctly inserted into the tray, and then close the tray.
3. Do not leave the CD tray open. Also, avoid touching the lens in the tray with your hand. If the lens becomes dirty, the CD may malfunction.
4. Do not wipe the lens using materials with rough surface (such as paper towel). Instead, use a cotton swab to gently wipe the lens.

FDA regulations require the following statement for all laser-based devices:  
"Caution, Use of controls or adjustments or performance of procedures other than those specified herein may result in hazardous radiation exposure."

**NOTE:** The CD R-W / DVD-Combo drive is classified as a Class 1 laser product. This label is located on the CD R-W / DVD-Combo drive.

**CLASS 1 LASER PRODUCT  
LASER KLASSE 1**

**NOTE:** For DVD-Combo drive only.

This product incorporates copyright protection technology that is protected by method claims of certain U.S. patents and other intellectual property rights owned by Macrovision Corporation and other rights owners. Use of this copyright protection technology must be authorized by Macrovision Corporation, and is intended for home and other limited viewing uses only unless otherwise authorized by Macrovision Corporation. Reverse engineering or disassembly is prohibited.

## Installing the CD R-W / DVD-Combo Drive

To install the CD R-W / DVD-Combo drive:

1. Insert the CD R-W / DVD-Combo drive into the CD drive bay located on the right side of the computer.



2. Slide the CD drive lock/unlock switch to the lock position to secure the CD R-W / DVD-Combo drive in place.





## Inserting and Removing a CD

**NOTE:** The following procedure applies to inserting or removing a DVD disc as well.

Follow this procedure to insert or remove a CD.

1. Turn on the computer.
2. Press the eject button and the CD tray will slide out partially. Gently pull on it until it is fully extended.
3. To insert a CD, place down the CD in the tray with its label facing up. Slightly press the center of the CD until it clicks into place.

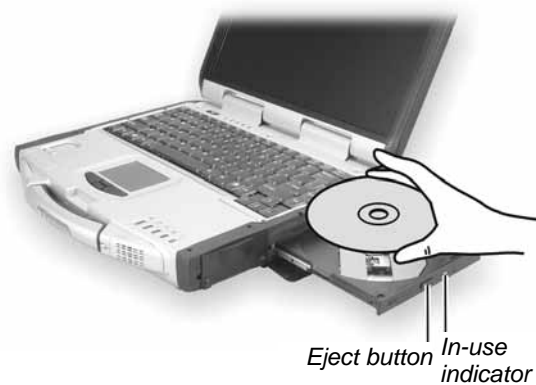

To remove a CD, hold the CD by its outer edge and lift it up from the tray.

4. Gently push the tray back into the drive.

**NOTE:** In the unlikely event that you are unable to release the CD tray by pressing the eject button, you can manually release the CD. (See "CD R-W / DVD-Combo Drive Problems" in Chapter 8.)

## Using the Video Features

The video subsystem of your computer features:

- 12.1/13.3-inch TFT (Thin-Film Transistor) color LCD display with 1024x768 XGA (Extended Video Graphics Array) resolution.
- 64 MB integrated video memory.
- Simultaneous display on LCD and external monitor, which is useful when you have a presentation as you can control the screen from your computer and face the audience at the same time.
- Dual view capability, which allows you to expand your desktop on the screen to another display device so that you have more desktop space to work on.
- Power Management.
- Touchscreen function (option).
- Sunlight readable transfective LCD display (option).

### NOTES:

- Before using the dual view capability, the video driver supplied with your computer must be installed.
- The computer enters Standby or Hibernation mode when the LCD is closed. If you want to use the computer with the LCD closed, set *None* to the "When I close the lid of my portable computer" option in the **Power Management** Properties. Thus the computer does not enter Standby or Hibernation mode when the LCD is closed.

## Configuring the Display Modes

### NOTES:

- To take advantage of the enhanced video capabilities, the video driver supplied with your computer must be installed.
- When using CRT only, the resolution would depend on the supported resolution by the CRT.

Your computer has been set to a default resolution and number of colors before shipment. You can view and change display settings through your operating system. See your operating system documentation or online help for specific information.

For displaying in higher resolutions, you can connect an external CRT monitor that supports higher resolutions. (See “Connecting an External Monitor” in Chapter 4 for more information.)

The following table lists the display modes supported by your computer.

Display Mode		LCD Only	CRT Only	Simultaneous Display
Resolution	Colors			
800x600	16-bit	√	√	√
	32-bit	√	√	√
1024x768	16-bit	√	√	√
	32-bit	√	√	√

**TABLE NOTES:**

- 16-bit = High Color or 65,536 (64 K) colors; 32-bit = True Color 16,770,000 (16 M) colors.
- When using CRT only, the resolution would depend on the supported resolution by the CRT.

## Using the Audio Features

### NOTES:

- To take advantage of the enhanced audio capabilities, the audio driver supplied with your computer must be installed (see chapter 6 for details).
- If you experience interference while recording, try lowering the microphone recording volume.

The audio subsystem of your computer features:



- Digital audio and analog mixing functions required for recording and playing sound on your computer
- Microsoft Windows Sound System support
- A set of speakers (❶)
- External audio connectors (❷)



Ways of playing and recording sound vary with the operating system used. See your operating system documentation or online help for specific information.

## Connecting Audio Devices

For higher audio quality, you can send or receive sound through external audio devices.

- **Microphone Connector** (  ) can be connected to an external microphone for recording voice or sound.
- **Audio Output Connector** (  ) can be connected to the line-in connector of powered speakers with built-in amplifiers, headphones, or earphone set. This connector is compliant with S/P-DIF (Sony/Philips-Digital InterFace). You can connect audio equipment with S/P-DIF to the computer. S/P-DIF is a new audio transfer file format that ensures a high quality digital audio output through optical fibers.

**NOTE:** When using external speakers/headphones or microphone, you cannot use the internal one.

# Using the Communication Features

## Using the LAN

**NOTE for Windows 2000:** To take advantage of the LAN feature, the LAN driver supplied with your computer must be installed.

The internal 100Base-T LAN (Local Area Network) module allows you to connect your computer to a network. It supports data transfer rate up to 100 Mbps.

To connect the network cable to the LAN module, connect one end of the LAN cable to the RJ-45 connector on the computer and the other end to the network hub.



The bottom left portion of the RJ-45 port contains the “Link Indicator,” that glows green when the system has an available connection to LAN. While the bottom right portion contains the “Active Indicator,” that blinks green when the system is accessing the LAN.



## Using the Wireless LAN

Depending on your model, an internal Mini PCI wireless LAN (WLAN) card may have been pre-installed by your computer manufacturer at the factory. This card allows you to access corporate networks or the Internet in a wireless environment.

The WLAN features include:

- IEEE 802.11b standard compliance
- 2.4 GHz DSSS (Direct Sequence Spread Spectrum) technology
- Peer-to-Peer (Ad-Hoc) and Access Point (Infrastructure) modes support
- WEP (Wired Equivalent Privacy) 64/128-bit data encryption
- Transmission rate at 11 Mbps, 5.5 Mbps, 2 Mbps, and 1 Mbps with automatic data rating

To take advantage of the WLAN feature, make sure that the WLAN driver is installed correctly. (See Chapter 6 for more information.) If your WLAN card was provided by your dealer instead of the computer manufacturer, contact your dealer for the correct driver to use.

## Configuring the WLAN

After driver installation, you can use the WLAN utility to configure and monitor your WLAN connection. If you are using Windows XP, you can also use its built-in WLAN utility. Follow this procedure to launch the WLAN utility in Windows XP:

1. Select **Control Panel** from the **Start** menu.
2. Click **Network and Internet Connections**.
3. Click **Network Connections**, then double-click the **Wireless Network Connection** icon .
4. Click **Properties** in the **Wireless Network Connection Status** dialog box.
5. You can configure your WLAN settings in the **Wireless Network Connection Properties** dialog box.

## Turning Off/On the WLAN

**NOTE:** The FAA (Federal Aviation Agency) has deemed it unsafe to operate wireless devices in aircraft as this may interfere with flight safety. Remember to select turn off wireless LAN when using your computer in the airplane.

Upon booting-up your computer, the WLAN function is on.

To turn off the WLAN function, turn off the WLAN utility.

It takes approximately 30 seconds for your computer to make a successful WLAN connection and approximately 10 seconds to disconnect.

## Connecting to the Internet or a Network through Wireless Data Services

Depending on your model, your computer includes an integrated GSM (Global System for Mobile Communications) / GPRS (General Packet Radio Service) feature.

After you establish a subscription with a GSM/GPRS service provider, you can use the wireless data features of your computer. Check with your service provider for a list of available wireless data services. Your service provider may charge additional fees for use of data services.

There are two methods for wirelessly connecting to an ISP or network:

- **GSM data transmission (circuit-switched data)**  
GSM data services enable you to use the GSM component of your computer as a built-in modem. You can use the service to connect to the Internet through an ISP or dial in to a corporate network to browse the Web or send and receive e-mail messages.
- **GPRS data transmission**  
GPRS is a high-speed data-on service that enables you to transmit data over a mobile network. Subscribing to a GPRS service allows you to transfer files, browse the Web and receive streaming audio and video on your computer.

## Connecting Using the GSM Modem

**NOTE:** To take advantage of the wireless modem feature, the PCI-952 driver supplied with your computer must be installed (see chapter 6).



Your computer can send and receive data via a mobile network using the GSM protocol.

To send or receive data over a GSM network, you must have an account with a service provider that supports GSM data services, and the service provider must enable the data features on your account.

### **Configuring a GSM Modem Connection**

Before you can use the GSM modem connection, make sure that you have a subscription to the Circuit-Switched Data (CSD) network with your service provider and you have an account with your service provider or corporate network you are connecting to.

To connect to an ISP or dial in to a specific computer, you must configure a connection for that service on your computer.

## Connecting Using GPRS

Your computer can receive General Packet Radio Services (GPRS), a high-speed data-only service that transmits data over a mobile telephone network. In addition, GPRS provides permanent on-line connection.

To use GPRS, you must have a subscription to the function with a service provider that supports GPRS.

### **Configuring a GPRS Connection**

To connect to a GPRS network, you must configure a connection for that service on your computer.

## Connecting Using GPS

**NOTE:** To take advantage of the GPS feature, the PCI-952 driver supplied with your computer must be installed (see chapter 6).

Navigation and positioning are crucial to so many activities and yet the process has always been quite cumbersome. To try to figure out where you are and where you are going, you need GPS technology.

The Global Positioning System (GPS) is a worldwide radio-navigation system formed from a constellation of 24 satellites and their ground stations. GPS uses these "man-made stars" as reference points to calculate

positions accurate to a matter of meters. In fact, with advanced forms of GPS you can make measurements to better than a centimeter! In a sense it is like giving every square meter on the planet a unique address.

Here's how GPS works in five logical steps:

- The basis of GPS is "triangulation" from satellites.
- To "triangulate," a GPS receiver measures distance using the travel time of radio signals.
- To measure travel time, GPS needs very accurate timing that it achieves with some tricks.
- Along with distance, you need to know exactly where the satellites are in space. High orbits and careful monitoring are the secret.
- Finally you must correct for any delays the signal experiences as it travels through the atmosphere.

Five broad categories of GPS application:

- Location – determining a basic position
- Navigation – getting from one location to another
- Tracking – monitoring the movement of people and things
- Mapping – creating maps of the world
- Timing – bringing precise timing to the world



# *Managing Power*

Your computer operates either on external AC power or internal battery power.

This chapter tells you how you can effectively manage power. To maintain optimal battery performance, it is important that you use the battery in the proper way.

The topics in this chapter include:

- What is an AC adapter
- How to charge the battery pack
- When and how to initialize the battery pack
- How to check the battery level
- How to replace the battery pack
- What happens when the battery is low and what actions to take
- What is Power Management
- How to save power

## AC Adapter

**CAUTION:**

- The AC adapter is designed for use with your computer only. Connecting the AC adapter to another device can damage the adapter.
- The AC power cord supplied with your computer is for use in the country where you purchased your computer. If you plan to go overseas with the computer, consult your dealer for the appropriate power cord.
- When you disconnect the AC adapter, disconnect from the electrical outlet first and then from the computer. A reverse procedure may damage the AC adapter or computer.
- When unplugging the connector, always hold the plug head. Never pull on the cord.

The AC adapter serves as a converter from AC (Alternating Current) to DC (Direct Current) power because your computer runs on DC power, but an electrical outlet usually provides AC power. It also charges the battery pack when connected to AC power.

The AC adapter operates on any voltage in the range of 100 ~ 240 V AC.

# Battery Pack

The battery pack is the internal power source for the computer. It is rechargeable using the AC adapter.

The operating time of a fully charged battery pack depends on how you are using the computer. When your applications often access peripherals, you will experience a shorter operating time.

**NOTE:** Care and maintenance information for the battery is provided in the “Battery Pack Guidelines” section in Chapter 7.

## Charging the Battery Pack

**NOTES:**

- Charging will not start if the battery's temperature is below 0 °C (32 °F) or above 50 °C (122 °F).
- The charging process will stop and the Battery Charge Indicator flashes amber when the battery's temperature gets above 60 °C (140 °F). If this happens, the battery pack may be damaged. Please contact your dealer.
- During charging, do not disconnect the AC adapter before the battery has been fully charged; otherwise you will get a prematurely charged battery.

To charge the battery pack, connect the AC adapter to the computer and an electrical outlet. The Battery Charge Indicator (  ) on the computer glows amber to indicate that charging is in progress. You are advised to keep the computer power off while the battery is being charged. When the battery is fully charged, the Battery Charge Indicator glows green.

It takes approximately 197 minutes to charge the battery pack to 80% capacity and four or more hours to fully charge the battery pack when the computer is off.

**CAUTION:** After the computer has been fully recharged, do not immediately disconnect and reconnect the AC adapter to charge it again. Doing so may damage the battery.

**NOTE:** The battery level may automatically lessen due to the self-discharge process (0.21% per day), even when the battery pack is fully charged (100%). This happens no matter if the battery pack is installed in the computer.

## Initializing the Battery Pack

You need to initialize a new battery pack before using it for the first time or when the actual operating time of a battery pack is much less than expected.



Initializing is the process of fully charging, discharging, and then charging. It can take several hours.

1. Make sure the computer power is turned off. Connect the AC adapter to fully charge the battery pack.
2. After the battery pack is fully charged, turn on the computer.
3. Disconnect the AC adapter and leave the computer on until the battery is fully discharged. The computer will shut down automatically.
4. Connect the AC adapter to fully charge the battery pack.

## Checking the Battery Level

When the battery charge on the battery falls below 5%, then system will shutdown.

**NOTE:** Any battery level indication is an estimated result. The actual operating time can be different from the estimated time, depending on how you are using the computer.

You can check the approximate battery level using the battery meter function of the operating system. To read the battery level in Windows, click the  icon on the taskbar. (Click the  icon if the computer is using AC power.)

## Replacing the Battery Pack

**CAUTION:**

- There is danger of explosion if the battery is incorrectly replaced. Replace the battery only with the computer manufacturer's optional battery packs. Discard used batteries according to the dealer's instructions.
- Do not attempt to disassemble the battery pack.

If you often rely on battery power for a long period of time while traveling, you may consider the purchase of an additional battery pack from your dealer and keep it with you in a fully charged state as a backup.

To replace the battery pack, follow these steps:

1. Make sure the computer is not turned on or connected to AC power.
2. Slide the battery security lock outward to the unlock (  ) position ( **1** ) and lift the battery pack compartment cover to take it off the computer ( **2** ).



3. Pull on the ribbon and take the battery pack off the computer.
4. Insert the new battery pack into the compartment.



## Battery Low Signals and Actions

Battery Low occurs when the battery has approximately 10% (Windows default setting) of its charge remaining. The computer gives warning beeps or messages and the Battery Charge Indicator (  ) blinks red to alert you to take actions.

**NOTE:** You can set up your threshold and signals of Battery Low under Windows.

Immediately save your data upon Battery Low. The remaining operating time depends on how you are using the computer. If you are using the audio subsystem, hard or floppy disk drives, the battery might run out of charge very quickly.

Always respond to Battery Low by placing your computer on Standby or Hibernation mode, turning off the computer, or connecting the AC or car adapter.

If you do not take any action and after a couple of warning beeps, the computer will automatically hibernate and turn off.

**CAUTION:** If you fail to save your data when the battery completely runs out of charge, then you lose your data.

# Power Management

Your computer supports ACPI (Advanced Configuration and Power Interface) for power management. The power management feature allows you to reduce the power consumption for energy saving.

With an ACPI-compliant operating system such as Windows 2000 and Windows XP, power supply to different computer components is controlled on an as-needed basis. This allows maximum power conservation and performance at the same time.

In general, Windows' power management works in this way:

What...	When...
Power to the hard disk is turned off	When the hard disk has been idle for a set period.
Power to the display is turned off	When the display has been idle for a set period.
The computer enters Standby mode. The hard disk and display are turned off and the entire system consumes less power.	When the entire system has been idle for a set period.
	When you press Fn+F10. *
	When you close the cover. *
The computer enters Hibernation mode. (See the next subsection for more information.)	When you press the power button. *
	When you press Fn+F10. *
	When you close the cover. *

\* depends on your settings in Windows.

For detailed information on power management, see Windows' Help.

## Hibernation

Hibernation is a very useful feature. People frequently open many applications when they use computers. It takes some time to get all these applications open and running, and normally they all have to be closed before the system can be turned off.

When you use the hibernation feature, you do not have to close the applications. The computer stores the state of your computer to a file on the hard disk and then shut down. The next time you turn on your computer, you return to exactly where you left off.

## Power-Saving Tips

In addition to your computer's automatic power management, you can do your part to maximize the battery's operating time by following these suggestions.

- Do not disable Power Management.
- Decrease the LCD brightness to the lowest comfortable level.
- Disable the parallel and serial ports if no devices are connected to these ports. (See "Components Menu" in Chapter 5.)
- If you work with an application that uses the serial port, exit the application when you finish using it.
- Turn off the computer when you are not using it.



# *Expanding Your Computer*

You can expand the capabilities of your computer by connecting other peripheral devices. When using a device, be sure to read the instructions accompanying the device together with the relevant section in this chapter.

This chapter gives guidelines on installing and using these devices:

- External monitor
- USB device
- Serial device
- IR and Bluetooth-capable devices
- IEEE 1394 device
- Video capture device

## Connecting an External Monitor

If you want the benefits of a larger display screen with higher resolution, you can connect an external CRT monitor to your computer.

Follow this procedure to connect an external monitor:

1. Make sure that the computer is not turned on.
2. Plug the monitor's signal connector to the computer's DVI-I port.



3. Plug one end of the monitor's power cord into the power socket on the monitor and the other end to an electrical outlet.
4. To use the monitor, turn on the monitor before turning on the computer.
5. The monitor should respond by default. If not, you can switch the display to the monitor or to both (simultaneous display), or to multi-display by pressing **Fn+F9**. In Windows, you can also change the display through the settings in **Display Properties**.
6. You can change display settings through your operating system. See your operating system documentation or online help for specific information.

**CAUTION:** Do not disconnect the external monitor while the computer is in Standby mode or Hibernation mode. If no external monitor is connected when the computer resumes, the LCD remains blank and the output is not displayed.

## Connecting a USB Device

**NOTE:** To take advantage of the USB 2.0 feature, the USB 2.0 driver supplied with your computer must be installed (see chapter 6).

Your computer has four USB ports that supports transfer rates up to 12 MB/s for USB 1.1 devices and 480 MB/s for USB 2.0 devices, such as digital camera, scanner, printer, modem, and mouse.

USB is specified to be an industry standard extension to the PC architecture. It supports “Plug-and-Play” technology so you can install and remove USB devices without turning off the computer. With its multiple connection capability, up to 127 devices can be connected in a daisy-chain configuration. In addition, you can use a USB hub that converts a single USB connector into multiple ports where USB devices can be connected.

To connect a USB device, simply plug the device cable to one of the USB ports.





## Connecting a Serial Device

Your computer has a serial port for connecting a serial device such as an external modem.

Follow this procedure to connect a serial device:

1. Make sure the “COM1 Ports” item is set properly in the SCU program. (See “Components Menu” in Chapter 5 for information.)
2. Make sure the computer is not turned on.
3. Plug the device cable to the serial port on the rear of the computer.
4. Turn on the computer.



**NOTE:** Portable modems that derive power through the serial port cannot be used with the computer. Instead, use a modem that is powered by its own internal battery or external AC power.

## Connecting an IR or Bluetooth-compliant Device

**NOTE:** To take advantage of the Bluetooth feature, the Bluetooth driver supplied with your computer must be installed (see chapter 6 for details).

Your computer has an IR (infrared) / Bluetooth port for connecting an infrared-equipped / Bluetooth-compliant device wirelessly such as another computer, printer, or PDA (Personal Digital Assistant).

Follow this procedure to connect an IR device:

1. Under Windows, make sure that the IrDA Fast Infrared Port is set to HP HSDL-2300/3600. (See “How to Use the CD” in Chapter 6 for information.)
2. Make sure that the “COM Ports” and its “Mode Setting For COM2” items are set properly in the SCU program. (See “Components Menu” in Chapter 5 for information.)
3. When using the IR port:  
Place the transmitting device where its IR port faces the IR port of your computer within the effective range – within  $\pm 20$ -degrees vertical angle and within  $\pm 20$ -degrees horizontal angle at no greater than 0.8~1.0 meter distance.  
Place the receiving device where the IR port of your computer faces its IR port within the effective range – within  $\pm 15$ -degrees vertical angle and within  $\pm 15$ -degrees horizontal angle at no greater than 0.8~1.0 meter distance.
4. To take advantage of the IR/Bluetooth communications, you need a third party software.

**NOTES:** During infrared/Bluetooth communication, take note of the following:

- Do not move the computer and IR/Bluetooth device.
- Do not enter Standby mode.
- Do not use a cell phone or another IR device near the computer.
- Avoid strong light such as sunlight or fluorescent light.
- Disable the screen saver.



## Connecting an IEEE 1394 Device

Your computer has an IEEE 1394 port on the right side of the computer for connecting 1394 devices.

IEEE 1394 is the next-generation serial bus standard, featuring high-speed data transfer, multi-channel communication link, and “Hot Plug” connectivity. It allows connection of up to 63 devices. The applications include not only computer peripheral devices such as scanner, printer and high-quality CCD, but also consumer electronic equipment such as DVCAM and VCR.

To connect an 1394 device, simply plug the device cable to the IEEE 1394 port of the system.



## Connecting a Video Capture Device

**NOTE:** To take advantage of the AV input port, the Video Capture driver supplied with your computer must be installed (see chapter 6 for details).

Your computer has an AV input port on the rear of the computer for connecting a video capture device such as high-quality CCD, as well as consumer electronic equipment such as DVCAM and VCR.

To connect a video capturing device, simply plug the device cable to the AV input port (conexant 878A PCI; BNC-type) of the system.



*Connect to video capture device*

## System Memory Upgrade

You can upgrade your computer by changing system memory to a maximum of 1 GB on the two 200-pin PC2100 DDR SO-DIMM slots. However, to avoid damage during the installation procedure, please ask your dealer for help.



## ***Setup Configuration Utility (SCU)***

SCU is a program for configuring the BIOS (Basic Input/Output System) settings of the computer.

BIOS is a layer of software, called firmware, that translates instructions from other layers of software into instructions that the computer hardware can understand. The BIOS settings are needed by your computer to identify the types of installed devices and establish special features.

This chapter tells you how to use the SCU program.



# When and How to Use the SCU Program

## When to Use

You need to run the SCU program when:

- You see an error message on the screen requesting you to run Setup.
- You want to restore the factory default settings.
- You want to modify some specific settings according to the hardware.
- You want to modify some specific settings to optimize system performance.

## Starting SCU

### NOTES:

- The Setup screens shown in this chapter are for your reference only. The actual items or settings on your computer may differ.
- The Setup program may have been updated after the publication of this manual.
- The settings you select in your operating system might override similar settings in Setup.

To run SCU, press F2 when the prompt appears in the lower left corner of the screen during system startup. The prompt shows up on the screen for only a few seconds. You must press F2 quickly. The SCU menu appears as shown next.

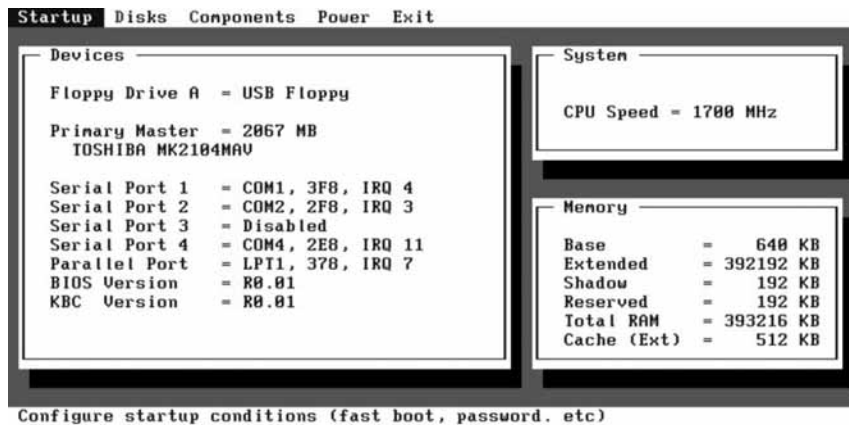

The menu can be divided into four areas:

- On the top line is the menu bar containing the titles of the available menus. Each menu title brings a specific menu.
- The center left column of the menu contains information regarding the current settings of the system. If you open a pull-down menu and select an item that provides multiple options, the left column will display a submenu where you can make further selections.
- The right column of the menu contains details of the CPU and system memory.
- The bottom lines of the menu provide keyboard instructions for moving around and making selections. When a menu item is highlighted, more detailed information is given.

## Moving Around and Making Selections

A brief description of keyboard usage is listed next:

Key	Function
←, →	Selects a menu title.
↑, ↓	1) Selects an item or option. 2) Brings up/down the value.
Enter	1) Brings up the sub-menu when available. 2) Opens or closes the options window when an item is selected.
Tab	Jumps from one item to another.
Esc	1) Exits the SCU program. 2) Returns to the previous menu if in a sub-menu. 3) Closes the options window if one is open.

**NOTE:** You are advised to use the mouse (if installed) as it is more straightforward than using the keyboard.

# Startup Menu

The Startup menu contains the basic configuration setting of the system, the sequence of the devices to be searched for the operating system, and a security setting that safeguards your system against unauthorized use.

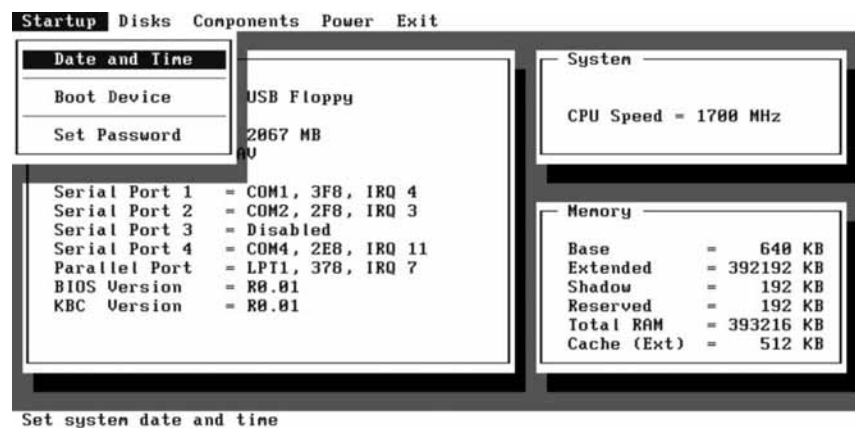

## Date and Time

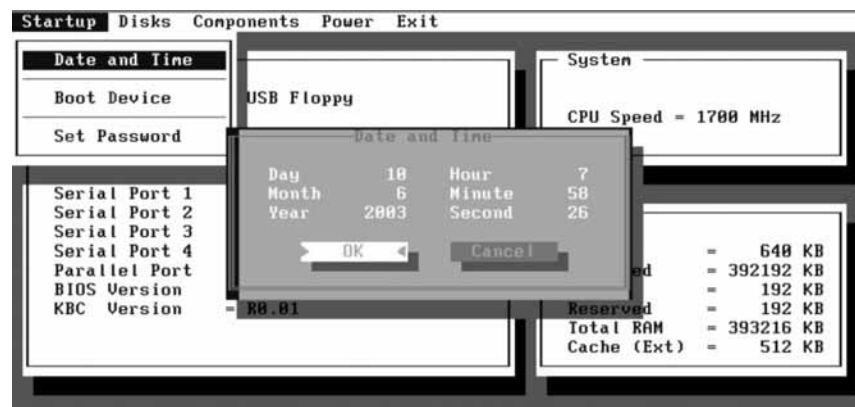

Sets the system time (Hour, Minute, Second) and date (Month, Day, Year).

## Boot Device

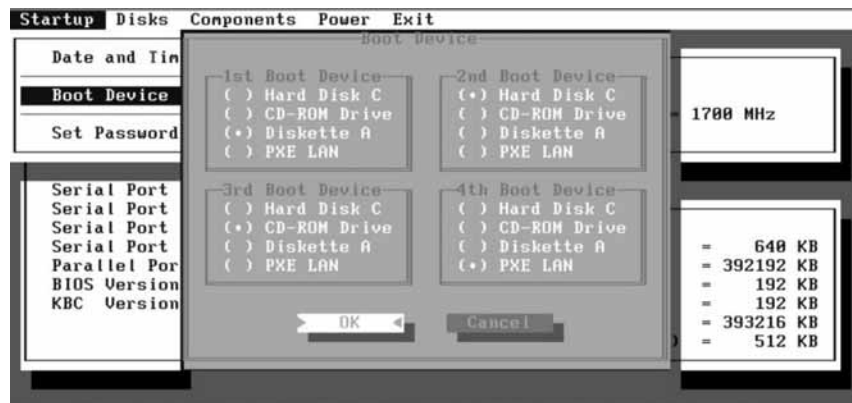

Press <Tab> key to select a control. <OK> button or <Enter> key accept entries. <Cancel> button or <Esc> key reject entries. Use cursor, spacebar, and numeric keys to change values. <Alt> key activates accelerators.

Sets the first, second, third, and fourth booting device. The system will try to boot from the first device but if it is not available, will try the next boot device. If you set the first boot device to *PXE LAN*, the system will boot from the LAN server first. The options are *Hard Disk C*, *CD-ROM Drive*, *Diskette A*, and *PXE LAN*. The default setting is *Diskette A*, *Hard Disk C*, *CD-ROM Drive*, then *PXE LAN*.

**NOTE:** If you set all booting options to the same device, then the computer will try to boot from that device only.

## Set Password



Allows you to set the password for your system. When typing the password, first make sure that Num Lk is off, then type your password in the entry fields and press Enter. Confirm your password by typing it again and pressing Enter.

## Disks Menu

The Disks menu contains a security setting that safeguards your system against viruses.

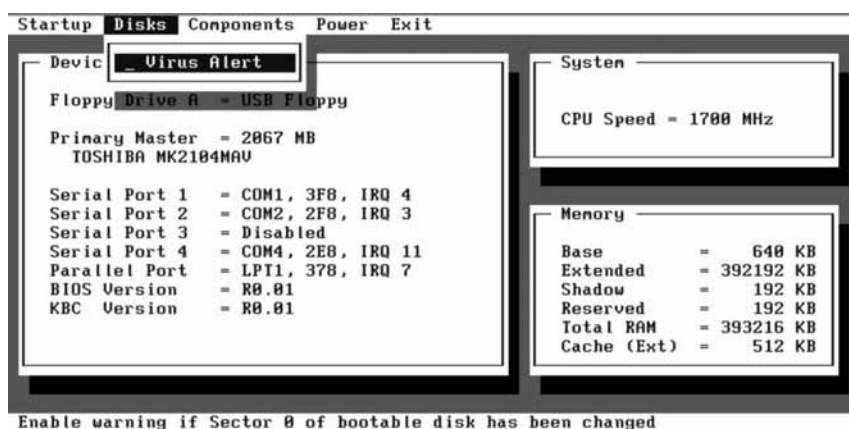

### Virus Alert

Sets if a warning message will appear when the hard disk boot sector (partition table) has been changed. A checkmark (✓) indicates enabled, while an underline (⎵) indicates disabled. The default setting is disabled.

**CAUTION:** Set this item to disabled before installing an operating system, running `Fdisk` or `Format` program. Otherwise, the intended action will fail.

# Components Menu

The Components menu contains a security setting that safeguards your system against viruses.

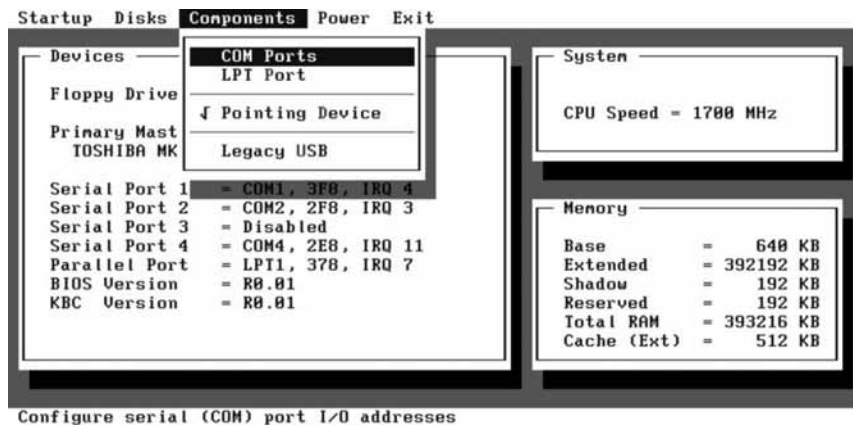

## COM Ports





Allows you to configure the IR port of the computer.

**COM1/2/3/4 Settings** sets the I/O (Input/Output) address and the Interrupt ReQuest line (IRQ) settings of the IR port. The options are *Disabled*; *COM1, 3F8, IRQ4*; *COM2, 2F8, IRQ3*; *COM3, 3E8, IRQ6*; *COM4, 2E8, IRQ11*.

**Mode Setting for COM2** sets the communication compatibility mode according to the type of the IR device to be connected. The options are *IrDA (HPSIR)* and *Fast IR*. The default setting is *Fast IR*. This item is not valid for setting if the **COM1/2/3/4 Settings** item is set to *Disabled*.

**DMA Setting For Fast IR** sets the DMA (Direct Memory Access) channel of the IR port in Fast IR mode. The options are *DMA 0*, *DMA 1*, and *DMA 3*. Default setting is *DMA 0*. This item is not valid for setting if the **Mode Setting for COM2** item is set to *IrDA (HPSIR)*.

**Pointing Device** enables or disables the touchpad. A checkmark (✓) indicates enabled, while an underline ( ) indicates disabled. The default setting is disabled.

## LPT Port

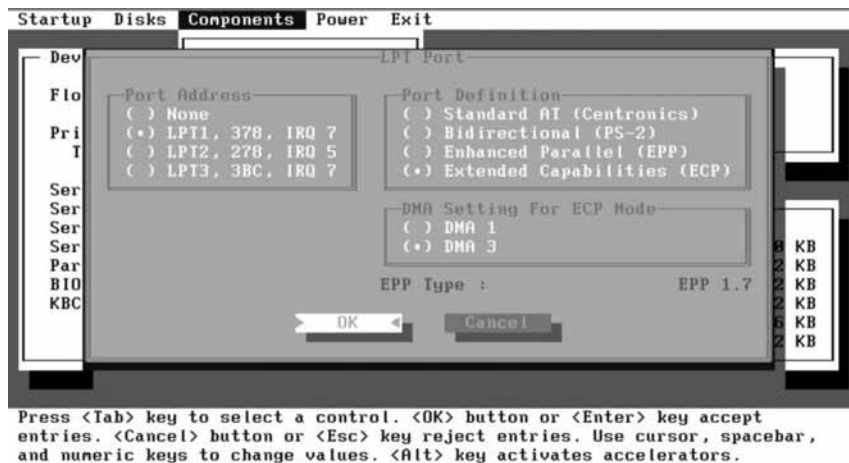

This item configures the parallel port of the computer.

**Port Address** sets the I/O address and the interrupt request line settings of the parallel port. The options are *None*; *LPT1, 378, IRQ 7*; *LPT2, 278, IRQ 5*; and *LPT3, 3BC, IRQ 7*. Default setting is *LPT1, 378, IRQ 7*.

**Port Definition** sets the operating mode for the parallel port according to the type of the parallel device to be connected. Your system supports EPP (Enhanced Parallel Port) and ECP (Extended Capabilities Port) standards, which turn the standard parallel port into a high-speed bi-directional peripheral port. The options are *Standard AT (Centronics)*, *Bidirectional (PS-2)*, *Enhanced Parallel (EPP)*, and *Extended Capabilities (ECP)*. Default setting is *Extended Capabilities (ECP)*. This item is not valid for setting if the **Port Address** item is set to *None*.

**DMA Setting For ECP Mode** sets the DMA (Direct Memory Access) channel of the ECP mode. The options are *DMA 1* and *DMA 3*. Default setting is *DMA 3*. This item is not valid for setting if the **Port Definition** item is not set to *Extended Capabilities (ECP)*.

## Legacy USB

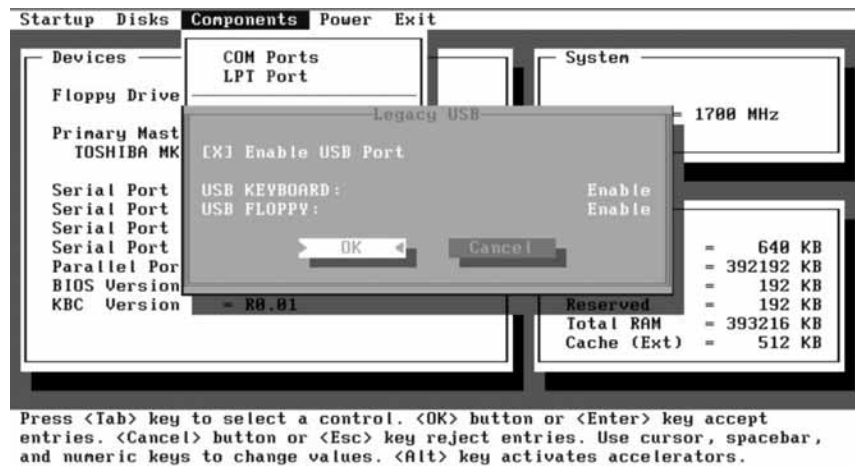

This item enables or disables the system's support for the USB port in DOS mode.

The **Enable USB Port** sub-item enables or disables the USB port in DOS mode. The options are enable and disable. A [X] mark indicates enable, while blank [ ] indicates disable. Default setting is enable.

The **USB Keyboard** sub-item enables or disables the USB keyboard in DOS mode. The options are *Enable* and *Disable*. Default setting is *Enable*. This item is not valid for setting if the **Enable USB Port** sub-item is disabled.

The **USB Floppy** sub-item enables or disables the USB floppy drive in DOS mode. The options are *Enable* and *Disable*. Default setting is *Enable*. This item is not valid for setting if the **Enable USB Port** sub-item is disabled.

## Exit Menu

The Exit menu allows you to leave the SCU program. After finished with your settings, you must save and exit so that the new settings can take effect.

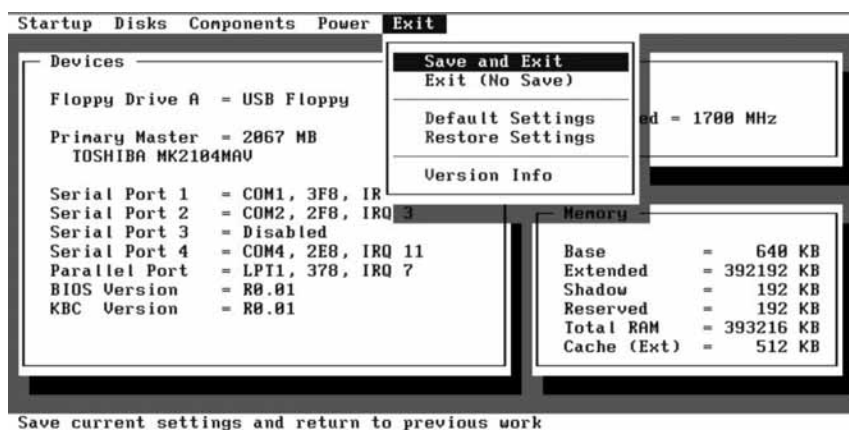

**Save and Exit** saves the changes you have made and exit the SCU program.

**Exit (No Save)** exits the SCU program without saving the changes you have made.

**Default Settings** loads factory default values for all the items.

**Restore Settings** restores previous values for all the items.

**Version Info** displays the BIOS version information.



## *Installing Software Drivers*

To take full advantage of the unique features of your computer, some operating systems require custom software, known as drivers, to be installed.

If you purchased the computer with Windows pre-installed, your dealer may have already installed the drivers. If not, you need to install the drivers using the CD supplied with your computer.

This chapter describes how to install the drivers.

## How to Use the CD

### NOTES:

- The drivers may have been updated after this manual was published. For driver upgrade, please contact your dealer.
- You can always find `README` or document files on the CD. These files contain the latest information from the software supplier. Please read the files together with this chapter.
- This CD supports Windows 2000 and Windows XP only.
- The available items may differ according to your computer model and operation system.

An autorun program is provided on the driver CD to help you easily install the drivers. As you insert the CD, the autorun program automatically starts. If you need to start the program manually, run the **Autorun.exe** program from the Setup directory of the CD.

The main screen appears as shown next:



## Installing Drivers for Windows 2000

To set up the necessary drivers for Windows 2000, click on “Windows 2K” on the initial screen. The following screen appears:

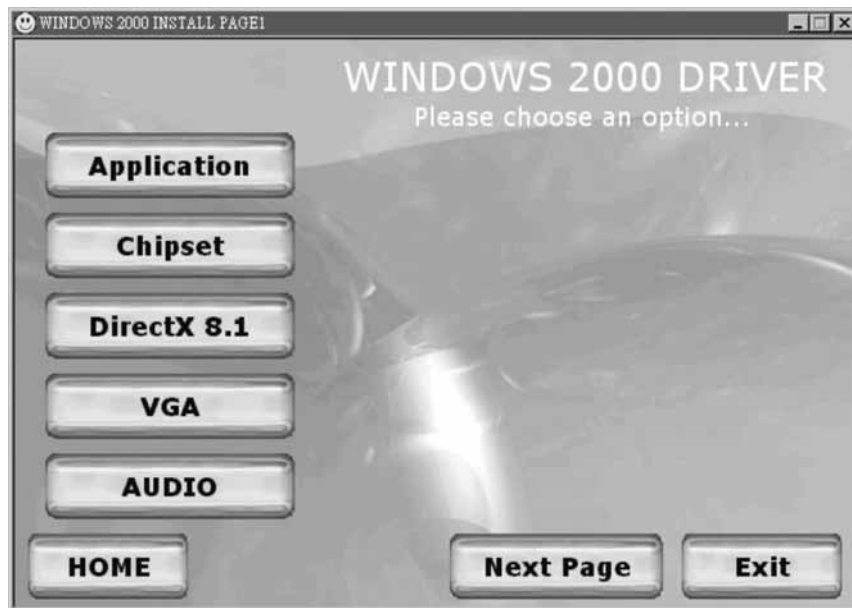

To install the necessary driver, just click on the particular option and follow the onscreen instructions to continue and complete installation.

- |                    |  |
|--------------------|--|
| <i>Application</i> | Installs the Intel® Application Accelerator to improve performance of the storage sub-system and overall system performance. This software delivers improved performance through several ingredient technologies (components). |
| <i>Chipset</i>     | Ensures the full function of the following drivers. Install this main chipset driver before installing the device drivers.   |
| <i>DirectX 8.1</i> | Allows you to take full advantage of the multimedia applications.  |



- VGA* Allows you to select high-resolution displays with richer colors. It can drive LCD displays as well as CRT displays.
- Audio* Allows you to take full advantage of the audio subsystem.

Upon clicking “Next Page,” the following screen appears:



- USB 2.0* Allows your system to connect to USB 2.0 devices.
- LAN* Allows you to use the network function of the computer.
- Touchpad* Allows you to take full advantage of the touchpad features.
- Touchscreen* Allows you to use your fingers as a pointing device (refer to the next section for further instructions).
- PCI-952* Installs the PCI to serial device driver that allows you to connect devices that uses a serial connection. You can use GPS technology and wireless modem to transmit information wirelessly.

**NOTE:** An extensive on screen instructions is provided, follow the steps outlined to install the driver.

Upon clicking “Next Page,” the following screen appears:

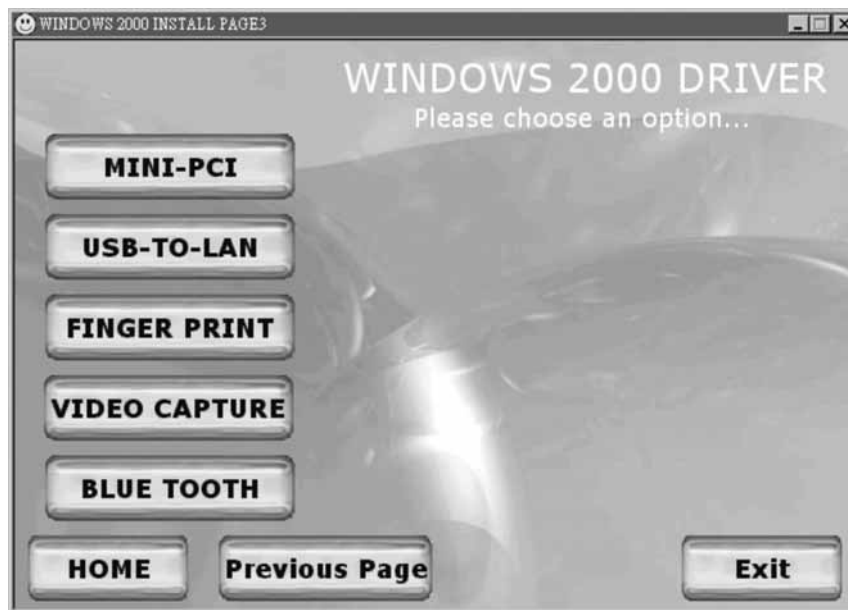

*Mini-PCI*            Installs the WLAN driver allows you to use the internal Mini PCI WLAN card.

**NOTE:** An extensive on screen instructions is provided, follow the steps outlined to install the driver.

*USB-to-LAN*        Allows you to use the network function of the computer through the optional docking station (if connected).

*Fingerprint*        Allows you to use the fingerprint recognition system and its application software.

**NOTE:** An extensive on screen instructions is provided, follow the steps outlined to install the driver and utility.

*Video Capture*    Allows you to connect a video capture device through the AV input port.

**NOTE:** An extensive on screen instructions is provided, follow the steps outlined to install the driver.

*Bluetooth*            Allows you to use the bluetooth port to connect to bluetooth-compliant devices.

## Touchscreen Driver

To install the touch screen driver, perform the following:

1. Insert the driver CD into the drive.
2. Click on “Windows 2K”, then “Touchscreen” and follow the onscreen instructions to continue.
3. When finished installing, select “Yes” to reboot your system. The driver should now be loaded.
4. After the system has finished rebooting, click on the “PenMount Monitor” icon located on the taskbar to bring up the “PenMount Control Panel”.
5. Select the “Standard Calibrate” folder and click on “OK.”
6. Click on “Advanced Calibrate” button.
7. Click on the four sides (points) and the plus-sign “+” on the screen to calibrate your touchscreen for use on the computer.

## Installing Drivers for Windows XP

To set up the necessary drivers for Windows XP, click on “Windows XP” on the initial screen. The following screen appears:



To install the necessary driver, just click on the particular option and follow the onscreen instructions to continue and complete installation.

- |                    |  |
|--------------------|--|
| <i>Application</i> | Installs the Intel® Application Accelerator to improve performance of the storage sub-system and overall system performance. This software delivers improved performance through several ingredient technologies (components). |
| <i>Chipset</i>     | Ensures the full function of the following drivers. Install this main chipset driver before installing the device drivers.   |
| <i>VGA</i>         | Allows you to select high-resolution displays with richer colors. It can drive LCD displays as well as CRT displays.   |

*Audio* Allows you to take full advantage of the audio subsystem.

*USB 2.0* Allows your system to connect to USB 2.0 devices.

Upon clicking “Next Page,” the following screen appears:



*Touchpad* Allows you to take full advantage of the touchpad features.

*Mini-PCI* Installs the WLAN driver allows you to use the internal Mini PCI WLAN card.

**NOTE:** An extensive on screen instructions is provided, follow the steps outlined to install the driver.

*PCI-952* Installs the PCI to serial device driver that allows you to connect devices that uses a serial connection. You can use GPS technology and wireless modem to transmit information wirelessly.

**NOTE:** An extensive on screen instructions is provided, follow the steps outlined to install the driver.

*Touchscreen* Allows you to use your fingers as a pointing device (refer to the next section for further instructions).

Upon clicking “Next Page,” the following screen appears:

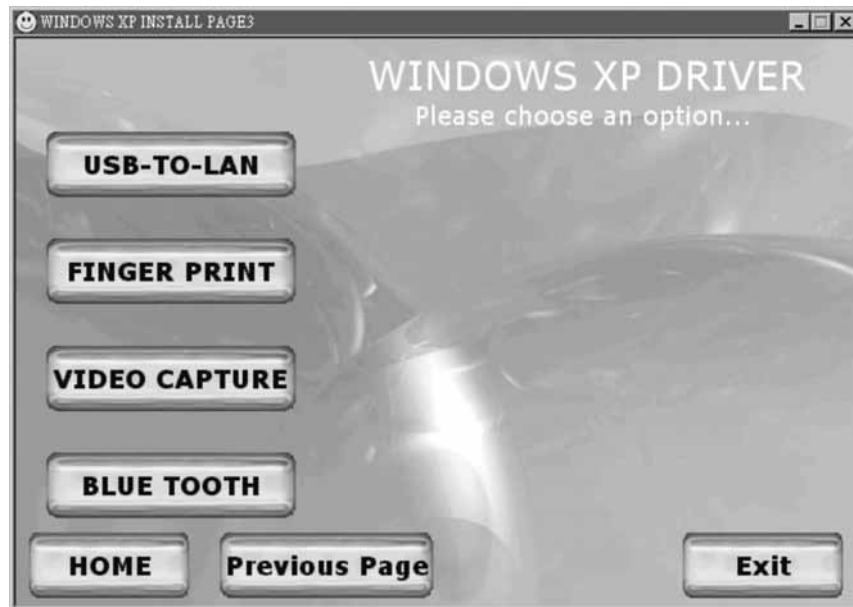

*USB-to-LAN* Allows you to use the network function of the computer through the optional docking station (if connected).

*Fingerprint* Allows you to use the fingerprint recognition system and its application software.

**NOTE:** An extensive on screen instructions is provided, follow the steps outlined to install the driver and utility.

*Video Capture* Allows you to connect a video capture device through the AV input port.

**NOTE:** An extensive on screen instructions is provided, follow the steps outlined to install the driver.

*Bluetooth* Allows you to use the bluetooth port to connect to bluetooth-compliant devices.

## Touchscreen Driver

To install the touchscreen driver, perform the following:

1. Insert the driver CD into the drive.
2. Click on “Windows XP”, then “Touchscreen” and follow the onscreen instructions to continue.
3. Click on ”Start,” then “Control Panel.”

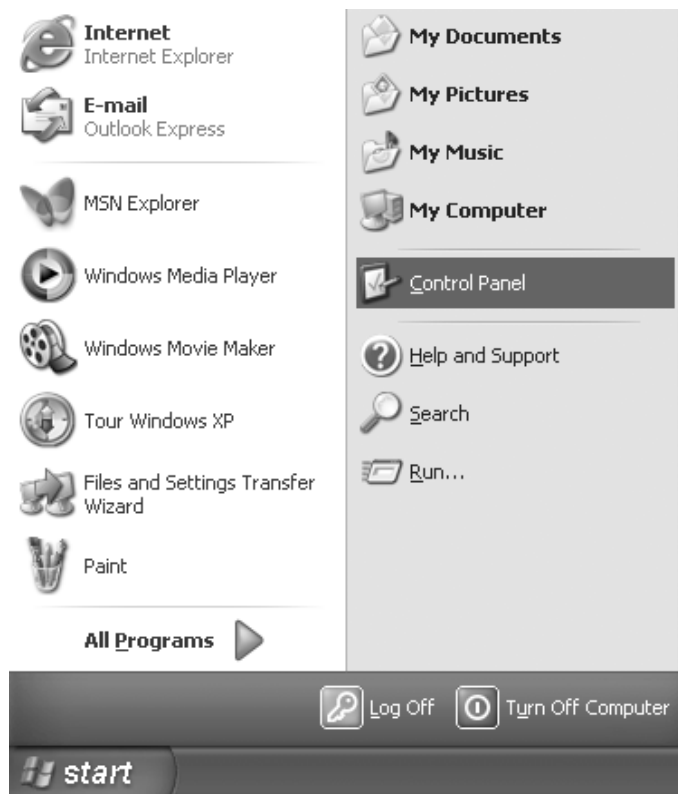

4. Click on the “Performance and Maintenance” category.

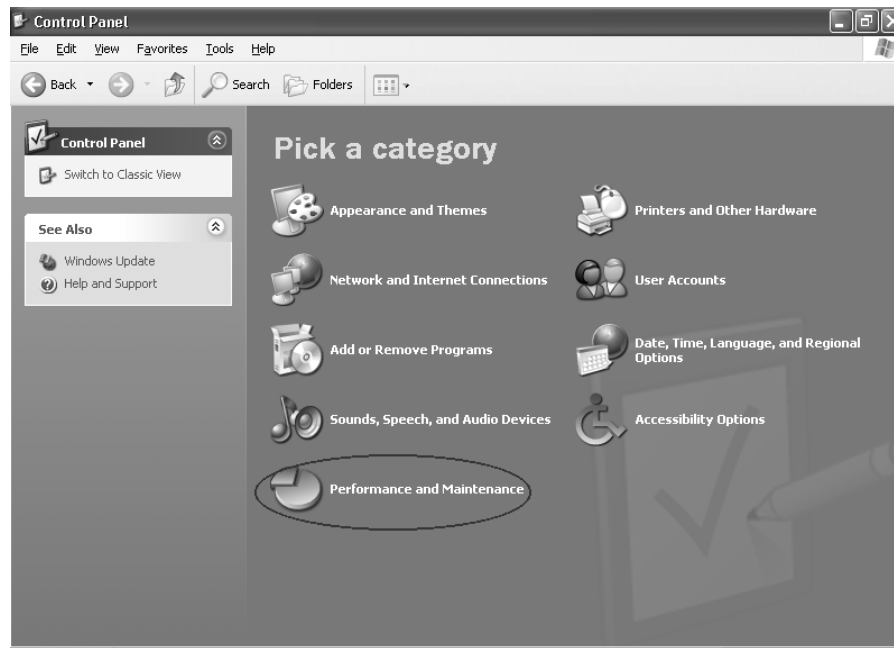



5. Click on “System.”

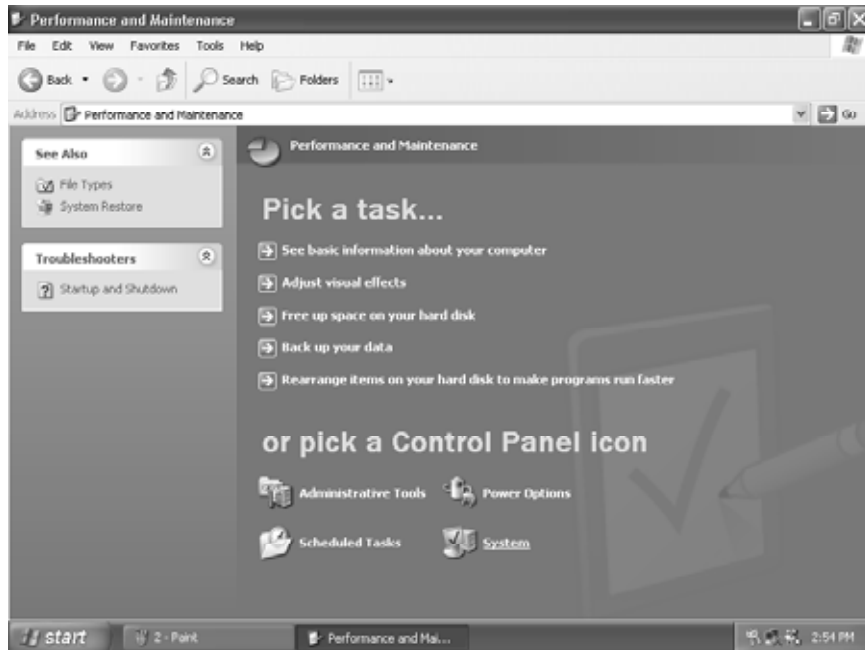

6. Click on “Hardware” folder, then click on “Device Manager.”

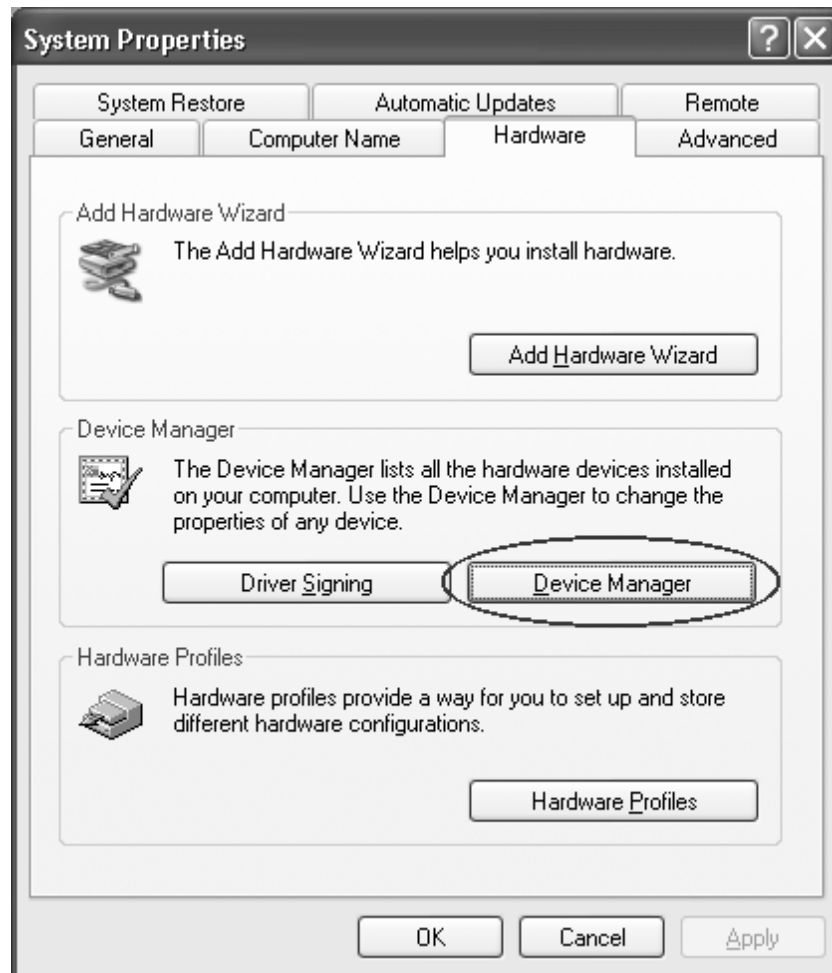

7. Click on “? Unknown device,” then click on the “Properties” icon.

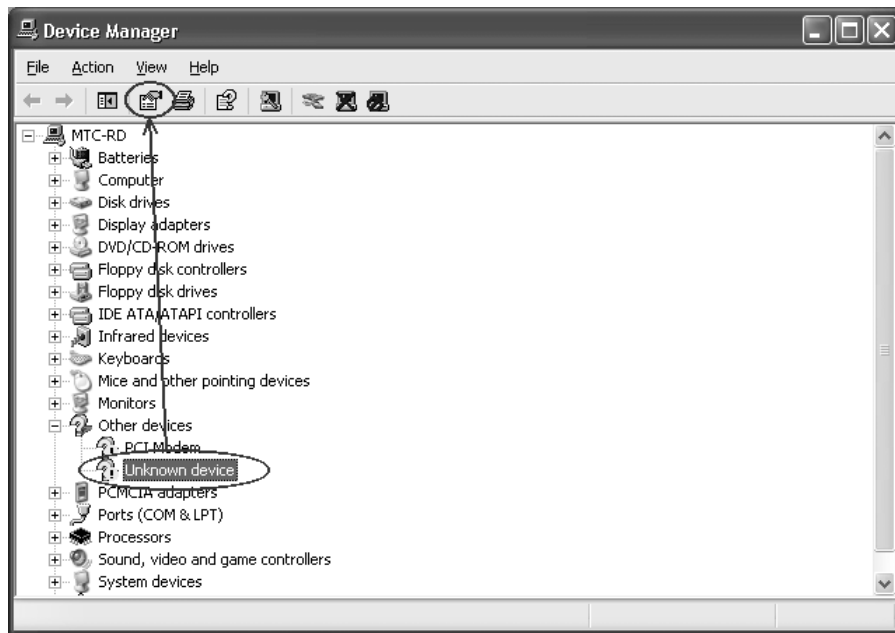

8. Click on “Reinstall Driver.”

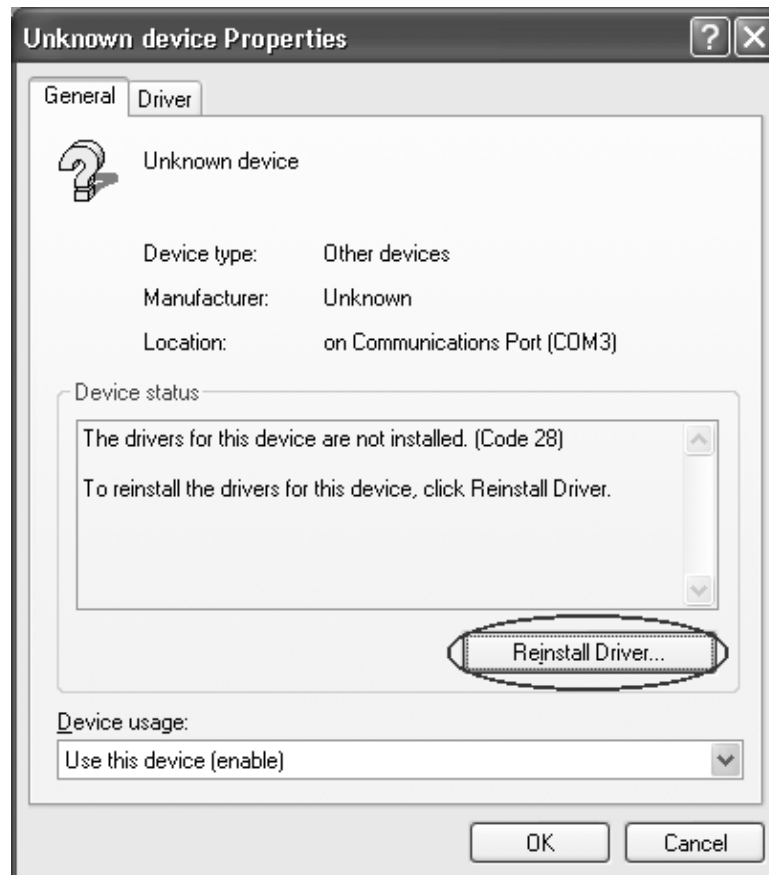

9. When the “Hardware Update Wizard” appears, select “Install the software automatically [Recommended],” then click on “Next.”

10. Click on “Continue Anyway.”



11. Click on “Finish.”



12. When the “PenMount DMC9000 and DMC9100 Properties” screen appears, click on “Close” to exit the driver installation.



## Touchscreen Utility

To install the touchscreen utility, perform the following:

1. Insert the driver CD into the drive.

2. Click on “Start”, then “Run.”

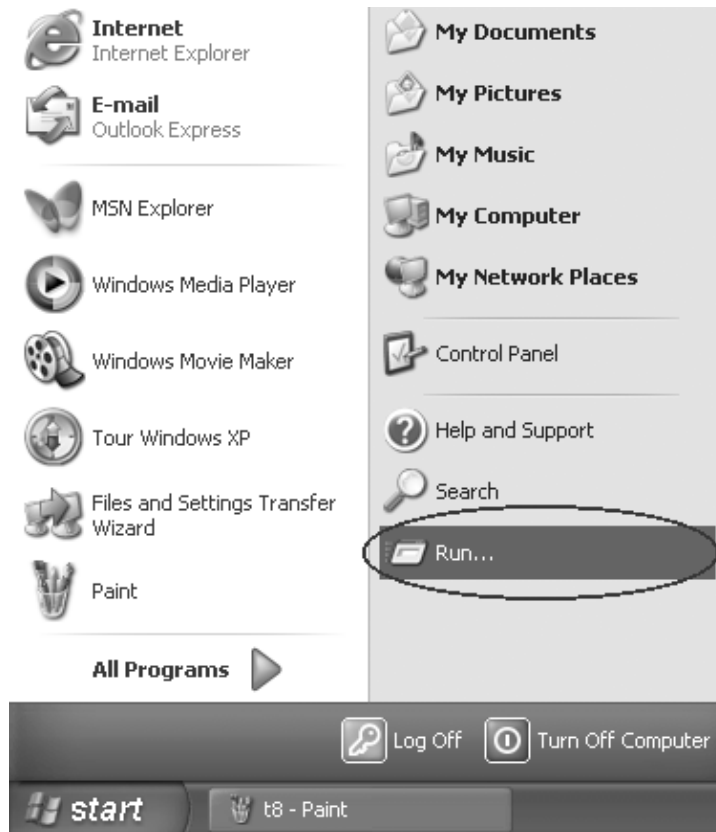

3. Enter the following directory on the driver CD: **\TSRC\Setup.exe**, then click on “OK.”
4. Select “Yes” to the question if this is the first time to run this setup.
5. When the “InstallShield Wizard” appears, click on “Next” to continue.
6. Select “I accept the terms in the license agreement,” then click on “Next.”
7. When the “Ready to Install the Program” screen appears, click on “Next” to continue.
8. Reboot the system.





## ***Caring for the Computer***

Taking good care of your computer will ensure a trouble-free operation and reduce the risk of damage to your computer.

This chapter gives you guidelines covering these areas of maintenance:

- How to protect the computer
- What to note when using and storing the computer
- How to clean the computer
- What to note when using the battery pack
- What to note when traveling with the computer

## Protecting the Computer

To safeguard the integrity of your computer data as well as the computer itself, you can protect the computer in several ways as described in this section.

### Using the Password

The power-on password protects your computer against unauthorized use. If the password is set, the prompt requesting for the password appears on the screen whenever the computer is turned on.

The password is set via the SCU program. See “Startup Menu” in Chapter 5 for instructions.

### Using an Anti-Virus Strategy

New viruses are always being developed nowadays and they are attacking computers even more easily with emails so commonly used worldwide.

The Security feature of the SCU program protects the boot sector of the hard disk. To enable the function, see “Disks Menu” in Chapter 5 for instructions.

You can also install a virus-detecting program to monitor potential viruses that could damage your files.

# Taking Care of the Computer

## Location Guidelines

- Use the computer where the temperature is between 0 °C (32 °F) and 50 °C (122 °F).
- Avoid placing the computer in a location subject to high humidity, extreme temperatures, mechanical vibration, direct sunlight, or heavy dust.
- Do not cover or block any ventilation openings on the computer. For example, do not place the computer on a bed, sofa, rug, or other similar surface. Otherwise, overheating may occur that results in damage to the computer.
- Keep the computer at least 13 cm (5 inches) away from electrical appliances that can generate a strong magnetic field such as a TV, refrigerator, motor, or a large audio speaker.
- Do not move the computer abruptly from a cold to a warm place. A temperature difference of more than 10 °C (18 °F) will cause condensation inside the unit, which may damage the storage media.
- Do not place the computer on an unsteady surface.

## General Guidelines

- Do not place heavy objects on top of the computer as this may damage the display.
- The screen surface is easily scratched. Do not use paper towels to clean the display. Avoid touching it with a ballpoint pen or pencil.
- To maximize the life of the backlight in the display, allow the backlight to automatically turn off as a result of power management. Avoid using a screen saver or other software that prevents the power management from working.

## Cleaning Guidelines

- Never clean the computer with its power on.
- Use a soft cloth moistened with water or a non-alkaline detergent to wipe the exterior of the computer.
- Gently wipe the display with a soft, lint-free cloth. Do not use alcohol or detergent on the display.
- Dust on the IR/Bluetooth port can interfere with data transfer. Wipe the port with a soft, dry cloth.
- Dust or grease on the touchscreen can affect its sensitivity. Clean the touchscreen by using adhesive tape to remove the dust and grease on its surface.

## Battery Pack Guidelines

- Recharge the battery pack when it is nearly discharged. When recharging, make sure the battery pack is fully charged. Doing so may avoid harm to the battery pack.
- Operate the computer with the battery pack installed even when using external power. This ensures that the battery is fully charged.
- If you will not be using the computer for a long period of time (more than two weeks), remove the battery pack from the computer.
- If you remove the battery pack, make sure the battery terminals do not contact any conductors such as metal objects or water. Otherwise, the battery may become unusable as a result of a short circuit.
- If you need to store the battery pack, store it in a cool, dry place. Never allow the temperature to exceed 70 °C (158 °F).
- Do not leave the battery pack in storage for more than 3 months without recharging it.

## When Traveling

- Before traveling with your computer, make a backup of your hard disk data into floppy disks or other storage devices. As an added precaution, bring along an extra copy of your important data.
- Make sure the battery pack is fully charged.
- Make sure the computer is turned off.
- Do not leave objects that will press onto the display.
- Disconnect the AC adapter from the computer and take it with you. Use the AC adapter as the power source and as a battery-charger.
- Hand-carry the computer. Do not check it in as luggage.
- Allow extra time for airport security. Many airports inspect electronic devices carefully.
- If you need to leave the computer in the car, put it in the trunk of the car to avoid exposing the computer to excessive heat.
- When going through airport security, it is recommended that you send the computer and floppy disks through the X-ray machine (the device you set your bags on). Avoid the magnetic detector (the device you walk through) or the magnetic wand (the hand-held device used by security personnel).
- If you plan to travel abroad with your computer, consult your dealer for the appropriate AC power cord for use in your country of destination.



# *Troubleshooting*

Hardware, software, or a combination of both can cause computer problems. When you encounter any problem, it might be a typical problem that can easily be solved.

This chapter tells you what actions to take when solving common computer problems. It is divided into three sections:

- Preliminary checklist
- Solving common problems
- Resetting the computer



## Preliminary Checklist

Here are helpful hints to follow before you take further actions when you encounter any problem:

- Try to isolate which part of the computer is causing the problem.
- Make sure that you turn on all peripheral devices before turning on the computer.
- If an external device has a problem, make sure that the cable connections are correct and secure.
- Make sure that the configuration information is properly set in the SCU program.
- Make sure that all the device drivers are correctly installed.
- Make notes of your observations. Are there any messages on the screen? Do any indicators light? Do you hear any beeps? Detailed descriptions are useful to the service personnel when you need to consult one for assistance.

If any problem persists after you follow the instructions in this chapter, contact an authorized dealer for help.

## Solving Common Problems

For easy reference, the problems are divided into these categories.

<b>Problem Type</b>	<b>Go to</b>
Battery Problems	P. 8-4
CD R-W / DVD-Combo Drive Problems	P. 8-4
Display Problems	P. 8-5
Fingerprint Recognition Problems	P. 8-7
Hardware Device Problems	P. 8-7
Hard Disk Drive Problems	P. 8-8
Infrared Problems	P. 8-8
Keyboard, Mouse and Touchpad Problems	P. 8-9
LAN Problems	P. 8-9
WLAN Problems	P. 8-10
Modem Problems	P. 8-10
Power Management Problems (for Windows)	P. 8-12
Printer Problems	P. 8-12
Software Problems	P. 8-13
Sound Problems	P. 8-13
Startup Problems	P. 8-14
Other Problems	P. 8-15

## Battery Problems

**The battery does not charge (Battery Charge indicator does not light amber).**

- Make sure that the AC adapter is properly connected.
- Make sure that the battery is not too hot or cold. Allow time for the battery pack to return to room temperature.
- Make sure that the battery pack is installed correctly.
- Make sure that the battery terminals are clean.

**The operating time of a fully charged battery becomes shorter.**

- If you often partially recharge and discharge, the battery might not be charged to its full potential. Initialize the battery to solve the problem. (See “Initializing the Battery Pack” in Chapter 3 for instructions.)

**The battery operating time indicated by the battery meter does not match the actual operating time.**

- The actual operating time can be different from the estimated time, depending on how you are using the computer. If the actual operating time is much less than the estimated time, initialize the battery. (See “Initializing the Battery Pack” in Chapter 3 for instructions.)

## CD R-W / DVD-Combo Drive Problems

**The CD R-W / DVD-Combo drive cannot read a CD.**

- Make sure that the CD is correctly seated in the tray, with the label facing up.
- Make sure that the CD is not dirty. Clean the CD with a CD cleaning kit, available in most computer stores.
- Make sure that the CD R-W / DVD-Combo drive driver is installed correctly.
- Make sure that the computer supports the CD or the files contained.

### **You cannot eject a CD.**

- The CD is not properly seated in the drive. Manually release the CD following the method described next:
  1. Turn off the system.
  2. Insert a small rod, such as a straightened paperclip, into the drive's manual eject hole and push firmly to release the tray.
  3. Pull the tray out until fully extended, and then remove the CD.



## Display Problems

### **Nothing appears on the screen.**

- If the power-on indicator is not on, check the electrical outlet, the plugs and power cords.
- If the power button does not respond to a light touch, press the button firmly.
- If you are using battery power, make sure that it has a charge remaining and that it is installed correctly.
- During operation, the screen may automatically turn off as a result of power management. Press any key to see if the screen comes back.

- The brightness level might be too low. Increase brightness by pressing Fn+F6.
- The display output might be set to an external device. To switch the display back to the LCD, press Fn+F9, or change the display through the settings in **Display Properties**.
- Reset the computer by pressing the keyboard BIOS reset switch on the left side of the computer or by pressing Ctrl+Alt+Del keys.
- Try turning the computer off, wait for a few seconds, then turn it back on.

**The characters on the screen are dim.**

- Adjust the brightness and/or contrast.

**Bad dots appear on the display at all times.**

- A small number of missing, discolored, or bright dots on the screen are an intrinsic characteristic of TFT LCD technology. It is not regarded as a LCD defect. The Inspection Standard generally agreed in the LCD industry allows a maximum of 8 pixels on a unit.

**Term definition:**

*Bright dots* When the LCD screen is lighted, dots appear bright at a dark area. Red/green/blue bright dots also count.

*Dark dots* When the LCD screen is lighted, dots appear black at bright areas.

*Distance between defective dots* The minimum distance between two defective dots.

*Adjacent defective dots* Defective dots within a radius of 10 mm.

**Resolution cannot be adjusted to desired setting.**

- Make sure that the video driver is installed correctly.

**The external monitor displays nothing.**

- Make sure that the monitor is turned on.
- Make sure that the monitor's signal cable is properly connected.

- Switch the display to the monitor by pressing Fn+F9, or change the display through the settings in **Display Properties**.

**Simultaneous display/multi-display does not work.**

- Make sure that you turn on the external monitor before turning on the computer.
- Press Fn+F9 to toggle through the display options or change the settings in **Display Properties** in Windows.

## Fingerprint Recognition Problems

**The fingerprint recognition application does not work.**

- Make sure that the necessary driver is correctly installed.
- Make sure that your finger is properly placed on the surface of the sensor.

## Hardware Device Problems

**The computer does not recognize a newly installed device.**

- The device may not be correctly configured in the SCU program. Run the SCU program to identify the new type.
- Make sure if any device driver needs to be installed. (Refer to the documentation that came with the device.)
- Make sure if the device needs any jumper or switch settings. (Refer to the documentation that came with the device.)
- Check the cables or power cords for correct connections.
- For an external device that has its own power switch, make sure that the power is turned on.

## Hard Disk Drive Problems

### **The hard disk drive error message appears on the screen.**

- Insert a bootable diskette and check the integrity of your hard drive.
- The hard disk drive has defects. Ask your dealer for help.

### **The hard disk drive operations seem slow.**

- The data files stored on the hard disk drive may be fragmented. Use a tool such as Window's **Disk Defragmenter** to defragment the files.

### **The hard disk drive in-use indicator glows without blinking.**

- The data files stored on the hard disk drive may be fragmented. Use a tool such as Window's **Disk Defragmenter** to defragment the files.

## Infrared Problems

### **The IR port does not work.**

- Make sure that the IR ports of the two device face each other within a  $\pm 15$ -degrees angle and 1 meter (3 feet) distance and there are no obstructions in between.
- Make sure that the device connected is using an equivalent speed.
- Make sure that the IrDA Fast Infrared Port is set to HP HSDL-2300/3600.
- Make sure that the IR port is set correctly in the SCU program.
- If you are printing to an infrared printer, make sure that the appropriate driver is installed.
- If you are using any file transfer functions, make sure that both the computer and the IR device have the appropriate software running.
- Make sure that there is no device radiating infrared rays, such as remote-controlled devices or wireless headphones, near the computer or device.
- Make sure that no direct sunlight or fluorescent lamps are near the computer or device.

- Make sure that the IR ports are clean.

## Keyboard, Mouse and Touchpad Problems

### **The keyboard does not respond.**

- Try connecting an external keyboard. If it works, contact an authorized dealer, as the internal keyboard cable might be loose.

### **The numeric keypad is disabled.**

- Make sure that the Num Lk is switched on. (Check if the Num Lock Indicator  glows or not.)

### **The external keyboard does not work.**

- Make sure that the keyboard cable is properly connected.

### **The USB mouse does not work.**

- Make sure that the mouse cable is properly connected.

### **The touchpad does not work, or the pointer is difficult to control with the touchpad.**

- Make sure that the touchpad is clean.

## LAN Problems

### **I cannot access the network.**

- Make sure that the LAN driver is correctly installed.
- Make sure that the LAN cable is properly connected to the RJ-45 connector and the network hub.
- Make sure that the network configuration is appropriate.
- Make sure that the user name or password is correct.



## WLAN Problems

### **I cannot use the WLAN feature.**

- Make sure that the Mini PCI WLAN card is correctly installed.
- Make sure that the necessary driver(s) is correctly installed.
- Make sure that the WLAN feature is turned on.

### **Transmission quality is poor.**

- Your computer may be in an out-of-range situation. Move your computer closer to the Access Point or another WLAN device it is associated with.
- Check if there is high interference around the environment and solve the problem as described next.

### **Radio interference exists.**

- Move your computer away from the device causing the radio interference such as microwave oven and large metal objects.
- Plug your computer into an outlet on a different branch circuit from that used by the affecting device.
- Consult your dealer or an experienced radio technician for help.

### **I cannot connect to another WLAN device.**

- Make sure that the WLAN feature is turned on.
- Make sure that the SSID setting is the same for every WLAN device in the network.
- Your computer is not recognizing changes. Restart the computer.
- Make sure that the IP address or subnet mask setting is correct.

### **I cannot communicate with the computer in the network when Infrastructure mode is configured.**

- Make sure that the Access Point your computer is associated with is powered on and all the LEDs are working properly.

- If the operating radio channel is in poor quality, change the Access Point and all the wireless station(s) within the BSSID to another radio channel.
- Your computer may be in an out-of-range situation. Move your computer closer to the Access Point it is associated with.
- Make sure that your computer is configured with the same security option (encryption) to the Access Point.
- Use the Web Manager/Telnet of the Access Point to check whether it is connected to the network.
- Reconfigure and reset the Access Point.

**I cannot access the network.**

- Make sure that the necessary driver(s) is correctly installed.
- Make sure that the network configuration is appropriate.
- Make sure that the user name or password is correct.
- You have moved out of range of the network.
- Turn off power management.

## Modem Problems

**The modem does not work.**

- Make sure that the modem driver is correctly installed.
- Make sure that the COM port in the communication software is correctly set.
- Turn off power management.

## Power Management Problems (for Windows)

### **The computer does not enter Standby or Hibernation mode automatically.**

- If you have a connection to another computer, the computer does not enter Standby or Hibernation mode if the connection is actively in use.
- Make sure that the Standby or Hibernation time-out is enabled.

### **The computer does not enter Standby or Hibernation mode immediately.**

- If the computer is performing an operation, it normally waits for the operation to finish.

### **The computer does not resume from Standby or Hibernation mode.**

- The computer automatically enters Standby or Hibernation mode when the battery pack is empty. Do any one of the following:
  - Connect the AC adapter to the computer.
  - Replace the empty battery pack with a fully charged one.

### **The computer does not enter Hibernation mode with the Fn+F10 hot keys.**

- Make sure that the Hibernation function is specified for the sleep button.

## Printer Problems

### **The printer does not work.**

- Make sure that the printer is turned on (if it comes with an independent power source) and is online (ready to use).
- Make sure that the printer's signal cable is properly connected.
- Make sure that the printer driver is correctly installed.
- Make sure that you have assigned the printer port correctly in your operating system or application program.

- Make sure that the printer port is enabled in the SCU program.

**The printer prints garbled information.**

- Make sure that the printer driver is correctly installed.
- Make sure that the printer cable is properly connected.

## Software Problems

**An application program does not work correctly.**

- Make sure that the software is correctly installed.
- If an error message appears on the screen, consult the software program's documentation for further information.
- If you are sure the operation has stop, reset the computer. (See "Resetting the Computer" later in this chapter.)

## Sound Problems

**No sound is produced.**

- Make sure that the volume control is not set too low.
- Make sure that the audio driver is correctly installed.
- Make sure that the computer is not in Standby mode.
- If using an external speaker, make sure that the speaker is properly connected.

**Distorted sound is produced.**

- Make sure that the volume control is not set too high or too low. In most cases, a high setting can cause the audio electronics to distort the sound.

**The sound system does not record.**

- Adjust the playback or recording sound levels.

**The external microphone or audio device does not work.**

- Make sure that the microphone is connected to the proper connector on the computer.
- Make sure that your computer is equipped with the driver needed.
- Click the speaker symbol on the taskbar and check the Windows volume control.
- Check the volume control of your computer.

## Startup Problems

**When you turn on the computer, it does not respond and the Power Indicator does not light green.**

- If you are using an external AC power, make sure that the AC adapter is correctly and securely connected. If so, make sure that the electrical outlet works properly.
- If you are using the battery power, make sure that the battery is not discharged.

**When you turn on the computer, it stops after POST.**

- Restart your computer.

**The message “Operating system not found” appears on the screen after you turn on the computer.**

- Make sure that there is no floppy disk in the floppy disk drive. If there is, remove it and restart the system.
- If this message appears when you are booting from the hard disk, insert a bootable disk in the floppy disk drive and check the condition of the hard disk.
- Make sure that the hard disk is set correctly in the SCU program.

**The message “Invalid system disk” or “Disk error” appears on the screen after you turn on the computer.**

- If you are deliberately trying to boot from a floppy disk, replace the disk with a bootable one and press any key to continue booting.

- If you are booting from the hard disk, make sure that there is no floppy disk in the floppy disk drive. If there is, remove it and restart the system.
- If this message appears when you are booting from the hard disk, insert a bootable disk in the floppy disk drive and check the condition of the hard disk.
- Make sure that the hard disk is set correctly in the SCU program.

## Other Problems

### **The date/time is incorrect.**

- Correct the date and time via the operating system or SCU program.
- After you have performed everything as described above and still have the incorrect date and time every time you turn on the computer, the RTC (Real-Time Clock) battery is at the end of its life. Call an authorized dealer to replace the RTC battery.

## Resetting the Computer

You may have to reset (reboot) your computer on some occasions when an error occurs and the program you are using hangs up.

If the system operation seems to hang up, first wait. It is possible that the system is processing data. Periodically check the hard disk drive in-use indicator, if it flashes irregularly, the program may be accessing data and preventing you from using the keyboard. If you are sure the operation has stopped and you cannot use the “restart” function of the operating system, reset the computer.

Reset the computer by any one of these methods:

- Press Ctrl+Alt+Del.
- If the above action does not work, turn off the system. Wait for at least five seconds and turn it on again.
- If the above does not work, insert a small rod, such as a straightened paper clip, into the keyboard BIOS reset switch on the left side of the computer and press firmly.



*Keyboard BIOS  
reset switch*

**CAUTION:** Resetting will cause any unsaved data to be lost.

# Specifications

NOTE: Specifications are subject to change without any prior notices.

Parts		Specifications
CPU		Intel Mobile Pentium 4 Processor-M series microprocessor, $\mu$ -FCPGA package, 1.7 GHz; Front Side Bus (FSB) 400 MHz with SpeedStep function
Cache Memory		L2 512 KB on-die
ROM BIOS		512 KB Flash EEPROM, PC2001-compliant
RAM	System	Two 200-pin PC2100 DDR SO-DIMM sockets, maximum 1 GB (standard 256 MB)
	Video	64 MB (integrated DDR memory)
Display	Panel	12.1/13.3-inch TFT XGA LCD, resolution up to 1024×768, Touchscreen (option), Sunlight Readable Transflective display (option)
	Video controller	ATI M9-CSP64, 64 MB integrated into DDR memory, supports DirectX® 8.1 and OpenGL® 1.3, AGP 4X, dual view function, LCD/CRT simultaneous display capability
	Video port	DVI-I port (TMDS/RGB), AV input (Conexant 878A PCI; BNC-type)
Keyboard		Waterproof with membrane cover, standard keys, numeric keypad, 12 function keys, and Windows keys, rubber keyboard and backlight feature(option)
Pointing device		Four buttons touchpad with Microsoft Windows mouse function
Storage device	Hard disk drive	2.5-inch (9.5 mm height), IDE, Ultra DMA support, damper protection, built-in system heater for low temperature function (option)
	CD drive	Slim-type CD R-W drive DVD-Combo drive (DVD + CD R-W)
Audio	Audio controller	Realtek ALC202, AC97 codec Rev.2.2 support, two built-in 2-watts stereo speakers, Microsoft Windows Sound compatibility
	Audio port	Two audio ports for Mic-in / Line-out (supports S/P-DIF)



Parts		Specifications
I/O ports	On left side	IR port and Bluetooth port, Mic-in, Line-out
	On right side	IEEE 1394 port, two USB ports, RJ-11 fax/modem port
	On rear side	DVI-I port, serial port, docking port for Port Replicator / car mount, two USB ports, AV input port, AC-in
	On keyboard panel	Fingerprint recognition system
LAN		10/100Base-T
Wireless LAN		Mini PCI (option)
Wireless Modem		GSM/GPRS, iDEN, DataTAC, CDMA (option)
GPS		Easily removable M-Loc MPM (Trimble solution) – option
Power	AC adapter	Input: 100~240 V AC, 50~60 Hz auto-switching Output: 19 V DC / 120 W
	Battery	Smart Li-ion battery, 11.1 V / 6000 mAH, 9 cells
Dimension (W×D×H)		11.8×9.5×2.3 inch (300×241×58 mm)
Weight		8.8 lb (4 kg)
Environment	Temperature	Operating: 0 °C (32 °F) to 50 °C (122 °F) Storage: -40 °C (-40 °F) to 70 °C (158 °F)
	Humidity	Operating: 5 % to 95 % RH, non-condensing

## ***Fingerprint Recognition System***

Your system features a fingerprint recognition system that can:

- display fingerprint images derived from the sensor IC
- enroll new users
- extract fingerprint templates from raw images, and store them in a local database
- match live-scan fingerprints against the local database

## Finger Placement

When placing a finger to be enrolled or identified, slide the cover to expose the sensor matrix surface, then use a light, but firm and steady pressure.



Avoid moving your finger during the scan, and be sure that you are making contact with the “sensor matrix” and with the surrounding drive ring (the light-colored surface surrounding the matrix). The system works best when it has a “core” image (the center of your fingerprint, which is approximately opposite the line of the cuticle of your fingernail).

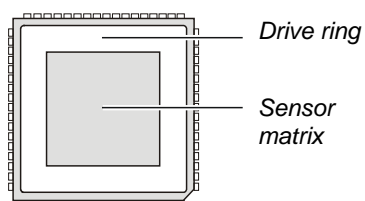

## Using the Application

**NOTE:** To take advantage of the fingerprint recognition system, the driver and utility supplied with your computer must be installed (see chapter 6 for details).

Double-click on the icon located on your Windows' system tray. The main menu appears.

The following program options are available:

- **Enroll** – allows the sensor IC to acquire fingerprint images, process it into the essential template data, and then insert it into the database together with an associated User ID and other optional information.
- **Identify** – is used to compare the finger presented to the sensor against all of the other fingerprints currently entered in the database (known as *one-to-many* search).
- **Validate ID** – is used to perform a *one-to-one* verification to ascertain if the person whose finger is placed on the sensor is in fact the same as the person enrolled under a particular User ID.
- **Data Capture** – a viewing facility that is used to display (or capture) a continuous series of real-time images of a fingerprint.
- **Database** – is used to review, delete, and otherwise manage the contents of the database.

**NOTE:** For an online Help information on using the application, click on "Help" located on the menu bar, then "**Aware User's Guide**."

A `Readme.txt` file is also located on your driver CD for late-breaking news, known bugs, work-arounds, and other additions, deletions, or discrepancies in the application program.



## Free Manuals Download Website

<http://myh66.com>

<http://usermanuals.us>

<http://www.somanuals.com>

<http://www.4manuals.cc>

<http://www.manual-lib.com>

<http://www.404manual.com>

<http://www.luxmanual.com>

<http://aubethermostatmanual.com>

Golf course search by state

<http://golfingnear.com>

Email search by domain

<http://emailbydomain.com>

Auto manuals search

<http://auto.somanuals.com>

TV manuals search

<http://tv.somanuals.com>