

Administrator's Handbook

Embedded Software Version 7.7.4

Motorola Netopia® 2200, 3300 and 7000 Series Gateways



Copyright

Copyright © 2007 by Motorola, Inc.

All rights reserved. No part of this publication may be reproduced in any form or by any means or used to make any derivative work (such as translation, transformation or adaptation) without written permission from Motorola, Inc.

Motorola reserves the right to revise this publication and to make changes in content from time to time without obligation on the part of Motorola to provide notification of such revision or change. Motorola provides this guide without warranty of any kind, either implied or expressed, including, but not limited to, the implied warranties of merchantability and fitness for a particular purpose. Motorola may make improvements or changes in the product(s) described in this manual at any time. MOTOROLA and the Stylized M Logo are registered in the US Patent & Trademark Office. Microsoft, Windows, Windows Me, and Windows NT are either trademarks or registered trademarks of Microsoft Corporation in the U.S and/or other countries. Macintosh is a registered trademark of Apple, Inc. Firefox is a registered trademark of the Mozilla Foundation. All other product or service names are the property of their respective owners.

Motorola, Inc.
6001 Shellmound Street
Emeryville, CA 94608
U.S.A.

Part Number

6161244-00-01

Copyright Acknowledgments

Because Motorola has included certain software source code in this product, Motorola includes the following text required by the respective copyright holders:

Portions of this software are based in part on the work of the following:

Copyright (c) 1998-2005 The OpenSSL Project. All rights reserved.

Redistribution and use in source and binary forms, with or without modification, are permitted provided that the following conditions are met:

1. Redistributions of source code must retain the above copyright notice, this list of conditions and the following disclaimer.
2. Redistributions in binary form must reproduce the above copyright notice, this list of conditions and the following disclaimer in the documentation and/or other materials provided with the distribution.
3. All advertising materials mentioning features or use of this software must display the following acknowledgment:
"This product includes software developed by the OpenSSL Project for use in the OpenSSL Toolkit.
(<http://www.openssl.org/>)"
4. The names "OpenSSL Toolkit" and "OpenSSL Project" must not be used to endorse or promote products derived from this software without prior written permission. For written permission, please contact openssl-core@openssl.org.
5. Products derived from this software may not be called "OpenSSL" nor may "OpenSSL" appear in their names without prior written permission of the OpenSSL Project.
6. Redistributions of any form whatsoever must retain the following acknowledgment:
"This product includes software developed by the OpenSSL Project
for use in the OpenSSL Toolkit (<http://www.openssl.org/>)"

THIS SOFTWARE IS PROVIDED BY THE OpenSSL PROJECT "AS IS" AND ANY EXPRESSED OR IMPLIED WARRANTIES, INCLUDING, BUT NOT LIMITED TO, THE IMPLIED WARRANTIES OF MERCHANTABILITY AND FITNESS FOR A PARTICULAR PURPOSE ARE DISCLAIMED. IN NO EVENT SHALL THE OpenSSL PROJECT OR ITS CONTRIBUTORS BE LIABLE FOR ANY DIRECT, INDIRECT, INCIDENTAL, SPECIAL, EXEMPLARY, OR CONSEQUENTIAL DAMAGES (INCLUDING, BUT NOT LIMITED TO, PROCUREMENT OF SUBSTITUTE GOODS OR SERVICES; LOSS OF USE, DATA, OR PROFITS; OR BUSINESS INTERRUPTION) HOWEVER CAUSED AND ON ANY THEORY OF LIABILITY, WHETHER IN CONTRACT, STRICT LIABILITY, OR TORT (INCLUDING NEGLIGENCE OR OTHERWISE) ARISING IN ANY WAY OUT OF THE USE OF THIS SOFTWARE, EVEN IF ADVISED OF THE POSSIBILITY OF SUCH DAMAGE.

This product includes cryptographic software written by Eric Young (ey@cryptsoft.com).

This product includes software written by Tim Hudson (tjh@cryptsoft.com).

Original SSLey License

/Copyright (C) 1995-1998 Eric Young (ey@cryptsoft.com)

All rights reserved.

This package is an SSL implementation written by Eric Young (ey@cryptsoft.com).

The implementation was written so as to conform with Netscape's SSL.

This library is free for commercial and non-commercial use as long as the following conditions are adhered to. The following conditions apply to all code found in this distribution, be it the RC4, RSA, lhash, DES, etc., code; not just the SSL code. The SSL documentation included with this distribution is covered by the same copyright terms except that the holder is Tim Hudson (tjh@cryptsoft.com).

Copyright remains Eric Young's, and as such any Copyright notices in the code are not to be removed. If this package is used in a product, Eric Young should be given attribution as the author of the parts of the library used. This can be in the form of a textual message at program startup or in documentation (online or textual) provided with the package.

Redistribution and use in source and binary forms, with or without modification, are permitted provided that the following conditions are met:

1. Redistributions of source code must retain the copyright notice, this list of conditions and the following disclaimer.
2. Redistributions in binary form must reproduce the above copyright notice, this list of conditions and the following disclaimer in the documentation and/or other materials provided with the distribution.
3. All advertising materials mentioning features or use of this software must display the following acknowledgement:
"This product includes cryptographic software written by Eric Young (eay@cryptsoft.com)"
The word 'cryptographic' can be left out if the routines from the library being used are not cryptographic related :-).
4. If you include any Windows specific code (or a derivative thereof) from the apps directory (application code) you must include an acknowledgement:
"This product includes software written by Tim Hudson (tjh@cryptsoft.com)"

THIS SOFTWARE IS PROVIDED BY ERIC YOUNG ``AS IS" AND ANY EXPRESS OR IMPLIED WARRANTIES, INCLUDING, BUT NOT LIMITED TO, THE IMPLIED WARRANTIES OF MERCHANTABILITY AND FITNESS FOR A PARTICULAR PURPOSE ARE DISCLAIMED. IN NO EVENT SHALL THE AUTHOR OR CONTRIBUTORS BE LIABLE FOR ANY DIRECT, INDIRECT, INCIDENTAL, SPECIAL, EXEMPLARY, OR CONSEQUENTIAL DAMAGES (INCLUDING, BUT NOT LIMITED TO, PROCUREMENT OF SUBSTITUTE GOODS OR SERVICES; LOSS OF USE, DATA, OR PROFITS; OR BUSINESS INTERRUPTION) HOWEVER CAUSED AND ON ANY THEORY OF LIABILITY, WHETHER IN CONTRACT, STRICT LIABILITY, OR TORT (INCLUDING NEGLIGENCE OR OTHERWISE) ARISING IN ANY WAY OUT OF THE USE OF THIS SOFTWARE, EVEN IF ADVISED OF THE POSSIBILITY OF SUCH DAMAGE.

The licence and distribution terms for any publicly available version or derivative of this code cannot be changed. i.e. this code cannot simply be copied and put under another distribution licence [including the GNU Public Licence.]

Portions of this software are based in part on the work of the following:

Copyright (C) 1995, 1996, 1997, and 1998 WIDE Project. All rights reserved.

Redistribution and use in source and binary forms, with or without modification, are permitted provided that the following conditions are met:

1. Redistributions of source code must retain the above copyright notice, this list of conditions and the following disclaimer.
2. Redistributions in binary form must reproduce the above copyright notice, this list of conditions and the following disclaimer in the documentation and/or other materials provided with the distribution.
3. Neither the name of the project nor the names of its contributors may be used to endorse or promote products derived from this software without specific prior written permission.

THIS SOFTWARE IS PROVIDED BY THE PROJECT AND CONTRIBUTORS ``AS IS" AND ANY EXPRESS OR IMPLIED WARRANTIES, INCLUDING, BUT NOT LIMITED TO, THE IMPLIED WARRANTIES OF MERCHANTABILITY AND FITNESS FOR A PARTICULAR PURPOSE ARE DISCLAIMED. IN NO EVENT SHALL THE PROJECT OR CONTRIBUTORS BE LIABLE FOR ANY DIRECT, INDIRECT, INCIDENTAL, SPECIAL, EXEMPLARY, OR CONSEQUENTIAL DAMAGES (INCLUDING, BUT NOT LIMITED TO, PROCUREMENT OF SUBSTITUTE GOODS OR SERVICES; LOSS OF USE, DATA, OR PROFITS; OR BUSINESS INTERRUPTION) HOWEVER CAUSED AND ON ANY THEORY OF LIABILITY, WHETHER IN CONTRACT, STRICT LIABILITY, OR TORT (INCLUDING NEGLIGENCE OR OTHERWISE) ARISING IN ANY WAY OUT OF THE USE OF THIS SOFTWARE, EVEN IF ADVISED OF THE POSSIBILITY OF SUCH DAMAGE.

Portions of this software are based in part on the work of the following:

Copyright (C) 1990, RSA Data Security, Inc. All rights reserved.

<<RSA Data Security, Inc. MD5 Message-Digest Algorithm>>

License to copy and use this software is granted provided that it is identified as the "RSA Data Security, Inc. MD5 Message Digest Algorithm" in all material mentioning or referencing this software or this function.

License is also granted to make and use derivative works provided that such works are identified as "derived from the RSA Data Security, Inc. MD5 Message-Digest Algorithm" in all material mentioning or referencing the derived work.

<<RSA Data Security, Inc. MD4 Message-Digest Algorithm>>

License to copy and use this software is granted provided that it is identified as the "RSA Data Security, Inc. MD4 Message Digest Algorithm" in all material mentioning or referencing this software or this function.

License is also granted to make and use derivative works provided that such works are identified as "derived from the RSA Data Security, Inc. MD4 Message-Digest Algorithm" in all material mentioning or referencing the derived work.

RSA Data Security, Inc. makes no representations concerning either the merchantability of this software or the suitability of this software for any particular purpose. It is provided "as is" without express or implied warranty of any kind.

These notices must be retained in any copies of any part of this documentation and/or software.

Portions of this software are based in part on the work of the following:

Copyright (c) 1989 Carnegie Mellon University. All rights reserved.

Redistribution and use in source and binary forms are permitted provided that the above copyright notice and this paragraph are duplicated in all such forms and that any documentation, advertising materials, and other materials related to such distribution and use acknowledge that the software was developed by Carnegie Mellon University. The name of the University may not be used to endorse or promote products derived from this software without specific prior written permission.

THIS SOFTWARE IS PROVIDED "AS IS" AND WITHOUT ANY EXPRESS OR IMPLIED WARRANTIES, INCLUDING, WITHOUT LIMITATION, THE IMPLIED WARRANTIES OF MERCHANTABILITY AND FITNESS FOR A PARTICULAR PURPOSE.

Portions of this software are based in part on the work of the following:

Copyright 2000, 2001 Shane Kerr. All rights reserved.

Redistribution and use in source and binary forms, with or without modification, are permitted provided that the following conditions are met:

1. Redistributions of source code must retain the above copyright notice, this list of conditions and the following disclaimer.
2. Redistributions in binary form must reproduce the above copyright notice, this list of conditions and the following disclaimer in the documentation and/or other materials provided with the distribution.

THIS SOFTWARE IS PROVIDED BY THE AUTHOR(S) "AS IS" AND ANY EXPRESS OR IMPLIED WARRANTIES, INCLUDING, BUT NOT LIMITED TO, THE IMPLIED WARRANTIES OF MERCHANTABILITY AND FITNESS FOR A PARTICULAR PURPOSE ARE DISCLAIMED. IN NO EVENT SHALL THE REGENTS OR CONTRIBUTORS BE LIABLE FOR ANY DIRECT, INDIRECT, INCIDENTAL, SPECIAL, EXEMPLARY, OR CONSEQUENTIAL DAMAGES (INCLUDING, BUT NOT LIMITED TO, PROCUREMENT OF SUBSTITUTE GOODS OR SERVICES; LOSS OF USE, DATA, OR PROFITS; OR BUSINESS INTERRUPTION) HOWEVER CAUSED AND ON ANY THEORY OF LIABILITY, WHETHER IN CONTRACT, STRICT LIABILITY, OR TORT (INCLUDING NEGLIGENCE OR OTHERWISE) ARISING IN ANY WAY OUT OF THE USE OF THIS SOFTWARE, EVEN IF ADVISED OF THE POSSIBILITY OF SUCH DAMAGE.

Table of Contents

CHAPTER 1	<i>Introduction</i>	13
	What's New in 7.7.4	13
	About Motorola Netopia® Documentation	15
	Intended Audience	15
	Documentation Conventions	15
	General	15
	Internal Web Interface	16
	Command Line Interface	16
	Organization	17
	A Word About Example Screens	17
CHAPTER 2	<i>Basic Mode Setup</i>	19
	Important Safety Instructions	20
	POWER SUPPLY INSTALLATION	20
	TELECOMMUNICATION INSTALLATION	20
	PRODUCT VENTILATION	20
	Wichtige Sicherheitshinweise	21
	NETZTEIL INSTALLIEREN	21
	INSTALLATION DER TELEKOMMUNIKATION	21
	Setting up the Motorola Netopia® Gateway	22
	Microsoft Windows:	22
	Macintosh MacOS 8 or higher or Mac OS X:	24
	Configuring the Motorola Netopia® Gateway	25
	MiAVo VDSL and Ethernet WAN models Quickstart	25
	PPPoE Quickstart	27
	Set up the Motorola Netopia® Pocket Gateway	28
	Motorola Netopia® Gateway Status Indicator Lights	30
	Home Page - Basic Mode	31
	Manage My Account	33
	Status Details	34
	Enable Remote Management	35
	Expert Mode	36
	Update Firmware	37
	Factory Reset	38
CHAPTER 3	<i>Expert Mode</i>	39
	Accessing the Expert Web Interface	39
	Open the Web Connection	39
	Home Page - Expert Mode	41

- Home Page - Information 41
- Toolbar **43**
- Navigating the Web Interface **43**
 - Breadcrumb Trail 43
- Restart **44**
 - Alert Symbol 45
- Help **46**
- Configure **47**
 - Quickstart 47
 - How to Use the Quickstart Page 47
 - Setup Your Gateway using a PPP Connection 47
 - LAN 49
 - Wireless 53
 - Privacy 54
 - Advanced 56
 - About Closed System Mode 57
 - WPA Version Allowed 59
 - Multiple SSIDs 59
 - WiFi Multimedia 62
 - Wireless MAC Authorization 63
 - Use RADIUS Server 65
 - WAN 67
 - PPP over Ethernet interface 67
 - Advanced: 69
 - Ethernet WAN interface 70
 - WAN Ethernet and VDSL Gateways 73
 - ADSL Gateways 73
 - Advanced 78
 - IP Static Routes 79
 - IP Static ARP 81
 - Pinholes 82
 - Configure Specific Pinholes 82
 - Planning for Your Pinholes 82
 - Example: A LAN Requiring Three Pinholes 82
 - Pinhole Configuration Procedure 84
 - IPMaps 87
 - Configure the IPMaps Feature 87
 - FAQs for the IPMaps Feature 87
 - What are IPMaps and how are they used? 87
 - What types of servers are supported by IPMaps? 87
 - Can I use IPMaps with my PPPoE or PPPoA connection? 87
 - Will IPMaps allow IP addresses from different subnets to be assigned to my Gateway? 87
 - IPMaps Block Diagram 88
 - Default Server 89
 - Configure a Default Server 89
 - Typical Network Diagram 89
 - NAT Combination Application 90
 - IP-Passthrough 90
 - A restriction 91
 - Differentiated Services 92
 - DNS 95
 - DHCP Server 96
 - RADIUS Server 97

SNMP	98
IGMP (Internet Group Management Protocol)	100
UPnP	102
LAN Management	103
Ethernet Bridge	104
Configuring for Bridge Mode	105
VLAN	107
Overview	107
Ethernet Switching/Policy Setup	108
Example	116
VoIP	120
System	124
Syslog Parameters	125
Log Event Messages	126
Internal Servers	129
Software Hosting	130
List of Supported Games and Software	131
Rename a User(PC)	132
Backup	133
Manual options	133
Automatic options	134
Ethernet MAC Override	136
Clear Options	137
Time Zone	138
Security	139
Passwords	140
Create and Change Passwords	140
Firewall	142
Use a Motorola Netopia® Firewall	142
BreakWater Basic Firewall	142
Configuring for a BreakWater Setting	142
TIPS for making your BreakWater Basic Firewall Selection	143
Basic Firewall Background	143
IPSec	146
SafeHarbour IPSec VPN	147
Configuring a SafeHarbour VPN	148
Parameter Descriptions	151
Stateful Inspection	154
Stateful Inspection Firewall installation procedure	154
Exposed Addresses	155
Stateful Inspection Options	157
Open Ports in Default Stateful Inspection Installation	157
Firewall Tutorial	158
General firewall terms	158
Basic IP packet components	158
Basic protocol types	158
Firewall design rules	159
Firewall Logic	159
Implied rules	160
Example filter set page	160
Filter basics	161
Example network	161
Example filters	161
Example 1	161
Example 2	162

Example 3	162
Example 4	162
Example 5	162
Packet Filter	163
What's a filter and what's a filter set?	163
How filter sets work	164
Filter priority	164
How individual filters work	165
A filtering rule	165
Parts of a filter	165
Port numbers	165
Port number comparisons	166
Other filter attributes	166
Putting the parts together	167
Filtering example #1	167
Filtering example #2	169
Design guidelines	169
An approach to using filters	170
Working with IP Filters and Filter Sets	171
Adding a filter set	171
Adding filters to a filter set	172
Viewing filters	175
Modifying filters	175
Deleting filters	175
Moving filters	175
Deleting a filter set	175
Associating a Filter Set with an Interface	176
Policy-based Routing using Filtersets	177
TOS field matching	177
Security Log	179
Using the Security Monitoring Log	179
Timestamp Background	181
Install	182
Install Software	183
Updating Your Gateway's Motorola Netopia® Firmware Version	183
Step 1: Required Files	183
Step 2: Motorola Netopia® firmware Image File	184
Install Key	187
Use Motorola Netopia® Software Feature Keys	187
Obtaining Software Feature Keys	187
Procedure - Install a New Feature Key File	187
To check your installed features:	189
Install Certificate	190

CHAPTER 4 *Basic Troubleshooting* **193**

Status Indicator Lights	194
LED Function Summary Matrix	204
Factory Reset Switch	206

CHAPTER 5 *Advanced Troubleshooting* **207**

Home Page 208
Expert Mode 210
System Status 211
Ports: Ethernet 212
Ports: DSL 213
IP: Interfaces 214
DSL: Circuit Configuration 215
System Log: Entire 216
Diagnostics 217
Network Tools 218

CHAPTER 6 *Command Line Interface* **223**

Overview **224**
Starting and Ending a CLI Session **226**
 Logging In 226
 Ending a CLI Session 226
 Saving Settings 226
Using the CLI Help Facility **226**
About SHELL Commands **227**
 SHELL Prompt 227
 SHELL Command Shortcuts 227
SHELL Commands **228**
 Common Commands 228
 WAN Commands 239
About CONFIG Commands **240**
 CONFIG Mode Prompt 240
 Navigating the CONFIG Hierarchy 240
 Entering Commands in CONFIG Mode 241
 Guidelines: CONFIG Commands 241
 Displaying Current Gateway Settings 242
 Step Mode: A CLI Configuration Technique 242
 Validating Your Configuration 242
CONFIG Commands **243**
 Remote ATA Configuration Commands 243
 DSL Commands 245
 ATM Settings 245
 Bridging Settings 246
 Common Commands 247
 DHCP Settings 248
 Common Commands 248
 DHCP Generic Options 249
 DHCP Option Filtering 252
 Example 253
 DMT Settings 254
 DSL Commands 254
 Domain Name System Settings 255
 Common Commands 255
 Dynamic DNS Settings 256
 IGMP Settings 257

IP Settings	259
Common Settings	259
ARP Timeout Settings	259
DSL Settings	259
Ethernet LAN Settings	261
Additional subnets	262
Default IP Gateway Settings	263
IP-over-PPP Settings	263
Static ARP Settings	266
IGMP Forwarding	266
IPsec Passthrough	266
IP Prioritization	266
Differentiated Services (DiffServ)	267
Packet Mapping Configuration	269
Queue Configuration	271
Basic Queue	272
Weighted Fair Queue	273
Priority Queue	274
Funnel Queue	275
Interface Queue Assignment	275
SIP Passthrough	276
RTSP Passthrough	276
Static Route Settings	276
IPMaps Settings	277
Network Address Translation (NAT) Default Settings	278
Network Address Translation (NAT) Pinhole Settings	278
PPPoE /PPPoA Settings	279
Configuring Basic PPP Settings	279
Configuring Port Authentication	281
PPPoE with IPoE Settings	282
Ethernet WAN platforms	282
ADSL platforms	283
Ethernet Port Settings	283
802.3ah Ethernet OAM Settings	284
Command Line Interface Preference Settings	285
Port Renumbering Settings	286
Security Settings	287
Firewall Settings (for BreakWater Firewall)	287
SafeHarbour IPsec Settings	287
Internet Key Exchange (IKE) Settings	291
Stateful Inspection	292
Example:	293
Packet Filtering Settings	294
Example:	296
SNMP Settings	297
SNMP Notify Type Settings	297
System Settings	298
Syslog	301
Default syslog installation procedure	302
Wireless Settings (supported models)	303
Wireless Multi-media (WMM) Settings	306
Wireless Privacy Settings	308
Wireless MAC Address Authorization Settings	309
RADIUS Server Settings	310
VLAN Settings	311
Example 1:	312

Example 2:	313
VoIP settings	316
Example	320
UPnP settings	321
DSL Forum settings	321
TR-064	321
TR-069	322
Backup IP Gateway Settings	323
VDSL Settings	325
VDSL Parameter Defaults	325
VDSL Parameters Accepted Values	327

CHAPTER 7 *Glossary* **331**

----A----	331
----B----	332
----C----	332
----D----	333
----E----	334
----F----	335
----H----	335
----I----	336
----K----	336
----L----	336
----M----	337
----N----	337
----P----	338
----Q----	338
----R----	339
----S----	339
----T----	340
----U----	341
----V----	341
----W----	341
----X----	341

CHAPTER 8 *Technical Specifications and Safety Information* **343**

Description	343
Dimensions:	343
Communications interfaces:	343
Power requirements	343
Environment	343
Operating temperature:	343
Storage temperature:	343
Relative storage humidity:	343
Software and protocols	343
Software media:	343
Routing:	343
WAN support:	343
Security:	343
Management/configuration methods:	344
Diagnostics:	344
Agency approvals	344

- North America 344
- International 344
- Regulatory notices 344
 - European Community. 344
- Manufacturer's Declaration of Conformance **344**
 - United States 345
 - Service requirements 345
 - Canada 345
 - Declaration for Canadian users. 345
 - Caution 346
- Important Safety Instructions **346**
 - Australian Safety Information 346
 - Caution 346
 - Caution 346
 - Telecommunication installation cautions 346
- 47 CFR Part 68 Information **347**
 - FCC Requirements. 347
 - FCC Statements. 347
- Electrical Safety Advisory **348**
- Copyright Acknowledgments **348**

CHAPTER 9 *Overview of Major Capabilities* **351**

- Wide Area Network Termination **351**
 - PPPoE/PPPoA (Point-to-Point Protocol over Ethernet/ATM). 351
 - Instant-On PPP 352
- Simplified Local Area Network Setup **352**
 - DHCP (Dynamic Host Configuration Protocol) Server 352
 - DNS Proxy 353
- Management **353**
 - Embedded Web Server 353
 - Diagnostics 353
- Security **354**
 - Remote Access Control 354
 - Password Protection 354
 - Network Address Translation (NAT) 354
 - Motorola Netopia® Advanced Features for NAT 355
 - Internal Servers. 355
 - Pinholes 356
 - Default Server 356
 - Combination NAT Bypass Configuration 356
 - IP-Passthrough 356
 - VPN IPSec Pass Through. 357
 - VPN IPSec Tunnel Termination 357
 - Stateful Inspection Firewall. 358
 - SSL Certificate Support. 358
 - VLANs 358

Index **359**

CHAPTER 1 Introduction

What's New in 7.7.4

New in Motorola Netopia® Embedded Software Version 7.7.4 are the following features:

- Internet Group Management Protocol (IGMP) Version 3 support. See [“IGMP \(Internet Group Management Protocol\)” on page 100](#).
- TR-101 Support:
 - Concurrent support for PPPoE and IPoE connections on the WAN. See [“WAN” on page 67](#).
 - Multiple LAN IP Subnet support. See [“LAN” on page 49](#).
 - Additional DHCP range support. These ranges are associated with the additional LAN subnets on a 1-to-1 basis.
 - DHCP option filtering support. Allows DHCP option data to be used to determine the desired DHCP address range. See [“DHCP Option Filtering” on page 252](#).
 - Support for additional WAN settings to control multicast forwarding as well as if 0.0.0.0 is used as the source address for IGMP packets. See [“Advanced:” on page 69](#).
 - Support for “unnumbered” interfaces. For IP interfaces, this allows the address to be set to 0 and the DHCP client also to be disabled. See [page 71](#).
- PPPoE/DHCP Autosensing. See [“WAN” on page 67](#).
- Wireless Multimedia Mode (WMM) support. See [“WiFi Multimedia” on page 62](#).
- Firewall: ClearSailing is automatically enabled on all 2200-Series ADSL2+ platforms. (Explicit exceptions: bonded and VDSL2, 3341, and 3387WG.) See [“Firewall” on page 142](#).
- TR-069 Remote device management is automatically enabled by default for 2200-Series Gateways. (Explicit exceptions: bonded and VDSL2, 3341, 3387WG). See [“TR-069” on page 322](#).
- Voice-over-IP (VoIP) Support using Session Initiation Protocol (SIP) for supported models. See [“VoIP” on page 120](#) and VoIP CLI [“VoIP settings” on page 316](#).
- Support of VLAN ID 0 on the Ethernet WAN and support for setting p-bits on a segment/port basis; inter-VLAN groups. See [“VLAN” on page 107](#) and CLI [“VLAN Settings” on page 311](#).
- Backup IP Gateway Support. See [“Backup” on page 133](#) and CLI [“Backup IP Gateway Settings” on page 323](#).

Corresponding commands have been added to the Command Line Interface (CLI). See [“Command Line Interface” on page 223](#).

- Reset WAN port and wireless counter and CLI command to display individual Ethernet port statistics. See [“reset enet \[all \]” on page 231](#) and [“show enet \[all \]” on page 233](#).
- CLI for Motorola Netopia® ATA Remote Management. See [“Remote ATA Configuration Commands” on page 243](#).

- Provide Bandwidth Management using Weighted Fair Queueing. See [“Queue Configuration” on page 271](#).
- New CLI command for disabling Dying Gasp. See [“DMT Settings” on page 254](#).
- Ethernet in the First Mile Operations Administration and Maintenance (802.3ah EFM OAM) Support. See [“802.3ah Ethernet OAM Settings” on page 284](#).
- IP multicast to layer 2 unicast mapping. See [“IGMP Settings” on page 257](#).
- Real Time Streaming Protocol (RTSP) ALG support for Video-on-Demand (VoD) Services. See [“RTSP Passthrough” on page 276](#).

About Motorola Netopia® Documentation



NOTE:

This guide describes the wide variety of features and functionality of the Motorola Netopia® Gateway, when used in Router mode. The Motorola Netopia® Gateway may also be delivered in Bridge mode. In Bridge mode, the Gateway acts as a pass-through device and allows the workstations on your LAN to have public addresses directly on the Internet.

Motorola, Inc. provides a suite of technical information for its 2200-, 3300- and 7000-series family of intelligent enterprise and consumer Gateways. It consists of:

- *Administrator's Handbook*
- Dedicated Quickstart guides
- Specific White Papers

The documents are available in electronic form as Portable Document Format (PDF) files. They are viewed (and printed) from Adobe Acrobat Reader, Exchange, or any other application that supports PDF files.

They are downloadable from Motorola's Netopia website:
<http://www.netopia.com/>

Intended Audience

This guide is targeted primarily to residential service subscribers.

Expert Mode sections may also be of use to the support staffs of broadband service providers and advanced residential service subscribers.

[See "Expert Mode" on page 39.](#)

Documentation Conventions



General

This manual uses the following conventions to present information:

Convention (Typeface)	Description
<i>bold italic</i>	Menu commands
<i>monospaced</i>	
<u><i>bold italic sans serif</i></u>	Web GUI page links and button names

<code>terminal</code>	Computer display text
bold terminal	User-entered text
<i>Italic</i>	Italic type indicates the complete titles of manuals.

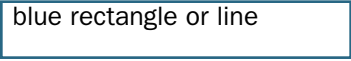
Internal Web Interface

Convention (Graphics)	Description
	Denotes an “excerpt” from a Web page or the visual truncation of a Web page
	Denotes an area of emphasis on a Web page
solid rounded rectangle with an arrow	

Command Line Interface

Syntax conventions for the Netopia Gateway command line interface are as follows:

Convention	Description
straight ([]) brackets in cmd line	Optional command arguments
curly ({ }) brackets, with values separated with vertical bars ().	Alternative values for an argument are presented in curly ({ }) brackets, with values separated with vertical bars ().
bold terminal type face	User-entered text
<i>italic terminal type face</i>	Variables for which you supply your own values

Organization

This guide consists of nine chapters, including a glossary, and an index. It is organized as follows:

- **Chapter 1, “Introduction”** — Describes the Motorola Netopia® document suite, the purpose of, the audience for, and structure of this guide. It gives a table of conventions.
- **Chapter 2, “Basic Mode Setup”** — Describes how to get up and running with your Motorola Netopia® Gateway.
- **Chapter 3, “Expert Mode”** — Focuses on the “Expert Mode” Web-based user interface for advanced users. It is organized in the same way as the Web UI is organized. As you go through each section, functions and procedures are discussed in detail.
- **Chapter 4, “Basic Troubleshooting”** — Gives some simple suggestions for troubleshooting problems with your Gateway’s initial configuration.
- **Chapter 5, “Advanced Troubleshooting”** — Gives suggestions and descriptions of expert tools to use to troubleshoot your Gateway’s configuration.
- **Chapter 6, “Command Line Interface”** — Describes all the current text-based commands for both the SHELL and CONFIG modes. A summary table and individual command examples for each mode is provided.
- **Chapter 7, “Glossary”**
- **Chapter 8, “Technical Specifications and Safety Information”**
- **Chapter 9, “Overview of Major Capabilities”** — Presents a product description summary.
- **Index**

A Word About Example Screens

This manual contains many example screen illustrations. Since Motorola Netopia® 2200-, 3300- and 7000-Series Gateways offer a wide variety of features and functionality, the example screens shown may not appear exactly the same for your particular Gateway or setup as they appear in this manual. The example screens are for illustrative and explanatory purposes, and should not be construed to represent your own unique environment.

CHAPTER 2 Basic Mode Setup

Most users will find that the basic Quickstart configuration is all that they ever need to use. This section may be all that you ever need to configure and use your Motorola Netopia® Gateway. The following instructions cover installation in *Router Mode*.

This section covers:

- [“Important Safety Instructions” on page 20](#)
- [“Wichtige Sicherheitshinweise” on page 21](#) (German)
- [“Setting up the Motorola Netopia® Gateway” on page 22](#)
- [“Configuring the Motorola Netopia® Gateway” on page 25](#)
- [“Motorola Netopia® Gateway Status Indicator Lights” on page 30](#)
- [“Home Page - Basic Mode” on page 31](#)

Important Safety Instructions

POWER SUPPLY INSTALLATION

Connect the power supply cord to the power jack on the Motorola Netopia® Gateway. Plug the power supply into an appropriate electrical outlet.



CAUTION:

Depending on the power supply provided with the product, either the direct plug-in power supply blades, power supply cord plug or the appliance coupler serves as the mains power disconnect. It is important that the direct plug-in power supply, socket-outlet or appliance coupler be located so it is readily accessible.

(Sweden) Apparaten skall anslutas till jordat uttag när den ansluts till ett nätverk

(Norway) Apparatet må kun tilkoples jordet stikkontakt.

USB-powered models: For Use with Listed I.T.E. Only

TELECOMMUNICATION INSTALLATION

When using your telephone equipment, basic safety precautions should always be followed to reduce the risk of fire, electric shock and injury to persons, including the following:

- Do not use this product near water, for example, near a bathtub, wash bowl, kitchen sink or laundry tub, in a wet basement or near a swimming pool.
- Avoid using a telephone (other than a cordless type) during an electrical storm. There may be a remote risk of electrical shock from lightning.
- Do not use the telephone to report a gas leak in the vicinity of the leak.

PRODUCT VENTILATION

The Motorola Netopia® Gateway is intended for use in a consumer's home. Ambient temperatures around this product should not exceed 104°F (40°C). It should not be used in locations exposed to outside heat radiation or trapping of its own heat. The product should have at least one inch of clearance on all sides except the bottom when properly installed and should not be placed inside tightly enclosed spaces unless proper ventilation is provided.

SAVE THESE INSTRUCTIONS

Wichtige Sicherheitshinweise

NETZTEIL INSTALLIEREN

Verbinden Sie das Kabel vom Netzteil mit dem Power-Anschluss an dem Motorola Netopia® Gateway. Stecken Sie dann das Netzteil in eine Netzsteckdose.



Achtung:

Abhängig von dem mit dem Produkt gelieferten Netzteil, entweder die direkten Stecker-netzgeräte, Stecker vom Netzkabel oder der Gerätekoppler dienen als Hauptspannungsunterbrechung. Es ist wichtig, dass das Steckernetzgerät, Steckdose oder Gerätekoppler frei zugänglich sind.

(Sweden) Apparaten skall anslutas till jordat uttag när den ansluts till ett nätverk

(Norway) Apparatet må kun tilkoples jordet stikkontakt.

USB-powered models: For Use with Listed I.T.E. Only

INSTALLATION DER TELEKOMMUNIKATION

Wenn Ihre Telefonausrüstung verwendet wird, sollten grundlegende Sicherheitsanweisungen immer befolgt werden, um die Gefahr eines Feuers, eines elektrischen Schlages und die Verletzung von Personen, zu verringern. Beachten Sie diese weiteren Hinweise:

- Benutzen Sie dieses Produkt nicht in Wassernähe wie z.B. nahe einer Badewanne, Waschschüssel, Küchenspüle, in einem nassen Keller oder an einem Swimmingpool.
- Vermeiden Sie das Telefonieren (gilt nicht für schnurlose Telefone) während eines Gewitters. Es besteht die Gefahr eines elektrischen Schlages durch einen Blitz.
- Nicht das Telefon benutzen um eine Gasleckstelle zu Melden, wenn Sie sich in der Nähe der Leckstelle befinden.

Bewahren Sie diese Anweisungen auf

Setting up the Motorola Netopia® Gateway

Refer to your *Quickstart Guide* for instructions on how to connect your Motorola Netopia® gateway to your power source, PC or local area network, and your Internet access point, whether it is a dedicated DSL outlet or a DSL or cable modem. Different Motorola Netopia® Gateway models are supplied for any of these connections. Be sure to enable Dynamic Addressing on your PC. Perform the following:

Microsoft Windows:

Step 1. Navigate to the TCP/IP Properties Control Panel.

a. Some Windows versions follow a path like this:

Start menu -> **Settings** -> **Control Panel** -> **Network** (or **Network and Dial-up Connections** -> **Local Area Connection** -> **Properties**) -> **TCP/IP** [your_network_card] or **Internet Protocol [TCP/IP]** -> **Properties**

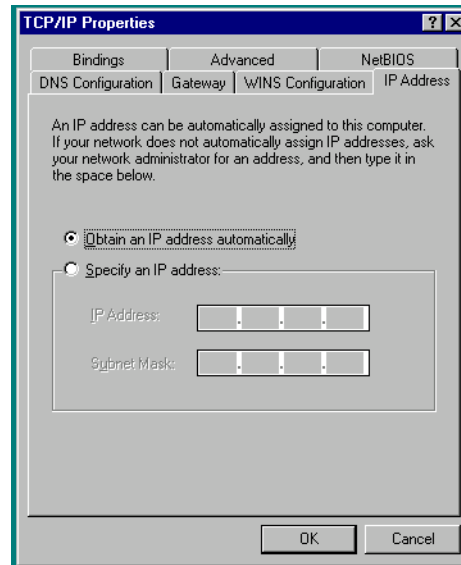

b. Some Windows versions follow a path like this:

Start menu -> **Control Panel** -> **Network and Internet Connections** -> **Network Connections** -> **Local Area Connection** -> **Properties** -> **Internet Protocol [TCP/IP]** -> **Properties**

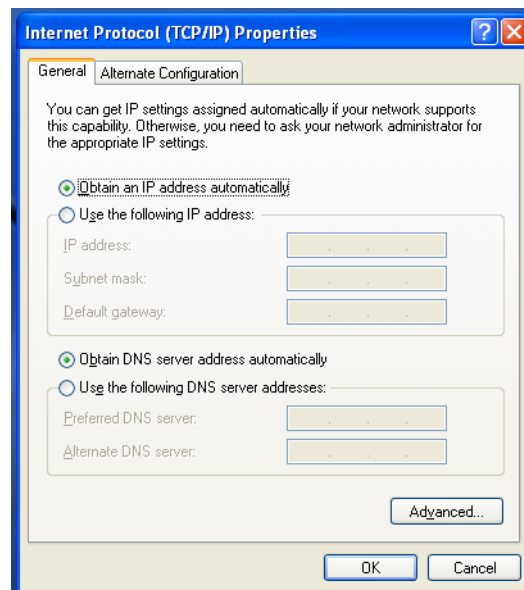

c. Windows Vista is set to obtain an IP address automatically by default. You may not need to configure it at all.

To check, open the **Networking** Control Panel and select **Internet Protocol Version 4 (TCP/IPv4)**. Click the **Properties** button.

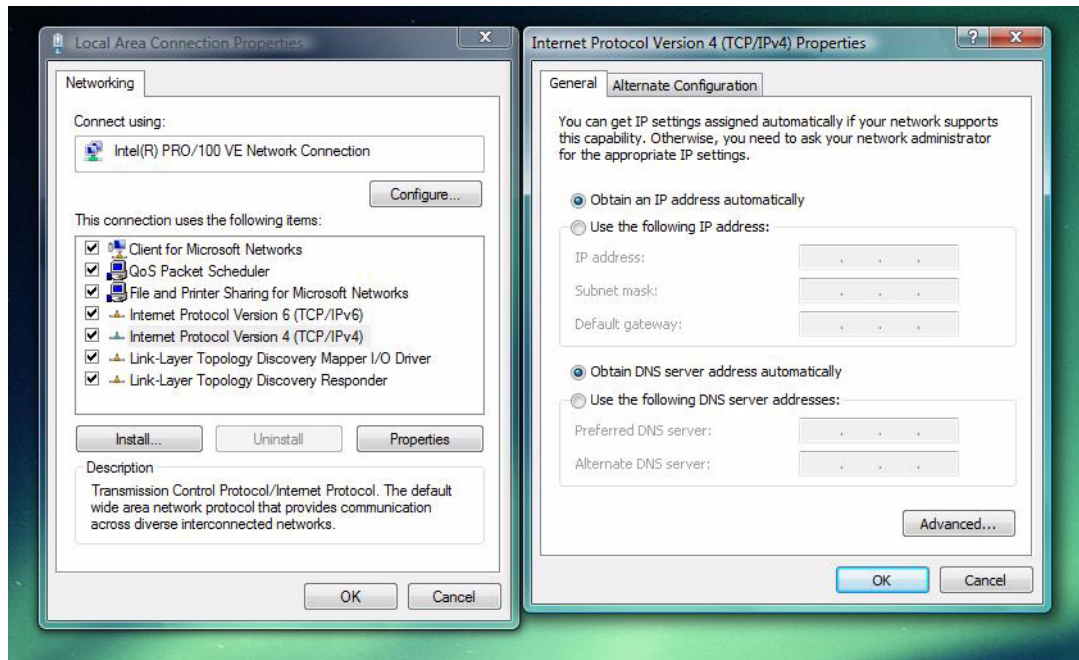

The **Internet Protocol Version 4 (TCP/IPv4) Properties** window should appear as shown.

If not, select the radio buttons shown above, and click the **OK** button.

Macintosh MacOS 8 or higher or Mac OS X:

Step 1. Access the TCP/IP or Network control panel.

- a. MacOS follows a **Apple Menu -> Control Panels -> TCP/IP** Control Panel

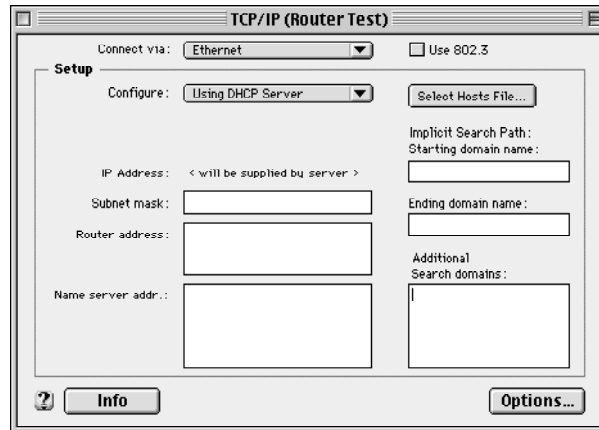

- b. Mac OS X follows a **Apple Menu -> System Preferences -> Network** path like this:

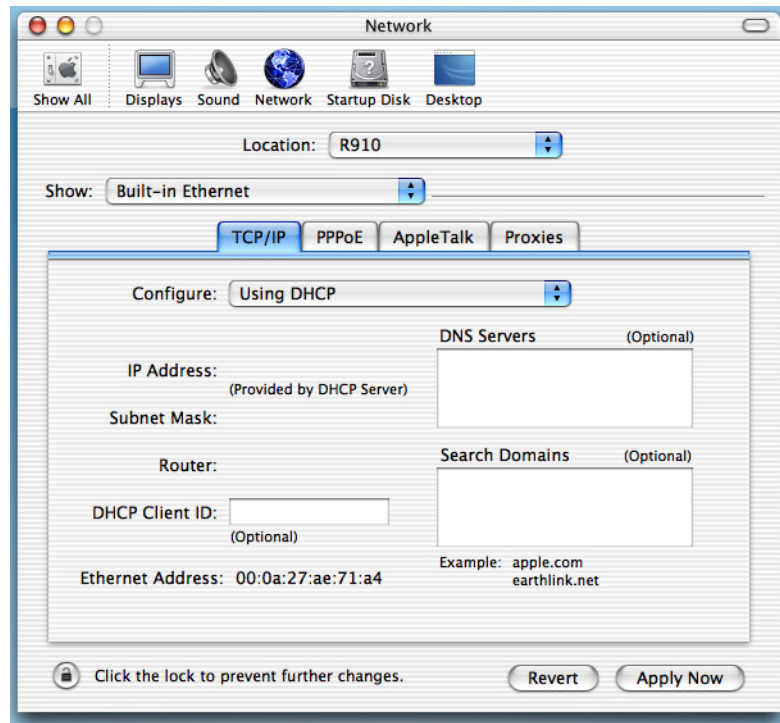

Then go to Step 2.

Step 2. Select *Built-in Ethernet*

Step 3. Select *Configure Using DHCP*

Step 4. Close and Save, if prompted.

Proceed to [“Configuring the Motorola Netopia® Gateway”](#) on page 25.

Configuring the Motorola Netopia® Gateway

1. Run your Web browser application, such as Firefox or Microsoft Internet Explorer, from the computer connected to the Motorola Netopia® Gateway.

Enter <http://192.168.1.254> in the Location text box.

The Admin Password page appears.

Welcome to your Netopia-3000

Before configuration, your Gateway requires a password to protect it from unauthorized access. This password is unique to this Gateway. It is case sensitive, and must be 1 to 8 characters long. Remember this password or keep it in a safe place.

After you submit your new password, you must logon before continuing. When you connect to your Gateway as an Administrator, you enter "Admin" as the UserName and the password you just created in the Logon dialog.

Admin Password

New Password

Confirm Password

Access to your Motorola Netopia® device can be controlled through two access control accounts, **Admin** or **User**.

- The **Admin**, or administrative user, performs all configuration, management or maintenance operations on the Gateway.
- The **User** account provides monitor capability **only**.
A user may **NOT** change the configuration, perform upgrades or invoke maintenance functions.
For the security of your connection, an Admin password must be set on the Motorola Netopia® unit.

MiAVo VDSL and Ethernet WAN models Quickstart

The browser then displays the Quickstart page.

Quickstart

The basic Gateway configuration required to connect to your ISP is complete. In most cases, you should be ready to connect to the Internet.

If you have further instructions from your Service Provider, including specific configuration parameters to be set, use the Quickstart Advanced link, if available, or go to Configure->WAN to set up your specific configuration.

Other Quickstart Options

[Advanced Configure System Name and Ethernet MAC Address](#)

2. Click the **Connect to the Internet** button.

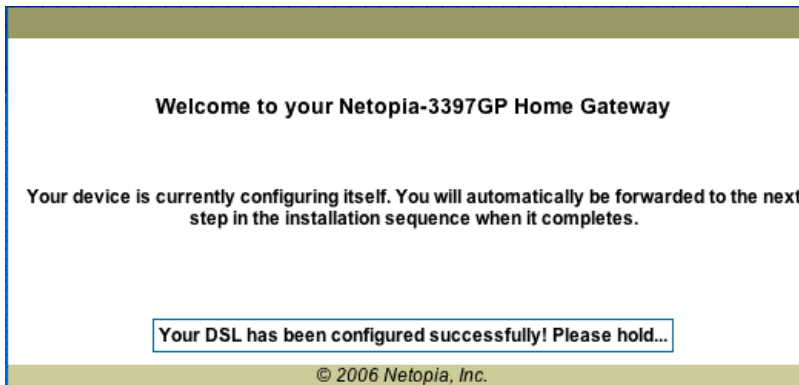

Once a connection is established, your browser is redirected to your service provider's home page or a registration page on the Internet.



NOTE:

For MiAVo Series (3397GP) models, skip the rest of this section.

Congratulations! Your configuration is complete.

You can skip to ["Home Page - Basic Mode" on page 31](#).

PPPoE Quickstart

For a PPPoE connection, your browser will display a different series of web pages:

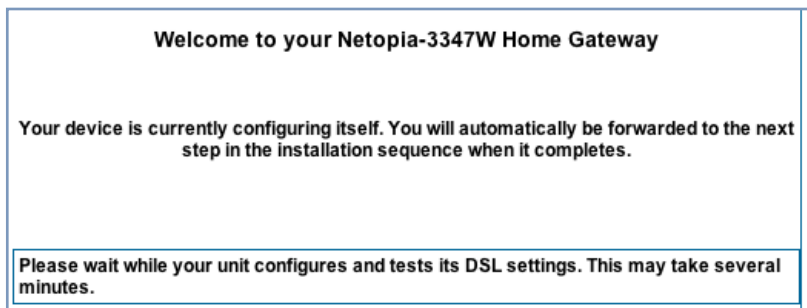

The browser then displays the Quickstart web page.

The screenshot shows a web page titled "Quickstart" with a blue header. Below the header, there are two input fields: "ISP Username" and "ISP Password". Below these fields is a button labeled "Connect to the Internet".

3. **Enter the username and password supplied by your Internet Service Provider. Click the *Connect to the Internet* button.**

Once you enter your username and password here, you will no longer need to enter them whenever you access the Internet. The Motorola Netopia® Gateway stores this information and automatically connects you to the Internet.

The Gateway displays a message while it configures itself.

4. **When the connection succeeds, your browser will display a success message.**

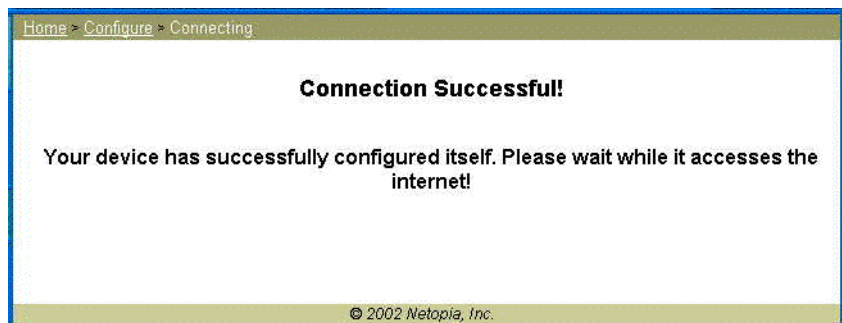

Once a connection is established, your browser is redirected to your service provider's home page or a registration page on the Internet.

5. **Congratulations! Your installation is complete. You can now surf to your favorite Web sites by typing an URL in your browser's location box or by selecting one of your favorite Internet bookmarks.**

Set up the Motorola Netopia® Pocket Gateway

Your Motorola Netopia® 3342N/3352N Pocket Gateway comes with its own installation wizard.

- If you are using Windows 98, insert the CD.
- If you are using Windows XP, Windows 2000, Windows NT or Windows Vista, you don't even need the CD.

Follow these easy setup steps:

1. **Plug the Motorola Netopia® Pocket Gateway into a USB port on your PC.**
2. **Whether you use the CD (Windows 98) or not (all other Windows versions), on Windows-based PCs, the Motorola Netopia® Installation Wizard will launch automatically.**

The Motorola Netopia® Installation Wizard will assist you to configure your PC to work with the Motorola Netopia® pocket Gateway. Follow the on-screen instructions.



To proceed, click the [Next](#) button.

The Motorola Netopia® Installation Wizard performs a series of checks on your system and then will install USB drivers for your connection.

3. **Place the Motorola Netopia® Pocket Gateway near your PC so you can see it easily.**
Make sure any cables are kept away from power cords, fluorescent lighting fixtures, and other sources of electrical interference.
4. **When the wizard prompts you, connect the RJ-11 Telephone Cable from the DSL port on the Motorola Netopia® Pocket Gateway to the ADSL phone jack.**

The **DSL** indicator light should blink for up to two minutes and then come on solid green once the device is connected to your computer.

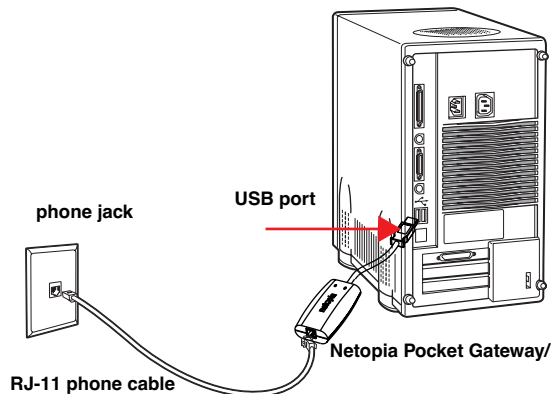

The Wizard displays a success message when the settings are configured.

5. **The Motorola Netopia® Installation Wizard will then launch your web browser and display the *Welcome* page where you configure your Motorola Netopia® Pocket Gateway.**

Motorola Netopia® Gateway Status Indicator Lights

Colored LEDs on your Motorola Netopia® Gateway indicate the status of various port activity. Different Gateway models have different ports for your connections and different indicator LEDs. The *Quickstart Guide* accompanying your Motorola Netopia® Gateway describes the behavior of the various indicator LEDs.

Example status indicator lights

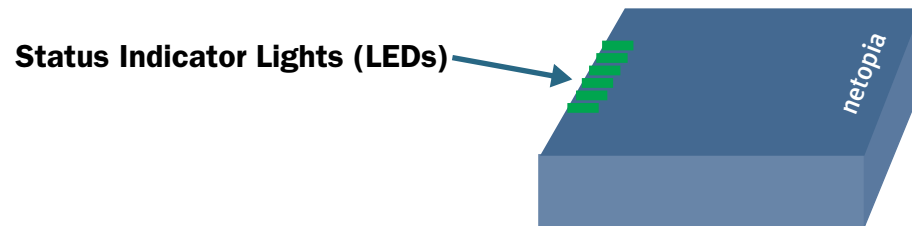

Home Page - Basic Mode

After you have performed the basic Quickstart configuration, any time you log in to your Motorola Netopia® Gateway you will access the Motorola Netopia® Gateway Home Page.

You access the Home Page by typing <http://192.168.1.254> in your Web browser's location box.

The Basic Mode Home Page appears.

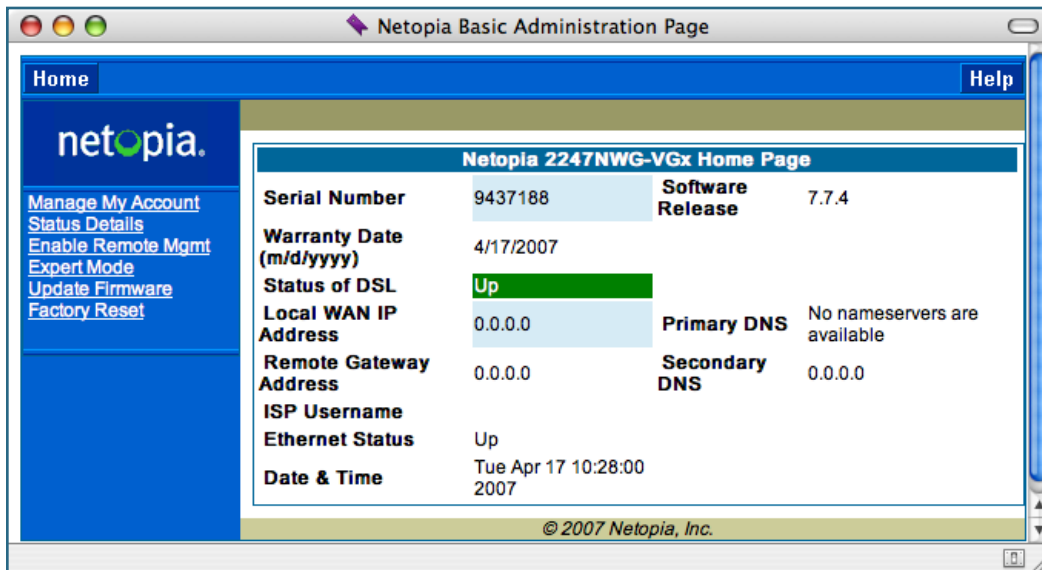

The screenshot shows a web browser window titled "Netopia Basic Administration Page". The page has a blue header with "Home" and "Help" buttons. Below the header is the "netopia." logo. A left sidebar contains several links: "Manage My Account", "Status Details", "Enable Remote Mgmt", "Expert Mode", "Update Firmware", and "Factory Reset". The main content area is titled "Netopia 2247NWG-VGx Home Page" and displays the following information:

Serial Number	9437188	Software Release	7.7.4
Warranty Date (m/d/yyyy)	4/17/2007		
Status of DSL	Up		
Local WAN IP Address	0.0.0.0	Primary DNS	No nameservers are available
Remote Gateway Address	0.0.0.0	Secondary DNS	0.0.0.0
ISP Username			
Ethernet Status	Up		
Date & Time	Tue Apr 17 10:28:00 2007		

© 2007 Netopia, Inc.



VoIP-enabled Gateways also display VoIP phone information, as well.

The Home Page displays the following information in the center section:

Item	Description
Serial Number	This is the unique serial number of your Gateway.
Software Release	This is the version number of the current embedded software in your Gateway.
Warranty Date	This is the date that your Gateway was installed and enabled.
Status of DSL	DSL connection (Internet) is either Up or Down
Status of Connection	'Waiting for DSL' is displayed while the Gateway is training. This should change to 'Up' within two minutes. 'Up' is displayed when the ADSL line is synched and the PPPoE session is established. 'Down' indicates inability to establish a connection; possible line failure.
Local WAN IP Address	This is the negotiated address of the Gateway's WAN interface. This address is usually dynamically assigned.
Remote Gateway Address	This is the negotiated address of the remote router to which this Gateway is connected.
Primary DNS Secondary DNS	These are the negotiated DNS addresses.
ISP Username	This is your PPPoE username as assigned by your service provider.
Ethernet Status	(if so equipped) Local Area Network (Ethernet) is either Up or Down
USB Status	If your Gateway is so equipped, Local Area Network (USB) is either Up or Down
Line 1/2 Registration	If your Gateway is so equipped, voice Line 1 and/or 2 is either Idle or Connected
Date & Time	This is the current UTC time; blank if this is not available due to lack of a network connection.

The links in the left-hand column on this page allow you to manage or configure several features of your Gateway. Each link is described in its own section.

Link: Manage My Account

You can change your ISP account information for the Motorola Netopia® Gateway. You can also manage other aspects of your account on your service provider's account management Web site.

Click on the [**Manage My Account**](#) link. The Manage My Account page appears.

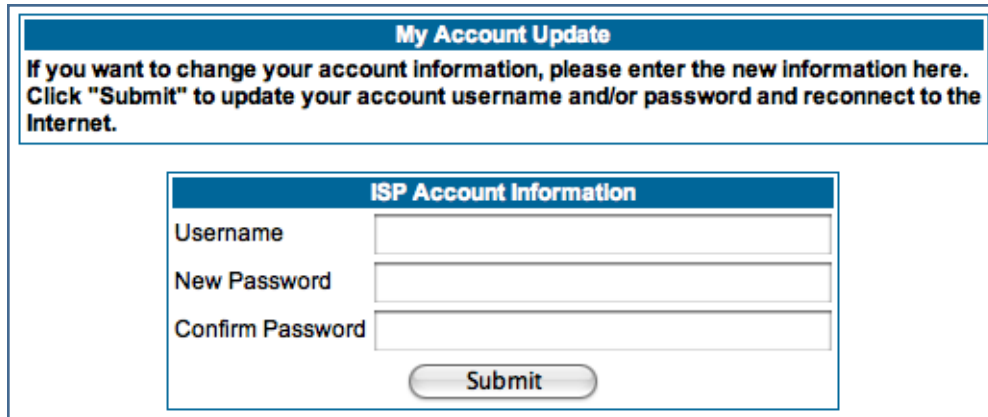

The screenshot shows a web form titled "My Account Update". At the top, a blue header bar contains the title. Below the header, a text box contains the instruction: "If you want to change your account information, please enter the new information here. Click 'Submit' to update your account username and/or password and reconnect to the Internet." Below this is a sub-form titled "ISP Account Information" with three input fields: "Username", "New Password", and "Confirm Password". A "Submit" button is located at the bottom of this sub-form.

If you have a PPPoE account, enter your username, and then your new password. Confirm your new password. For security, your actual passwords are not displayed on the screen as you type. You must enter the new password twice to be sure you have typed it correctly.

Click the [**Submit**](#) button.

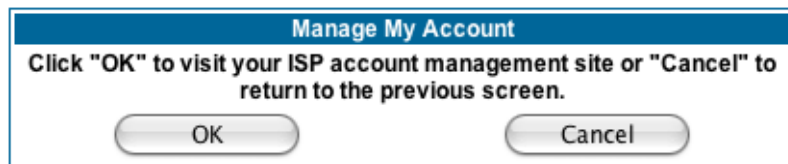

The screenshot shows a dialog box titled "Manage My Account". It contains the instruction: "Click 'OK' to visit your ISP account management site or 'Cancel' to return to the previous screen." At the bottom, there are two buttons: "OK" and "Cancel".

If you have a non-PPPoE account, click the [**OK**](#) button.

You will be taken to your service provider's Web site account management page.

Link: Status Details

If you need to diagnose any problems with your Motorola Netopia® Gateway or its connection to the Internet, you can run a sophisticated diagnostic tool. It checks several aspects of your physical and electronic connection and reports its results on-screen. This can be useful for troubleshooting, or when speaking with a technical support technician.

Click on the [Status Details](#) link. The Diagnostics page appears.



Click the [Run Diagnostics](#) button to run your diagnostic tests. For a detailed description of these tests, see [“Diagnostics” on page 217](#).

Link: Enable Remote Management

This link allows you to authorize a remotely-located person, such as a support technician, to directly access your Motorola Netopia® Gateway. This is useful for fixing configuration problems when you need expert help. You can limit the amount of time such a person will have access to your Gateway. This will prevent unauthorized individuals from gaining access after the time limit has expired.

Click the [Enable Rmt Mgmt](#) link. The Enable Remote Management page appears.

Enable Remote Management

Please enter a password for administrator access to this device, as well as a timeout value for the management session. You may leave the password entries blank to use the current administrator password. Click "OK" to enable administrator access, or "Cancel" to return to the previous screen.

Temporary Admin Password

Old Password

New Password

Confirm Password

Password Timeout 20 minutes

Since you've already has entered an Admin password, you can use that Admin password or enter a new password. If you enter a new password, it becomes the temporary Admin password. After the time-out period has expired, the Admin password reverts to the original Admin password you entered.

Enter a temporary password for the person you want to authorize, and confirm it by typing it again. You can select a time-out period for this password, from 5 to 30 minutes, from the pull-down menu. Be sure to tell the authorized person what the password is, and for how long the time-out is set. Click the [OK](#) button.

[Link: Expert Mode](#)

Most users will find that the basic Quickstart configuration is all that they ever need to use. Some users, however, may want to do more advanced configuration. The Motorola Netopia® Gateway has many advanced features that can be accessed and configured through the Expert Mode pages.

Click the [Expert Mode](#) link to display the Expert Mode Confirmation page.

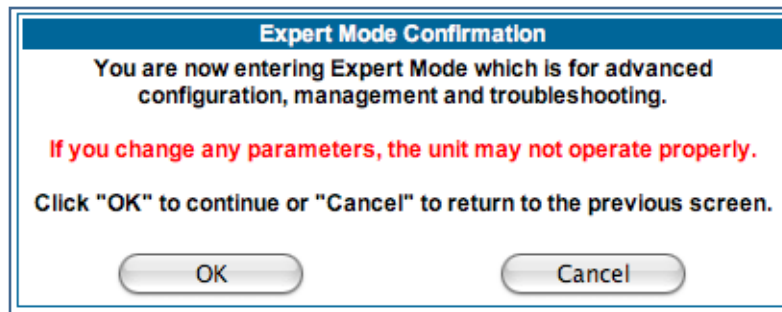

You should carefully consider any configuration changes you want to make, and be sure that your service provider supports them.

Once you click the **OK** button you will be taken to the Expert Mode Home Page.

The Expert Mode Home Page is the main access point for configuring and managing the advanced features of your Gateway. See ["Expert Mode" on page 39](#) for information.

[Link: Update Firmware](#)



NOTE:

(This link is not available on the 3342/3352 models, since firmware updates must be upgraded via the USB host driver. 3342N/3352N models *do* support this feature.)

Periodically, the embedded firmware in your Gateway may be updated to improve the operation or add new features. Your gateway includes its own onboard installation capability. Your service provider may inform you when new firmware is available, or you can check for yourself.

Click the [Update Firmware](#) link. The Firmware Update Confirmation page appears.

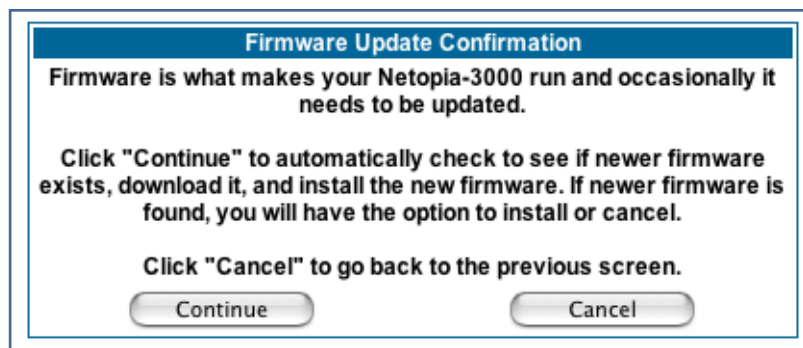

If you click the [Continue](#) button, the Gateway will check a remote Firmware Server for the latest firmware revision. If a newer version is found, your firmware will be automatically updated once you confirm the installation.

[Link: Factory Reset](#)

In some cases, you may need to clear all the configuration settings and start over again to program the Motorola Netopia® Gateway. You can perform a factory reset to do this.

Click on [Factory Reset](#) to reset the Gateway back to its original factory default settings.

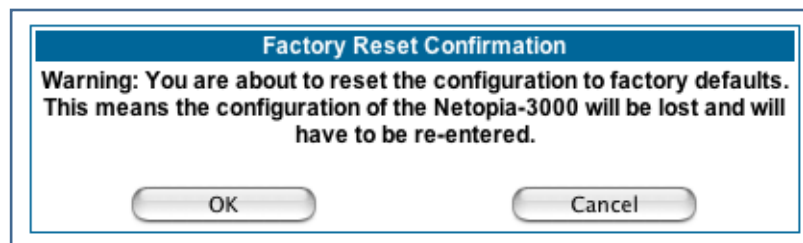

NOTE:

Exercise caution before performing a Factory Reset. This will erase any configuration changes that you may have made and allow you to reprogram your Gateway.

CHAPTER 3 Expert Mode

Using the Expert Mode Web-based user interface for the Motorola Netopia® 2200-, 3300- and 7000-series Gateway you can configure, troubleshoot, and monitor the status of your Gateway.

Accessing the Expert Web Interface

Open the Web Connection

Once your Gateway is powered up, you can use any recent version of the best-known web browsers such as Netscape Navigator or Microsoft Internet Explorer from any LAN-attached PC or workstation. The procedure is:

1. **Enter the name or IP address of your Motorola Netopia® Gateway in the Web browser's window and press Return.**
For example, you would enter <http://192.168.1.254>.
2. **If an administrator or user password has been assigned to the Motorola Netopia® Gateway, enter *Admin* or *User* as the username and the appropriate password and click [OK](#).**
The Basic Mode Home Page opens.

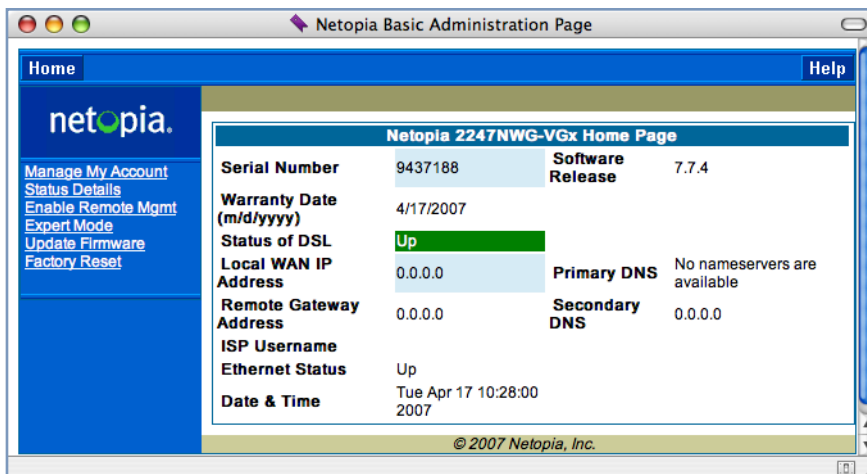

3. **Click on the [Expert Mode](#) link in the left-hand column of links.**

You are challenged to confirm your choice.

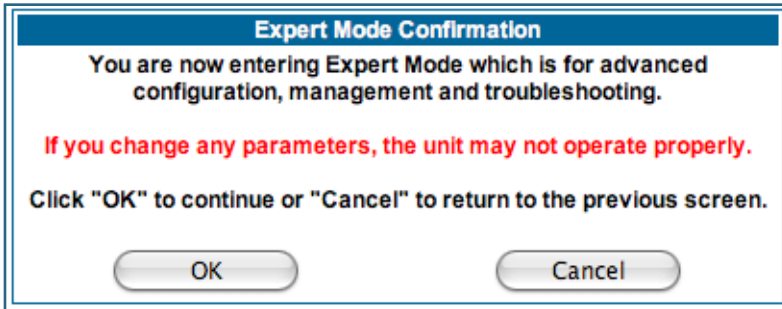

Click **OK**.

The Home Page opens in Expert Mode.

Home Page - Expert Mode

The Home Page is the summary page for your Motorola Netopia® Gateway. The toolbar at the top provides links to controlling, configuring, and monitoring pages. Critical configuration and operational status is displayed in the center section.

General Information			
Hardware	Netopia Model 2247-41-10NA ADSL2 WIAD		
Serial Number	9437188		
Software Version	7.7.4	BreakWater Firewall	ClearSailing
Product ID	1225		
Date & Time	Fri Jun 1 10:07:20 2007	Safe Harbour	On
WAN			
Status	Up	Data Rate (Kbps)	Downstream: 8000 Upstream: 800
Local Address	0.0.0.0	Peer Address	0.0.0.0
Connection Type	Always On		
NAT	On	WAN Users	Unlimited
LAN			
IP Address	192.168.1.254		
Netmask	255.255.255.0	Ethernet Status	Up
DHCP Server	On	DHCP Leases	0 out of 253 leases in use
VoIP			
Line 1 Registration	Registered	Line 2 Registration	Registered
Line 1 Account	4004	Line 2 Account	4005

Home Page - Information

The Home page's center section contains a summary of the Gateway's configuration settings and operational status.

Summary Information	
Field	Status and/or Description
General Information	
Hardware	Model number and summary specification
Serial Number	Unique serial number, located on label attached to bottom of unit
Software Version	Release and build number of running Motorola Netopia® Operating System.
Product ID	Refers to internal circuit board series; useful in determining which software upgrade applies to your hardware type.
Date & Time	This is the current UTC time; blank if this is not available due to lack of a network connection.
Breakwater Firewall	<i>If the optional feature key is installed:</i> Status of the Breakwater Firewall: ClearSailing, SilentRunning, or LANdLocked.
Safe Harbour	<i>If the optional feature key is installed:</i> SafeHarbour VPN IPsec Tunnel option (if installed): either On or Off.
WAN	

Status	Wide Area Network may be Waiting for DSL (or other waiting status), Up or Down
Data Rate (Kbps)	Once connected, displays DSL speed rate, Downstream and Upstream
Local Address	IP address assigned to the WAN port.
Peer Address	The IP address of the gateway to which the connection defaults. If doing DHCP, this info will be acquired. If doing PPP, this info will be negotiated.
Connection Type	May be either Instant On or Always On.
NAT	On or Off . <i>ON</i> if using Network Address Translation to share the IP address across many LAN users.
WAN Users	Displays the number of users allotted and the total number available for use.

LAN

IP Address	Internal IP address of the Motorola Netopia® Gateway.
Netmask	Defines the IP subnet for the LAN Default is 255.255.255.0 for a Class C device
DHCP Server	On or Off . <i>ON</i> if using DHCP to get IP addresses for your LAN client machines.
DHCP Leases	A "lease" is held by each LAN client that has obtained an IP address through DHCP.
Ethernet (or USB) Status	Status of your Ethernet network connection (if supported). Up or Down .

VoIP

Line 1/2 Registration	If your Gateway is so equipped, voice Line 1 and/or 2 is either Idle or Registered
-----------------------	--

Toolbar

The toolbar is the dark blue bar at the top of the page containing the major navigation buttons. These buttons are available from almost every page, allowing you to move freely about the site.

Home	Configure	Troubleshoot	Security	Install	Restart	Help
	Quickstart	System Status	Passwords	Install Certificate		
	LAN	Network Tools	Firewall	Install Key		
	WAN	Diagnostics	IPSec	Install Software		
	Advanced		Stateful Inspection			
			Packet Filter			
			Security Log			

Navigating the Web Interface

[Link: Breadcrumb Trail](#)

The breadcrumb trail is built in the light brown area beneath the toolbar. As you navigate down a path within the site, the trail is built from left to right. To return anywhere along the path from which you came, click on one of the links.



Restart

Button: Restart

The Restart button on the toolbar allows you to restart the Gateway at any time. You will be prompted to confirm the restart before any action is taken. The Restart Confirmation message explains the consequences of and reasons for restarting the Gateway.

Restart Gateway

Restarting the Gateway is needed to enable:

- **Changes to your Gateway database configuration**
- **New feature keys**
- **Operating System Software Upgrades**

When you restart:

- **All users will be disconnected**
- **You will be returned to the Home page**
- **The Gateway will not respond to your web requests. This inactivity may last for approximately 2 minutes.**

[Restart Gateway](#)

[Link: Alert Symbol](#)

The Alert symbol appears in the upper right corner if you make a database change; one in which a change is made to the Gateway's configuration. The Alert serves as a reminder that you must **Save** the changes and **Restart** the Gateway before the change will take effect. You can make many changes on various pages, and even leave the browser for up to 5 minutes, but if the Gateway is restarted before the changes are applied, they will be lost. When you click on the Alert symbol, the Save Changes page appears. Here you can select various options to save or discard these changes.

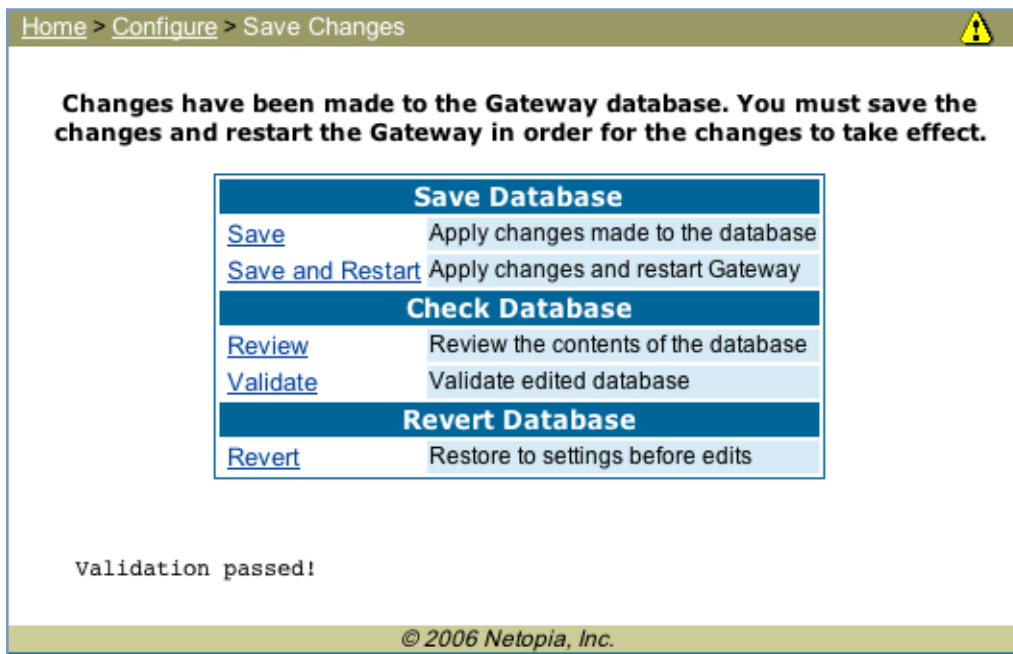

If more than one Alert is triggered, you will need to take action to clear the first Alert before you can see the second Alert.

A screenshot of the 'Save Changes' page. The breadcrumb path is 'Home > Configure > Save Changes'. A yellow warning icon is in the top right corner. The main message reads: 'Changes have been made to the Gateway database. You must save the changes and restart the Gateway in order for the changes to take effect.' Below this is a table of actions:

Save Database	
Save	Apply changes made to the database
Save and Restart	Apply changes and restart Gateway

Check Database	
[Review](#)	Review the contents of the database
[Validate](#)	Validate edited database
Revert Database	
---	---
[Revert](#)	Restore to settings before edits

Validation passed!

© 2006 Netopia, Inc.

Help

Button: [Help](#)

Context-sensitive Help is provided in your Gateway. The page shown here is displayed when you are on the Home page or other transitional pages. To see a context help page example, go to [Security -> Pass-words](#), then click [Help](#).

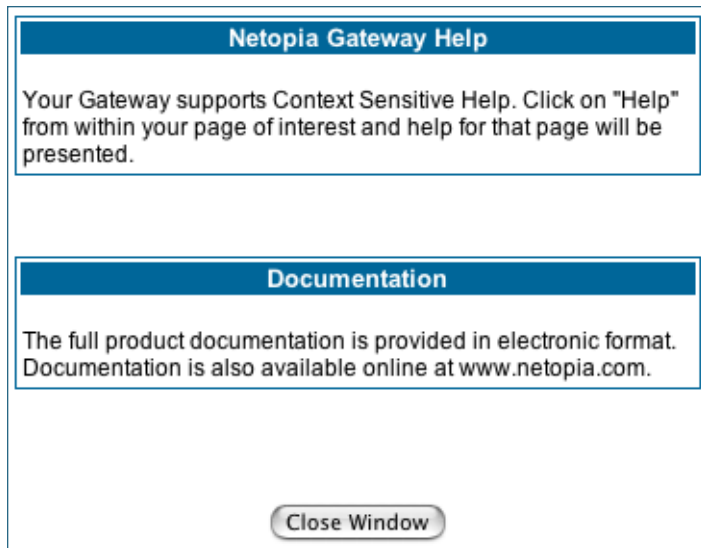

Configure

Button: [Configure](#)

The Configuration options are presented in the order of likelihood you will need to use them. **Quickstart** is typically accessed during the hardware installation and initial configuration phase. **Often, these settings should be changed only in accordance with information from your Service Provider. LAN and WAN** settings are available to fine-tune your system. **Advanced** provides some special capabilities typically used for gaming or small office environments, or where LAN-side servers are involved.



This button will not be available if you log on as *User*.

Link: [Quickstart](#)

How to Use the Quickstart Page. Quickstart is normally used immediately after the new hardware is installed. When you are first configuring your Gateway, Quickstart appears first.

(Once you have configured your Gateway, logging on displays the Home page. Thereafter, if you need to use Quickstart, choose it from the Expert Mode Configure menu.)

Setup Your Gateway using a PPP Connection.

This example screen is the for a **PPP Quickstart** configuration. Your gateway authenticates with the Service Provider equipment using the ISP Username and Password. These values are given to you by your Service Provider.

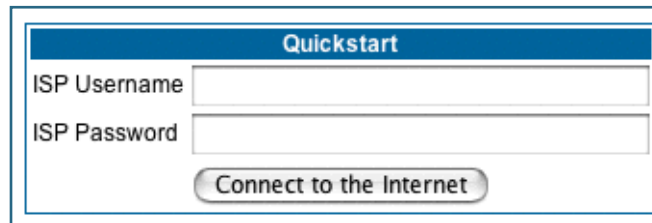

1. Enter your ISP Username and ISP Password.
2. Click [Connect to the Internet](#).

A brief message is displayed while the Gateway attempts to establish a connection.

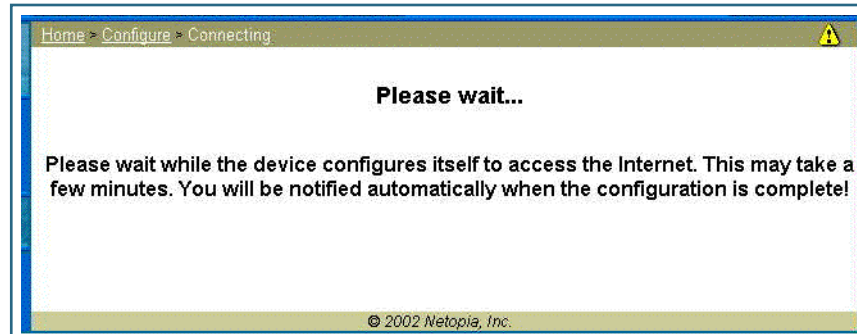

3. **When the connection succeeds, your browser will display your Service Provider's home page.**

If you encounter any problems connecting, refer to the chapters "[Basic Troubleshooting](#)" on page 193 or "[Advanced Troubleshooting](#)" on page 207.

[Link: LAN](#)

LAN IP Interface (Ethernet 100BT)

Enable Interface

IP Address

IP Netmask

Restrictions

Other LAN Options

Advanced	Configure advanced IP settings
IP Subnets	Configure more LAN IP Subnets
DHCP Server	Configure DHCP server options
Wireless	Configure Wireless Options

* **Enable Interface:** Enables all LAN-connected computers to share resources and to connect to the WAN. The Interface should always be enabled unless you are instructed to disable it by your Service Provider during troubleshooting.

* **IP Address:** The LAN IP Address of the Gateway. The IP Address you assign to your LAN interface must not be used by another device on your LAN network.

* **IP Netmask:** Specifies the subnet mask for the TCP/IP network connected to the virtual circuit. The subnet mask specifies which bits of the 32-bit binary IP address represent network information. The default subnet mask for most networks is 255.255.255.0 (Class C subnet mask.)

* **Restrictions:** Specifies whether an administrator can open a Web Administrator or Telnet connection to the Gateway over the LAN interface in order to monitor and configure the Gateway. On the LAN Interface, you can enable or disable administrator access. By default, administrative restrictions are turned off, meaning an administrator can open a Web Administrator or Telnet connection through the LAN Interface.

• **Advanced:** Clicking on the Advanced link displays the Advanced LAN IP Interface page.

Advanced LAN IP Interface (Ethernet 100BT)

IGMP Forwarding

RIP Send Mode

RIP Receive Mode

Proxy ARP

Static Client Address Translation

- **IGMP Forwarding:** The default setting is Disabled. If you check this option, it will enable Internet Group Management Protocol (IGMP) multicast forwarding. IGMP allows a router to determine which host groups have members on a given network segment. See [“IGMP \(Internet Group Management Protocol\)” on page 100](#) for more information.
- **RIP Send Mode:** Specifies whether the gateway should use Routing Information Protocol (RIP) broadcasts to advertise its routing tables to other routers on your network. You may choose from the following protocols:
 - RIP-1: Routing Information Protocol version 1
 - RIP-2: RIP Version 2 is an extension of the original Routing Information Protocol (RIP-1) that expands the amount of useful information in the RIP packets. While RIP-1 and RIP-2 share the same basic algorithms, RIP-2 supports several new features, including inclusion of subnet masks in RIP packets and implementation of multicasting instead of broadcasting (which reduces the load on hosts which do not support routing protocols).
 - RIP-1 compatibility: Compatible with RIP version 1
 - RIP-2 with MD5: MD5 authentication is an extension of RIP-2 that increases security by requiring an authentication key when routes are advertised.
 - RIP MD5 Key: Secret password when using RIP-2 with MD5.
- **RIP Receive Mode:** Specifies whether the Gateway should use Routing Information Protocol (RIP) broadcasts to update its routing tables with information received from other routers on your network. The protocol choices are the same as for the RIP send mode.
- **Proxy ARP:** Specifies whether you want the Gateway to respond when it receives an address resolution protocol for devices behind it. This is a way to make a computer that is physically located on one network appear to be part of a different physical network connected to the same Gateway. It allows you to hide a computer with a public IP address on a private network behind your Gateway, and still have the computer appear to be on the public network “in front of” the Gateway.
- **Static Client Address Translation:** If you check this checkbox, this feature allows a statically addressed computer whose IP address falls outside of the LAN subnet(s) to simply plug in and get online without any manual configuration on either the host or the Motorola Netopia® Gateway. If enabled, statically addressed LAN hosts that have an address outside of LAN subnets will be able to communicate via the Router’s WAN interface to the Internet. Supported static IP address values *must* fall *outside* of the Router's LAN subnet(s).
- **IP Subnets:** The IP Subnets screen allows you to configure up to seven secondary subnets and their DHCP ranges, by entering IP address/subnet mask pairs:

To edit an IP subnet entry, select the entry and press the "Edit" button.

IP Subnets				
On	IP Address	Netmask	DHCP Start	DHCP End
N	0.0.0.0	0.0.0.0	0.0.0.0	0.0.0.0
N	0.0.0.0	0.0.0.0	0.0.0.0	0.0.0.0
N	0.0.0.0	0.0.0.0	0.0.0.0	0.0.0.0
N	0.0.0.0	0.0.0.0	0.0.0.0	0.0.0.0
N	0.0.0.0	0.0.0.0	0.0.0.0	0.0.0.0
N	0.0.0.0	0.0.0.0	0.0.0.0	0.0.0.0
N	0.0.0.0	0.0.0.0	0.0.0.0	0.0.0.0



Note:

You need not use this screen if you have only a single Ethernet IP subnet.

This screen displays seven rows of editable columns. All seven row labels are always visible, regardless of the number of subnets configured.

- To add an IP subnet, select one of the rows, and click the [Edit](#) button.

The screenshot shows a form titled "IP Subnet Entry". It contains a checkbox labeled "Enabled" which is currently unchecked. Below the checkbox is a "Submit" button.

Check the **Enabled** checkbox and click the [Submit](#) button.

The screen expands to allow you to enter subnet information.

The screenshot shows the expanded "IP Subnet Entry" form. It includes the "Enabled" checkbox, which is now checked. Below it are four input fields: "IP Address" (0.0.0.0), "Netmask" (0.0.0.0), "DHCP Start Address" (0.0.0.0), and "DHCP End Address" (0.0.0.0). A "Submit" button is located at the bottom of the form.

If **DHCP Server** (see below) is not enabled, the DHCP Start Address and DHCP End Address fields do not appear.

- Enter the Router's IP address on the subnet in the **IP Address** field and the subnet mask for the subnet in the **Netmask** field.
- Enter the **DHCP Start Address** and **End Address** of the subnet range in their respective fields. Ranges cannot overlap and there may be only one range per subnet.
- Click the [Submit](#) button.
- When you are finished adding subnets, click the **Alert** icon at the upper right, and in the resulting page, click the [Save and Restart](#) link.

To delete a configured subnet, set both the IP address and subnet mask values to 0.0.0.0, either explicitly or by clearing each field and clicking the [Submit](#) button to commit the change.



NOTE:

All additional DHCP ranges use the global lease period value. See [page 52](#).

• **DHCP Server:** Your Gateway can provide network configuration information to computers on your LAN, using the Dynamic Host Configuration Protocol (DHCP).

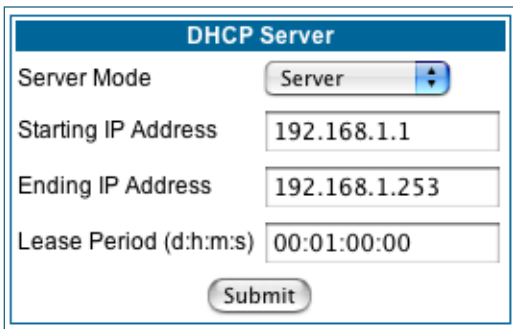

DHCP Server	
Server Mode	Server
Starting IP Address	192.168.1.1
Ending IP Address	192.168.1.253
Lease Period (d:h:m:s)	00:01:00:00
<input type="button" value="Submit"/>	

If you already have a DHCP server on your LAN, you should turn this service off.

If you want the Gateway to provide this service, click the **Server Mode** pull-down menu, choose **Server**, then configure the range of IP addresses that you would like the Gateway to hand out to your computers.

You can also specify the length of time the computers can use the configuration information; DHCP calls this period the lease time.

Your Service Provider may, for certain services, want to provide configuration from its DHCP servers to the computers on your LANs. In this case, the Gateway will relay the DHCP requests from your computers to a DHCP server in the Service Provider's network. Click the relay-agent and enter the IP address of the Service Provider's DHCP server in the Server Address field. This address is furnished by the Service Provider.



NOTE:

The **Relay-agent** option only works when NAT is off and the Gateway is in router mode.

Wireless (supported models)

If your Gateway is a wireless model (such as a 3347W) you can enable or disable the wireless LAN (WLAN) by clicking the [Wireless](#) link.

Wireless functionality is enabled by default.

802.11 Wireless Settings

Enable Wireless

SSID (Network ID) 5440 4401

Privacy OFF - No Privacy

Submit

Other Wireless Options

[Advanced Configuration Options](#)

If you uncheck the **Enable Wireless** checkbox, the Wireless Options are disabled, and the Gateway will not provide or broadcast any wireless LAN services.

SSID (Network ID): The SSID is preset to a number that is unique to your unit. You can either leave it as is, or change it by entering a freeform name of up to 32 characters, for example “Ed’s Wireless LAN”. On client PCs’ software, this might also be called the *Network Name*. The SSID is used to identify this particular wireless LAN. Depending on their operating system or client wireless card, users must either:

- select from a list of available wireless LANs that appear in a scanned list on their client
- or, if you are in Closed System Mode (see **Enable Closed System Mode** below), enter this name on their clients in order to join this wireless LAN.

The pull-down menu for enabling **Privacy** offers four settings: **WPA-802.1x**, **WPA-PSK**, **WEP - Automatic**, and **Off - No Privacy**. **WEP-Manual** is also available on the Advanced Configuration Options page. [See “Privacy” on page 54.](#)



NOTE:

On the 2200-Series Gateways, **WEP-Manual** privacy is enabled by default. Use the Motorola Netopia® Installation Wizard on the accompanying Motorola Netopia® CD to generate WEP keys for connecting wireless client computers.

Privacy

- **Off - No Privacy** provides no encryption on your wireless LAN data.
- **WPA-802.1x** provides RADIUS server authentication support.
- **WPA-PSK** provides Wireless Protected Access, the most secure option for your wireless network. This mechanism provides the best data protection and access control.

The **Pre Shared Key** is a passphrase shared between the Router and the clients and is used to generate dynamically changing keys. The passphrase can be 8-63 characters or up to 64 hex characters. It is recommended to use at least 20 characters for best security.

- **WEP - Automatic** is a passphrase generator. You enter a passphrase that you choose in the **Passphrase** field. The passphrase can be any string of words or numbers.
You can provide a level of data security by enabling WEP (Wired Equivalent Privacy) for encryption of network data. You can enable 40-, 128-, or 256-bit WEP Encryption (depending on the capability of your client wireless card) for IP traffic on your LAN.

You select a single key for encryption of outbound traffic. The WEP-enabled client must have an identical key of the same length, in the identical slot (1 – 4) as the Gateway, in order to successfully receive and decrypt the traffic. Similarly, the client also has a ‘default’ key that it uses to encrypt its transmissions. In order for the Gateway to receive the client’s data, it must likewise have the identical key of the same length, in the same slot. For simplicity, a Gateway and its clients need only enter, share, and use the first key.

The screenshot shows the '802.11 Wireless Settings' configuration page. It features a blue header with the title '802.11 Wireless Settings'. Below the header, there are several configuration options: 'Enable Wireless' is checked; 'SSID (Network ID)' is set to '4414 0400'; 'Privacy' is set to 'WEP - Automatic'; a blue instruction bar reads 'Select a key size and enter a passphrase below; then click Submit'; 'Encryption Key Size' is set to '40/64 bit (10 characters)'; 'Passphrase' is 'howdydoodo'; 'Encryption Key' is 'abcdefabcd'; and 'Default Key' is '1'. A 'Submit' button is located at the bottom center of the form.

Click the [Submit](#) button. The Alert icon appears.

Click the Alert icon, and then the [Save and Restart](#) link.

Advanced

If you click the [Advanced](#) link, the advanced **802.11 Wireless Settings** page appears.

802.11 Wireless Settings	
Enable Wireless	<input checked="" type="checkbox"/>
Wireless ID (SSID)	4414 0400
Operating Mode	Normal (802.11b+g)
Default Channel	6
AutoChannel Setting	OFF - Use default
Enable Closed System Mode	<input type="checkbox"/>
Block Wireless Bridging	<input type="checkbox"/>
Privacy	WEP - Automatic
Enter a passphrase below, and click Submit to make keys.	
WEP key passphrase	howdydoody
Encryption Key Size #1	40/64 bit (10 characters)
Encryption Key #1	abcdefabcd
Encryption Key Size #2	40/64 bit (10 characters)
Encryption Key #2	efabcdefab
Encryption Key Size #3	40/64 bit (10 characters)
Encryption Key #3	cdefabcdef
Encryption Key Size #4	40/64 bit (10 characters)
Encryption Key #4	abcdefabcd
Use WEP encryption key(1-4) #	1
Submit	
Other Wireless Options	
Multiple SSIDs	Enable and Configure Multiple SSIDs
WiFi Multimedia	Enable and Configure WMM
MAC Authorization	Limit Wireless Access by MAC Address

Note: This page displays different options depending on which form of Privacy or other options you have enabled.

You can then configure:

Operating Mode: The pull-down menu allows you to select and lock the Gateway into the wireless transmission mode you want. For compatibility with clients using 802.11**b** (up to 11 Mbps transmission) and 802.11**g** (up to 20+ Mbps), select **Normal (802.11b + g)**. To limit your wireless LAN to one mode or the other, select **802.11b Only**, or **802.11g Only**.



NOTE:

If you choose to limit the operating mode to 802.11b or 802.11g only, clients using the mode you excluded will not be able to connect.

Default Channel: on which the network will broadcast. This is a frequency range within the 2.4Ghz band. Channel selection depends on government regulated radio frequencies that vary from region to region. The widest range available is from 1 to 14. However, in North America only 1 to 11 may be selected. Europe,

France, Spain and Japan will differ. Channel selection can have a significant impact on performance, depending on other wireless activity close to this Gateway. Channel selection is not necessary at the client computers; the clients will scan the available channels seeking access points using the same SSID as the client.

AutoChannel Setting: For 802.11G models, AutoChannel is a feature that allows the Motorola Netopia® Gateway to determine the best channel to broadcast automatically.

Three settings are available from the pull-down menu: **Off-Use default**, **At Startup**, and **Continuous**.

- **Off-Use default** is the default setting; the Motorola Netopia® Gateway will use the configured default channel selected from the previous pull-down menu.
- **At Startup** causes the Motorola Netopia® Gateway at startup to briefly initialize on the default channel, then perform a full two- to three-second scan, and switch to the best channel it can find, remaining on that channel until the next reboot.
- **Continuous** performs the at-startup scan, and will continuously monitor the current channel for any other Access Point beacons. If an Access Point beacon is detected on the same channel, the Motorola Netopia® Gateway will initiate a three- to four-minute scan of the channels, locate a better one, and switch. Once it has switched, it will remain on this channel for at least 30 minutes before switching again if another Access Point is detected.

Enable Closed System Mode: If enabled, Closed System Mode hides the wireless network from the scanning features of wireless client computers. Unless both the wireless clients and the Router share the same SSID in Closed System mode, the Router's wireless LAN will not appear as an available network when scanned for by wireless-enabled computers. Members of the Closed System WLAN must log onto the Router's wireless network with the identical SSID as that configured in the router.

Closed System mode is an ideal way to increase wireless security and to prevent casual detection by unwanted neighbors, office users, or malicious users such as hackers.

If you do not enable Closed System Mode, it is more convenient, but potentially less secure, for clients to access your WLAN by scanning available access points. You must decide based on your own network requirements.

About Closed System Mode

Enabling Closed System Mode on your wireless Gateway provides another level of security, since your wireless LAN will no longer appear as an available access point to client PCs that are casually scanning for one.

Your own wireless network clients, however, must log into the wireless LAN by using the exact SSID of the Motorola Netopia® Gateway.

In addition, if you have enabled WEP encryption on the Motorola Netopia® Gateway, your network clients must also have WEP encryption enabled, and must have the same WEP encryption key as the Motorola Netopia® Gateway.

Once the Motorola Netopia® Gateway is located by a client computer, by setting the client to a matching SSID, the client can connect immediately if WEP is not enabled. If WEP is enabled then the client must also have WEP enabled and a matching WEP key.

Wireless client cards from different manufacturers and different operating systems accomplish connecting to a wireless LAN and enabling WEP in a variety of ways. Consult the documentation for your particular wireless card and/or operating system.



NOTE:

While clients may also have a passphrase feature, these are vendor-specific and may not necessarily create the same keys. You can passphrase generate a set of keys on one, and manually enter them on the other to get around this.

Block Wireless Bridging: Check the checkbox to block wireless clients from communicating with other wireless clients on the LAN side of the Gateway.

- **WEP - Manual** allows you to enter your own encryption keys manually. This is a difficult process, but only needs to be done once. Avoid the temptation to enter all the same characters.

802.11 Wireless Settings

Enable Wireless	<input checked="" type="checkbox"/>
Wireless ID (SSID)	<input type="text" value="4414 0400"/>
Operating Mode	Normal (802.11b+g) ▾
Default Channel	6 ▾
AutoChannel Setting	OFF - Use default ▾
Enable Closed System Mode	<input type="checkbox"/>
Block Wireless Bridging	<input type="checkbox"/>
Privacy	WEP - Manual ▾
Encryption Key Size #1	40/64 bit (10 characters) ▾
Encryption Key #1	<input type="text" value="abcdefghijkl"/>
Encryption Key Size #2	40/64 bit (10 characters) ▾
Encryption Key #2	<input type="text" value="efghijklmno"/>
Encryption Key Size #3	40/64 bit (10 characters) ▾
Encryption Key #3	<input type="text" value="pqrstuvwxyz"/>
Encryption Key Size #4	40/64 bit (10 characters) ▾
Encryption Key #4	<input type="text" value="abcdefghijklmnop"/>
Use WEP encryption key (1-4) #	1 ▾
<input type="button" value="Submit"/>	

Other Wireless Options:

Multiple SSIDs	Enable and Configure Multiple SSIDs
WiFi Multimedia	Enable and Configure WMM
MAC Authorization	Limit Wireless Access by MAC Address

Encryption Key Size #1 – #4: Selects the length of each encryption key. The longer the key, the stronger the encryption and the more difficult it is to break the encryption.

Encryption Key #1 – #4: The encryption keys. You enter keys using hexadecimal digits. For 40/64bit encryption, you need ten digits; 26 digits for 128bit, and 58 digits for 256bit WEP. Hexadecimal characters are 0 – 9, and a – f.

Examples:

- 40bit: 02468ACE02
- 128bit: 0123456789ABCDEF0123456789
- 256bit: 592CA140F0A238B0C61AE162F592CA140F0A238B0C61AE162F21A09C

Use WEP encryption key (1 – 4) #: Specifies which key the Gateway will use to encrypt transmitted traffic. The default is key #1.

You disable the wireless LAN by unchecking the Enable Wireless checkbox, clicking the [Submit](#) button, followed by the [Save and Restart](#) link.

WPA Version Allowed

If you select either **WPA-802.1x** or **WPA-PSK** as your privacy setting, the **WPA Version Allowed** pull-down menu appears to allow you to select the WPA version(s) that will be required for client connections. Choices are:

- **WPA Version 1 and 2**, for maximum interoperability,
- **WPA Version 1 Only**, for backward compatibility,
- **WPA Version 2 Only**, for maximum security.

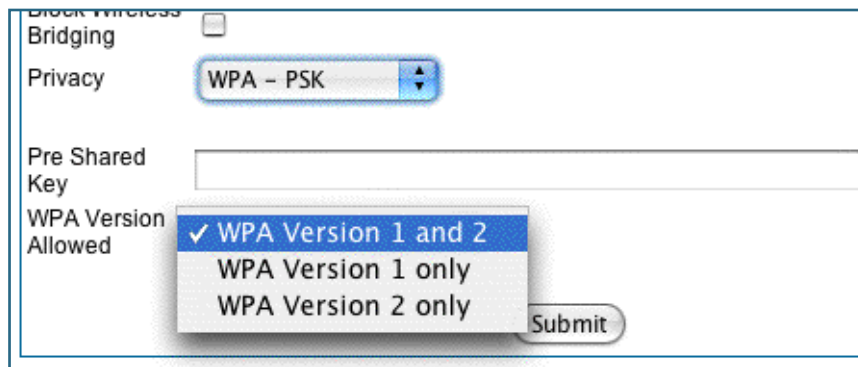

All clients must support the version(s) selected in order to successfully connect.

Multiple SSIDs

The **Multiple Wireless SSIDs** feature allows you to add additional network identifiers (SSIDs or *Network Names*) for your wireless network.

To enable Multiple Wireless SSIDs, click the [Multiple SSIDs](#) link.

When the Multiple Wireless SSIDs screen appears, check the **Enable SSID** checkbox for each SSID you want to enable.

Multiple Wireless SSIDs

Enable SSID #2

Enable SSID #3

Enable SSID #4

The screen expands to allow you to name each additional Wireless ID, and specify a Privacy mode for each one.

Multiple Wireless SSIDs

Enable SSID #2

SSID #2

Privacy

Pre Shared Key

WPA Version Allowed

Enable SSID #3

Enable SSID #4

Privacy modes available from the pull-down menu for the multiple SSIDs are: **WPA-PSK**, **WPA-802.1x**, or **Off-No Privacy. WEP** can also be selected on the additional SSIDs as long as it is not used on the primary SSID. WEP can only be used on one SSID, so any others will not have WEP available.

These additional Wireless IDs are “Closed System Mode” Wireless IDs that will not be shown by a client scan, and therefore must be manually configured at the client. In addition, wireless bridging between clients is disabled for all members of these additional network IDs.

Click the **Submit** button.

After your first entry, the Alert icon  will appear in the upper right corner of your screen. When you are finished adding SSIDs, click the Alert icon, and Save your changes and restart the Gateway.

WiFi Multimedia

WiFi Multimedia is an advanced feature that allows you to prioritize various types of data travelling over the wireless network. Certain types of data that are sensitive to delays, such as voice or video, must be prioritized ahead of other, less delay-sensitive types, such as email.

WiFi Multimedia currently implements wireless Quality of Service (QoS) by transmitting data depending on Diffserv priority settings. These priorities are mapped into four Access Categories (AC), in increasing order of priority:

- Background (BK),
- Best Effort (BE),
- Video (VI), and
- Voice (VO).

It requires WiFi Multimedia (WMM)-capable clients, usually a separate feature enabled at the client network settings, and client PC software that makes use of Differentiated Services (Diffserv). Refer to your operating system instructions for enabling Diffserv QoS..

When you click the [WiFi Multimedia](#) link the **WiFi Multimedia** page appears.



WiFi Multimedia

WMM Mode: Disabled

Submit

To enable the WiFi Multimedia custom settings, select **Diffserv** from the pull-down menu.

The screen expands.

WiFi Multimedia

WMM Mode:

Warning - It is not recommended that you modify these settings without direct knowledge or instructions to do so. Modifying these settings inappropriately could have an undesirable impact on network performance.

Router EDCA Parameters

Access Categories (AC)	AIFs	cwMin	cwMax
VOICE: (VO):	<input type="text" value="1"/>	<input type="text" value="3"/>	<input type="text" value="7"/>
VIDEO: (VI):	<input type="text" value="1"/>	<input type="text" value="7"/>	<input type="text" value="15"/>
BEST-EFFORT: (BE):	<input type="text" value="3"/>	<input type="text" value="15"/>	<input type="text" value="63"/>
BACKGROUND: (BK):	<input type="text" value="7"/>	<input type="text" value="15"/>	<input type="text" value="1023"/>

Client EDCA Parameters

Access Categories (AC)	AIFs	cwMin	cwMax	TXOP Limit
VOICE: (VO):	<input type="text" value="2"/>	<input type="text" value="3"/>	<input type="text" value="7"/>	<input type="text" value="1504"/>
VIDEO: (VI):	<input type="text" value="2"/>	<input type="text" value="7"/>	<input type="text" value="15"/>	<input type="text" value="3008"/>
BEST-EFFORT: (BE):	<input type="text" value="3"/>	<input type="text" value="15"/>	<input type="text" value="1023"/>	<input type="text" value="0"/>
BACKGROUND: (BK):	<input type="text" value="7"/>	<input type="text" value="15"/>	<input type="text" value="1023"/>	<input type="text" value="0"/>

Router EDCA Parameters (Enhanced Distributed Channel Access) govern wireless data from your Gateway to the client; **Client EDCA Parameters** govern wireless data from the client to your Gateway.



NOTE:

It is not recommended that you modify these settings without direct knowledge or instructions to do so. Modifying these settings inappropriately could seriously degrade network performance.

- **AIFs:** (Arbitration Interframe Spacing) the wait time in milliseconds for data frames.
- **cwMin:** (Minimum Contention Window) upper limit in milliseconds of the range for determining initial random backoff. The value you choose must be lower than cwMax.
- **cwMax:** (Maximum Contention Window) upper limit in milliseconds of the range of determining final random backoff. The value you choose must be higher than cwMin.
- **TXOP Limit:** Time interval in microseconds that clients may initiate transmissions.
(When **Operating Mode** is **B-only**, default values are used and this field is not configurable.)

Wireless MAC Authorization

Wireless MAC Authorization allows you to specify which client PCs are allowed to join the wireless LAN by specific hardware address. Once it is enabled, only entered MAC addresses that have been set to *Allow* will

be accepted onto the wireless LAN. All unlisted addresses will be blocked, in addition to the listed addresses with *Allow* disabled.

To enable Wireless MAC Authentication, click the [MAC Authorization](#) link.

When the Wireless MAC Authentication screen appears, check the **Enable Wireless MAC Authorization** checkbox:

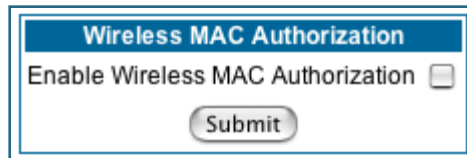

Wireless MAC Authorization
Enable Wireless MAC Authorization
Submit

The screen expands as follows:

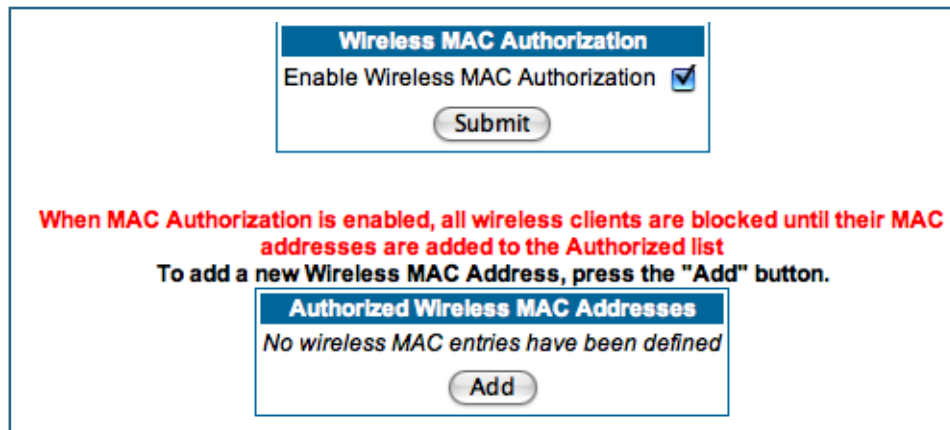

Wireless MAC Authorization
Enable Wireless MAC Authorization
Submit

When MAC Authorization is enabled, all wireless clients are blocked until their MAC addresses are added to the Authorized list
To add a new Wireless MAC Address, press the "Add" button.

Authorized Wireless MAC Addresses
No wireless MAC entries have been defined
Add

Click the [Add](#) button. The **Authorized Wireless MAC Address Entry** screen appears.

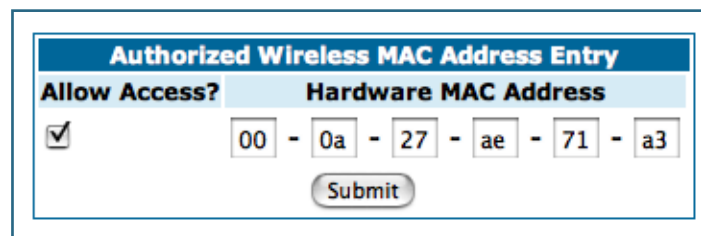

Authorized Wireless MAC Address Entry

Allow Access?	Hardware MAC Address
<input checked="" type="checkbox"/>	00 - 0a - 27 - ae - 71 - a3

Submit

Enter the MAC (hardware) address of the client PC you want to authorize for access to your wireless LAN. The **Allow Access?** checkbox is enabled by default. Unchecking this checkbox specifically denies access from this MAC address. Click the [Submit](#) button.



Note:

When MAC Authorization is enabled, all wireless clients are blocked until their MAC addresses

are added to the Authorized list.

Your entry will be added to a list of up to 32 authorized addresses as shown:

The screenshot shows a web interface for configuring wireless MAC authentication. At the top, there is a section titled "Wireless MAC Authentication" with a checkbox labeled "Enable Wireless MAC Authentication:" which is checked. Below this is a "Submit" button. In the center, there is instructional text: "To add a new Wireless MAC Address, press the 'Add' button. To edit or delete a Wireless MAC Address, select the entry and press the 'Edit' or 'Delete' button." Below this text is a section titled "Authorized Wireless MAC Addresses" containing a list with one entry: "Wireless MAC Address = 00-0a-27-ae-71-a3 - Allowed". At the bottom of this section are three buttons: "Add", "Edit", and "Delete".

You can continue to [Add](#), [Edit](#), or [Delete](#) addresses to the list by clicking the respective buttons.

After your first entry, the Alert icon  will appear in the upper right corner of your screen. When you are finished adding addresses to the list, click the Alert icon, and Save your changes and restart the Gateway.

Use RADIUS Server

RADIUS servers allow external authentication of users by means of a remote authentication database. The remote authentication database is maintained by a Remote Authentication Dial-In User Service (RADIUS) server. In conjunction with Wireless User Authentication, you can use a RADIUS server database to authenticate users seeking access to the wireless services, as well as the authorized user list maintained locally within the Gateway.

If you click the [RADIUS](#) link, the screen expands to allow you to enter your RADIUS server information.

The screenshot shows a web interface for configuring RADIUS servers. The title is "Radius Servers". It contains five input fields: "RADIUS Server Addr/Name", "RADIUS Server Secret", "Alt RADIUS Server Addr/Name", "Alt RADIUS Server Secret", and "Radius Server Port". The "Radius Server Port" field has the value "1812" entered. At the bottom is a "Submit" button.

- **RADIUS Server Addr/Name:** The default RADIUS server name or IP address that you want to use.
- **RADIUS Server Secret:** The RADIUS secret key used by this server. The shared secret should have the same characteristics as a normal password.
- **RADIUS Server Port:** The port on which the RADIUS server is listening, typically, the default 1812.

Click the [Submit](#) button.

You can also configure alternate RADIUS servers from the Advanced Network Configuration page, by clicking the [Advanced](#) link.

The **Advanced Network Configuration** page appears.

Network Configuration	
IP Static Routes	Build IP static route table
IP Static ARP	Build IP static ARP table
NAT	
Pinholes	Set up pinholes through NAT
IPMaps	Set up NAT one-to-one IP address mappings
Default Server	Set up NAT default server options
Services	
Differentiated Services	Set up Differentiated Service options
DNS	Set up DNS options
DHCP Server	Set up DHCP server and relay-agent options
RADIUS Server	Set up RADIUS server options
SNMP	Set up SNMP community, trap and system group options
IGMP	Set up IGMP options
UPnP	Enable or disable Universal Plug'n'Play
LAN Management (TR-064)	Enable or disable DSL Forum LAN-Side DSL CPE Configuration services
Ethernet Bridge	Set up ethernet MAC bridge
VLAN	Set up VLAN Configuration
VoIP	Set up VoIP Configuration
Miscellaneous	
System	Configure System parameters
Syslog Parameters	Set up Syslog
Internal Servers	Configure internal web and telnet ports
Software Hosting	Set up Software Hosting
Backup	Set up Backup options
Clear Options	Restore the Gateway to its factory configuration
Time Zone	Time Zone settings

You access the RADIUS Server configuration screen from the Advanced Network Configuration web page, by clicking the [RADIUS Server](#) link.

Link: [WAN](#)

When you click the [WAN](#) link, the WAN IP configuration page appears. This page varies depending on the WAN interface of your Motorola Netopia® Gateway.

WAN IP Interfaces: Your IP interfaces are listed.

PPP over Ethernet interface

WAN IP Interfaces

[PPP over Ethernet vcc1](#) [Configure this IP interface](#)

IP Gateway

Enable Gateway Option

Interface Type [PPP \(vcc1\)](#)

[Submit](#)

Other WAN Options

[ATM](#) Set up ATM circuits

Click the [PPP over Ethernet](#) link to configure it.

The **WAN IP Interface** page appears.

WAN IP Interface (PPP over Ethernet vcc1)

Enable Interface

Address Mapping (NAT)

Restrictions [Admin Disabled](#)

DHCP/PPPoE/PPPoA Autosensing: [PPPoE/DHCP](#)

ISP Username

ISP Password

Connection Type [Always-On](#)

[Submit](#)

Other Interface Options

[Advanced](#) Advanced settings for this interface

Enable Interface: You can disable the interface by unchecking the checkbox. However, doing so will disable all ability for your LAN users to connect to the WAN using the Gateway.

Address Mapping (NAT): Specifies whether you want the Gateway to use network address translation (NAT) when communicating with remote routers. NAT lets you conceal details of your network from remote routers. By default, address mapping is enabled.

Restrictions: This setting determines the types of traffic the Gateway accepts from the WAN. **Admin Disabled** means that Gateway traffic is accepted but administrative commands are ignored. **None** means that all traffic is accepted. When PPP is enabled, **Admin Disabled** is the default.

DHCP/PPPoE/PPPoA Autosensing:

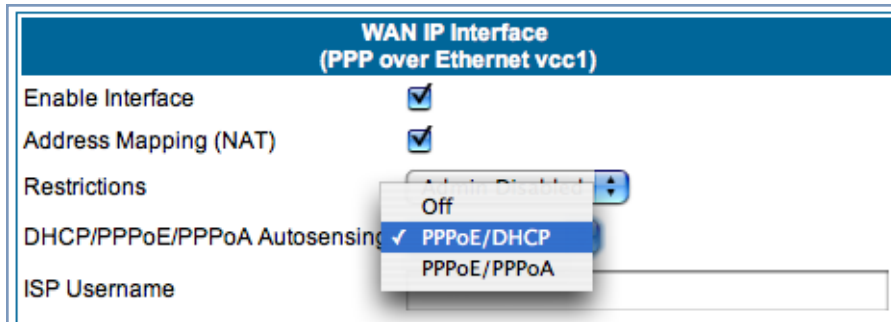

The pull-down menu allows you to select an autosensing feature, or to disable it. Selecting between PPPoE/DHCP or PPPoE/PPPoA enables automatic sensing of your WAN connection type. If you select **PPPoE/DHCP**, the gateway attempts to connect using PPPoE first. If the Gateway

fails to connect after 60 seconds, it switches to DHCP. As soon as it can connect via DHCP, the Gateway chooses and sets DHCP as its default. Otherwise, after attempting to connect via DHCP for 60 seconds, the Gateway switches back to PPPoE. The Gateway will continue to switch back and forth in this manner until it successfully connects. Similarly, selecting **PPPoE/PPPoA** causes the Gateway to attempt to connect by trying these protocols in parallel, and using the first one that is successful. If you choose to disable the feature, select **Off**.

ISP Username: This is the username used to authenticate your Gateway with the Service Provider's network. This value is given to you by your Service Provider.

ISP Password: This is the password used to authenticate your Gateway with the Service Provider's network. This value is given to you by your Service Provider.

Connection Type: The pull-down menu allows you to choose to have either an uninterrupted connection or an as-needed connection.

- **Always On:** This setting provides convenience, but it leaves your network permanently connected to the Internet.
- **Instant On** furnishes almost all the benefits of an Always On connection, but has additional security benefits:
 - Your network cannot be attacked when it is not connected.
 - Your network may change address with each connection, making it more difficult to attack.

Timeout: (only appears if Instant-On Connection Type is selected) Specifies the time in seconds before disconnect if there is no traffic over the Internet link.

Advanced:

If you click the [Advanced](#) link, the **Advanced WAN IP Interface** configuration page appears.

Advanced WAN IP Interface (PPP over Ethernet vcc1)	
Local Address	<input type="text" value="0.0.0.0"/>
Peer Address	<input type="text" value="0.0.0.0"/>
RIP Receive Mode	<input type="text" value="Off"/>
Multicast Forward	<input checked="" type="checkbox"/>
IGMP Null Source Address	<input type="checkbox"/>
LCP Settings	
Authentication	<input type="text" value="PAP and/or CHAP"/>
MRU	<input type="text" value="1492"/>
Magic Number	<input checked="" type="checkbox"/>
Protocol Compression	<input type="checkbox"/>
LCP Echo Requests	<input checked="" type="checkbox"/>
Max Failures	<input type="text" value="10"/>
Max Configures	<input type="text" value="10"/>
Max Terminates	<input type="text" value="2"/>
Restart Timer	<input type="text" value="3"/>
<input type="button" value="Submit"/>	

Local Address: If this value is 0.0.0.0, the Gateway will acquire its IP address from your ISP. Otherwise this address is assigned to the virtual PPP interface.

Peer Address: Address of the server on the Service Provider side of the ppp link. This peer will attempt to negotiate the local IP address if IP Address = 0.0.0.0. If the remote peer does not accept the IP address, the link will not come up.

RIP Receive Mode: Routing Information Protocol (RIP) is needed if there are IP routers on other segments of your Ethernet network that the Motorola Netopia® Gateway needs to recognize. Set to **Off**, Netopia Embedded Software Version 7.7.4 will not accept information from either RIP-1 nor RIP-2 routers. With Receive RIP Mode set to **RIP-1**, the Motorola Netopia® Gateway will accept routing information provided by RIP packets from other routers that use the same subnet mask. Set to **RIP-2**, Netopia Embedded Software Version 7.7.4 will accept routing information provided by RIP packets from other routers that use different subnet masks.

From the pull-down menu, choose **Off**, **RIP-1**, **RIP-2**, **RIP-1 compatibility**, or **RIP-2 with MD5**.

RIP Receive MD5 Key: (Only appears if RIP-2 with MD5 RIP Receive Mode is selected) The purpose of MD5 authentication is to provide an additional level of confidence that a RIP packet received was generated by a reliable source. In other words, MD5 authentication provides an enhanced level of security that information that your PC receives does not originate from a malicious source posing as part of your network. This field allows you to enter an MD5 encryption key of from 1 – 16 ASCII characters for authenticating RIP receipts.

Multicast Forward: If you check this checkbox, this interface acts as an IGMP proxy host, and IGMP packets are transmitted and received on this interface on behalf of IGMP hosts on the LAN interface.

IGMP Null Source Address: If you check this checkbox, the source IP address of every IGMP packet transmitted from this interface is set to 0.0.0.0. This complies with the requirements of TR-101, and removes the need for a publicly advertised IP address on the WAN interface. This checkbox is only available if “Multicast Forward” is checked.

LCP Settings:

Authentication: Select **Off**, **PAP and/or CHAP**, **PAP only**, or **CHAP only** from the pull-down menu. The settings for port authentication on the Gateway must match the authentication expected by the remote system. The username and passwords are available on the WAN IP Interfaces page.

MRU: Specifies the Maximum Receive Unit for the PPP Interface.

Magic Number: Enables or disables LCP magic number negotiation.

Protocol Compression: Specifies whether you want the Gateway to compress the PPP Protocol field when it transmits datagrams over the PPP link.

LCP Echo Requests: Specifies whether you want your Gateway to send LCP echo requests. You should turn off LCP echoing if you do not want the Gateway to drop a PPP link to a nonresponsive peer.

Max Failures: Specifies the maximum number of Configure-NAK messages the PPP module can send without having sent a Configure-ACK message.

Max Configures: Specifies the maximum number of unacknowledged configuration requests that your Gateway will send.

Max Terminates: Specifies the maximum number of unacknowledged termination requests that your Gateway will send before terminating the PPP link.

Restart Timer: The number of seconds the Gateway should wait before retransmitting a configuration or termination request.

Click the [Submit](#) button when you are finished.

Ethernet WAN interface

The screenshot shows a web interface for configuring WAN IP interfaces. At the top, there is a blue header with the text "WAN IP Interfaces". Below this header, there are two main sections. The first section is titled "Ethernet WAN" and includes a link to "Configure this IP interface". The second section is titled "IP Gateway" and contains a checkbox labeled "Enable Gateway Option" which is currently unchecked, and a "Submit" button. Below these sections, there is a third section titled "Other WAN Options" which includes a link to "PPPoE" and the text "Configure PPP over Ethernet settings".

Click the [Ethernet WAN](#) link to configure it.

The **WAN IP Interface** page appears.

The screenshot shows the configuration page for the WAN IP Interface (Ethernet WAN). It features a blue header with the title. Below the header, there are four rows of settings: 'Enable Interface' with a checked checkbox, 'Obtain IP Address Automatically' with a checked checkbox, 'Address Mapping (NAT)' with a checked checkbox, and 'Restrictions' with a dropdown menu set to 'Admin Disabled'. A 'Submit' button is located at the bottom center of the form.

The screenshot shows the 'Other Interface Options' section. It has a blue header with the title. Below the header, there are two tabs: 'Advanced' (which is selected and highlighted in light blue) and 'Advanced settings for this interface'.

Enable Interface: You can disable the interface by unchecking the checkbox. However, doing so will disable all ability for your LAN users to connect to the WAN using the Gateway.

Obtain IP Address Automatically: Your service provider may tell you that the WAN IP Address for your Gateway is static. In this case, disable this checkbox and enter the IP Address and IP Netmask from your Service Provider in the appropriate fields.

The screenshot shows the configuration page for the WAN IP Interface (RFC-1483 Bridged Ethernet vcc1). It features a blue header with the title. Below the header, there are six rows of settings: 'Enable Interface' with a checked checkbox, 'Obtain IP Address Automatically' with an unchecked checkbox, 'IP Address' with a text input field containing '0.0.0.1', 'IP Netmask' with a text input field containing '255.255.255.0', 'Address Mapping (NAT)' with a checked checkbox, and 'Restrictions' with a dropdown menu set to 'Admin Disabled'. A 'Submit' button is located at the bottom center of the form.

IP Address: This is the IP Address from your Service Provider when using static IP addressing.

IP Netmask: This is the Netmask from your Service Provider when using static IP addressing.



NOTE:

Beginning with Firmware Version 7.7, you can now run an IPoE interface without an IP address (“unnumbered” interface), if you un-check “Obtain IP Address Automatically” and set the IP Address to 0.

Address Mapping (NAT): Specifies whether you want the Gateway to use network address translation (NAT) when communicating with remote routers. NAT lets you conceal details of your network from remote routers. By default, address mapping is enabled.

Restrictions: This setting determines the types of traffic the Gateway accepts from the WAN. **Admin Disabled** means that Gateway traffic is accepted but administrative commands are ignored. **None** means that all traffic is accepted. **Admin Disabled** is the default.

Advanced:

If you click the [Advanced](#) link the **Advanced WAN IP Interface** configuration page appears.

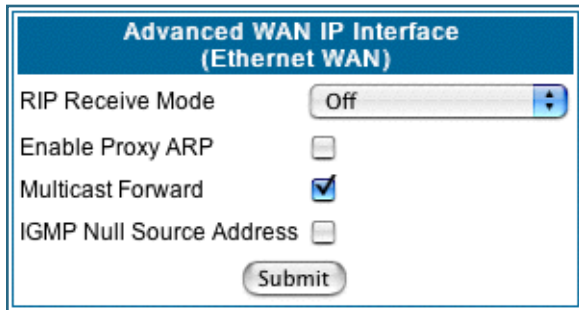

RIP Receive Mode: Routing Information Protocol (RIP) is needed if there are IP routers on other segments of your Ethernet network that the Motorola Netopia® Gateway needs to recognize. Set to **Off**, Netopia Embedded Software Version 7.7.4 will not accept information from either RIP-1 nor RIP-2 routers. With Receive RIP Mode set to **RIP-1**, the Motorola Netopia® Gateway will accept routing information provided by RIP packets from other routers that use the same subnet mask. Set to **RIP-2**, Netopia Embedded Software Version 7.7.4 will accept routing information provided by RIP packets from

other routers that use different subnet masks.

From the pull-down menu, choose **Off**, **RIP-1**, **RIP-2**, **RIP-1 compatibility**, or **RIP-2 with MD5**.

Enable Proxy ARP: Checking the checkbox will enable the Gateway to respond when it receives an Address Resolution Protocol message for devices behind it.

Multicast Forward: If you check this checkbox, this interface acts as an IGMP proxy host, and IGMP packets are transmitted and received on this interface on behalf of IGMP hosts on the LAN interface.

IGMP Null Source Address: If you check this checkbox, the source IP address of every IGMP packet transmitted from this interface is set to 0.0.0.0. This complies with the requirements of TR-101, and removes the need for a publicly advertised IP address on the WAN interface. This checkbox is only available if “Multicast Forward” is checked.

IP Gateway

Enable Gateway Option: You can configure the Gateway to send packets to a default gateway if it does not know how to reach the destination host.

Interface Type: If you have PPPoE enabled, you can specify that packets destined for unknown hosts will be sent to the gateway being used by the remote PPP peer. If you select ip-address, you must enter the IP address of a host on a local or remote network to receive the traffic.

Default Gateway: The IP Address of the default gateway.

Other WAN Options

PPPoE: You can enable or disable PPPoE. This link also allows configuration of NAT, admin restrictions, PPPoE username/password, and connection type.

PPP over Ethernet

Enable PPPoE

PPPoE with IPoE

Number of Sessions

WAN Ethernet and VDSL Gateways

To allow for concurrent PPPoE and IPoE support on WAN Ethernet Gateways, including VDSL units, **PPPoE with IPoE** is available on the PPPoE configuration page. Checking the checkbox will provide this concurrent support. When you enable PPPoE with IPoE, the additional WAN interface becomes available for configuration.

WAN IP Interfaces

[PPP over Ethernet WAN](#) Configure this IP interface

[Ethernet WAN](#) Configure this IP interface

IP Gateway

Enable Gateway Option

Interface Type

Other WAN Options

[PPPoE](#) Configure PPP over Ethernet settings



NOTE:

Enabling pppoe-with-ipoe disables support for multiple PPPoE sessions.

ADSL Gateways

ATM Circuits: You can configure the ATM circuits and the number of Sessions. The IP Interface(s) should be reconfigured after making changes here.

Available Encapsulation types:

PPP over Ethernet (PPPoE)
 PPP over ATM (PPPoA)
 RFC-1483 Bridged Ethernet
 RFC-1483 Routed IP
 None

Available Multiplexing types:

LLC/SNAP
 VC muxed

ATM Circuits					
VCC	VPI	VCI	Encapsulation	Multiplexing	PPPoE Sessions
1	0	0	PPP over Ethernet	LLC/SNAP	1

To turn off a VCC, set its encapsulation to **None**.
To turn on another VCC, [Click Here](#).

Other ATM Options
[ATM Traffic Shaping](#) Configure ATM Traffic Shaping Options

Your Motorola Netopia® ADSL Gateway supports VPI/VCI autodetection by default. If VPI/VCI autodetection is enabled, the ATM Circuits page displays VPI/VCI = 0. If you configure a new ATM VPI/VCI pair, upon saving and restarting, autodetection is disabled and only the new VPI/VCI pair configuration will be enabled.

VPI/VCI Autodetection consists of eight static VPI/VCI pair configurations. These are 0/35, 8/35, 0/32, 8/32, 1/35, 1/1, 1/32, 2/32. These eight VPI/VCI pairs will be created if the Gateway is configured for autodetection. the Gateway does not establish a circuit using any of these preconfigured VPI/VCI pairs, then you can manually enter a VPI/VCI pair in the ATM Circuits page.

PPPoE with IPoE: For ADSL Gateways, you must configure two VCCs with the **same** VPI/VCI settings to provide concurrent PPPoE with IPoE support.

You must use fixed VPI/VCI values for PPPoE with IPoE. You cannot have both VPI/VCI values set to 0/0; autodetection does not work in this mode.

ATM Circuits					
VCC	VPI	VCI	Encapsulation	Multiplexing	PPPoE Sessions
1	0	36	PPP over Ethernet	LLC/SNAP	1
1	0	36	RFC-1483 Bridged Ethernet	LLC/SNAP	

To turn off a VCC, set its encapsulation to **None**.
To turn on another VCC, [Click Here](#).

Other ATM Options
[ATM Traffic Shaping](#) Configure ATM Traffic Shaping Options

WAN IP Interfaces	
PPP over Ethernet vcc1	Configure this IP interface
RFC-1483 Bridged Ethernet vcc1	Configure this IP interface

IP Gateway	
Enable Gateway Option	<input checked="" type="checkbox"/>
Interface Type	PPP (vcc1) ▾
<input type="button" value="Submit"/>	

Other WAN Options	
ATM	Set up ATM circuits

Once the VCCs have been configured, the WAN IP Interfaces screen displays the additional interface which you can then configure as required.

ATM Traffic Shaping: You can prioritize delay-sensitive data by configuring the Quality of Service (QoS) characteristics of the virtual circuit. Click the [ATM Traffic Shaping](#) link.

ATM Traffic Shaping				
VCC	Service Class	Peak Cell Rate	Sustained Cell Rate	Maximum Burst Size
1	<input checked="" type="checkbox"/> UBR <input type="checkbox"/> CBR <input type="checkbox"/> VBR	<input type="text" value="0"/>		

You can choose UBR (Unspecified Bit Rate), CBR (Constant Bit Rate), or VBR (Variable Bit Rate) from the pull-down menu and set the Peak Cell Rate (PCR) in the editable field.

UBR (Unspecified Bit Rate) guarantees no minimum transmission rate. Cells are transmitted on a “best effort” basis. However, there is a cap on the maximum transmission rate for UBR VCs. In a practical situation:

- UBR VCs should be transmitted at a priority lower than CBR.
- Bandwidth should be shared equally among UBR VCs.

UBR applications are non-real-time traffic such as IP data traffic.

CBR (Constant Bit Rate) guarantees a certain transmission rate (although the application may underutilize this bandwidth). A Peak Cell Rate (PCR) characterizes CBR. CBR is most suited for real time applications such as real time voice / video, although it can be used for other applications.

VBR (Variable Bit Rate) This class is characterized by:

- a **Peak Cell Rate** (PCR), which is a temporary burst, not a sustained rate, and
- a **Sustained Cell Rate** (SCR),
- a Burst Tolerance (BT), specified in terms of **Maximum Burst Size** (MBS). The MBS is the maximum number of cells that can be transmitted at the peak cell rate and should be less than, or equal to the Peak Cell Rate, which should be less than, or equal to the line rate.

VBR has two sub-classes:

a. VBR non-real-time (VBR-nrt): Typical applications are non-real-time traffic, such as IP data traffic. This class yields a fair amount of Cell Delay Variation (CDV).

b. VBR real time (VBR-rt): Typical applications are real-time traffic, such as compressed voice over IP and video conferencing. This class transmits cells with a more tightly bounded Cell Delay Variation. The applications follow CBR.

ATM Traffic Shaping				
VCC	Service Class	Peak Cell Rate	Sustained Cell Rate	Maximum Burst Size
1	<input type="button" value="VBR"/>	<input type="text" value="0"/>	<input type="text" value="0"/>	<input type="text" value="0"/>



Note:

The difference between VBR-rt and VBR-nrt is the tolerated Cell Delay Variation range and the provisioned Maximum Burst Size.

Class	PCR	SCR	MBS	Transmit Priority	Comments
UBR	X	N/A	N/A	Low	PCR is a cap
CBR	X	N/A	N/A	High	PCR is a guaranteed rate
VBR	X	X	X	High	PCR > SCR. SCR is a guaranteed rate. PCR is a cap.

[Link: Advanced](#)

Selected Advanced options are discussed in the pages that follow. Many are self-explanatory or are dictated by your service provider.

The following are typical links under Configure -> Advanced (some models offer other links):

Network Configuration	
IP Static Routes	Build IP static route table
IP Static ARP	Build IP static ARP table
NAT	
Pinholes	Set up pinholes through NAT
IPMaps	Set up NAT one-to-one IP address mappings
Default Server	Set up NAT default server options
Services	
Differentiated Services	Set up Differentiated Service options
DNS	Set up DNS options
DHCP Server	Set up DHCP server and relay-agent options
RADIUS Server	Set up RADIUS server options
SNMP	Set up SNMP community, trap and system group options
IGMP	Set up IGMP options
UPnP	Enable or disable Universal Plug'n'Play
LAN Management (TR-064)	Enable or disable DSL Forum LAN-Side DSL CPE Configuration services
Ethernet Bridge	Set up ethernet MAC bridge
VLAN	Set up VLAN Configuration
VoIP	Set up VoIP Configuration
Miscellaneous	
System	Configure System parameters
Syslog Parameters	Set up Syslog
Internal Servers	Configure internal web and telnet ports
Software Hosting	Set up Software Hosting
Backup	Set up Backup options
Clear Options	Restore the Gateway to its factory configuration
Time Zone	Time Zone settings

[Link: IP Static Routes](#)

A static route identifies a manually configured pathway to a remote network. Unlike dynamic routes, which are acquired and confirmed periodically from other routers, static routes do not time out. Consequently, static routes are useful when working with PPP, since an intermittent PPP link may make maintenance of dynamic routes problematic.

When you click the [Static Routes](#) link, the **IP Static Routes** page appears.

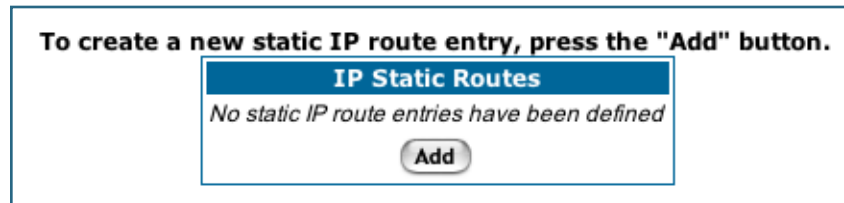

You can configure as many as 32 static IP routes for the Gateway. To add a static route, click the [Add](#) button.

The **IP Static Route Entry** page appears.

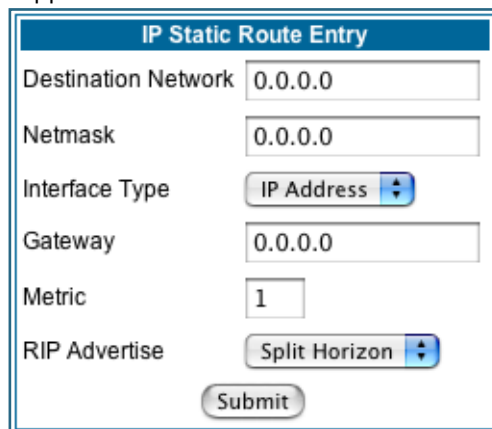

The screenshot shows the "IP Static Route Entry" form. It contains the following fields and options:

- Destination Network: 0.0.0.0
- Netmask: 0.0.0.0
- Interface Type: IP Address (dropdown menu)
- Gateway: 0.0.0.0
- Metric: 1
- RIP Advertise: Split Horizon (dropdown menu)

At the bottom of the form is a "Submit" button.

- **Destination Network:** Enter the IP address of the static route. It may not be 0.0.0.0.
- **Netmask:** Enter the subnet mask for the IP network at the other end of the static route. The subnet mask associated with the destination network must represent the same network class (A, B, or C) or a lower class (such as a class C subnet mask or class B network number) to be valid.
- **Interface Type:** Choose **PPP (vcc1)** – depending on the interface; typically vcc1 for DSL – or **IP Address** from the pull-down menu to specify whether the static route is accessible through PPP or IP address.
- **Gateway:** Enter the IP address of the gateway for the static route. The default gateway must be located on a network connected to your Motorola Netopia® Gateway configured interface.
- **Metric:** Specifies the hop count for the static route. Enter a number from 1 to 15 to indicate the number of routes (actual or best guess) a packet must traverse to reach the remote network. Some metric or a value of 1 will be used to indicate:
 - The remote network is one router away and the static route is the best way to reach it.
 - The remote network is more than one router away but the static route should not be replaced by a dynamic route, even if the dynamic route is more efficient.

- **RIP Advertise:** From the pull-down menu, choose how the static route should be advertised via RIP:
 - **Split Horizon:** Do not advertise route if the gateway is on the same subnet.
 - **Always:** Advertise route in all RIP messages.
 - **Never:** Do not advertise route.

Click the [Submit](#) button. The Alert icon  will appear, so that you can switch to the **Save Changes** page, when you are finished.

Once you save your changes, you will be returned to the IP Static Routes entry screen.

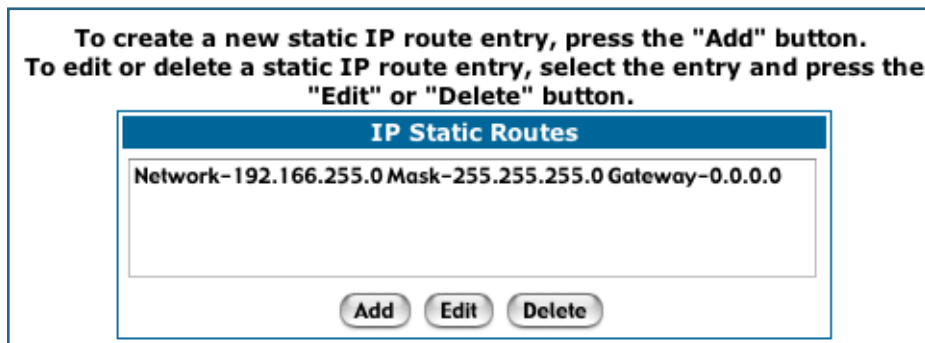

- You can continue to **Add**, **Edit**, or **Delete** Static Routes from this screen.

When you are finished, click the Alert icon , switch to the **Save Changes** page, and click the [Save Changes](#) link.

Link: IP Static ARP

Your Gateway maintains a dynamic Address Resolution Protocol (ARP) table to map IP addresses to Ethernet (MAC) addresses. It populates this ARP table dynamically, by retrieving IP address/MAC address pairs only when it needs them. Optionally, you can define static ARP entries to map IP addresses to their corresponding Ethernet MAC addresses. Unlike dynamic ARP table entries, static ARP table entries do not time out. The IP address cannot be 0.0.0.0. The Ethernet MAC address entry is in nn-nn-nn-nn-nn-nn (hexadecimal) format.

IP Static ARP Entry	
IP Address	Hardware MAC Address
<input type="text" value="0.0.0.0"/>	<input type="text" value="00"/> - <input type="text" value="00"/> - <input type="text" value="00"/> - <input type="text" value="00"/> - <input type="text" value="00"/> - <input type="text" value="00"/>
<input type="button" value="Submit"/>	

Link: Pinholes

Pinholes allow you to transparently route selected types of network traffic, such as FTP requests or HTTP (Web) connections, to a specific host behind the Gateway. Creating a pinhole allows access traffic originating from a remote connection (WAN) to be sent to the internal computer (LAN) that is specified in the Pinhole page.

Pinholes are common for applications like multiplayer online games. Refer to software manufacturer application documentation for specific traffic types and port numbers.

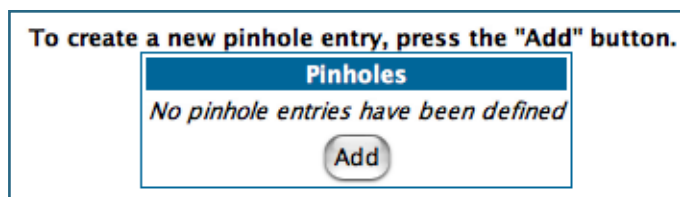

Configure Specific Pinholes. Planning for Your Pinholes. Determine if any of the service applications that you want to provide on your LAN stations use TCP or UDP protocols. If an application does, then you must configure a pinhole to implement port forwarding. This is accessed from the **Advanced -> Pinholes** page.

Example: A LAN Requiring Three Pinholes . The procedure on the following pages describes how you set up your NAT-enabled Motorola Netopia® Gateway to support three separate applications. This requires passing three kinds of specific IP traffic through to your LAN.

Application 1: You have a Web server located on your LAN behind your Motorola Netopia® Gateway and would like users on the Internet to have access to it. With NAT “On”, the only externally visible IP address on your network is the Gateway’s WAN IP (supplied by your Service Provider). All traffic intended for that LAN Web server must be directed to that IP address.

Application 2: You want one of your LAN stations to act as the “central repository” for all email for all of the LAN users.

Application 3: One of your LAN stations is specially configured for game applications. You want this specific LAN station to be dedicated to games.

A sample table to plan the desired pinholes is:

WAN Traffic Type	Protocol	Pinhole Name	LAN Internal IP Address
Web	TCP	my-webserver	192.168.1.1
Email	TCP	my-mailserver	192.168.1.2
Games	UDP	my-games	192.168.1.3

For this example, Internet protocols TCP and UDP must be passed through the NAT security feature and the Gateway’s embedded Web (HTTP) port must be re-assigned by configuring new settings on the Internal Servers page.



TIPS for making Pinhole Entries:

1. If the port forwarding feature is required for Web services, ensure that the embedded Web server's port number is re-assigned PRIOR to any Pinhole data entry.
2. Enter data for one Pinhole at a time.
3. Use a unique name for each Pinhole. If you choose a duplicate name, it will overwrite the previous information without warning.

A diagram of this LAN example is:

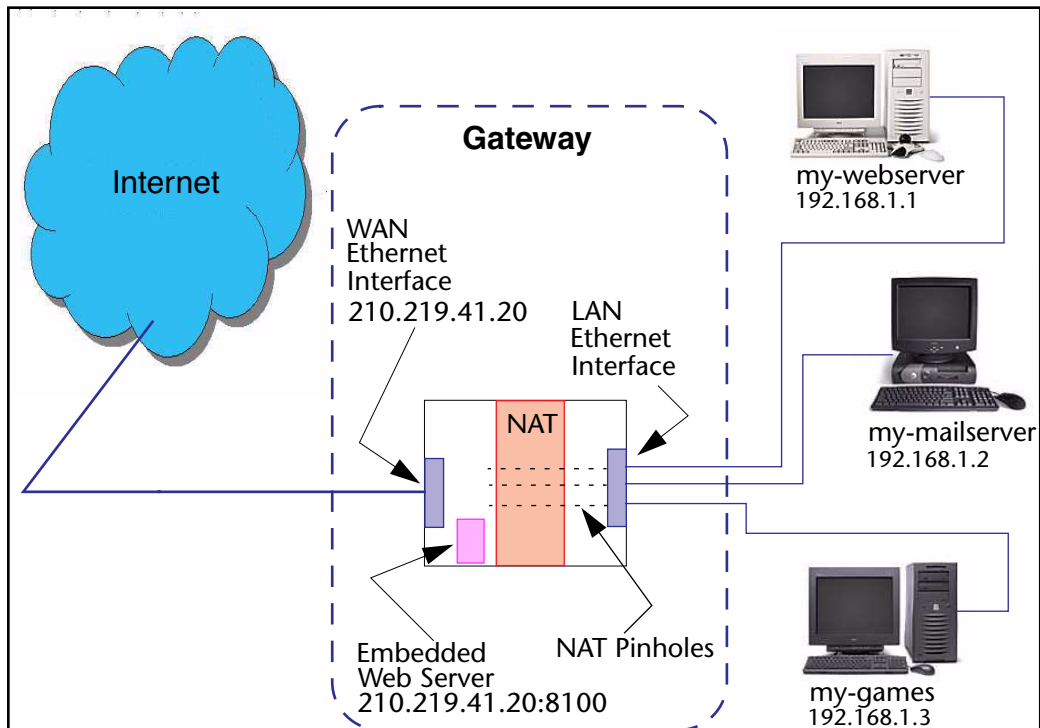

You can also use the LAN-side address of the Gateway, 192.168.1.x:8100 to access the web and 192.168.1.x:23 to access the telnet server.

Pinhole Configuration Procedure. Use the following steps:

1. From the [Configure](#) toolbar button -> [Advanced](#) link, select the [Internal Servers](#) link.

Since Port Forwarding is required for this example, the Motorola Netopia® embedded Web server is configured first.



NOTE:

The two text boxes, **Web (HTTP) Server Port** and **Telnet Server Port**, on this page refer to the port numbers of the Motorola Netopia® Gateway's *embedded administration ports*.

To pass Web traffic through to your LAN station(s), select a Web (HTTP) Port number that is greater than 1024. In this example, you choose 8100.

2. Type **8100** in the Web (HTTP) Server Port text box.

Internal Servers	
Enter a value from 1 to 65534, 0 to disable the server	
Web (HTTP) Server Port	8100
Telnet Server Port	23
<input type="button" value="Submit"/>	

3. Click the [Submit](#) button.
4. Click [Advanced](#). Select the [Pinholes](#) link to go to the Pinhole page.
5. Click [Add](#). Type your specific data into the Pinhole Entries table of this page. Click [Submit](#).

Pinhole Entry	
Pinhole Name	my-webserver
Protocol	TCP
External Port Start	80
External Port End	80
Internal IP Address	192.168.1.1
Internal Port	80
<input type="button" value="Submit"/>	
Add or Edit more Pinholes	

-
6. Click on the [Add or Edit more Pinholes](#) link. Click the [Add](#) button. Add the next Pinhole. Type the specific data for the second Pinhole.

Pinhole Entry	
Pinhole Name	<input type="text" value="my-mailserver"/>
Protocol	<input type="button" value="TCP"/> ▾
External Port Start	<input type="text" value="25"/>
External Port End	<input type="text" value="25"/>
Internal IP Address	<input type="text" value="192.168.1.2"/>
Internal Port	<input type="text" value="25"/>
<input type="button" value="Submit"/>	
Add or Edit more Pinholes	

7. Click on the [Add or Edit more Pinholes](#) link. Click the [Add](#) button. Add the next Pinhole. Type the specific data for the third Pinhole.

Pinhole Entry	
Pinhole Name	<input type="text" value="my-games"/>
Protocol	<input type="button" value="UDP"/> ▾
External Port Start	<input type="text" value="1100"/>
External Port End	<input type="text" value="1200"/>
Internal IP Address	<input type="text" value="192.168.1.3"/>
Internal Port	<input type="text" value="1100"/>
<input type="button" value="Submit"/>	
Add or Edit more Pinholes	



NOTE:

Note the following parameters for the “my-games” Pinhole:

1. The Protocol ID is UDP.
 2. The external port is specified as a range.
 3. The Internal port is specified as the lower range entry.
-

8. Click on the [Add or Edit more Pinholes](#) link. Review your entries to be sure they are correct.

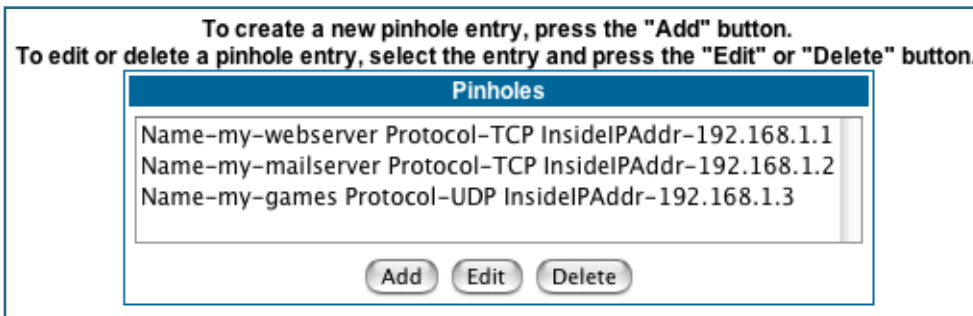

9. Click the [Alert](#) icon.
10. Click the [Save and Restart](#) link to complete the entire Pinhole creation task and ensure that the parameters are properly saved.



NOTE:

REMEMBER: When you have re-assigned the port address for the embedded Web server, you can still access this facility.

Use the Gateway's WAN address plus the new port number.

In this example it would be

<WAN Gateway address>:<new port number> or, in this case, 210.219.41.20:8100

You can also use the LAN-side address of the Gateway, 192.168.1.x:8100 to access the web and 192.168.1.x:23 to access the telnet server.

[Link: IPMaps](#)

IPMaps supports one-to-one Network Address Translation (NAT) for IP addresses assigned to servers, hosts, or specific computers on the LAN side of the Motorola Netopia® Gateway.

A single static or dynamic (DHCP) WAN IP address must be assigned to support other devices on the LAN. These devices utilize Motorola Netopia®'s default NAT/PAT capabilities.

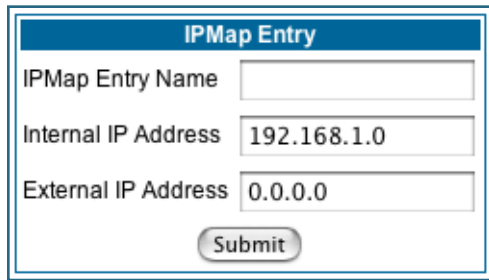

The screenshot shows a web form titled "IPMap Entry". It contains three input fields: "IPMap Entry Name" (empty), "Internal IP Address" (containing "192.168.1.0"), and "External IP Address" (containing "0.0.0.0"). Below the fields is a "Submit" button.

Configure the IPMaps Feature

FAQs for the IPMaps Feature

Before configuring an example of an IPMaps-enabled network, review these frequently asked questions.

What are IPMaps and how are they used? The IPMaps feature allows **multiple static** WAN IP addresses to be assigned to the Motorola Netopia® Gateway.

Static WAN IP addresses are used to support specific services, like a web server, mail server, or DNS server. This is accomplished by mapping a separate static WAN IP address to a specific internal LAN IP address. All traffic arriving at the Gateway intended for the static IP address is transferred to the internal device. All outbound traffic from the internal device appears to originate from the static IP address.

Locally hosted servers are supported by a public IP address while LAN users behind the NAT-enabled IP address are protected.

IPMaps is compatible with the use of NAT, with either a statically assigned IP address or DHCP/PPP served IP address for the NAT table.

What types of servers are supported by IPMaps? IPMaps allows a Motorola Netopia® Gateway to support servers behind the Gateway, for example, web, mail, FTP, or DNS servers. VPN servers are not supported at this time.

Can I use IPMaps with my PPPoE or PPPoA connection? Yes. IPMaps can be assigned to the WAN interface **provided they are on the same subnet**. Service providers will need to ensure proper routing to all IP addresses assigned to your WAN interface.

Will IPMaps allow IP addresses from different subnets to be assigned to my Gateway? IPMap will support statically assigned WAN IP addresses from the **same** subnet.

WAN IP addresses from different subnets are **not supported**.

IPMaps Block Diagram

The following diagram shows the IPMaps principle in conjunction with existing Motorola Netopia® NAT operations:

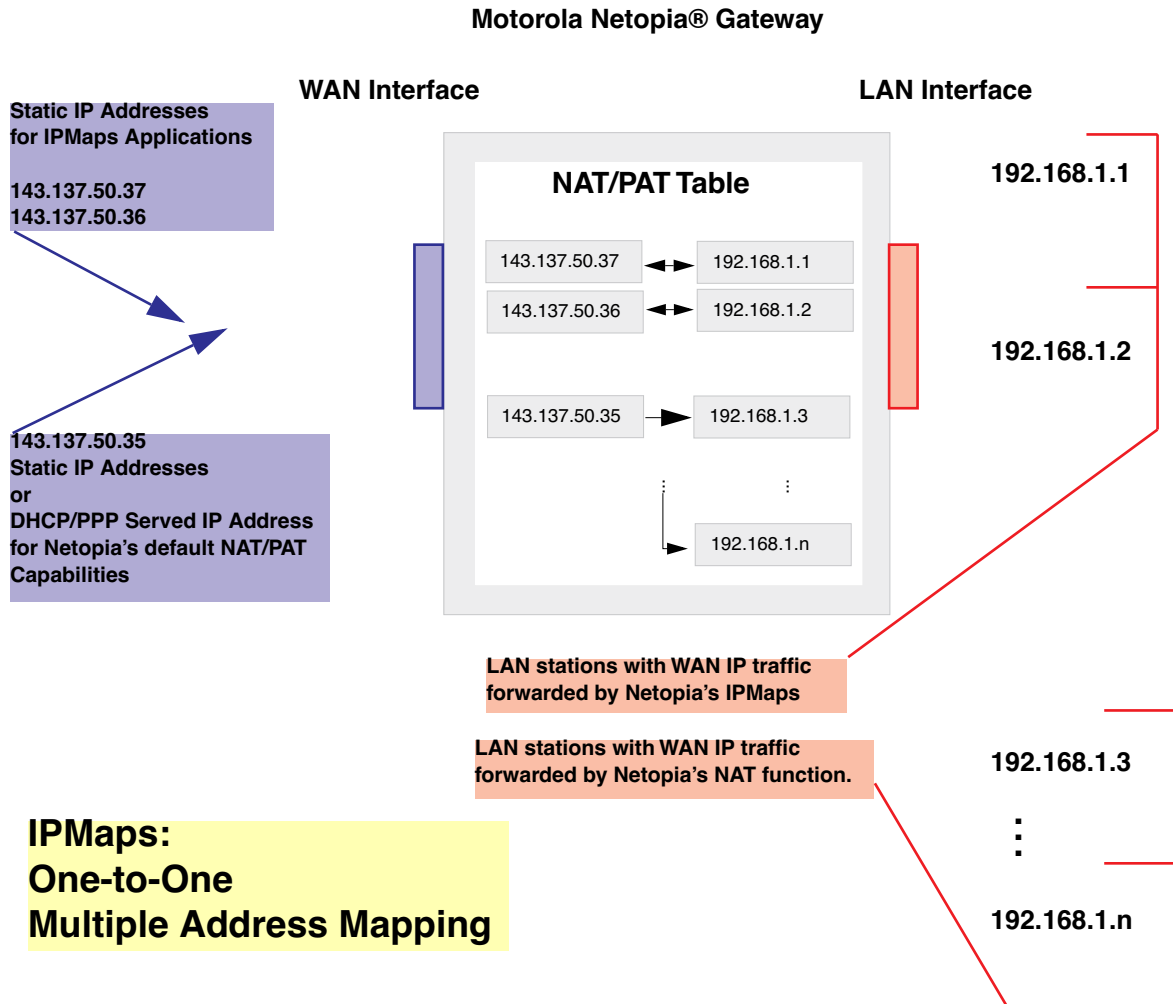

[Link: Default Server](#)

This feature allows you to:

- Direct your Gateway to forward all externally initiated IP traffic (TCP and UDP protocols only) to a default host on the LAN.

Enable it for certain situations:

- Where you cannot anticipate what port number or packet protocol an in-bound application might use. For example, some network games select arbitrary port numbers when a connection is opened.
 - When you want all unsolicited traffic to go to a specific LAN host.
- Configure for IP Passthrough.

Configure a Default Server. This feature allows you to direct unsolicited or non-specific traffic to a designated LAN station. With NAT “On” in the Gateway, these packets normally would be discarded.

For instance, this could be application traffic where you don’t know (in advance) the port or protocol that will be used. Some game applications fit this profile.

Use the following steps to setup a NAT default server to receive this information:

1. **Select the [Configure](#) toolbar button, then [Advanced](#), then the [Default Server](#) link.**

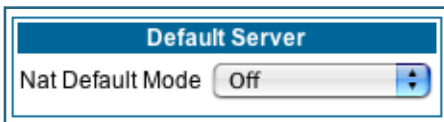

2. **From the pull-down menu, select [Default-Server](#).**

The NAT Server IP Address field appears.

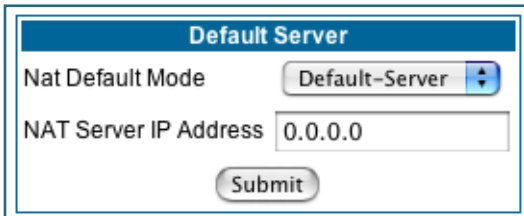

3. **Determine the IP address of the LAN computer you have chosen to receive the unexpected or unknown traffic.**

Enter this address in the NAT Server IP Address field.

4. **Click the [Submit](#) button.**
5. **Click the [Alert](#) button.**
6. **Click the [Save and Restart](#) link to confirm.**

Typical Network Diagram. A typical network using the NAT Default Server looks like this:

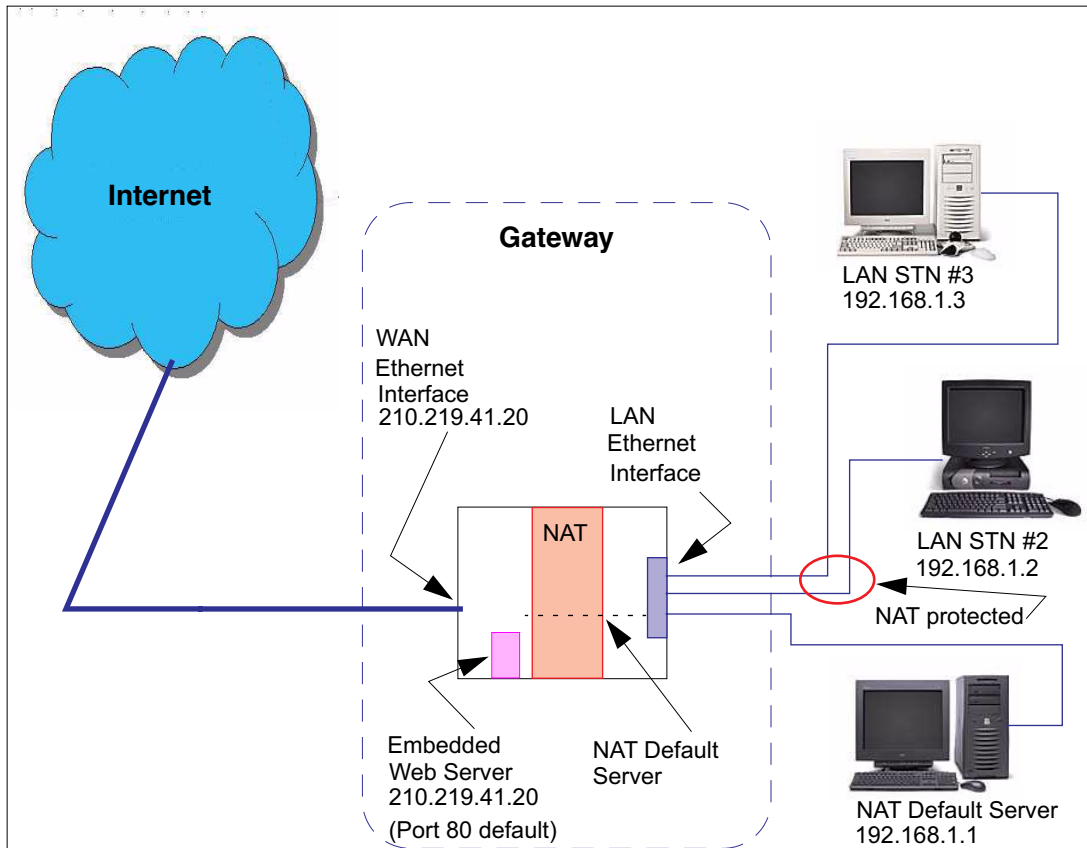

You can also use the LAN-side address of the Gateway, 192.168.1.x to access the web and telnet server.

NAT Combination Application. Motorola Netopia®'s NAT security feature allows you to configure a sophisticated LAN layout that uses **both** the Pinhole and Default Server capabilities.

With this topology, you configure the embedded administration ports as a first task, followed by the Pinholes and, finally, the NAT Default Server.

When using both NAT pinholes and NAT Default Server the Gateway works with the following rules (in sequence) to forward traffic from the Internet to the LAN:

1. **If the packet is a response to an existing connection created by outbound traffic from a LAN PC, forward to that station.**
2. **If not, check for a match with a pinhole configuration and, if one is found, forward the packet according to the pinhole rule.**
3. **If there's no pinhole, the packet is forwarded to the Default Server.**

IP-Passthrough. Your Gateway offers an IP passthrough feature. The IP passthrough feature allows a single PC on the LAN to have the Gateway's public address assigned to it. It also provides PAT (NAPT) via the same public IP address for all other hosts on the private LAN subnet. Using IP passthrough:

- The public WAN IP is used to provide IP address translation for private LAN computers.
- The public WAN IP is assigned and reused on a LAN computer.

- DHCP address serving can automatically serve the WAN IP address to a LAN computer. When DHCP is used for addressing the designated passthrough PC, the acquired or configured WAN address is passed to DHCP, which will dynamically configure a single-servable-address subnet, and reserve the address for the configured MAC address. This dynamic subnet configuration is based on the local and remote WAN address and subnet mask. If the WAN interface does not have a suitable subnet mask that is usable, for example when using PPP or PPPoE, the DHCP subnet configuration will default to a class C subnet mask.

The screenshot shows a configuration window titled "Default Server". It contains a dropdown menu for "Nat Default Mode" set to "IP-Passthrough". Below it is a checkbox for "DHCP Enable" which is currently unchecked. At the bottom of the window is a "Submit" button.

- If you want to manually assign the WAN address to a LAN PC, do not check the **DHCP Enable** checkbox.
- If you check the **DHCP Enable** checkbox, the screen expands.

This screenshot shows the same "Default Server" configuration window, but with the "DHCP Enable" checkbox checked. Below the checkbox, the "Host Hardware Address" field is populated with six boxes, each containing "00", separated by dashes: "00 - 00 - 00 - 00 - 00 - 00". The "Submit" button remains at the bottom.

The **Host Hardware Address** field displays. Here you enter the MAC address of the designated IP-Passthrough computer.

- If this MAC address is not all zeroes, then it will use DHCP to set the LAN host's address to the (configured or acquired) WAN IP address.
The MAC address must be six colon-delimited or dash-delimited sets of hex digits ('0' – 'FF').
- If you leave the MAC address as zeros then the first DHCP client will be assigned the WAN address.

Once configured, the passthrough host's DHCP leases will be shortened to two minutes. This allows for timely updates of the host's IP address, which will be a private IP address *before* the WAN connection is established. *After* the WAN connection is established and has an address, the passthrough host can renew its DHCP address binding to acquire the WAN IP address.

A restriction. Since both the Gateway and the passthrough host will use the same IP address, new sessions that conflict with existing sessions will be rejected by the Gateway. For example, suppose you are a teleworker using an IPSec tunnel from the Gateway *and* from the passthrough host. Both tunnels go to the same remote endpoint, such as the VPN access concentrator at your employer's office. In this case, the first one to start the IPSec traffic will be allowed; the second one – since, from the WAN, it's indistinguishable – will fail.

[Link: Differentiated Services](#)

When you click the [Differentiated Services](#) link, the Differentiated Services configuration screen appears.

Differentiated Services (Diffserv) allow your Gateway to make Quality of Service (QoS) decisions about what path Internet traffic, such as Voice over IP (VoIP), should travel across your network. For example, you may want streaming video conferencing to use high quality, but more restrictive, connections, or, you might want e-mail to use less restrictive, but less reliable, connections.

VDSL and Bonded ADSL models display this screen:

Most other models display this screen:

- To enable Differentiated Services, check the **Enable** checkbox.
- (Not displayed on VDSL and Bonded ADSL models) Enter a value from 60 to 100 (percent) in the **Low-High Priority Ratio** field. The default is 92.

Differentiated Services uses the low-to-high priority queue ratio to regulate traffic flow. For example, to provide the least possible latency and highest possible throughput for high priority traffic, you could set the ratio to 100(%). This would cause the gateway to forward low priority data *only after* the high priority queue is completely empty. In practice, you should set it to something less than 100%, since the low priority traffic might have to wait too long to be passed, and consequently be subject to time-outs.

Click the [Submit](#) button.

You can then define Custom Flows. If your applications do not provide Quality of Service (QoS) control, Custom Flows allows you to define streams for some protocols, port ranges, and between specific end point addresses.

- To define a custom flow, click the [Add](#) button. The Custom Flow Entry screen appears.

Custom Flow Entry

Name: Custom Flow 1

Protocol: TCP

Direction: Outbound

Start Port: 0

End Port: 0

Inside IP Address: 0.0.0.0

Inside IP Netmask: 0.0.0.0

Outside IP Address: 0.0.0.0

Outside IP Netmask: 0.0.0.0

Quality of Service (QoS): Off

Submit

[Add or Edit more Custom Flows](#)

- **Name** – Enter a name in this field to label the flow.
- **Protocol** – Select the protocol from the pull-down menu: TCP (default), UDP, ICMP, or Other. “Other” is appropriate for setting up flows on protocols with non-standard port definitions. IPSEC and PPTP are common examples.
- **Numerical Protocol** – If you select “Other” protocol, this field appears for you to provide its actual protocol number, with a range of 0 – 255.
- **Direction** – Choose Outbound (default), Inbound, or Both from the pull-down menu.
- **Start Port** – For TCP or UDP protocols, you can optionally specify a range of ports. Enter the starting port here.
- **End Port** – Enter the ending port here.
- **Inside IP Address/Netmask** – For outbound flows, specify an IP address/netmask on your LAN. For inbound flows, this setting is ignored. This setting marks packets from this LAN IP host/network based on the address and netmask information. For outbound flows, the Inside IP Address/Netmask is the source address. If you enter a zero IP address (0.0.0.0), the IP address/netmask fields

will be ignored.

- **Outside IP Address/Netmask** – If you want traffic destined for and originating from a certain WAN IP address to be controlled, enter the IP address and subnet mask here. If you leave the default all-zeroes, the outside address check is ignored.

For outbound flows, the outside address is the destination IP address for traffic; for inbound packets, the outside address is the source IP address.

Note:

When setting the Inside/Outside IP Address/Netmask settings, note that a netmask value can be used to configure for a network rather than a single IP address.

• **Quality of Service (QoS)** – This is the Quality of Service setting for the flow, based on the TOS bit information. Select Expedite, Assure, or Off (default) from the pull-down menu. The following table outlines the TOS bit settings and behavior:

QoS Setting	TOS Bit Value	Behavior
Off	TOS=000	This custom flow is disabled. You can activate it by selecting one of the two settings below. This setting allows you to pre-define flows without actually activating them.
Assure	TOS=001	Use normal queuing and throughput rules, but do not drop packets if possible. Appropriate for applications with no guaranteed delivery mechanism.
Expedite	TOS=101	Use minimum delay. Appropriate for VoIP and video applications.
Network Control	TOS=111	Use highest possible priority.

[Link: DNS](#)

Your Service Provider may maintain a Domain Name server. If you have the information for the DNS servers, enter it on the DNS page. If your Gateway is configured to use DHCP to obtain its WAN IP address, the DNS information is automatically obtained from that same DHCP Server.

If your service provider hosts a Domain Name Server, you may enter the domain name and IP address associated with the server here.

If you are receiving DNS information dynamically from your service provider, the server addresses must be entered as "0.0.0.0".

DNS	
Domain Name	<input type="text"/>
Primary DNS Server Address	<input type="text" value="0.0.0.0"/>
Secondary DNS Server Address	<input type="text" value="0.0.0.0"/>
<input type="button" value="Submit"/>	

[Link: DHCP Server](#)

Your Gateway can provide network configuration information to computers on your LAN, using the Dynamic Host Configuration Protocol (DHCP).

If you already have a DHCP server on your LAN, you should turn this service off.

If you want the Gateway to provide this service, select **Server** from the [Server Mode](#) pull-down menu, then configure the range of IP addresses that you would like the Gateway to hand out to your computers.

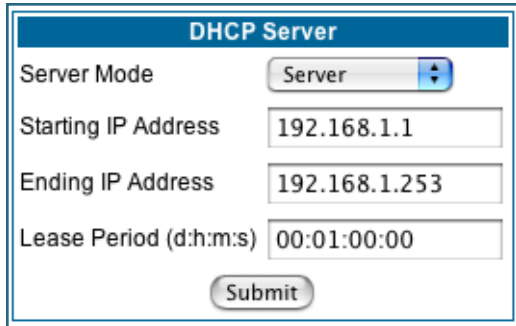

The screenshot shows a configuration window titled "DHCP Server". It contains the following fields and controls:

- Server Mode:** A pull-down menu with "Server" selected.
- Starting IP Address:** A text input field containing "192.168.1.1".
- Ending IP Address:** A text input field containing "192.168.1.253".
- Lease Period (d:h:m:s):** A text input field containing "00:01:00:00".
- Submit:** A button at the bottom of the form.

You can also specify the length of time the computers can use the configuration information; DHCP calls this period the lease time.

Your Service Provider may, for certain services, want to provide configuration from its DHCP servers to the computers on your LANs. In this case, the Gateway will relay the DHCP requests from your computers to a DHCP server in the Service Provider's network.

Select **Relay-agent** and enter the IP address of the Service Provider's DHCP server in the Server Address field. This address is furnished by the Service Provider.

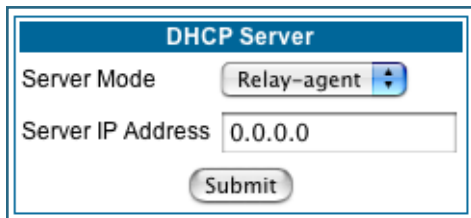

The screenshot shows a configuration window titled "DHCP Server". It contains the following fields and controls:

- Server Mode:** A pull-down menu with "Relay-agent" selected.
- Server IP Address:** A text input field containing "0.0.0.0".
- Submit:** A button at the bottom of the form.



NOTE:

The relay-agent option only works when NAT is off and the Gateway is in router mode.

[Link: RADIUS Server](#)

RADIUS servers allow external authentication of users by means of a remote authentication database. The remote authentication database is maintained by a Remote Authentication Dial-In User Service (RADIUS) server. In conjunction with Wireless User Authentication, you can use a RADIUS server database to authenticate users seeking access to the wireless services, as well as the authorized user list maintained locally within the Gateway.

If you click the [RADIUS](#) link, the RADIUS Servers screen appears.

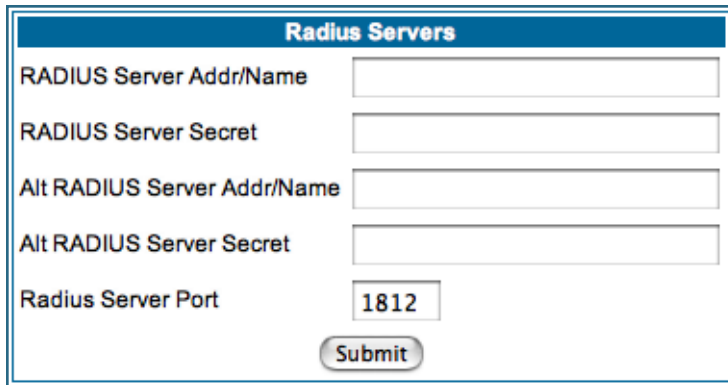

The screenshot shows a web form titled "Radius Servers". It contains five input fields: "RADIUS Server Addr/Name", "RADIUS Server Secret", "Alt RADIUS Server Addr/Name", "Alt RADIUS Server Secret", and "Radius Server Port". The "Radius Server Port" field has the value "1812" entered. A "Submit" button is located at the bottom of the form.

- **RADIUS Server Addr/Name:** The default RADIUS server name or IP address that you want to use.
- **RADIUS Server Secret:** The RADIUS secret key used by this server. The shared secret should have the same characteristics as a normal password.
- **RADIUS Server Port:** The port on which the RADIUS server is listening, typically, the default 1812.

Click the [Submit](#) button.

You can also configure alternate RADIUS servers from the Wireless Configuration pages. See [“Use RADIUS Server” on page 65](#) for more information.

Link: [SNMP](#)

When you click the [SNMP](#) link, the SNMP configuration page appears.

Each community name below must be unique. Enter blank to delete.

Communities	
Read Community Name	<input type="text" value="public"/>
Write Community Name	<input type="text"/>
Trap Community Name	<input type="text"/>

System Group	
System Contact	<input type="text"/>
System Location	<input type="text"/>

Notifications	
Notification Type	<input type="button" value="v1 Trap"/>
<input type="button" value="Submit"/>	

To create a new IP Trap entry, press the "Add" button.

IP Trap Entries
<i>No IP Trap entries have been defined</i>
<input type="button" value="Add"/>

The Simple Network Management Protocol (SNMP) lets a network administrator monitor problems on a network by retrieving settings on remote network devices. The network administrator typically runs an SNMP management station program on a local host to obtain information from an SNMP agent. In this case, the Motorola Netopia® Gateway is an SNMP agent. Your Gateway supports SNMP-V1, with the exception of most sets (read-only and traps), and SNMP-V2. (For certain parts of the NPAV2TRAP.MIB – parameters under resNatParams, resDslParams, resSecParams – set is supported.)

You enter SNMP configuration information on this page. Your network administrator furnishes the SNMP parameters.



WARNING:

SNMP presents you with a security issue. The community facility of SNMP behaves somewhat like a password. The community “public” is a well-known community name. It could be used to examine the configuration of your Gateway by your service provider or an uninvited reviewer. The information can be read from the Gateway. If you are strongly concerned about security, you may leave the “public” community blank.

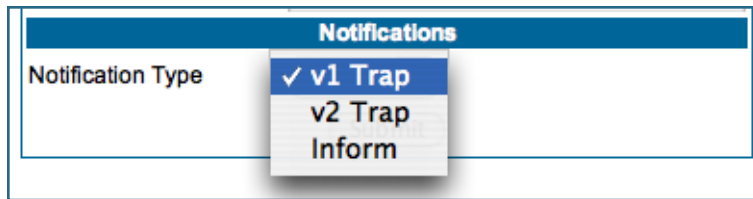

The **Notification Type** pull-down menu allows you to configure the type of SNMP notifications that will be generated:

- **v1 Trap** – This selection will generate notifications containing an SNMPv1 Trap *Protocol Data Unit* (PDU)
- **v2 Trap** – This selection will generate notifications containing an SNMPv2 Trap PDU
- **Inform** – This selection will generate notifications containing an SNMPv2 InformRequest PDU.

To send SNMP traps, you must add IP addresses for each trap receiver you want to have. Click the [Add](#) button.

The **IP Trap Entry** screen appears.

A screenshot of the 'IP Trap Entry' form. It features a blue header with the text 'IP Trap Entry'. Below the header is a text input field labeled 'IP Trap Entry Address' containing the value '0.0.0.0'. At the bottom of the form is a 'Submit' button.

Enter an IP Trap Entry IP address. This is the destination for SNMP trap messages, the IP address of the host acting as an SNMP console.

Click the [Submit](#) button. Click the Alert icon, and in the resulting page, click the [Save and Restart](#) link.

[Link: IGMP \(Internet Group Management Protocol\)](#)

Multicasting is a method for transmitting large amounts of information to many, but not all, computers over an internet. One common use is to distribute real time voice, video, and data services to the set of computers which have joined a distributed conference. Other uses include updating the address books of mobile computer users in the field, or sending out company newsletters to a distribution list.

Since a router should not be used as a passive forwarding device, Motorola Netopia® Gateways use a protocol for forwarding multicasting: Internet Group Management Protocol (IGMP).

Motorola Netopia® Gateways support IGMP Version 1, Version 2, or, beginning with Motorola Netopia® Firmware Version 7.7, Version 3.

See the “Advanced” option in [“LAN” on page 49](#) for more information.

IGMP “Snooping” is a feature of Ethernet layer 2 switches that “listens in” on the IGMP conversation between computers and multicast routers. Through this process, it builds a database of where the multicast routers reside by noting IGMP general queries used in the querier selection process and by listening to other router protocols.

From the host point of view, the snooping function listens at a port level for an IGMP report. The switch then processes the IGMP report and starts forwarding the relevant multicast stream onto the host's port. When the switch receives an IGMP *leave* message, it processes the leave message, and if appropriate stops the multicast stream to that particular port. Basically, customer IGMP messages although processed by the switch are also sent to the multicast routers.

In order for IGMP snooping to function with IGMP Version 3, it must always track the full source filter state of each host on each group, as was previously done with Version 2 only when *Fast Leave* support was enabled.

IGMP Version 3 supports:

IGMP Source Filtering: the ability for group memberships to incorporate source address filtering. This allows “Source-Specific Multicast” (SSM). By adding source filtering, a Gateway that proxies IGMP can more selectively join the specific multicast group for which there are interested LAN multicast receivers.

These features require no user configuration on the Gateway.

To configure IGMP options available in Motorola Netopia® Gateways, click the [IGMP](#) link.

The **IGMP** page appears.

IGMP	
IGMP Snooping	<input checked="" type="checkbox"/>
Robustness	<input type="text" value="2"/>
Query Interval	<input type="text" value="125"/>
Query Response Interval	<input type="text" value="100"/>
Unsolicited Report Interval	<input type="text" value="10"/>
Querier Version	v1 v2 <input checked="" type="text" value="v3"/>
Last Member Query Interval	<input type="text" value="10"/>
Last Member Query Count	<input type="text" value="2"/>
Fast Leave	<input type="checkbox"/>
Log Enable	<input type="checkbox"/>
Wireless Multicast to Unicast conversion	<input type="checkbox"/>
<input type="button" value="Submit"/>	

You can set the following options:

- **IGMP Snooping** – checking this checkbox enables the Motorola Netopia® Gateway to “listen in” to IGMP traffic. The Gateway discovers multicast group membership for the purpose of restricting multicast transmissions to only those ports which have requested them. This helps to reduce overall network traffic from streaming media and other bandwidth-intensive IP multicast applications.
- **Robustness** – a way of indicating how sensitive to lost packets the network is. IGMP can recover from robustness minus 1 lost IGMP packet. The default value is 2.
- **Query Interval**– the amount of time in seconds between IGMP General Query messages sent by the querier gateway. The default query interval is 125 seconds.
- **Query Response Interval** – the maximum amount of time in tenths of a second that the IGMP router waits to receive a response to a General Query message. The default query response interval is 10 seconds and must be less than the query interval.
- **Unsolicited Report Interval** – the amount of time in

seconds between repetitions of a particular computer’s initial report of membership in a group. The default unsolicited report interval is 10 seconds.

- **Querier Version** – Select a version of the IGMP Querier from the pull-down menu: **v1**, **v2**, or **v3**. The default **v3** allows for backward compatibility mode with the earlier versions, and should not need to be changed. However, for administrative purposes you may select either **v1** or **v2**.
- **Last Member Query Interval** – the amount of time in tenths of a second that the IGMP gateway waits to receive a response to a Group-Specific Query message. The last member query interval is also the amount of time in seconds between successive Group-Specific Query messages. The default last member query interval is 1 second (10 deci-seconds).
- **Last Member Query Count** – the number of Group-Specific Query messages sent before the gateway assumes that there are no members of the host group being queried on this interface. The default last member query count is 2.
- **Fast Leave** – Checking this checkbox enables a non-standard expedited leave mechanism. The querier keeps track of which client is requesting which channel by IP address. When a leave message is received, the querier can check its internal table to see if there are any more clients on this group. If there are none, it immediately sends an IGMP leave message to the upstream querier. By default, Fast Leave is set to **Off**.
- **Log Enable** – If you check this checkbox, all IGMP messages on both the LAN and the WAN will be logged.
- **Wireless Multicast to Unicast conversion** – This checkbox only appears if **IGMP Snooping** is enabled. If you check this checkbox, the Gateway replaces the multicast MAC-address with the physical MAC-address of the wireless client. If there is more than one wireless client interested in the same multicast group, the router will revert to multicasting the stream immediately. When one or more wireless clients leave a group, and the router determines that only a single wireless client is interested in the stream, it will once again unicast the stream.

Click the [Submit](#) button. Click the Alert icon, and in the resulting page, click the [Save and Restart](#) link.

[Link: UPnP](#)

Universal Plug and Play (UPnP™) is a set of protocols that allows a PC to automatically discover other UPnP devices (anything from an internet gateway device to a light switch), retrieve an XML description of the device and its services, control the device, and subscribe to real-time event notification.

By default, UPnP is enabled on the Motorola Netopia® Gateway.

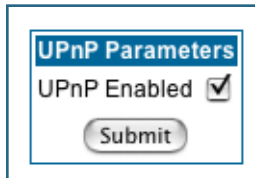

For Windows XP users, the automatic discovery feature places an icon representing the Motorola Netopia® Gateway automatically in the “My Network Places” folder. Double-clicking this icon opens the Gateway’s web UI.

PCs using UPnP can retrieve the Gateway’s WAN IP address, and automatically create NAT port maps. This means that applications that support UPnP, and are used with a UPnP-enabled Motorola Netopia® Gateway, will not need application layer gateway support on the Motorola Netopia® Gateway to work through NAT.

You can disable UPnP, if you are not using any UPnP devices or applications.

- Uncheck the [UPnP Enabled](#) checkbox, and click the [Submit](#) button.
- The Alert icon will appear in the upper right corner of the web page. Click the Alert icon, and when prompted, click the [Save and Restart](#) link.

Link: LAN Management

TR-064 is a LAN-side DSL Gateway configuration specification. It is an extension of UPnP. It defines more services to locally manage the Motorola Netopia® Gateway. While UPnP allows open access to configure the Gateway's features, TR-064 requires a password to execute any command that changes the Gateway's configuration.

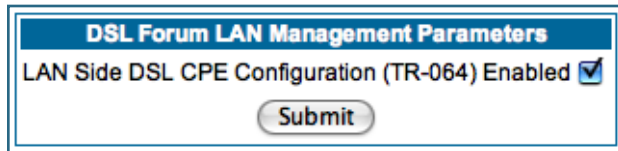

DSL Forum LAN Management Parameters

LAN Side DSL CPE Configuration (TR-064) Enabled

Submit

TR-064 is enabled by default. To *disable* it:

- Uncheck the **Enabled** checkbox, and click the **Submit** button.
- The Alert icon will appear in the upper right corner of the web page. Click the Alert icon, and when prompted, click the **Save and Restart** link.

Link: Ethernet Bridge

The Motorola Netopia® Gateway can be used as a bridge, rather than a router. A bridge is a device that joins two networks. As an Internet access device, a bridge connects the home computer directly to the service provider's network equipment with no intervening routing functionality, such as Network Address Translation. Your home computer becomes just another address on the service provider's network. In a DSL connection, the bridge serves simply to convey the digital data information back and forth over your telephone lines in a form that keeps it separate from your voice telephone signals.

If your service provider's network is set up to provide your Internet connectivity via bridge mode, you can set your Motorola Netopia® Gateway to be compatible.

Bridges let you join two networks, so that they appear to be part of the same physical network. As a bridge for protocols other than TCP/IP, your Gateway keeps track of as many as 512 MAC (Media Access Control) addresses, each of which uniquely identifies an individual host on a network. Your Gateway uses this bridging table to identify which hosts are accessible through which of its network interfaces. The bridging table contains the MAC address of each packet it sees, along with the interface over which it received the packet. Over time, the Gateway learns which hosts are available through its WAN port and/or its LAN port.

When configured in Bridge Mode, the Motorola Netopia® will act as a pass-through device and allow the workstations on your LAN to have public addresses directly on the internet.



NOTE:

In this mode the Motorola Netopia® is providing NO firewall protection as is afforded by NAT. Also, only the workstations that have a public address can access the internet. This can be useful if you have multiple static public IPs on the LAN.

Bridging per WAN is supported in conjunction with VLANs – individual WANs can be bridged to the LAN only if the WANs are part of a VLAN. (See [“VLAN” on page 107](#) for more information.) The capability to bridge individual VLANs is supported only if the underlying encapsulation is RFC1483-Bridged (ether-Ic).

Configuring for Bridge Mode

1. Browse into the Motorola Netopia® Gateway's web interface.
2. Click on the [Configure](#) button in the upper Menu bar.
3. Click on the [LAN](#) link.

The LAN page appears.

4. In the box titled LAN IP Interface (Ethernet 100BT):

LAN IP Interface (Ethernet 100BT)

Enable Interface

IP Address

IP Netmask

Restrictions

Other LAN Options

[Advanced](#) Configure advanced IP settings

[DHCP Server](#) Configure DHCP server options

Make note of the Ethernet IP Address and subnet mask. You can use this address to access the router in the future.

5. Click on the [Advanced](#) link in the left-hand links toolbar.
6. Under the heading of Services, click on the [Ethernet Bridge](#) link.

The Ethernet Bridge page appears.

LAN IP Interface (Ethernet 100BT)

Enable Interface

IP Address

IP Netmask

Restrictions

The appearance of this page varies, depending on your Gateway's interfaces.

7. **If available:**
 - a. Check the **Enable Bridging on Port** selection. (This may be Always On.)
 - b. Click [Submit](#).
8. **If you want the Gateway to do both bridging and routing, check the [Enable Concurrent Bridging/Routing](#) checkbox.**

When this mode is enabled, the Gateway will appear to be a router, but also bridge traffic from the LAN if it has a valid LAN-side address.

9. Check the [Enable System Bridge](#) checkbox.

The window shrinks.

Ethernet Bridge

Enable System Bridge

Enable Concurrent Bridging/Routing

Ethernet 100BT (LAN)

Enable Bridging on Port Always On

Ethernet Wireless (LAN)

Enable Bridging on Port Always On

- b. Click [Submit](#).

At this point you should be ready to do the final save on the configuration changes you have made.

The yellow **Alert** symbol will appear beneath the Help button on the right-hand end of the menu bar.

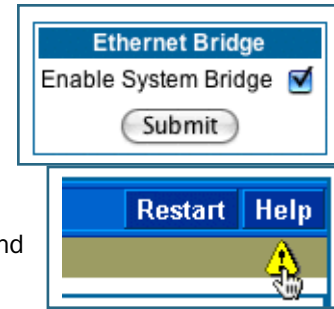

10. **Click on the Alert symbol and you will see whether your changes have been validated.**
11. **If you are satisfied with the changes you have made, click [Save and Restart](#) in the Save Database box to Apply changes and restart Gateway.**

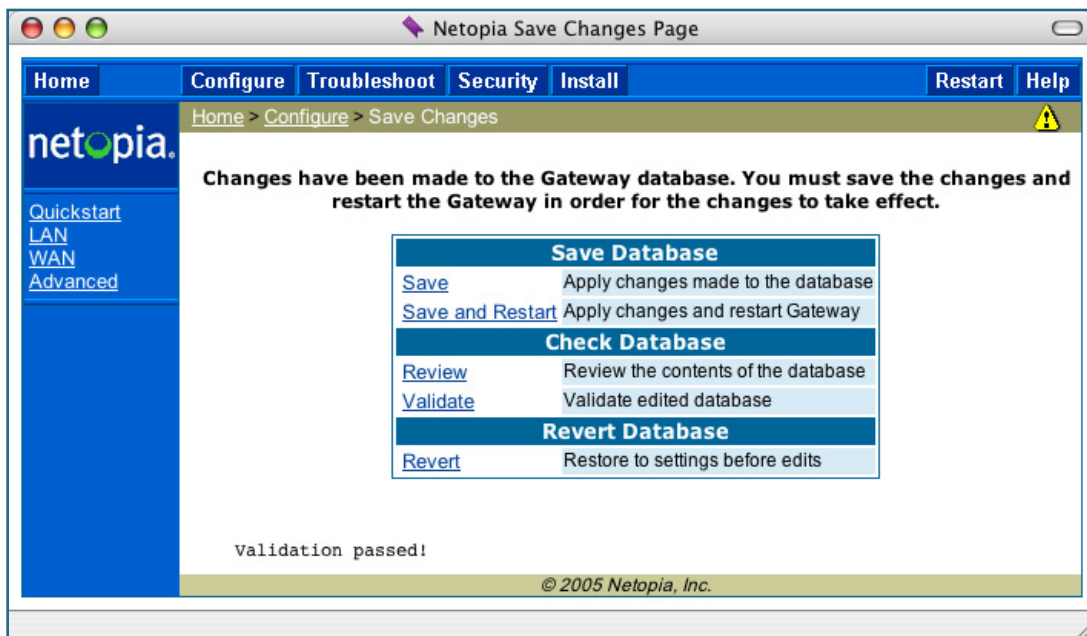

You have now configured your Motorola Netopia® Gateway for bridging, and it will bridge all traffic across the WAN. You will need to make configurations to your machines on your LAN. These settings must be made in accordance with your ISP. If you ever need to get back into the Motorola Netopia® Gateway again for management reasons, you will need to manually configure your machine to be in the same subnet as the Ethernet interface of the Motorola Netopia®, since DHCP server is not operational in bridge mode.

Link: VLAN

When you click the [VLAN](#) link the **VLANs** page appears.

VLANs			
VLAN#	Enabled	Name	Type
1	N		By-Port
2	N		By-Port
3	N		By-Port
4	N		By-Port
5	N		By-Port
6	N		By-Port
7	N		By-Port
8	N		By-Port

Overview

A Virtual Local Area Network (VLAN) is a network of computers or other devices that behave as if they are connected to the same wire even though they may be physically located on different segments of a LAN. You set up VLANs by configuring the Gateway software rather than hardware. This makes VLANs very flexible. VLANs behave like separate and independent networks.

Beginning with Version 7.7.4, VLANs are now strictly layer 2 entities. They can be thought of as virtual Ethernet switches, into which can be added: Ethernet ports, router IP interfaces, ATM PVC/VCC interfaces, SSIDs, and any other physical port such as USB, HPNA, or MOCA. This allows great flexibility on how the components of a system are connected to each other.

VLANs are part of Motorola's VGx Virtual Gateway technology which allows individual port-based VLANs to be treated as separate and distinct "channels." When data is passed to a Motorola Netopia VGx-enabled broadband gateway, specific policies, routing, and prioritization parameters can be applied to each individual service, delivering that service to the appropriate peripheral device with the required level of quality of service (QoS). In effect, a single Motorola gateway acts as separate virtual gateways for each distinct service being delivered.

Motorola's VGx technology maps multiple local VLANs to one or more specific permanent virtual circuits (PVCs) for DSL, or wide area network VLANs for a fiber network. VGx provides service segmentation and QoS controls, service management, and supports delivery of triple play applications: voice for IP Telephony, video for IPTV, and data.

Your Gateway supports the following:

- Port-based VLANs - these can be used when no trunking is required
- Global VLANs - these are used when trunking is required on any port member of the VLAN
 - Supports 802.1q and 802.1p; both are configurable
- Routed VLANs

- WAN-side VLAN with Multiple WAN IPoE interface support and IP interface-to-VLAN binding
- LAN-side VLAN with IP interface-to-VLAN binding
- Inter-VLAN routing
- Bridged VLANs - these VLANs are used to bridge traffic from LAN to WAN
- Prioritization per VLAN and per port

Ethernet Switching/Policy Setup

Before you configure any VLANs, the unconfigured Gateway is set up as a router composed of a LAN switch, a WAN switch, and a router in the middle, with LAN and WAN IP interfaces connected to their respective switches. These bindings between Ethernet switch ports, IP LAN interface, IP WAN interface and WAN physical ports are automatically created.

When you configure any VLANs, the default bindings are no longer valid, and the system requires explicit binding between IP interfaces and layer 2 interfaces. Each VLAN can be thought of as a layer 2 switch, and enabling each port or interface in a VLAN is analogous to plugging it in to the layer 2 switch.

Thereafter, in order for devices to communicate on layer 2, they must be associated in the same VLAN. For devices to communicate at layer 3, the devices must be either on the same VLAN, or on VLANs that have an Inter-VLAN routing group enabled in common.

When configuring VLANs you must define how traffic needs to be forwarded:

- If traffic needs to be bridged between LAN and WAN you can create a single VLAN that encompasses the WAN port and LAN ports.
- If traffic needs to be routed then you must define four elements:
 - LAN-side VLANs
 - WAN-side VLANs
 - Associate IP Interfaces to VLANs
 - Inter-VLAN Routing Groups: configuration of routing between VLANs is done by association of a VLAN to a Routing Group. Traffic will be routed between VLANs within a routing group. The LAN IP Ethernet Interface can be bound to multiple LAN VLANs, but forwarding can be limited between an Ethernet LAN port and a WAN VLAN if you properly configure Inter-VLAN groups.

Inter-VLAN groups are also used to block routing between WAN interfaces. If each WAN IP interface is bound to its own VLAN and if you configure a different Inter-VLAN group for each WAN VLAN then no routing between WAN IP interfaces is possible.

- Example: to route between a VCC and all the LAN ports, which effectively is similar to the default configuration without any VLANs:
Create a VLAN named "VccWan" consisting of vcc1, ip-vcc1, routing-group 1
Create a VLAN named "Lan" consisting of eth0.1, eth0.2, eth0.3, eth0.4, ssid1, ssid2, ssid3, ssid4 (etc.), ip-eth-a, routing-group 1

An example of multiple VLANs, using a Motorola Netopia® Gateway with VGx managed switch technology, is shown below:

A VLAN Model Combining Bridging and Routing

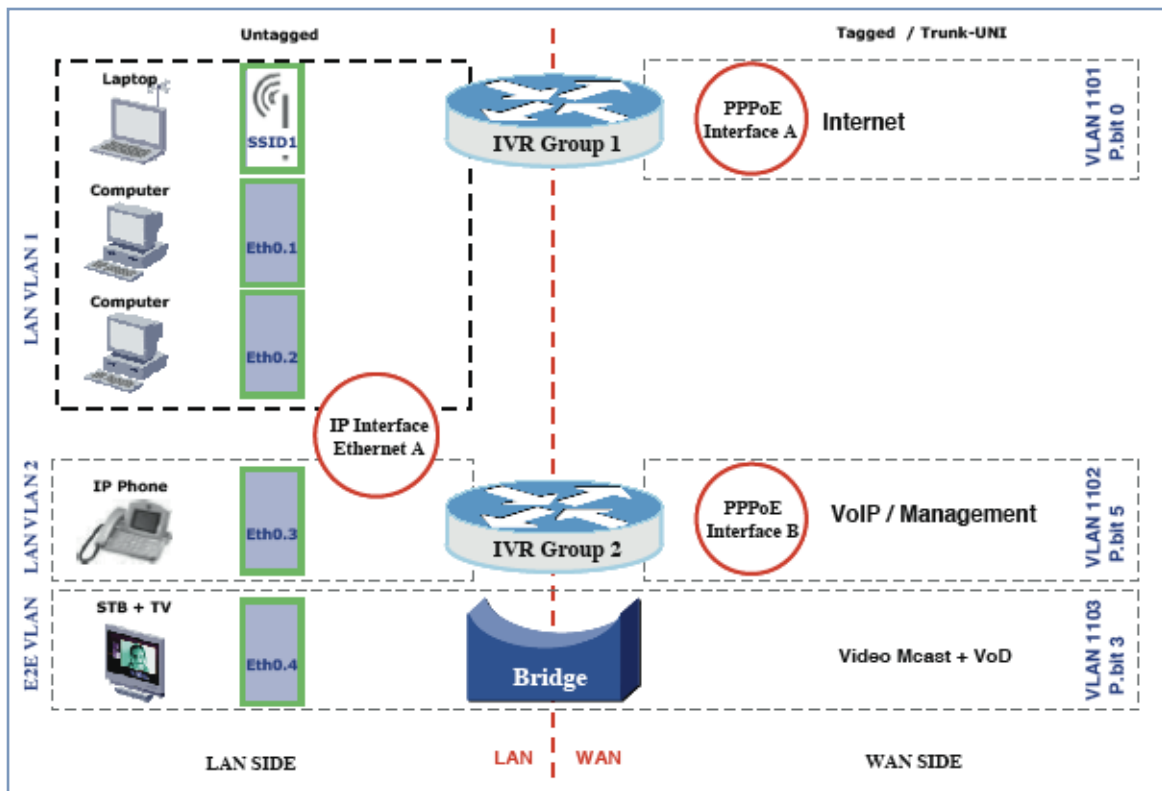

To configure VLANs check the **Enable** checkbox.

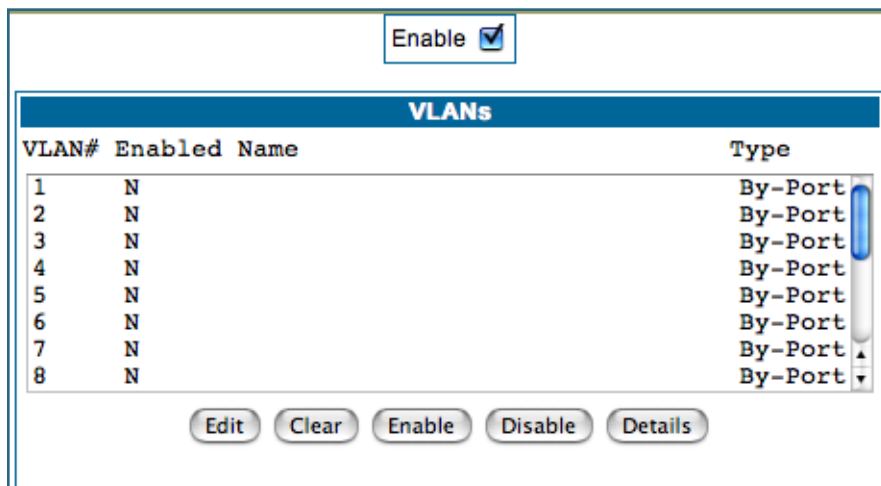

To create a VLAN select a list item from the main VLAN page and click the [Edit](#) button.

The **VLAN Entry** page appears.

VLAN Entry: 1

Enable

VLAN Name

Type

Admin Restricted

802.1p Priority Bit

Check the **Enable** checkbox, and enter a descriptive name for the VLAN.

VLAN Entry: 1

Enable

VLAN Name

Type

Admin Restricted

802.1p Priority Bit

You can create up to 16 VLANs, and you can also restrict any VLAN, and the computers on it, from administering the Gateway.

- **VLAN Name** – A descriptive name for the VLAN.
- **Type** – LAN or WAN Port(s) can be enabled on the VLAN. You can choose a type designation as follows:
 - By-Port:** indicates that the VLAN is port-based. Traffic sent to this port will be treated as belonging to the VLAN, and will not be forwarded to other ports that are not within a common VLAN segment.
 - Global** indicates that the ports joining this VLAN are part of a global 802.1q Ethernet VLAN. This VLAN includes ports on this Router and may include ports within other devices throughout the network. The VID in this case may define the behavior of traffic between all devices on the network having ports that are members of this VLAN segment.

- **VLAN ID** – If you select **Global** as the VLAN Type, the VLAN ID field appears for you to enter a VID. This must be a unique identifying number between 1 and 4094. (A VID of zero (0) is permitted on the Ethernet WAN port only.)

- **Admin Restricted** – If you want to prevent administrative access to the Gateway from this VLAN, check the checkbox.
- **802.1p Priority Bit:** If you set this from the pull-down menu to a value greater than 0, all packets of this VLAN with unmarked priority bits (pbits) will be re-marked to this priority. Click the **Submit** button.

The **VLAN Port Configuration** screen appears.

Portname	Enable	Tag	Priority	Promote	802.1p Priority Bit
eth0.1	<input type="checkbox"/>				
eth0.2	<input type="checkbox"/>				
eth0.3	<input type="checkbox"/>				
eth0.4	<input type="checkbox"/>				
ssid1	<input type="checkbox"/>				
usb	<input type="checkbox"/>				
vcc1	<input type="checkbox"/>				
IP interfaces		none			

- Port interfaces available for this VLAN are listed in the left hand column.
- Displayed port interfaces vary depending on the kinds of physical ports on your Gateway, for example, Ethernet, USB, and/or wireless. Also, if you have multiple wireless SSIDs defined, these may be displayed as well (See **Enable Multiple Wireless IDs** on [page 59](#))
- For Motorola Netopia® VGx technology models, separate Ethernet switch ports are displayed and may be configured. To enable any of them on this VLAN, check the associated **Enable** checkbox(es). Typically you will choose a physical port, such as an Ethernet port (example: **eth0.1**) or a wireless SSID (example: **ssid1**).
- When you enable an interface, the **Tag**, **Priority**, and **Promote** checkboxes and an **802.1p Priority Bit** pull-down menu appear for that interface.

Port Configuration for VLAN: 1

Portname	Enable	Tag	Priority	Promote	802.1p Priority Bit
eth0.1	<input checked="" type="checkbox"/>	<input type="checkbox"/>	<input checked="" type="checkbox"/>	<input checked="" type="checkbox"/>	1
eth0.2	<input type="checkbox"/>				
eth0.3	<input type="checkbox"/>				
eth0.4	<input type="checkbox"/>				
ssid1	<input type="checkbox"/>				
ssid2	<input type="checkbox"/>				
ssid3	<input type="checkbox"/>				
usb	<input type="checkbox"/>				
vcc1	<input type="checkbox"/>				

IP interfaces:

Tag – Packets transmitted from this port through this VLAN must be tagged with the VLAN VID. Packets received through this port destined for this VLAN must be tagged with the VLAN VID by the source. The Tag option is only available on **Global** type ports.

Priority – Use any 802.1p priority bits in the VLAN header to prioritize packets within the Gateway's internal queues, according to DiffServ priority mapping rules. See [“Differentiated Services” on page 92](#) for more information.

Promote – Write any 802.1p priority bits into the IP-TOS header bit field for received IP packets on this port destined for this VLAN. Write any IP-TOS priority bits into the 802.1p priority bit field for tagged IP packets transmitted from this port for this VLAN.

All mappings between Ethernet 802.1p and IP-TOS are made according to a pre-defined QoS mapping policy. The pre-defined mapping can now be set in the CLI. See [“Queue Configuration” on page 271](#). See also [“Differentiated Services” on page 92](#) for more information.

802.1p Priority Bit – If you set this field to a value greater than 0, all packets received on this port with unmarked priority bits (pbits) will be re-marked to this priority. If the port 802.1p PBit is greater than 0, the VLAN 802.1p PBit setting is ignored.

- Select an **IP Interface** for this VLAN if it is to be routed; otherwise leave the default. These selections will vary depending on your IP interfaces. For example, if you have set up multiple VCCs, these will appear in the list as **ip-vcc1**, **ip-vcc2**, and so forth.

ssid1

usb

vcc1

IP interfaces:

- When you select an IP interface, the screen expands to allow you to configure **Inter-Vlan-Groups**. Inter-VLAN groups allow VLANs in the group to route traffic to the others; ungrouped VLANs cannot route traffic to each other.

Port Configuration for VLAN: 1

Portname	Enable	Tag	Priority	Promote	802.1p Priority Bit
eth0.1	<input checked="" type="checkbox"/>	<input checked="" type="checkbox"/>	<input checked="" type="checkbox"/>	<input type="checkbox"/>	0
eth0.2	<input checked="" type="checkbox"/>	<input type="checkbox"/>	<input type="checkbox"/>	<input type="checkbox"/>	0
eth0.3	<input type="checkbox"/>				
eth0.4	<input type="checkbox"/>				
ssid1	<input checked="" type="checkbox"/>	<input type="checkbox"/>	<input type="checkbox"/>	<input type="checkbox"/>	0
ssid2	<input type="checkbox"/>				
ssid3	<input type="checkbox"/>				
vcc1	<input type="checkbox"/>				

IP interfaces ip-eth-a

Inter-VLAN-Group Enable

Group-1	<input checked="" type="checkbox"/>
Group-2	<input type="checkbox"/>
Group-3	<input type="checkbox"/>
Group-4	<input type="checkbox"/>
Group-5	<input type="checkbox"/>
Group-6	<input type="checkbox"/>
Group-7	<input type="checkbox"/>
Group-8	<input type="checkbox"/>

Submit

- Click the [Submit](#) button.
- When you are finished, click the Alert icon  in the upper right-hand corner of the screen, and in the resulting screen, click the [Save](#) link.
- If you want to create more VLANs, click the [Advanced](#) link (in the left-hand toolbar) and then the [VLAN](#) link in the resulting page, and repeat the process.

You can **Edit**, **Clear**, **Enable**, or **Disable** your VLAN entries by returning to the VLANs page, and selecting the appropriate entry from the displayed list.

Enable

VLANs			
VLAN#	Enabled	Name	Type
1	Y	Example 1	By-Port
2	N		By-Port
3	N		By-Port
4	N		By-Port
5	N		By-Port
6	N		By-Port
7	N		By-Port
8	N		By-Port

- When you are finished, click the Alert icon  in the upper right-hand corner of the screen, and in the resulting screen, click the [Save and Restart](#) link.

To view the settings for each VLAN, select the desired VLAN from the list and click the **Details** button.

The screen expands to display the VLAN settings.

Enable

VLANs			
VLAN#	Enabled	Name	Type
1	Y	Example 1	By-Port
2	N		By-Port
3	N		By-Port
4	N		By-Port
5	N		By-Port
6	N		By-Port
7	N		By-Port
8	N		By-Port

Admin Restricted
Off

802.1p Priority Bit (VLAN#: 1)
0

Portname	Enable	Tag	Priority	Promote	802.1p Priority Bit
eth0.1	On	Off	On	On	0
eth0.2	On	Off	Off	Off	0
eth0.3	Off				
eth0.4	Off				
ssid1	On	Off	Off	Off	0
ssid2	Off				
ssid3	Off				
vcc1	Off				
IP interfaces	ip-eth-a				
Inter-VLAN-Group	Enable				
Group-1	On				
Group-2	Off				
Group-3	Off				
Group-4	Off				
Group-5	Off				
Group-6	Off				
Group-7	Off				
Group-8	Off				

Example

The following is a simple example of how you might configure some VLANs:

You want to configure a 3347NWG-VGx Gateway with two SSIDs (see [“Multiple SSIDs” on page 59](#) for more information) for two VLANs, allowing both access to the Internet. One SSID will be in the same VLAN as the four ports of the Ethernet Switch, so that those two networks can communicate. The second VLAN will be for the other SSID. The second VLAN will also be denied access to the 3347NWG-VGx web interface and telnet interface. This setup might be useful if you have a doctor’s office or a coffee shop, and you want to keep your customers separated from the rest of the network.

1. **In the VLANs page, check the Enable checkbox, select VLAN #1 in the VLANs list, and click the Edit button.**

VLAN#	Enabled	Name	Type
1	N		By-Port
2	N		By-Port
3	N		By-Port
4	N		By-Port
5	N		By-Port
6	N		By-Port
7	N		By-Port
8	N		By-Port

2. **Check the Enable checkbox, and in the VLAN Name box, enter the name you would like.**

For example, call it **Network A**.

Since this VLAN will be for SSID1 and the Ethernet ports, leave **Admin Restricted** unchecked. This will give this VLAN access to the Gateway.

3. **Click the Submit button.**
4. **In the Port Configuration for VLAN:1 page, you add the Port Interfaces you want associated with the VLAN.**

Port Configuration for VLAN: 1				
Portname	Enable	Tag	Priority	Promote 802.1p Priority Bit
eth0.1	<input checked="" type="checkbox"/>	<input type="checkbox"/>	<input type="checkbox"/>	0
eth0.2	<input checked="" type="checkbox"/>	<input type="checkbox"/>	<input type="checkbox"/>	0
eth0.3	<input checked="" type="checkbox"/>	<input type="checkbox"/>	<input type="checkbox"/>	0
eth0.4	<input checked="" type="checkbox"/>	<input type="checkbox"/>	<input type="checkbox"/>	0
ssid1	<input checked="" type="checkbox"/>	<input type="checkbox"/>	<input type="checkbox"/>	0
ssid2	<input type="checkbox"/>			
ssid3	<input type="checkbox"/>			
vcc1	<input type="checkbox"/>			
IP interfaces	ip-eth-a			
Inter-VLAN-Group	Enable			
Group-1	<input checked="" type="checkbox"/>			
Group-2	<input type="checkbox"/>			
Group-3	<input type="checkbox"/>			
Group-4	<input type="checkbox"/>			
Group-5	<input type="checkbox"/>			
Group-6	<input type="checkbox"/>			
Group-7	<input type="checkbox"/>			
Group-8	<input type="checkbox"/>			

In this case, select all the physical Ethernet ports: **eth0.1** through **eth0.4**, and wireless **ssid1**. Select **ip-eth-a**, the IP interface for the group. This will be Inter-Vlan-Group #1. Check the **Group-1** checkbox. These ports will be able to communicate with each other.

5. **Click the Submit button.**
6. **In the VLAN page, select VLAN #2 in the VLANs list, and click the Edit button.**

VLAN Entry: 2	
Enable	<input checked="" type="checkbox"/>
VLAN Name	Network B
Type	By-Port
Admin Restricted	<input checked="" type="checkbox"/>
802.1p Priority Bit	0

The VLAN Name must be given another unique name. For example, call it **Network B**. Since this is for the second SSID that we don't want to be given access to the Gateway, check the **Admin Restricted** checkbox.

7. Click the Submit button.
8. In the Port Configuration for VLAN: 2 page, you add the Port Interfaces you want associated with the VLAN.

Port Configuration for VLAN: 2

Portname	Enable	Tag	Priority	Promote	802.1p	Priority Bit
eth0.1	<input type="checkbox"/>					
eth0.2	<input type="checkbox"/>					
eth0.3	<input type="checkbox"/>					
eth0.4	<input type="checkbox"/>					
ssid1	<input type="checkbox"/>					
ssid2	<input checked="" type="checkbox"/>	<input type="checkbox"/>	<input type="checkbox"/>		0	↓↑
ssid3	<input type="checkbox"/>					
vcc1	<input type="checkbox"/>					
IP interfaces	ip-eth-a ↓↑					
Inter-VLAN-Group	Enable					
Group-1	<input type="checkbox"/>					
Group-2	<input checked="" type="checkbox"/>					
Group-3	<input type="checkbox"/>					
Group-4	<input type="checkbox"/>					
Group-5	<input type="checkbox"/>					
Group-6	<input type="checkbox"/>					
Group-7	<input type="checkbox"/>					
Group-8	<input type="checkbox"/>					

Select the **ip-eth-a** port interface and check the **ssid2** port interface. Make this VLAN a member of Inter-Vlan-Group **Group-2**.

9. Click the Submit button.
10. Next, create a VLAN to provide the Inter-Vlan-Groups access to the Internet (WAN).

VLAN Entry: 3

Enable	<input checked="" type="checkbox"/>
VLAN Name	WAN VLAN
Type	By-Port ↓↑
Admin Restricted	<input type="checkbox"/>
802.1p Priority Bit	0 ↓↑

For example, call it **WAN VLAN**.

Port Configuration for VLAN: 3				
Portname	Enable	Tag	Priority	Promote 802.1p Priority Bit
eth0.1	<input type="checkbox"/>			
eth0.2	<input type="checkbox"/>			
eth0.3	<input type="checkbox"/>			
eth0.4	<input type="checkbox"/>			
ssid1	<input type="checkbox"/>			
ssid2	<input type="checkbox"/>			
ssid3	<input type="checkbox"/>			
vcc1	<input checked="" type="checkbox"/>	<input type="checkbox"/>	<input type="checkbox"/>	0
IP interfaces	ip-vcc1			
Inter-VLAN-Group	Enable			
Group-1	<input checked="" type="checkbox"/>			
Group-2	<input checked="" type="checkbox"/>			
Group-3	<input type="checkbox"/>			
Group-4	<input type="checkbox"/>			
Group-5	<input type="checkbox"/>			
Group-6	<input type="checkbox"/>			
Group-7	<input type="checkbox"/>			
Group-8	<input type="checkbox"/>			

Check the **vcc1** checkbox, select the **ip-vcc1** IP interface, and check the Inter-Vlan-Group **Group-1** and **Group-2** checkboxes. Members of Groups 1 and 2 will now be able to communicate with the Internet (WAN), but not with each other.

11. **Once you have finished with the configuration of the VLANs, click the Alert icon in the upper right hand corner.**

This will validate that the settings are legal for your network.

12. **Click the [Save and Restart](#) link.**

This will restart the Motorola Netopia® Gateway and retain the VLAN configuration.

[Link: VoIP](#)

(supported models only)

Voice-over-IP (VoIP) refers to the ability to make voice telephone calls over the Internet. This differs from traditional phone calls that use the Public Switched Telephone Network (PSTN). VoIP calls use an Internet protocol, Session Initiation Protocol (SIP), to transmit sound over a network or the Internet in the form of data packets. Certain Motorola Netopia® Gateway models have two separate voice ports for connecting telephone handsets. These models support VoIP. If your Gateway is a VoIP model, you can configure the VoIP features.

When you click the [VoIP](#) link, the **SIP Line Entry** page appears.

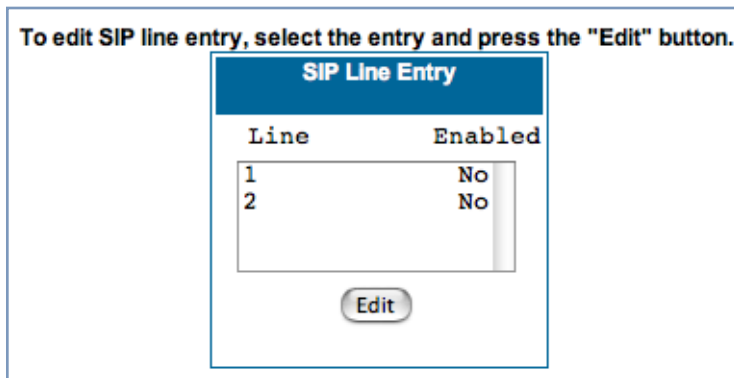

To enable a VoIP line, select one of the lines from the SIP Line Entry menu that corresponds to the port on the Gateway to which your phone is connected.

Click the [Edit](#) button. In the resulting screen, check the **Enable SIP** checkbox.

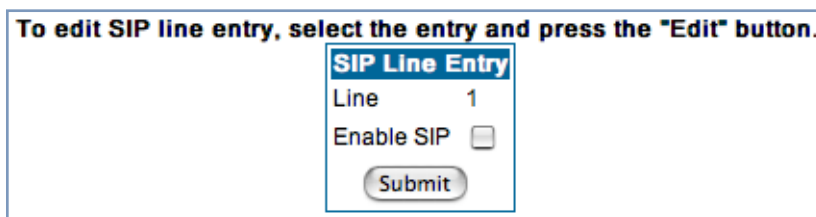

The screen expands to display the features that you can enable for that line.

To edit SIP line entry, select the entry and press the "Edit" button.

SIP Line Entry	
Line	1
Enable SIP	<input checked="" type="checkbox"/>
Transport Type	UDP
Registration Interval (in secs)	<input type="text" value="3600"/>
Registrar Server	<input type="text"/>
Registrar Port	<input type="text" value="5060"/>
Proxy Server	<input type="text"/>
Proxy Port	<input type="text" value="5060"/>
Outbound Proxy Server	<input type="text"/>
Outbound Proxy Port	<input type="text" value="5060"/>
User Display Name	<input type="text"/>
SIP User Name	<input type="text"/>
SIP User Password	<input type="text"/>
Auth User ID	<input type="text"/>
Call Features	
DTMF Mode	<input type="text" value="Info"/>
Enable End of Dial Marker	<input type="checkbox"/>
Enable Call Forwarding Unconditionally	<input type="checkbox"/>
Enable Call Forwarding On Busy	<input type="checkbox"/>
Enable Call Forwarding On No Answer	<input type="checkbox"/>
Enable Waiting	<input type="checkbox"/>
Enable Conferencing	<input type="checkbox"/>
Subscribe for Do Not Disturb	<input type="checkbox"/>
Subscribe for MWI	<input type="checkbox"/>
<input type="button" value="Submit"/>	

SIP Line Entry

Registration Interval (in secs)	Length of time the VoIP registration will be valid before it will be renewed. Default is 1 hour.
Registrar Server	Registration Server name or IP address.
Registrar Port	Registration Server port. Default is 5060.
Proxy Server	Proxy server name or IP address.

SIP Line Entry

Proxy Port	Proxy server port, if required. Default is 5060.
Outbound Proxy Server	Outbound Proxy server name or IP address, if required.
Outbound Proxy Port	Outbound Proxy server port, if required. Default is 5060.
User Display Name	Name of this phone's user to be displayed on the Home page. Example: "Jacob Q. Smith"
SIP User Name	Registration user ID. Example: "jqsmith"
SIP User Password	Registration user password.
Auth User ID	The authorization ID that authenticates the user to SIP for the specified phone. Most SIP Servers expect this to be the User Name itself but some may use Auth User ID .

Call Features Settings

DTMF Mode	Choose the Dual Tone Multi-Frequency Mode: <ul style="list-style-type: none"> • Inband: Sends the DTMF digits as a normal inband tone. • RFC2833: Sends the DTMF digits as an event as part of the RTP packet header information. • Info: Sends the DTMF digits in the SIP INFO message.
Enable End of Dial Marker	If you check this checkbox, the Gateway will generate an "end of dial" (#) signal that indicates that the dialed number is complete.
Enable Call Forwarding Unconditionally	If you check this checkbox, all calls will be forwarded to a specified number. The Unconditional Call Forwarding Number field will appear for you to enter the number, if enabled.
Enable Call Forwarding On Busy	If you check this checkbox, calls will be forwarded to a specified number if the line is busy. The On Busy Call Forwarding Number field will appear for you to enter the number, if enabled.
Enable Call Forwarding On No Answer	If you check this checkbox, calls will be forwarded to a specified number if there is no answer. The On No Answer Call Forwarding Number field will appear for you to enter the number, if enabled.
Enable Waiting	If you check this checkbox, call waiting is enabled.
Enable Conferencing	If you check this checkbox, 3-party teleconferencing is enabled.
Subscribe for Do Not Disturb	If you check this checkbox, the Gateway will reject VoIP calls without ringing the phone.
Subscribe for MWI	If you check this checkbox, Message Waiting Indicator is enabled when new voice mail is received.

When you are finished entering the required information, click the [Submit](#) button.

To configure the second voice port, return to the **SIP Line Entry** screen by clicking the [VoIP](#) link in the Breadcrumb Trail.

When you are finished, click the Alert icon  in the upper right corner of the page, and in the resulting page, click the [Save and Restart](#) link.

The **Home** page for a VoIP-enabled Gateway with both phone lines registered is shown below.

Home	Configure	Troubleshoot	Security	Install	Restart	Help
						
Home						
General Information						
Hardware	Netopia Model 2247-41-10NA ADSL2 WIAD					
Serial Number	9437188					
Software Version	7.7.4	BreakWater Firewall	ClearSailing			
Product ID	1225					
Date & Time	Fri Jun 1 10:07:20 2007	Safe Harbour	On			
WAN						
Status	Up	Data Rate (Kbps)	Downstream: 8000 Upstream: 800			
Local Address	0.0.0.0	Peer Address	0.0.0.0			
Connection Type	Always On					
NAT	On	WAN Users	Unlimited			
LAN						
IP Address	192.168.1.254					
Netmask	255.255.255.0					
DHCP Server	On	Ethernet Status	Up			
		DHCP Leases	0 out of 253 leases in use			
VoIP						
Line 1 Registration	Registered	Line 2 Registration	Registered			
Line 1 Account	4004	Line 2 Account	4005			
© 2007 Netopia, Inc.						

[Link: System](#)

The **System Name** defaults to your Gateway's factory identifier combined with its serial number. Some cable-oriented Service Providers use the System Name as an important identification and support parameter.

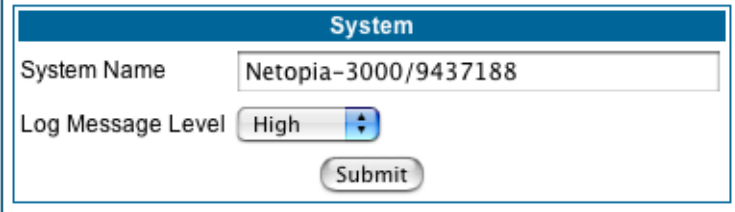

The screenshot shows a web form titled "System" with a blue header. It contains two main fields: "System Name" with a text input field containing "Netopia-3000/9437188", and "Log Message Level" with a dropdown menu currently set to "High". Below these fields is a "Submit" button.

The System Name can be 1 – 255 characters long; it can include embedded spaces and special characters.

The **Log Message Level** alters the severity at which messages are collected in the Gateway's system log. Do not alter this field unless instructed by your Support representative.

Link: Syslog Parameters

You can configure a UNIX-compatible syslog client to report a number of subsets of the events entered in the Gateway's WAN Event History. Syslog sends log-messages to a host that you specify.

To enable syslog logging, click on the [Syslog Parameters](#) link.

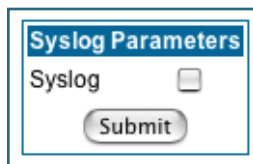

The screenshot shows a small window titled "Syslog Parameters". It contains a checkbox labeled "Syslog" which is currently unchecked. Below the checkbox is a "Submit" button.

Check the **Syslog** checkbox.

The screen expands.

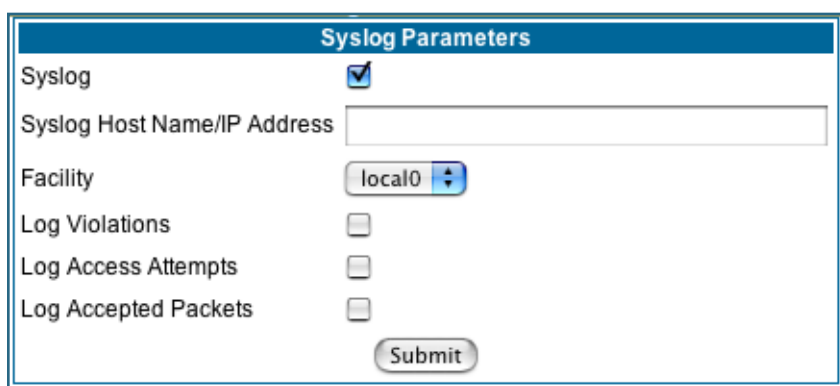

The expanded screenshot shows the "Syslog Parameters" configuration page. It includes the following fields and options:

- Syslog**: A checkbox that is checked.
- Syslog Host Name/IP Address**: A text input field.
- Facility**: A pull-down menu currently set to "local0".
- Log Violations**: An unchecked checkbox.
- Log Access Attempts**: An unchecked checkbox.
- Log Accepted Packets**: An unchecked checkbox.
- A **Submit** button at the bottom.

- **Syslog**: Enable syslog logging in the system.
- **Syslog Host Name/IP Address**: Enter the name or the IP Address of the host that should receive syslog messages.
- **Facility**: From the pull-down menu, select the Syslog facility to be used by the router when generating syslog messages. Options are *local0* through *local7*.
- **Log Violations**: If you check this checkbox, the Gateway will generate messages whenever a packet is discarded because it violates the router's security policy.
- **Log Access Attempts**: If you check this checkbox, the Gateway will generate messages whenever a packet attempts to access the router or tries to pass through the router. This option is disabled by default.
- **Log Accepted Packets**: If you check this checkbox, the Gateway will generate messages whenever a packet accesses the router or passes through the router. This option is disabled by default.



NOTE:

Syslog needs to be enabled to comply with logging requirements mentioned in The Modular Firewall Certification Criteria - Baseline Module - version 4.1 (specified by ICSA Labs).

For more information, please go to the following URL:

<http://www.icsalabs.com/icsa/docs/html/communities/firewalls/pdf/4.1/baseline.pdf>

Log Event Messages

Administration Related Log Messages

- | | |
|---|--|
| 1. administrative access attempted: | This log-message is generated whenever the user attempts to access the router's management interface. |
| 2. administrative access authenticated and allowed: | This log-message is generated whenever the user attempts to access the router's management interface and is successfully authenticated and allowed access to the management interface. |
| 3. administrative access allowed: | If for some reason, a customer does not want password protection for the management interface, this log-message is generated whenever any user attempts to access the router's management interface and is allowed access to the management interface. |
| 4. administrative access denied - invalid user name: | This log-message is generated whenever the user tries to access the router's management interface and authentication fails due to incorrect user-name. |
| 5. administrative access denied - invalid password: | This log-message is generated whenever the user tries to access the router's management interface and authentication fails due to incorrect password. |
| 6. administrative access denied - telnet access not allowed: | This log-message is generated whenever the user tries to access the router's Telnet management interface from a Public interface and is not permitted since Remote Management is disabled. |
| 7. administrative access denied - web access not allowed: | This log-message is generated whenever the user tries to access the router's HTTP management interface from a Public interface and is not permitted since Remote Management is disabled. |

System Log Messages

- | | |
|--|--|
| 1. Received NTP Date and Time: | This log-message is generated whenever NTP receives Date and time from the server. |
| 2. EN: IP up: | This log-message is generated whenever Ethernet WAN comes up. |
| 3. WAN: Ethernet WAN1 activated at 100000 Kbps: | This log-message is generated when the Ethernet WAN Link is up. |
| 4. Device Restarted: | This log-message is generated when the router has been restarted. |

DSL Log Messages (most common):

- | | |
|---|--|
| 1. WAN: Data link activated at <Rate> Kbps (rx/tx) | This log message is generated when the DSL link comes up. |
| 2. WAN: Data link deactivated | This log message is generated when the DSL link goes down. |
| 3. RFC1483 up | This log message is generated when RFC1483 link comes up. |
| 4. RFC1483-<WAN-instance>: IP down | This log message is generated when RFC1483 link goes down. |

DSL Log Messages (most common):

- | | |
|---|---|
| 5. PPP: Channel <ID> up Dialout Profile name: <Profile Name> | This log message is generated when a PPP channel comes up. |
| 6. PPP-<WAN Instance> down: <Reason> | This log message is generated when a PPP channel goes down. The reason for the channel going down is displayed as well. |

Access-related Log Messages

- | | |
|---|--|
| 1. permitted: | This log-message is generated whenever a packet is allowed to traverse router-interfaces or allowed to access the router itself. |
| 2. attempt: | This log-message is generated whenever a packet attempts to traverse router-interfaces or attempts to access the router itself. |
| 3. dropped - violation of security policy: | This log-message is generated whenever a packet, traversing the router or destined to the router itself, is dropped by the firewall because it violates the expected conditions. |
| 4. dropped - invalid checksum: | This log-message is generated whenever a packet, traversing the router or destined to the router itself, is dropped because of invalid IP checksum. |
| 5. dropped - invalid data length: | This log-message is generated whenever a packet, traversing the router or destined to the router itself, is dropped because the IP length is greater than the received packet length or if the length is too small for an IP packet. |
| 6. dropped - fragmented packet: | This log-message is generated whenever a packet, traversing the router, is dropped because it is fragmented, stateful inspection is turned ON on the packet's transmit or receive interface, and deny-fragment option is enabled. |
| 7. dropped - cannot fragment: | This log-message is generated whenever a packet traversing the router is dropped because the packet cannot be sent without fragmentation, but the do not fragment bit is set. |
| 8. dropped - no route found: | This log-message is generated whenever a packet, traversing the router or destined to the router itself, is dropped because no route is found to forward the packet. |
| 9. dropped - invalid IP version: | This log-message is generated whenever a packet, traversing the router or destined to the router itself, is dropped because the IP version is not 4. |
| 10. dropped - possible land attack: | This log-message is generated whenever a packet, traversing the router or destined to the router itself, is dropped because the packet is TCP/UDP packet and source IP Address and source port equals the destination IP Address and destination port. |
| 11. TCP SYN flood detected: | This log-message is generated whenever a SYN packet destined to the router's management interface is dropped because the number of SYN-sent and SYN-receives exceeds one half the number of allowable connections in the router. |
| 12. Telnet receive DoS attack - packets dropped: | This log-message is generated whenever TCP packets destined to the router's telnet management interface are dropped due to overwhelming receive data. |

Access-related Log Messages

13. dropped - reassembly timeout:

This log-message is generated whenever packets, traversing the router or destined to the router itself, are dropped because of reassembly timeout.

14. dropped - illegal size:

This log-message is generated whenever packets, traversing the router or destined to the router itself, are dropped during reassembly because of illegal packet size in a fragment.

Link: Internal Servers

Your Gateway ships with an embedded Web server and support for a Telnet session, to allow ease of use for configuration and maintenance. The default ports of **80** for HTTP and **23** for Telnet may be reassigned. This is necessary if a pinhole is created to support applications using port 80 or 23. [See "Pinholes" on page 82.](#) for more information on Pinhole configuration.

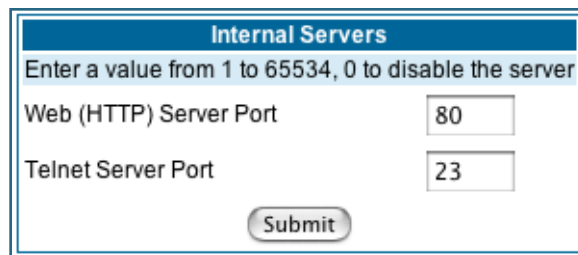

Internal Servers	
Enter a value from 1 to 65534, 0 to disable the server	
Web (HTTP) Server Port	<input type="text" value="80"/>
Telnet Server Port	<input type="text" value="23"/>
<input type="button" value="Submit"/>	

Web (HTTP) Server Port: To reassign the port number used to access the Motorola Netopia® embedded Web server, change this value to a value greater than 1024. When you next access the embedded Motorola Netopia® Web server, append the IP address with <port number>, (e.g. Point your browser to **http://210.219.41.20:8080**).

Telnet Server Port: To reassign the port number used to access your Motorola Netopia® embedded Telnet server, change this value to a value greater than 1024. When you next access the Motorola Netopia® embedded Telnet server, append the IP address with <port number>, (e.g. **telnet 210.219.41.20 2323**).

You can also use the LAN-side address of the Gateway, 192.168.1.x:8100 to access the web server and 192.168.1.x:2323 to access the telnet server. The value of 0 for an internal server port will disable that server. You can disable Telnet or Web, but not both. If you disabled both ports, you would not be able to reconfigure the unit without pressing the reset button.

[Link: Software Hosting](#)

Software Hosting allows you to host internet applications when NAT is enabled. **User(PC)** specifies the machine on which the selected software is hosted. You can host different games and software on different PCs.

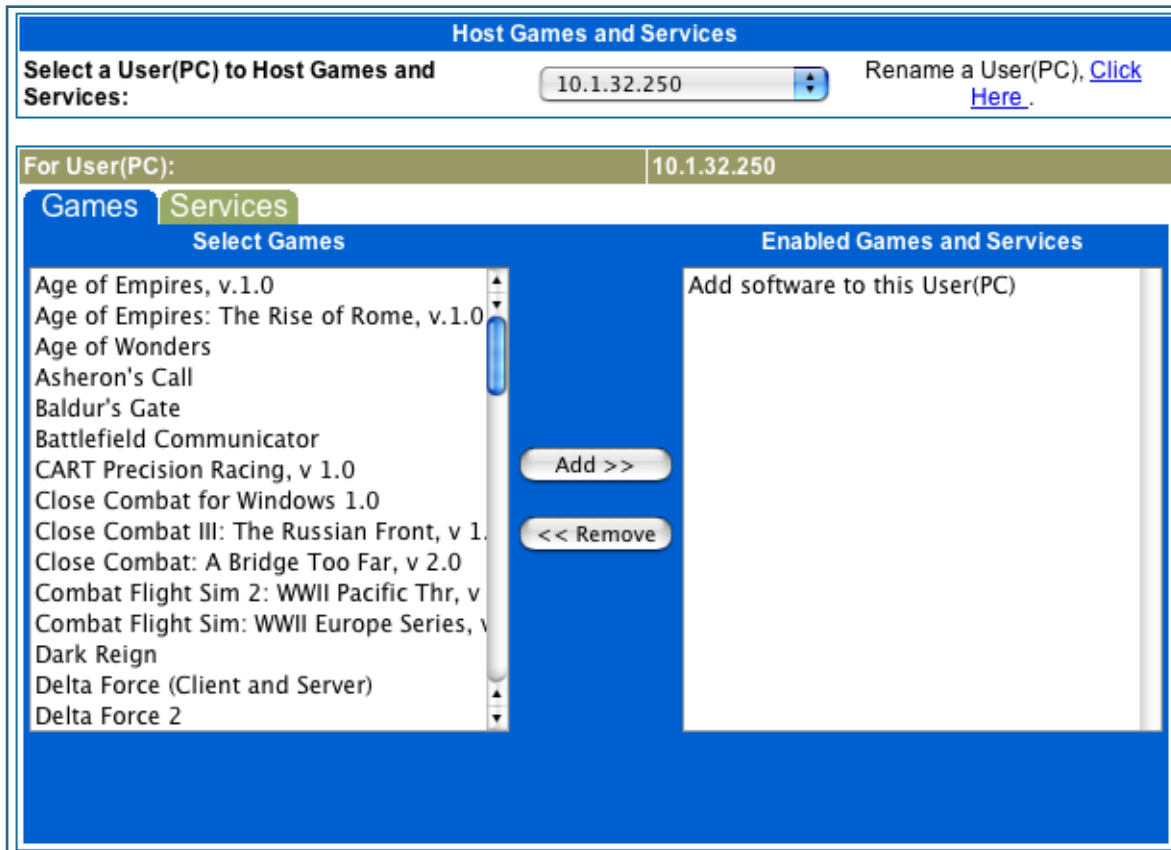

To select the games or software that you want to host for a specific PC, highlight the name(s) in the box on the left side of the screen. Click the [Add](#) button to select the software that will be hosted.

To remove a game or software from the hosted list, highlight the game or software you want to remove and click the [Remove](#) button.

List of Supported Games and Software

Age of Empires, v.1.0	Age of Empires: The Rise of Rome, v.1.0	Age of Wonders
Asheron's Call	Baldur's Gate	Battlefield Communicator
Buddy Phone	Calista IP Phone	CART Precision Racing, v 1.0
Citrix Metaframe/ICA Client	Close Combat for Windows 1.0	Close Combat: A Bridge Too Far, v 2.0
Close Combat III: The Russian Front, v 1.0	Combat Flight Sim: WWII Europe Series, v 1.0	Combat Flight Sim 2: WWII Pacific Thr, v 1.0
Dark Reign	Delta Force (Client and Server)	Delta Force 2
Diablo II Server	Dialpad	DNS Server
Dune 2000	eDonkey 2000	eMule
F-16, Mig 29	F-22, Lightning 3	Fighter Ace II
FTP	GNUtella	H.323 compliant (Netmeeting, CUSeeME)
Half Life	Hellbender for Windows, v 1.0	Heretic II
Hexen II	Hotline Server	HTTP
HTTPS	ICQ 2001b	ICQ Old
IMAP Client	IMAP Client v.3	Internet Phone
IPSec	IPSec IKE	Jedi Knight II: Jedi Outcast
Kali	KazaA	LimeWire
Links LS 2000	Mech Warrior 3	Mech Warrior 4: Vengeance
Medal of Honor Allied Assault	Microsoft Flight Simulator 98	Microsoft Flight Simulator 2000
Microsoft Golf 1998 Edition, v 1.0	Microsoft Golf 1999 Edition	Microsoft Golf 2001 Edition
Midtown Madness, v 1.0	Monster Truck Madness, v 1.0	Monster Truck Madness 2, v 2.0
Motocross Madness 2, v 2.0	Motocross Madness, v 1.0	MSN Game Zone
MSN Game Zone (DX7 an 8 Play)	Need for Speed 3, Hot Pursuit	Need for Speed, Porsche
Net2Phone	NNTP	Operation FlashPoint
Outlaws	pcAnywhere (incoming)	POP-3
PPTP	Quake II	Quake III
Rainbow Six	RealAudio	Return to Castle Wolfenstein

Roger Wilco	Rogue Spear	ShoutCast Server
SMTP	SNMP	SSH server
StarCraft	Starfleet Command	StarLancer, v 1.0
Telnet	TFTP	Tiberian Sun: Command and Conquer
Timbuktu	Total Annihilation	Ultima Online
Unreal Tournament Server	Urban Assault, v 1.0	VNC, Virtual Network Computing
Westwood Online, Command and Conquer	Win2000 Terminal Server	XBox Live Games
Yahoo Messenger Chat	Yahoo Messenger Phone	ZNES

Rename a User(PC)

If a PC on your LAN has no assigned host name, you can assign one by clicking the [Rename a User\(PC\)](#) link.

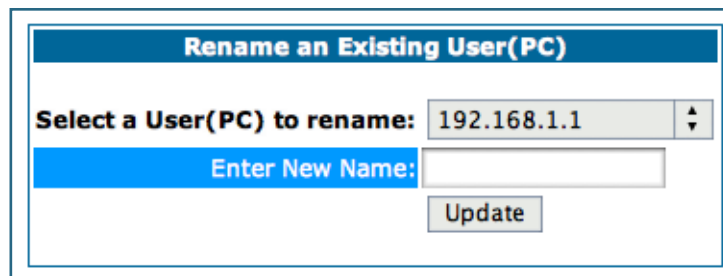

To rename a server, select the server from the pull-down menu. Then type a new name in the text box below the pull-down menu. Click the [Update](#) button to save the new name.



NOTE:

The new name given to a server is only known to Software Hosting. It is not used as an identifier in other network functions, such as DNS or DHCP.

[Link: Backup](#)

The purpose of Backup is to provide a recovery mechanism in the event that the primary connection fails. A failure can be either line loss, for example by central site switch failure or physical cable breakage, or loss of end-to-end connectivity. Detection of one of these failures causes the Gateway to switch from using the primary DSL WAN connection to an alternate gateway on the Ethernet LAN. In the event of a loss of primary connectivity you have the option of switching back to the primary circuit automatically once it has recovered its connection.

A typical application would be to have a LAN connection from your Gateway to another Gateway that has, for example, another DSL modem or Gateway connection to the Internet, and designating the second gateway as the backup gateway. Should the primary WAN connection fail, traffic would be automatically redirected through your alternate gateway device to maintain Internet connectivity.



The screenshot shows the 'Backup Options' page. At the top, there is a blue header with the text 'Backup Options'. Below this, the 'Backup' status is shown as 'disabled' in a pull-down menu. Underneath, there is a section titled 'Backup IP Gateway' with a checkbox for 'Enable Backup Gateway' which is currently unchecked. A 'Submit' button is located at the bottom of the form.

When you click the [Backup](#) link, the **Backup Options** page appears.

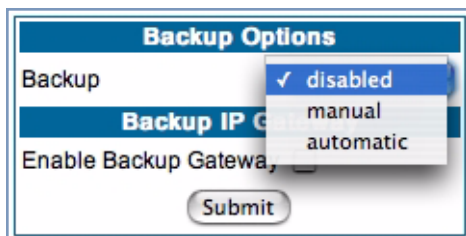

This screenshot is similar to the previous one, but the 'Backup' pull-down menu is open, showing three options: 'disabled' (which is selected with a checkmark), 'manual', and 'automatic'. The 'Enable Backup Gateway' checkbox remains unchecked, and the 'Submit' button is still visible at the bottom.

Select either **manual** or **automatic** from the pull-down menu.

- If you choose **manual**, you will have to switch manually to your alternate gateway in the event of a connection failure.
- For fail-over purposes, choose **automatic**.

Manual options

If you choose manual, you can also choose Auto Recovery. If you chose **Auto Recovery**, enter the number of minutes that the system should wait before it assumes that a connection has been re-established. This allows you to be sure that the primary WAN connection is well re-established before the Gateway switches back to it from the backup mode. Minimum value is one minute.

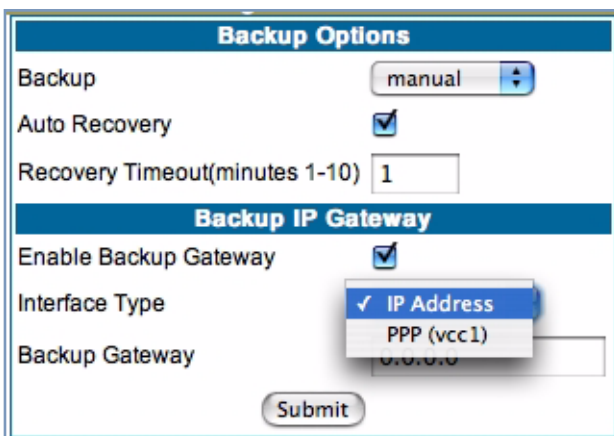

The screenshot shows the 'Backup Options' page with 'manual' selected in the 'Backup' menu. The 'Auto Recovery' checkbox is checked. The 'Recovery Timeout (minutes 1-10)' is set to '1'. In the 'Backup IP Gateway' section, the 'Enable Backup Gateway' checkbox is checked. The 'Interface Type' pull-down menu is open, showing 'IP Address' selected with a checkmark and 'PPP (vcc1)' as an alternative option. The 'Backup Gateway' field is empty. A 'Submit' button is at the bottom.

- Check the **Enable Backup Gateway** checkbox.
- From the pull-down menu, select the **Interface Type** to which you want to direct the backup connection. If you have defined multiple VCCs, you can choose a secondary one. Otherwise, to backup to an IP device on the LAN, choose **IP Address**.

The screen expands to allow you to enter an IP address of your **Backup Gateway**.

Click the [Submit](#) button; click the Alert icon, and in the resulting page, click the [Save and Restart](#) link.

Once Backup is configured, a new field appears in the Home Page.

BACKUP	
Current Port	Primary
Current State	up
<input type="button" value="Force Backup"/>	

If your DSL WAN link fails, you can switch to your Backup Gateway by clicking the [Force Backup](#) button.

Automatic options

If you select automatic as your Backup option, the screen expands to allow you to enter additional information.

Backup Options	
Backup	<input type="button" value="automatic"/>
Failure Timeout(minutes 1-10)	<input type="text" value="1"/>
Ping Host 1	<input type="button" value="address"/>
Address	<input type="text" value="0.0.0.0"/>
Ping Host 2	<input type="button" value="address"/>
Address	<input type="text" value="0.0.0.0"/>
Auto Recovery	<input checked="" type="checkbox"/>
Recovery Timeout(minutes 1-10)	<input type="text" value="1"/>
Backup IP Gateway	
Enable Backup Gateway	<input checked="" type="checkbox"/>
Interface Type	<input type="button" value="IP Address"/>
Backup Gateway	<input type="text" value="0.0.0.0"/>
<input type="button" value="Submit"/>	

• **Failure Timeout (minutes 1-10)** – Enter the number of minutes you want the system to wait before the backup port becomes enabled in the event of primary line failure. This allows you to be sure the WAN connection is not merely briefly interrupted before the gateway switches to backup mode.

• **Ping Host 1** and **Ping Host 2** – Select **address** or **name** from the pull-down menu enter IP address(es) or resolvable DNS name(s) that the Gateway will ping.

The Gateway will ping both addresses simultaneously at five-second intervals, recording the ping responses from each host. The Gateway will proceed into backup mode only if neither of the configured remote hosts responds.



Note:

For best results, enter an IP address and not a host name. If a host name is used it may not be resolvable, and may keep the interface down.

- While the Gateway is in backup mode, it will continue to ping both hosts via the primary interface. If either host responds to a ping and the **Auto Recovery** checkbox is checked, the Gateway will revert to the primary interface.
- If you chose Auto Recovery, select **Recovery Timeout (minutes 1-10)**. Enter the number of minutes you want the system to wait before attempting to switch back to the WAN connection. This allows you to be sure that the WAN connection is well re-established before the gateway switches back to it from the backup mode.
- Check the **Enable Backup Gateway** checkbox

-
- From the pull-down menu, select the **Interface Type** to which you want to direct the backup connection. If you have defined multiple VCCs, you can choose a secondary one. Otherwise, to backup to an IP device on the LAN, choose **IP Address**.

The screen expands to allow you to enter an IP address of your **Backup Gateway**.

Click the [Submit](#) button; click the Alert icon, and in the resulting page, click the [Save and Restart](#) link.

Once Backup is configured, a new field appears in the Home Page.

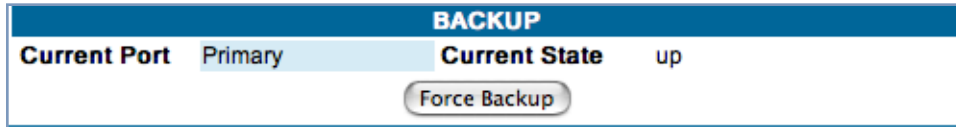

For automatic mode, it should not be necessary to switch to Backup manually. However, you can force a switch to your Backup Gateway by clicking the [Force Backup](#) button.

[Link: Ethernet MAC Override](#)

(Only available on models with Ethernet WAN interfaces, such as the 338X-series or VDSL Gateways.)

Your Gateway comes with its own MAC (Media Access Control) address, also called the *Hardware Address*, a 12 character number unique for each LAN-connected device.

Your Service Provider, particularly cable service providers, may instruct you to override the default MAC address.



Ethernet MAC Address Override

Enable Override

MAC Address - - - - -

If so, check the **Enable Override** checkbox, and enter the new MAC address in the field provided.

Link: Clear Options

To restore the factory configuration of the Gateway, choose **Clear Options**. You may want to upload your configuration to a file before performing this function. You can do this using the **upload** command via the command-line interface. See the **upload** command on [page 238](#).

Clear Options does not clear feature keys or affect the software image.

You must restart the Gateway for **Clear Options** to take effect.

Clear Options

Choosing the 'Clear Options' link below will restore the Gateway's factory configuration. You will be returned to the Restart Page because the Gateway must be restarted in order to complete the process.

[Clear Options](#)

Link: Time Zone

When you click the [Time Zone](#) link, the **Time Zone** page appears.



The screenshot shows a web form titled "TimeZone" with a blue header. Below the header, the text "Time Zone:" is followed by a pull-down menu currently displaying "Greenwich". Below the menu is a "Submit" button.

You can set your local time zone by selecting the number of hours your time zone is distant from Greenwich Mean Time (GMT +12 – -12) from the pull-down menu. This allows you to set the time zone for access controls and in general.

Security

Button: Security

The Security features are available by clicking on the Security toolbar button. Some items of this category do not appear when you log on as **User**.

Home > Security	
The descriptions below provide information on the links displayed on the left of the screen.	
Passwords	Allows changing the Admin or User passwords that control access to the Gateway.
Firewall	Provides access to firewall settings if the firewall feature has been purchased.
IPSec	Provides access to configuration parameters for IPSec functionality.
Stateful Inspection	Provides access to stateful inspection settings.
Packet Filter	Provides access to packet filter settings.
Security Log	Provides specific information about security-related events.

[Link: Passwords](#)

Access to your Gateway may be controlled through two optional user accounts, **Admin** and **User**. When you first power up your Gateway, you create a password for the **Admin** account. The User account does not exist by default. As the Admin, a password for the User account can be entered or existing passwords changed.

Create and Change Passwords. You can establish different levels of access security to protect your Motorola Netopia® Gateway settings from unauthorized display or modification.

- **Admin** level privileges let you display and modify **all** settings in the Motorola Netopia® Gateway (Read/Write mode). The Admin level password is created when you first access your Gateway.
- **User** level privileges let you display (but **not** change) settings of the Motorola Netopia® Gateway. (Read Only mode)

To prevent anyone from observing the password you enter, characters in the old and new password fields are not displayed as you type them.

To display the Passwords window, click the [Security](#) toolbar button on the Home page.

The screenshot shows two windows. The top window, titled "About Passwords", contains the following text: "Access to your Gateway is controlled through two user accounts, Admin and User." It lists "Admin: Full access to the Gateway" and "User: Not allowed to configure any parameters, install keys/software, or restart the Gateway". It concludes with "Use the fields below to change or create passwords." The bottom window, titled "Passwords", contains a "Username" pull-down menu set to "admin (Admin account)", an "Old Password" field with a note "(Leave blank if no old password)", a "New Password" field, and a "Confirm Password" field. Below these fields is the text "Password changes are automatically saved, and take effect immediately." and a "Submit" button.

Use the following procedure to change existing passwords or add the User password for your Motorola Netopia® Gateway:

1. **Select the account type from the [Username](#) pull-down list.**
Choose from **Admin** or **User**.
2. **If you assigned a password to the Motorola Netopia® Gateway previously, enter your current password in the [Old Password](#) field.**
3. **Enter your new password in the [New Password](#) field.**

Motorola Netopia®'s rules for a Password are:

-
- It can have up to eight alphanumeric characters.
 - It is case-sensitive.
4. **Enter your new password again in the [Confirm Password](#) field.**
You confirm the new password to verify that you entered it correctly the first time.
 5. **When you are finished, click the [Submit](#) button to store your modified configuration in the Motorola Netopia® unit's memory.**
Password changes are automatically saved, and take effect immediately.

[Link: Firewall](#)

Use a Motorola Netopia® Firewall

BreakWater Basic Firewall. BreakWater delivers an easily selectable set of pre-configured firewall protection levels. For simple implementation these settings (comprised of three levels) are readily available through Motorola Netopia®'s embedded web server interface.

BreakWater Basic Firewall's three settings are:

- **ClearSailing**
ClearSailing, BreakWater's default setting, supports both inbound and outbound traffic. It is the only basic firewall setting that fully interoperates with all other Motorola Netopia® software features.
- **SilentRunning**
Using this level of firewall protection allows transmission of outbound traffic on pre-configured TCP/UDP ports. It disables any attempt for inbound traffic to identify the Gateway. This is the Internet equivalent of having an *unlisted number*.
- **LANdLocked**
The third option available turns off all inbound and outbound traffic, isolating the LAN and disabling all WAN traffic.



NOTE:

BreakWater Basic Firewall operates independent of the NAT functionality on the Gateway.

Configuring for a BreakWater Setting

Use these steps to establish a firewall setting:

1. **Ensure that you have enabled the BreakWater basic firewall with the appropriate feature key.**
See [See "Use Motorola Netopia® Software Feature Keys" on page 187.](#) for reference.
NOTE: The firewall is now keyed on by default on the 2200-Series Gateways.
2. **Click the [Security](#) toolbar button.**
3. **Click [Firewall](#).**

BreakWater Firewall

ClearSailing Removes the traffic restrictions imposed by SilentRunning and LANdlocked. Protection against unwanted inbound traffic is controlled by NAT settings.
Note: The ClearSailing firewall setting is necessary to enable pinholes, IPMaps and a NAT default server.

SilentRunning Using this level of firewall protection allows secure transmission of outbound traffic, but disables any attempt for inbound traffic to identify the Gateway. This is the Internet equivalent of having an unlisted number.
Note: The SilentRunning firewall setting disables pinholes, IPMaps and a NAT default server.

LANdLocked This option turns off all inbound and outbound traffic (including pinholes and IPMaps), isolating the LAN and disabling all WAN traffic.

BreakWater Option ClearSailing SilentRunning LANdLocked

BreakWater changes are automatically saved, and take effect immediately.

4. Click on the radio button to select the protection level you want. Click [Submit](#).

Changing the BreakWater setting does **not** require a restart to take effect. This makes it easy to change the setting “on the fly,” as your needs change.

TIPS for making your BreakWater Basic Firewall Selection

Application	Select this Level	Other Considerations
Typical Internet usage (browsing, e-mail)	SilentRunning	
Multi-player online gaming	ClearSailing	Set Pinholes; once defined, pinholes will be active whenever ClearSailing is set. Restore SilentRunning when finished.
Going on vacation	LANdLocked	Protects your connection while your away.
Finished online use for the day	LANdLocked	This protects you instead of disconnecting your Gateway connection.
Chatting online or using instant messaging	ClearSailing	Set Pinholes; once defined, pinholes will be active whenever ClearSailing is set. Restore SilentRunning when finished.

Basic Firewall Background

As a device on the Internet, a Motorola Netopia® Gateway requires an IP address in order to send or receive traffic.

The IP traffic sent or received have an associated application port which is dependent on the nature of the connection request. In the IP protocol standard the following session types are common applications:

- ICMP
- HTTP
- FTP
- SNMP
- telnet
- DHCP

By receiving a response to a scan from a port or series of ports (which is the expected behavior according to the IP standard), hackers can identify an existing device and gain a potential opening for access to an internet-connected device.

To protect LAN users and their network from these types of attacks, BreakWater offers three levels of increasing protection.

The following tables indicate the **state of ports associated with session types**, both on the WAN side and the LAN side of the Gateway.

This table shows how inbound traffic is treated. *Inbound* means the traffic is coming from the WAN into the WAN side of the Gateway.

Gateway: WAN Side				
BreakWater Setting >>		ClearSailing	SilentRunning	LANdLocked
Port	Session Type	-----Port State-----		
20	ftp data	Enabled	Disabled	Disabled
21	ftp control	Enabled	Disabled	Disabled
23	telnet external	Enabled	Disabled	Disabled
23	telnet Motorola Netopia® server	Enabled	Disabled	Disabled
80	http external	Enabled	Disabled	Disabled
80	http Motorola Netopia® server	Enabled	Disabled	Disabled
67	DHCP client	Enabled	Enabled	Disabled
68	DHCP server	Not Applicable	Not Applicable	Not Applicable
161	snmp	Enabled	Disabled	Disabled
	ping (ICMP)	Enabled	Disabled	Disabled

This table shows how outbound traffic is treated. *Outbound* means the traffic is coming from the LAN-side computers into the LAN side of the Gateway.

Gateway: LAN Side				
BreakWater Setting >>		ClearSailing	SilentRunning	LANdLocked
Port	Session Type	-----Port State-----		
20	ftp data	Enabled	Enabled	Disabled
21	ftp control	Enabled	Enabled	Disabled
23	telnet external	Enabled	Enabled	Disabled
23	telnet Motorola Netopia® server	Enabled	Enabled	Enabled
80	http external	Enabled	Enabled	Disabled
80	http Motorola Netopia® server	Enabled	Enabled	Enabled
67	DHCP client	Not Applicable	Not Applicable	Not Applicable
68	DHCP server	Enabled	Enabled	Enabled
161	snmp	Enabled	Enabled	Enabled
	ping (ICMP)	Enabled	Enabled	WAN - Disabled LAN - Local Address Only



NOTE:

The Gateway's WAN DHCP client port in SilentRunning mode is **enabled**. This feature allows end users to continue using DHCP-served IP addresses from their Service Providers, while having no identifiable presence on the Internet.

[Link: IPSec](#)

When you click on the [IPSec](#) link, the IPSec configuration screen appears.

Your Gateway can support two mechanisms for IPSec tunnels:

- **IPSec PassThrough** supports Virtual Private Network (VPN) clients running on LAN-connected computers. Normally, this feature is enabled.

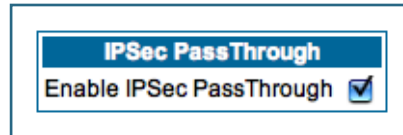

You can disable it if your LAN-side VPN client includes its own NAT interoperability option.

Uncheck the [Enable IPSec Passthrough](#) checkbox.

- **SafeHarbour VPN IPSec** is a keyed feature that you must purchase. (See "Install Key" on page 187.) It enables Gateway-terminated VPN support.

SafeHarbour IPSec VPN

SafeHarbour VPN IPSec Tunnel provides a single, encrypted tunnel to be **terminated on** the Gateway, making a secure tunnel available for **all** LAN-connected users. This implementation offers the following:

- Eliminates the need for VPN client software on individual PCs.
- Reduces the complexity of tunnel configuration.
- Simplifies the ongoing maintenance for secure remote access.

If you have purchased the SafeHarbour IPSec feature key, the IPSec configuration screen offers additional options.

Two separate mechanisms for IPSec tunnel support are provided by your Gateway:

- IPSec PassThrough supports VPN clients running on LAN-connected computers. Disable this checkbox if your LAN-side VPN client includes its own NAT interoperability solution.
- SafeHarbour is a keyed feature that enables Gateway-terminated VPN support.

IPSec PassThrough
Enable IPSec PassThrough

SafeHarbour IPSec
Enable SafeHarbour IPSec

SafeHarbour IPSec Tunnel Entry						
On	Name	Peer External IP Address	Encryption Protocol	Authentication Protocol	Key Management	
<input checked="" type="checkbox"/>		0.0.0.0	ESP	ESP	IKE	<input type="button" value="Add"/>

A typical SafeHarbour configuration is shown below:

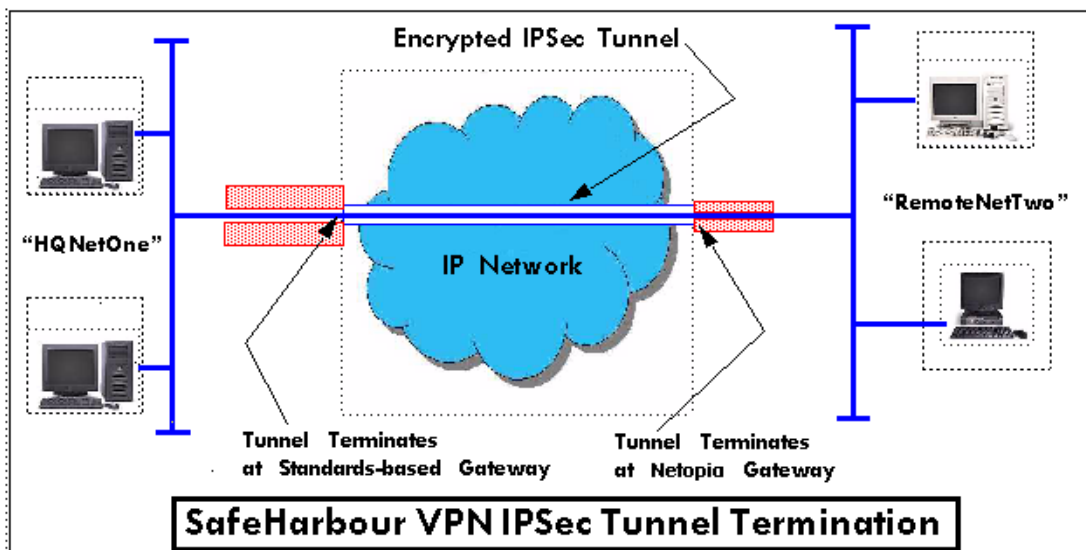

Configuring a SafeHarbour VPN

Use the following procedure to configure your SafeHarbour tunnel.

- 1. Obtain your configuration information from your network administrator.**

The tables “[Parameter Descriptions](#)” on [page 151](#) describe the various parameters that may be required for your tunnel. Not all of them need to be changed from the defaults for every VPN tunnel. Consult with your network administrator.

- 2. Complete the Parameter Setup worksheet “[IPSec Tunnel Details Parameter Setup Worksheet](#)” on [page 149](#).**

The worksheet provides spaces for you to enter your own specific values. You can print the page for easy reference. IPSec tunnel configuration requires precise parameter setup between VPN devices. The Setup Worksheet ([page 149](#)) facilitates setup and assures that the associated variables are **identical**.

Table 1: IPSec Tunnel Details Parameter Setup Worksheet

Parameter	Motorola Netopia® Gateway	Peer Gateway
Name		
Peer Internal Network		
Peer Internal Netmask		
NAT Enable	On/Off	
PAT Address		
Negotiation Method	Main/Aggressive	
Local ID Type	IP Address Subnet Hostname ASCII	
Local ID Address/Value		
Local ID Mask		
Remote ID Type	IP Address Subnet Hostname ASCII	
Remote ID Address/Value		
Remote ID Mask		
Pre-Shared Key Type	HEX ASCII	
Pre-Shared Key		
DH Group	1/2/5	
PFS Enable	Off/On	
SA Encrypt Type	DES 3DES	
SA Hash Type	MD5 SHA1	
Invalid SPI Recovery	Off/On	
Soft MBytes	1 - 1000000	
Soft Seconds	60 - 1000000	
Hard MBytes	1 - 1000000	
Hard Seconds	60 - 1000000	
IPSec MTU	100 - 1500 (default)	
Xauth Enable	Off/On	
Xauth Username		
Xauth Password		

3. **Be sure that you have SafeHarbour VPN enabled.**

SafeHarbour is a keyed feature. See [“Install Key” on page 187.](#) for information concerning installing Motorola Netopia® Software Feature Keys.

4. **Check the [Enable SafeHarbour IPSec](#) checkbox.**

Checking this box will automatically display the **SafeHarbour IPSec Tunnel Entry** parameters.

Enter the initial group of tunnel parameters. Refer to your **Setup Worksheet** and the **“Parameter Descriptions” on page 151** as required.

5. **Enter the tunnel [Name](#).**

This parameter does not have to match the peer/remote VPN device.

6. **Enter the [Peer External IP Address](#).**

7. **Select the [Encryption Protocol](#) from the pull-down menu.**

8. **Select the [Authentication Protocol](#) from the pull-down menu.**

9. **Click [Add](#).**

The Tunnel Details page appears.

Tunnel Details	
Name	my_tunnel
Peer Internal Network	0.0.0.0
Peer Internal Netmask	255.255.255.0
NAT Enable	<input checked="" type="checkbox"/>
PAT Address	0.0.0.0
Negotiation Method	Aggressive
Local ID type	IP Address
Local ID Address	0.0.0.0
Remote ID Type	IP Address
Remote ID Address	0.0.0.0
Pre-Shared Key Type	ASCII
Pre-Shared Key	netopia1
DH Group	1
PFS Enable	<input type="checkbox"/>
SA Encrypt Type	DES
SA Hash Type	MD5
Invalid SPI Recovery	<input type="checkbox"/>
Soft MBytes	1000
Soft Seconds	82800
Hard MBytes	1200
Hard Seconds	86400
IPSec MTU	1500
Xauth Enable	<input type="checkbox"/>
<input type="button" value="Update"/> <input type="button" value="Delete"/>	

10. **Make the Tunnel Details entries.**

Enter or select the required settings.

Soft MBytes, Soft Seconds, Hard MBytes, and Hard Seconds values do not have to match the peer/remote VPN device.

Refer to your [“IPSec Tunnel Details Parameter Setup Worksheet” on page 149.](#))

11. **Click [Update](#).**

The **Alert** button appears.

12. **Click the [Alert](#) button.**

13. **Click [Save and Restart](#).**

Your SafeHarbour IPSec VPN tunnel is fully configured.

Parameter Descriptions

The following tables describe SafeHarbour's parameters that are used for an IPSec VPN tunnel configuration:

Table 2: IPSec Configuration page parameters

Field	Description
Name	The Name parameter refers to the name of the configured tunnel. This is mainly used as an identifier for the administrator. The Name parameter is an ASCII value and is limited to 31 characters. <u>The tunnel name does not need to match the peer gateway.</u>
Peer External IP Address	The Peer External IP Address is the public, or routable IP address of the remote gateway or VPN server you are establishing the tunnel with.
Encryption Protocol	Encryption protocol for the tunnel session. Parameter values supported include NONE or ESP.
Authentication Protocol	Authentication Protocol for IP packet header. The three parameter values are None, Encapsulating Security Payload (ESP) and Authentication Header (AH)
Key Management	The Key Management algorithm manages the exchange of security keys in the IPSec protocol architecture. SafeHarbour supports the standard Internet Key Exchange (IKE)

Table 3: IPSec Tunnel Details page parameters

Field	Description
Name	The Name parameter refers to the name of the configured tunnel. This is mainly used as an identifier for the administrator. The Name parameter is an ASCII value and is limited to 31 characters. <u>The tunnel name does not need to match the peer gateway.</u>
Peer Internal Network	The Peer Internal IP Network is the private, or Local Area Network (LAN) address of the remote gateway or VPN Server you are communicating with.
Peer Internal Netmask	The Peer Internal IP Netmask is the subnet mask of the Peer Internal IP Network.
NAT enable	Turns NAT on or off for this tunnel.
PAT Address	If NAT is enabled, this field appears. You can specify a Port Address Translation (PAT) address or leave the default all-zeroes (if Xauth is enabled). If you leave the default, the address will be requested from the remote router and dynamically applied to the Gateway.
Negotiation Method	This parameter refers to the method used during the Phase I key exchange, or IKE process. SafeHarbour supports Main or Aggressive Mode. Main mode requires 3 two-way message exchanges while Aggressive mode only requires 3 total message exchanges.
Local ID type	If Aggressive mode is selected as the Negotiation Method, this option appears. Selection options are: IP Address, Subnet, Hostname, ASCII
Local ID Address/ Value	If Aggressive mode is selected as the Negotiation Method, this field appears. This is the local (Gateway-side) IP address (or Name Value, if Subnet or Hostname are selected as the Local ID Type).

Table 3: IPSec Tunnel Details page parameters

Local ID Mask	If Aggressive mode is selected as the Negotiation Method, and Subnet as the Local ID Type, this field appears. This is the local (Gateway-side) subnet mask.
Remote ID Type	If Aggressive mode is selected as the Negotiation Method, this option appears. Selection options are: IP Address, Subnet, Hostname, ASCII.
Remote ID Address/Value	If Aggressive mode is selected as the Negotiation Method, this field appears. This is the remote (central-office-side) IP address (or Name Value, if Subnet or Hostname are selected as the Local ID Type).
Remote ID Mask	If Aggressive mode is selected as the Negotiation Method, and Subnet as the Remote ID Type, this field appears. This is the remote (central-office-side) subnet mask.
Pre-Shared Key Type	The Pre-Shared Key Type classifies the Pre-Shared Key. SafeHarbour supports ASCII or HEX types
Pre-Shared Key	The Pre-Shared Key is a parameter used for authenticating each side. The value can be ASCII or Hex and a maximum of 64 characters. ASCII is case-sensitive.
DH Group	Diffie-Hellman is a public key algorithm used between two systems to determine and deliver secret keys used for encryption. Groups 1, 2 and 5 are supported.
PFS Enable	Perfect Forward Secrecy (PFS) is used during SA renegotiation. When PFS is selected, a Diffie-Hellman key exchange is required. If enabled, the PFS DH group follows the IKE phase 1 DH group.
SA Encrypt Type	SA Encryption Type refers to the symmetric encryption type. This encryption algorithm will be used to encrypt each data packet. SA Encryption Type values supported include DES and 3DES.
SA Hash Type	SA Hash Type refers to the Authentication Hash algorithm used during SA negotiation. Values supported include MD5 and SHA1. N/A will display if NONE is chosen for Auth Protocol.
Invalid SPI Recovery	Enabling this allows the Gateway to re-establish the tunnel if either the Motorola Netopia® Gateway or the peer gateway is rebooted.
Soft MBytes	Setting the Soft MBytes parameter forces the renegotiation of the IPSec Security Associations (SAs) at the configured Soft MByte value. The value can be configured between 1 and 1,000,000 MB and refers to data traffic passed. If this value is not achieved, the Hard MBytes parameter is enforced. <u>This parameter does not need to match the peer gateway.</u>
Soft Seconds	Setting the Soft Seconds parameter forces the renegotiation of the IPSec Security Associations (SAs) at the configured Soft Seconds value. The value can be configured between 60 and 1,000,000 seconds. <u>This parameter does not need to match the peer gateway.</u>
Hard MBytes	Setting the Hard MBytes parameter forces the renegotiation of the IPSec Security Associations (SAs) at the configured Hard MByte value. The value can be configured between 1 and 1,000,000 MB and refers to data traffic passed. <u>This parameter does not need to match the peer gateway.</u>
Hard Seconds	Setting the Hard Seconds parameter forces the renegotiation of the IPSec Security Associations (SAs) at the configured Hard Seconds value. The value can be configured between 60 and 1,000,000 seconds <u>This parameter does not need to match the peer gateway.</u>

Table 3: IPSec Tunnel Details page parameters

IPSec MTU	<p>Some ISPs require a setting of e.g. 1492 (or other value). The default 1500 is the most common and you usually don't need to change this unless otherwise instructed. Accepted values are from 100 – 1500.</p> <p>This is the starting value that is used for the MTU when the IPSec tunnel is installed. It specifies the maximum IP packet length for the encapsulated AH or ESP packets sent by the router. The MTU used on the IPSec connection will be automatically adjusted based on the MTU value in any received ICMP <i>can't fragment</i> error messages that correspond to IPSec traffic initiated from the router. Normally the MTU only requires manual configuration if the ICMP error messages are blocked or otherwise not received by the router.</p>
Xauth Enable	<p>Extended Authentication (XAuth), an extension to the Internet Key Exchange (IKE) protocol. The Xauth extension provides dual authentication for a remote user's Motorola Netopia® Gateway to establish a VPN, authorizing network access to the user's central office. IKE establishes the tunnel, and Xauth authenticates the specific remote user's Gateway. Since NAT is supported over the tunnel, the remote user network can have multiple PCs behind the client Gateway accessing the VPN. By using XAuth, network VPN managers can centrally control remote user authentication.</p>
Xauth Username/ Password	<p>Xauth authentication credentials.</p>

Link: Stateful Inspection

All computer operating systems are vulnerable to attack from outside sources, typically at the operating system or Internet Protocol (IP) layers. Stateful Inspection firewalls intercept and analyze incoming data packets to determine whether they should be admitted to your private LAN, based on multiple criteria, or blocked. Stateful inspection improves security by tracking data packets over a period of time, examining incoming and outgoing packets. Outgoing packets that request specific types of incoming packets are tracked; only those incoming packets constituting a proper response are allowed through the firewall.

Stateful inspection is a security feature that prevents unsolicited inbound access when NAT is disabled. You can configure UDP and TCP “no-activity” periods that will also apply to NAT time-outs if stateful inspection is enabled on the interface. Stateful Inspection parameters are active on a WAN interface only if enabled on your Gateway. Stateful inspection can be enabled on a WAN interface whether NAT is enabled or not.

Stateful Inspection Firewall installation procedure



NOTE:

Installing Stateful Inspection Firewall is mandatory to comply with Required Services Security Policy - Residential Category module - Version 4.1 (specified by ICSA Labs)

For more information please go to the following URL:

<http://www.icsalabs.com/icsa/docs/html/communities/firewalls/pdf/4.1/baseline.pdf>

1. Access the router through the web interface from the private LAN.

DHCP server is enabled on the LAN by default.

2. The Gateway's Stateful Inspection feature must be enabled in order to prevent TCP, UDP and ICMP packets destined for the router or the private hosts.

This can be done by navigating to **Expert Mode** -> **Security** -> **Stateful Inspection**.

- **UDP no-activity time-out:** The time in seconds after which a UDP session will be terminated, if there is no traffic on the session.
- **TCP no-activity time-out:** The time in seconds after which an TCP session will be terminated, if there is no traffic on the session.

- **DoS Detect:** If you check this checkbox, the Gateway will monitor packets for Denial of Service attacks.
- **Exposed Addresses:** The hosts specified in Exposed Addresses will be allowed to receive inbound traffic even if there is no corresponding outbound traffic. This is active only if NAT is disabled on a WAN interface.
- **Stateful Inspection Options:** Enable and configure stateful inspection on a WAN interface.

Exposed Addresses

You can specify the IP addresses you want to expose by clicking the [Exposed addresses](#) link.

Add, Edit, or delete exposed addresses options are active only if NAT is disabled on a WAN interface. The hosts specified in exposed addresses will be allowed to receive inbound traffic even if there is no corresponding outbound traffic.

- **Start Address:** Start IP Address of the exposed host range.
- **End Address:** End IP Address of the exposed host range
- **Protocol:** Select the Protocol of the traffic to be allowed to the host range from the pull-down menu. Options are Any, TCP, UDP, or TCP/UDP.

- **Start Port:** Start port of the range to be allowed to the host range. The acceptable range is from 1 - 65535
- **End Port:** Protocol of the traffic to be allowed to the host range. The acceptable range is from 1 - 65535

You can add more exposed addresses by clicking the [Add more Exposed Addresses](#) link. A list of previously configured exposed addresses appears.

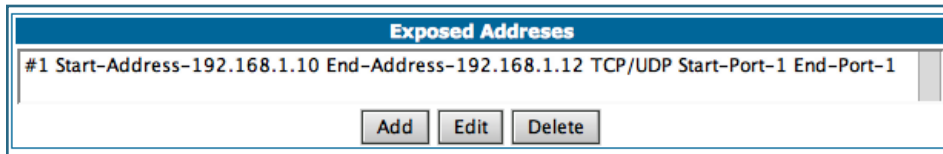

Click the [Add](#) button to add a new range of exposed addresses.

You can edit a previously configured range by clicking the [Edit](#) button, or delete the entry entirely by clicking the [Delete](#) button.

All configuration changes will trigger the Alert Icon.  Click on the Alert icon.

This allows you to validate the configuration and reboot the Gateway.

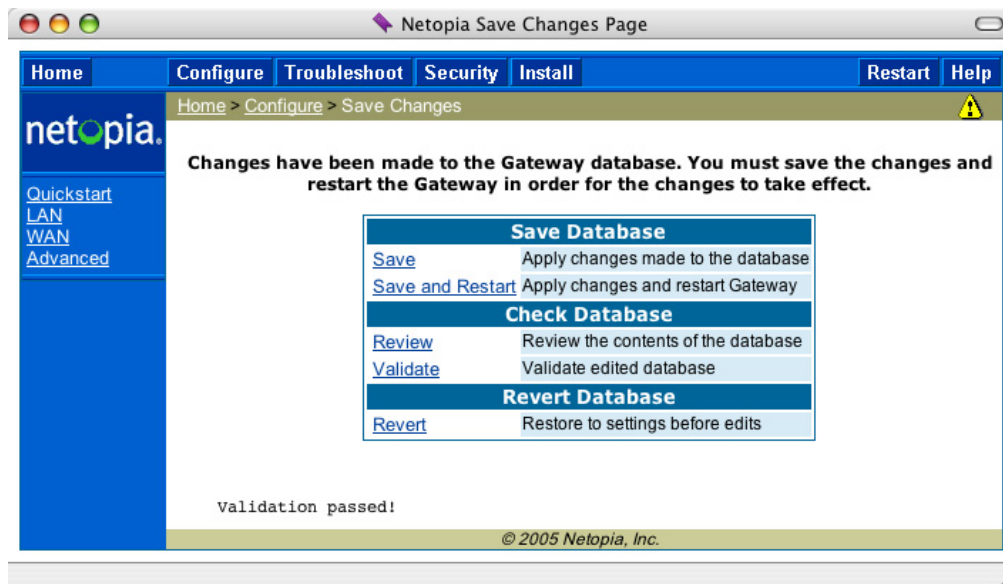

Click the [Save and Restart](#) link. You will be asked to confirm your choice, and the Gateway will reboot with the new configuration.

Stateful Inspection Options

Stateful Inspection Parameters are active on a WAN interface only if you enable them on your Gateway.

PPP over Ethernet vcc1

Stateful Inspection	<input type="checkbox"/>
Default Mapping to Router	<input type="checkbox"/>
TCP Sequence Number Difference	<input type="text" value="0"/>
Deny Fragments	<input type="checkbox"/>

- **Stateful Inspection:** To enable stateful inspection on this WAN interface, check the checkbox.
- **Default Mapping to Router:** This is disabled by default. This option will allow the router to respond to traffic received on this interface, for example, ICMP Echo requests.



NOTE:

If Stateful Inspection is enabled on a WAN interface **Default Mapping to Router** must be enabled to allow inbound VPN terminations to the router.

- **TCP Sequence Number Difference:** Enter a value in this field. This value represents the maximum sequence number difference allowed between subsequent TCP packets. If this number is exceeded, the packet is dropped. The acceptable range is 0 – 65535. A value of 0 (zero) disables this check.
- **Deny Fragments:** To enable this option, which causes the router to discard fragmented packets on this interface, check the checkbox.

Open Ports in Default Stateful Inspection Installation

Port	Protocol	Description	LAN (Private) Interface	WAN (Public) Interface
23	TCP	telnet	Yes	No
53	UDP	DNS	Yes	No
67	UDP	Bootps	Yes	No
68	UDP	Bootpc	Yes	No
80	TCP	HTTP	Yes	No
137	UDP	Netbios-ns	Yes	No
138	UDP	Netbios-dgm	Yes	No
161	UDP	SNMP	Yes	No
500	UDP	ISAKMP	Yes	No
520	UDP	Router	Yes	No

Firewall Tutorial

General firewall terms



Note:

Breakwater Basic Firewall (see “[BreakWater Basic Firewall](#)” on page 142) does not make use of the packet filter support and can be used in addition to filtersets

Filter rule: A filter set is comprised of individual filter rules.

Filter set: A grouping of individual filter rules.

Firewall: A component or set of components that restrict access between a protected network and the Internet, or between two networks.

Host: A workstation on the network.

Packet: Unit of communication on the Internet.

Packet filter: Packet filters allow or deny packets based on source or destination IP addresses, TCP or UDP ports.

Port: A number that defines a particular type of service.

Basic IP packet components

All IP packets contain the same basic header information, as follows:

Source IP Address	163.176.132.18
Destination IP Address	163.176.4.27
Source Port	2541
Destination Port	80
Protocol	TCP
DATA	User Data

This header information is what the packet filter uses to make filtering decisions. It is important to note that a packet filter does not look into the IP data stream (the User Data from above) to make filtering decisions.

Basic protocol types

TCP: Transmission Control Protocol. TCP provides reliable packet delivery and has a retransmission mechanism (so packets are not lost). RFC 793 is the specification for TCP.

UDP: User Datagram Protocol. Unlike TCP, UDP does not guarantee reliable, sequenced packet delivery. If data does not reach its destination, UDP does not retransmit the data. RFC 768 is the specification for UDP.

There are many more ports defined in the Assigned Addresses RFC. The table that follows shows some of these port assignments.

Example TCP/UDP Ports

TCP Port	Service	UDP Port	Service
20/21	FTP	161	SNMP
23	Telnet	69	TFTP
25	SMTP		
80	WWW		
144	News		

Firewall design rules

There are two basic rules to firewall design:

- “What is not explicitly allowed is denied.”

and

- “What is not explicitly denied is allowed.”

The first rule is far more secure, and is the best approach to firewall design. It is far easier (and more secure) to allow in or out only certain services and deny anything else. If the other rule is used, you would have to figure out everything that you want to disallow, now and in the future.

Firewall Logic

Firewall design is a test of logic, and filter rule ordering is critical. If a packet is forwarded through a series of filter rules and then the packet matches a rule, the appropriate action is taken. The packet will not forward through the remainder of the filter rules.

For example, if you had the following filter set...

- Allow WWW access;
- Allow FTP access;
- Allow SMTP access;
- Deny all other packets.

and a packet goes through these rules destined for FTP, the packet would forward through the first rule (WWW), go through the second rule (FTP), and match this rule; the packet is allowed through.

If you had this filter set for example....

- Allow WWW access;

- Allow FTP access;
- Deny FTP access;
- Deny all other packets.

and a packet goes through these rules destined for FTP, the packet would forward through the first filter rule (WWW), match the second rule (FTP), and the packet is allowed through. Even though the next rule is to deny all FTP traffic, the FTP packet will never make it to this rule.

Implied rules

With a given set of filter rules, there is an Implied rule that may or may not be shown to the user. The implied rule tells the filter set what to do with a packet that does not match any of the filter rules. An example of implied rules is as follows:

Implied	Meaning
Y+Y+Y=N	If all filter rules are YES, the implied rule is NO.
N+N+N=Y	If all filter rules are NO, the implied rule is YES.
Y+N+Y=N	If a mix of YES and NO filters, the implied rule is NO.

Example filter set page

This is an example of the Motorola Netopia® filter set page:

Filter Set: Filter

Input Rules:

#	Fwd	Src IP Address	Src Mask	Dst IP Address	Dst Mask	Prot	Src Port	Dst Port
1	No	199.211.211.17	0.0.0.0	0.0.0.0	0.0.0.0	TCP	=23	NC
2	No	0.0.0.0	0.0.0.0	0.0.0.0	0.0.0.0	TCP	NC	=6000
3	Yes	0.0.0.0	0.0.0.0	0.0.0.0	0.0.0.0	ICMP		
4	Yes	0.0.0.0	0.0.0.0	0.0.0.0	0.0.0.0	TCP	NC	=1023
5	Yes	0.0.0.0	0.0.0.0	0.0.0.0	0.0.0.0	UDP	NC	=1023

Output Rules:
No Output Filter Rules have been defined.

Filter basics

In the source or destination IP address fields, the IP address that is entered must be the network address of the subnet. A host address can be entered, but the applied subnet mask must be 32 bits (255.255.255.255).

Netopia Embedded Software Version 7.7.4 has the ability to compare source and destination TCP or UDP ports. These options are as follows:

Item	What it means
No Compare	Does not compare TCP or UDP port
Not Equal To	Matches any port other than what is defined
Less Than	Anything less than the port defined
Less Than or Equal	Any port less than or equal to the port defined
Equal	Matches only the port defined
Greater Than or Equal	Matches the port or any port greater
Greater Than	Matches anything greater than the port defined

Example network

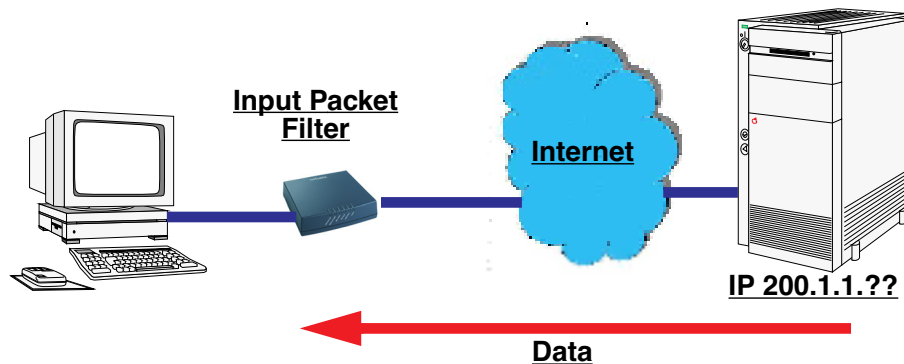

Example filters

Example 1

Filter Rule:	200.1.1.0	(Source IP Network Address)
	255.255.255.128	(Source IP Mask)
	Forward = No	(What happens on match)

Incoming packet has the source address of 200.1.1.28

This incoming IP packet has a source IP address that matches the network address in the Source IP Address field in Netopia Embedded Software Version 7.7.4. This will *not* forward this packet.

Example 2

Filter Rule:	200.1.1.0	(Source IP Network Address)
	255.255.255.128	(Source IP Mask)
	Forward = No	(What happens on match)

Incoming packet has the source address of 200.1.1.184.

This incoming IP packet has a source IP address that does not match the network address in the Source IP Address field in Netopia Embedded Software Version 7.7.4. This rule *will* forward this packet because the packet does not match.

Example 3

Filter Rule:	200.1.1.96	(Source IP Network Address)
	255.255.255.240	(Source IP Mask)
	Forward = No	(What happens on match)

Incoming packet has the source address of 200.1.1.184.

This rule does *not* match and this packet will be forwarded.

Example 4

Filter Rule:	200.1.1.96	(Source IP Network Address)
	255.255.255.240	(Source IP Mask)
	Forward = No	(What happens on match)

Incoming packet has the source address of 200.1.1.104.

This rule *does* match and this packet will *not* be forwarded.

Example 5

Filter Rule:	200.1.1.96	(Source IP Network Address)
	255.255.255.255	(Source IP Mask)
	Forward = No	(What happens on match)

Incoming packet has the source address of 200.1.1.96.

This rule *does* match and this packet will *not* be forwarded. This rule masks off a *single* IP address.

Link: Packet Filter

When you click the [Packet Filter](#) link the **Filter Sets** screen appears.



Security should be a high priority for anyone administering a network connected to the Internet. Using packet filters to control network communications can greatly improve your network's security. The Packet Filter engine allows creation of a maximum of eight Filter Sets. Each Filter Set can consist of many rules. There can be a maximum of 32 filter rules in the system.



WARNING:

Before attempting to configure filters and filter sets, please read and understand this entire section thoroughly. Motorola Netopia® Gateways incorporating NAT have advanced security features built in. Improperly adding filters and filter sets increases the possibility of loss of communication with the Gateway and the Internet. Never attempt to configure filters unless you are local to the Gateway.

Although using filter sets can enhance network security, there are disadvantages:

- Filters are complex. Combining them in filter sets introduces subtle interactions, increasing the likelihood of implementation errors.
- Enabling a large number of filters can have a negative impact on performance. Processing of packets will take longer if they have to go through many checkpoints in addition to NAT.
- Too much reliance on packet filters can cause too little reliance on other security methods. Filter sets are *not* a substitute for password protection, effective safeguarding of passwords, and general awareness of how your network may be vulnerable.

Netopia Embedded Software Version 7.7.4's packet filters are designed to provide security for the Internet connections made to and from your network. You can customize the Gateway's filter sets for a variety of packet filtering applications. Typically, you use filters to selectively admit or refuse TCP/IP connections from certain remote networks and specific hosts. You will also use filters to screen particular types of connections. This is commonly called *firewalling* your network.

Before creating filter sets, you should read the next few sections to learn more about how these powerful security tools work.

What's a filter and what's a filter set?

A filter is a rule that lets you specify what sort of data can flow in and out of your network. A particular filter can be either an input filter—one that is used on data (packets) coming in to your network from the Internet—or an output filter—one that is used on data (packets) going out from your network to the Internet.

A filter set is a group of filters that work together to check incoming or outgoing data. A filter set can consist of a combination of input and output filters.

How filter sets work

A filter set acts like a team of customs inspectors. Each filter is an inspector through which incoming and outgoing packages must pass. The inspectors work as a team, but each inspects every package individually.

Each inspector has a specific task. One inspector's task may be to examine the destination address of all outgoing packages. That inspector looks for a certain destination—which could be as specific as a street address or as broad as an entire country—and checks each package's destination address to see if it matches that destination.

A filter inspects data packets like a customs inspector scrutinizing packages.



Filter priority

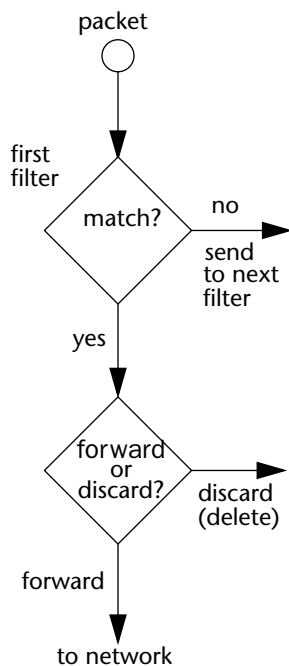

Continuing the customs inspectors analogy, imagine the inspectors lined up to examine a package. If the package matches the first inspector's criteria, the package is either rejected or passed on to its destination, depending on the first inspector's particular orders. In this case, the package is never seen by the remaining inspectors.

If the package does not match the first inspector's criteria, it goes to the second inspector, and so on. You can see that the order of the inspectors in the line is very important.

For example, let's say the first inspector's orders are to send along all packages that come from Rome, and the second inspector's orders are to reject all packages that come from France. If a package arrives from Rome, the first inspector sends it along without allowing the second inspector to see it. A package from Paris is ignored by the first inspector, rejected by the second inspector, and never seen by the others. A package from London is ignored by the first two inspectors, so it's seen by the third inspector.

In the same way, filter sets apply their filters in a particular order. The first filter applied can forward or discard a packet before that packet ever reaches any of the other filters. If the first filter can neither forward nor discard the packet (because it cannot match any criteria), the second filter has a chance to forward or reject it, and so on. Because of this hierarchical structure,

each filter is said to have a priority. The first filter has the highest priority, and the last filter has the lowest priority.

How individual filters work

As described above, a filter applies criteria to an IP packet and then takes one of three actions:

- Forwards the packet to the local or remote network
- Blocks (discards) the packet
- Ignores the packet

A filter forwards or blocks a packet only if it finds a match after applying its criteria. When no match occurs, the filter ignores the packet.

A filtering rule

The criteria are based on information contained in the packets. A filter is simply a rule that prescribes certain actions based on certain conditions. For example, the following rule qualifies as a filter:

“Block all Telnet attempts that originate from the remote host 199.211.211.17.”

This rule applies to Telnet packets that come from a host with the IP address 199.211.211.17. If a match occurs, the packet is blocked.

Here is what this rule looks like when implemented as a filter in Netopia Embedded Software Version 7.7.4:

To understand this particular filter, look at the parts of a filter.

Parts of a filter

A filter consists of criteria based on packet attributes. A typical filter can match a packet on any one of the following attributes:

- The source IP address and subnet mask (where the packet was sent from)
- The destination IP address and subnet mask (where the packet is going)
- The TOS bit setting of the packet. Certain types of IP packets, such as voice or multimedia packets, are sensitive to delays introduced by the network. A delay-sensitive packet is identified by a special low-latency setting called the TOS bit. It is important for such packets to be received rapidly or the quality of service degrades.
- The type of higher-layer Internet protocol the packet is carrying, such as TCP or UDP

Filter Input Rule Entry #1	
Forward	<input type="checkbox"/>
Source IP	199.211.211.17
Source Mask	255.255.255.255
Destination IP	0.0.0.0
Destination Mask	0.0.0.0
TOS	0
TOS Mask	0
Protocol	TCP
Source Port Compare:	Equal to
Source Port:	23
Destination Port Compare:	No compare
<input type="button" value="Submit"/>	
Add or Edit more Filter Rules	

Port numbers

A filter can also match a packet's port number attributes, but only if the filter's protocol type is set to TCP or UDP, since only those protocols use port numbers. The filter can be configured to match the following:

- The source port number (the port on the sending host that originated the packet)
- The destination port number (the port on the receiving host that the packet is destined for)

By matching on a port number, a filter can be applied to selected TCP or UDP services, such as Telnet, FTP, and World Wide Web. The following tables show a few common services and their associated port numbers:

Internet service	TCP port	Internet service	TCP port
FTP	20/21	Finger	79
Telnet	23	World Wide Web	80
SMTP (mail)	25	News	144
Gopher	70	rlogin	513

Internet service	UDP port	Internet service	UDP port
Who Is	43	TFTP	69
World Wide Web	80	who	513
SNMP	161		

Port number comparisons

A filter can also use a comparison option to evaluate a packet's source or destination port number. The comparison options are:

- **No Compare:** No comparison of the port number specified in the filter with the packet's port number.
- **Not Equal To:** For the filter to match, the packet's port number cannot equal the port number specified in the filter.
- **Less Than:** For the filter to match, the packet's port number must be less than the port number specified in the filter.
- **Less Than or Equal:** For the filter to match, the packet's port number must be less than or equal to the port number specified in the filter.
- **Equal:** For the filter to match, the packet's port number must equal the port number specified in the filter.
- **Greater Than:** For the filter to match, the packet's port number must be greater than the port number specified in the filter.
- **Greater Than or Equal:** For the filter to match, the packet's port number must be greater than or equal to the port number specified in the filter.

Other filter attributes

There are three other attributes to each filter:

- The filter's order (i.e., priority) in the filter set
- Whether the filter is currently active
- Whether the filter is set to forward packets or to block (discard) packets

Putting the parts together

When you display a filter set, its filters are displayed as rows in a table:

Filter Set: Filter								
Input Rules:								
#	Fwd	Src IP Address	Src Mask	Dst IP Address	Dst Mask	Prot	Src Port	Dst Port
1	No	199.211.211.17	0.0.0.0	0.0.0.0	0.0.0.0	TCP	=23	NC
2	No	0.0.0.0	0.0.0.0	0.0.0.0	0.0.0.0	TCP	NC	=6000
3	Yes	0.0.0.0	0.0.0.0	0.0.0.0	0.0.0.0	ICMP		
4	Yes	0.0.0.0	0.0.0.0	0.0.0.0	0.0.0.0	TCP	NC	=1023
5	Yes	0.0.0.0	0.0.0.0	0.0.0.0	0.0.0.0	UDP	NC	=1023

Output Rules:
No Output Filter Rules have been defined.

The table's columns correspond to each filter's attributes:

- **#:** The filter's priority in the set. Filter number 1, with the highest priority, is first in the table.
- **Fwd:** Shows whether the filter forwards (**Yes**) a packet or discards (**No**) it when there's a match.
- **Src-IP:** The packet source IP address to match.
- **Src-Mask:** The packet source subnet mask to match.
- **Dst-IP:** The packet destination IP address to match.
- **Dst-Mask:** The packet destination IP address to match.
- **Protocol:** The protocol to match. This can be entered as a number (see the table below) or as TCP or UDP if those protocols are used.

Protocol	Number to use	Full name
N/A	0	Ignores protocol type
ICMP	1	Internet Control Message Protocol
TCP	6	Transmission Control Protocol
UDP	17	User Datagram Protocol

- **Src Port:** The source port to match. This is the port on the sending host that originated the packet.
- **Dst Port:** The destination port to match. This is the port on the receiving host for which the packet is intended.
- **NC:** Indicates No Compare, where specified.

Filtering example #1

Returning to our filtering rule example from above (see [page 165](#)), look at how a rule is translated into a filter. Start with the rule, then fill in the filter's attributes:

- The rule you want to implement as a filter is:

"Block all Telnet attempts that originate from the remote host 199.211.211.17."

- The host 199.211.211.17 is the source of the Telnet packets you want to block, while the destination address is any IP address. How these IP addresses are masked determines what the final match will be, although the mask is not displayed in the table that displays the filter sets (you set it when you create the filter). In fact, since the mask for the destination IP address is 0.0.0.0, the address for Destination IP address could have been anything. The mask for Source IP address must be 255.255.255.255 since an exact match is desired.
 - Source IP Address = 199.211.211.17
 - Source IP address mask = 255.255.255.255
 - Destination IP Address = 0.0.0.0
 - Destination IP address mask = 0.0.0.0
- Using the tables on [page 166](#), find the destination port and protocol numbers (the *local* Telnet port):
 - Protocol = TCP (or 6)
 - Destination Port = 23
- The filter should be enabled and instructed to block the Telnet packets containing the source address shown in step 2:
 - Forward = unchecked

This four-step process is how we produced the following filter from the original rule:

Filter Input Rule Entry #1	
Forward	<input type="checkbox"/>
Source IP	<input type="text" value="199.211.211.17"/>
Source Mask	<input type="text" value="255.255.255.255"/>
Destination IP	<input type="text" value="0.0.0.0"/>
Destination Mask	<input type="text" value="0.0.0.0"/>
TOS	<input type="text" value="0"/>
TOS Mask	<input type="text" value="0"/>
Protocol	<input type="text" value="TCP"/>
Source Port Compare:	<input type="text" value="Equal to"/>
Source Port:	<input type="text" value="23"/>
Destination Port Compare:	<input type="text" value="No compare"/>
<input type="button" value="Submit"/>	
Add or Edit more Filter Rules	

Filtering example #2

Suppose a filter is configured to block all incoming IP packets with the source IP address of 200.233.14.0, regardless of the type of connection or its destination. The filter would look like this:



Filter Input Rule Entry #2	
Forward	<input checked="" type="checkbox"/>
Source IP	200.233.14.0
Source Mask	255.255.255.0
Destination IP	0.0.0.0
Destination Mask	0.0.0.0
TOS	0
TOS Mask	0
Protocol	Any
<input type="button" value="Submit"/>	

This filter blocks any packets coming from a remote network with the IP network address 200.233.14.0. The 0 at the end of the address signifies *any* host on the class C IP network 200.233.14.0. If, for example, the filter is applied to a packet with the source IP address 200.233.14.5, it will block it.

In this case, the mask, must be set to 255.255.255.0. This way, all packets with a source address of 200.233.14.x will be matched correctly, no matter what the final address byte is.



Note:

The protocol attribute for this filter is *Any* by default. This tells the filter to ignore the IP protocol or type of IP packet.

Design guidelines

Careful thought must go into designing a new filter set. You should consider the following guidelines:

- Be sure the filter set's overall purpose is clear from the beginning. A vague purpose can lead to a faulty set, and that can actually make your network *less* secure.
- Be sure each individual filter's purpose is clear.
- Determine how filter priority will affect the set's actions. Test the set (on paper) by determining how the filters would respond to a number of different hypothetical packets.
- Consider the combined effect of the filters. If every filter in a set fails to match on a particular packet, the packet is:
 - Forwarded if all the filters are configured to discard (*not* forward)
 - Discarded if all the filters are configured to forward
 - Discarded if the set contains a combination of forward and discard filters

An approach to using filters

The ultimate goal of network security is to prevent unauthorized access to the network without compromising authorized access. Using filter sets is part of reaching that goal.

Each filter set you design will be based on one of the following approaches:

- That which is not expressly prohibited is permitted.
- That which is not expressly permitted is prohibited.

It is strongly recommended that you take the latter, and safer, approach to all of your filter set designs.

Working with IP Filters and Filter Sets

To work with filters and filter sets, begin by accessing the filter set pages.



NOTE:

Make sure you understand how filters work before attempting to use them. Read the section “Packet Filter” on page 163.



The procedure for creating and maintaining filter sets is as follows:

- 1. Add a new filter set.**
See [Adding a filter set](#), below.
- 2. Create the filters for the new filter set.**
See [“Adding filters to a filter set” on page 172](#).
- 3. Associate the filter set with either the LAN or WAN interface.**
See [“Associating a Filter Set with an Interface” on page 176](#).

The sections below explain how to execute these steps.

Adding a filter set

You can create up to eight different custom filter sets. Each filter set can contain up to 16 output filters and up to 16 input filters. There can be a maximum of 32 filter rules in the system.

To add a new filter set, click the [Add](#) button in the Filter Sets page. The Add Filter Set page appears.

Enter new name for the filter set, for example *Filter Set 1*.

To save the filter set, click the [Submit](#) button. The saved filter set is empty (contains no filters), but you can return to it later to add filters (see [“Adding filters to a filter set”](#)).



NOTE:

As you begin to build a filter set, and as you add filters, after your first entry, the Alert icon

 will appear in the upper right corner of the web page. It will remain until all of your changes are entered and validated. You need not immediately restart the Gateway until your filter set is complete. See [“Associating a Filter Set with an Interface” on page 176](#).

Adding filters to a filter set

There are two kinds of filters you can add to a filter set: input and output. Input filters check packets received from the Internet, destined for your network. Output filters check packets transmitted from your network to the Internet.

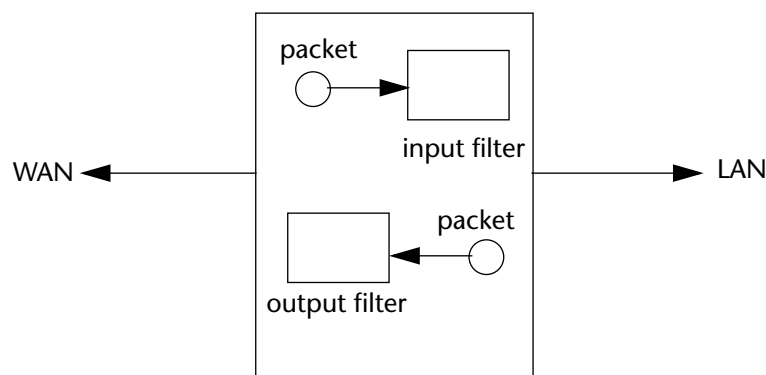

The Motorola Netopia® Router

Packets in Netopia Embedded Software Version 7.7.4 pass through an input filter if they originate from the WAN and through an output filter if they're being sent out to the WAN.

The process for adding input and output filters is exactly the same. The main difference between the two involves their reference to source and destination. From the perspective of an input filter, your local network is the destination of the packets it checks, and the remote network is their source. From the perspective of an output filter, your local network is the source of the packets, and the remote network is their destination.

Type of filter	Source means	Destination means
Input filter	The remote network	The local network
Output filter	The local network	The remote network

To add a filter, select the **Filter Set Name** to which you will add a filter, and click the [Edit](#) button.

Filter Set Associations	
Ethernet 100BT	None
PPP over Ethernet vcc1	None

Filter Sets
Filter Set 1

The Filter Set page appears.

Filter Set: Filter Set 1
Input Rules: <i>No Input Filter Rules have been defined.</i> <input type="button" value="Add"/>
Output Rules: <i>No Output Filter Rules have been defined.</i> <input type="button" value="Add"/>



Note:

There are two [Add](#) buttons in this page, one for input filters and one for output filters. In this section, you'll learn how to add an input filter to a filter set. Adding an output filter works exactly the same way, providing you keep the different source and destination perspectives in mind.

1. To add a filter, click the [Add](#) button under Input Rules.

The Input Rule Entry page appears.

Filter Input Rule Entry #1	
Forward	<input type="checkbox"/>
Source IP	0.0.0.0
Source Mask	0.0.0.0
Destination IP	0.0.0.0
Destination Mask	0.0.0.0
TOS	0
TOS Mask	0
Protocol	Any
<input type="button" value="Submit"/>	

2. If you want the filter to forward packets that match its criteria to the destination IP address, check the *Forward* checkbox.

If Forward is unchecked, packets matching the filter's criteria will be discarded.

3. Enter the *Source IP* address this filter will match on.

You can enter a subnet or a host address.

4. Enter the *Source Mask* for the source IP address.

This allows you to further modify the way the filter will match on the source address. Enter 0.0.0.0 to force the filter to match on all source IP addresses, or enter 255.255.255.255 to match the source IP address exclusively.

5. Enter the *Destination IP* Address this filter will match on.

You can enter a subnet or a host address.

6. Enter the *Destination Mask* for the destination IP address.

This allows you to further modify the way the filter will match on the destination address. Enter 0.0.0.0 to force the filter to match on all destination IP addresses.

7. If desired, you can enter a TOS and TOS Mask value.

See "[Policy-based Routing using Filtersets](#)" on [page 177](#) for more information.

8. Select *Protocol* from the pull-down menu: ICMP, TCP, UDP, Any, or the number of another IP transport protocol (see the table on [page 167](#)).

If Protocol Type is set to TCP or UDP, the settings for port comparison will appear. These settings only take effect if the Protocol Type is TCP or UDP.

9. From the *Source Port Compare* pull-down menu, choose a comparison method for the filter to use on a packet's source port number.

Then select *Source Port* and enter the actual source port number to match on (see the table on [page 166](#)).

10. From the *Destination Port Compare* pull-down menu, choose a comparison method for the filter to use on a packet's destination port number.

Then select *Destination Port* and enter the actual destination port number to match on (see the table on [page 166](#)).

-
11. When you are finished configuring the filter, click the [Submit](#) button to save the filter in the filter set.

Viewing filters

To display the table of input or output filters, select the **Filter Set Name** in the Filter Set page and click the [Add](#) or [Edit](#) button.

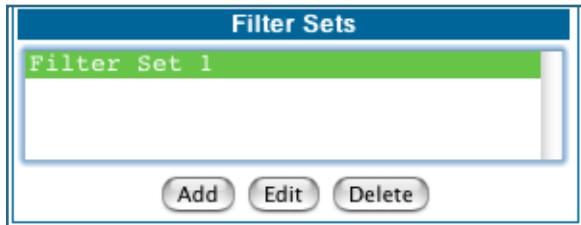

The table of filters in the filtersets appears.

The screenshot shows a window titled "Filter Set: Filter". It contains a table of input rules and a section for output rules.

#	Fwd	Src IP Address	Src Mask	Dst IP Address	Dst Mask	Prot	Src Port	Dst Port
1	No	199.211.211.17	0.0.0.0	0.0.0.0	0.0.0.0	TCP	=23	NC
2	No	0.0.0.0	0.0.0.0	0.0.0.0	0.0.0.0	TCP	NC	=6000
3	Yes	0.0.0.0	0.0.0.0	0.0.0.0	0.0.0.0	ICMP		
4	Yes	0.0.0.0	0.0.0.0	0.0.0.0	0.0.0.0	TCP	NC	=1023
5	Yes	0.0.0.0	0.0.0.0	0.0.0.0	0.0.0.0	UDP	NC	=1023

Below the table are buttons: "Add", "Edit", "Move Down", "Move Up", and "Delete".

Below the buttons is a section titled "Output Rules:" with the text "No Output Filter Rules have been defined." and an "Add" button.

Modifying filters

To modify a filter, select a filter from the table and click the [Edit](#) button. The Rule Entry page appears. The parameters in this page are set in the same way as the ones in the original Rule Entry page (see [“Adding filters to a filter set”](#) on page 172).

Deleting filters

To delete a filter, select a filter from the table and click the [Delete](#) button.

Moving filters

To reorganize the filters in a filter set, select a filter from the table and click the [Move Up](#) or [Move Down](#) button to place the filter in the desired priority position.

Deleting a filter set

If you delete a filter set, all of the filters it contains are deleted as well. To reuse any of these filters in another set, before deleting the current filter set you'll have to note their configuration and then recreate them.

To delete a filter set, select the filter set from the Filter Sets list and click the [Delete](#) button.

Associating a Filter Set with an Interface

Once you have created a filter set, you must associate it with an interface in order for it to be effective. Depending on its application, you can associate it with either the WAN (usually the Internet) interface or the LAN.

To associate a filter set with the LAN, return to the **Filter Sets** page.

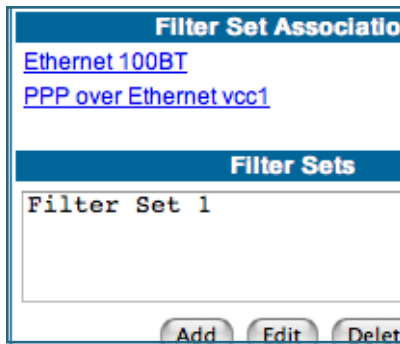

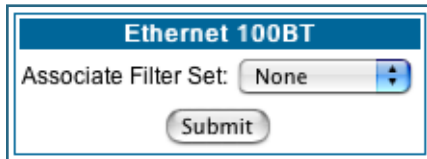

Click the [Ethernet 100BT](#) link.

The **Ethernet 100BT** page appears.

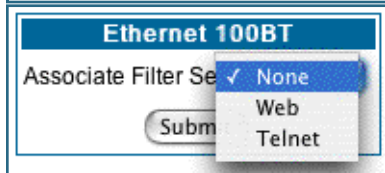

From the pull-down menu, select the filter set to associate with this interface.



Click the [Submit](#) button. The Alert icon will appear in the upper right corner of the page. 

Click the Alert icon to go to the validation page, where you can save your configuration.

You can repeat this process for both the WAN and LAN interfaces, to associate your filter sets.



When you return to the Filter Sets page, it will display your interface associations.

Policy-based Routing using Filtersets

Netopia Embedded Software Version 7.7.4 offers the ability to route IP packets using criteria other than the destination IP address. This is called *policy-based routing*.

You specify the routing criteria and routing information by using IP filtersets to determine the forwarding action of a particular filter.

You specify a gateway IP address, and each packet matching the filter is routed according to that gateway address, rather than by means of the global routing table.

In addition, the classifier list in a filter includes the TOS field. This allows you to filter on TOS field settings in the IP packet, if you want.

Filter Input Rule Entry #1	
Forward:	<input checked="" type="checkbox"/>
Source IP	<input type="text" value="0.0.0.0"/>
Source Mask	<input type="text" value="0.0.0.0"/>
Destination IP	<input type="text" value="0.0.0.0"/>
Destination Mask	<input type="text" value="0.0.0.0"/>
TOS	<input type="text" value="16"/>
TOS Mask	<input type="text" value="16"/>
Protocol:	<input type="text" value="Any"/> ▾
Idle-Reset:	<input type="checkbox"/>
Force Route:	<input checked="" type="checkbox"/>
Gateway IP	<input type="text" value="127.0.0.3"/>
<input type="button" value="Submit"/>	
Add or Edit more Filter Rules	

To use the policy-based routing feature, you create a filter that forwards the traffic.

- Check the **Forward** checkbox. This will display the Force Routing options.
- Check the **Force Route** checkbox.
- Enter the **Gateway IP** address in standard dotted-quad notation to which the traffic should be forwarded.
- You can enter **Source** and **Destination IP Address(es)** and **Mask(s)**, **Protocol Type**, and **Source** and **Destination Port ID(s)** for the filter, if desired.

TOS field matching

Netopia Embedded Software Version 7.7.4 includes two parameters for an IP filter: **TOS** and **TOS Mask**. Both fields accept values in the range 0 – 255.

Certain types of IP packets, such as voice or multimedia packets, are sensitive to latency introduced by the network. A delay-sensitive packet is one that has the low-latency bit set in the TOS field of the IP header. This means that if such packets are not received rapidly, the quality of service degrades. If you expect to route significant amounts of such traffic you can configure your router to route this type of traffic to a gateway

other than your normal gateway using this feature.

The TOS field matching check is consistent with source and destination address matching.

If you check the **Idle Reset** checkbox, a match on this rule will keep the WAN connection alive by resetting the idle-timeout status.

The Idle Reset setting is used to determine if a packet which matches the filter will cause an “instant-on” link to connect, if it is down; or reset its idle timer, if it is already up. For example, if you wanted ping traffic not to keep the link up, you would create a filter which forwards a ping, but with the Idle Reset checkbox unchecked.

Filter Input Rule Entry #1	
Forward:	<input checked="" type="checkbox"/>
Source IP	<input type="text" value="0.0.0.0"/>
Source Mask	<input type="text" value="0.0.0.0"/>
Destination IP	<input type="text" value="0.0.0.0"/>
Destination Mask	<input type="text" value="0.0.0.0"/>
TOS	<input type="text" value="16"/>
TOS Mask	<input type="text" value="16"/>
Protocol:	<input type="text" value="Any"/> ▾
Idle-Reset:	<input type="checkbox"/>
Force Route:	<input checked="" type="checkbox"/>
Gateway IP	<input type="text" value="127.0.0.3"/>
<input type="button" value="Submit"/>	
Add or Edit more Filter Rules	

Example: You want packets with the TOS low latency bit to go through VC 2 (via gateway 127.0.0.3 – the Motorola Netopia® Gateway will use 127.0.0.x, where x is the WAN port + 1) instead of your normal gateway.

You would set up the filter as shown here.



NOTE:

Default Forwarding Filter

If you create one or more filters that have a matching action of *forward*, then action on a packet matching *none* of the filters is to block any traffic.

Therefore, if the behavior you want is to force the routing of a certain type of packet and pass all others through the normal routing mechanism, you must configure one filter to match the first type of packet and apply Force Routing. A subsequent filter is required to match and forward all other packets.

Management IP traffic

If the Force Routing filter is applied to source IP addresses, it may inadvertently block communication with the router itself. You can avoid this by preceding the Force Routing filter with a filter that matches the destination IP address of the Gateway itself.

[Link: Security Log](#)

Security Monitoring is a keyed feature. See [page 187](#) for information concerning installing Motorola Netopia® Software Feature Keys.

Security Monitoring detects security-related events, including common types of malicious attacks, and writes them to the security log file.



Using the Security Monitoring Log

You can view the Security Log at any time. Use the following steps:

1. **Click the [Security toolbar button](#).**
2. **Click the [Security Log link](#).**
3. **Click the [Show link](#) from the Security Log tool bar.**
4. **An example of the Security Log is shown on the next page.**
5. **When a new security event is detected, you will see the [Alert button](#).**

The **Security Alert** remains **until** you view the information. Clicking the Alert button will take you directly to a page showing the log.

Your Netopia Gateway has detected and successfully blocked an event that could have compromised the security of your network.

Please refer to your customer documentation for a description of the logged event.

```

Number of security log entries      :      5

Security alert type                :      Port Scan
Protocol type                     :      TCP
IP source address                 :      143.137.137.14
Time at last attempt              :      Fri May 21 15:17:40 2004 (UTC)
Number of ports that were scanned :      9
Highest port                     :      1167
Lowest port                      :      1094
1102 1108 1094 1099 1166 1167 1151 1160 1164

Security alert type                :      Excessive Pings
IP source address                 :      143.137.137.92
IP destination address           :      143.137.199.8
Number of attempts                :      90
Time at last attempt              :      Fri May 21 17:52:22 2004 (UTC)

Security alert type                :      Port Scan
Protocol type                     :      TCP
IP source address                 :      143.137.50.2
Time at last attempt              :      Fri May 21 17:51:37 2004 (UTC)
Number of ports that were scanned :      241
Highest port                     :      5302
Lowest port                      :      73
111 473 602 863 817 1994 805 395 5302 1670
(Only the first 10 ports are recorded.)

Security alert type                :      Port Scan
Protocol type                     :      UDP
IP source address                 :      143.137.50.2
Time at last attempt              :      Fri May 21 17:52:43 2004 (UTC)
Number of ports that were scanned :      162
Highest port                     :      5236
Lowest port                      :      1
583 1 1471 444 4133 811 5236 650 776 1492
(Only the first 10 ports are recorded.)

Security alert type                :      Illegal Packet Size (Ping of Death)
IP source address                 :      192.168.1.3
IP destination address           :      143.137.199.8
Number of attempts                :      5
Time at last attempt              :      Fri May 21 18:05:33 2004 (UTC)
Illegal packet size               :      65740
    
```

The capacity of the security log is 100 security alert messages. When the log reaches capacity, subsequent messages are not captured, but they are noted in the log entry count.

To reset this log, select **Reset** from the Security Monitor tool bar.

The following message is displayed.

The security log has been reset.

When the Security Log contains no entries, this is the response:

```
The security log is empty.
```

Timestamp Background

During bootup, to provide better log information and to support improved troubleshooting, a Motorola Netopia® Gateway acquires the National Institute of Standards and Technology (NIST) Universal Coordinated Time (UTC) reference signal, and then adjusts it for your local time zone.

Once per hour, the Gateway attempts to re-acquire the NIST reference, for re-synchronization or initial acquisition of the UTC information. Once acquired, all subsequent log entries display this date and time information. UTC provides the equivalent of Greenwich Mean Time (GMT) information.

If the WAN connection is not enabled (or NTP has been disabled), the internal clocking function of the Gateway provides log timestamps based on “uptime” of the unit.

Install

Button: [Install](#)

From the **Install** toolbar button you can Install new Operating System Software and Feature Keys as updates become available.

The descriptions below provide information on the links displayed on the left of the screen.

Install Certificate	Installation page for SSL certificate.
Install Key	Installation page for software keys. These allow additional features to run on the Gateway. A list of features available for the Gateway can be viewed from the System Status page.
Install Software	Installation page for upgrading the operating system software.

On selected models, you can install a Secure Sockets Layer (SSL V3.0) certificate from a trusted Certification Authority (CA) for authentication purposes. If this feature is available on your Gateway, the [Install Certificate](#) link will appear in the Install page as shown. Otherwise, it will not appear.

Link: Install Software

(This link is not available on the 3342/3352 models, since firmware updates must be upgraded via the USB host driver. 3342N/3352N models **are** upgradeable by this procedure.)

This page allows you to install an updated release of the Motorola Netopia® Firmware.

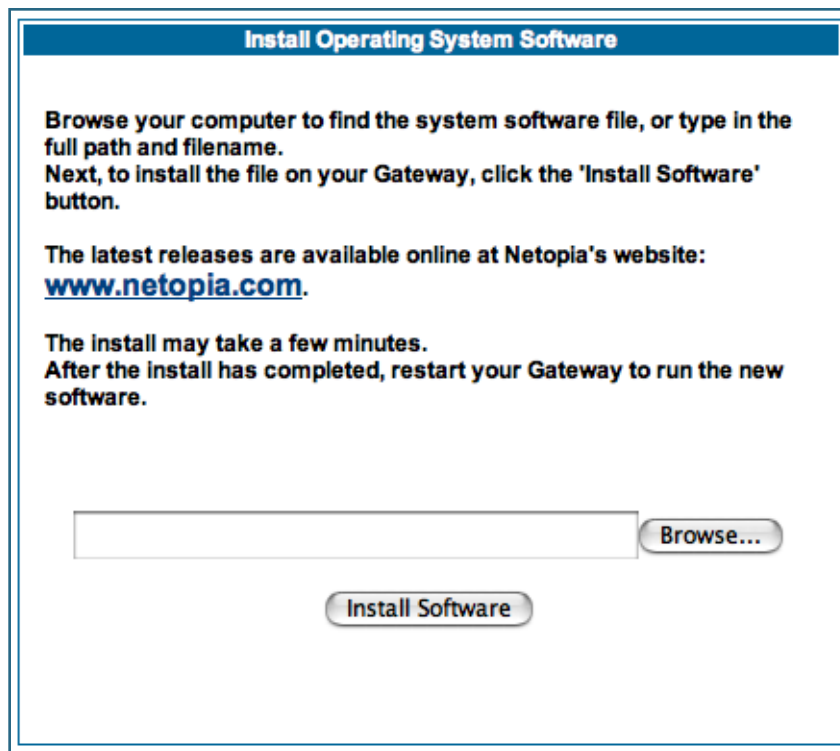

The screenshot shows a web interface titled "Install Operating System Software". The text reads: "Browse your computer to find the system software file, or type in the full path and filename. Next, to install the file on your Gateway, click the 'Install Software' button." Below this, it says: "The latest releases are available online at Netopia's website: www.netopia.com." Further down, it states: "The install may take a few minutes. After the install has completed, restart your Gateway to run the new software." At the bottom, there is a text input field with a "Browse..." button to its right, and a large "Install Software" button centered below.

Updating Your Gateway's Motorola Netopia® Firmware Version. You install a new operating system image in your unit from the Install Operating System Software page. For this process, the computer you are using to connect to the Motorola Netopia® Gateway must be on the same local area network as the Motorola Netopia® Gateway.

Step 1: Required Files

Upgrading Netopia Embedded Software Version 7.7.4 requires a Motorola Netopia® firmware image file.

Background

Firmware upgrade image files are posted periodically on the Motorola Netopia® website. You can download the latest operating system software for your Gateway by accessing the following URL:

<http://www.netopia.com/support/hardware/>

Be sure to download the correct file for your particular Gateway. Different Gateway models have different firmware files. Also, be sure your ISP supports the version of firmware you want to use.

When you download your firmware upgrade from the Motorola Netopia® website, be sure to download the latest *User Guide* PDF files. These are also posted on the Motorola Netopia® website in the Documentation Center.

Confirm Motorola Netopia® Firmware Image Files

The Motorola Netopia® firmware Image file is specific to the model and the product identification number.

1. **Confirm that you have received the appropriate Motorola Netopia® Firmware Image file.**
2. **Save the Motorola Netopia® Firmware image file to a convenient location on your PC.**

Step 2: Motorola Netopia® firmware Image File

Install the Motorola Netopia® firmware Image

To install the Motorola Netopia® firmware in your Motorola Netopia® Gateway from the **Home Page** use the following steps:

1. **Open a web connection to your Motorola Netopia® Gateway from the computer on your LAN.**
2. **Click the [Install Software](#) button on the Motorola Netopia® Gateway Home page.**

The *Install Operating System Software* window opens.

3. **Enter the filename into the text box by using one of these techniques:**

The Motorola Netopia® firmware file name begins with a shortened form of the version number and ends with the suffix “.bin” (for “binary”). Example: *nta760.bin*

- a. Click the Browse button, select the file you want, and click [Open](#).

-or-

- b. Enter the name and path of the software image you want to install in the text field.

4. **Click the [Install Software](#) button.**

The Motorola Netopia® Gateway copies the image file from your computer and installs it into its memory storage. You see a progress bar appear on your screen as the image is copied and installed.

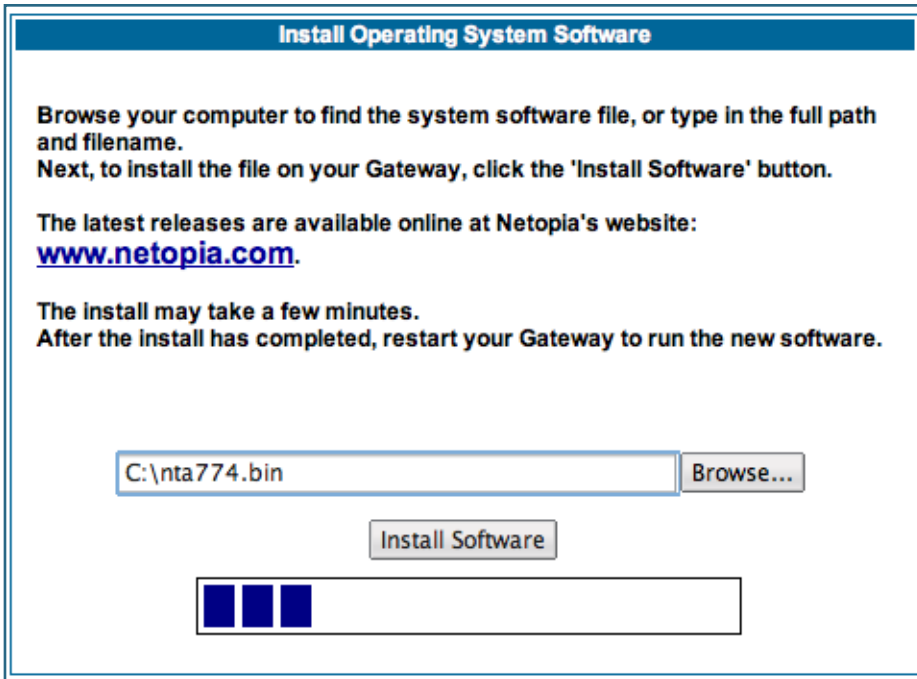

When the image has been installed, a success message displays.

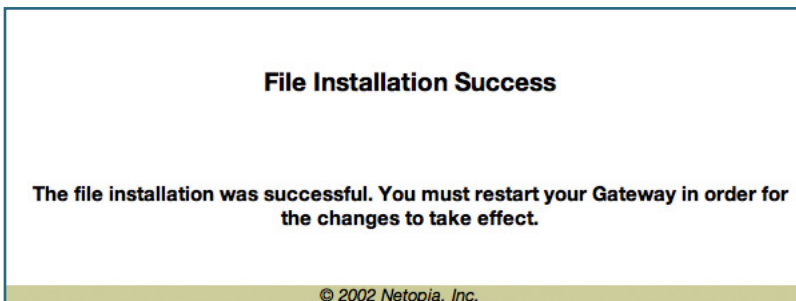

5. **When the success message appears, click the Restart button and confirm the Restart when you are prompted.**

Your Motorola Netopia® Gateway restarts with its new image.

Verify the Motorola Netopia® Firmware Release

To verify that the Motorola Netopia® firmware image has loaded successfully, use the following steps:

1. **Open a web connection to your Motorola Netopia® Gateway from the computer on your LAN and return to the Home page.**

2. Verify your Motorola Netopia® firmware release, as shown on the Home Page.

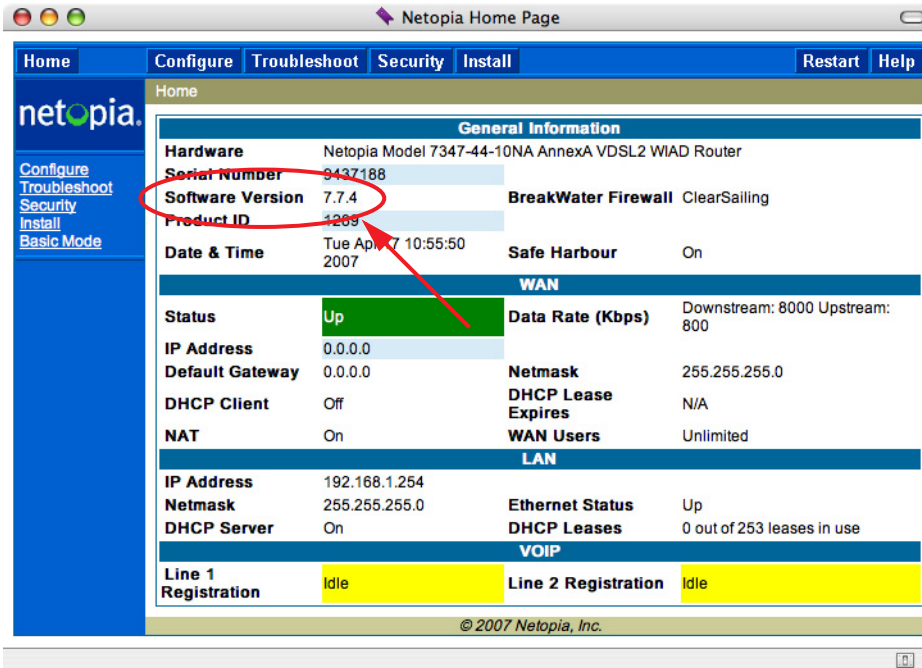

This completes the upgrade process.

[Link: Install Key](#)

You can obtain advanced product functionality by employing a software **Feature Key**. Software feature keys are specific to a Gateway's serial number. Once the feature key is installed and the Gateway is restarted, the new feature's functionality becomes enabled.

Use Motorola Netopia® Software Feature Keys

Motorola Netopia® Gateway users obtain advanced product functionality by installing a *software feature key*. This concept utilizes a specially constructed and distributed keycode (referred to as a feature key) to enable additional capability within the unit.

Software feature key properties are specific to a unit's serial number; they will not be accepted on a platform with another serial number.

Once installed, and the Gateway restarted, the new feature's functionality becomes available. This allows full access to configuration, operation, maintenance and administration of the new enhancement.

Obtaining Software Feature Keys

Contact Motorola or your Service Provider to acquire a Software Feature Key.

Procedure - Install a New Feature Key File

With the appropriate feature keycode, use the steps listed below to enable a new function.

1. **From the Home page, click the [Install](#) toolbar button.**
2. **Click [Install Keys](#)**
The Install Key File page appears.
3. **Enter the feature keycode in the input Text Box.**
Type the full keycode in the Text Box.

Install Key

You may be able to extend the features of your Gateway by purchasing an Upgrade Key. A list of upgrades is available online at www.netopia.com. To purchase an upgrade you must provide your serial number, which is: 10095016

Type in the Upgrade Key exactly as given. It is case sensitive.

After the install has completed, restart your Gateway to enable the new features.

4. Click the [Install Key](#) button.

File Installation Success

The file installation was successful. You must restart your Gateway in order for the changes to take effect.

5. Click the [Restart](#) toolbar button.

The Confirmation screen appears.

Restart Gateway

Restarting the Gateway is needed to enable:

- Changes to your Gateway database configuration
- New feature keys
- Operating System Software Upgrades

When you restart:

- All users will be disconnected
- You will be returned to the Home page
- The Gateway will not respond to your web requests. This inactivity may last for approximately 2 minutes.

[Restart Gateway](#)

6. Click the [Restart the Gateway](#) link to confirm.

To check your installed features:

7. Click the [Install](#) toolbar button.

8. Click the [list of features](#) link.

The System Status page appears with the information from the features link displayed below. You can check that the feature you just installed is enabled.

Select an option from the table below:

General	All Status Overview Features Memory
Ports	Ethernet DSL Wireless
IP	Interfaces Routes ARP LAN-Discovery
DSL	Statistics Circuit Configuration
System Log	Entire Page by Page Reset
Other	DHCP Client DHCP Server PPPoE Wireless Clients

Available features:

Feature	Mode	Expiration	Notes
Security Monitoring	Keyed	None	
ATM VCCs	Keyed	None	Limit: 8
PPPoE Sessions	Keyed	None	Limit: 8
Concurrent WAN Users	Keyed	None	Unlimited
Basic Firewall	Keyed	None	
VPN	Keyed	None	
Enterprise Class Upgrade	Keyed	None	

[Link: Install Certificate](#)

Secure Sockets Layer (SSL) is a protocol for transmitting private information over the Internet. SSL uses two keys to encrypt data: a public key known to everyone and a private or secret key known only to the recipient of the message.

Netopia Embedded Software Version 7.7.4 uses SSL certificates for TR-069 support.

SSL certificates are issued by trusted Certification Authorities (CAs). The CA digitally signs each certificate. Each client contains a list of trusted CAs. When an SSL handshake between a server and your Gateway occurs, the client verifies that the server certificate was issued by a trusted CA. If the CA is not trusted, a warning will appear. Certificates installed in your Gateway and servers to which it connects verify to each other that communications between them are encrypted and private.

Certificates are purchased from an issuing Certificate Authority, usually by your corporate IT department or other service provider, and provided to users for secure communications.

You must obtain a certificate file before you can install it.

1. **To install an SSL certificate, click the [Install Certificate](#) link.**

The descriptions below provide information on the links displayed on the left of the screen.	
Install Certificate	Installation page for SSL certificate.
Install Key	Installation page for software keys. These allow additional features to run on the Gateway. A list of features available for the Gateway can be viewed from the System Status page.
Install Software	Installation page for upgrading the operating system software.

The Install Certificate page appears.

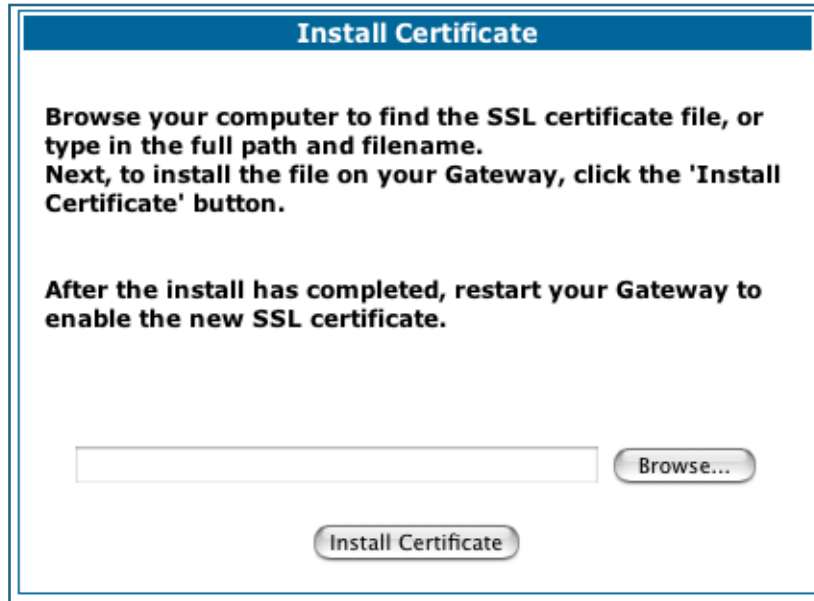

Install Certificate

Browse your computer to find the SSL certificate file, or type in the full path and filename. Next, to install the file on your Gateway, click the 'Install Certificate' button.

After the install has completed, restart your Gateway to enable the new SSL certificate.

2. **Browse to the location where you have saved your certificate and select the file, or type the full path.**
3. **Click the [Install Certificate](#) button.**
4. **Restart your Gateway.**

CHAPTER 4 *Basic Troubleshooting*

This section gives some simple suggestions for troubleshooting problems with your Gateway's initial configuration.

Before troubleshooting, make sure you have

- read the *Quickstart Guide*;
- plugged in all the necessary cables; and
- set your PC's TCP/IP controls to obtain an IP address automatically.

Status Indicator Lights

The first step in troubleshooting is to check the status indicator lights (LEDs) in the order outlined below.

Motorola Netopia® Gateway 2210 status indicator lights

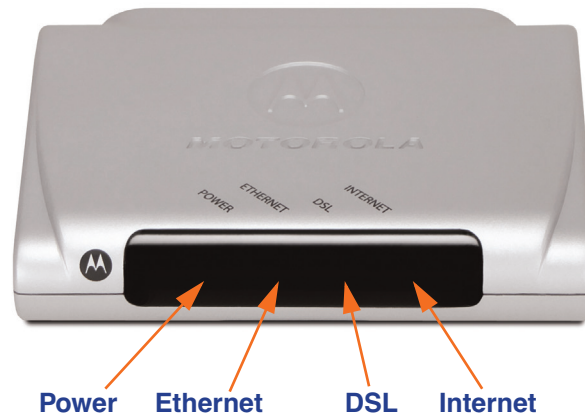

LED	Action
Power	Green when power is on. Red if device malfunctions. Flashes Red when new embedded software is being installed.
Ethernet	Solid green when connected. Flash green when there is activity on the LAN.
DSL	Solid green when trained. Blinking green when no line is attached or when training.
Internet	Solid green when Broadband device is connected. Flashes green for activity on the WAN port. If the physical link comes up, but PPP or DHCP fail, the LED turns red .

Motorola Netopia® Gateway 2240N/2241N status indicator lights

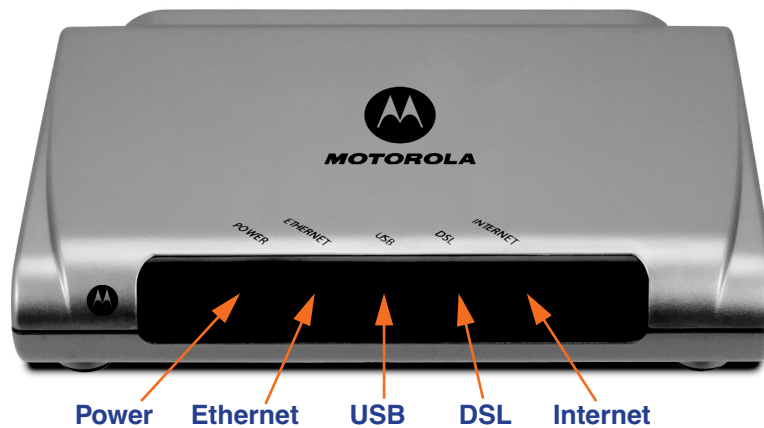

LED	Action
Power	Green when power is on. Red if device malfunctions. Flashes Red when new embedded software is being installed.
Ethernet	Solid green when connected. Flash green when there is activity on the LAN.
USB (Model 2241N only)	Solid green when connected. Flash green when there is activity on the LAN.
DSL	Solid green when trained. Blinking green when no line is attached or when training.
Internet	Solid green when Broadband device is connected. Flashes green for activity on the WAN port. If the physical link comes up, but PPP or DHCP fail, the LED turns red .

Motorola Netopia® Gateway 2246N status indicator lights

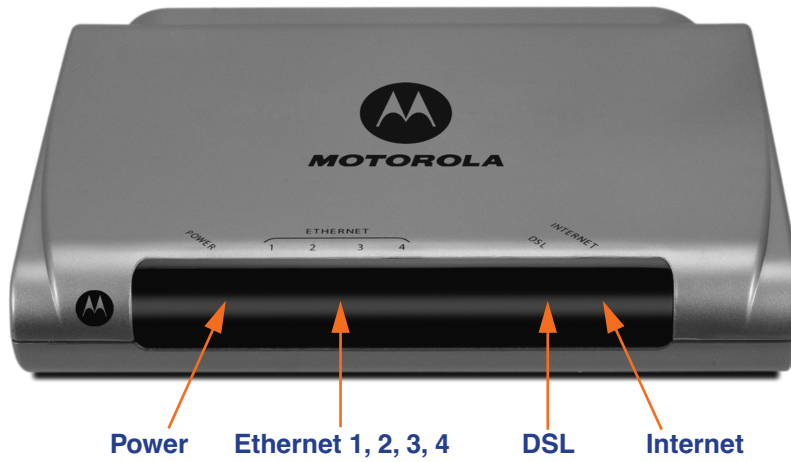

LED	Action
Power	Green when power is on. Red if device malfunctions. Flashes Red when new embedded software is being installed.
Ethernet 1, 2, 3, 4	Solid green when connected. Flash green when there is activity on the LAN.
DSL	Solid green when trained. Blinking green when no line is attached or when training.
Internet	Solid green when Broadband device is connected. Flashes green for activity on the WAN port. If the physical link comes up, but PPP or DHCP fail, the LED turns red .

Motorola Netopia® Gateway 2247NWG status indicator lights



LED	Action
Power	<i>Green</i> when power is on. <i>Red</i> if device malfunctions. Flashes <i>Red</i> when new embedded software is being installed.
Ethernet 1, 2, 3, 4	Solid <i>green</i> when connected. Flash <i>green</i> when there is activity on the LAN.
Wireless	Flashes <i>green</i> when there is activity on the wireless LAN. Off if driver fails to initialize, or if wireless is disabled.
DSL	Solid <i>green</i> when trained. Blinking <i>green</i> when no line is attached or when training.
Internet	Solid <i>green</i> when Broadband device is connected. Flashes <i>green</i> for activity on the WAN port. If the physical link comes up, but PPP or DHCP fail, the LED turns <i>red</i> .

Motorola Netopia® Gateway 3340(N), 3341(N), 3351(N) status indicator lights

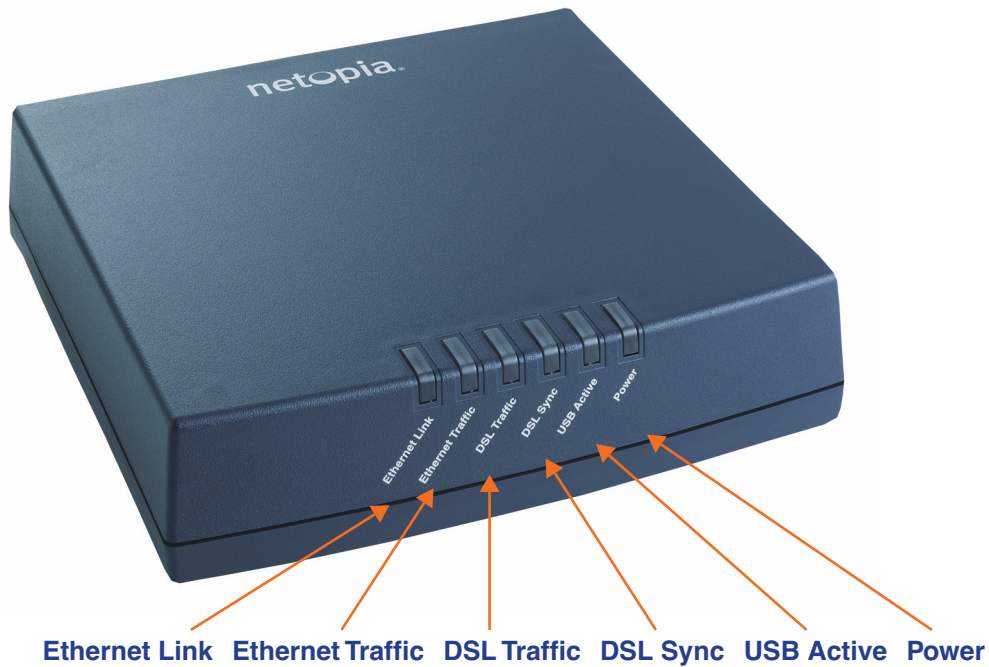

LED	Action
Ethernet Link	Solid green when connected.
Ethernet Traffic	Flashes green when there is activity on the LAN.
DSL Traffic	Blinks green when traffic is sent/received over the WAN.
DSL Sync	Blinking green with no line attached or training, solid green when trained with the DSL line.
USB Active (Model 3341N only)	Solid green when connected; otherwise, not lit.
PPPoE Active (Model 3340N only)	Solid green when PPPoE is negotiated; otherwise, not lit.
Power	Green when power is on. Red if device malfunctions. Flashes Red when new embedded software is being installed.

Motorola Netopia® Gateway 3342/3342N, 3352/3352N status indicator lights

USB:

Solid **green** when USB is connected
otherwise, not lit



DSL:

Blinking **green** with no line attached or training,
solid **green** when trained with the DSL line.



Special patterns:

- Both LEDs are off during boot (power on boot or warm reboot).
- When the 3342/3352 successfully boots up, both LEDs flash green once.
- Both LEDs are off when the Host OS suspends the device, (e.g. Windows standby/reboot, device disabled, driver uninstalled, etc.)

Motorola Netopia® Gateway 3346(N), 3356(N) status indicator lights

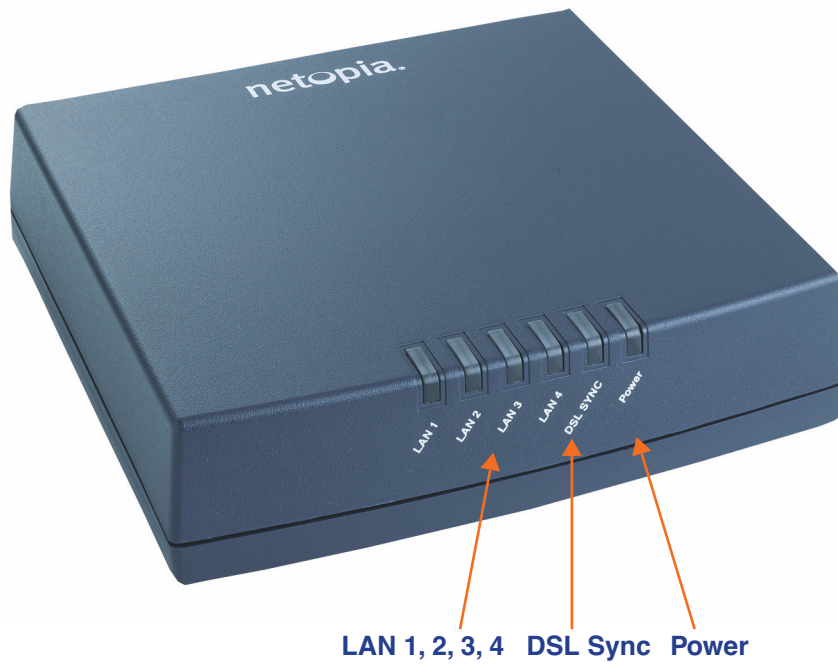

LED	Action
Power	Green when power is on. Red if device malfunctions. Flashes Red when new embedded software is being installed.
DSL Sync	Blinking green with no line attached or training, solid green when trained with the DSL line.
LAN 1, 2, 3, 4	Solid green when connected; Flash green when there is activity on the LAN.

Motorola Netopia® Gateway 3347W, 3347(N)WG status indicator lights



LED	Action
Power	Green when power is on. Red if device malfunctions. Flashes Red when new embedded software is being installed.
DSL Sync	Solid green when trained. Blinking green when no line is attached or when training. Flashes green for DSL traffic.
Ethernet 1, 2, 3, 4	Solid green when connected. Flash green when there is activity on the LAN.
Wireless Link	Flashes green when there is activity on the wireless LAN. Off if driver fails to initialize, or if wireless is disabled.

Motorola Netopia® Gateway MiAVo status indicator lights



LED	Action
Power	Green when power is on. Red if device malfunctions. Flashes Red when new embedded software is being installed.
DSL (DSL 1 & 2: ADSL2+ models only)	Solid green when trained. Blinking green when no line is attached or when training. Flashes green for DSL traffic.
Ethernet 1, 2, 3, 4	Solid green when connected. Flash green when there is activity on the LAN.
Wireless	Flashes green when there is activity on the wireless LAN. Off if driver fails to initialize, or if wireless is disabled.

Motorola Netopia® Gateway 7346/56-series MiAVo status indicator lights

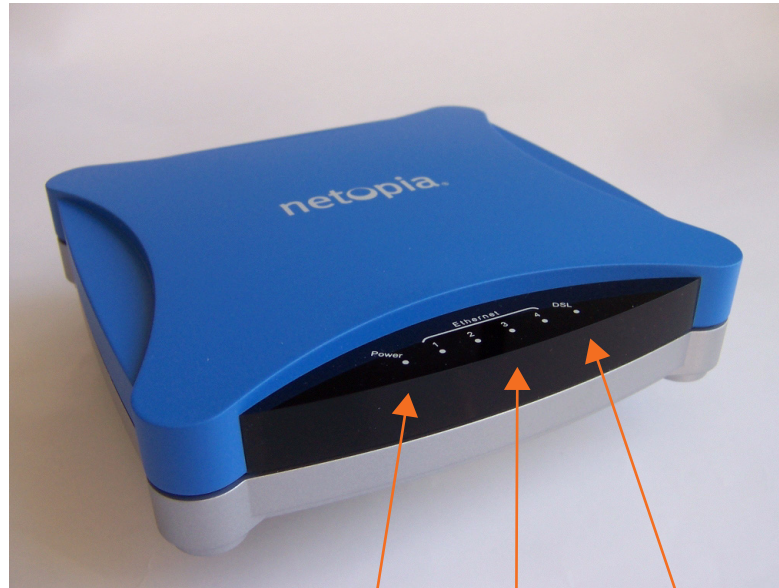

Power Ethernet 1, 2, 3, 4 DSL

LED	Action
Power	Green when power is on. Red if device malfunctions. Flashes Red when new embedded software is being installed.
Ethernet 1, 2, 3, 4	Solid green when connected. Flash green when there is activity on the LAN.
DSL	Solid green when trained. Blinking green when no line is attached or when training. Flashes green for DSL traffic.

LED Function Summary Matrix

	Unlit	Solid Green	Flashing Green	Solid Red	Flashing Red
Power	No power	Power on	N/A	System failure	Installing new embedded software
USB Active	No signal	USB port connected to PC	Activity on the USB cable	N/A	N/A
DSL Sync	No signal	DSL line synched with the DSLAM	Attempting to train with DSLAM	N/A	N/A
DSL Traffic	No signal	N/A	Activity on the DSL cable	N/A	N/A
Ethernet Traffic	No signal	N/A	Activity on the Ethernet port	N/A	N/A
Ethernet Link	No signal	Synched with Ethernet card	N/A	N/A	N/A
Internet	No signal	Broadband device is connected.	Activity on the WAN port.	Physical link established, but PPP or DHCP fails.	N/A
Wireless	Wireless is disabled.	Wireless is enabled.	Activity on the WLAN.	N/A	N/A

If a status indicator light does not look correct, look for these possible problems:

LED	State	Possible problems
Power	Unlit	<ol style="list-style-type: none"> 1. Make sure the power switch is in the ON position. 2. Make sure the power adapter is plugged into the 2200-, 3300- or 7000-series DSL Gateway properly. 3. Try a known good wall outlet. 4. Replace the power supply and/or unit.
DSL Sync	Unlit	<ol style="list-style-type: none"> 1. Make sure the you are using the correct cable. The DSL cable is the thinner standard telephone cable. 2. Make sure the DSL cable is plugged into the correct wall jack. 3. Make sure the DSL cable is plugged into the DSL port on the 2200-, 3300- or 7000-series DSL Gateway. 4. Make sure the DSL line has been activated at the central office DSLAM. 5. Make sure the 2200-, 3300- or 7000-series DSL Gateway is not plugged into a micro filter.
EN Link	Unlit	<p>Note: EN Link light is inactive if only using USB.</p> <ol style="list-style-type: none"> 1. Make sure the you are using the Ethernet cable, not the DSL cable. The Ethernet cable is thicker than the standard telephone cable. 2. Make sure the Ethernet cable is securely plugged into the Ethernet jack on the PC. 3. If plugging a 2200-, 3300- or 7000-series DSL Gateway into a hub the you may need to plug into an uplink port on the hub, or use an Ethernet cross over cable. 4. Make sure the Ethernet cable is securely plugged into the Ethernet port on the 2200-, 3300- or 7000-series DSL Gateway. 5. Try another Ethernet cable if you have one available.

EN Traffic	Unlit	<ol style="list-style-type: none"> 1. Make sure you have Ethernet drivers installed on the PC. 2. Make sure the PC's TCP/IP Properties for the Ethernet Network Control Panel is set to obtain an IP address via DHCP. 3. Make sure the PC has obtained an address in the 192.168.1.x range. (You may have changed the subnet addressing.) 4. Make sure the PC is configured to access the Internet over a LAN. 5. Disable any installed network devices (Ethernet, HomePNA, wireless) that are not being used to connect to the 2200-, 3300- or 7000-series DSL Gateway.
USB Active	Unlit	<p>Note: USB Active light is inactive if only using Ethernet.</p> <ol style="list-style-type: none"> 1. Make sure you have USB drivers installed on the PC. 2. Make sure the PC's TCP/IP Properties for the USB Network Control Panel is set to obtain an IP address via DHCP. 3. Make sure the PC has obtained an address in the 192.168.1.x range. (You may have changed the subnet addressing.) 4. Make sure the PC is configured to access the Internet over a LAN. 5. Disable any installed network devices (Ethernet, HomePNA, wireless) that are not being used to connect to the 2200-, 3300- or 7000-series DSL Gateway.
DSL Traffic	Unlit	Launch a browser and try to browse the Internet. If the DSL Active light still does not flash, then proceed to Advanced Troubleshooting below.
Wireless Link	Unlit	<ul style="list-style-type: none"> • Make sure your client PC(s) have their wireless cards correctly installed and configured. • Check your client PC(s) TCP/IP settings to make sure they are receiving an IP address from the wireless Router. • Check the Gateway's log for wireless driver failure messages.

Factory Reset Switch

(not supported on some models; 3342/3342N/3352/3352N models do not have a reset switch)

Lose your password? This section shows how to reset the Motorola Netopia® Gateway so that you can access the configuration screens once again.



NOTE: Keep in mind that all of your settings will need to be reconfigured.

If you don't have a password, the only way to access the Motorola Netopia® Gateway is the following:

1. Referring to the following diagram, find the round Reset Switch opening.

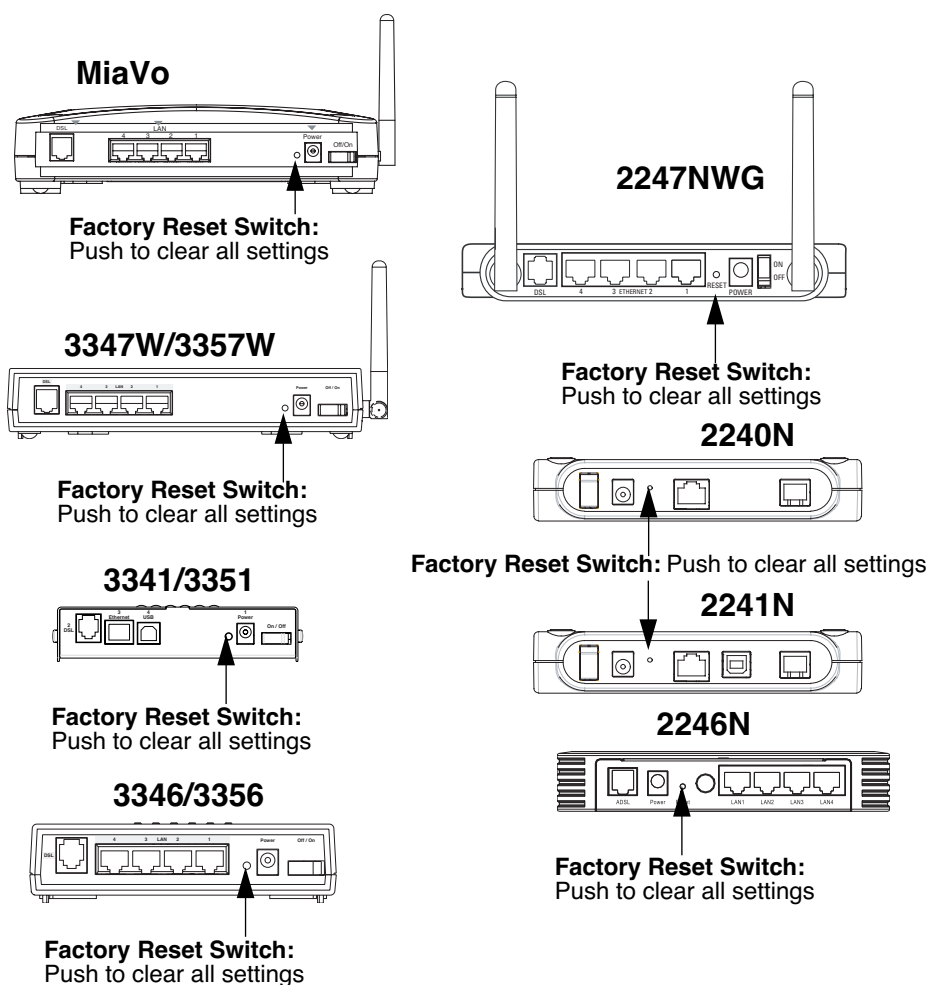

2. Carefully insert the point of a pen or an unwound paperclip into the opening.

- If you press the factory default button for less than 1/2 a second, the unit will continue to run as normal.
- If you press the factory default button for 1 second, when you release it, the Gateway will perform a factory reset, clear all settings and configurations, and reboot. Do not hold the button down too long (5 – 10 seconds). This will destroy any saved default settings as well.

CHAPTER 5 *Advanced Troubleshooting*

Advanced Troubleshooting can be accessed from the Gateway's Web UI. Point your browser to <http://192.168.1.254>. The main page displays the device status. (If this does not make the Web UI appear, then do a release and renew in Windows networking to see what the Gateway address really is.)

Home Page

The home page displays basic information about the Gateway. This includes the ISP Username, Connection Status, Device Address, Remote Gateway Address, DNS-1, and DNS-2. If you are not able to connect to the Internet, verify the following:

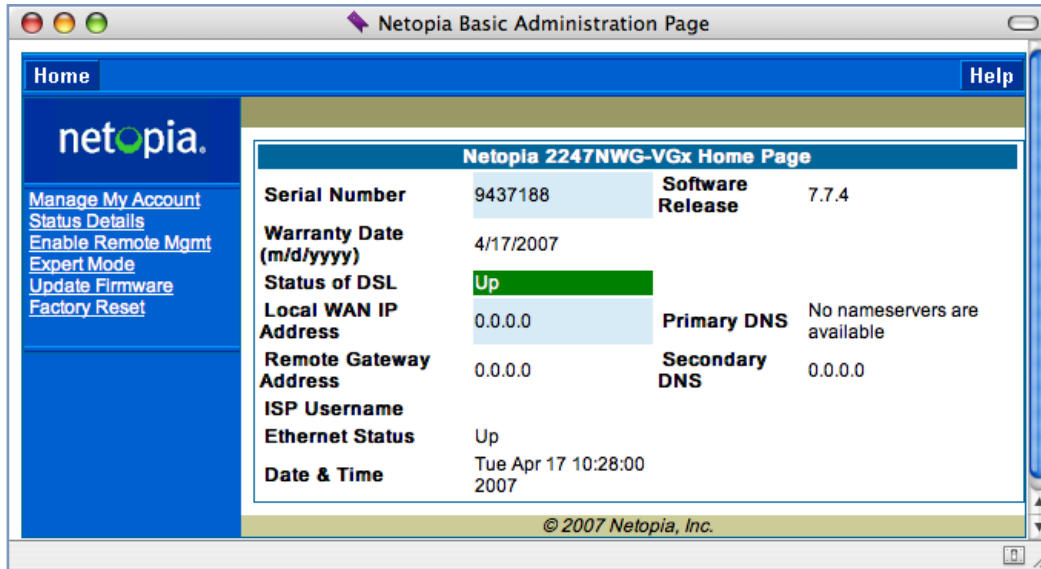

Item	Description
Local WAN IP Address	This is the negotiated address of the Gateway's WAN interface. This address is usually dynamically assigned.
Remote Gateway Address	This is the negotiated address of the remote router to which this Gateway is connected.
Status of Connection	<p>'Waiting for DSL' is displayed while the Gateway is training. This should change to 'Up' within two minutes. If not, make sure an RJ-11 cable is used, the Gateway is connected to the correct wall jack, and the Gateway is not plugged into a micro filter.</p> <p>'No Connection' is displayed if the Gateway has trained but failed the PPPoE login. This usually means an invalid user name or password. Go to Expert Mode and change the PPPoE name and password.</p> <p>'Up' is displayed when the ADSL line is synched and the PPPoE (or other connection method) session is established.</p> <p>'Down' is displayed if the line connection fails.</p>
ISP Username	This should be the valid PPPoE username. If not, go to Expert Mode and change to the correct username.
Device Address	<p>This is the negotiated address of the Gateway's WAN interface. This address is often dynamically assigned. Make sure this is a valid address.</p> <p>If this is not the correct assigned address, go to Expert Mode and verify the PPPoE address has not been manually assigned.</p>

Item	Description
Device Gateway	This is the negotiated address of the remote router. Make sure this is a valid address. If this is not the correct address, go to Expert Mode and verify the address has not been manually assigned.
Primary DNS/ Secondary DNS	These are the negotiated DNS addresses. Make sure they are valid DNS addresses. (Secondary DNS is optional, and may validly be blank (0.0.0.0).) If these are not the correct addresses, go to Expert Mode and verify the addresses have not been manually assigned.
Serial Number	This is the unique serial number of your Gateway.
Ethernet Status	(if so equipped; not available on 3342/3342N/3352/3352N) This is the status of your Ethernet connection. If you are connecting via Ethernet, it should be Up .
USB Status	This is the status of your USB connection (if equipped). If you are connecting via USB, it should be Up .
Software Release	This is the version number of the current embedded software in your Gateway.
Warranty Date	This is the date that your Gateway was installed and enabled.
Date & Time	If this is blank, you likely lack a network connection, or your NTP server information is incorrect.

NOTE: The Home Page may also display **Wireless, VoIP or Backup status depending on model and configuration.** See [“Wireless” on page 53](#), [“VoIP” on page 120](#), or [“Backup” on page 133](#) for more information.

If all of the above seem correct, then access Expert Mode by clicking the [Expert Mode](#) link.

Button: Troubleshoot

Expert Mode

Expert Mode has advanced troubleshooting tools that are used to pinpoint the exact source of a problem.

Clicking the Troubleshoot tab displays a page with links to System Status, Network Tools, and Diagnostics.

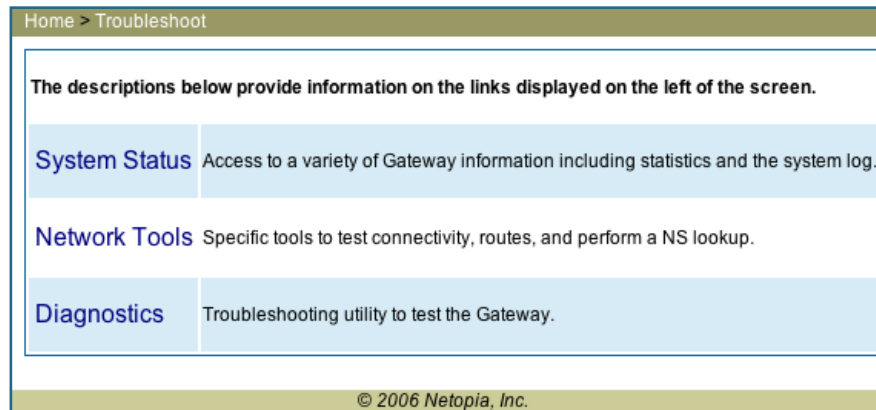

- **System Status:** Displays an overall view of the system and its condition.
- **Network Tools:** Includes NSLookup, Ping and TraceRoute.
- **Diagnostics:** Runs a multi-layer diagnostic test that checks the LAN, WAN, PPPoE, and other connection issues.

[Link: System Status](#)

In the system status screen, there are several utilities that are useful for troubleshooting.

Select an option from the table below:

General	All Status Overview Features Memory
Ports	Ethernet DSL Wireless
IP	Interfaces Routes ARP LAN-Discovery
DSL	Statistics Circuit Configuration
System Log	Entire Page by Page Reset
Other	DHCP Client DHCP Server PPPoE Wireless Clients

Some examples are given in the following pages.

Link: Ports: Ethernet

The Ethernet port selection shows the traffic sent and received on the Ethernet interface. There should be frames and bytes on both the upstream and downstream sides. If there are not, this could indicate a bad Ethernet cable or no Ethernet connection. Below is an *example*:

```
Ethernet Driver Statistics - 10/100 Ethernet
Type: 100BASET
Port Status: Link up
General:
  Transmit OK           : 7862
  Receive OK           : 4454
  Tx Errors             : 0
  Rx Errors            : 0
  Rx CRC Errors        : 0
  Rx Frame Errors      : 0
Upper Layers:
  Rx No Handler        : 0
  Rx No Message        : 0
  Rx Octets            : 975576
  Rx Unicast Pkts     : 4156
  Rx Multicast Pkts   : 203
  Tx Discards          : 0
  Tx Octets            : 2117992
  Tx Unicast Pkts     : 3789
  Tx Multicast Pkts   : 4073
Ethernet driver statistics - USB
Port Status: Link down
General:
  Transmit OK           : 0
  Receive OK           : 0
  Tx Errors             : 0
  Rx Errors            : 0
  Tx Octets            : 0
  Rx Octets            : 0

Ethernet driver statistics - 10/100 Ethernet
Type: 100BASET
Port Status: Link up
General:
  Transmit OK           : 7863
  Receive OK           : 4458
  Tx Errors             : 0
  Rx Errors            : 0
  Rx CRC Errors        : 0
  Rx Frame Errors      : 0
Upper Layers:
  Rx No Handler        : 0
  Rx No Message        : 0
  Rx Octets            : 976327
  Rx Unicast Pkts     : 4159
  Rx Multicast Pkts   : 204
  Tx Discards          : 0
```

[Link: Ports: DSL](#)

The DSL port selection shows the state of the DSL line, whether it is up or down and how many times the Gateway attempted to train. The state should indicate 'up' for a working configuration. If it is not, check the DSL cable and make sure it is plugged in correctly and not connected to a micro filter. Below is an example:

```
ADSL Line State:      Up
ADSL Startup Attempts: 5
ADSL Modulation:     DMT
Datapump Version:    3.22
                    Downstream  Upstream
                    -----  -----
SNR Margin:          18.6          14.0 dB
Line Attenuation:    0.4           4.0 dB
Errored Seconds:     14           3
Loss of Signal:      4             4
Loss of Frame:       0             0
CRC Errors:          0             0
Data Rate:           8000          800
```

[Link: IP: Interfaces](#)

The IP interfaces selection shows the state and configuration information for your IP LAN and WAN interfaces. Below is an example:

```
IP interfaces:
Ethernet 100BT: ( up broadcast default rip-send v1 rip-receive v1 )
    inet 192.168.1.1 netmask 255.255.255.0 broadcast 192.168.1.255
    physical address 00-16-cb-39-a9-78 mtu 1500

PPP over Ethernet vcc1: ( up address-mapping broadcast default admin-disabled
    rip-send v1 rip-receive v1 )
    inet 10.1.2.34 netmask 255.255.255.0 broadcast 10.1.2.1
    physical address 00-15-bc-28-b8-67 mtu 1500
```

[Link: DSL: Circuit Configuration](#)

The DSL Circuit Configuration screen shows the traffic sent and received over the DSL line as well as the trained rate (upstream and downstream) and the VPI/VCI. Verify traffic is being sent over the DSL line. If not, check the cabling and make sure the Gateway is not connected to a micro filter. Also verify the correct PVC is listed, which should be 0/35 (some providers use other values, such as 8/35. Check with your provider). If not go to the WAN setup and change the VPI/VCI to its correct value. Below is an example:

```
ATM port status      : Up
Rx data rate (bps)  : 8000
Tx data rate (bps)  : 800
ATM Virtual Circuits:

VCC #  Type  VPI  VCI  Encapsulation
-----  ---  ---  ---  -----
   1    PVC   8    35  PPP over Ethernet (LLC/SNAP encapsulation)

ATM Circuit Statistics:
Rx Frames      :      17092      Tx Frames      :      25078
Rx Octets      :     905876      Tx Octets      :     1329134
Rx Errors      :           0      Tx Errors      :           0
Rx Discards    :           0      Tx Discards    :           0
No Rx Buffers  :           0      Tx Queue Full  :           0
```

[Link: System Log: Entire](#)

The system log shows the state of the WAN connection as well as the PPPoE session. Verify that the PPPoE session has been correctly established and there are no failures. If there are error messages, go to the WAN configuration and verify the settings. The following is an *example* of a *successful connection*:

```

Message Log:
Mon Apr 16 10:48:22 2007 L3      KS: Using configured options found in flash
Mon Apr 16 10:48:22 2007 L3      BOOT: Warm start v7.3r0 -----
Mon Apr 16 10:48:22 2007 L3      IP address server initialization complete
Mon Apr 16 10:48:22 2007 L4      BR: Using saved configuration options
Mon Apr 16 10:48:22 2007 L4      BR: Netopia SOC OS version 7.3.0 (build r0)
Mon Apr 16 10:48:22 2007 L4      BR: Netopia-3000/9495032 (Netopia-3000, rev 1), PID 1205
Mon Apr 16 10:48:22 2007 L4      BR: last install status: Firmware installed successfully
Mon Apr 16 10:48:22 2007 L4      BR: memory sizes - 2048K Flash, 8192K RAM
Mon Apr 16 10:48:22 2007 L3      BR: Starting kernel
Mon Apr 16 10:48:22 2007 L3      AAL5: initializing service
Mon Apr 16 10:48:22 2007 L4      ATM: Waiting for PHY layer to come up
Mon Apr 16 10:48:22 2007 L3      POE: Initializing PPP over Ethernet service
Mon Apr 16 10:48:22 2007 L4      POE: Binding to Ethernet (ether/vccl)
Mon Apr 16 10:48:22 2007 L3      BRDG: Configuring port (10/100BT-LAN)
Mon Apr 16 10:48:22 2007 L3      BRDG: Bridge not enabled for WAN.
Mon Apr 16 10:48:22 2007 L3      BRDG: Bridging from one WAN port to another is disabled
Mon Apr 16 10:48:22 2007 L3      BRDG: Initialization complete
Mon Apr 16 10:48:22 2007 L4      IP: Routing between WAN ports is disabled
Mon Apr 16 10:48:22 2007 L4      IP: IPsec client pass through is enabled
Mon Apr 16 10:48:22 2007 L4      IP: Address mapping enabled on interface PPP over Ethernet vccl
Mon Apr 16 10:48:22 2007 L3      IP: Adding default gateway over PPP over Ethernet vccl
Mon Apr 16 10:48:22 2007 L3      IP: Initialization complete
Mon Apr 16 10:48:22 2007 L3      IPsec: initializing service
Mon Apr 16 10:48:22 2007 L3      IPsec: No feature key available - service disabled
Mon Apr 16 10:48:22 2007 L3      PPP: PPP over Ethernet vccl binding to PPPoE
Mon Apr 16 10:48:22 2007 L3      PPP: PPP over Ethernet vccl Port listening for incoming PPP connection requests
.
.
Mon Apr 16 10:48:22 2007 L4      RFC1483-1 up
Mon Apr 16 10:48:22 2007 L3      Service-Name=ANY
Mon Apr 16 10:48:22 2007 L3      Host-Uniq 00000001
Mon Apr 16 10:48:22 2007 L3      AC-Name=62011050058192-SMS1800
Mon Apr 16 10:48:22 2007 L3      Service-Name=ANY
Mon Apr 16 10:48:22 2007 L3      lcp: LCP Send Config-Request+
Mon Apr 16 10:48:22 2007 L3      MAGIC 0x2dee0000+
Mon Apr 16 10:48:22 2007 L3      lcp: LCP Recv Config-Req:+
Mon Apr 16 10:48:22 2007 L3      MRU(1492) (ACK) AUTHTYPE(c223) (CHAP) (ACK) MAGICNUMBER
Mon Apr 16 10:48:22 2007 L3      (4403604) (ACK)
Mon Apr 16 10:48:22 2007 L3      lcp: returning Configure-Ack
Mon Apr 16 10:48:22 2007 L3      chap: received challenge, id 1
Mon Apr 16 10:48:22 2007 L3      chap: received success, id 1
Mon Apr 16 10:48:22 2007 L3      ipcp: IPCP Config-Request+
Mon Apr 16 10:48:22 2007 L3      ADDR(0x0) DNS(0x0) DNS2(0x0) WINS(0x0) WINS2(0x0)
Mon Apr 16 10:48:22 2007 L3      ipcp: IPCP Recv Config-Req:+
Mon Apr 16 10:48:22 2007 L3      ADDR(143.137.199.254) (ACK)
Mon Apr 16 10:48:22 2007 L3      ipcp: returning Configure-ACK
Mon Apr 16 10:48:22 2007 L3      ipcp: IPCP Config-Request+
Mon Apr 16 10:48:22 2007 L3      ADDR(0x0) DNS(0x0) DNS2(0x0)
Mon Apr 16 10:48:22 2007 L3      ipcp: IPCP Config-Request+
Mon Apr 16 10:48:22 2007 L3      ADDR(0x8f89c702) DNS(0x8f89320a) DNS2(0x8f898909)
Mon Apr 16 10:48:22 2007 L3      ipcp: negotiated remote IP address 143.137.199.254
Mon Apr 16 10:48:22 2007 L3      ipcp: negotiated IP address 143.137.199.2
Mon Apr 16 10:48:22 2007 L3      ipcp: negotiated TCP hdr compression off
Mon Apr 16 10:48:22 2007 L3      NTP: Update system date & time
Mon Apr 16 10:50:02 L4      TS: "admin" logging in on serial port 0
Mon Apr 16 10:50:02 L4      TS: "Admin" completed login: Full Read/Write access
Mon Apr 16 10:50:02 L4      TS: "Admin" completed login: Full Read/Write access
    
```

[Link: Diagnostics](#)

The diagnostics section tests a number of different things at the same time, including the DSL line, the Ethernet interface and the PPPoE session.

```
==== Checking LAN Interfaces
Check Ethernet LAN connect                : PASS
Check IP connect to Ethernet (LAN)       : PASS
  Pinging Gateway                         : PASS
Check MAC-Bridge connect to Ethernet (LAN) : PASS
==== Checking DSL (WAN) Interfaces
Check DSL Synchronization                 : PASS
Check ATM Cell-Delineation               : PASS
  ATM OAM Segment Ping through (vccl)    : WARNING
    *** Don't worry, your service provider may not support this test
  ATM OAM End-To-End Ping through (vccl) : WARNING
    *** Don't worry, your service provider may not support this test
Check Ethernet connect to AAL5 (vccl)    : PASS
Check PPPOE connect to Ethernet (vccl)   : PASS
  Check PPP connect to PPPOE (vccl)      : PASS
  Check IP connect to PPP (vccl)         : PASS
  Pinging Gateway                         : PASS
==== Checking Miscellaneous
Check DNS- Query for netopia.com         : SKIPPED
Ping DNS Server Primary IP Address       : SKIPPED
TEST DONE
```

The following table summarizes the possible results.

CODE	Description
PASS	The test was successful.
FAIL	The test was unsuccessful.
SKIPPED	The test was skipped because a test on which it depended failed, or it was not supported by the service provider equipment to which it is connected, or it does not apply.
PENDING	The test timed out without producing a result. Try running the test again.
WARNING	The test was unsuccessful. The Service Provider equipment your Gateway connects to may not support this test.

[Link: Network Tools](#)

Three test tools are available from this page.

- **NSLookup** - converts a domain name to its IP address and vice versa.
- **Ping** - tests the “reachability” of a particular network destination by sending an ICMP echo request and waiting for a reply.
- **TraceRoute** - displays the path to a destination by showing the number of hops and the router addresses of these hops.

Network Test Tools

Enter a host name (such as netopia.com) or an IP address, then click on an option below.

NS Lookup: Converts a host name into IP address or vice versa.
Ping: Sends a ping message to an Internet Host.
TraceRoute: Traces the path to an Internet Host.

Network Host

Host:

1. To use the NSLookup capability, type an address (domain name or IP address) in the text box and click the [NSLookup](#) button

Example: Show the IP Address for *grosso.com*.

Server :	controller2.netopia.com
Address :	143.137.137.9
Name :	www.grosso.com
Address :	192.150.14.120

Result: The DNS Server doing the lookup is displayed in the **Server:** and **Address:** fields. If the Name Server can find your entry in its table, it is displayed in the **Name:** and **Address:** fields.

PING: The network tools section sends a PING from the Gateway to either the LAN or WAN to verify connectivity. A PING could be either an IP address (163.176.4.32) or Domain Name (www.netopia.com).

2. To use the Ping capability, type a destination address (domain name or IP address) in the text box and click the [Ping](#) button.

Example: Ping to *grosso.com*.

```
ping www.grosso.com

Pinging 192.150.14.120 from local address 143.137.199.8 (timer gran. 100 ms)...
    Ping size: 100 Ping count: 5
ICMP echo reply from 192.150.14.120, 200 ms
ICMP echo reply from 192.150.14.120, 100 ms
No ping response.
ICMP echo reply from 192.150.14.120, 100 ms
ICMP echo reply from 192.150.14.120, 100 ms

--- 192.150.14.120 ping statistics ---
5 packets transmitted, 4 packets received, 20% packet loss
```

Result: The host was reachable with four out of five packets sent.

Below are some specific tests:

Action	If PING is not successful, possible causes are:
From the Gateway's Network Tools page:	
Ping the internet default gateway IP address	DSL is down, DSL or ATM settings are incorrect; Gateway's IP address or subnet mask are wrong; gateway router is down.
Ping an internet site by IP address	Gateway's default gateway is incorrect, Gateway's subnet mask is incorrect, site is down.
Ping an internet site by name	DNS is not properly configured on the Gateway; configured DNS servers are down; site is down.
From a LAN PC:	
Ping the Gateway's LAN IP address	IP address and subnet mask of PC are not on the same scheme as the Gateway; cabling or other connectivity issue.
Ping the Gateway's WAN IP address	Default gateway on PC is incorrect.
Ping the Gateway's internet default gateway IP address	NAT is off on the Gateway and the internal IP addresses are private.
Ping an internet site by IP address	PC's subnet mask may be incorrect, site is down.
Ping an internet site by name	DNS is not properly configured on the PC, configured DNS servers are down, site is down.

- To use the TraceRoute capability, type a destination address (domain name or IP address) in the text box and click the [TraceRoute](#) button.**

Example: Show the path to the grosso.com site.

```
traceroute www.grosso.com

Traceroute to 192.150.14.120 from address 143.137.199.8 (timer gran. 100 ms)...
  30 hops max, 56 byte packets
 1 143.137.199.254 100 ms 100 ms 0 ms
 2 143.137.50.254 100 ms 0 ms 0 ms
 3 143.137.137.254 100 ms 0 ms 100 ms
 4 141.154.96.161 0 ms 0 ms 100 ms
 5 141.154.8.13 0 ms 100 ms 0 ms
 6 4.24.92.97 0 ms 100 ms 0 ms
 7 4.24.4.225 100 ms 0 ms 100 ms
 8 4.24.7.121 0 ms 0 ms 100 ms
 9 4.24.7.113 0 ms 100 ms 0 ms
10 4.24.6.50 100 ms 0 ms 100 ms
11 4.24.10.86 0 ms 100 ms 100 ms
12 4.24.6.234 0 ms 100 ms 0 ms
13 192.205.32.153 100 ms 0 ms 100 ms
14 12.123.1.122 100 ms 0 ms 100 ms
15 12.122.2.173 100 ms 100 ms 100 ms
16 12.122.2.153 100 ms 100 ms 100 ms
17 12.122.5.149 100 ms 200 ms 100 ms
18 12.123.12.189 100 ms 100 ms 200 ms
19 12.124.32.34 100 ms 100 ms 200 ms
20 192.150.14.120 100 ms ! 100 ms ! 100 ms !
```

Result: It took 20 hops to get to the grosso.com web site.

CHAPTER 6 *Command Line Interface*

The Motorola Netopia® Gateway operating software includes a command line interface (CLI) that lets you access your Motorola Netopia® Gateway over a telnet connection. You can use the command line interface to enter and update the unit's configuration settings, monitor its performance, and restart it.

This chapter covers the following topics:

- “Overview” on page 224
- “Starting and Ending a CLI Session” on page 226
- “Using the CLI Help Facility” on page 226
- “About SHELL Commands” on page 227
- “SHELL Commands” on page 228
- “About CONFIG Commands” on page 240
- “CONFIG Commands” on page 243

CONFIG Commands

[“Remote ATA Configuration Commands” on page 243](#)

[“DSL Commands” on page 245](#)

[“Bridging Settings” on page 246](#)

[“DHCP Settings” on page 248](#)

[“DMT Settings” on page 254](#)

[“Domain Name System Settings” on page 255](#)

[“IGMP Settings” on page 257](#)

[“IP Settings” on page 259](#)

[“Queue Configuration” on page 271](#)

[“IPMaps Settings” on page 277](#)

[“Network Address Translation \(NAT\) Default Settings” on page 278](#)

[“Network Address Translation \(NAT\) Pinhole Settings” on page 278](#)

[“PPPoE /PPPoA Settings” on page 279](#)

[“SNMP Settings” on page 297](#)

[“PPPoE with IPoE Settings” on page 282](#)

[“Ethernet Port Settings” on page 283](#)

[“802.3ah Ethernet OAM Settings” on page 284](#)

[“Command Line Interface Preference Settings” on page 285](#)

[“Port Renumbering Settings” on page 286](#)

[“Security Settings” on page 287](#)

[“System Settings” on page 298](#)

[“Syslog” on page 301](#)

[“Wireless Settings \(supported models\)” on page 303](#)

[“VLAN Settings” on page 311](#)

[“VoIP settings” on page 316](#)

[“UPnP settings” on page 321](#)

[“DSL Forum settings” on page 321](#)

[“Backup IP Gateway Settings” on page 323](#)

Overview

The CLI has two major command modes: **SHELL** and **CONFIG**. **Summary tables** that list the commands are provided below. Details of the entire command set follow in this section.

SHELL Commands	
Command	Status and/or Description
arp	to send ARP request
atmping	to send ATM OAM loopback
clear	to erase all stored configuration information
clear_certificate	to remove an SSL certificate that has been installed
clear_log	to erase all stored log info in flash memory
configure	to configure unit's options
diagnose	to run self-test
download	to download config file
etheroam	to show Ethernet OAM info
exit	to quit this shell
help	to get more: "help all" or "help help"
install	to download and program an image into flash
license	to enter an upgrade key to add a feature
log	to add a message to the diagnostic log
loglevel	to report or change diagnostic log level
netstat	to show IP information
nslookup	to send DNS query for host
ping	to send ICMP Echo request
quit	to quit this shell
reset	to reset subsystems
restart	to restart unit
show	to show system information
start	to start subsystem
status	to show basic status of unit
telnet	to telnet to a remote host
traceroute	to send traceroute probes
upload	to upload config file
view	to show configuration information
voip	to show VoIP info
who	to show who is using the shell

CONFIG Commands	
Command Verbs	Status and/or Description
delete	Delete configuration list data
help	Help command option
save	Save configuration data
script	Print configuration data
set	Set configuration data
validate	Validate configuration settings
view	View configuration data
Keywords	
ata	ATA remote config options
atm	ATM options (DSL only)
backup	Backup gateway options
bridge	Bridge options
dhcp	Dynamic Host Configuration Protocol options
dmt	DMT ADSL options
diffserv	Differentiated Services options
dns	Domain Name System options
dslf-cpewan	TR-069 CPE WAN management
dslf-lanmngt	TR-064 LAN management
dynamic-dns	Dynamic DNS client options
ethernet	Ethernet options
ethernet-MAC-override	Ethernet options
igmp	IGMP configuration options
ip	TCP/IP protocol options
ip-maps	IPmaps options
nat-default	Network Address Translation default options
pinhole	Pinhole options
ppp	Peer-to-Peer Protocol options
wan-over-ether	PPP over Ethernet options
preferences	Shell environment settings
queue	bandwidth queueing options
radius	RADIUS Server options
security	Security options
servers	Internal Server options
snmp	SNMP management options
system	Gateway's system options
upnp	UPnP options
vdsl	VDSL tuning options
vlan	VLAN options
wireless	Wireless LAN options
Command Utilities	
top	Go to top level of configuration mode
quit	Exit from configuration mode; return to shell mode
exit	Exit from configuration mode; return to shell mode

Starting and Ending a CLI Session

Open a telnet connection from a workstation on your network.

You initiate a telnet connection by issuing the following command from an IP host that supports telnet, for example, a personal computer running a telnet application such as NCSA Telnet.

```
telnet <ip_address>
```

You must know the IP address of the Motorola Netopia® Gateway before you can make a telnet connection to it. By default, your Motorola Netopia® Gateway uses 192.168.1.254 as the IP address for its LAN interface. You can use a Web browser to configure the Motorola Netopia® Gateway IP address.

Logging In

The command line interface log-in process emulates the log-in process for a UNIX host. To logon, enter the username (either admin or user), and your password.

- Entering the administrator password lets you display and update all Motorola Netopia® Gateway settings.
- Entering a user password lets you display (but not update) Motorola Netopia® Gateway settings.

When you have logged in successfully, the command line interface lists the username and the security level associated with the password you entered in the diagnostic log.

Ending a CLI Session

You end a command line interface session by typing **quit** from the SHELL node of the command line interface hierarchy.

Saving Settings

In CONFIG mode, the **save** command saves the working copy of the settings to the Gateway. The Gateway automatically validates its settings when you save and displays a warning message if the configuration is not correct.

Using the CLI Help Facility

The **help** command lets you display on-line help for SHELL and CONFIG commands. To display a list of the commands available to you from your current location within the command line interface hierarchy, enter **help**.

To obtain help for a specific CLI command, type **help <command>**. You can truncate the **help** command to **h** or a question mark when you request help for a CLI command.

About SHELL Commands

You begin in SHELL mode when you start a CLI session. SHELL mode lets you perform the following tasks with your Motorola Netopia® Gateway:

- Monitor its performance
- Display and reset Gateway statistics
- Issue administrative commands to restart Motorola Netopia® Gateway functions

SHELL Prompt

When you are in SHELL mode, the CLI prompt is the name of the Motorola Netopia® Gateway followed by a right angle bracket (>). For example, if you open a CLI connection to the Motorola Netopia® Gateway named “Netopia-3000/9437188,” you would see **Netopia-3000/9437188>** as your CLI prompt.

SHELL Command Shortcuts

You can **truncate** most commands in the CLI to their shortest unique string. For example, you can use the truncated command **q** in place of the full **quit** command to exit the CLI. However, you would need to enter **rese** for the **reset** command, since the first characters of **reset** are common to the **restart** command.

The only commands you cannot truncate are **restart** and **clear**. To prevent accidental interruption of communications, you must enter the **restart** and **clear** commands in their entirety.

You can use the Up and Down arrow keys to scroll backward and forward through recent commands you have entered. Alternatively, you can use the **!!** command to repeat the last command you entered.

SHELL Commands

Common Commands

arp *nnn.nnn.nnn.nnn*

Sends an Address Resolution Protocol (ARP) request to match the *nnn.nnn.nnn.nnn* IP address to an Ethernet hardware address.

clear [yes]

Clears the configuration settings in a Motorola Netopia® Gateway. If you do not use the optional **yes** qualifier, you are prompted to confirm the **clear** command.

clear_certificate

Removes an SSL certificate that has been installed.

clear_log

Erases the log information stored in flash if persistent logging is enabled.

configure

Puts the command line interface into Configure mode, which lets you configure your Motorola Netopia® Gateway with Config commands. Config commands are described starting on [page 225](#).

diagnose

Runs a diagnostic utility to conduct a series of internal checks and loopback tests to verify network connectivity over each interface on your Motorola Netopia® Gateway. The console displays the results of each test as the diagnostic utility runs. If one test is dependent on another, the diagnostic utility indents its entry in the console window. For example, the diagnostic utility indents the Check IP connect to Ethernet (LAN) entry, since that test will not run if the Check Ethernet LAN Connect test fails.

Each test generates one of the following result codes:

CODE	Description
PASS	The test was successful.
FAIL	The test was unsuccessful.
SKIPPED	The test was skipped because a test on which it depended failed, or because the test did not apply to your particular setup or model.
PENDING	The test timed out without producing a result. Try running the test again.

download [*server_address*] [*filename*] [*confirm*]

This command installs a file of configuration parameters into the Motorola Netopia® Gateway from a TFTP (Trivial File Transfer Protocol) server. The TFTP server must be accessible on your Ethernet network.

You can include one or more of the following arguments with the download command. If you omit arguments, the console prompts you for this information.

- The *server_address* argument identifies the IP address of the TFTP server from which you want to copy the Motorola Netopia® Gateway configuration file.
- The *filename* argument identifies the path and name of the configuration file on the TFTP server.
- If you include the optional **confirm** keyword, the download begins as soon as all information is entered.

You can also download an SSL certificate file from a trusted Certification Authority (CA), on platforms that support SSL, as follows:

download [-cert] [*server_address*] [*filename*] [confirm]

install [*server_address*] [*filename*] [confirm]

(Not supported on model 3342/3352)

Downloads a new version of the Motorola Netopia® Gateway operating software from a TFTP (Trivial File Transfer Protocol) server, validates the software image, and programs the image into the Motorola Netopia® Gateway memory. After you install new operating software, you must restart the Motorola Netopia® Gateway.

The *server_address* argument identifies the IP address of the TFTP server on which your Motorola Netopia® Gateway operating software is stored. The *filename* argument identifies the path and name of the operating software file on the TFTP server.

If you include the optional keyword *confirm*, you will not be prompted to confirm whether or not you want to perform the operation.

license [key]

This command installs a software upgrade key. An upgrade key is a purchased item, based on the serial number of the gateway.

log message_string

Adds the message in the *message_string* argument to the Motorola Netopia® Gateway diagnostic log.

loglevel [*level*]

Displays or modifies the types of log messages you want the Motorola Netopia® Gateway to record. If you enter the **loglevel** command without the optional *level* argument, the command line interface displays the current log level setting.

You can enter the **loglevel** command with the *level* argument to specify the types of diagnostic messages you want to record. All messages with a level number equal to or greater than the level you specify are recorded. For example, if you specify loglevel 3, the diagnostic log will retain high-level informational messages (level 3), warnings (level 4), and failure messages (level 5).

Use the following values for the *level* argument:

- **1** or **low** – Low-level informational messages or greater; includes trivial status messages.
- **2** or **medium** – Medium-level informational messages or greater; includes status messages that can help monitor network traffic.
- **3** or **high** – High-level informational messages or greater; includes status messages that may be significant but do not constitute errors.
- **4** or **warning** – Warnings or greater; includes recoverable error conditions and useful operator information.
- **5** or **failure** – Failures; includes messages describing error conditions that may not be recoverable.

netstat -i

Displays the IP interfaces for your Motorola Netopia® Gateway.

netstat -r

Displays the IP routes stored in your Motorola Netopia® Gateway.

nslookup { *hostname* | *ip_address* }

Performs a domain name system lookup for a specified host.

- The *hostname* argument is the name of the host for which you want DNS information; for example, **nslookup klaatu**.
- The *ip_address* argument is the IP address, in dotted decimal notation, of the device for which you want DNS information.

ping [-s *size*] [-c *count*]{ *hostname* | *ip_address* }

Causes the Motorola Netopia® Gateway to issue a series of ICMP Echo requests for the device with the specified name or IP address.

- The *hostname* argument is the name of the device you want to ping; for example, **ping ftp.netopia.com**.
- The *ip_address* argument is the IP address, in dotted decimal notation, of the device you want to locate. If a host using the specified name or IP address is active, it returns one or more ICMP Echo replies, confirming that it is accessible from your network.
- The **-s** *size* argument lets you specify the size of the ICMP packet.
- The **-c** *count* argument lets you specify the number of ICMP packets generated for the ping request. Values greater than 250 are truncated to 250.

You can use the **ping** command to determine whether a hostname or IP address is already in use on your network. You cannot use the **ping** command to ping the Motorola Netopia® Gateway's own IP address.

quit

Exits the Motorola Netopia® Gateway command line interface.

reset arp

Clears the Address Resolution Protocol (ARP) cache on your unit.

reset atm

Resets the Asynchronous Transfer Mode (ATM) statistics.

reset cdmode

This command will set up one boot flag so that the next time a 3342N/3352N restarts or reboots (power cycle), the Gateway will boot into CD-ROM mode instead of Gateway mode.

This command is only for the 3342N/3352N. If the Gateway is not a 3342N/3352N this command does nothing but returns the message: "CD mode is not supported on this platform."

reset crash

Clears crash-dump information, which identifies the contents of the Motorola Netopia® Gateway registers at the point of system malfunction.

reset dhcp server

Clears the DHCP lease table in the Motorola Netopia® Gateway.

reset diffserv

Resets the Differentiated Services (diffserv) statistics.

reset enet [all]

Resets Ethernet statistics to zero. Resets individual LAN switch port statistics as well as wireless and WAN Ethernet statistics (where applicable).

reset heartbeat

Restarts the heartbeat sequence.

reset ipmap

Clears the IPMap table (NAT).

reset log

Rewinds the diagnostic log display to the top of the existing Motorola Netopia® Gateway diagnostic log. The **reset log** command does not clear the diagnostic log. The next **show log** command will display information from the beginning of the log file.

reset security-log

Clears the security monitoring log to make room to capture new entries.

reset wan-users [all | *ip-address*]

This function disconnects the specified WAN User to allow for other users to access the WAN. This function is only available if the number of WAN Users is restricted and NAT is on. Use the **all** parameter to disconnect all users. If you logon as Admin you can disconnect any or all users. If you logon as User, you can only disconnect yourself.

reset wan

This function resets WAN interface statistics.

reset wepkeys

This function allows you to force your wireless WEP key settings back to the default values, if there are default values. For example, on some models, the WEP keys are based on the serial number. This allows you to get back those default settings if you have changed them without the need to reset the entire configuration of the unit.

restart [*seconds*]

Restarts your Motorola Netopia® Gateway. If you include the optional *seconds* argument, your Motorola Netopia® Gateway will restart when the specified number of seconds have elapsed. You must enter the complete **restart** command to initiate a restart.

show all-info

Displays all settings currently configured in the Motorola Netopia® Gateway.

show backup

Displays the status of the Backup port, Up or Down, and reports the current port in use.

show bridge interfaces

Displays bridge interfaces maintained by the Motorola Netopia® Gateway.

show bridge table

Displays the bridging table maintained by the Motorola Netopia® Gateway.

show config

Dumps the Motorola Netopia® Gateway's configuration script just as the **script** command does in config mode.

show crash

Displays the most recent crash information, if any, for your Motorola Netopia® Gateway.

show dhcp agent

Displays DHCP relay-agent leases.

show dhcp server leases

Displays the DHCP leases stored in RAM by your Motorola Netopia® Gateway.

show diffserv

Displays the Differentiated Services and QoS values configured in the Motorola Netopia® Gateway.

show dslf device-association

Displays LAN devices that conform with the TR111 Gateway requirement. It displays - IP Address, Manufacture OUI and Serial number.

show enet [all]

Displays Ethernet interface statistics maintained by the Motorola Netopia® Gateway. Beginning with Firmware Version 7.7, supports display of individual LAN switch port statistics as well as WAN Ethernet statistics (where applicable).

Example:

```
show enet status all
10/100 Ethernet 1

Port Status: Link down
Transmit OK           : 0
Transmit unicastpkts : 0
Receive OK           : 0
Receive unicastpkts  : 0
Tx Octets            : 0
Rx Octets            : 0

10/100 Ethernet 2

Port Status: Link down
Transmit OK           : 0
Transmit unicastpkts : 0
Receive OK           : 0
Receive unicastpkts  : 0
Tx Octets            : 0
Rx Octets            : 0
```

10/100 Ethernet 3

Port Status: Link up
Duplex: Full-duplex not active
Speed: 100BASE-X
Transmit OK : 3309
Transmit unicastpkts : 31
Receive OK : 5588
Receive unicastpkts : 1976
Tx Octets : 31
Rx Octets : 1976

10/100 Ethernet 4

Port Status: Link down
Transmit OK : 0
Transmit unicastpkts : 0
Receive OK : 0
Receive unicastpkts : 0
Tx Octets : 0
Rx Octets : 0

show etheroam ah

Displays OAM internal information, such as OAM mode, state, configurations, events and OAM statistics.

show features

Displays standard and keyed features installed in the Motorola Netopia® Gateway.

show group-mgmt

Displays the IGMP Snooping Table. See [“IGMP \(Internet Group Management Protocol\)” on page 100](#) for detailed explanation.

show ip arp

Displays the Ethernet address resolution table stored in your Motorola Netopia® Gateway.

show ip igmp

Displays the contents of the IGMP Group Address table and the IGMP Report table maintained by your Motorola Netopia® Gateway.

show ip interfaces

Displays the IP interfaces for your Motorola Netopia® Gateway.

show ip ipsec

Displays IPSec Tunnel statistics.

show ip firewall

Displays firewall statistics.

show ip lan-discovery

Displays the LAN Host Discovery Table of hosts on the wired or wireless LAN, and whether or not they are currently online.

show ip routes

Displays the IP routes stored in your Motorola Netopia® Gateway.

show ip state-insp

Displays whether stateful inspection is enabled on an interface or not, exposed addresses and blocked packet statistics because of stateful inspection.

show ipmap

Displays IPMap table (NAT).

show log

Displays blocks of information from the Motorola Netopia® Gateway diagnostic log. To see the entire log, you can repeat the **show log** command or you can enter **show log all**.

show memory [all]

Displays memory usage information for your Motorola Netopia® Gateway. If you include the optional **all** argument, your Motorola Netopia® Gateway will display a more detailed set of memory statistics.

show pppoe

Displays status information for each PPPoE socket, such as the socket state, service names, and host ID values.

show rtsp

Displays RTSP ALG session activity data.

show security-log

Displays blocks of information from the Motorola Netopia® Gateway security log.

show status

Displays the current status of a Motorola Netopia® Gateway, the device's hardware and software revision levels, a summary of errors encountered, and the length of time the Motorola Netopia® Gateway has been running since it was last restarted. Identical to the **status** command.

show summary

Displays a summary of WAN, LAN, and Gateway information.

show vlan

Displays detail of VLAN status and statistics.

Example:

```
show vlan

Displaying vlan segment interfaces
==== vlan mode ====
==== segment 0 port masks ====
PortPort   : 00000000-00000000
GlobalPort : 00000000-00000000
SumPort    : 00000000-00000000
==== segment 1 port masks ====
PortPort   : 00001006-00000001
GlobalPort : 00000000-00000000
SumPort    : 00001006-00000001
==== segment 2 port masks ====
PortPort   : 0000003c-00000000
GlobalPort : 00000000-00000000
SumPort    : 0000003c-00000000
==== segment 3 port masks ====
PortPort   : 00000000-00000000
GlobalPort : 00000000-00000000
SumPort    : 00000000-00000000
==== segment 4 port masks ====
PortPort   : 00000000-00000000
GlobalPort : 00000000-00000000
SumPort    : 00000000-00000000
==== segment 5 port masks ====
PortPort   : 00000000-00000000
GlobalPort : 00000000-00000000
SumPort    : 00000000-00000000
==== segment 6 port masks ====
PortPort   : 00000000-00000000
GlobalPort : 00000000-00000000
SumPort    : 00000000-00000000
==== segment 7 port masks ====
PortPort   : 00000000-00000000
GlobalPort : 00000000-00000000
```

```
SumPort      : 00000000-00000000
==== segment 8 port masks ====
PortPort     : 00000000-00000000
GlobalPort   : 00000000-00000000
SumPort      : 00000000-00000000
==== segment 9 port masks ====
PortPort     : 00000000-00000000
GlobalPort   : 00000000-00000000
SumPort      : 00000000-00000000
==== segment 10 port masks ====
PortPort     : 00000000-00000000
GlobalPort   : 00000000-00000000
SumPort      : 00000000-00000000
==== vlan active segment ====
Type : 1
Index : 1
Vid : 1
PortMask      : 00001006-00000001
SwitchMask    : 00000004
WirelessMask  : 00001000
==== vlan active link ====
namePtr       : eth-lan-uplink
portType      : 1
portIndex     : 1
ifId          : 45
==== vlan active link ====
namePtr       : ethernet0/0
portType      : 3
portIndex     : 2
ifId          : 46
==== vlan active link ====
namePtr       : ssid1
portType      : 5
portIndex     : 12
ifId          : 56
==== vlan active link ====
namePtr       : eth-ip0
portType      : 7
portIndex     : 32
ifId          : 76
==== vlan active segment ====
Type : 1
Index : 2
Vid : 3
PortMask      : 0000003c-00000000
SwitchMask    : 0000003c
WirelessMask  : 00000000
==== vlan active link ====
namePtr       : ethernet0/0
portType      : 3
portIndex     : 2
ifId          : 90
```

```
==== vlan active link ====
namePtr   : ethernet0/1
portType  : 3
portIndex : 3
ifId      : 91
==== vlan active link ====
namePtr   : ethernet0/2
portType  : 3
portIndex : 4
ifId      : 92
==== vlan active link ====
namePtr   : ethernet0/3
portType  : 3
portIndex : 5
ifId      : 93
```

show wireless [all]

Shows wireless status and statistics.

show wireless clients [MAC_address]

Displays details on connected clients, or more details on a particular client if the MAC address is added as an argument.

telnet { hostname | ip_address } [port]

Lets you open a telnet connection to the specified host through your Motorola Netopia® Gateway.

- The *hostname* argument is the name of the device to which you want to connect; for example, **telnet ftp.netopia.com**.
- The *ip_address* argument is the IP address, in dotted decimal notation, of the device to which you want to connect.
- The *port* argument is the number of the port over which you want to open a telnet session.

traceroute (ip_address | hostname)

Traces the routing path to an IP destination.

upload [server_address] [filename] [confirm]

Copies the current configuration settings of the Motorola Netopia® Gateway to a TFTP (Trivial File Transfer Protocol) server. The TFTP server must be accessible on your Ethernet network. The *server_address* argument identifies the IP address of the TFTP server on which you want to store the Motorola Netopia® Gateway settings. The *filename* argument identifies the path and name of the configuration file on the TFTP server. If you include the optional **confirm** keyword, you will not be prompted to confirm whether or not you want to perform the operation.

view config

Dumps the Motorola Netopia® Gateway's configuration just as the **view** command does in config mode.

who

Displays the names of the current shell and PPP users.

WAN Commands

atmping vccn [*segment* | *end-to-end*]

Lets you check the ATM connection reachability and network connectivity. This command sends five Operations, Administration, and Maintenance (OAM) loopback calls to the specified vpi/vci destination. There is a five second total timeout interval.

Use the **segment** argument to ping a neighbor switch.
Use the **end-to-end** argument to ping a remote end node.

reset dhcp client release [*vcc-id*]

Releases the DHCP lease the Motorola Netopia® Gateway is currently using to acquire the IP settings for the specified DSL port. The **vcc-id** identifier is an “index” letter in the range B-I, and does not directly map to the VCC in use. Enter the **reset dhcp client release** command without the variable to see the letter assigned to each virtual circuit.

reset dhcp client renew [*vcc-id*]

Releases the DHCP lease the Motorola Netopia® Gateway is currently using to acquire the IP settings for the specified DSL port. The **vcc-id** identifier is an “index” letter in the range B-I, and does not directly map to the VCC in use. Enter the **reset dhcp client release** without the variable to see the letter assigned to each virtual circuit.

reset dsl

Resets any open DSL connection.

reset ppp vccn

Resets the point-to-point connection over the specified virtual circuit. This command only applies to virtual circuits that use PPP framing.

show atm [all]

Displays ATM statistics for the Motorola Netopia® Gateway. The optional **all** argument displays a more detailed set of ATM statistics.

show dsl [all]

Displays DSL port statistics, such as upstream and downstream connection rates and noise levels.

show ppp [{ stats | lcp | ipcp }]

Displays information about open PPP links. You can display a subset of the PPP statistics by including an optional **stats**, **lcp**, or **ipcp** argument for the **show ppp** command.

start ppp vccn

Opens a PPP link on the specified virtual circuit.

About CONFIG Commands

You reach the configuration mode of the command line interface by typing **configure** (or any truncation of **configure**, such as **con** or **config**) at the CLI SHELL prompt.

CONFIG Mode Prompt

When you are in CONFIG mode, the CLI prompt consists of the name of the Motorola Netopia® Gateway followed by your current **node** in the hierarchy and two right angle brackets (>>). For example, when you enter CONFIG mode (by typing **config** at the SHELL prompt), the **Netopia-3000/9437188 (top)>>** prompt reminds you that you are at the top of the CONFIG hierarchy. If you move to the **ip** node in the CONFIG hierarchy (by typing **ip** at the CONFIG prompt), the prompt changes to **Netopia-3000/9437188 (ip)>>** to identify your current location.

Some CLI commands are not available until certain conditions are met. For example, you must enable IP for an interface before you can enter IP settings for that interface.

Navigating the CONFIG Hierarchy

- **Moving from CONFIG to SHELL** — You can navigate from anywhere in the CONFIG hierarchy back to the SHELL level by entering **quit** at the CONFIG prompt and pressing RETURN.

```
Netopia-3000/9437188 (top)>> quit
Netopia-3000/9437188 >
```

- **Moving from top to a subnode** — You can navigate from the top node to a subnode by entering the node name (or the significant letters of the node name) at the CONFIG prompt and pressing RETURN. For example, you move to the IP subnode by entering **ip** and pressing RETURN.

```
Netopia-3000/9437188 (top)>> ip
Netopia-3000/9437188 (ip)>>
```

As a shortcut, you can enter the significant letters of the node name in place of the full node name at the CONFIG prompt. The significant characters of a node name are the letters that uniquely identify the node. For example, since no other CONFIG node starts with **b**, you could enter one letter ("**b**") to move to the bridge node.

- **Jumping down several nodes at once** — You can jump down several levels in the CONFIG hierarchy by entering the complete path to a node.
- **Moving up one node** — You can move up through the CONFIG hierarchy one node at a time by entering the **up** command.

- **Jumping to the top node** — You can jump to the top level from anywhere in the CONFIG hierarchy by entering the **top** command.
- **Moving from one subnode to another** — You can move from one subnode to another by entering a partial path that identifies how far back to climb.
- **Moving from any subnode to any other subnode** — You can move from any subnode to any other subnode by entering a partial path that starts with a top-level CONFIG command.
- **Scrolling backward and forward through recent commands** — You can use the Up and Down arrow keys to scroll backward and forward through recent commands you have entered. When the command you want appears, press Enter to execute it.

Entering Commands in CONFIG Mode

CONFIG commands consist of keywords and arguments. Keywords in a CONFIG command specify the action you want to take or the entity on which you want to act. Arguments in a CONFIG command specify the values appropriate to your site. For example, the CONFIG command

set ip ethernet A *ip_address*

consists of two keywords (*ip*, and *ethernet A*) and one argument (*ip_address*). When you use the command to configure your Gateway, you would replace the argument with a value appropriate to your site.

For example:

```
set ip ethernet A 192.31.222.57
```

Guidelines: CONFIG Commands

The following table provides guidelines for entering and formatting CONFIG commands.

Command component	Rules for entering CONFIG commands
Command verbs	CONFIG commands must start with a command verb (set, view, delete). You can truncate CONFIG verbs to three characters (set, vie, del). CONFIG verbs are case-insensitive. You can enter "SET," "Set," or "set."
Keywords	Keywords are case-insensitive. You can enter "Ethernet," "ETHERNET," or "ethernet" as a keyword without changing its meaning. Keywords can be abbreviated to the length that they are differentiated from other keywords.
Argument Text	Text strings can be as many as 64 characters long, unless otherwise specified. In some cases they may be as long as 255 bytes. Special characters are represented using backslash notation. Text strings may be enclosed in double (") or single (') quote marks. If the text string includes an embedded space, it must be enclosed in quotes. Special characters are represented using backslash notation.
Numbers	Enter numbers as integers, or in hexadecimal, where so noted.
IP addresses	Enter IP addresses in dotted decimal notation (0 to 255).

If a command is ambiguous or miskeyed, the CLI prompts you to enter additional information. For example, you must specify which virtual circuit you are configuring when you are setting up a Motorola Netopia® Gateway.

Displaying Current Gateway Settings

You can use the **view** command to display the current CONFIG settings for your Motorola Netopia® Gateway. If you enter the **view** command at the top level of the CONFIG hierarchy, the CLI displays the settings for all enabled functions. If you enter the **view** command at an intermediate node, you see settings for that node and its subnodes.

Step Mode: A CLI Configuration Technique

The Motorola Netopia® Gateway command line interface includes a step mode to automate the process of entering configuration settings. When you use the CONFIG step mode, the command line interface prompts you for all required and optional information. You can then enter the configuration values appropriate for your site without having to enter complete CLI commands.

When you are in step mode, the command line interface prompts you to enter required and optional settings. If a setting has a default value or a current setting, the command line interface displays the default value for the command in parentheses. If a command has a limited number of acceptable values, those values are presented in brackets, with each value separated by a vertical line. For example, the following CLI step command indicates that the default value is **off** and that valid entries are limited to **on** and **off**.

```
option (off) [ on | off] : ON
```

You can accept the default value for a field by pressing the Return key. To use a different value, enter it and press Return.

You can enter the CONFIG step mode by entering **set** from the top node of the CONFIG hierarchy. You can enter step mode for a particular service by entering **set service_name**. In stepping set mode (press Control-X <Return/Enter> to exit. For example:

```
Netopia-3000/9437188 (top)>> set system
...
system
  name ("Netopia-3000/9437188"): Mycroft
  Diagnostic Level (High): medium
Stepping mode ended.
```

Validating Your Configuration

You can use the **validate** CONFIG command to make sure that your configuration settings have been entered correctly. If you use the **validate** command, the Motorola Netopia® Gateway verifies that all required settings for all services are present and that settings are consistent.

```
Netopia-3000/9437188 (top)>> validate
Error: Subnet mask is incorrect
Global Validation did not pass inspection!
```

You can use the **validate** command to verify your configuration settings at any time. Your Motorola Netopia® Gateway automatically validates your configuration any time you save a modified configuration.

CONFIG Commands

This section describes the keywords and arguments for the various CONFIG commands.

Remote ATA Configuration Commands

Motorola Netopia® firmware supports configuration of a maximum of four Motorola Netopia® ATA profiles, which are stored in the Gateway's configuration database. When a Motorola Netopia® ATA is discovered, the Gateway compares the MAC address of the ATA with one of the existing profiles stored in the database. If there is a match, the configuration is downloaded to the Motorola Netopia® ATA, and the ATA is restarted. Once the Motorola Netopia® ATA is restarted, it comes up with the newly downloaded configuration.

set ata profile [0... 3] ata-option [on | off]

Enables or disables the remote ATA configuration option for the specified ATA configuration profile to be stored in the Gateway.

set ata profile [0... 3] ata-mac-addr *MAC_addr*

Specifies the MAC address of the ATA for the specified configuration profile.

set ata profile [0... 3] ata-qos-enable [on | off]

Enables or disables QoS for the specified profile.

set ata profile [0... 3] ata-dhcp-enable [on | off]

Enables or disables DHCP client service for the specified profile.

set ata profile [0... 3] ata-dhcp-hostname *string*

Specifies a DHCP client hostname for the specified profile.

set ata profile [0... 3] ata-dhcp-vid-enable [off | on]

Enables or disables a DHCP client vendor ID for the specified profile.

set ata profile [0... 3] ata-dhcp-vid *string*

Specifies a vendor ID for the specified profile when **ata-dhcp-vid-enable** is **on**.

set ata profile [0... 3] ata-static-wan-ip *ip_addr*

Specifies a static WAN IP address for the specified profile.

set ata profile [0... 3] ata-static-wan-subnet-mask *subnet_mask*

Specifies a static WAN IP subnet mask for the specified profile.

set ata profile [0... 3] ata-static-wan-gateway *ip_addr*

Specifies a static gateway WAN IP address for the specified profile.

set ata profile [0... 3] ata-proxy-server *ip_addr*

Specifies a SIP proxy server hostname or IP address for the specified profile.

set ata profile [0... 3] ata-proxy-port *port*

Specifies a SIP proxy server port, typically 5060, for the specified profile.

set ata profile [0... 3] ata-registrar-server *ip_addr*

Specifies a registrar server hostname or IP address for the specified profile.

set ata profile [0... 3] ata-registrar-port *port*

Specifies a registrar server port, typically 5060, for the specified profile.

set ata profile [0... 3] ata-outproxy-server *ip_addr*

Specifies an outbound proxy server hostname or IP address for the specified profile.

set ata profile [0... 3] ata-outproxy-port *port*

Specifies an outbound proxy server port, typically 5060, for the specified profile.

set ata profile [0... 3] ata-auth-id *value*

Specifies an authorization ID for the specified profile.

set ata profile [0... 3] ata-user-name *string*

Specifies the ISP-supplied user name for the specified profile.

set ata profile [0... 3] ata-user-display-name *string*

Specifies the a user “display” or “screen” name for the specified profile.

set ata profile [0... 3] ata-user-password *string*

Specifies the user password for the specified profile.

DSL Commands

ATM Settings. You can use the CLI to set up each ATM virtual circuit.

set atm option {on | off }

Enables the WAN interface of the Motorola Netopia® Gateway to be configured using the Asynchronous Transfer Mode (ATM) protocol.

set atm [vcc *n*] option {on | off }

Selects the virtual circuit for which further parameters are set. Up to eight VCCs are supported; the maximum number is dependent on your Motorola Netopia® Operating System tier and the capabilities that your Service Provider offers.

set atm [vcc *n*] qos service-class { cbr | ubr | vbr }

Sets the Quality of Service class for the specified virtual circuit – Constant (**cbr**), Unspecified (**ubr**), or Variable (**vbr**) Bit Rate.

- **ubr**: No configuration is needed for UBR VCs. Leave the default value 0 (maximum line rate).
- **cbr**: One parameter is required for CBR VCs. Enter the **Peak Cell Rate** that applies to the VC. This value should be between 1 and the line rate. You set this value according to specifications defined by your service provider.
- **vbr**: Three parameters are required for VBR VCs. Enter the **Peak Cell Rate**, the **Sustained Cell Rate**, and the **Maximum Burst Size** that apply to the VC. You set these values according to specifications defined by your service provider.

set atm [vcc *n*] qos peak-cell-rate { 1 ...*n* }

If QoS class is set to **cbr** or **vbr** then specify the **peak-cell-rate** that should apply to the specified virtual circuit. This value should be between 1 and the line rate.

The Peak Cell Rate (PCR) should be set to the maximum rate a PVC can oversubscribe its Sustained Cell Rate (SCR). The Peak Cell Rate (see below) must be less than, or equal to the raw WAN (DSL) bit rate. The Maximum Burst Size (MBS) is the number of cells that can be sent at the PCR rate, after which the PVC must fall back to the SCR rate.

set atm [vcc *n*] qos sustained-cell-rate { 1 ...*n* }

If QoS class is set to **vbr**, then specify the **sustained-cell-rate** that should apply to the specified virtual circuit. This value should be less than, or equal to the Peak Cell Rate, which should be less than, or equal to the line rate.

set atm [vcc *n*] qos max-burst-size { 1 ...*n* }

If QoS class is set to **vbr** then specify the **max-burst-size** that should apply to the specified virtual circuit. This value is the maximum number of cells that can be transmitted at the Peak Cell Rate after which the ATM VC transmission rate must drop to the Sustained Cell Rate.

set atm [vcc n] vpi { 0 ... 255 }

Select the virtual path identifier (vpi) for VCC n.

Your Service Provider will indicate the required vpi number.

set atm [vcc n] vci { 0 ... 65535 }

Select the virtual channel identifier (vci) for VCC n. Your Service Provider will indicate the required vci number.

set atm [vccn] encap { ppp-vcmux | ppp-llc | ether-llc | ip-llc | ppoe-vcmux | ppoe-llc }

Select the encapsulation mode for VCC n. The options are:

ppp-vcmux	PPP over ATM, VC-muxed
ppp-llc	PPP over ATM, LLC-SNAP
ether-llc	RFC-1483, bridged Ethernet, LLC-SNAP
ip-llc	RFC-1483, routed IP, LLC-SNAP
pppoe-vcmux	PPP over Ethernet, VC-muxed
pppoe-llc	PPP over Ethernet, LLC-SNAP

Your Service Provider will indicate the required encapsulation mode.

set atm [vccn] ppoe-sessions { 1 ... 8 }

Select the number of PPPoE sessions to be configured for VCC 1, up to a total of eight. The total number of **pppoe-sessions** and PPPoE VCCs configured must be less than or equal to eight.

Bridging Settings

Bridging lets the Motorola Netopia® Gateway use MAC (Ethernet hardware) addresses to forward non-TCP/IP traffic from one network to another. When bridging is enabled, the Motorola Netopia® Gateway maintains a table of up to 512 MAC addresses. Entries that are not used within 30 seconds are dropped. If the bridging table fills up, the oldest table entries are dropped to make room for new entries.

Virtual circuits that use IP framing cannot be bridged.



NOTE:

For bridging in the 3341 (or any model with a USB port), you cannot set the **bridge option off**, or **bridge ethernet option off**; these are on by default because of the USB port.

Common Commands

set bridge sys-bridge {on | off }

Enables or disables bridging services in the Motorola Netopia® Gateway. You must enable bridging services within the Motorola Netopia® Gateway before you can enable bridging for a specific interface.

set bridge concurrent-bridging-routing {on | off }

Enables or disables Concurrent Bridging/Routing.

set bridge dhcp-filterset " *string* "

Assigns a filterset named *string* to the bridge configuration.



NOTE:

A filterset can only be configured for the bridge if the system bridge or concurrent bridging/routing is enabled.

set bridge ethernet option { on | off }

Enables or disables bridging services for the specified virtual circuit using Ethernet framing.

set bridge dsl vccn option { on | off }

Enables or disables bridging services for the specified interface. Specified interface must be part of a VLAN if bridge is turned **on**. Only RFC-1483 Bridged encapsulation is supported currently.

- **show log** command will show that WAN Bridge is enabled when at least one WAN interface is bridged.
 - **show ip interfaces** and **show bridge interfaces** commands will show the interfaces that are not in bridged mode and that are in bridged modes, respectively.
-

set bridge table-timeout [30 ... 6000]

Sets the timeout value for bridging table timeout. Default = 30 secs; range = 30 secs – 6000 secs (.5–100 mins).

DHCP Settings

As a Dynamic Host Control Protocol (DHCP) server, your Motorola Netopia® Gateway can assign IP addresses and provide configuration information to other devices on your network dynamically. A device that acquires its IP address and other TCP/IP configuration settings from the Motorola Netopia® Gateway can use the information for a fixed period of time (called the DHCP lease).

Common Commands

set dhcp option { off | server | relay-agent }

Enables or disables DHCP services in the Motorola Netopia® Gateway. You must enable DHCP services before you can enter other DHCP settings for the Motorola Netopia® Gateway.

If you turn off DHCP services and save the new configuration, the Motorola Netopia® Gateway clears its DHCP settings.

set dhcp start-address *ip_address*

If you selected **server**, specifies the first address in the DHCP address range. The Motorola Netopia® Gateway can reserve a sequence of up to 253 IP addresses within a subnet, beginning with the specified address for dynamic assignment.

set dhcp end-address *ip_address*

If you selected **server**, specifies the last address in the DHCP address range.

set dhcp lease-time *lease-time*

If you selected **server**, specifies the default length for DHCP leases issued by the Motorola Netopia® Gateway. Enter lease time in **dd:hh:mm:ss** (day/hour/minute/second) format.

set dhcp option-group *name*

Specifies a name for one of up to eight DHCP Option Groups. Each Option Group can have a name of between 1 and 15 characters. The name is used in the DHCP filterset syntax to choose what group of gen-options is to be served to a particular DHCP Client. See [“DHCP Generic Options” on page 249](#) and [“DHCP Option Filtering” on page 252](#).

Option Groups refer to *gen-options*; they do not contain them. Deleting a gen-option from an option group does not delete the option. Adding a gen-option to an option-group does not preclude it from being added to another option-group.

set dhcp default-option-group *name*

Sets the option group specified by *name* as the default.

set dhcp server-address *ip_address*

If you selected **relay-agent**, specifies the IP address of the relay agent server.

set dhcp range [2... 8] start-address *ip_address*

Specifies the starting IP address of DHCP range *n* when **subnet *n* option** is **on**. See [“Additional subnets” on page 262](#).

set dhcp range [2... 8] end-address *ip_address*

Specifies the ending IP address of DHCP range *n* when **subnet *n* option** is **on**. See [“Additional subnets” on page 262](#).

set dhcp reserved ip-address *x.x.x.x* mac-address *y-y-y-y-y*

If you selected **server**, reserves the specified IP address from the DHCP pool to the specified MAC address. These are list items; a total of 16 reserved addresses are supported. Secondary ranges will all make use of the **dhcp lease-time** value.

DHCP Generic Options

Beginning with Firmware Version 7.7.2, you can specify DHCP Generic Options which allow you to configure the content to be served for particular option numbers.

set dhcp gen-option name *name*

Specifies a DHCP generic option set named *name* of one to 15 characters. You can specify up to 20 **gen-options**. Each can contain up to 100 bytes of data, up to a maximum of 912 bytes of options data total. An option will be served only if the client requests it.

set dhcp gen-option option [1 – 255]

Specifies the DHCP option by number, 1 – 255. The following table shows the formats and sizes for known options, and whether or not you can configure a **gen-option** of that type.

Option	Data Format	Data Size (bytes)	Can Configure
0	Empty	0	No
1	IP mask	4	Yes
2	Unsigned 4 byte integer	4	Yes
3 - 11	IP address list	Multiples of 4	Yes
12	String (up to 100 characters)	N	Yes
13	Unsigned 2 byte integer	2	Yes
14 - 15	String (up to 100 characters)	N	Yes
16	Unsigned 4 byte integer	4	Yes
17	String (up to 100 characters)	N	Yes
18	String (up to 100 characters)	N	Yes
19 - 20	Flag	1	Yes
21	IP address & mask list	Multiples of 8	Yes
22	Unsigned 2 byte integer	2	Yes

Option	Data Format	Data Size (bytes)	Can Configure
23	Unsigned 1 byte integer	1	Yes
24	Unsigned 4 byte integer	4	Yes
25	Unsigned 2 byte integer list	Multiples of 2	Yes
26	Unsigned 2 byte integer	2	Yes
27	Flag	1	Yes
28	IP address	4	Yes
29 - 31	Flag	1	Yes
32	IP address	4	Yes
33	IP address and mask list	Multiples of 8	Yes
34	Flag	1	Yes
35	Unsigned 4 byte integer	4	Yes
36	Flag	1	Yes
37	Unsigned 1 byte integer	1	Yes
38	Unsigned 4 byte integer	4	Yes
39	Flag	1	Yes
40	String (up to 100 characters)	N	Yes
41 - 42	IP address list	Multiples of 4	Yes
43	Vendor-specific	String	Yes
44 - 45	IP address list	Multiples of 4	Yes
46	Unsigned 1 byte integer	1	Yes
47	String (up to 100 characters)	N	Yes
48 - 49	IP address list	Multiples of 4	Yes
50	IP address	4	No
51	Unsigned 4 byte integer	4	No
52	Unsigned 1 byte integer	1	No
53	Unsigned 1 byte integer	1	Yes
54	IP address	4	Yes
55	String (up to 100 characters)	N	No
56	String (up to 100 characters)	N	Yes
57	Unsigned 2 byte integer	2	Yes
58 - 59	Unsigned 4 byte integer	4	No
60	String (up to 100 characters)	N	Yes
61	String (up to 100 characters)	N	No
62	String (up to 100 characters)	N	Yes
63	Complex	N	No
64	String (up to 100 characters)	N	Yes
65	IP address list	Multiples of 4	Yes
66 - 67	String (up to 100 characters)	N	Yes
68 - 76	IP address list	Multiples of 4	Yes

Option	Data Format	Data Size (bytes)	Can Configure
77	Pascal string list (length byte + data)	N	Yes
78 - 79	Complex	N	No
80	Empty	0	No
81	Complex	N	No
82	Sub-option list	N	Yes
83	Complex	N	No
84	Undefined	??	Yes
85	IP address list	Multiples of 4	Yes
86 - 87	Unicode String	Multiples of 2	Yes
88	Encoded DN list	N	Yes
89	IP address list	Multiples of 4	Yes
90	Complex	N	No
91 - 97	Undefined/Weakly defined	??	Yes
98	String (up to 100 characters)	N	Yes
99 - 115	Undefined/Weakly defined	??	Yes
116	Flag	1	Yes
117	Unsigned 2 byte integer list	Multiples of 2	Yes
118	IP address	4	Yes
119	Encoded DN list 2	N	Yes
120	Encoded DN list or IPAddress list	N	Yes
121 - 125	Complex	N	No
126 - 127	Undefined	N	Yes
128	IP address list	Multiples of 4	Yes
129 - 223	Undefined/Weakly defined	??	Yes
224 - 254	Private Use	N	Yes
249 (note)	Microsoft uses this instead of 121	N	Yes
255	Empty	0	No

set dhcp gen-option data-type [ascii | hex | dotted-decimal]

Specifies the DHCP gen-option data type: **ascii**, **hex** or **dotted-decimal**.

set dhcp gen-option data *data*

Specifies the **gen-option** data.

- If the **data-type** is **ascii**, then any printable character + octal representations (e.g. "\0007") and hex representations (e.g. "\xA4").
- If the **data-type** is **hex**, then an even number of hex characters (e.g. "0123456789AbcdEf")
- If the **data-type** is **dotted-decimal**, then a series of numbers between 0 and 255, separated by a period (.). IP addresses are generally represented in this form.

DHCP Option Filtering

Beginning with Firmware Version 7.7, support for DHCP option filtering is provided via the filterset settings.

```
set dhcp filterset name " string" rule n type [ dhcp-option | hw-address | requested-option ]
```

Specifies a DHCP filterset named *string* as one of three possible types:

The rule can either specify an option and option contents, **dhcp-option**; a client hardware address range, **hw-address**; or an option the client is requesting, **requested-option**. For **hw-address**, you will need to enter **start-address** and **end-address** values; for the others a **dhcp-option** parameter must be set.

By default a rule is of type **dhcp-option**, for backwards compatibility.

```
set dhcp filterset name " string" rule n dhcp-option [ 0... 255 ]
```

Creates a DHCP filterset named ***string***, for example "settopbox," with rule number *n*.

Up to two filtersets can be added. Your Gateway supports a single LAN DHCP server instance, but an additional filterset is available for use when bridging, to block undesired DHCP traffic. Up to **8 rules** can be created in the filterset, which are evaluated in order.

dhcp-option determines which DHCP option should be compared. A typical value would be to use option 60 data for comparison, but allowing this value to be configured permits more flexibility.

```
set dhcp filterset name "settopbox" rule 1 type dhcp-option
```

```
set dhcp filterset name " string" rule n match-action [ pass | discard | continue ]
```

Assigns a match action to the filterset. If set to **pass** the **match-pool** address is shown.

```
set dhcp filterset name " string" rule n absent-action [ pass | discard | continue ]
```

Assigns an absent action to the filterset. If set to **pass** the **absent-pool** address is hidden.

```
set dhcp filterset name " string" rule n match-option-group " option_group"
```

Assigns the option group named ***option_group*** to match.

```
set dhcp filterset name " string" rule n match-str " match_string"
```

Assigns a match string to the filterset. The **match-str** string will be compared against the DHCP DISCOVER option data. This string can contain multiple "*" and "?" wildcard substitutions.

set dhcp filterset name "*string*" rule *n* match-pool *ip_address*

Specifies the start IP address of the range within a DHCP pool where that range will be used to allocate an address if the wildcard matches.

The value 0.0.0.0 means regular processing; 255.255.255.255 means discard.

set dhcp filterset name "*string*" rule *n* absent-pool *ip_address*

Specifies the start IP address of the range within a DHCP pool where that range will be used to allocate an address if the option in the DHCP packet is not present.

The value 0.0.0.0 means regular processing; 255.255.255.255 means discard.

Example

```
Netopia-3000/9450000 (dhcp)>> sc
set dhcp option server
set dhcp start-address 192.168.1.33
set dhcp end-address 192.168.1.63
set dhcp lease-time 01:00:00:00
set dhcp filterset name "settopbox" rule 1 dhcp-option 60
set dhcp filterset name "settopbox" rule 1 match-str "STB*"
set dhcp filterset name "settopbox" rule 1 match-pool 192.168.6.100
set dhcp filterset name "settopbox" rule 1 absent-pool 0.0.0.0
Netopia-3000/9450000 (dhcp)>>
```

set dhcp assigned-filterset "*string*"

Assigns the filterset named ***string*** created above to the DHCP configuration.

DMT Settings

DSL Commands

set dmt dsl-annex-support [off | on]

This controls whether other annex support (just as Annex M) is enabled. Default is **off**.

set dmt type [lite | dmt | ansi | multi | adsl2 | adsl2+ | reads12 | adsl2anxm | adsl2+anxm]

Selects the type of Discrete Multitone (DMT) asynchronous digital subscriber line (ADSL) protocol to use for the WAN interface.

The **type** value also supports the following settings on certain model units: **adsl2**, **adsl2+**, **reads12**, **adsl2anxm**, **adsl2+anxm**.



NOTE:

Some **dmt type** settings are now supported for many Annex B (335xN) platforms. 2200 Series and 33xxN Series models are supported. Currently, **adsl2anxm** and **adsl2+anxm** are not supported in Annex B.

set dmt autoConfig [off | on]

Enables support for automatic VPI/VCI detection and configuration. When set to **on** (the default), a pre-defined list of VPI/VCI pairs are searched to find a valid configuration for your ADSL line. Entering a value for the VPI or VCI setting will disable this feature.

set dmt dmt dying-gasp [default | off | on]

Enables or disables Gateway “dying gasp” behavior in cases of power failure. Default is **off**.

set dmt wiringMode [auto | tip_ring | A_A1]

(not supported on all models) This command configures the wiring mode setting for your ADSL line. Selecting **auto** (the default) causes the Gateway to detect which pair of wires (inner or outer pair) are in use on your phone line. Specifying **tip_ring** forces the inner pair to be used; and **A_A1** the outer pair.

set dmt metallic-termination [auto | disabled | always_on]

(not supported on all models) This command allows you to apply a sealing current to “dry” DSL lines so that the wiring doesn’t corrode.

- **auto** - The device will scan for standard telephone service (POTS). If it finds POTS, it disables metallic termination. If it does not find POTS during the search period, then metallic termination is enabled.
- **disabled** - There is no POTS detection, and metallic termination is disabled.
- **always_on** - The device will scan for POTS for information only. Metallic termination is always enabled.

Domain Name System Settings

Domain Name System (DNS) is an information service for TCP/IP networks that uses a hierarchical naming system to identify network domains and the hosts associated with them. You can identify a primary DNS server and one secondary server.

Common Commands

set dns domain-name *domain-name*

Specifies the default domain name for your network. When an application needs to resolve a host name, it appends the default domain name to the host name and asks the DNS server if it has an address for the “fully qualified host name.”

set dns primary-address *ip_address*

Specifies the IP address of the primary DNS name server.

set dns proxy-enable

This allows you to disable the default behavior of acting as a DNS proxy. The default is **on**.

set dns secondary-address *ip_address*

Specifies the IP address of the secondary DNS name server. Enter **0.0.0.0** if your network does not have a secondary DNS name server.

set dns configured-dns-priority [0 - 255]

Sets the configured DNS priority relative to acquired DNS. These server addresses may be acquired via DHCP (client), PPP, or statically configured. A “DNS learned-server-priority” is assigned to each configured interface. By default, configured DNSes have the highest priority (lowest number), then PPP-acquired DNSes, and DHCP-acquired DNSes have lowest priority (highest number).

The default priorities for each type are:

- Configured DNSes: 10
- PPP-acquired: 20
- DHCP-acquired: 30

Dynamic DNS Settings

Dynamic DNS support allows you to use the free services of *www.dyndns.org*. Dynamic DNS automatically directs any public Internet request for your computer's name to your current dynamically-assigned IP address. This allows you to get to the IP address assigned to your Gateway, even though your actual IP address may change as a result of a PPPoE connection to the Internet.

```
set dynamic-dns option [ off | dyndns.org ]  
set dynamic-dns ddns-host-name myhostname.dyndns.org  
set dynamic-dns ddns-user-name myusername  
set dynamic-dns ddns-user-password myuserpassword
```

Enables or disables dynamic DNS services. The default is **off**. If you specify **dyndns.org**, you must supply your hostname, username for the service, and password.

Because different dynamic DNS vendors use different proprietary protocols, currently only *www.dyndns.org* is supported.

IGMP Settings

NOTE: IGMP Version 3 is supported beginning with Firmware Version 7.7.

See [“IGMP \(Internet Group Management Protocol\)” on page 100](#) for detailed explanation.

You can set the following options:

- **IGMP Snooping** – enables the Motorola Netopia® Gateway to “listen in” to IGMP traffic. The Gateway discovers multicast group membership for the purpose of restricting multicast transmissions to only those ports which have requested them. This helps to reduce overall network traffic from streaming media and other bandwidth-intensive IP multicast applications.
- **Robustness** – a way of indicating how sensitive to lost packets the network is. IGMP can recover from robustness minus 1 lost IGMP packet. The default value is 2.
- **Query Interval**– the amount of time in seconds between IGMP General Query messages sent by the querier gateway. The default query interval is 125 seconds.
- **Query Response Interval** – the maximum amount of time in tenths of a second that the IGMP router waits to receive a response to a General Query message. The default query response interval is 10 seconds and must be less than the query interval.
- **Unsolicited Report Interval** – the amount of time in seconds between repetitions of a particular computer’s initial report of membership in a group. The default unsolicited report interval is 10 seconds.
- **Querier Version** – select a version of the IGMP Querier: version **1**, version **2**, or version **3**. If you know you will be communicating with other hosts that are limited to v1 or v2, for backward compatibility, select accordingly; otherwise, allow the default v3.



NOTE:

IGMP Querier version is relevant only if the router is configured for IGMP forwarding. If any IGMP v1 routers are present on the subnet, the querier **must** use IGMP v1. The use of IGMP v1 must be administratively configured, since there is no reliable way of dynamically determining whether IGMP v1 routers are present on a network. IGMP forwarding is enabled per IP Profile and WAN Connection Profile.

-
- **Last Member Query Interval** – the amount of time in tenths of a second that the IGMP gateway waits to receive a response to a Group-Specific Query message. The last member query interval is also the amount of time in seconds between successive Group-Specific Query messages. The default last member query interval is 1 second (10 deci-seconds).
 - **Last Member Query Count** – the number of Group-Specific Query messages sent before the gateway assumes that there are no members of the host group being queried on this interface. The default last member query count is 2.
 - **Fast Leave** – set to **off** by default, fast leave enables a non-standard expedited leave mechanism. The querier keeps track of which client is requesting which channel by IP address. When a leave message is received, the querier can check its internal table to see if there are any more clients on this group. If there are none, it immediately sends an IGMP leave message to the upstream querier.
 - **Log Enable** – If set to on, all IGMP messages on both the LAN and the WAN will be logged.
 - **Wireless Multicast to Unicast conversion** – Only available if **IGMP Snooping** is enabled. If set to **on**, the Gateway replaces the multicast MAC-address with the physical MAC-address of the wireless client. If there is more than one wireless client interested in the same multicast group, the router will revert to multicasting the stream immediately. When one or more wireless clients leave a group, and the router

determines that only a single wireless client is interested in the stream, it will once again unicast the stream.

set igmp snooping [off | on]

Enables IGMP Snooping.

set igmp robustness *value*

Sets IGMP robustness range: from 2 – 255. The default is 2.

set igmp query-intvl *value*

Sets the query-interval range: from 10 seconds – 600 seconds, The default is 125 seconds.

set igmp query-response-intvl *value*

Sets the query-response interval range: from 5 deci-seconds (tenths of a second) – 255 deci-seconds. The default is 100 deci-seconds.

set igmp unsol-report-intvl *value*

Sets the unsolicited report interval: the amount of time in seconds between repetitions of a particular computer's initial report of membership in a group. The default is 10 seconds.

set igmp version [1 | 2 | 3]

Sets the IGMP querier version: version **1**, version **2**, or version **3**. If you know you will be communicating with other hosts that are limited to v1, for backward compatibility, select **1**; otherwise, allow the default **3**.

set igmp last-member-query-intvl *value*

Sets the last member query interval: the amount of time in tenths of a second that the IGMP gateway waits to receive a response to a Group-Specific Query message. The last member query interval is also the amount of time in seconds between successive Group-Specific Query messages. The default is 1 second (10 deci-seconds).

set igmp last-member-query-count *value*

Sets the last member query count: the number of Group-Specific Query messages sent before the gateway assumes that there are no members of the host group being queried on this interface. The default is 2.

set igmp fast-leave [off | on]

Sets fast leave on or off. Set to **off** by default, fast leave enables a non-standard expedited leave mechanism. The querier keeps track of which client is requesting which channel by IP address. When a leave message is received, the querier can check its internal table to see if there are any more clients on this group. If there are none, it immediately sends an IGMP leave message to the upstream querier.

set igmp wireless-m2u [on | off]

This command allows you enable or disable wireless multicast-to-unicast if **igmp snooping** is set to **on**.

set igmp log-enable [on | off]

If set to **on**, all IGMP messages on both the LAN and the WAN will be logged. Default is **off**.

IP Settings

You can use the command line interface to specify whether TCP/IP is enabled, identify a default Gateway, and to enter TCP/IP settings for the Motorola Netopia® Gateway LAN and WAN ports.



NOTE:

For the DSL platform you must identify the virtual PPP interface [**vccn**], a number from 1 to 8.

Common Settings

set ip option { on | off }

Enables or disables TCP/IP services in the Motorola Netopia® Gateway. You must enable TCP/IP services before you can enter other TCP/IP settings for the Motorola Netopia® Gateway. If you turn off TCP/IP services and save the new configuration, the Motorola Netopia® Gateway clears its TCP/IP settings.

ARP Timeout Settings

set ip arp-timeout [60 ... 6000]

Sets the timeout value for ARP timeout. Default = 600 secs (10 mins); range = 60 secs - 6000 secs (1–100 mins).

DSL Settings

set ip dsl vccn address *ip_address*

Assigns an IP address to the virtual circuit. Enter 0.0.0.0 if you want the virtual circuit to obtain its IP address from a remote DHCP server.

set ip dsl vccn broadcast *broadcast_address*

Specifies the broadcast address for the TCP/IP network connected to the virtual circuit. IP hosts use the broadcast address to send messages to every host on your network simultaneously.

The broadcast address for most networks is the network number followed by 255. For example, the broadcast address for the 192.168.1.0 network would be 192.168.1.255.

set ip dsl vccn netmask *netmask*

Specifies the subnet mask for the TCP/IP network connected to the virtual circuit. The subnet mask specifies which bits of the 32-bit binary IP address represents network information. The default subnet mask for most networks is 255.255.255.0 (Class C subnet mask).

set ip dsl vccn restrictions { *admin-disabled* | *none* }

Specifies restrictions on the types of traffic the Motorola Netopia® Gateway accepts over the DSL virtual circuit. The **admin-disabled** argument means that access to the device via telnet, web, and SNMP is disabled. RIP and ICMP traffic is still accepted. The **none** argument means that all traffic is accepted.

set ip dsl vccn addr-mapping { *on* | *off* }

Specifies whether you want the Motorola Netopia® Gateway to use network address translation (NAT) when communicating with remote routers. Address mapping lets you conceal details of your network from remote routers. It also permits all LAN devices to share a single IP address. By default, address mapping is turned "On".

set ip dsl vccn auto-sensing [*off* | *dhcp/pppoe* | *pppoe/pppoa*]

Enables or disables DHCP/PPPoE or PPPoE/PPPoA autosensing on the specified interface. Setting this to **DHCP/PPPoE** enables automatic sensing of your WAN connection type: PPPoE or DHCP. The gateway attempts to connect using PPPoE first. If the Gateway fails to connect after 60 seconds, it switches to DHCP. As soon as it can connect via DHCP, the Gateway chooses and sets DHCP as its default. Otherwise, after attempting to connect via DHCP for 60 seconds, the Gateway switches back to PPPoE. The Gateway will continue to switch back and forth in this manner until it successfully connects. Similarly, selecting **PPPoE/PPPoA** causes the Gateway to attempt to connect by trying these protocols in parallel, and using the first one that is successful.

set ip dsl vccn mcast-fwd [*on* | *off*]

Enables or disables multi-cast forwarding on the specified interface. If set to **on**, this interface acts as an IGMP proxy host, and IGMP packets are transmitted and received on this interface on behalf of IGMP hosts on the LAN interface.

set ip dsl vccn igmp-null-source-addr { *on* | *off* }

Specifies whether you want the Motorola Netopia® Gateway to identify the source IP address of every IGMP packet transmitted from this interface as 0.0.0.0 when **mcast-fwd** is set to **on**. This complies with the requirements of TR-101, and removes the need for a publicly advertised IP address on the WAN interface.

set ip dsl vccn unnumbered [*on* | *off*]

Specifies whether you want the Motorola Netopia® Gateway to have its WAN interface unnumbered, i.e. set to 0. **unnumbered** option is only available if the address is set to 0 for the interface. Enables or disables unnumbered IP addressing (where an address of 0 is allowed AND the DHCP client is disabled) on the specified interface. This setting applies to native IP as well as PPP interfaces to support running an IPoE interface without an address.

set ip dsl vccn rip-send { off | v1 | v2 | v1-compat | v2-MD5 }

Specifies whether the Motorola Netopia® Gateway should use Routing Information Protocol (RIP) broadcasts to advertise its routing tables to other routers. RIP Version 2 (RIP-2) is an extension of the original Routing Information Protocol (RIP-1) that expands the amount of useful information in the RIP packets. While RIP-1 and RIP-2 share the same basic algorithms, RIP-2 supports several additional features, including inclusion of subnet masks in RIP packets and implementation of multicasting instead of broadcasting (which reduces the load on hosts which do not support routing protocols. RIP-2 with MD5 authentication is an extension of RIP-2 that increases security by requiring an authentication key when routes are advertised.

Depending on your network needs, you can configure your Motorola Netopia® Gateway to support RIP-1, RIP-2, or RIP-2MD5.

If you specify **v2-MD5**, you must also specify a **rip-send-key**. Keys are ASCII strings with a maximum of 31 characters, and must match the other router(s) keys for proper operation of MD5 support.

set ip dsl vccn rip-receive { off | v1 | v2 | v1-compat | v2-MD5 }

Specifies whether the Motorola Netopia® Gateway should use Routing Information Protocol (RIP) broadcasts to update its routing tables with information received from other routers.

If you specify **v2-MD5**, you must also specify a **rip-receive-key**. Keys are ASCII strings with a maximum of 31 characters, and must match the other router(s) keys for proper operation of MD5 support.

Ethernet LAN Settings

set ip ethernet A option { on | off }

Enables or disables communications through the designated Ethernet port in the Gateway. You must enable TCP/IP functions for an Ethernet port before you can configure its network settings.

set ip ethernet A address *ip_address*

Assigns an IP address to the Motorola Netopia® Gateway on the local area network. The IP address you assign to the local Ethernet interface must be unique on your network. By default, the Motorola Netopia® Gateway uses 192.168.1.254 as its LAN IP address.

set ip ethernet A broadcast *broadcast_address*

Specifies the broadcast address for the local Ethernet interface. IP hosts use the broadcast address to send messages to every host on your network simultaneously.

The broadcast address for most networks is the network number followed by 255. For example, the broadcast address for the 192.168.1.0 network would be 192.168.1.255.

set ip ethernet A netmask *netmask*

Specifies the subnet mask for the local Ethernet interface. The subnet mask specifies which bits of the 32-bit binary IP address represent network information. The default subnet mask for most networks is 255.255.255.0 (Class C subnet mask).

set ip ethernet A restrictions { none | admin-disabled }

Specifies whether an administrator can open a telnet connection to a Motorola Netopia® Gateway over an Ethernet interface (**A** = the LAN) to monitor and configure the unit.

The **admin-disabled** argument prevents access to the device via telnet, web, and SNMP.

By default, administrative restrictions are **none** on the LAN, but **admin-disabled** is set on the WAN. This means that, by default, an administrator can open, for example, a telnet connection from the LAN, but not the WAN.

set ip ethernet A rip-send { off | v1 | v2 | v1-compatible | v2-MD5 }

Specifies whether the Motorola Netopia® Gateway should use Routing Information Protocol (RIP) broadcasts to advertise its routing tables to other routers on your network. RIP Version 2 (RIP-2) is an extension of the original Routing Information Protocol (RIP-1) that expands the amount of useful information in the RIP packets. While RIP-1 and RIP-2 share the same basic algorithms, RIP-2 supports several additional features, including inclusion of subnet masks in RIP packets and implementation of multicasting instead of broadcasting (which reduces the load on hosts which do not support routing protocols). RIP-2 with MD5 authentication is an extension of RIP-2 that increases security by requiring an authentication key when routes are advertised.

If you specify **v2-MD5**, you must also specify a **rip-send-key**. Keys are ASCII strings with a maximum of 31 characters, and must match the other router(s) keys for proper operation of MD5 support.

Depending on your network needs, you can configure your Motorola Netopia® Gateway to support RIP-1, RIP-2, or RIP-2MD5.

set ip ethernet A rip-receive { off | v1 | v2 | v1-compatible | v2-MD5 }

Specifies whether the Motorola Netopia® Gateway should use Routing Information Protocol (RIP) broadcasts to update its routing tables with information received from other routers on your network.

If you specify **v2-MD5**, you must also specify a **rip-receive-key**. Keys are ASCII strings with a maximum of 31 characters, and must match the other router(s) keys for proper operation of MD5 support.

Additional subnets

See [“DHCP Settings” on page 248](#) for subnet range configuration commands.

set ip ethernet A subnet [2 ... 8] option [on | off]

Enables or disables additional LAN subnets. Up to seven additional subnets may be configured.

set ip ethernet A subnet *n* address *ip_address*

Specifies an IP address for the subnet *n*, when **subnet *n* option** is **on**.

set ip ethernet A subnet *n* netmask *netmask*

Specifies the subnet mask for the subnet *n*, when **subnet *n* option** is **on**.

Default IP Gateway Settings

set ip gateway option { on | off }

Specifies whether the Motorola Netopia® Gateway should send packets to a default Gateway if it does not know how to reach the destination host.

set ip gateway interface { *ip-address* | *ppp-vccn* }

Specifies how the Motorola Netopia® Gateway should route information to the default Gateway. If you select ***ip-address***, you must enter the IP address of a host on a local or remote network. If you specify ***ppp***, the Motorola Netopia® unit uses the default gateway being used by the remote PPP peer.

IP-over-PPP Settings. Use the following commands to configure settings for routing IP over a virtual PPP interface.



NOTE:

For a DSL platform you must identify the virtual PPP interface [***vccn***], a number from 1 to 8.

set ip ip-ppp [*vccn*] option { on | off }

Enables or disables IP routing through the virtual PPP interface. By default, IP routing is turned on. If you turn off IP routing and save the new configuration, the Motorola Netopia® Gateway clears IP routing settings

set ip ip-ppp [*vccn*] address *ip_address*

Assigns an IP address to the virtual PPP interface. If you specify an IP address other than 0.0.0.0, your Motorola Netopia® Gateway will not negotiate its IP address with the remote peer. If the remote peer does not accept the IP address specified in the *ip_address* argument as valid, the link will not come up.

The default value for the *ip_address* argument is 0.0.0.0, which indicates that the virtual PPP interface will use the IP address assigned to it by the remote peer. Note that the remote peer must be configured to supply an IP address to your Motorola Netopia® Gateway if you enter 0.0.0.0 for the *ip_address* argument.

set ip ip-ppp [vccn] peer-address ip_address

Specifies the IP address of the peer on the other end of the PPP link. If you specify an IP address other than 0.0.0.0, your Motorola Netopia® Gateway will not negotiate the remote peer's IP address. If the remote peer does not accept the address in the *ip_address* argument as its IP address (typically because it has been configured with another IP address), the link will not come up.

The default value for the *ip_address* argument is 0.0.0.0, which indicates that the virtual PPP interface will accept the IP address returned by the remote peer. If you enter 0.0.0.0, the peer system must be configured to supply this address.

set ip ip-ppp [vccn] restrictions { admin-disabled | none }

Specifies restrictions on the types of traffic the Motorola Netopia® Gateway accepts over the PPP virtual circuit. The **admin-disabled** argument means that access to the device via telnet, web, and SNMP is disabled. RIP and ICMP traffic is still accepted. The **none** argument means that all traffic is accepted.

set ip ip-ppp [vccn] addr-mapping [on | off]

Specifies whether you want the Motorola Netopia® Gateway to use network address translation (NAT) when communicating with remote routers. Address mapping lets you conceal details of your network from remote routers. It also permits all LAN devices to share a single IP address. By default, address mapping is turned "On".

set ip ip-ppp [vccn] auto-sensing [off | dhcp/pppoe | pppoe/pppoea]

Enables or disables DHCP/PPPoE or PPPoE/PPPoA autosensing on the specified interface. Setting this to **DHCP/PPPoE** enables automatic sensing of your WAN connection type: PPPoE or DHCP. The gateway attempts to connect using PPPoE first. If the Gateway fails to connect after 60 seconds, it switches to DHCP. As soon as it can connect via DHCP, the Gateway chooses and sets DHCP as its default. Otherwise, after attempting to connect via DHCP for 60 seconds, the Gateway switches back to PPPoE. The Gateway will continue to switch back and forth in this manner until it successfully connects. Similarly, selecting **PPPoE/PPPoA** causes the Gateway to attempt to connect by trying these protocols in parallel, and using the first one that is successful.

set ip ip-ppp [vccn] rip-send { off | v1 | v2 | v1-compatible | v2-MD5 }

Specifies whether the Motorola Netopia® Gateway unit should use Routing Information Protocol (RIP) broadcasts to advertise its routing tables to routers on the other side of the PPP link. An extension of the original Routing Information Protocol (RIP-1), RIP Version 2 (RIP-2) expands the amount of useful information in the packets. While RIP-1 and RIP-2 share the same basic algorithms, RIP-2 supports several new features. For example, inclusion of subnet masks in RIP packets and implementation of multicasting instead of broadcasting. This last feature reduces the load on hosts which do not support routing protocols. RIP-2 with MD5 authentication is an extension of RIP-2 that increases security by requiring an authentication key when routes are advertised.

This command is only available when address mapping for the specified virtual circuit is turned "off".

If you specify **v2-MD5**, you must also specify a **rip-send-key**. Keys are ASCII strings with a maximum of 31 characters, and must match the other router(s) keys for proper operation of MD5 support.

set ip ip-ppp [vccn] rip-receive { off | v1 | v2 | v1-compatible | v2-MD5 }

Specifies whether the Motorola Netopia® Gateway should use Routing Information Protocol (RIP) broadcasts to update its routing tables with information received from other routers on the other side of the PPP link.

If you specify **v2-MD5**, you must also specify a **rip-receive-key**. Keys are ASCII strings with a maximum of 31 characters, and must match the other router(s) keys for proper operation of MD5 support.

set ip ip-ppp vccn igmp-null-source-addr [on | off]

Specifies whether you want the Motorola Netopia® Gateway to identify the source IP address of every IGMP packet transmitted from this interface as 0.0.0.0 when **mcast-fwd** is set to **on**. This complies with the requirements of TR-101, and removes the need for a publicly advertised IP address on the WAN interface.

set ip ip-ppp vccn mcast-fwd [on | off]

Specifies whether you want the Motorola Netopia® Gateway interface to act as an IGMP proxy host.

set ip ip-ppp vccn unnumbered [on | off]

Specifies whether you want the Motorola Netopia® Gateway to have its WAN interface unnumbered, i.e. set to 0.

set ip ip-ppp vccn dns acquired-dns-priority [0 - 255]

Sets the priority for DNS acquired via PPP. See [“Domain Name System Settings” on page 255](#) for more information.

Static ARP Settings

Your Motorola Netopia® Gateway maintains a dynamic Address Resolution Protocol (ARP) table to map IP addresses to Ethernet (MAC) addresses. Your Motorola Netopia® Gateway populates this ARP table dynamically, by retrieving IP address/MAC address pairs only when it needs them. Optionally, you can define static ARP entries to map IP addresses to their corresponding Ethernet MAC addresses. Unlike dynamic ARP table entries, static ARP table entries do not time out.

You can configure as many as 16 static ARP table entries for a Motorola Netopia® Gateway. Use the following commands to add static ARP entries to the Motorola Netopia® Gateway static ARP table:

set ip static-arp ip-address ip_address

Specifies the IP address for the static ARP entry. Enter an IP address in the *ip_address* argument in dotted decimal format. The *ip_address* argument cannot be 0.0.0.0.

set ip static-arp ip-address ip_address hardware-address MAC_address

Specifies the Ethernet hardware address for the static ARP entry. Enter an Ethernet hardware address in the *MAC_address* argument in **nn.nn.nn.nn.nn.nn** (hexadecimal) format.

IGMP Forwarding

set ip igmp-forwarding [off | on]

Turns IP IGMP forwarding off or on. The default is off.

IPsec Passthrough

set ip ipsec-passthrough [off | on]

Turns IPsec client passthrough off or on. The default is on.

IP Prioritization

set ip prioritize [off | on]

Allows you to support traffic that has the TOS bit set. This defaults to **off**.

Differentiated Services (DiffServ)

set diffserv option [off | on]

Turns the DiffServ option **off** (default) or **on**. **on** enables the service and IP TOS bits are used, even if no flows are defined. Consequently, if the end-point nodes provide TOS settings from an application that can be interpreted as one of the supported states, the Gateway will handle it as if it actively marked the TOS field itself.



NOTE:

The Gateway itself will not override TOS bit settings made by the endpoints. Support for source-provided IP TOS priorities within the Gateway is achieved simply by turning the Diff-Serve option “on” and by setting the lohi-asymmetry to adjust the behavior of the Gateway’s internal queues.

set diffserv lohi-ratio [60 - 100 percent]

Sets a percentage between 60 and 100 used to regulate the level of packets allowed to be pending in the low priority queue. The default is 92. It can be used in some degree to adjust the relative throughput bandwidth for low- versus high-priority traffic.



NOTE:

diffserv lohi-ratio has been removed for VDSL, ADSL bonded units.

```

set diffserv custom-flows name name
  protocol [ TCP | UDP | ICMP | other ]
  direction [ outbound | inbound | both ]
  start-port [ 0 - 65535 ]
  end-port [ 0 - 65535 ]
  inside-ip inside-ip-addr
  inside-ip-mask inside-ip-netmask
  outside-ip outside-ip-addr
  outside-ip-mask outside-ip-netmask
  qos [ off | assure | expedite | network-control ]
  
```

Defines or edits a custom flow. Select a **name** for the custom-flow from the **set** command. The CLI will step into the newly-named or previously-defined flow for editing.

- **protocol** – Allows you to choose the IP protocol for the stream: **TCP**, **UDP**, **ICMP**, or **other**. **other** is appropriate for setting up flows on protocols with non-standard port definitions, for example, IPSEC or PPTP. If you select **other**, an additional field, **numbered-protocol** will appear with a range of 0–255. Choose the protocol number from this field.
- **direction** – Allows you to choose whether to apply the marking and gateway queue behavior for inbound packets, outbound packets, or to both. If the Gateway is used as an “edge” gateway, its more important function is to mark the packets for high-priority streams in the outbound direction.
- **start-port/end-port** – Allows you to specify a range of ports to check for a particular flow, if the protocol selection is TCP or UDP.
- **inside-ip/mask** – If you want packets originating from a certain LAN IP address to be marked, enter the IP address and subnet mask here. If you leave the address equal to zero, this check is ignored for outbound packets. The check is always ignored for inbound packets. The DiffServe queuing function must be applied ahead of NAT; and, before NAT re-maps the inbound packets, all inbound packets are destined for the Gateway's WAN IP address.
- **outside-ip/mask** – If you want packets destined for and originating from a certain WAN IP address to be marked, enter this address and subnet mask here. If you leave the address equal to zero, the outside address check is ignored. For outbound flows, the outside address is the destination IP address for the packets. For inbound packets, the outside address is the source IP address for the packets.

Note:

When setting the Inside/Outside IP Address/Netmask settings, note that a netmask value can be used to configure for a network rather than a single IP address.

- **qos** – Allows you to specify the Quality of Service for the flow: **off**, **assure**, **expedite** or **network-control**. These are used both to mark the IP TOS byte and to distribute packets into the queues as if they were marked by the source.

QoS Setting	TOS Bit Value	Behavior
Off	TOS=000	This custom flow is disabled. You can activate it by selecting one of the two settings below. This setting allows you to pre-define flows without actually activating them.
Assure	TOS=001	Use normal queuing and throughput rules, but do not drop packets if possible. Appropriate for applications with no guaranteed delivery mechanism.
Expedite	TOS=101	Use minimum delay. Appropriate for VoIP and video applications.
Network Control	TOS=111	Use highest possible priority.

Packet Mapping Configuration

set diffserv qos [network-control-queue | expedite-queue | assured-queue | best-effort-queue] *queue_name*

Specifies the Diffserv QoS queue mapping associations.

- ***queue_name*** - the basic queue name to which classified packets are directed.

By default the following mappings are created:

```
set diffserv qos network-control-queue basic_q0
set diffserv qos expedite-queue basic_q1
set diffserv qos assured-queue basic_q2
set diffserv qos best-effort-queue basic_q3
```

set diffserv qos dscp-map [default | custom]

- **default** – the default DSCP-queue mappings are used
- **custom** – allows you to set up customized mappings between DSCP code points and queue types.

If **custom** is selected, the following can be configured:

```
set diffserv qos dscp-map-0
  [ best-effort | assured | expedite | network-control ]
set diffserv qos dscp-map-1
  [ best-effort | assured | expedite | network-control ]
...
set diffserv qos dscp-map-31
  [ best-effort | assured | expedite | network-control ]
```

By default, the following settings are used in custom mode:

```
set diffserv qos dscp-map-0 best-effort
set diffserv qos dscp-map-1 best-effort
set diffserv qos dscp-map-2 best-effort
set diffserv qos dscp-map-3 best-effort
set diffserv qos dscp-map-4 best-effort
set diffserv qos dscp-map-5 assured
set diffserv qos dscp-map-6 best-effort
set diffserv qos dscp-map-7 best-effort
set diffserv qos dscp-map-8 best-effort
set diffserv qos dscp-map-9 assured
set diffserv qos dscp-map-10 best-effort
set diffserv qos dscp-map-11 best-effort
set diffserv qos dscp-map-12 best-effort
set diffserv qos dscp-map-13 assured
set diffserv qos dscp-map-14 best-effort
set diffserv qos dscp-map-15 best-effort
set diffserv qos dscp-map-16 best-effort
set diffserv qos dscp-map-17 assured
set diffserv qos dscp-map-18 best-effort
set diffserv qos dscp-map-19 best-effort
```

```
set diffserv qos dscp-map-20 best-effort
set diffserv qos dscp-map-21 best-effort
set diffserv qos dscp-map-22 best-effort
set diffserv qos dscp-map-23 expedite
set diffserv qos dscp-map-24 network-control
set diffserv qos dscp-map-25 network-control
set diffserv qos dscp-map-26 network-control
set diffserv qos dscp-map-27 network-control
set diffserv qos dscp-map-28 network-control
set diffserv qos dscp-map-29 network-control
set diffserv qos dscp-map-30 network-control
set diffserv qos dscp-map-31 network-control
```

Queue Configuration

Beginning with Firmware Version 7.7.4, the queuing characteristics of all “N” and “-02” model Gateway’s WAN interface can now be configured for:

- strict priority queuing (as currently)
- weighted fair queuing
- rate-limiting funnel



Note:

The configuration mechanism is designed to be flexible enough to accommodate complex queuing requirements. Configurations not supported by the Gateway will be flagged during configuration verification.

You configure the WAN outbound queue as follows:

- create and configure one or more queues, which can be a basic queue or a priority queue comprising a group of basic queues, a weighted fair queue comprising a group of basic queues, or a funnel comprising a group of basic queues;
- assign a queue instance to the Ethernet WAN interface;
- map packet attributes to a queue.

The same queue name can be assigned to multiple interfaces which require identical queue configuration, however currently the only interface available for queueing configuration is ethernet 1.

To help you configure queues, and to maintain compatibility with previous firmware releases, several queues are set up automatically on upgrade to Version 7.7, or upon a factory reset.

**set queue name *queue_name* option [on | off]
type [basic | wfq | priority | funnel]**

Creates a queue named *queue_name* and assigns a **type**:

- **basic** – Basic Queue
- **wfq** – Weighted Fair Queue
- **priority** – Priority Queue
- **funnel** – Funnel Queue

Basic Queue

**set queue name *basic_queue_name* option [on | off]
set queue name *basic_queue_name* type basic**

Specifies the Basic Queue named *basic_queue_name* attributes. Basic queues have one input and one output. The basic queue is assigned an ID, with the following attribute: when the queue is full, discard.

By default, the following Basic Queues are created:

- basic_q0
- basic_q1
- basic_q2
- basic_q3

Weighted Fair Queue

```
set queue name wfq option [ on | off ]
set queue name wf_queue_name type wfq
set queue name wf_queue_name weight-type [ relative | bps ]
set queue name wf_queue_name entry n input input_queue_name
set queue name wf_queue_name entry n weight weight
set queue name wf_queue_name entry n share-bw [ on | off ]
set queue name wf_queue_name entry n default-input queue_name
```

Specifies the attributes of the Weighted Fair Queue named *wf_queue_name*.

- **wf_queue_name** – name of weighted fair queue

A weighted fair queue can contain up to 8 input queues. For each input queue, the following is configured:

- **weight-type** – the weighted fair queue configuration allows you to set the rate in bits per second (**bps**) or percentage of the line rate (**relative**). **bps** is the default.
- **n** – entry number for this input queue
- **input_queue_name** – name of input queue
- **weight_value** – numeric relative weight of queue
- **share-bw** – if enabled, the bandwidth for this queue can be shared between other queues when idle.
- **default-input** – specifies the default input queue name.

The default special queuing configuration shapes the rate of a custom flow toward the Remote Management Server.

By default, the following WFQ is created:

```
set queue name "wfq" option on
set queue name "wfq" type wfq
set queue name "wfq" weight-type bps
set queue name "wfq" entry 1 input "basic_q0"
set queue name "wfq" entry 1 weight 10000
set queue name "wfq" entry 1 share-bw off
set queue name "wfq" entry 2 input "basic_q1"
set queue name "wfq" entry 2 weight 20000
set queue name "wfq" entry 2 share-bw off
set queue name "wfq" entry 3 input "basic_q2"
set queue name "wfq" entry 3 weight 30000
set queue name "wfq" entry 3 share-bw off
set queue name "wfq" entry 4 input "basic_q3"
set queue name "wfq" entry 4 weight 40000
set queue name "wfq" entry 4 share-bw off
set queue name "wfq" default-input "basic_q0"
```

Priority Queue

```
set queue name priority_queue_name option [ off | on ]
set queue name priority_queue_name type priority
set queue name priority_queue_name default-input queue_name
```

A priority queue can contain up to 8 input queues. For each input queue, the following is configured:

```
set queue name priority_queue_name entry n
    input input_queue_name
set queue name priority_queue_name entry n priority priority_value
```

Specifies the Priority Queue named *priority_queue_name* attributes.

- ***priority_queue_name*** – name of priority queue
- ***input_queue_name*** – name of input queue
- ***priority_value*** – numeric relative priority of queue. The higher the number, the higher the priority of the queue.
- ***default-input*** – specifies the default input queue name.

By default, the following priority queue is created:

```
set queue name "pq" option on
set queue name "pq" type priority
set queue name "pq" entry 1 input "basic_q0"
set queue name "pq" entry 1 priority 10
set queue name "pq" entry 2 input "basic_q1"
set queue name "pq" entry 2 priority 20
set queue name "pq" entry 3 input "basic_q2"
set queue name "pq" entry 3 priority 30
set queue name "pq" entry 4 input "basic_q3"
set queue name "pq" entry 4 priority 40
set queue name "pq" default-input "basic_q0"
```

Funnel Queue

A funnel queue is used to limit the rate of the transmission below the actual line rate:

```
set queue name funnel_queue_name option [ on | off ]
set queue name funnel_queue_name type funnel
set queue name funnel_queue_name input input_queue_name
set queue name funnel_queue_name bps bps
```

Specifies the Funnel Queue named *funnel_queue_name* attributes.

- *funnel_queue_name* – name of funnel queue
- *input_queue_name* – name of input queue
- *bps* – max bits per second permitted through funnel queue

By default, the following funnel queues are created:

Rate-limiting priority queue to 100Kbps:

```
set queue name pq-100kbps option on
set queue name pq-100kbps type funnel
set queue name pq-100kbps input pq
set queue name pq-100kbps bps 100000
```

Rate-limiting weighted fair queue to 100Kbps:

```
set queue name wfq-100kbps option on
set queue name wfq-100kbps type funnel
set queue name wfq-100kbps input wfq
set queue name wfq-100kbps bps 100000
```

Interface Queue Assignment

The WAN ethernet queue is assigned as follows:

```
set [ ethernet ethernet I ip ethernet B | ip-ppp vccn ] tx-queue queue_name
```

By default, the WAN ethernet interface is assigned the default priority queue:

```
set ethernet ethernet B tx-queue pq
```

Other interfaces may likewise be assigned **tx-queue** values.

SIP Passthrough

set ip sip-passthrough [on | off]

Turns Session Initiation Protocol application layer gateway client passthrough on or off. The default is **on**.

Session Initiation Protocol, is a signaling protocol for Internet conferencing, telephony, presence, events notification and instant messaging.

RTSP Passthrough

set ip ethernet B rtsp-passthrough [off | on]

Turns Real Time Streaming Protocol application layer gateway client passthrough **on** or **off**. RTSP is a protocol used for streaming media. It allows a client remotely to control a streaming media server. A typical application is Video-on-Demand (VoD). The default is **on**.

Static Route Settings

A static route identifies a manually configured pathway to a remote network. Unlike dynamic routes, which are acquired and confirmed periodically from other routers, static routes do not time out. Consequently, static routes are useful when working with PPP, since an intermittent PPP link may make maintenance of dynamic routes problematic.

You can configure as many as 32 static IP routes for a Motorola Netopia® Gateway. Use the following commands to maintain static routes to the Motorola Netopia® Gateway routing table:

set ip static-routes destination-network *net_address*

Specifies the network address for the static route. Enter a network address in the *net_address* argument in dotted decimal format. The *net_address* argument cannot be 0.0.0.0.

set ip static-routes destination-network *net_address* netmask *netmask*

Specifies the subnet mask for the IP network at the other end of the static route. Enter the *netmask* argument in dotted decimal format. The subnet mask associated with the destination network must represent the same network class (A, B, or C) or a lower class (such as a class C subnet mask for class B network number) to be valid.

**set ip static-routes destination-network *net_address*
interface { ip-address | ppp-vccn }**

Specifies the interface through which the static route is accessible.

**set ip static-routes destination-network *net_address*
gateway-address *gate_address***

Specifies the IP address of the Gateway for the static route. The default Gateway must be located on a network connected to the Motorola Netopia® Gateway configured interface.

**set ip static-routes destination-network *net_address*
metric *integer***

Specifies the metric (hop count) for the static route. The default metric is 1. Enter a number from 1 to 15 for the integer argument to indicate the number of routers (actual or best guess) a packet must traverse to reach the remote network.

You can enter a metric of 1 to indicate either:

- The remote network is one router away and the static route is the best way to reach it;
- The remote network is more than one router away but the static route should not be replaced by a dynamic route, even if the dynamic route is more efficient.

**set ip static-routes destination-network *net_address*
rip-advertise [splitHorizon | always | never]**

Specifies whether the gateway should use Routing Information Protocol (RIP) broadcasts to advertise to other routers on your network and which mode to use. The default is **splitHorizon**.

delete ip static-routes destination-network *net_address*

Deletes a static route. Deleting a static route removes all information associated with that route.

IPMaps Settings

set ip-maps name <name> internal-ip <ip address>

Specifies the name and static ip address of the LAN device to be mapped.

set ip-maps name <name> external-ip <ip address>

Specifies the name and static ip address of the WAN device to be mapped.

Up to 8 mapped static IP addresses are supported.

Network Address Translation (NAT) Default Settings

NAT default settings let you specify whether you want your Motorola Netopia® Gateway to forward NAT traffic to a default server when it doesn't know what else to do with it. The NAT default host function is useful in situations where you cannot create a specific NAT pinhole for a traffic stream because you cannot anticipate what port number an application might use. For example, some network games select arbitrary port numbers when a connection is being opened. By identifying your computer (or another host on your network) as a NAT default server, you can specify that NAT traffic that would otherwise be discarded by the Motorola Netopia® Gateway should be directed to a specific hosts.

set nat-default mode [off | default-server | ip-passthrough]

Specifies whether you want your Motorola Netopia® Gateway to forward unsolicited traffic from the WAN to a default server or an IP passthrough host when it doesn't know what else to do with it. See [“Default Server” on page 89](#) for more information.

set nat-default dhcp-enable [on | off]

Allows the IP passthrough host to acquire its IP address via DHCP, if **ip-passthrough** is enabled.

set nat-default address *ip_address*

Specifies the IP address of the NAT default server.

set nat-default host-hardware-address *MAC_address* }

Specifies the hardware (MAC) address of the IP passthrough host. If the MAC address is specified as all-zeroes, the first DHCP client that requests an IP address gets the passthrough address.

Network Address Translation (NAT) Pinhole Settings

NAT pinholes let you pass specific types of network traffic through the NAT interfaces on the Motorola Netopia® Gateway. NAT pinholes allow you to route selected types of network traffic, such as FTP requests or HTTP (Web) connections, to a specific host behind the Motorola Netopia® Gateway transparently.

To set up NAT pinholes, you identify the type(s) of traffic you want to redirect by port number, and you specify the internal host to which each specified type of traffic should be directed.

The following list identifies protocol type and port number for common TCP/IP protocols:

- FTP (TCP 21)
- telnet (TCP 23)
- SMTP (TCP 25),
- TFTP (UDP 69)
- SNMP (TCP 161, UDP 161)

set pinhole name *name*

Specifies the identifier for the entry in the router's pinhole table. You can name pinhole table entries sequentially (1, 2, 3), by port number (21, 80, 23), by protocol, or by some other naming scheme.

set pinhole name *name* protocol-select { tcp | udp }

Specifies the type of protocol being redirected.

set pinhole name *name* external-port-start [0 - 49151]

Specifies the first port number in the range being translated.

set pinhole name *name* external-port-end [0 - 49151]

Specifies the last port number in the range being translated.

set pinhole name *name* internal-ip *internal-ip*

Specifies the IP address of the internal host to which traffic of the specified type should be transferred.

set pinhole name *name* internal-port [0 - 65535]

Specifies the port number your Motorola Netopia® Gateway should use when forwarding traffic of the specified type. Under most circumstances, you would use the same number for the external and internal port.

PPPoE /PPPoA Settings

You can use the following commands to configure basic settings, port authentication settings, and peer authentication settings for PPP interfaces on your Motorola Netopia® Gateway.

Configuring Basic PPP Settings.



NOTE:

For the DSL platform you must identify the virtual PPP interface [**vccn**], a number from 1 to 8.

set ppp module [vccn] option { on | off }

Enables or disables PPP on the Motorola Netopia® Gateway.

set ppp module [vccn] auto-connect { on | off }

Supports manual mode required for some vendors. The default **on** is not normally changed. If auto-connect is disabled (**off**), you must manually start/stop a ppp connection.

set ppp module [vccn] mru *integer*

Specifies the Maximum Receive Unit (MRU) for the PPP interface. The *integer* argument can be any number between 128 and 1492 for PPPoE; 1500 otherwise.

set ppp module [vccn] magic-number { on | off }

Enables or disables LCP magic number negotiation.

set ppp module [vccn] protocol-compression { on | off }

Specifies whether you want the Motorola Netopia® Gateway to compress the PPP Protocol field when it transmits datagrams over the PPP link.

set ppp module [vccn] lcp-echo-requests { on | off }

Specifies whether you want your Motorola Netopia® Gateway to send LCP echo requests. You should turn off LCP echoing if you do not want the Motorola Netopia® Gateway to drop a PPP link to a nonresponsive peer.

set ppp module [vccn] echo-period *integer*

Specifies the number of seconds the Motorola Netopia® Gateway should wait before sending another echo from an LCP echo request. The integer argument can be any number from between 5 and 300 (seconds).

set ppp module [vccn] lost-echoes-max *integer*

Specifies the maximum number of lost echoes the Motorola Netopia® Gateway should tolerate before bringing down the PPP connection. The integer argument can be any number from between 1 and 20.

set ppp module [vccn] failures-max *integer*

Specifies the maximum number of Configure-NAK messages the PPP module can send without having sent a Configure-ACK message. The integer argument can be any number between 1 and 20.

set ppp module [vccn] configure-max *integer*

Specifies the maximum number of unacknowledged configuration requests that your Motorola Netopia® Gateway will send. The integer argument can be any number between 1 and 20.

set ppp module [vccn] terminate-max *integer*

Specifies the maximum number of unacknowledged termination requests that your Motorola Netopia® Gateway will send before terminating the PPP link. The integer argument can be any number between 1 and 10.

set ppp module [vccn] restart-timer *integer*

Specifies the number of seconds the Motorola Netopia® Gateway should wait before retransmitting a configuration or termination request. The integer argument can be any number between 1 and 30.

set ppp module [vccn] connection-type { instant-on | always-on }

Specifies whether a PPP connection is maintained by the Motorola Netopia® Gateway when it is unused for extended periods. If you specify **always-on**, the Motorola Netopia® Gateway never shuts down the PPP link. If you specify **instant-on**, the Motorola Netopia® Gateway shuts down the PPP link after the number of seconds specified in the **time-out** setting (below) if no traffic is moving over the circuit.

set ppp module [vccn] time-out *integer*

If you specified a connection type of **instant-on**, specifies the number of seconds, in the range 30 - 3600, with a default value of 300, the Motorola Netopia® Gateway should wait for communication activity before terminating the PPP link.

Configuring Port Authentication. You can use the following command to specify how your Motorola Netopia® Gateway should respond when it receives an authentication request from a remote peer.

The settings for port authentication on the local Motorola Netopia® Gateway must match the authentication that is expected by the remote peer. For example, if the remote peer requires CHAP authentication and has a name and CHAP secret for the Motorola Netopia® Gateway, you must enable CHAP and specify the same name and secret on the Motorola Netopia® Gateway before the link can be established.

set ppp module [vccn] port-authentication option [off | on | pap-only | chap-only]

Specifying **on** turns both PAP and CHAP on, or you can select PAP or CHAP. Specify the **username** and **password** when port authentication is turned on (both CHAP and PAP, CHAP or PAP.) Authentication must be enabled before you can enter other information.

set ppp module [vccn] port-authentication username *username*

The **username** argument is 1 – 255 alphanumeric characters. The information you enter must match the username configured in the PPP peer's authentication database.

set ppp module [vccn] port-authentication password *password*

The **password** argument is 1 – 128 alphanumeric characters. The information you enter must match the password used by the PPP peer.

PPPoE with IPoE Settings

Ethernet WAN platforms

set wan-over-ether pppoe [on | off]

Enables or disables PPPoE on the Ethernet WAN interface.

set wan-over-ether pppoe-with-ipoe [on | off]

Enables or disables the PPPoE with IPoE support on Ethernet WAN, including VDSL, platforms when **pppoe option** is set to **on**.

When **pppoe-with-ipoe** is set to **on**, an additional interface, "ethernet C," becomes available.

set wan-over-ether ipoe-sessions [1 - 4]

Sets the number of IPoE sessions, up to four, on Ethernet WAN, including VDSL, platforms.



NOTE:

Enabling **pppoe-with-ipoe** disables support for multiple PPPoE sessions.

Example:

```
set ip ethernet C option on
set ip ethernet C address 0.0.0.0
set ip ethernet C broadcast 0.0.0.255
set ip ethernet C netmask 255.255.255.0
set ip ethernet C restrictions admin-disabled
set ip ethernet C addr-mapping on
set ip ethernet C dns acquired-dns-priority 20
set ip ethernet C mcast-fwd on
set ip ethernet C igmp-null-source-addr off
set ip ethernet C tx-queue "none"
set ip ethernet C unnumbered off
set ip ethernet C rip-receive off
set ip ethernet C proxy-arp off
set ip ip-ppp enet-B option on
set ip ip-ppp enet-B address 0.0.0.0
set ip ip-ppp enet-B peer-address 0.0.0.0
set ip ip-ppp enet-B restrictions admin-disabled
set ip ip-ppp enet-B addr-mapping on
set ip ip-ppp enet-B dns acquired-dns-priority 20
set ip ip-ppp enet-B igmp-null-source-addr off
set ip ip-ppp enet-B tx-queue "none"
set ip ip-ppp enet-B mcast-fwd on
set ip ip-ppp enet-B unnumbered off
set ip ip-ppp enet-B rip-receive off
```

ADSL platforms

You must configure two VCCs with the *same* VPI/VCI to enable concurrent PPPoE and IPoE support, and you will need to configure the individual settings for each interface for proper operation.

set atm vcc *n* encap pppoe-llc

Specifies that the VCC will allow a second VCC with the same VPI/VCI values as the first. **pppoe-llc** denotes this special case.

Example:

```
set atm option on
set atm vcc 1 option on
set atm vcc 1 vpi 0
set atm vcc 1 vci 35
set atm vcc 1 encap pppoe-llc
set atm vcc 2 option on
set atm vcc 2 vpi 0
set atm vcc 2 vci 35
set atm vcc 2 encap ether-llc
```

This will allow you to configure the second WAN interface.

```
set atm vcc 2 vpi 0
set atm vcc 2 vci 35
set atm vcc 2 encap ether-llc
...
```

set ip ip-ppp vcc1 mcast-fwd [on | off]

Enables or disables multi-cast forwarding on the specified interface. If set to **on**, this interface acts as an IGMP proxy host, and IGMP packets are transmitted and received on this interface on behalf of IGMP hosts on the LAN interface. See [“IGMP \(Internet Group Management Protocol\)” on page 100](#) for more information.

set ip ip-ppp vcc1 igmp-null-source-addr [off | on]

Enables or disables IGMP null source address, if **mcast-fwd** is set to **on**. If enabled, the source IP address of every IGMP packet transmitted from this interface is set to 0.0.0.0. This complies with the requirements of TR-101, and removes the need for a publicly advertised IP address on the WAN interface.

Ethernet Port Settings

set ethernet ethernet A mode { auto | 100M-full | 100M-full-fixed | 100M-half-fixed | 10M-full-fixed | 10M-half-fixed | 100M-half | 10M-full | 10M-half }

Allows mode setting for the ethernet port. Only supported on units without a LAN switch, or dual ethernet products (338x). In the dual ethernet case, “ethernet B” would be specified for the WAN port. The default is **auto**.

802.3ah Ethernet OAM Settings

802.3ah Ethernet in the First Mile (EFM) Operations Administration and Maintenance (OAM) is a group of network management functions that provide network fault indication, performance information, and diagnosis using special-purpose Ethernet OAM frames. These are exchanged between your Gateway and service provider Access Node (AN) devices for network fault management, performance analysis and fault isolation.

All VDSL and Ethernet WAN Motorola Netopia Gateways support Ethernet OAM options.

More Ethernet Packet-Transfer-Mode (PTM) enabled xDSL Motorola Netopia Gateways will support 802.3ah Ethernet OAM options in future releases.

802.3ah Ethernet OAM exchanges periodic Ethernet OAM heartbeat frames between the endpoints of the physical link being monitored, and thus discovers and keeps-alive the Link connectivity and reports faults if the link goes down. Supported OAM request and response types are: remote loopback enable, remote loopback disable, variable request, variable response.

set ethernet oam ah option [off | on]

Enables or disables Ethernet OAM. Default is **off**.

set ethernet oam ah pass-through [off | on]

Enable or disable Ethernet OAM pass-through mode. Default is **off**.

Warning: This is a DEBUG feature. Leave it off unless you know exactly what you are doing.

set ethernet oam ah mode [active | passive]

Specifies the Ethernet OAM mode. Default is **active**.

set ethernet oam ah pdu-size-max [64 - 1518]

Specifies the Maximum Protocol Data Unit (PDU) size. Default is **1518**.

set ethernet oam ah discovery-timer [1 - 300]

Specifies the discovery timer value for continuity check in seconds. Range is 1 – 300 seconds. Default is **1**.

set ethernet oam ah keepalive-timer [5 - 305]

Specifies the keep-alive timer value in seconds. Range is 5 – 305 seconds. Default is **5**.

etheroam ah ping

Sends OAM remote loopback request in active mode.

Command Line Interface Preference Settings

You can set command line interface preferences to customize your environment.

set preference verbose { on | off }

Specifies whether you want command help and prompting information displayed. By default, the command line interface verbose preference is turned off. If you turn it on, the command line interface displays help for a node when you navigate to that node.

set preference more *lines*

Specifies how many lines of information you want the command line interface to display at one time. The *lines* argument specifies the number of lines you want to see at one time. The range is 1-65535. By default, the command line interface shows you 22 lines of text before displaying the prompt: **More** ...[y|n] ?.

If you enter 1000 for the *lines* argument, the command line interface displays information as an uninterrupted stream (which is useful for capturing information to a text file).

Port Renumbering Settings

If you use NAT pinholes to forward HTTP or telnet traffic through your Motorola Netopia® Gateway to an internal host, you must change the port numbers the Motorola Netopia® Gateway uses for its own configuration traffic. For example, if you set up a NAT pinhole to forward network traffic on Port 80 (HTTP) to another host, you would have to tell the Motorola Netopia® Gateway to listen for configuration connection requests on a port number other than 80, such as 6080.

After you have changed the port numbers the Motorola Netopia® Gateway uses for its configuration traffic, you must use those port numbers instead of the standard numbers when configuring the Motorola Netopia® Gateway. For example, if you move the router's Web service to port "6080" on a box with a system (DNS) name of "superbox", you would enter the URL ***http://superbox:6080*** in a Web browser to open the Motorola Netopia® Gateway graphical user interface. Similarly, you would have to configure your telnet application to use the appropriate port when opening a configuration connection to your Motorola Netopia® Gateway.

set servers web-http [1 - 65534]

Specifies the port number for HTTP (web) communication with the Motorola Netopia® Gateway. Because port numbers in the range 0-1024 are used by other protocols, you should use numbers in the range 1025-65534 when assigning new port numbers to the Motorola Netopia® Gateway web configuration interface. A setting of **0** (zero) will turn the server off.

set servers telnet-tcp [1 - 65534]

Specifies the port number for telnet (CLI) communication with the Motorola Netopia® Gateway. Because port numbers in the range 0-1024 are used by other protocols, you should use numbers in the range 1025-65534 when assigning new port numbers to the Motorola Netopia® Gateway telnet configuration interface. A setting of **0** (zero) will turn the server off.



NOTE:

You cannot specify a port setting of **0** (zero) for both the web and telnet ports at the same time. This would prevent you from accessing the Gateway.

Security Settings

Security settings include the Firewall, Packet Filtering, Stateful Inspection, and IPsec parameters. Some of the security functionality is keyed.

Firewall Settings (for BreakWater Firewall)

set security firewall option [ClearSailing | SilentRunning | LANdLocked]

The 3 settings for BreakWater are discussed in detail on page [page 142](#).

SafeHarbour IPsec Settings

SafeHarbour VPN is a tunnel between the local network and another geographically dispersed network that is interconnected over the Internet. This VPN tunnel provides a secure, cost-effective alternative to dedicated leased lines. Internet Protocol Security (IPsec) is a series of services including encryption, authentication, integrity, and replay protection. Internet Key Exchange (IKE) is the key management protocol of IPsec that establishes keys for encryption and decryption. Because this VPN software implementation is built to these standards, the other side of the tunnel can be either another Motorola Netopia® unit or another IPsec/IKE based security product. For VPN you can choose to have traffic authenticated, encrypted, or both.

When connecting the Motorola Netopia® unit in a telecommuting scenario, the corporate VPN settings will dictate the settings to be used in the Motorola Netopia® unit. If a parameter has not been specified from the other end of the tunnel, choose the default unless you fully understand the ramifications of your parameter choice.

set security ipsec option (off) {on | off}

Turns on the SafeHarbour IPsec tunnel capability. Default is off. See “IPsec” on [page 146](#) for more information.

set security ipsec tunnels name "123"

The name of the tunnel can be quoted to allow special characters and embedded spaces.

set security ipsec tunnels name "123" tun-enable (on) {on | off}

This enables this particular tunnel. Currently, one tunnel is supported.

set security ipsec tunnels name "123" dest-ext-address ip-address

Specifies the IP address of the destination gateway.

**set security ipsec tunnels name "123" dest-int-network
*ip-address***

Specifies the IP address of the destination computer or internal network.

**set security ipsec tunnels name "123" dest-int-netmask
*netmask***

Specifies the subnet mask of the destination computer or internal network. The subnet mask specifies which bits of the 32-bit IP address represents network information. The default subnet mask for most networks is 255.255.255.0 (class C subnet mask).

**set security ipsec tunnels name "123" encrypt-protocol
(ESP) { ESP | none }**

See [page 146](#) for details about SafeHarbour IPsec tunnel capability.

**set security ipsec tunnels name "123" auth-protocol
(ESP) { AH | ESP | none }**

See [page 146](#) for details about SafeHarbour IPsec tunnel capability.

**set security ipsec tunnels name "123" IKE-mode
pre-shared-key-type (hex) { ascii | hex }**

See [page 146](#) for details about SafeHarbour IPsec tunnel capability.

**set security ipsec tunnels name "123" IKE-mode
pre-shared-key ("") { hex string }**

See [page 146](#) for details about SafeHarbour IPsec tunnel capability.

Example: **0x1234**

**set security ipsec tunnels name "123" IKE-mode
neg-method { main | aggressive }**

See [page 146](#) for details about SafeHarbour IPsec tunnel capability.

Note: *Aggressive Mode* is a little faster, but it does not provide identity protection for negotiations nodes.

**set security ipsec tunnels name "123" IKE-mode
DH-group (1) { 1 | 2 | 5 }**

See [page 146](#) for details about SafeHarbour IPsec tunnel capability.

```
set security ipsec tunnels name "123" IKE-mode  
isakmp-SA-encrypt (DES) { DES | 3DES }
```

See [page 146](#) for details about SafeHarbour IPsec tunnel capability.

```
set security ipsec tunnels name "123" IKE-mode  
ipsec-mtu mtu_value
```

The **Maximum Transmission Unit** is a link layer restriction on the maximum number of bytes of data in a single transmission. The maximum allowable value (also the default) is 1500, and the minimum is 100.

```
set security ipsec tunnels name "123" IKE-mode isakmp-SA-hash  
(MD5) {MD5 | SHA1}
```

See [page 146](#) for details about SafeHarbour IPsec tunnel capability.

```
set security ipsec tunnels name "123" IKE-mode PFS-enable  
{ off | on }
```

See [page 146](#) for details about SafeHarbour IPsec tunnel capability.

```
set security ipsec tunnels name "123" IKE-mode invalid-spi-recovery  
{ off | on }
```

Enables the Gateway to re-establish the tunnel if either the Motorola Netopia® Gateway or the peer gateway is rebooted.

```
set security ipsec tunnels name "123" xauth enable {off | on }
```

Enables or disables Xauth extensions to IPsec, when **IKE-mode neg-method** is set to **aggressive**. Default is **off**.

```
set security ipsec tunnels name "123" xauth username username
```

Sets the Xauth username, if Xauth is enabled.

```
set security ipsec tunnels name "123" xauth password password
```

Sets the Xauth password, if Xauth is enabled.

```
set security ipsec tunnels name "123" nat-enable { on | off }
```

Enables or disables NAT on the specified IPsec tunnel. The default is **off**.

```
set security ipsec tunnels name "123" nat-pat-address ip-address
```

Specifies the NAT port address translation IP address for the specified IPsec tunnel.

```
set security ipsec tunnels name "123" local-id-type  
  { IP-address | Subnet | Hostname | ASCII }
```

Specifies the NAT local ID type for the specified IPsec tunnel, when Aggressive Mode is set.

```
set security ipsec tunnels name "123" local-id id_value
```

Specifies the NAT local ID value as specified in the **local-id-type** for the specified IPsec tunnel, when Aggressive Mode is set.



Note: If **subnet** is selected, the following two values are used instead:

```
set security ipsec tunnels name "123" local-id-addr ip-address  
set security ipsec tunnels name "123" local-id-mask ip-mask
```

```
set security ipsec tunnels name "123" remote-id-type  
  { IP-address | Subnet | Hostname | ASCII }
```

Specifies the NAT remote ID type for the specified IPsec tunnel, when Aggressive Mode is set.

```
set security ipsec tunnels name "123" remote-id id_value
```

Specifies the NAT remote ID value as specified in the **remote-id-type** for the specified IPsec tunnel, when Aggressive Mode is set.



Note: If **subnet** is selected, the following two values are used instead:

```
set security ipsec tunnels name "123" remote-id-addr ip-address  
set security ipsec tunnels name "123" remote-id-mask ip-mask
```

Internet Key Exchange (IKE) Settings

The following four IPsec parameters configure the rekeying event.

```
set security ipsec tunnels name "123" IKE-mode  
ipsec-soft-mbytes (1000) {1-1000000}
```

```
set security ipsec tunnels name "123" IKE-mode  
ipsec-soft-seconds (82800) {60-1000000}
```

```
set security ipsec tunnels name "123" IKE-mode  
ipsec-hard-mbytes (1200) {1-1000000}
```

```
set security ipsec tunnels name "123" IKE-mode  
ipsec-hard-seconds (86400) {60-1000000}
```

- The **soft** parameters designate when the system *begins* to negotiate a new key. For example, after 82800 seconds (23 hours) or 1 Gbyte has been transferred (whichever comes first) the key will begin to be renegotiated.
- The **hard** parameters indicate that the renegotiation *must be complete* or the tunnel will be disabled. For example, 86400 seconds (24 hours) means that the renegotiation must be complete within one day.

Both ends of the tunnel set parameters, and typically they will be the same. If they are not the same, the rekey event will happen when the longest time period expires or when the largest amount of data has been sent.

Stateful Inspection

Stateful inspection options are accessed by the **security state-insp** tag.

```
set security state-insp [ ip-ppp | dsl ] vccn option [ off | on ]  
set security state-insp ethernet [ A | B ] option [ off | on ]
```

Sets the stateful inspection option **off** or **on** on the specified interface. This option is disabled by default. Stateful inspection prevents unsolicited inbound access when NAT is disabled.

```
set security state-insp [ ip-ppp | dsl ] vccn  
  default-mapping [ off | on ]  
set security state-insp ethernet [ A | B ]  
  default-mapping [ off | on ]
```

Sets stateful inspection default mapping to router option **off** or **on** on the specified interface.

```
set security state-insp [ ip-ppp | dsl ] vccn tcp-seq-diff  
  [ 0 - 65535 ]  
set security state-insp ethernet [ A | B ] tcp-seq-diff  
  [ 0 - 65535 ]
```

Sets the acceptable TCP sequence difference on the specified interface. The TCP sequence number difference maximum allowed value is 65535. If the value of **tcp-seq-diff** is 0, it means that this check is disabled.

```
set security state-insp [ ip-ppp | dsl ] vccn  
  deny-fragments [ off | on ]  
set security state-insp ethernet [ A | B ]  
  deny-fragments [ off | on ]
```

Sets whether fragmented packets are allowed to be received or not on the specified interface.

```
set security state-insp tcp-timeout [ 30 - 65535 ]
```

Sets the stateful inspection TCP timeout interval, in seconds.

```
set security state-insp udp-timeout [ 30 - 65535 ]
```

Sets the stateful inspection UDP timeout interval, in seconds.

```
set security state-insp dos-detect [ off | on ]
```

Enables or disables the stateful inspection Denial of Service detection feature. If set to **on**, the device will monitor packets for Denial of Service (DoS) attack. Offending packets may be discarded if it is determined to be a DoS attack.

set security state-insp xposed-addr exposed-address# "n"

Allows you to add an entry to the specified list, or, if the list does not exist, creates the list for the stateful inspection feature. **xposed-addr** settings only apply if NAT is off.

Example:

```
set security state-insp xposed-addr exposed-address# (?): 32
```

32 has been added to the **xposed-addr** list.

Sets the exposed list address number.

set security state-insp xposed-addr exposed-address# "n" start-ip ip_address

Sets the exposed list range starting IP address, in dotted quad format.

set security state-insp xposed-addr exposed-address# "n" end-ip ip_address

Sets the exposed list range ending IP address, in dotted quad format.

32 exposed addresses can be created. The range for exposed address numbers are from 1 through 32.

set security state-insp xposed-addr exposed-address# "n" protocol [tcp | udp | both | any]

Sets the protocol for the stateful inspection feature for the exposed address list. Accepted values for **protocol** are **tcp**, **udp**, **both**, or **any**.

If **protocol** is not **any**, you can set port ranges:

set security state-insp xposed-addr exposed-address# "n" start-port [1 - 65535]

set security state-insp xposed-addr exposed-address# "n" end-port [1 - 65535]

Packet Filtering Settings

Packet Filtering has two parts:

- Create/Edit/Delete Filter Sets, create/edit/delete rules to a Filter Set.
- Associate a created Filter Set with a WAN or LAN interface

See “Packet Filter” on page 163 for more information.

```
set security pkt-filter filterset filterset-name [ input_filter | output_filter ] index  
forward [ on | off ]
```

Creates or edits a filter rule, specifying whether packets will be forwarded or not.



NOTE:

If this is the first rule, it will create the filter-set called *filterset-name*, otherwise it will edit the filterset.

If the index is not consecutive, the system will select the next consecutive index. If the index does not exist, a rule will be created. If a rule exists, the rule will be edited.

```
set security pkt-filter filterset filterset-name [ input_filter | output_filter ] index  
idle-reset [ on | off ]
```

Turns idle reset on or off for the specified filter rule. A match on this rule resets idle-timeout status and keeps the WAN connection alive. The default is **off**. For **idle-reset** to be displayed, **forward** must be enabled on a filter rule.

```
set security pkt-filter filterset filterset-name [ input_filter | output_filter ] index  
frc-rte [ on | off ]
```

Turns forced routing on or off for the specified filter rule. A match on this rule will force a route for packets. The default is **off**. For **frc-rte** to be displayed, **forward** must be enabled on a filter rule.

```
set security pkt-filter filterset filterset-name [ input_filter | output_filter ] index  
gateway ip_addr
```

Specifies the gateway IP address for forced routed packets, if forced routing is enabled.

```
set security pkt-filter filterset filterset-name [ input_filter | output_filter ] index  
src-ip ip_addr
```

Specifies the source IP address to match packets (where the packet was sent from).

```
set security pkt-filter filterset filterset-name [ input_filter | output_filter ] index  
src-mask mask
```

Specifies the source IP mask to match packets (where the packet was sent from).

**set security pkt-filter filterset *filterset-name* [input_filter | output_filter] index
dest-ip *ip_addr***

Specifies the destination IP address to match packets (where the packet is going).

**set security pkt-filter filterset *filterset-name* [input_filter | output_filter] index
dest-mask *mask***

Specifies the destination IP mask to match packets (where the packet is going).

**set security pkt-filter filterset *filterset-name* [input_filter | output_filter] index
tos *value***

Specifies the TOS (Type Of Service) value to match packets. The value for **tos** can be from 0 – 255.

**set security pkt-filter filterset *filterset-name* [input_filter | output_filter] index
tos-mask *value***

Specifies the TOS (Type Of Service) mask to match packets. The value for **tos-mask** can be from 0 – 255.

**set security pkt-filter filterset *filterset-name* [input_filter | output_filter] index
protocol *value***

Specifies the protocol value to match packets, the type of higher-layer Internet protocol the packet is carrying, such as TCP or UDP. The value for **protocol** can be from 0 – 255.

**set security pkt-filter filterset *filterset-name* [input_filter | output_filter] index
src-compare [nc | ne | lt | le | eq | gt | ge]**

Sets the source compare operator action for the specified filter rule. **src-compare** only displays when the **protocol** is TCP or UDP.

Operator	Action
nc	No compare
ne	Not equal to
lt	Less than
le	Less than or equal to
eq	Equal to
ge	Greater than or equal to
gt	Greater than

**set security pkt-filter filterset *filterset-name* [input_filter | output_filter] index
dst-compare [nc | ne | lt | le | eq | gt | ge]**

Sets the destination compare operator action for the specified filter rule. **dst-compare** only displays when the **protocol** is TCP or UDP.

Operator	Action
nc	No compare
ne	Not equal to
lt	Less than
le	Less than or equal to
eq	Equal to
ge	Greater than or equal to
gt	Greater than

**set security pkt-filter filterset *filterset-name* [input_filter | output_filter] index
src-port *value***

Specifies the source IP port to match packets (the port on the sending host that originated the packet, if the underlying protocol is TCP or UDP). **src-port** does not display if **nc** is set for **src-compare** or **dst-compare**.

**set security pkt-filter filterset *filterset-name* [input_filter | output_filter] index
dst-port *value***

Specifies the destination IP port to match packets (the port on the receiving host that the packet is destined for, if the underlying protocol is TCP or UDP). **dst-port** does not display if **nc** is set for **src-compare** or **dst-compare**.

**set security pkt-filter interface
assigned-filterset *filterset-name***

Associates a filterset with a LAN or WAN interface.

Example:

```
set security pkt-filter ethernet A assigned-filterset set1
```

SNMP Settings

The Simple Network Management Protocol (SNMP) lets a network administrator monitor problems on a network by retrieving settings on remote network devices. The network administrator typically runs an SNMP management station program on a local host to obtain information from an SNMP agent such as the Motorola Netopia® Gateway.

set snmp community read *name*

Adds the specified name to the list of communities associated with the Motorola Netopia® Gateway. By default, the Motorola Netopia® Gateway is associated with the public community.

set snmp community write *name*

Adds the specified name to the list of communities associated with the Motorola Netopia® Gateway.

set snmp community trap *name*

Adds the specified name to the list of communities associated with the Motorola Netopia® Gateway.

set snmp trap ip-traps *ip-address*

Identifies the destination for SNMP trap messages. The *ip-address* argument is the IP address of the host acting as an SNMP console.

set snmp sysgroup contact *contact_info*

Identifies the system contact, such as the name, phone number, beeper number, or email address of the person responsible for the Motorola Netopia® Gateway. You can enter up to 255 characters for the *contact_info* argument. You must put the *contact_info* argument in double-quotes if it contains embedded spaces.

set snmp sysgroup location *location_info*

Identifies the location, such as the building, floor, or room number, of the Motorola Netopia® Gateway. You can enter up to 255 characters for the *location_info* argument. You must put the *location_info* argument in double-quotes if it contains embedded spaces.

SNMP Notify Type Settings

set snmp notify type [v1-trap | v2-trap | inform]

Sets the type of SNMP notifications that the system will generate:

- **v1-trap** – This selection will generate notifications containing an SNMPv1 Trap *Protocol Data Unit* (PDU)
- **v2-trap** – This selection will generate notifications containing an SNMPv2 Trap PDU
- **inform** – This selection will generate notifications containing an SNMPv2 InformRequest PDU.

System Settings

You can configure system settings to assign a name to your Motorola Netopia® Gateway and to specify what types of messages you want the diagnostic log to record.

set system name *name*

Specifies the name of your Motorola Netopia® Gateway. Each Motorola Netopia® Gateway is assigned a name as part of its factory initialization. The default name for a Motorola Netopia® Gateway consists of the word “Netopia-3000/XXX” where “XXX” is the serial number of the device; for example, Netopia-3000/9437188. A system name can be 1 – 255 characters long. Once you have assigned a name to your Motorola Netopia® Gateway, you can enter that name in the *Address* text field of your browser to open a connection to your Motorola Netopia® Gateway.



NOTE:

Some broadband cable-oriented Service Providers use the **System Name** as an important identification and support parameter. If your Gateway is part of this type of network, do **NOT** alter the System Name unless specifically instructed by your Service Provider.

set system diagnostic-level { off | low | medium | high | alerts | failures }

Specifies the types of log messages you want the Motorola Netopia® Gateway to record. All messages with a level equal to or greater than the level you specify are recorded. For example, if you specify set system diagnostic-level **medium**, the diagnostic log will retain medium-level informational messages, alerts, and failure messages. Specifying **off** turns off logging.

Use the following guidelines:

- **low** - Low-level informational messages or greater; includes trivial status messages.
- **medium** - Medium-level informational messages or greater; includes status messages that can help monitor network traffic.
- **high** - High-level informational messages or greater; includes status messages that may be significant but do not constitute errors. The default.
- **alerts** - Warnings or greater; includes recoverable error conditions and useful operator information.
- **failures** - Failures; includes messages describing error conditions that may not be recoverable.

set system ftp-server option [off | on]

Enables or disables a simple FTP server in the Gateway. If enabled, the Gateway will accept binary embedded software images (‘.bin’) files or command line configuration files.

Supported FTP commands

MODE	(data transfer mode (only Streaming supported))
NOOP	(send back ok)
PORT	(specify client address:port for data)
QUIT	(quit)
STOR	(send file to FTP server)
SYST	(get system info about FTP server)
TYPE	(set data representation type, ASCII and IMAGE (BIN) only supported)
USER	(send username for authentication)

set system log-size [10240... 65536]

Specifies a size for the system log. The most recent entries are posted to the beginning of the log. When the log becomes full, the oldest entries are dropped. The default is 30000.

set system persistent-log [off | on]

When set to **on**, causes the log information to be kept in flash memory.

set system idle-timeout { telnet [1...120] | http [1... 120] }

Specifies a timeout period of inactivity for telnet or HTTP access to the Gateway, after which a user must re-login to the Gateway. Defaults are 5 minutes for HTTP and 15 minutes for telnet.

set system username { administrator *name* | user *name* }

Specifies the usernames for the administrative user – the default is **admin**; and a non-administrative user – the default is **user**.

set system password { admin | user }

Specifies the administrator or user password for a Motorola Netopia® Gateway. When you enter the **set system password** command, you are prompted to enter the old password (if any) and new password. You are prompted to repeat the new password to verify that you entered it correctly the first time. To prevent anyone from observing the password you enter, characters in the old and new passwords are not displayed as you type them. For security, you cannot use the “step” method to set the system password.

A password can be as many as 8 characters. Passwords are case-sensitive.

Passwords go into effect immediately. You do not have to restart the Motorola Netopia® Gateway for the password to take effect. Assigning an administrator or user password to a Motorola Netopia® Gateway does not affect communications through the device.

```
set system heartbeat option { on | off }
  protocol [ udp | tcp ]
  port-client [ 1 - 65535 ]
  ip-server [ ip_address | dns_name ]
  port-server [ 1 - 65535 ]
  url-server ("server_name")
  number [ 1 - 1073741823 ]
  interval (00:00:00:20)
  sleep (00:00:30:00)
  contact-email ("string@domain_name")
  location ("string"):
```

The heartbeat setting is used in conjunction with the configuration server to broadcast contact and location information about your Gateway. You can specify the **protocol**, **port**, **IP-**, **port-**, and **URL-server**.

- The **interval** setting specifies the broadcast update frequency. Part of sequence control. The interval is the spacing between heartbeats, in d:h:m:s.
- The **contact-email** setting is a quote-enclosed text string giving an email address for the Gateway's administrator.
- The **location** setting is a text string allowing you to specify your geographical or other location, such as "Secaucus, NJ."
- The **number** setting is part of the sequence control. This is the number of heartbeats to send, at each "interval", before sleeping. For example, if this is 20, in the above layout, each heartbeat sequence will send out a total 20 heartbeats, spaced at 30 second intervals, and then sleep for 30 minutes. So to have the Gateway send out packets "forever", this number can be set very high. If it is 1440 and the interval is 1 minute, say, the heartbeat will go out every minute for 1440 minutes, or one day, before sleeping.
- The **sleep** setting is part of sequence control. This is the time to sleep before starting another heartbeat sequence, in d:h:m:s.

```
set system ntp
  option [ off | on ]:
  server-address (north-america.pool.ntp.org)
  alt-server-address (pool.ntp.org):
  time-zone [ -12 - 12 ]
  update-period (60) [ 1 - 65535 ]:
  daylight-savings [ off | on ]
```

Specifies the NTP server address, time zone, and how often the Gateway should check the time from the NTP server. The NTP **server-address** and **alt-server-address** can be entered as DNS names as well as IP addresses. NTP time-zone of 0 is GMT time; options are -12 through 12 (+/- 1 hour increments from GMT time). **update-period** specifies how often, in minutes, the Gateway should update the clock. **daylight-savings** specifies whether daylight savings time is in effect; it defaults to **off**.

```
set system zerotouch option [ on | off ]
```

Enables or disables the Zero Touch option.

Zero Touch refers to automatic configuration of your Motorola Netopia® Gateway. The Motorola Netopia® Gateway has default settings such that initial connection to the Internet will succeed. If the **zerotouch** option is set to **on**, HTTP requests to any destination IP address except the IP address(es) of the configured redirection URL(s) will access a redirection server. DNS traffic will not be blocked. Other traffic from the LAN to all destinations will be dropped.

set system zerotouch redirect-url *redirection-URL*

Specifies the URL(s) of the desired redirection server(s) when the **zerotouch** option is set to **on**. URLs may be a maximum of 192 characters long, and may be in any of the following forms:

```
http://<domain-name OR IP address>/optionalPath:port
http://<domain-name OR IP address>/optionalPath
https://<domain-name OR IP address>/optionalPath:port
https://<domain-name OR IP address>/optionalPath
<domain-name OR IP address>/optionalPath:port
<domain-name OR IP address>/optionalPath
```

If the port number is omitted, port 80 will be assumed.

Syslog

set system syslog option [off | on]

Enables or disables system syslog feature. If syslog option is **on**, the following commands are available:

set system syslog host-nameip [*ip_address* | *hostname*]

Specifies the syslog server's address either in dotted decimal format or as a DNS name up to 64 characters.

set system syslog log-facility [local0 ... local7]

Sets the UNIX syslog Facility. Acceptable values are **local0** through **local7**.

set system syslog log-violations [off | on]

Specifies whether violations are logged or ignored.

set system syslog log-accepted [off | on]

Specifies whether acceptances are logged or ignored.

set system syslog log-attempts [off | on]

Specifies whether connection attempts are logged or ignored.

Default *syslog* installation procedure

1. **Access the router via telnet from the private LAN.**

DHCP server is enabled on the LAN by default.

2. **The product's stateful inspection feature must be enabled in order to examine TCP, UDP and ICMP packets destined for the router or the private hosts.**

This can be done by entering the **CONFIG** interface.

- Type **config**
- Type the command to enable stateful inspection
set security state-insp ip-ppp vccl option on
- Type the command to enable the router to drop fragmented packets
set security state-insp ip-ppp vccl deny-fragments on

3. **Enabling syslog:**

- Type **config**
- Type the command to enable syslog
set system syslog option on
- Set the IP Address of the syslog host
set system syslog host-nameip <ip-addr>
(example: **set system syslog host-nameip 10.3.1.1**)
- Enable/change the options you require
set system syslog log-facility local1
set system syslog log-violations on
set system syslog log-accepted on
set system syslog log-attempts on

4. **Set NTP parameters**

- Type **config**
- Set the time-zone – Default is 0 or GMT
set system ntp time-zone <zone>
(example: **set system ntp time-zone -8**)
- Set NTP server-address if necessary (default is 204.152.184.72)
set system ntp server-address <ip-addr>
(example:
set system ntp server-address 204.152.184.73)
- Set alternate server address
set system ntp alt-server-address <ip-addr>

5. **Type the command to save the configuration**

- Type **save**
- Exit the configuration interface by typing
exit
- Restart the router by typing
restart

The router will reboot with the new configuration in effect.

Wireless Settings (supported models)

set wireless option (on | off)

Administratively enables or disables the wireless interface.

set wireless network-id ssid { *network_name* }

Specifies the wireless network id for the Gateway. A unique *ssid* is generated for each Gateway. You must set your wireless clients to connect to this exact id, which can be changed to any 32-character string.

set wireless auto-channel mode { off | at-startup | continuous }

Specifies the wireless AutoChannel Setting for 802.11G models. AutoChannel is a feature that allows the Motorola Netopia® Gateway to determine the best channel to broadcast automatically. For details, see [“Advanced” on page 56](#).

set wireless default-channel { 1...14 }

Specifies the wireless 2.4GHz sub channel on which the wireless Gateway will operate. For US operation, this is limited to channels 1–11. Other countries vary; for example, Japan is channel 14 only. The default channel in the US is 6. Channel selection can have a significant impact on performance, depending on other wireless activity in proximity to this AP. Channel selection is not necessary at the clients; clients will scan the available channels and look for APs using the same ssid as the client.

set wireless network-id closed-system { on | off }

When this setting is enabled, a client must know the ssid in order to connect or even see the wireless access point. When disabled, a client may scan for available wireless access points and will see this one. Enable this setting for greater security. The default is **on**.

set wireless mode { both-b-and-g | b-only | g-only }

Specifies the wireless operating mode for connecting wireless clients: **both-b-and-g**, **b-only**, or **g-only**, and locks the Gateway in that mode.



NOTE:

If you choose to limit the operating mode to B or G only, clients using the mode you excluded will not be able to connect.

set wireless multi-ssid option { on | off }

Enables or disables the **multi-ssid** feature which allows you to add additional network identifiers (SSIDs or *Network Names*) for your wireless network. When enabled, you can specify up to three additional SSIDs with separate privacy settings for each. See below.

set wireless multi-ssid {second-ssid | third-ssid | fourth-ssid } *name*

Specifies a descriptive name for each SSID. when **multi-ssid option** is set to **on**.

set wireless multi-ssid second-ssid-privacy { off | WEP | WPA-PSK | WPA-802.1x }

set wireless multi-ssid third-ssid-privacy { off | WEP | WPA-PSK | WPA-802.1x }

set wireless multi-ssid fourth-ssid-privacy { off | WEP | WPA-PSK | WPA-802.1x }

Specifies the type of privacy enabled on multiple SSIDs when **multi-ssid option** is set to **on**. off = no privacy; WEP = WEP encryption; WPA-PSK = Wireless Protected Access/Pre-Shared Key; WPA-802.1x = Wireless Protected Access/802.1x authentication. See [“Wireless Privacy Settings” on page 308](#) for more information.



NOTE:

WEP is supported on only one SSID at a time, and will not be available if another SSID already has it configured.

set wireless multi-ssid second-ssid-wpa-ver { all | WPA1-only | WPA2-only }

set wireless multi-ssid third-ssid-wpa-ver { all | WPA1-only | WPA2-only }

set wireless multi-ssid fourth-ssid-wpa-ver { all | WPA1-only | WPA2-only }

Specifies the type of WPA version enabled on multiple SSIDs when **multi-ssid option** is set to **on** and privacy is set to **WPA-PSK**. See [“Wireless Privacy Settings” on page 308](#) for more information.

set wireless multi-ssid second-ssid-psk { *string* }

set wireless multi-ssid third-ssid-psk { *string* }

set wireless multi-ssid fourth-ssid-psk { *string* }

Specifies a WPA passphrase for the multiple SSIDs, when **second-**, **third-**, or **fourth-ssid-privacy** is set to **WPA-PSK**. The Pre Shared Key is a passphrase shared between the Gateway and the clients and is used to generate dynamically changing keys. The passphrase can be 8 – 63 characters. It is recommended to use at least 20 characters for best security.

set wireless multi-ssid second-ssid-weplen [40/64bit | 128bit | 256bit]

set wireless multi-ssid third-ssid-weplen [40/64bit | 128bit | 256bit]

set wireless multi-ssid fourth-ssid-weplen [40/64bit | 128bit | 256bit]

Specifies the WEP key length for the multiple SSIDs, when **second-**, **third-**, or **fourth-ssid-privacy** is set to **WEP**. **40bit** encryption is equivalent to **64bit** encryption. The longer the key, the stronger the encryption and the more difficult it is to break the encryption.

set wireless multi-ssid second-ssid-wepkey { *hexadecimal digits* }
set wireless multi-ssid third-ssid-wepkey { *hexadecimal digits* }
set wireless multi-ssid fourth-ssid-wepkey { *hexadecimal digits* }

Specifies a WEP key for the multiple SSIDs, when **second-**, **third-**, or **fourth-ssid-privacy** is set to **WEP**. For 40/64bit encryption, you need 10 digits; 26 digits for 128bit, and 58 digits for 256bit WEP. Valid hexadecimal characters are 0 – 9, a – f.

set wireless no-bridging [off | on]

When set to **on**, this will block wireless clients from communicating with other wireless clients on the LAN side of the Gateway.

set wireless tx-power [full | medium | fair | low | minimal]

Sets the wireless transmit power, scaling down the router's wireless transmit coverage by lowering its radio power output. Default is **full** power. Transmit power settings are useful in large venues with multiple wireless routers where you want to reuse channels. Since there are only three non-overlapping channels in the 802.11 spectrum, it helps to size the Gateway's cell to match the location. This allows you to install a router to cover a small "hole" without conflicting with other routers nearby.

Wireless Multi-media (WMM) Settings

Router EDCA Parameters (Enhanced Distributed Channel Access) govern wireless data from your Gateway to the client; **Client EDCA Parameters** govern wireless data from the client to your Gateway.

set wireless wmm option [off | on]

Enables or disables wireless multi-media settings option, which allows you to fine tune WiFi Multimedia Quality of Service (QoS) by transmitting data depending on Diffserv priority settings. These priorities are mapped into four Access Categories (AC), in increasing order of priority: Background (BK), Best Effort (BE), Video (VI), and Voice (VO). It requires WiFi Multimedia-capable clients, usually a separate feature enabled at the client.

- **aifs:** (Arbitration Interframe Spacing) the wait time in milliseconds for data frames.
Valid values are: 1 – 255
- **cwmin:** (Minimum Contention Window) upper limit in milliseconds of the range for determining initial random backoff. The value you choose must be lower than **cwmax**.
Valid **values** are: 1, 3, 7, 15, 31, 63, 127, 255, or 511.
- **cwmax:** (Maximum Contention Window) upper limit in milliseconds of the range of determining final random backoff. The value you choose must be higher than **cwmin**.
Valid **values** are: 3, 7, 15, 31, 63, 127, 255, 511, or 1023.
- **txoplimit:** Time interval in microseconds that clients may initiate transmissions.
Valid values are: 0 – 9999.



NOTE:

It is not recommended that you modify these settings without direct knowledge or instructions to do so. Modifying these settings inappropriately could seriously degrade network performance.

```
set wireless wmm router-edca voice { aifs 1... 255 }  
set wireless wmm router-edca voice { cwmin value }  
set wireless wmm router-edca voice { cwmax value }
```

Sets values for Gateway WMM voice parameters.

```
set wireless wmm router-edca video { aifs 1... 255 }  
set wireless wmm router-edca video { cwmin value }  
set wireless wmm router-edca video { cwmax value }
```

Sets values for Gateway WMM video parameters.

```
set wireless wmm router-edca best-effort { aifs 1... 255 }  
set wireless wmm router-edca best-effort { cwmin value }  
set wireless wmm router-edca best-effort { cwmax value }
```

Sets values for Gateway WMM best effort parameters.

```
set wireless wmm router-edca background { aifs 1... 255 }
set wireless wmm router-edca background { cwmin value }
set wireless wmm router-edca background { cwmax value }
```

Sets values for Gateway WMM background parameters.

```
set wireless wmm client-edca voice { aifs 1... 255 }
set wireless wmm client-edca voice { cwmin value }
set wireless wmm client-edca voice { cwmax value }
set wireless wmm client-edca voice { txoplimit 0... 9999 }
```

Sets values for client WMM voice parameters.

```
set wireless wmm client-edca video { aifs 1... 255 }
set wireless wmm client-edca video { cwmin value }
set wireless wmm client-edca video { cwmax value }
set wireless wmm client-edca video { txoplimit 0... 9999 }
```

Sets values for client WMM video parameters.

```
set wireless wmm client-edca best-effort { aifs 1... 255 }
set wireless wmm client-edca best-effort { cwmin value }
set wireless wmm client-edca best-effort { cwmax value }
set wireless wmm client-edca best-effort { txoplimit 0... 9999 }
```

Sets values for client WMM best effort parameters.

```
set wireless wmm client-edca background { aifs 1... 255 }
set wireless wmm client-edca background { cwmin value }
set wireless wmm client-edca background { cwmax value }
set wireless wmm client-edca background { txoplimit 0... 9999 }
```

Sets values for client WMM background parameters.

Wireless Privacy Settings

set wireless network-id privacy option { off | WEP | WPA-PSK | WPA-802.1x }

Specifies the type of privacy enabled on the wireless LAN. off = no privacy; WEP = WEP encryption; WPA-PSK = Wireless Protected Access/Pre-Shared Key; WPA-802.1x = Wireless Protected Access/802.1x authentication. See “Wireless” on page 53 for a discussion of these options.

WPA provides Wireless Protected Access, the most secure option for your wireless network. This mechanism provides the best data protection and access control. PSK requires a Pre-Shared Key; 802.1x requires a RADIUS server for authentication.

WEP is Wired Equivalent Privacy, a method of encrypting data between the wireless Gateway and its clients. It is strongly recommended to turn this **on** as it is the primary way to protect your network and data from intruders. Note that 40bit is the same as 64bit and will work with either type of wireless client. The default is **off**.

A single key is selected (see **default-key**) for encryption of outbound/transmitted packets. The WEP-enabled client must have the identical key, of the same length, in the identical slot (1..4) as the wireless Gateway, in order to successfully receive and decrypt the packet. Similarly, the client also has a ‘default’ key that it uses to encrypt its transmissions. In order for the wireless Gateway to receive the client’s data, it must likewise have the identical key, of the same length, in the same slot. For simplicity, a wireless Gateway and its clients need only enter, share, and use the first key.

set wireless network-id privacy pre-shared-key *string*

The Pre Shared Key is a passphrase shared between the Router and the clients and is used to generate dynamically changing keys, when **WPA-PSK** is selected or enabled. The passphrase can be 8 – 63 characters. It is recommended to use at least 20 characters for best security.

set wireless network-id privacy default-keyid { 1...4 }

Specifies which WEP encryption key (of 4) the wireless Gateway will use to transmit data. The client *must* have an identical matching key, in the same numeric slot, in order to successfully decode. Note that a client allows you to choose which of its keys it will use to transmit. Therefore, you must have an identical key in the same numeric slot on the Gateway.

For simplicity, it is easiest to have both the Gateway and the client transmit with the same key. The default is **1**.

set wireless network-id privacy encryption-key1-length { 40/64bit, 128bit, 256bit }

set wireless network-id privacy encryption-key2-length { 40/64bit, 128bit, 256bit }

set wireless network-id privacy encryption-key3-length { 40/64bit, 128bit, 256bit }

set wireless network-id privacy encryption-key4-length { 40/64bit, 128bit, 256bit }

Selects the length of each encryption key. **40bit** encryption is equivalent to **64bit** encryption. The longer the key, the stronger the encryption and the more difficult it is to break the encryption.

```
set wireless network-id privacy encryption-key1 { hexadecimal digits }
set wireless network-id privacy encryption-key2 { hexadecimal digits }
set wireless network-id privacy encryption-key3 { hexadecimal digits }
set wireless network-id privacy encryption-key4 { hexadecimal digits }
```

The encryption keys. Enter keys using hexadecimal digits. For 40/64bit encryption, you need 10 digits; 26 digits for 128bit, and 58 digits for 256bit WEP. Valid hexadecimal characters are 0 – 9, a – f.

Example 40bit key: 02468ACE02.

Example 128bit key: 0123456789ABCDEF0123456789.

Example 256bit key: 592CA140F0A238B0C61AE162F592CA140F0A238B0C61AE162F21A09C.

You must set at least one of these keys, indicated by the default-keyid.

Wireless MAC Address Authorization Settings

```
set wireless mac-auth option { on | off }
```

Enabling this feature limits the MAC addresses that are allowed to access the LAN as well as the WAN to specified MAC (hardware) addresses.

```
set wireless mac-auth wrlss-MAC-list mac-address
    MAC-address_string
```

Enters a new MAC address into the MAC address authorization table. The format for an Ethernet MAC address is six hexadecimal values between 00 and FF inclusive separated by colons or dashes (e.g., 00:00:C5:70:00:04).

```
set wireless mac-auth wrlss-MAC-list mac-address
    "MAC-address_string" allow-access { on | off }
```

Designates whether the MAC address is enabled or not for wireless network access. Disabled MAC addresses cannot be used for access until enabled.

RADIUS Server Settings

set radius radius-name " *server_name_string* "

Specifies the default RADIUS server name or IP address.

set radius radius-secret " *shared_secret* "

Specifies the RADIUS secret key used by this server. The shared secret should have the same characteristics as a normal password.

set radius alt-radius-name " *server_name_string* "

Specifies an alternate RADIUS server name or IP address to be used if the primary server is unreachable.

set radius alt-radius-secret " *shared_secret* "

Specifies the secret key used by the alternate RADIUS server.

set radius radius-port *port_number*

Specifies the port on which the RADIUS server is listening. The default value is 1812.

VLAN Settings

You can create up to 8 VLANs, and you can also restrict any VLAN, and the computers on it, from administering the Gateway. See [“VLAN” on page 107](#) for more information.

set vlan name *name*

Sets the descriptive name for the VLAN. If no name is specified, displays a selection list of node names to select for editing. Once a new VLAN name is specified, presents the list of VLAN characteristics to define.

set vlan name *name* type [*by-port* | *global*]

Specifies VLAN **type**: **by-port** or **global**. Default is **by-port**.

set vlan name *name* id *VID*

Specifies VLAN **id** (VID), when type is set to **global**. The numerical range of possible VIDs is 1 - 4094. (A VID of zero (0) is permitted on the Ethernet WAN port only.)

set vlan name *name* admin-restricted [*off* | *on*]

Turns **admin-restricted** **off** or **on**. Default is **off**. If you select **on**, administrative access to the Gateway is blocked from the specified VLAN.

set vlan name *name* seg-pbits [*0* - *7*]

Specifies the 802.1p priority bit. If you set this to a value greater than 0, all packets of this VLAN with unmarked priority bits (pbits) will be re-marked to this priority.

set vlan name *name* ports *port* option [*off* | *on*]

Enables or disables the Gateway's physical Ethernet, USB or VCC **port** or wireless SSID for the specified VLAN.

set vlan name *name* ports *port* tag [*off* | *on*]

If set to **on**, packets transmitted from this port through this VLAN must be tagged with the VLAN VID. Packets received through this port destined for this VLAN must be tagged with the VLAN VID by the source. The **tag** option is only available on **global** type ports.

set vlan name *name* ports *port* priority [*off* | *on*]

Enables or disables the **priority** for the port assigned to the specified VLAN allowing packet prioritization based on any 802.1p priority bits in the VLAN header to prioritize packets within the Gateway's internal queues, according to DiffServ priority mapping rules.

set vlan name *name* ports *port* promote [*off* | *on*]

Enables or disables the **promote** setting allowing writing any 802.1p priority bits into the IP-TOS header bit field for received IP packets on this port destined for this VLAN. Write any IP-TOS priority bits into the

802.1p priority bit field for tagged IP packets transmitted from this port for this VLAN. All mappings between Ethernet 802.1p and IP-TOS are made via **diffserv dscp-map** settings.

set vlan name *name* ports *port* port-pbits [0 - 7]

Specifies the 802.1p priority bit for this port associated with the specified VLAN. If you set this to a value greater than 0, all packets of this port with unmarked priority bits (pbits) will be re-marked to this priority.

set vlan name *name* ip-interface *ip_interface*

Associates this VLAN with the specified IP interface. By default the **ip-vcc1** and **ip-eth-a** interfaces are available, but others may be defined.

set vlan name *name* inter-vlan-routing [group-1... group-8] [off | on]

When set to **on**, **inter-vlan-routing** allows VLANs in the specified group to route traffic to the others; ungrouped VLANs cannot route traffic to each other.

You must save the changes, exit out of configuration mode, and restart the Gateway for the changes to take effect.

Example 1:

- A simple example using the “Step” method – Navigate to the VLAN item:

```
Netopia-3000/9437188 (top)>> vlan
Netopia-3000/9437188 (vlan)>> set
vlan

(vlan) node list ...
Select (name) node to modify from list,
or enter new (name) to create.
vlan name (?): vlan1
(vlan1) has been added to the (vlan) list
name "vlan1"
type (by-port) [ by-port | global ]: by-port
admin-restricted (off) [ off | on ]: off
seg-pbits (0) [ 0 - 7 ]: 0
ports
```

- At this point you have created a VLAN. It is called **vlan1**, without any admin restrictions.
- Next, add the port **eth0.1** port to this VLAN:

```
ports
eth0.1
option (off) [ off | on ]: on
priority (off) [ off | on ]: on
promote (off) [ off | on ]: on
port-pbits (0) [ 0 - 7 ]: 1
eth0.2
option (off) [ off | on ]:
eth0.3
option (off) [ off | on ]:
eth0.4
option (off) [ off | on ]:
ssid1
```

```
option (off) [ off | on ]:  
vcc1  
option (off) [ off | on ]:
```

- Assign an IP interface:

```
ip-vcc1  
option (off) [ off | on ]:  
ip-eth-a  
option (off) [ off | on ]: on  
ipsec-mgmt1  
option (off) [ off | on ]:  
Netopia-3000/9437188 (vlan)>>
```

Example 2:

- An example of a “Triple-Play” setup:

```
set vlan name "LanPorts" type by-port  
set vlan name "LanPorts" admin-restricted off  
set vlan name "LanPorts" seg-pbits 0  
set vlan name "LanPorts" ports eth0.1 option off  
set vlan name "LanPorts" ports eth0.2 option on  
set vlan name "LanPorts" ports eth0.2 priority off  
set vlan name "LanPorts" ports eth0.2 promote off  
set vlan name "LanPorts" ports eth0.2 port-pbits 0  
set vlan name "LanPorts" ports eth0.3 option on  
set vlan name "LanPorts" ports eth0.3 priority off  
set vlan name "LanPorts" ports eth0.3 promote off  
set vlan name "LanPorts" ports eth0.3 port-pbits 0  
set vlan name "LanPorts" ports eth0.4 option on  
set vlan name "LanPorts" ports eth0.4 priority off  
set vlan name "LanPorts" ports eth0.4 promote off  
set vlan name "LanPorts" ports eth0.4 port-pbits 0  
set vlan name "LanPorts" ports ssid1 option on  
set vlan name "LanPorts" ports ssid1 priority off  
set vlan name "LanPorts" ports ssid1 promote off  
set vlan name "LanPorts" ports ssid1 port-pbits 0  
set vlan name "LanPorts" ports eth1 option off  
set vlan name "LanPorts" ip-interfaces ip-ppp-a option off  
set vlan name "LanPorts" ip-interfaces ip-eth-b option off  
set vlan name "LanPorts" ip-interfaces ip-eth-c option off  
set vlan name "LanPorts" ip-interfaces ip-eth-a option on  
set vlan name "LanPorts" inter-vlan-routing group-1 on  
set vlan name "LanPorts" inter-vlan-routing group-2 off  
set vlan name "LanPorts" inter-vlan-routing group-3 off  
set vlan name "LanPorts" inter-vlan-routing group-4 off  
set vlan name "Voip_217" type global  
set vlan name "Voip_217" id 217  
set vlan name "Voip_217" admin-restricted off  
set vlan name "Voip_217" seg-pbits 7  
set vlan name "Voip_217" ports eth0.1 option off  
set vlan name "Voip_217" ports eth0.2 option off  
set vlan name "Voip_217" ports eth0.3 option off  
set vlan name "Voip_217" ports eth0.4 option off  
set vlan name "Voip_217" ports ssid1 option off  
set vlan name "Voip_217" ports eth1 option on  
set vlan name "Voip_217" ports eth1 tag on  
set vlan name "Voip_217" ports eth1 priority off  
set vlan name "Voip_217" ports eth1 promote off  
set vlan name "Voip_217" ports eth1 port-pbits 0  
set vlan name "Voip_217" ip-interfaces ip-ppp-a option off  
set vlan name "Voip_217" ip-interfaces ip-eth-b option on  
set vlan name "Voip_217" ip-interfaces ip-eth-c option off
```

```
set vlan name "Voip_217" ip-interfaces ip-eth-a option off
set vlan name "Voip_217" inter-vlan-routing group-1 on
set vlan name "Voip_217" inter-vlan-routing group-2 off
set vlan name "Voip_217" inter-vlan-routing group-3 off
set vlan name "Voip_217" inter-vlan-routing group-4 off
set vlan name "PPPoE_11" type global
set vlan name "PPPoE_11" id 11
set vlan name "PPPoE_11" admin-restricted off
set vlan name "PPPoE_11" seg-pbits 0
set vlan name "PPPoE_11" ports eth0.1 option off
set vlan name "PPPoE_11" ports eth0.2 option off
set vlan name "PPPoE_11" ports eth0.3 option off
set vlan name "PPPoE_11" ports eth0.4 option off
set vlan name "PPPoE_11" ports ssid1 option off
set vlan name "PPPoE_11" ports eth1 option on
set vlan name "PPPoE_11" ports eth1 tag on
set vlan name "PPPoE_11" ports eth1 priority off
set vlan name "PPPoE_11" ports eth1 promote off
set vlan name "PPPoE_11" ports eth1 port-pbits 0
set vlan name "PPPoE_11" ip-interfaces ip-ppp-a option on
set vlan name "PPPoE_11" ip-interfaces ip-eth-b option off
set vlan name "PPPoE_11" ip-interfaces ip-eth-c option off
set vlan name "PPPoE_11" ip-interfaces ip-eth-a option off
set vlan name "PPPoE_11" inter-vlan-routing group-1 on
set vlan name "PPPoE_11" inter-vlan-routing group-2 off
set vlan name "PPPoE_11" inter-vlan-routing group-3 off
set vlan name "PPPoE_11" inter-vlan-routing group-4 off
set vlan name "Mgmt_2017" type global
set vlan name "Mgmt_2017" id 2017
set vlan name "Mgmt_2017" admin-restricted off
set vlan name "Mgmt_2017" seg-pbits 3
set vlan name "Mgmt_2017" ports eth0.1 option off
set vlan name "Mgmt_2017" ports eth0.2 option off
set vlan name "Mgmt_2017" ports eth0.3 option off
set vlan name "Mgmt_2017" ports eth0.4 option off
set vlan name "Mgmt_2017" ports ssid1 option off
set vlan name "Mgmt_2017" ports eth1 option on
set vlan name "Mgmt_2017" ports eth1 tag on
set vlan name "Mgmt_2017" ports eth1 priority off
set vlan name "Mgmt_2017" ports eth1 promote off
set vlan name "Mgmt_2017" ports eth1 port-pbits 0
set vlan name "Mgmt_2017" ip-interfaces ip-ppp-a option off
set vlan name "Mgmt_2017" ip-interfaces ip-eth-b option off
set vlan name "Mgmt_2017" ip-interfaces ip-eth-c option on
set vlan name "Mgmt_2017" ip-interfaces ip-eth-a option off
set vlan name "Mgmt_2017" inter-vlan-routing group-1 off
set vlan name "Mgmt_2017" inter-vlan-routing group-2 off
set vlan name "Mgmt_2017" inter-vlan-routing group-3 off
set vlan name "Mgmt_2017" inter-vlan-routing group-4 off
set vlan name "Video_31" type global
set vlan name "Video_31" id 31
set vlan name "Video_31" admin-restricted off
set vlan name "Video_31" seg-pbits 5
set vlan name "Video_31" ports eth0.1 option on
set vlan name "Video_31" ports eth0.1 tag off
set vlan name "Video_31" ports eth0.1 priority off
set vlan name "Video_31" ports eth0.1 promote off
set vlan name "Video_31" ports eth0.1 port-pbits 0
set vlan name "Video_31" ports eth0.2 option off
set vlan name "Video_31" ports eth0.3 option off
set vlan name "Video_31" ports eth0.4 option off
set vlan name "Video_31" ports ssid1 option off
set vlan name "Video_31" ports eth1 option on
```

```
set vlan name "Video_31" ports eth1 tag on
set vlan name "Video_31" ports eth1 priority off
set vlan name "Video_31" ports eth1 promote off
set vlan name "Video_31" ports eth1 port-pbits 0
set vlan name "Video_31" ip-interfaces ip-ppp-a option off
set vlan name "Video_31" ip-interfaces ip-eth-b option off
set vlan name "Video_31" ip-interfaces ip-eth-c option off
set vlan name "Video_31" ip-interfaces ip-eth-a option off
set vlan name "Video_31" inter-vlan-routing group-1 off
set vlan name "Video_31" inter-vlan-routing group-2 off
set vlan name "Video_31" inter-vlan-routing group-3 off
set vlan name "Video_31" inter-vlan-routing group-4 off
```

You must save the changes, exit out of configuration mode, and restart the Gateway for the changes to take effect.

VoIP settings

(supported models only)

Voice-over-IP (VoIP) refers to the ability to make voice telephone calls over the Internet. This differs from traditional phone calls that use the Public Switched Telephone Network (PSTN). VoIP calls use an Internet protocol, Session Initiation Protocol (SIP), to transmit sound over a network or the Internet in the form of data packets. Certain Motorola Netopia® Gateway models have two separate voice ports for connecting telephone handsets. These models support VoIP. If your Gateway is a VoIP model, you can configure the VoIP features.

set voip phone [0 | 1] sip-option [off | on]

Turns SIP on or off for the specified phone. Default is **off**.

set voip phone [0 | 1] sip-proxy-server [*server_name* | *ip_address*]

Specifies the SIP proxy server for the specified phone by fully qualified server name or IP address.

set voip phone [0 | 1] sip-proxy-server-domain *domain_name*

Specifies the SIP proxy server domain name or IP address for the specified phone.

set voip phone [0 | 1] sip-proxy-server-transport [UDP | TCP | TLS]

Specifies the SIP proxy server transport protocol for the specified phone. Default is **UDP**.

set voip phone [0 | 1] sip-registrar-setting sip-registrar-server [*server_name* | *ip_address*]

Specifies the SIP registration server for the specified phone by fully qualified server name or IP address.

set voip phone [0 | 1] sip-registrar-setting sip-registrar-server-transport [UDP | TCP | TLS]

Specifies the SIP registration server transport protocol for the specified phone . Default is **UDP**.

set voip phone [0 | 1] sip-registrar-setting sip-expires-time [0 - 65535]

Specifies the SIP registration server time-out duration from 0 – 65535 seconds for the specified phone. Default is **3600** (1 hour).

set voip phone [0 | 1] sip-out-proxy-server [*server_name* | *ip_address*]

Specifies the SIP outbound proxy server for the specified phone by fully qualified server name or IP address.

set voip phone [0 | 1] sip-user-display-name *name*

Specifies the user name that is displayed on the web UI Home page, or other caller-id displays for the specified phone.

set voip phone [0 | 1] sip-user-name *username*

Specifies the user name that authenticates the user to SIP for the specified phone.

set voip phone [0 | 1] sip-user-password *password*

Specifies the password that authenticates the user to SIP for the specified phone.

set voip phone [0 | 1] auth-id *string*

Specifies the authorization ID that authenticates the user to SIP for the specified phone. Most SIP Servers expect this to be the username itself but some may use **auth-id**.

**set voip phone [0 | 1] codec G711A priority
[1 | 2 | 3 | 4 | 5 | 6 | 7 | none]**

Assigns a priority to the **alaw** codec, the common analog voice encoding method used *outside* North America.

**set voip phone [0 | 1] codec G711U priority
[1 | 2 | 3 | 4 | 5 | 6 | 7 | none]**

Assigns a priority to the **ulaw** codec, the common analog voice encoding method used *in* North America.

**set voip phone [0 | 1] codec G729A priority
[1 | 2 | 3 | 4 | 5 | 6 | 7 | none]**

Assigns a priority to the **G729 annex A** codec, the common analog voice compression implementation used in North America.

**set voip phone [0 | 1] codec G726_16 priority
[1 | 2 | 3 | 4 | 5 | 6 | 7 | none]**

Assigns a priority to the **G726-16** codec, a common audio media type implementation at 16 kbit/s.

**set voip phone [0 | 1] codec G726_24 priority
[1 | 2 | 3 | 4 | 5 | 6 | 7 | none]**

Assigns a priority to the **G726-24** codec, a common audio media type implementation at 24 kbit/s.

**set voip phone [0 | 1] codec G726_32 priority
[1 | 2 | 3 | 4 | 5 | 6 | 7 | none]**

Assigns a priority to the **G726-32** codec, a common audio media type implementation at 32 kbit/s.

```
set voip phone [ 0 | 1 ] codec G726_40 priority
[ 1 | 2 | 3 | 4 | 5 | 6 | 7 | none ]
```

Assigns a priority to the **G726-40** codec, a common audio media type implementation at 40 kbit/s.

```
set voip phone [ 0 | 1 ] sip-advanced-setting sip-dtmf-mode
[ inband | rfc2833 | info ]
```

sip-dtmf-mode – sets the Dual Tone Multi-Frequency Mode:

- **inband**: sends the DTMF digits as a normal inband tone.
- **rfc2833**: sends the DTMF digits as an event as part of the RTP packet header information.
- **info**: sends the DTMF digits in the SIP INFO message.

```
set voip phone [ 0 | 1 ] sip-advanced-setting sip-end-of-dial-marker
[ off | on ]
```

sip-end-of-dial-marker – turns an “end of dial” (#) signal that indicates that the dialed number is complete **on** or **off**.

```
set voip phone [ 0 | 1 ] sip-advanced-setting call-feature
call-forwarding-all-option [ off | on ]
```

call-forwarding-all-option – turns unconditional call forwarding **on** or **off**.

```
set voip phone [ 0 | 1 ] sip-advanced-setting call-feature
call-forwarding-all-number phone_number
```

call-forwarding-all-number – specifies the number to which calls are to be forwarded when **call-forwarding-all-option** is **on**.

```
set voip phone [ 0 | 1 ] sip-advanced-setting call-feature
call-forwarding-on-busy-option [ off | on ]
```

call-forwarding-on-busy-option – turns call forwarding when the line is busy **on** or **off**.

```
set voip phone [ 0 | 1 ] sip-advanced-setting call-feature
call-forwarding-on-no-answer-option [ off | on ]
```

call-forwarding-on-no-answer-option – turns call forwarding when there is no answer **on** or **off**.

```
set voip phone [ 0 | 1 ] sip-advanced-setting call-feature
call-forwarding-on-no-answer-number phone_number
```

call-forwarding-on-no-answer-number – specifies the number to which calls are to be forwarded when **call-forwarding-on-no-answer-option** is **on**.

**set voip phone [0 | 1] sip-advanced-setting call-feature
call-waiting-option [off | on]**

call-waiting-option – enables or disables call waiting.

**set voip phone [0 | 1] sip-advanced-setting call-feature
call-conferencing-option [off | on]**

call-conferencing-option – enables or disables 3-way call conferencing.

**set voip phone [0 | 1] sip-advanced-setting call-feature
subscribe-do-not-disturb-option [off | on]**

subscribe-do-not-disturb-option – enables or disables option to prevent the phone from ringing.

**set voip phone [0 | 1] sip-advanced-setting call-feature
subscribe-mwi-option [off | on]**

subscribe-mwi-option – if set to **on**, the Message Waiting Indicator is enabled when new voice mail is received.

**set voip phone [0 | 1] sip-advanced-setting dsp-settings echo-option
[echo-off | echo-on | echo-on-nlp | echo-on-cng-nlp]**

echo-option – specifies under what conditions the system invokes or disables echo cancellation. Default is **echo-on-cng-nlp** (Comfort Noise Generation with non-linear processor).

**set voip phone [0 | 1] sip-advanced-setting dsp-settings
echo-start-attenuation [0 - 65535]**

echo-start-attenuation – specifies the minimum attenuation level at which to invoke echo cancellation. Default is **8192**.

**set voip phone [0 | 1] sip-advanced-setting dsp-settings
echo-max-attenuation [0 - 65535]**

echo-max-attenuation – specifies the maximum attenuation level at which to invoke echo cancellation. Default is **16384**.

**set voip phone [0 | 1] sip-advanced-setting dsp-settings
echo-tail-length [0 - 65535]**

echo-tail-length – specifies the duration of an echo tail required to invoke cancellation. Default is **0**.

**set voip phone [0 | 1] sip-advanced-setting dsp-settings
vad-option [off | on]**

vad-option – turns Voice Activity Detection on or off. Default is **off**.

set voip phone [0 | 1] sip-advanced-setting dsp-settings vad-setting [vad-cn | vad-std-sid | vad-suppress-sid]

When **vad-option** is set to **on**:

- **vad-cn** – enables Voice Activity Detection/Comfort Noise Generation. When speech is not present, the CNG algorithm generates a noise signal at the level sent from the transmit side.
- **vad-std-sid** – enables Voice Activity Detection with standard Silence Insertion Descriptor support.
- **vad-suppress-sid** – enables Voice Activity Detection but suppresses standard Silence Insertion Descriptor support.

Example

```
set voip phone: 0 sip-option on
set voip phone: 0 sip-proxy-server "10.3.1.129"
set voip phone: 0 sip-proxy-server-domain ""
set voip phone: 0 sip-proxy-server-transport UDP
set voip phone: 0 sip-registrar-setting sip-registrar-server "10.3.1.129"
set voip phone: 0 sip-registrar-setting sip-registrar-server-transport UDP
set voip phone: 0 sip-registrar-setting sip-expires-time 3600
set voip phone: 0 sip-out-proxy-server "10.3.1.129"
set voip phone: 0 sip-user-display-name "4004"
set voip phone: 0 sip-user-name "4004"
set voip phone: 0 sip-user-password "4004"
set voip phone: 0 auth-id "4004"
set voip phone: 0 codec G711A priority 1
set voip phone: 0 codec G711U priority 2
set voip phone: 0 codec G729A priority 3
set voip phone: 0 codec G726_16 priority 4
set voip phone: 0 codec G726_24 priority 5
set voip phone: 0 codec G726_32 priority 6
set voip phone: 0 codec G726_40 priority 7
set voip phone: 0 sip-advanced-setting sip-dtmf-mode rfc2833
set voip phone: 0 sip-advanced-setting sip-end-of-dial-marker off
set voip phone: 0 sip-advanced-setting call-feature call-forwarding-all-option off
set voip phone: 0 sip-advanced-setting call-feature call-forwarding-on-busy-option off
set voip phone: 0 sip-advanced-setting call-feature call-forwarding-on-no-answer-option off
set voip phone: 0 sip-advanced-setting call-feature call-waiting-option off
set voip phone: 0 sip-advanced-setting call-feature call-conferencing-option off
set voip phone: 0 sip-advanced-setting call-feature subscribe-do-not-disturb-option off
set voip phone: 0 sip-advanced-setting call-feature subscribe-mwi-option off
set voip phone: 0 sip-advanced-setting dsp-settings echo-option echo-on-cng-nlp
set voip phone: 0 sip-advanced-setting dsp-settings echo-start-attenuation 8192
set voip phone: 0 sip-advanced-setting dsp-settings echo-max-attenuation 16384
set voip phone: 0 sip-advanced-setting dsp-settings echo-tail-length 0
set voip phone: 0 sip-advanced-setting dsp-settings vad-option off
set voip phone: 1 sip-option on
set voip phone: 1 sip-proxy-server "10.3.1.129"
set voip phone: 1 sip-proxy-server-domain ""
set voip phone: 1 sip-proxy-server-transport UDP
set voip phone: 1 sip-registrar-setting sip-registrar-server "10.3.1.129"
set voip phone: 1 sip-registrar-setting sip-registrar-server-transport UDP
set voip phone: 1 sip-registrar-setting sip-expires-time 3600
set voip phone: 1 sip-out-proxy-server "10.3.1.129"
set voip phone: 1 sip-user-display-name "4005"
set voip phone: 1 sip-user-name "4005"
set voip phone: 1 sip-user-password "4005"
set voip phone: 1 auth-id "4005"
set voip phone: 1 codec G711A priority 1
```

```
set voip phone: 1 codec G711U priority 2
set voip phone: 1 codec G729A priority 3
set voip phone: 1 codec G726_16 priority 4
set voip phone: 1 codec G726_24 priority 5
set voip phone: 1 codec G726_32 priority 6
set voip phone: 1 codec G726_40 priority 7
set voip phone: 1 sip-advanced-setting sip-dtmf-mode rfc2833
set voip phone: 1 sip-advanced-setting sip-end-of-dial-marker off
set voip phone: 1 sip-advanced-setting call-feature call-forwarding-all-option off
set voip phone: 1 sip-advanced-setting call-feature call-forwarding-on-busy-option off
set voip phone: 1 sip-advanced-setting call-feature call-forwarding-on-no-answer-option off
set voip phone: 1 sip-advanced-setting call-feature call-waiting-option off
set voip phone: 1 sip-advanced-setting call-feature call-conferencing-option off
set voip phone: 1 sip-advanced-setting call-feature subscribe-do-not-disturb-option off
set voip phone: 1 sip-advanced-setting call-feature subscribe-mwi-option off
set voip phone: 1 sip-advanced-setting dsp-settings echo-option echo-on-cng-nlp
set voip phone: 1 sip-advanced-setting dsp-settings echo-start-attenuation 8192
set voip phone: 1 sip-advanced-setting dsp-settings echo-max-attenuation 16384
set voip phone: 1 sip-advanced-setting dsp-settings echo-tail-length 0
set voip phone: 1 sip-advanced-setting dsp-settings vad-option off
```

UPnP settings

set upnp option [on | off]

PCs using UPnP can retrieve the Gateway's WAN IP address, and automatically create NAT port maps. This means that applications that support UPnP, and are used with a UPnP-enabled Motorola Netopia® Gateway, will not need application layer gateway support on the Motorola Netopia® Gateway to work through NAT. The default is **on**.

You can disable UPnP, if you are not using any UPnP devices or applications.

set upnp log [off | on]

Enables or disables UPnP logging.

set upnp read-only [off | on]

Enables or disables

DSL Forum settings

TR-064 is a LAN-side DSL CPE configuration specification and TR-069 is a WAN-side DSL CPE Management specification.

TR-064

DSL Forum LAN Side CPE Configuration (TR-064) is an extension of UPnP. It defines more services to locally manage the Motorola Netopia® Gateway. While UPnP allows open access to configure the Gateway's features, TR-064 requires a password to execute any command that changes the Gateway's configuration.

set dslf-lanmgmt option [off | on]

Turns TR-064 LAN side management services on or off. The default is **on**.

TR-069

DSL Forum CPE WAN Management Protocol (TR-069) provides services similar to UPnP and TR-064. The communication between the Motorola Netopia® Gateway and management agent in UPnP and TR-064 is strictly over the LAN, whereas the communication in TR-069 is over the WAN link for some features and over the LAN for others. TR-069 allows a remote Auto-Config Server (ACS) to provision and manage the Motorola Netopia® Gateway. TR-069 protects sensitive data on the Gateway by not advertising its presence, and by password protection.

set dslf-cpewan option [off | on]

set dslf-cpewan acs-url "*acs_url:port_number*"

set dslf-cpewan acs-user-name "*acs_username*"

set dslf-cpewan acs-user-password "*acs_password*"

Turns TR-069 WAN side management services on or off. For 3300-Series Gateways, the default is **off**; for 2200-Series Gateways, the default is **on**. If TR-069 WAN side management services are enabled, specifies the auto-config server URL and port number. A username and password must also be supplied, if TR-069 is enabled.

The auto-config server is specified by URL and port number. The format for the ACS URL is as follows:

http://some_url.com:port_number

or

http://123.45.678.910:port_number

On units that support SSL, the format for the ACS URL can also be:

https://some_url.com:port_number

or

https://123.45.678.910:port_number

Backup IP Gateway Settings

The purpose of Backup is to provide a recovery mechanism in the event that the primary connection fails. Should the primary WAN connection fail, traffic would be automatically redirected through your alternate gateway device to maintain Internet connectivity. See [“Backup” on page 133](#) for more information.

set backup option [disabled | manual | automatic]

Specifies whether backup to an IP gateway is **disabled** or enabled as **manual** or **automatic**. Default is **disabled**.

set backup failure-timeout [1 - 10]

Specifies the number of minutes you want the system to wait before the backup port becomes enabled in the event of primary line failure, when **backup option** is set to **automatic**. Sets the Default is **1**.

set backup ping-host [1 | 2] [name | address]

Specifies whether the Gateway will ping an IP address or resolvable DNS name, when **backup option** is set to **automatic**. These are optional items that are particularly useful for testing if the remote end of a VPN connection has gone down.

The Gateway will ping both addresses simultaneously at five-second intervals, recording the ping responses from each host. The Gateway will proceed into backup mode only if neither of the configured remote hosts responds.

set backup ping-host [1 | 2] [name *hostname* | ip-address *ip_address*]

Specifies an IP address or resolvable DNS name for the Gateway to ping.

set backup auto-recovery [off | on]

Turns automatic recovery **off** or **on**. Default is **off**.

set backup recovery-timeout [1 - 10]

If **auto-recovery** is set to **on**, specifies the number of minutes for the system to wait before attempting to switch back to the WAN connection. This allows you to be sure that the WAN connection is well re-established before the gateway switches back to it from the backup mode. Default is **1**.

set ip backup-gateway option [on | off]

Turns the backup gateway option **on** or **off**. Default is **off**.

set ip backup-gateway interface ip-address

Specifies the backup gateway interface ip address to which you want to direct the backup connection.

set ip backup-gateway default *ip_address*

Specifies the ip address of the default gateway.

VDSL Settings



CAUTION!

These settings are for very advanced users and lab technicians. Exercise extreme caution when modifying any of these settings.

```
set vdsl sys-option [ 0x00 - 0xff ]
  sys-bandplan [ 0x00 - 0xff ]
  psd-mask-level [ 0x00 - 0xff ]
  pbo-k1_1 [ 0x00000000 - 0xffffffff ]
  pbo-k1_2 [ 0x00000000 - 0xffffffff ]
  pbo-k1_3 [ 0x00000000 - 0xffffffff ]
  pbo-k2_1 [ 0x00000000 - 0xffffffff ]
  pbo-k2_2 [ 0x00000000 - 0xffffffff ]
  pbo-k2_3 [ 0x00000000 - 0xffffffff ]
  line-type [ 0x00 - 0xff ]
  us-max-inter-delay [ 0x00 - 0xff ]
  ds-max-inter-delay [ 0x00 - 0xff ]
  us-target-noise-margin [ 0x0000 - 0xffff ]
  ds-target-noise-margin [ 0x0000 - 0xffff ]
  min-noise-margin [ 0x0000 - 0xffff ]
  port-bandplan [ 0x00 - xff ]
  framing-mode [ 0x00 - 0xff ]
  band-mod [ 0x00 - 0xff ]
  port-option [ 0x00 - 0xff ]
  power-mode [ 0x00 - 0xff ]
  tx-filter [ 0x00 - 0xff ]
  rx-filter [ 0x00 - 0xff ]
  dying-gasp [ off | on ]
```

VDSL Parameter Defaults

Parameter	Default	Meaning
sys-option	0x00	VDSL system option(bit0=ntr, 1=margin, 2=ini, 3=pbo, 4=tlan, 5=pbo)
sys-bandplan	0x02	VDSL system bandplan(bp_3_998_4=2, bp4_997_3=3, bp5_997_3=4...)
psd-mask-level	0x00	VDSL system psd mask(def=0, 1=ansim1cab, 2=ansim2cab, 3=etsim1cab, 4=etsim2cab)
pbo-k1_1	0x00	VDSL system power back-off k1_1
pbo-k1_2	0x00	VDSL system power back-off k1_2
pbo-k1_3	0x00	VDSL system power back-off k1_3
pbo-k2_1	0x00	VDSL system power back-off k2_1
pbo-k2_2	0x00	VDSL system power back-off k2_2

VDSL Parameter Defaults

Parameter	Default	Meaning
pbo-k2_3	0x00	VDSL system power back-off k2_3
line-type	0x81	VDSL port line type(auto=0x80, vdsl=0x81, vdsl_etsi=0x82)
us-max-inter-delay	0x04	VDSL port upstream max inter delay
ds-max-inter-delay	0x04	VDSL port downstream max inter delay
us-target-noise-margin	0x0C	VDSL port upstream target noise margin
ds-target-noise-margin	0x0C	VDSL port downstream target noise margin
min-noise-margin	0x0A	VDSL port minimum noise margin
port-bandplan	0x02	VDSL port bandplan
framing-mode	0x90	DSL port frame mode(0-ATM; 0x80-PTM; 0x90-Auto(EFM/PTM))
band-mod	0x11	VDSL port band mod
port-option	0x0A - Annex B 0x06 - Annex A	VDSL port portoption(bit0=l43, bit1=v43, bit2=a43, bit3=b43)
power-mode	0x01	VDSL port power mode
tx-filter	0x02	VDSL port txPathFilterMode
rx-filter	0x02	VDSL port rxPathFilterMode
dying-gasp	off	Dying Gasp On/Off

VDSL Parameters Accepted Values

Parameter	Accepted Values
sys-option	Bit[0]: NTR_DISABLE Bit[1]: ALW_MARGIN_ADJUST. 1: the SNR margin for the optional band is reduced by up to 2.5 dB, but never below a minimum of 4 dB. Bit[2]: SUPPORT_INI Bit[4]: TLAN Enable Bit[5]: PBO Weak mode Enable (Applicable only when PBO Bit[3]=0. Bit[6]: ADSL_SAFE_MODE Enable Bit[7]: TLAN_SAFE_MODE Enable (Applicable only when TLAN Enable Bit[4] is set. If TLAN_SAFE_MODE not set, line will attempt to retrain at higher rates, but less stable line)
sys-bandplan	BP1_998_3 (0x00) BP2_998_3 (0x01) BP998_3B_8_5M (0x01) BP3_998_4 (0x02) BP998_4B_12M (0x02) BP4_997_3 (0x03) BP997_3B_7_1M (0x03) BP5_997_3 (0x04) BP6_997_4 (0x05) BP997_4B_7_1M (0x05) BP7_MXU_3 (0x06) FLEX_3B_8_5M (0x06) BP8_MXU_2 (0x07) BP9_998_2 (0x08) BP10_998_2 (0x09) BP998_2B_3_8M (0x09) BP11_998_2 (0x0A) BP12_998_2 (0x0B) BP13_MXU_3 (0x0C) BP14_MXU_3 (0x0D) BP15_MXU_3 (0x0E) BP16_997_4B_4P (0x0F) BP17_998_138_4400 (0x10) BP18_997_138_4400(0x11) BP19_997_32_4400(0x12) BP20_998_138_4400_opBand (0x15) BP21_997_138_4400_opBand (0x16) BP22_998_138_4400_opBand(0x16) BP23_998_138_16000 (0x17) BP24_998_3B_8KHZ (0x18) BP25_998_138_17600 (0x19) BP26_CH1_3 (0x1A) BP27_CH1_4 (0x1B)

VDSL Parameters Accepted Values

Parameter	Accepted Values
psd-mask-level	0x00 -- default mask (old gains from before) 0x01 -- ANSI M1 CAB 0x02 -- ANSI M2 CAB 0x03 -- ETSI M1 CAB 0x04 -- ETSI M2 CAB 0x05 -- ITU-T Annex F (Japan) 0x06 - ANSI M1 Ex 0x07 - ANSI M2 Ex 0x08 -- ETSI M1 Ex 0x09 - ETSI M2 Ex 0x0A - RESERVED 0x0B - PSD_K (Korean M1 FTTCab -59dBm/Hz)
pbo-k1_1	K1 and K2 parameters allow the user more flexibility in using Upstream Power Back-Off (UPBO) on CPE modem. Changing K1 and K2 values will affect the CPE TX PSD. Refer to VDSL standards for exact relation between K1, K2 parameters and TX PSD. There is an individual set of K1/K2 parameters associated with each upstream band in the PSD: Upstream Band 0 or Optional band, Upstream band 1, Upstream band 2 and Upstream Band 3. Setting all K2 parameters to 0 and all K1 to a high power level (ie low number) will essentially disable UPBO.
pbo-k1_2	
pbo-k1_3	
pbo-k2_1	
pbo-k2_2	
pbo-k2_3	
line-type	VDSL_AUTO_DETECT – (0x80) VDSL – (0x81) VDSL_ETSI – (0x82)
us-max-inter-delay	Maximum upstream interleave delay. Provisioned in steps of 0.5 ms. User defined.
ds-max-inter-delay	Maximum downstream interleave delay. Provisioned in steps of 0.5 ms. User defined.
us-target-noise-margin	Range 0-31.0dB, increments of 0.5dB (e.g., 0 = 0dB, 1 = 0.5dB, ...)
ds-target-noise-margin	Range 0-31.0dB, increments of 0.5dB (e.g., 0 = 0dB, 1 = 0.5dB, ...)
min-noise-margin	Range 0-31.0dB, increments of 0.5dB (e.g., 0 = 0dB, 1 = 0.5dB, ...)

VDSL Parameters Accepted Values

Parameter	Accepted Values
port-bandplan	BP1_998_3 (0x00)
	BP2_998_3 (0x01)
	BP998_3B_8_5M (0x01)
	BP3_998_4 (0x02)
	BP998_4B_12M (0x02)
	BP4_997_3 (0x03)
	BP997_3B_7_1M (0x03)
	BP5_997_3 (0x04)
	BP6_997_4 (0x05)
	BP997_4B_7_1M (0x05)
	BP7_MXU_3 (0x06)
	FLEX_3B_8_5M (0x06)
	BP8_MXU_2 (0x07)
	BP9_998_2 (0x08)
	BP10_998_2 (0x09)
	BP998_2B_3_8M (0x09)
	BP11_998_2 (0x0A)
	BP12_998_2 (0x0B)
	BP13_MXU_3 (0x0C)
	BP14_MXU_3 (0x0D)
	BP15_MXU_3 (0x0E)
	BP16_997_4B_4P (0x0F)
	BP17_998_138_4400 (0x10)
	BP18_997_138_4400(0x11)
	BP19_997_32_4400(0x12)
	BP20_998_138_4400_opBand (0x15)
	BP21_997_138_4400_opBand (0x16)
BP22_998_138_4400_opBand(0x16)	
BP23_998_138_16000 (0x17)	
BP24_998_3B_8KHZ (0x18)	
BP25_998_138_17600 (0x19)	
BP26_CH1_3 (0x1A)	
BP27_CH1_4 (0x1B)	
framing-mode	HDLC – 0x80
	AUTO – 0x90
	ATM – 0x00

VDSL Parameters Accepted Values

Parameter	Accepted Values
band-mod	<p>Bit 0, 1: Tx Cfg band</p> <p>1- All tones on</p> <p>2- All tones below 640 Khz are turned off</p> <p>3- All tones below 1.1 Mhz are turned off</p> <p>Bit 2,3: Not used</p> <p>Bit 4,5: Rx Cfg band</p> <p>1- All tones on</p> <p>2- All tones below 640 Khz are turned off</p> <p>3- All tones below 1.1 Mhz are turned off</p> <p>Bit 6, 7:Optional band</p> <p>0- No Optional band</p> <p>1- ANNEX_A_6_32 (ie. 25KHz to 138 KHz)</p> <p>2- ANNEX_B_32_64 (ie. 138 KHz to 276 KHz)</p> <p>3- ANNEX_B_6_64 (ie. 25KHz to 276 KHz)</p>
port-option	<p>Bit [0]: I 43 G.hs carrier set.</p> <p>Bit [1]: V 43 G.hs carrier set.</p> <p>Bit [2]. A 43 G.hs carrier set.</p> <p>Bit [3]: B 43 G.hs carrier set.</p> <p>Bit[4:7]: shall be set to 0.</p>
power-mode	<p>0: 8.5dBm power output</p> <p>1: 11.5 dBm power output</p>
tx-filter	<p>0: using internal filter in Tx path</p> <p>1: using K1 external filter in Tx path (for Korea VLR Application)</p> <p>2: using U1 external filter in Tx path (for US / Korea VLR Application)</p> <p>3: using H1 external filter in Tx path (for 100/100 Application)</p>
rx-filter	<p>0: using internal filter in Rx path</p> <p>1: using K1 external filter in Rx path (for Korea VLR Application)</p> <p>2: using U1 external filter in Rx path (for US / Korea VLR Application)</p> <p>3: using H1 external filter in Rx path (for 100/100 Application)</p>
dying-gasp	<p>Dying Gasp is a message sent from CPE to CO using the indicator bit. It indicates that the CPE is experiencing an impending loss of power.</p> <p>Off: Dying Gasp off (don't send a message to CO).</p> <p>On: Dying Gasp on.</p>

CHAPTER 7 *Glossary*

10Base-T. IEEE 802.3 specification for Ethernet that uses unshielded twisted pair (UTP) wiring with RJ-45 eight-conductor plugs at each end. Runs at 10 Mbps.

100Base-T. IEEE 802.3 specification for Ethernet that uses unshielded twisted pair (UTP) wiring with RJ-45 eight-conductor plugs at each end. Runs at 100 Mbps.

-----A-----

ACK. Acknowledgment. Message sent from one network device to another to indicate that some event has occurred. See NAK.

access rate. Transmission speed, in bits per second, of the circuit between the end user and the network.

adapter. Board installed in a computer system to provide network communication capability to and from that computer system.

address mask. See subnet mask.

ADSL. Asymmetric Digital Subscriber Line. Modems attached to twisted pair copper wiring that transmit 1.5-9 Mbps downstream (to the subscriber) and 16 -640 kbps upstream, depending on line distance. (Downstream rates are usually lower than 1.5Mbps in practice.)

AH. The **A**uthentication **H**header provides data origin authentication, connectionless integrity, and anti-replay protection services. It protects all data in a datagram from tampering, including the fields in the header that do not change in transit. Does not provide confidentiality.

ANSI. American National Standards Institute.

ASCII. American Standard Code for Information Interchange (pronounced ASK-ee). Code in which numbers from 0 to 255 represent individual characters, such as letters, numbers, and punctuation marks; used in text representation and communication protocols.

asynchronous communication. Network system that allows data to be sent at irregular intervals by preceding each octet with a start bit and following it with a stop bit. Compare synchronous communication.

Auth Protocol. Authentication Protocol for IP packet header. The three parameter values are None, Encapsulating Security Payload (ESP) and Authentication Header (AH).

-----B-----

backbone. The segment of the network used as the primary path for transporting traffic between network segments.

baud rate. Unit of signaling speed equal to the number of number of times per second a signal in a communications channel varies between states. Baud is synonymous with bits per second (bps) if each signal represents one bit.

binary. Numbering system that uses only zeros and ones.

bps. Bits per second. A measure of data transmission speed.

BRI. Basic Rate Interface. ISDN standard for provision of low-speed ISDN services (two B channels (64 kbps each) and one D channel (16 kbps)) over a single wire pair.

bridge. Device that passes packets between two network segments according to the packets' destination address.

broadcast. Message sent to all nodes on a network.

broadcast address. Special IP address reserved for simultaneous broadcast to all network nodes.

buffer. Storage area used to hold data until it can be forwarded.

-----C-----

carrier. Signal suitable for transmission of information.

CCITT. Comité Consultatif International Télégraphique et Téléphonique or Consultative Committee for International Telegraph and Telephone. An international organization responsible for developing telecommunication standards.

CD. Carrier Detect.

CHAP. Challenge-Handshake Authentication Protocol. Security protocol in PPP that prevents unauthorized access to network services. See RFC 1334 for PAP specifications Compare PAP.

client. Network node that requests services from a server.

CPE. Customer Premises Equipment. Terminating equipment such as terminals, telephones and modems that connects a customer site to the telephone company network.

CO. Central Office. Typically a local telephone company facility responsible for connecting all lines in an area.

compression. Operation performed on a data set that reduces its size to improve storage or transmission rate.

CPIP. Carrier Pigeon Internet Protocol. RFC 1149 - Standard for the transmission of IP datagrams on avian carriers. The IP datagram is printed, on a small scroll of paper, in hexadecimal, with each octet separated by whitestuff and blackstuff. The scroll of paper is wrapped around one leg of the avian carrier. A band of duct tape is used to secure the datagram's edges. The bandwidth is limited to the leg length. The MTU is variable, and paradoxically, generally increases with increased carrier age. A typical MTU is 256 milligrams. Some datagram padding may be needed. Upon receipt, the duct tape is removed and the paper copy of the datagram is optically scanned into an electronically transmittable form.

crossover cable. Cable that lets you connect a port on one Ethernet hub to a port on another Ethernet hub. You can order an Ethernet crossover cable from Netopia, if needed.

CSU/DSU. Channel Service Unit/Data Service Unit. Device responsible for connecting a digital circuit, such as a T1 link, with a terminal or data communications device.

-----D-----

data bits. Number of bits used to make up a character.

datagram. Logical grouping of information sent as a network-layer unit. Compare frame, packet.

DCE. Digital Communication Equipment. Device that connects the communication circuit to the network end node (DTE). A modem and a CSU/DSU are examples of a DCE.

dedicated line. Communication circuit that is used exclusively to connect two network devices. Compare dial on demand.

DES. Data Encryption Standard is a 56-bit encryption algorithm developed by the U.S. National Bureau of Standards (now the National Institute of Standards and Technology).

3DES. Triple DES, with a 168 bit encryption key, is the most accepted variant of DES.

DH Group. Diffie-Hellman is a public key algorithm used between two systems to determine and deliver secret keys used for encryption. Groups 1, 2 and 5 are supported. Also, see Diffie-Hellman listing.

DHCP. Dynamic Host Configuration Protocol. A network configuration protocol that lets a router or other device assign IP addresses and supply other network configuration information to computers on your network.

dial on demand. Communication circuit opened over standard telephone lines when a network connection is needed.

Diffie-Hellman. A group of key-agreement algorithms that let two computers compute a key independently without exchanging the actual key. It can generate an unbiased secret key over an insecure medium.

diffserv. Differentiated Services. A method for controlling Quality of Service (QoS) queue priority settings. It allows a Gateway to make Quality of Service (QoS) decisions about what path Internet traffic, such as Voice over IP (VoIP), should travel across your network.

domain name. Name identifying an organization on the Internet. Domain names consists of sets of characters separated by periods (dots). The last set of characters identifies the type of organization (.GOV, .COM, .EDU) or geographical location (.US, .SE).

domain name server. Network computer that matches host names to IP addresses in response to Domain Name System (DNS) requests.

Domain Name System (DNS). Standard method of identifying computers by name rather than by numeric IP address.

DSL. Digital Subscriber Line. Modems on either end of a single twisted pair wire that delivers ISDN Basic Rate Access.

DTE. Data Terminal Equipment. Network node that passes information to a DCE (modem) for transmission. A computer or router communicating through a modem is an example of a DTE device.

DTR. Data Terminal Ready. Circuit activated to indicate to a modem (or other DCE) that the computer (or other DTE) is ready to send and receive data.

dynamic DNS. Allows you to use the free services of *www.dyndns.org*. Dynamic DNS automatically directs any public Internet request for your computer's name to your current dynamically-assigned IP address.

-----E-----

echo interval. Frequency with which the router sends out echo requests.

encapsulation. Technique used to enclose information formatted for one protocol, such as AppleTalk, within a packet formatted for a different protocol, such as TCP/IP.

Encrypt Protocol. Encryption protocol for the tunnel session.

Parameter values supported include NONE or ESP.

encryption. The application of a specific algorithm to a data set so that anyone without the encryption key cannot understand the information.

ESP. Encapsulation Security Payload (ESP) header provides confidentiality, data origin authentication, connectionless integrity, anti-replay protection, and limited traffic flow confidentiality. It encrypts the contents of the datagram as specified by the Security Association. The ESP transformations encrypt and decrypt portions of datagrams, wrapping or unwrapping the datagram within another IP datagram. Optionally, ESP transformations may perform data integrity validation and compute an Integrity Check Value for the datagram being sent. The complete IP datagram is enclosed within the ESP payload.

Ethernet crossover cable. See crossover cable.

Ethernet OAM 802.3ah. 802.3ah Ethernet in the First Mile (EFM) **O**perations **A**dministration and **M**aintenance (OAM) is a group of network management functions that provide network fault indication, performance information, and diagnosis using special-purpose Ethernet OAM frames. These are exchanged between your Gateway and service provider Access Node (AN) devices for network fault management, performance analysis and fault isolation.

-----F-----

FCS. Frame Check Sequence. Data included in frames for error control.

flow control. Technique using hardware circuits or control characters to regulate the transmission of data between a computer (or other DTE) and a modem (or other DCE). Typically, the modem has buffers to hold data; if the buffers approach capacity, the modem signals the computer to stop while it catches up on processing the data in the buffer. See CTS, RTS, xon/xoff.

fragmentation. Process of breaking a packet into smaller units so that they can be sent over a network medium that cannot transmit the complete packet as a unit.

frame. Logical grouping of information sent as a link-layer unit. Compare datagram, packet.

FTP. File Transfer Protocol. Application protocol that lets one IP node transfer files to and from another node.

FTP server. Host on network from which clients can transfer files.

-----H-----

Hard MBytes. Setting the Hard MBytes parameter forces the renegotiation of the IPSec Security Associations (SAs) at the configured Hard MByte value.

The value can be configured between 1 and 1,000,000 MB and refers to data traffic passed.

Hard Seconds. Setting the Hard Seconds parameter forces the renegotiation of the IPSec Security Associations (SAs) at the configured Hard Seconds value. The value can be configured between 60 and 1,000,000 seconds.

A tunnel will start the process of renegotiation at the soft threshold and renegotiation *must* happen by the hard limit or traffic over the tunnel is terminated.

hardware handshake. Method of flow control using two control lines, usually Request to Send (RTS) and Clear to Send (CTS).

header. The portion of a packet, preceding the actual data, containing source and destination addresses and error-checking fields.

HMAC. Hash-based Message Authentication Code

hop. A unit for measuring the number of routers a packet has passed through when traveling from one network to another.

hop count. Distance, measured in the number of routers to be traversed, from a local router to a remote network. See metric.

hub. Another name for a repeater. The hub is a critical network element that connects everything to one centralized point. A hub is simply a box with multiple ports for network connections. Each device on the network is attached to the hub via an Ethernet cable.

-----I-----

IGMP. Internet **G**roup **M**anagement **P**rotocol allows a router to determine which host groups have members on a given network segment.

IKE. Internet **K**ey **E**xchange protocol provides automated key management and is a preferred alternative to manual key management as it provides better security. Manual key management is practical in a small, static environment of two or three sites. Exchanging the key is done through manual means. Because IKE provides automated key exchange, it is good for larger, more dynamic environments.

INSPECTION. The best option for Internet communications security is to have an SMLI firewall constantly inspecting the flow of traffic: determining direction, limiting or eliminating inbound access, and verifying down to the packet level that the network traffic is only what the customer chooses. The Netopia Gateway works like a network super traffic cop, inspecting and filtering out undesired traffic based on your security policy and resulting configuration.

interface. A connection between two devices or networks.

internet address. IP address. A 32-bit address used to route packets on a TCP/IP network. In dotted decimal notation, each eight bits of the 32-bit number are presented as a decimal number, with the four octets separated by periods.

IPCP. Internet Protocol Control Protocol. A network control protocol in PPP specifying how IP communications will be configured and operated over a PPP link.

IPSEC. A protocol suite defined by the Internet Engineering Task Force to protect IP traffic at packet level. It can be used for protecting the data transmitted by any service or application that is based on IP, but is commonly used for VPNs.

ISAKMP. Internet **S**ecurity **A**ssociation and **K**ey **M**anagement **P**rotocol is a framework for creating connection specific parameters. It is a protocol for establishing, negotiating, modifying, and deleting SAs and provides a framework for authentication and key exchange. ISAKMP is a part of the IKE protocol.

-----K-----

Key Management . The Key Management algorithm manages the exchange of security keys in the IPsec protocol architecture. SafeHarbour supports the standard *Internet Key Exchange (IKE)*

-----L-----

LCP. Link Control Protocol. Protocol responsible for negotiating connection configuration parameters, authenticating peers on the link, determining whether a link is functioning properly, and terminating the link. Documented in RFC 1331.

loopback test. Diagnostic procedure in which data is sent from a devices's output channel and directed back to its input channel so that what was sent can be compared to what was received.

-----M-----

magic number. Random number generated by a router and included in packets it sends to other routers. If the router receives a packet with the same magic number it is using, the router sends and receives packets with new random numbers to determine if it is talking to itself.

MD5. A 128-bit, **message-digest**, authentication algorithm used to create digital signatures. It computes a secure, irreversible, cryptographically strong hash value for a document. Less secure than variant SHA-1.

metric. Distance, measured in the number of routers a packet must traverse, that a packet must travel to go from a router to a remote network. A route with a low metric is considered more efficient, and therefore preferable, to a route with a high metric. See hop count.

modem. Modulator/demodulator. Device used to convert a digital signal to an analog signal for transmission over standard telephone lines. A modem at the other end of the connection converts the analog signal back to a digital signal.

MRU. Maximum Receive Unit. The maximum packet size, in bytes, that a network interface will accept.

MSSID. Multiple Service Set Identifier. Unique identifiers of data sent over a wireless connection that act as passwords when wireless devices try to join wireless networks. An SSID differentiates one wireless network from another, so all access points and all devices attempting to connect to a specific network must use the same SSID. Netopia Gateways support up to four SSIDs.

SSIDs are also sometimes referred to as *Network Names* because they are names that identify wireless networks.

MTU. Maximum Transmission Unit. The maximum packet size, in bytes, that can be sent over a network interface.

MULTI-LAYER. The Open System Interconnection (OSI) model divides network traffic into seven distinct levels, from the Physical (hardware) layer to the Application (software) layer. Those in between are the Presentation, Session, Transport, Network, and Data Link layers. Simple first and second generation firewall technologies inspect between 1 and 3 layers of the 7 layer model, while our SMLI engine inspects layers 2 through 7.

-----N-----

NAK. Negative acknowledgment. See ACK.

NCP. Network Control Protocol.

Negotiation Method. This parameter refers to the method used during the Phase I key exchange, or IKE process. SafeHarbour supports Main or Aggressive Mode. Main mode requires 3 two-way message exchanges while Aggressive mode only requires 3 total message exchanges.

null modem. Cable or connection device used to connect two computing devices directly rather than over a network.

-----P-----

packet. Logical grouping of information that includes a header and data. Compare frame, datagram.

PAP. Password Authentication Protocol. Security protocol within the PPP protocol suite that prevents unauthorized access to network services. See RFC 1334 for PAP specifications. Compare CHAP.

parity. Method of checking the integrity of each character received over a communication channel.

Peer External IP Address. The Peer External IP Address is the public, or routable IP address of the remote gateway or VPN server you are establishing the tunnel with.

Peer Internal IP Network. The Peer Internal IP Network is the private, or Local Area Network (LAN) address of the remote gateway or VPN Server you are communicating with.

Peer Internal IP Netmask. The Peer Internal IP Netmask is the subnet mask of the Peer Internal IP Network.

PFS Enable. Enable **P**erfect **F**orward **S**ecrecy. PFS forces a DH negotiation during Phase II of IKE-IPSec SA exchange. You can disable this or select a DH group 1, 2, or 5. PFS is a security principle that ensures that any single key being compromised will permit access to only data protected by that single key. In PFS, the key used to protect transmission of data must not be used to derive any additional keys. If the key was derived from some other keying material, that material must not be used to derive any more keys.

PING. Packet INternet Groper. Utility program that uses an ICMP echo message and its reply to verify that one network node can reach another. Often used to verify that two hosts can communicate over a network.

PPP. Point-to-Point Protocol. Provides a method for transmitting datagrams over serial router-to-router or host-to-network connections using synchronous or asynchronous circuits.

Pre-Shared Key. The Pre-Shared Key is a parameter used for authenticating each side. The value can be an ASCII or Hex and a maximum of 64 characters.

Pre-Shared Key Type. The Pre-Shared Key Type classifies the Pre-Shared Key. SafeHarbour supports *ASCII* or *HEX* types

Priority queueing. Priority queueing (PQ) manages bandwidth resources on a network Gateway. It makes sure that prioritized data packets, such as streaming video or Voice-over-IP, are forwarded with the least possible delay. All other traffic is handled when the highest priority queue is empty.

protocol. Formal set of rules and conventions that specify how information can be exchanged over a network.

PSTN. Public Switched Telephone Network.

-----Q-----

QoS. Quality of Service. The ability of a network to prioritize certain kinds of network traffic to provide reserved bandwidth and reduced latency needed by some real-time and interactive traffic such as voice and video over IP. QoS also provides priority for one or more flows, such that one flow does not make other flows fail.

-----R-----

repeater. Device that regenerates and propagates electrical signals between two network segments. Also known as a hub.

RFC. Request for Comment. Set of documents that specify the conventions and standards for TCP/IP networking.

RIP. Routing Information Protocol. Protocol responsible for distributing information about available routes and networks from one router to another.

RJ-11. Four-pin connector used for telephones.

RJ-45. Eight-pin connector used for 10BaseT (twisted pair Ethernet) networks.

route. Path through a network from one node to another. A large internetwork can have several alternate routes from a source to a destination.

routing table. Table stored in a router or other networking device that records available routes and distances for remote network destinations.

-----S-----

SA Encrypt Type. SA Encryption Type refers to the symmetric encryption type. This encryption algorithm will be used to encrypt each data packet. SA Encryption Type values supported include *DES* and *3DES*.

SA Hash Type. SA Hash Type refers to the Authentication Hash algorithm used during SA negotiation. Values supported include *MD5 SHA1*. N/A will display if NONE is chose for Auth Protocol.

Security Association. From the IPSEC point of view, an SA is a data structure that describes which transformation is to be applied to a datagram and how. The SA specifies:

- The authentication algorithm for AH and ESP
- The encryption algorithm for ESP
- The encryption and authentication keys
- Lifetime of encryption keys
- The lifetime of the SA
- Replay prevention sequence number and the replay bit table

An arbitrary 32-bit number called a Security Parameters Index (SPI), as well as the destination host's address and the IPSEC protocol identifier, identify each SA. An SPI is assigned to an SA when the SA is negotiated. The SA can be referred to by using an SPI in AH and ESP transformations. SA is unidirectional. SAs are commonly setup as bundles, because typically two SAs are required for communications. SA management is always done on bundles (setup, delete, relay).

serial communication. Method of data transmission in which data bits are transmitted sequentially over a communication channel

SHA-1. An implementation of the U.S. Government **Secure Hash Algorithm**; a 160-bit authentication algorithm.

Soft MBytes. Setting the Soft MBytes parameter forces the renegotiation of the IPSec Security Associations (SAs) at the configured Soft MByte value. The value can be configured between *1 and 1,000,000 MB* and refers to data traffic passed. If this value is not achieved, the Hard MBytes parameter is enforced.

Soft Seconds. Setting the Soft Seconds parameter forces the renegotiation of the IPSec Security Associations (SAs) at the configured Soft Seconds value. The value can be configured between 60 and 1,000,000 seconds.

SPI . The **S**ecurity **P**arameter **I**ndex is an identifier for the encryption and authentication algorithm and key. The SPI indicates to the remote firewall the algorithm and key being used to encrypt and authenticate a packet. It should be a unique number greater than 255.

SSL. Secure Sockets Layer. A protocol developed by Netscape for transmitting private documents via the Internet. SSL uses a cryptographic system that uses two keys to encrypt data: a public key known to everyone and a private or secret key known only to the recipient of the message.

STATEFUL. The Netopia Gateway monitors and maintains the state of any network transaction. In terms of network request-and-reply, state consists of the source IP address, destination IP address, communication ports, and data sequence. The Netopia Gateway processes the stream of a network conversation, rather than just individual packets. It verifies that packets are sent from and received by the proper IP addresses along the proper communication ports in the correct order and that no imposter packets interrupt the packet flow. Packet filtering monitors only the ports involved, while the Netopia Gateway analyzes the continuous conversation stream, preventing session hijacking and denial of service attacks.

static route. Route entered manually in a routing table.

subnet mask. A 32-bit address mask that identifies which bits of an IP address represent network address information and which bits represent node identifier information.

synchronous communication. Method of data communication requiring the transmission of timing signals to keep peers synchronized in sending and receiving blocks of data.

-----T-----

telnet. IP protocol that lets a user on one host establish and use a virtual terminal connection to a remote host.

TR-064. TR-064 is a LAN-side DSL Gateway configuration specification; an extension of UPnP. It defines more services to locally manage a Gateway.

TR-069. TR-069 is a WAN-side DSL Gateway Management specification; provides services similar to UPnP and TR-064. The communication between a Gateway and management agent in UPnP and TR-064 is strictly over the LAN, whereas the communication in TR-069 is over the WAN link for some features and over the LAN for others. TR-069 allows a remote Auto-Config Server to provision and manage a Gateway.

TR-101. Standard for a network architecture where the aggregation network is Ethernet-based while the DSL access network is still ATM-over-DSL-based. This facilitates multiplay service delivery over a range of scaleable broadband access technologies. Ratified by the DSL Forum in late April 2006, TR-101 enables service providers to evolve their DSL access networks to better support faster access rates and to introduce new multiplay services across IP-based broadband networks, all through a single gateway. These standards are particularly important for widespread delivery of Internet Protocol Television (IPTV). TR-101 outlines the specific features necessary for IP-based network equipment to deliver multiple services with

the same levels of Quality of Service, authentication, and service segmentation previously provided by traditional DSL networks.

twisted pair. Cable consisting of two copper strands twisted around each other. The twisting provides protection against electromagnetic interference.

-----U-----

UTP. Unshielded twisted pair cable.

-----V-----

VDSL. Very high rate Digital Subscriber Line. VDSL transmits high speed data over short reaches of twisted-pair copper telephone lines, with a range of speeds depending upon actual line length. Both data channels will be separated in frequency from bands used for POTS and ISDN, enabling service providers to overlay VDSL on existing services. At present the two high speed channels will also be separated in frequency.

VLAN. Virtual Local Area Network. A network of computers that behave as if they are connected to the same wire even though they may be physically located on different segments of a LAN. VLANs are configured in software rather than hardware.

VoIP. Voice-over-IP (VoIP) refers to the ability to make voice telephone calls over the Internet. This differs from traditional phone calls that use the Public Switched Telephone Network (PSTN). VoIP calls use an Internet protocol, Session Initiation Protocol (SIP), to transmit sound over a network or the Internet in the form of data packets.

-----W-----

WAN. Wide Area Network. Private network facilities, usually offered by public telephone companies but increasingly available from alternative access providers (sometimes called Competitive Access Providers, or CAPs), that link business network nodes.

WFQ. Weighted Fair Queueing. A packet scheduling technique allowing guaranteed bandwidth services in order to let multiple sessions share the same link. It regulates the flow of data in networks by sorting packets to minimize latency. WFQ passes along narrowband signals first, and buffers broadband signals.

WMM. WiFi MultiMedia. WiFi Multimedia allows you to prioritize various types of data travelling over the wireless network. Certain types of data that are sensitive to delays, such as voice or video, must be prioritized ahead of other, less delay-sensitive types, such as email. It currently implements wireless Quality of Service (QoS) by transmitting data depending on Diffserv priority settings.

WWW. World Wide Web.

-----X-----

XAuth. Extended Authentication. An extension to the Internet Key Exchange (IKE) protocol, for IPSec tunneling. Requires SafeHarbour IPsec tunneling feature key.

CHAPTER 8 *Technical Specifications and Safety Information*

Description

Dimensions:

Smart Modems: 13.5 cm (w) x 13.5 cm (d) x 3.5 cm (h); 5.25" (w) x 5.25" (d) x 1.375" (h)

Wireless Models: 19.5 cm (w) x 17.0 cm (d) x 4.0 cm (h); 7.6" (w) x 6.75" (d) x 1.5" (h)

3342/3342N/3352/3352N: 8.5 cm (w) x 4.5 cm (d) x 2 cm (h); 3.375" (w) x 1.75" (d) x .875" (h)

2200-Series Modems: 1.06"(2.69 cm) H, 4.36" (11.07 cm) W, 5.71"(14.50 cm) L

2200-Series Wireless Models: 1.2"(3.0cm) H, 8.7" (22.0 cm) W, 5.2"(13.2cm) L

Communications interfaces: The Motorola Netopia® Gateways have an RJ-11 jack for DSL line connections or an RJ-45 jack for cable/DSL modem connections and 1 or 4-port 10/100Base-T Ethernet switch for your LAN connections. Some models have a USB port that can be used to connect to your PC; in some cases, the USB port also serves as the power source. Some models contain an 802.11b or 802.11g wireless LAN transmitter.

Power requirements

- 12 VDC input
- **USB-powered models only:** For Use with Listed I.T.E. Only

Environment

Operating temperature: 0° to +40° C

Storage temperature: 0° to +70° C

Relative storage humidity: 20 to 80% noncondensing

Software and protocols

Software media: Software preloaded on internal flash memory; field upgrades done via download to internal flash memory via TFTP or web upload. (does not apply to 3342/3352)

Routing: TCP/IP Internet Protocol Suite, RIP

WAN support: PPPoA, PPPoE, DHCP, static IP address

Security: PAP, CHAP, UI password security, IPsec, SSL certificate

Management/configuration methods: HTTP (Web server), Telnet, SNMP, TR-069 DSL Forum CPE WAN Management Protocol

Diagnostics: Ping, event logging, routing table displays, statistics counters, web-based management, traceroute, nslookup, and diagnostic commands.

Agency approvals

North America

Safety Approvals:

- United States – UL 60950, Third Edition
- Canada – CSA: CAN/CSA-C22.2 No. 60950-00

EMC:

- United States – FCC Part 15 Class B
- Canada – ICES-003

Telecom:

- United States – 47 CFR Part 68
- Canada – CS-03

International

Safety Approvals:

- Low Voltage (European directive) 73/23
- EN60950 (Europe)

EMI Compatibility:

- 89/336/EEC (European directive)
- EN55022:1994 CISPR22 Class B
- EN300 386 V1.2.1 (non-wireless products)
- EN 301-489 (wireless products)

Regulatory notices

European Community. This Motorola Netopia® product conforms to the European Community CE Mark standard for the design and manufacturing of information technology equipment. This standard covers a broad area of product design, including RF emissions and immunity from electrical disturbances.

The Netopia Embedded Software Version 7.7.4 complies with the following EU directives:

- Low Voltage, 73/23/EEC
- EMC Compatibility, 89/336/EEC, conforming to EN 55 022

Manufacturer's Declaration of Conformance



Warnings:

This is a Class B product. In a domestic environment this product may cause radio interference, in which

case the user may be required to take adequate measures. Adequate measures include increasing the physical distance between this product and other electrical devices.
Changes or modifications to this unit not expressly approved by the party responsible for compliance could void the user's authority to operate the equipment.

United States. This equipment has been tested and found to comply with the limits for a Class B digital device, pursuant to Part 15 of the FCC Rules. These limits are designed to provide reasonable protection against harmful interference in a residential installation. This equipment generates, uses, and can radiate radio frequency energy and, if not installed and used in accordance with the instructions, may cause harmful interference to radio communications. However, there is no guarantee that interference will not occur in a particular installation. If this equipment does cause harmful interference to radio or television reception, which can be determined by turning the equipment off and on, the user is encouraged to try to correct the interference by one or more of the following measures:

- Reorient or relocate the receiving antenna.
- Increase the separation between the equipment and receiver.
- Connect the equipment into an outlet on a circuit different from that to which the receiver is connected.
- Consult the dealer or an experienced radio TV technician for help.

Service requirements. In the event of equipment malfunction, all repairs should be performed by our Company or an authorized agent. Under FCC rules, no customer is authorized to repair this equipment. This restriction applies regardless of whether the equipment is in or out of warranty. It is the responsibility of users requiring service to report the need for service to our Company or to one of our authorized agents. Service can be obtained at Motorola, Inc., 6001 Shellmound Street, Emeryville, California, 94608. Telephone: 510-597-5400.



Important

This product was tested for FCC compliance under conditions that included the use of shielded cables and connectors between system components. Changes or modifications to this product not authorized by the manufacturer could void your authority to operate the equipment.

Canada. This Class B digital apparatus meets all requirements of the Canadian Interference-Causing Equipment Regulations.

Cet appareil numérique de la classe B respecte toutes les exigences du Règlement sur le matériel brouilleur du Canada.

Declaration for Canadian users

NOTICE: The Canadian Industry Canada label identifies certified equipment. This certification means that the equipment meets certain telecommunications network protective, operation, and safety requirements. The Department does not guarantee the equipment will operate to the user's satisfaction.

Before installing this equipment, users should ensure that it is permissible to be connected to the facilities of the local telecommunications company. The equipment must also be installed using an acceptable method of connection. In some cases, the company's inside wiring associated with a single line individual service may be extended by means of a certified connector assembly (telephone extension cord). The customer should be aware that compliance with the above conditions may not prevent degradation of service in some situations.

Repairs to the certified equipment should be made by an authorized Canadian maintenance facility designated by the supplier. Any repairs or alterations made by the user to this equipment, or equipment malfunctions, may give the telecommunications company cause to request the user to disconnect the equipment.

Users should ensure for their own protection that the electrical ground connections of the power utility, telephone lines, and internal metallic water pipe system, if present, are connected together. This precaution may be particularly important in rural areas.

Caution

Users should not attempt to make such connections themselves, but should contact the appropriate electric inspection authority, or electrician, as appropriate.

The Ringer Equivalence Number (REN) assigned to each terminal device provides an indication of the maximum number of terminals allowed to be connected to a telephone interface. The termination on an interface may consist of any combination of devices subject only to the requirement that the sum of the Ringer Equivalence Numbers of all the devices does not exceed 5.

Important Safety Instructions

Australian Safety Information

The following safety information is provided in conformance with Australian safety requirements:

Caution

DO NOT USE BEFORE READING THE INSTRUCTIONS: Do not connect the Ethernet ports to a carrier or carriage service provider's telecommunications network or facility unless: a) you have the written consent of the network or facility manager, or b) the connection is in accordance with a connection permit or connection rules.

Connection of the Ethernet ports may cause a hazard or damage to the telecommunication network or facility, or persons, with consequential liability for substantial compensation.

Caution

- The direct plug-in power supply serves as the main power disconnect; locate the direct plug-in power supply near the product for easy access.
- For use only with CSA Certified Class 2 power supply, rated 12VDC.

Telecommunication installation cautions

- Never install telephone wiring during a lightning storm.
- Never install telephone jacks in wet locations unless the jack is specifically designed for wet locations.
- Never touch uninsulated telephone wires or terminals unless the telephone line has been disconnected at the network interface.
- Use caution when installing or modifying telephone lines.
- Avoid using a telephone (other than a cordless type) during an electrical storm. There may be a remote risk of electric shock from lightning.
- Do not use the telephone to report a gas leak in the vicinity of the leak.

47 CFR Part 68 Information

FCC Requirements

1. The Federal Communications Commission (FCC) has established Rules which permit this device to be directly connected to the telephone network. Standardized jacks are used for these connections. This equipment should not be used on party lines or coin phones.
2. If this device is malfunctioning, it may also be causing harm to the telephone network; this device should be disconnected until the source of the problem can be determined and until repair has been made. If this is not done, the telephone company may temporarily disconnect service.
3. The telephone company may make changes in its technical operations and procedures; if such changes affect the compatibility or use of this device, the telephone company is required to give adequate notice of the changes. You will be advised of your right to file a complaint with the FCC.
4. If the telephone company requests information on what equipment is connected to their lines, inform them of:
 - a. The telephone number to which this unit is connected.
 - b. The ringer equivalence number. [0.XB]
 - c. The USOC jack required. [RJ11C]
 - d. The FCC Registration Number. [XXXUSA-XXXX-XX-E]

Items (b) and (d) are indicated on the label. The Ringer Equivalence Number (REN) is used to determine how many devices can be connected to your telephone line. In most areas, the sum of the REN's of all devices on any one line should not exceed five (5.0). If too many devices are attached, they may not ring properly.

FCC Statements

- a) This equipment complies with Part 68 of the FCC rules and the requirements adopted by the ACTA. On the bottom of this equipment is a label that contains, among other information, a product identifier in the format US:AAAEQ##TXXXX. If requested, this number must be provided to the telephone company.
- b) List all applicable certification jack Universal Service Order Codes ("USOC") for the equipment: RJ11.
- c) A plug and jack used to connect this equipment to the premises wiring and telephone network must comply with the applicable FCC Part 68 rules and requirements adopted by the ACTA. A compliant telephone cord and modular plug is provided with this product. It is designed to be connected to a compatible modular jack that is also compliant. See installation instructions for details.
- d) The REN is used to determine the number of devices that may be connected to a telephone line. Excessive RENs on a telephone line may result in the devices not ringing in response to an incoming call. In most but not all areas, the sum of RENs should not exceed five (5.0). To be certain of the number of devices that may be connected to a line, as determined by the total RENs, contact the local telephone company. For products approved after July 23, 2002, the REN for this product is part of the product identifier that has the format US:AAAEQ##TXXXX. The digits represented by ## are the REN without a decimal point (e.g., 03 is a REN of 0.3). For earlier products, the REN is separately shown on the label.
- e) If this equipment, the Motorola Netopia® 2200-, 3300- or 7000-series router, causes harm to the telephone network, the telephone company will notify you in advance that temporary discontinuance of service may be required. But if advance notice isn't practical, the telephone company will notify the customer as soon as possible. Also, you will be advised of your right to file a complaint with the FCC if you believe it is necessary.
- f) The telephone company may make changes in its facilities, equipment, operations or procedures that could affect the operation of the equipment. If this happens the telephone company will provide advance notice in order for you to make necessary modifications to maintain uninterrupted service.
- g) If trouble is experienced with this equipment, the Motorola Netopia® 2200-, 3300- or 7000-series router, for repair or warranty information, please contact:

Motorola Technical Support
510-597-5400
www.netopia.com.

If the equipment is causing harm to the telephone network, the telephone company may request that you disconnect the equipment until the problem is resolved.

- h) This equipment not intended to be repaired by the end user. In case of any problems, please refer to the troubleshooting section of the Product User Manual before calling Motorola Technical Support.
- i) Connection to party line service is subject to state tariffs. Contact the state public utility commission, public service commission or corporation commission for information.
- j) If your home has specially wired alarm equipment connected to the telephone line, ensure the installation of this Motorola Netopia® 2200-, 3300- or 7000-series router does not disable your alarm equipment. If you have questions about what will disable alarm equipment, consult your telephone company or qualified installer.

RF Exposure Statement:

NOTE: Installation of the wireless models must maintain at least 20 cm between the wireless router and any body part of the user to be in compliance with FCC RF exposure guidelines.

Electrical Safety Advisory

Telephone companies report that electrical surges, typically lightning transients, are very destructive to customer terminal equipment connected to AC power sources. This has been identified as a major nationwide problem. Therefore it is advised that this equipment be connected to AC power through the use of a surge arrestor or similar protection device.

Copyright Acknowledgments

Because Motorola has included certain software source code in this product, Motorola includes the following text required by the respective copyright holders:

Portions of this software are based in part on the work of the following:

Copyright (c) 1998-2005 The OpenSSL Project. All rights reserved.

Redistribution and use in source and binary forms, with or without modification, are permitted provided that the following conditions are met:

1. Redistributions of source code must retain the above copyright notice, this list of conditions and the following disclaimer.
2. Redistributions in binary form must reproduce the above copyright notice, this list of conditions and the following disclaimer in the documentation and/or other materials provided with the distribution.
3. All advertising materials mentioning features or use of this software must display the following acknowledgment:
"This product includes software developed by the OpenSSL Project for use in the OpenSSL Toolkit.
(<http://www.openssl.org/>)"
4. The names "OpenSSL Toolkit" and "OpenSSL Project" must not be used to endorse or promote products derived from this software without prior written permission. For written permission, please contact openssl-core@openssl.org.
5. Products derived from this software may not be called "OpenSSL" nor may "OpenSSL" appear in their names without prior written permission of the OpenSSL Project.
6. Redistributions of any form whatsoever must retain the following acknowledgment:
"This product includes software developed by the OpenSSL Project
for use in the OpenSSL Toolkit (<http://www.openssl.org/>)"

THIS SOFTWARE IS PROVIDED BY THE OpenSSL PROJECT "AS IS" AND ANY EXPRESSED OR IMPLIED WARRANTIES, INCLUDING, BUT NOT LIMITED TO, THE IMPLIED WARRANTIES OF MERCHANTABILITY AND FITNESS FOR A PARTICULAR PURPOSE ARE DISCLAIMED. IN NO EVENT SHALL THE OpenSSL PROJECT OR ITS CONTRIBUTORS BE LIABLE FOR ANY DIRECT, INDIRECT, INCIDENTAL, SPECIAL, EXEMPLARY, OR CONSEQUENTIAL DAMAGES (INCLUDING, BUT NOT LIMITED TO, PROCUREMENT OF SUBSTITUTE GOODS OR SERVICES; LOSS OF USE, DATA, OR PROFITS; OR BUSINESS INTERRUPTION) HOWEVER CAUSED AND ON ANY THEORY OF LIABILITY, WHETHER IN CONTRACT, STRICT LIABILITY, OR TORT (INCLUDING NEGLIGENCE OR OTHERWISE) ARISING IN ANY WAY OUT OF THE USE OF THIS SOFTWARE, EVEN IF ADVISED OF THE POSSIBILITY OF SUCH DAMAGE.

This product includes cryptographic software written by Eric Young (ey@cryptsoft.com).

This product includes software written by Tim Hudson (tjh@cryptsoft.com).

Original SSLeay License

/Copyright (C) 1995-1998 Eric Young (eay@cryptsoft.com)

All rights reserved.

This package is an SSL implementation written by Eric Young (eay@cryptsoft.com).

The implementation was written so as to conform with Netscape's SSL.

This library is free for commercial and non-commercial use as long as the following conditions are adhered to. The following conditions apply to all code found in this distribution, be it the RC4, RSA, lhash, DES, etc., code; not just the SSL code. The SSL documentation included with this distribution is covered by the same copyright terms except that the holder is Tim Hudson (tjh@cryptsoft.com).

Copyright remains Eric Young's, and as such any Copyright notices in the code are not to be removed. If this package is used in a product, Eric Young should be given attribution as the author of the parts of the library used. This can be in the form of a textual message at program startup or in documentation (online or textual) provided with the package.

Redistribution and use in source and binary forms, with or without modification, are permitted provided that the following conditions are met:

1. Redistributions of source code must retain the copyright notice, this list of conditions and the following disclaimer.
2. Redistributions in binary form must reproduce the above copyright notice, this list of conditions and the following disclaimer in the documentation and/or other materials provided with the distribution.
3. All advertising materials mentioning features or use of this software must display the following acknowledgement:

“This product includes cryptographic software written by Eric Young (eay@cryptsoft.com)”

The word 'cryptographic' can be left out if the routines from the library being used are not cryptographic related :-).

4. If you include any Windows specific code (or a derivative thereof) from the apps directory (application code) you must include an acknowledgement:

“This product includes software written by Tim Hudson (tjh@cryptsoft.com)”

THIS SOFTWARE IS PROVIDED BY ERIC YOUNG ``AS IS'' AND ANY EXPRESS OR IMPLIED WARRANTIES, INCLUDING, BUT NOT LIMITED TO, THE IMPLIED WARRANTIES OF MERCHANTABILITY AND FITNESS FOR A PARTICULAR PURPOSE ARE DISCLAIMED. IN NO EVENT SHALL THE AUTHOR OR CONTRIBUTORS BE LIABLE FOR ANY DIRECT, INDIRECT, INCIDENTAL, SPECIAL, EXEMPLARY, OR CONSEQUENTIAL DAMAGES (INCLUDING, BUT NOT LIMITED TO, PROCUREMENT OF SUBSTITUTE GOODS OR SERVICES; LOSS OF USE, DATA, OR PROFITS; OR BUSINESS INTERRUPTION) HOWEVER CAUSED AND ON ANY THEORY OF LIABILITY, WHETHER IN CONTRACT, STRICT LIABILITY, OR TORT (INCLUDING NEGLIGENCE OR OTHERWISE) ARISING IN ANY WAY OUT OF THE USE OF THIS SOFTWARE, EVEN IF ADVISED OF THE POSSIBILITY OF SUCH DAMAGE.

The licence and distribution terms for any publicly available version or derivative of this code cannot be changed. i.e. this code cannot simply be copied and put under another distribution licence [including the GNU Public Licence.]

Portions of this software are based in part on the work of the following:

Copyright (C) 1995, 1996, 1997, and 1998 WIDE Project. All rights reserved.

Redistribution and use in source and binary forms, with or without modification, are permitted provided that the following conditions are met:

1. Redistributions of source code must retain the above copyright notice, this list of conditions and the following disclaimer.
2. Redistributions in binary form must reproduce the above copyright notice, this list of conditions and the following disclaimer in the documentation and/or other materials provided with the distribution.
3. Neither the name of the project nor the names of its contributors may be used to endorse or promote products derived from this software without specific prior written permission.

THIS SOFTWARE IS PROVIDED BY THE PROJECT AND CONTRIBUTORS ``AS IS'' AND ANY EXPRESS OR IMPLIED WARRANTIES, INCLUDING, BUT NOT LIMITED TO, THE IMPLIED WARRANTIES OF MERCHANTABILITY AND FITNESS FOR A PARTICULAR PURPOSE ARE DISCLAIMED. IN NO EVENT SHALL THE PROJECT OR CONTRIBUTORS BE LIABLE FOR ANY DIRECT, INDIRECT, INCIDENTAL, SPECIAL, EXEMPLARY, OR CONSEQUENTIAL DAMAGES (INCLUDING, BUT NOT LIMITED TO, PROCUREMENT OF SUBSTITUTE GOODS OR SERVICES; LOSS OF USE, DATA, OR PROFITS; OR BUSINESS INTERRUPTION) HOWEVER CAUSED AND ON ANY THEORY OF LIABILITY, WHETHER IN CONTRACT, STRICT

LIABILITY, OR TORT (INCLUDING NEGLIGENCE OR OTHERWISE) ARISING IN ANY WAY OUT OF THE USE OF THIS SOFTWARE, EVEN IF ADVISED OF THE POSSIBILITY OF SUCH DAMAGE.

Portions of this software are based in part on the work of the following:

Copyright (C) 1990, RSA Data Security, Inc. All rights reserved.

<<RSA Data Security, Inc. MD5 Message-Digest Algorithm>>

License to copy and use this software is granted provided that it is identified as the "RSA Data Security, Inc. MD5 Message Digest Algorithm" in all material mentioning or referencing this software or this function.

License is also granted to make and use derivative works provided that such works are identified as "derived from the RSA Data Security, Inc. MD5 Message-Digest Algorithm" in all material mentioning or referencing the derived work.

<<RSA Data Security, Inc. MD4 Message-Digest Algorithm>>

License to copy and use this software is granted provided that it is identified as the "RSA Data Security, Inc. MD4 Message Digest Algorithm" in all material mentioning or referencing this software or this function.

License is also granted to make and use derivative works provided that such works are identified as "derived from the RSA Data Security, Inc. MD4 Message-Digest Algorithm" in all material mentioning or referencing the derived work.

RSA Data Security, Inc. makes no representations concerning either the merchantability of this software or the suitability of this software for any particular purpose. It is provided "as is" without express or implied warranty of any kind.

These notices must be retained in any copies of any part of this documentation and/or software.

Portions of this software are based in part on the work of the following:

Copyright (c) 1989 Carnegie Mellon University. All rights reserved.

Redistribution and use in source and binary forms are permitted provided that the above copyright notice and this paragraph are duplicated in all such forms and that any documentation, advertising materials, and other materials related to such distribution and use acknowledge that the software was developed by Carnegie Mellon University. The name of the University may not be used to endorse or promote products derived from this software without specific prior written permission.

THIS SOFTWARE IS PROVIDED ``AS IS'' AND WITHOUT ANY EXPRESS OR IMPLIED WARRANTIES, INCLUDING, WITHOUT LIMITATION, THE IMPLIED WARRANTIES OF MERCHANTABILITY AND FITNESS FOR A PARTICULAR PURPOSE.

Portions of this software are based in part on the work of the following:

Copyright 2000, 2001 Shane Kerr. All rights reserved.

Redistribution and use in source and binary forms, with or without modification, are permitted provided that the following conditions are met:

1. Redistributions of source code must retain the above copyright notice, this list of conditions and the following disclaimer.

2. Redistributions in binary form must reproduce the above copyright notice, this list of conditions and the following disclaimer in the documentation and/or other materials provided with the distribution.

THIS SOFTWARE IS PROVIDED BY THE AUTHOR(S) ``AS IS'' AND ANY EXPRESS OR IMPLIED WARRANTIES, INCLUDING, BUT NOT LIMITED TO, THE IMPLIED WARRANTIES OF MERCHANTABILITY AND FITNESS FOR A PARTICULAR PURPOSE ARE DISCLAIMED. IN NO EVENT SHALL THE REGENTS OR CONTRIBUTORS BE LIABLE FOR ANY DIRECT, INDIRECT, INCIDENTAL, SPECIAL, EXEMPLARY, OR CONSEQUENTIAL DAMAGES (INCLUDING, BUT NOT LIMITED TO, PROCUREMENT OF SUBSTITUTE GOODS OR SERVICES; LOSS OF USE, DATA, OR PROFITS; OR BUSINESS INTERRUPTION) HOWEVER CAUSED AND ON ANY THEORY OF LIABILITY, WHETHER IN CONTRACT, STRICT LIABILITY, OR TORT (INCLUDING NEGLIGENCE OR OTHERWISE) ARISING IN ANY WAY OUT OF THE USE OF THIS SOFTWARE, EVEN IF ADVISED OF THE POSSIBILITY OF SUCH DAMAGE.

CHAPTER 9 Overview of Major Capabilities

The Motorola Netopia® Gateway offers simplified setup and management features as well as advanced broadband router capabilities. The following are some of the main features of the Motorola Netopia® Gateway:

- [“Wide Area Network Termination” on page 351](#)
The Gateway combines an ADSL modem with an Internet router. It translates protocols used on the Internet to protocols used by home personal computers and eliminates the need for special desktop software (i.e. PPPoE).
- [“Simplified Local Area Network Setup” on page 352](#)
Built-in DHCP and DNS proxy features minimize or eliminate the need to program any network configuration into your home personal computer.
- [“Management” on page 353](#)
A Web server built into the Motorola Netopia® Operating System makes setup and maintenance easy using standard browsers. Diagnostic tools facilitate troubleshooting.
- [“Security” on page 354](#)
Network Address Translation (NAT), password protection, Stateful Inspection firewall and other built-in security features prevent unauthorized remote access to your network. Pinholes, default server, and other features permit access to computers on your home network that you can specify.

Wide Area Network Termination

PPPoE/PPPoA (Point-to-Point Protocol over Ethernet/ATM)

The PPPoE specification, incorporating the PPP and Ethernet standards, allows your computer(s) to connect to your Service Provider’s network through your Ethernet WAN connection. The Motorola Netopia®-series Gateway supports PPPoE, eliminating the need to install PPPoE client software on any LAN computers.

Service Providers may require the use of PPP authentication protocols such as Challenge Handshake Authentication Protocol (CHAP) or Password Authentication Protocol (PAP). CHAP and PAP use a username and password pair to authenticate users with a PPP server.

A CHAP authentication process works as follows:

1. **The password is used to scramble a challenge string.**
2. **The password is a shared secret, known by both peers.**

3. The unit sends the scrambled challenge back to the peer.

PAP, a less robust method of authentication, sends a username and password to a PPP server to be authenticated. PAP's username and password pair are not encrypted, and are therefore sent "unscrambled".

Instant-On PPP

You can configure your Gateway for one of two types of Internet connections:

- Always On
- Instant On

These selections provide either an uninterrupted Internet connection or an as-needed connection.

While an Always On connection is convenient, it does leave your network permanently connected to the Internet, and therefore potentially vulnerable to attacks.

Motorola Netopia®'s Instant On technology furnishes almost all the benefits of an Always-On connection while providing two additional security benefits:

- Your network cannot be attacked when it is not connected.
- Your network may change address with each connection making it more difficult to attack.

When you configure Instant On access, you can also configure an idle time-out value. Your Gateway monitors traffic over the Internet link and when there has been no traffic for the configured number of seconds, it disconnects the link.

When new traffic that is destined for the Internet arrives at the Gateway, the Gateway will instantly re-establish the link.

Your service provider may be using a system that assigns the Internet address of your Gateway out of a pool of many possible Internet addresses. The address assigned varies with each connection attempt, which makes your network a moving target for any attacker.

Simplified Local Area Network Setup

DHCP (Dynamic Host Configuration Protocol) Server

DHCP Server functionality enables the Gateway to assign to your LAN computer(s) a "private" IP address and other parameters that allow network communication. The default DHCP Server configuration of the Gateway supports up to 253 LAN IP addresses.

This feature simplifies network administration because the Gateway maintains a list of IP address assignments. Additional computers can be added to your LAN without the hassle of configuring an IP address.

DNS Proxy

Domain Name System (DNS) provides end users with the ability to look for devices or web sites by typing their names, rather than IP addresses. For web surfers, this technology allows you to enter the URL (Universal Resource Locator) as text to surf to a desired website.

The Motorola Netopia® DNS Proxy feature allows the LAN-side IP address of the Gateway to be used for proxying DNS requests from hosts on the LAN to the DNS Servers configured in the gateway. This is accomplished by having the Gateway's LAN address handed out as the “DNS Server” to the DHCP clients on the LAN.



NOTE:

The Motorola Netopia® DNS Proxy only proxies UDP DNS queries, not TCP DNS queries.

Management

Embedded Web Server

There is no specialized software to install on your PC to configure, manage, or maintain your Motorola Netopia® Gateway. Web pages embedded in the operating system provide access to the following Gateway operations:

- Setup
- System and security logs
- Diagnostics functions

Once you have removed your Motorola Netopia® Gateway from its packing container and powered the unit up, use any LAN attached PC or workstation running a common web browser application to configure and monitor the Gateway.

Diagnostics

In addition to the Gateway's visual LED indicator lights, you can run an extensive set of diagnostic tools from your Web browser.

Two of the facilities are:

- Automated “Multi-Layer” Test
The [Run Diagnostics](#) link initiates a sequence of tests. They examine the entire functionality of the Gateway, from the physical connections to the data traffic.

- Network Test Tools

Three test tools to determine network reachability are available:

Ping - tests the “reachability” of a particular network destination by sending an ICMP echo request and waiting for a reply.

NSLookup - converts a domain name to its IP address and vice versa.

TraceRoute - displays the path to a destination by showing the number of hops and the router addresses of these hops.

The system log also provides diagnostic information.



NOTE:

Your Service Provider may request information that you acquire from these various diagnostic tools. Individual tests may be performed at the command line. (See [“Command Line Interface” on page 223.](#))

Security

Remote Access Control

You can determine whether or not an administrator or other authorized person has access to configuring your Gateway. This access can be turned on or off in the Web interface.

Password Protection

Access to your Motorola Netopia® device can be controlled through two access control accounts, **Admin** or **User**.

- The **Admin**, or administrative user, performs all configuration, management or maintenance operations on the Gateway.
- The **User** account provides monitor capability **only**.
A user may **NOT** change the configuration, perform upgrades or invoke maintenance functions.

Account usernames can now be changed for the **Admin** and **User** accounts.

Network Address Translation (NAT)

The Motorola Netopia® Gateway Network Address Translation (NAT) security feature lets you conceal the topology of a hard-wired Ethernet or wireless network connected to its LAN interface from routers on networks connected to its WAN interface. In other words, the end computer stations on your LAN are **invisible** from the Internet.

Only a **single WAN IP address** is required to provide this security support for your entire LAN.

LAN sites that communicate through an Internet Service Provider typically enable NAT, since they usually purchase only one IP address from the ISP.

- When NAT is **ON**, the Motorola Netopia® Gateway “proxies” for the end computer stations on your network by pretending to be the originating host for network communications from non-originating networks. The WAN interface address is the only IP address exposed.
The Motorola Netopia® Gateway tracks which local hosts are communicating with which remote hosts. It routes packets received from remote networks to the correct computer on the LAN (Ethernet) interface.

- When NAT is **OFF**, a Motorola Netopia® Gateway acts as a traditional TCP/IP router, all LAN computers/ devices are exposed to the Internet.

A diagram of a typical NAT-enabled LAN follows:

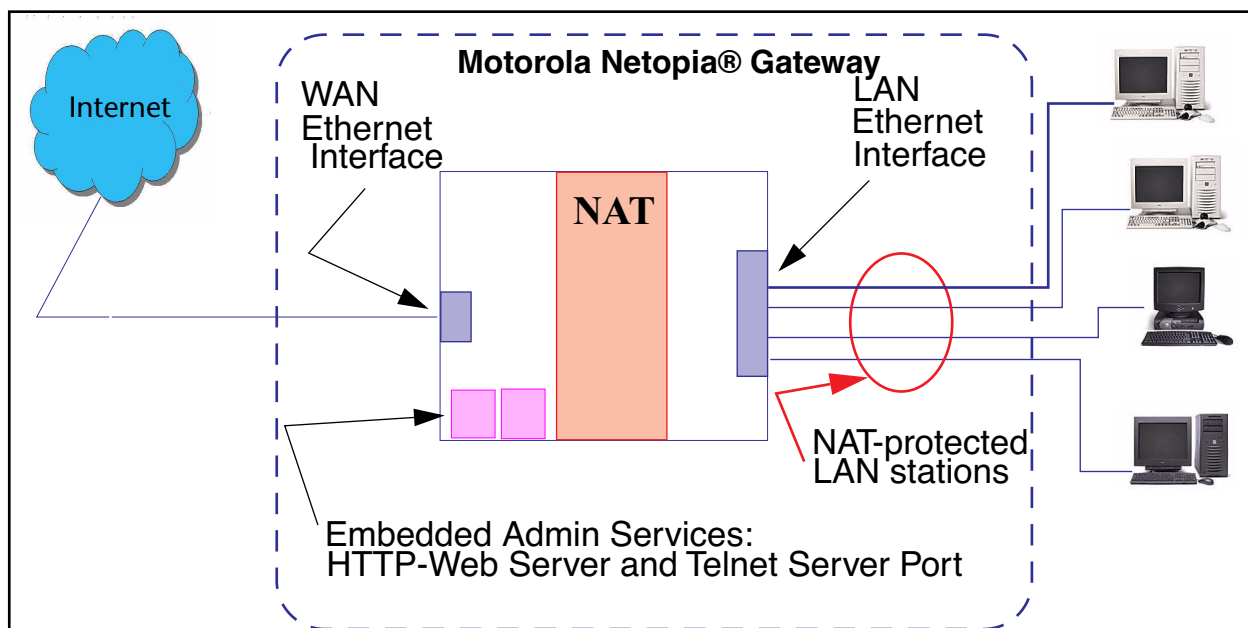

NOTE:

1. The default setting for NAT is **ON**.
2. Motorola Netopia® uses Port Address Translation (PAT) to implement the NAT facility.
3. NAT Pinhole traffic (discussed below) is always initiated from the WAN side.

Motorola Netopia® Advanced Features for NAT

Using the NAT facility provides effective LAN security. However, there are user applications that require methods to selectively by-pass this security function for certain types of Internet traffic.

Motorola Netopia® Gateways provide special pinhole configuration rules that enable users to establish NAT-protected LAN layouts that still provide flexible by-pass capabilities.

Some of these rules require coordination with the unit's embedded administration services: the internal Web (HTTP) Port (TCP 80) and the internal Telnet Server Port (TCP 23).

Internal Servers

The internal servers are the embedded Web and Telnet servers of the Gateway. You would change the internal server ports for Web and Telnet of the Gateway if you wanted to have these services on the LAN using pinholes or the Default server.

Pinholes

This feature allows you to:

- Transparently route selected types of network traffic using the port forwarding facility. FTP requests or HTTP (Web) connections are directed to a specific host on your LAN.
- Setup multiple pinhole paths.
Up to 32 paths are supported
- Identify the type(s) of traffic you want to redirect by port number.

Common TCP/IP protocols and ports are:

FTP (TCP 21)	telnet (TCP 23)
SMTP (TCP 25)	HTTP (TCP 80)
SNMP (TCP 161, UDP 161)	

See [page 82](#) for How To instructions.

Default Server

This feature allows you to:

- Direct your Gateway to forward all externally initiated IP traffic (TCP and UDP protocols only) to a default host on the LAN.
- Enable it for certain situations:
Where you cannot anticipate what port number or packet protocol an in-bound application might use. For example, some network games select arbitrary port numbers when a connection is opened.

When you want all unsolicited traffic to go to a specific LAN host.

Combination NAT Bypass Configuration

Specific pinholes and Default Server settings, each directed to different LAN devices, can be used together.



WARNING:

Creating a pinhole or enabling a Default Server allows inbound access to the specified LAN station. Contact your Network Administrator for LAN security questions.

IP-Passthrough

Motorola Netopia® OS now offers an IP passthrough feature. The IP passthrough feature allows a single PC on the LAN to have the Gateway's public address assigned to it. It also provides PAT (NAPT) via the same public IP address for all other hosts on the private LAN subnet.

VPN IPSec Pass Through

This Motorola Netopia® service supports your independent VPN client software in a transparent manner. Motorola Netopia® has implemented an Application Layer Gateway (ALG) to support multiple PCs running IP Security protocols.

This feature has three elements:

1. **On power up or reset, the address mapping function (NAT) of the Gateway's WAN configuration is turned on by default.**
2. **When you use your third-party VPN application, the Gateway recognizes the traffic from your client and your unit. It allows the packets to pass through the NAT "protection layer" via the encrypted IPSec tunnel.**
3. **The encrypted IPSec tunnel is established "through" the Gateway.**

A typical VPN IPSec Tunnel pass through is diagrammed below:

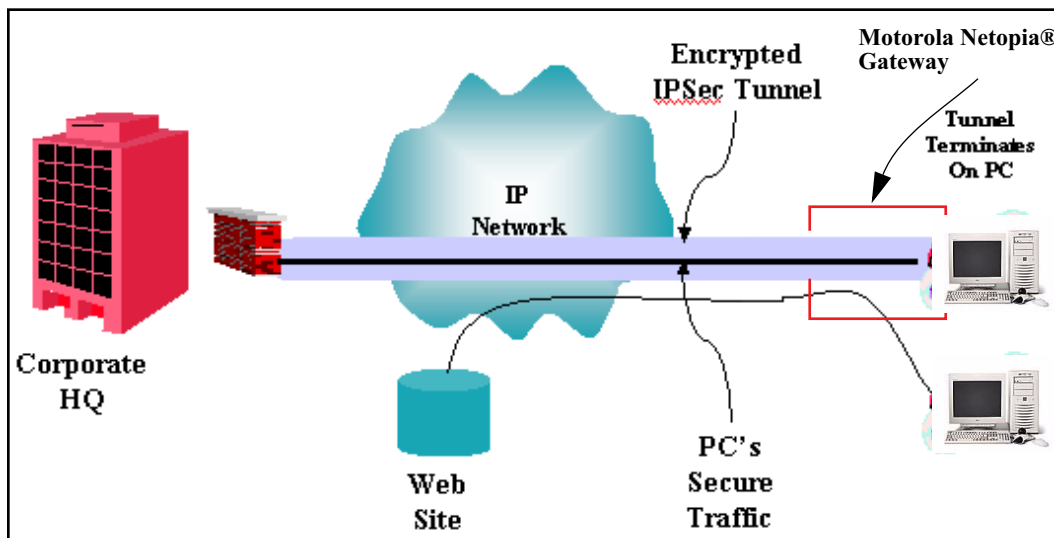

NOTE:

Typically, no special configuration is necessary to use the IPSec pass through feature. In the diagram, VPN PC clients are shown behind the Motorola Netopia® Gateway and the secure server is at Corporate Headquarters across the WAN. You cannot have your secure server behind the Motorola Netopia® Gateway. When multiple PCs are starting IPSec sessions, they must be started one at a time to allow the associations to be created and mapped.

VPN IPSec Tunnel Termination

This Motorola Netopia® service supports termination of VPN IPSec tunnels at the Gateway. This permits tunnelling from the Gateway without the use of third-party VPN client software on your client PCs.

Stateful Inspection Firewall

Stateful inspection is a security feature that prevents unsolicited inbound access when NAT is disabled. You can configure UDP and TCP “no-activity” periods that will also apply to NAT time-outs if stateful inspection is enabled on the interface.

Technical details are discussed in [“Expert Mode” on page 39](#).

SSL Certificate Support

On selected models, you can also install a Secure Sockets Layer (SSL V3.0) certificate from a trusted Certification Authority (CA) for authentication purposes. If this feature is available on your Gateway, an additional link will appear in the Install page.

Netopia Embedded Software Version 7.7.4 uses SSL certificates for TR-069 support.

See [“Install Certificate” on page 190](#).

VLANs

Motorola Netopia®'s VGx technology allows a single Motorola Netopia® VGx-enabled broadband gateway to act as separate virtual gateways, treating each individual service as a single service “channel.” The VGx-enabled gateway applies specific policies, routing, and prioritization parameters to each service channel, ensuring delivery of that service to the appropriate peripheral device with the requisite level of QoS and correct feature sets — making it ideal for delivery of triple play voice, video, and data services.

VGx was developed to ensure that subscribers receive the quality of voice, video, and data services they expect — to prevent a large data download from causing jittery video or poor voice quality. VGx achieves this goal by providing superior service segmentation and QoS features obtained by mapping multiple local virtual local area networks (**VLANs**) to one or more specific permanent virtual circuits (PVCs) for DSL, or wide area network VLANs for a fiber network.

Traffic prioritization is determined through the Institute of Electrical Engineering (IEEE) standard **802.1p**, which specifies **QoS** algorithms to prioritize traffic based on protocol and source. This insures that each service receives the QoS treatment it requires; for example,

- video is free from latency,
- VoIP service is prioritized to insure aural quality, and
- data is securely and efficiently routed.

Index

Symbols

!! command [227](#)

A

Access the GUI [39](#)

Address resolution table [234](#)

Administrative restrictions [264](#)

Administrator password [39](#), [140](#), [226](#)

Arguments, CLI [241](#)

ARP

 Command [228](#), [239](#)

ATA configuration [243](#)

Authentication [281](#)

Authentication trap [297](#)

auto-channel mode [303](#)

AutoChannel Setting [57](#), [303](#)

B

Backup [133](#)

Bridging [246](#)

Broadcast address [259](#), [261](#)

C

CLI [223](#)

 !! command [227](#)

 Arguments [241](#)

 Command shortcuts [227](#)

 Command truncation [240](#)

 Configuration mode [240](#)

 Keywords [241](#)

 Navigating [240](#)

 Prompt [227](#), [240](#)

 Restart command [227](#)

 SHELL mode [227](#)

 View command [242](#)

Command

 ARP [228](#), [239](#)

 Ping [230](#)

 Telnet [238](#)

Command line interface (see CLI)

Community [297](#)
Compression, protocol [280](#)
Concurrent Bridging/Routing [105](#), [247](#)
CONFIG
 Command List [225](#)
Configuration mode [240](#)

D

D. port [167](#)
Default IP address [39](#)
denial of service [340](#)
designing a new filter set [169](#)
DHCP [248](#)
DHCP filtering [252](#)
DHCP lease table [231](#)
DHCP option filtering [252](#)
DHCP/PPPoE/PPPoA Autosensing [68](#)
Diagnostic log [231](#), [235](#)
 Level [298](#)
Diagnostics [353](#)
DNS [255](#)
DNS Proxy [353](#)
Documentation conventions [15](#)
Domain Name System (DNS) [255](#)
DSL Forum settings [321](#)

E

Echo request [280](#)
echo-period [280](#)
Embedded Web Server [353](#)
Ethernet address [246](#)
Ethernet statistics [231](#)

F

Feature Keys
 Obtaining [187](#)
filter
 parts [165](#)
 parts of [165](#)
filter priority [164](#)
filter set
 adding [171](#)
 display [167](#)

filter sets
 adding [171](#)
 defined [163](#)
 deleting [175](#)
 disadvantages [163](#)
 using [171](#)
filtering example #1 [167](#)

filters
 actions a filter can take [165](#)
 adding to a filter set [172](#)
 defined [163](#)
 deleting [175](#)
 input [172](#)
 modifying [175](#)
 output [172](#)
 using [170](#), [171](#)
 viewing [175](#)
firewall [235](#)
FTP [278](#)

H

Hardware address [246](#)
hijacking [340](#)
Hop count [277](#)
HTTP traffic [286](#)

I

ICMP Echo [230](#)
IGMP [100](#)
IGMP Snooping [101](#), [257](#)
Install [182](#)
Install Certificate [190](#)
IP address [259](#), [261](#)
 Default [39](#)
IP interfaces [234](#)
IP routes [235](#)
IP Subnets [50](#)
IPMap table [235](#)
IPSec Tunnel [234](#)

K

Keywords, CLI [241](#)

L

LAN Host Discovery Table [235](#)
latency [177](#)
LCP echo request [280](#)
Link
 Install Software [182](#)
 Quickstart [47](#), [49](#), [67](#)
Local Area Network [352](#)
Location, SNMP [297](#)
Log [235](#)
Logging in [226](#)
lost echoes [280](#)

M

Magic number [280](#)
Memory [235](#)
Metric [277](#)
multi-cast forwarding [260](#), [283](#)
Multiple SSIDs [59](#)
multiple subnets [50](#)
Multiple Wireless SSIDs
 Wireless [59](#), [303](#)

N

Nameserver [255](#)
NAT [264](#), [278](#), [354](#)
 Traffic rules [90](#)
NAT Default Server [356](#)
Netmask [262](#)
Network Address Translation [354](#)
Network Test Tools [353](#)
NSLookup [353](#)

O

set upnp option [321](#)
Operating Mode
 Wireless [56](#), [303](#)

P

PAP [351](#)
Password [140](#)
 Administrator [39](#), [140](#), [226](#)
 User [39](#), [140](#), [226](#)

persistent-log [299](#)
Ping [353](#)
Ping command [230](#)
Pinholes [278](#), [356](#)
 Planning [82](#)
policy-based routing [177](#)
Port authentication [281](#)
port number
 comparisons [166](#)
port numbers [165](#)
Port renumbering [286](#)
PPP [240](#)
PPPoE [351](#)
PPPoE with IPoE [71](#), [73](#)
Primary nameserver [255](#)
Prompt, CLI [227](#), [240](#)
Protocol compression [280](#)

Q

qos max-burst-size [245](#)
qos peak-cell-rate [245](#)
qos service-class [245](#)
qos sustained-cell-rate [245](#)
quality of service [165](#), [177](#)

R

Restart [232](#)
Restart command [227](#)
Restart timer [280](#)
Restrictions [264](#)
RIP [261](#), [262](#)
Routing Information Protocol (RIP) [261](#), [262](#)
rtsp-passthrough [276](#)

S

Secondary nameserver [255](#)
Secure Sockets Layer [190](#)
Security
 filters [163](#)
Security log [180](#)
Session Initiation Protocol [120](#), [316](#)
Set bncp command [245](#), [246](#)
Set bridge commands [247](#)

Set DMT commands [254](#)
Set dns commands [255](#)
Set ip static-routes commands [276](#)
Set ppp module port authentication command [281](#)
Set preference more command [285](#)
Set preference verbose command [285](#)
set security state-insp [292](#)
Set servers command [286](#)
Set servers telnet-tcp command [286](#)
Set snmp sysgroup location command [297](#)
Set snmp traps authentication-traps ip-address command [297](#)
Set system diagnostic-level command [298](#)
Set system heartbeat command [300](#)
Set system name command [298](#)
Set system NTP command [300](#)
Set system password command [299](#)
set system syslog [301](#)
Set wireless option command [303](#)
Set wireless user-auth option command [309](#)
SHELL
 Command Shortcuts [227](#)
 Commands [227](#)
 Prompt [227](#)
SHELL level [240](#)
SHELL mode [227](#)
show config [232](#)
Show ppp [240](#)
Simple Network Management Protocol (SNMP) [297](#)
SIP [120](#), [316](#)
sip-passthrough [276](#)
SMTP [278](#)
SNMP [98](#), [278](#), [297](#)
SNMP Notify Type settings [297](#)
src. port
 [167](#)
SSL certificates [190](#)
Stateful Inspection [154](#)
stateful inspection [235](#)
Static route [276](#)
Step mode [242](#)
Subnet mask [262](#)
Subnets [50](#)
subnets
 multiple [50](#)
Syslog [125](#)

System contact, SNMP [297](#)
System diagnostics [298](#)
system idle-timeout [299](#)

T

Telnet [226](#), [278](#)
Telnet command [238](#)
Telnet traffic [286](#)
TFTP [278](#)
TFTP server [229](#)
Toolbar [43](#)
TOS bit [165](#), [177](#)
TraceRoute [218](#), [354](#)
Trap [297](#)
Trivial File Transfer Protocol [229](#)
Truncation [240](#)

U

UPnP [102](#)
User name [226](#)
User password [39](#), [140](#), [226](#)

V

set atm [245](#)
View command [242](#)
view config [238](#)
VLAN ID [111](#)
VLAN Settings [311](#)
VLANs [107](#)
Voice-over-IP [120](#), [316](#)
VoIP [120](#), [316](#)
VPN
 IPSec Pass Through [357](#)
 IPSec Tunnel Termination [357](#)

W

Weighted Fair Queue [273](#)
weighted fair queuing [271](#)
Wide Area Network [351](#)
WiFi Multimedia [62](#)
Wireless [53](#)

Z

Zero Touch [301](#)



MOTOROLA

Motorola Netopia® 2200-, 3300- or 7000-series

Motorola, Inc.
6001 Shellmound Street
Emeryville, CA 94608

August 2, 2007

Free Manuals Download Website

<http://myh66.com>

<http://usermanuals.us>

<http://www.somanuals.com>

<http://www.4manuals.cc>

<http://www.manual-lib.com>

<http://www.404manual.com>

<http://www.luxmanual.com>

<http://aubethermostatmanual.com>

Golf course search by state

<http://golfingnear.com>

Email search by domain

<http://emailbydomain.com>

Auto manuals search

<http://auto.somanuals.com>

TV manuals search

<http://tv.somanuals.com>