

# GM950 User Guide

## Contents

	Page:
Safety Information .....	1
General Information.....	2
Radio Controls and Indicators .....	2
Audio Signals.....	3
Display Icons .....	3
Radio On/Off .....	3
Channel Selection .....	4
4-Channel Model .....	4
128-Channel Model .....	4
Channel Without Selective Call Functions.....	4
Communication Procedures .....	4
Call Termination .....	4
Channel With Selective Call Functions.....	5
Address Selection.....	5
Status Selection.....	5
Sending a Selective Call.....	5
Receiving a Selective Call .....	5
Option Button Functions .....	6
Computer Software Copyright .....	7

## Safety Information

Every radio, when transmitting, radiates energy into the atmosphere which may, under certain conditions, cause the generation of a spark. All users of vehicles fitted with radios should be aware of the following warning:

**WARNING: Do not operate radio near inflammable liquids or in the vicinity of explosive devices.**



During normal use, the radio will subject you to radio energy substantially below the level where any kind of harm is reported.

To ensure personal safety, please observe the following simple rules:

- DO NOT** transmit when the antenna is very close to, or touching, exposed parts of the body, especially the face and eyes.
- DO NOT** hold the transmit (PTT) key in when not actually desiring to transmit.
- DO NOT** allow children to play with any radio equipment containing a transmitter.
- DO NOT** operate radio whilst driving. It should also be noted that the use of a hand-held microphone while driving could constitute an offence under Road Traffic Regulations.

## General Information

Congratulations on choosing the GM950, an excellent mobile radio. Motorola's stringent quality procedures guarantee the high standard of Motorola products. Your radio has left our factory only after extensive tests.

This user guide describes the way a standard radio works. Since standard operation may be changed by programming, the way your radio operates may differ slightly from what is described here.

If in doubt contact the person in charge of your radio system or the Motorola dealer who supplied the equipment.

**WARNING:** When installing or removing the mobile radio from the vehicle, the radio must be switched off.









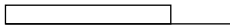
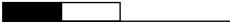

## Radio Controls and Indicators

The numbers refer to the illustrations on the inside front cover.

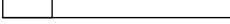
- 1. Radio ON/OFF.**
- 2. Microphone connector.**
- 3. Volume Up/Down Control.**
- 4. Three LED Indicators:**

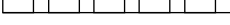
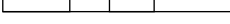
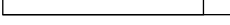
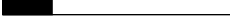
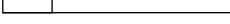
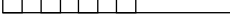

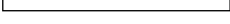





Red, continuous:	Radio transmits
Red, flashing:	Channel busy
Yellow, continuous:	Monitor mode
Yellow, flashing:	Radio Called
Green, continuous:	Function button enabled (non-display radio only)
Green, flashing:	Scanning on
Red, Green: (alternating)	Error indication. Switch radio off then on again.
Red, Yellow, Green: (alternating)	If error indication persists, return radio to dealer.
- 5. Squelch Button.**
- 6. Programmable Function Button.**
- 7. Channel Selection Buttons.**
- 8. Channel Selected LEDs.**
- 9. Programmable Option Buttons.**
- 10. LCD Display.**  
Three characters + Function Icons.
- 11. Microphone PTT (Push To Talk).**

## Audio Signals

High pitched tone <input type="checkbox"/>	Medium pitched tone <input checked="" type="checkbox"/>
	Power Up - Radio self-test OK
	Power Up - Radio self-test Fail
	Button Error
	Force Monitor
	Keypad Acknowledge
	Channel Busy Tone
	Individual Call Alert
	Individual Call Reminder
	Group Call Alert
	TOT Pre Alert
	Monitor Alert
	Scan Start
	Priority Channel
	Volume Select
	H/W error - Button press not accepted, tone continues until valid operation.

## Display Icons (128-channel Only)

The icons which appear on the display are:

	Scan Enabled
	Monitor Enabled
	Repeater Talkaround/Call Forward Enabled
	External Alarm Enabled
	Multicall 1-Address Selection Mode
	Multicall 2-Status Selection Mode
	Channel Selection Mode
	Coded/Clear - Scrambled speech on when icon lit.*

\* Requires additional hardware option module.

## Radio On/Off

To switch the radio on, press and release the ON/OFF switch. The radio performs a self-test and a high-pitched start-up tone will be heard.

If the error tone sounds, please contact the person in charge of your radio system or your local Motorola dealer.

To switch the radio off, press and hold the ON/OFF switch for 2 seconds, then release.

The **GM950** is a highly flexible mobile radio and can be configured in many ways to best match your specific operational requirements. The following information describes typical operation. Please contact the person in charge of your radio system or your local Motorola representative for further information.

### **Channel Selection**

#### **4-Channel Model**

To select a channel, press one of the four channel select buttons (7) for the desired channel. If the channel is available, the green, channel-selected LED (8) will light. If it is not, the error tone will sound.

#### **128-Channel Model**

To select a channel, enter channel mode (Y displayed) by pressing channel select button (9c), then use the up/down scroll buttons (7) to display the desired channel number. The channel may be used as soon as it is displayed.

#### **Channel Without Selective Call Functions**

When you have selected a channel, you are ready to transmit. You should only make a call when the channel is free ( red indicator (4) does not flash). If in doubt, press the monitor button (5) to listen to the channel.

### **Communication Procedures**

Take the microphone out of its holder. Press the transmit (PTT) key (11) on the side of the microphone while talking, release it while listening. Speak in a normal tone of voice, keeping a distance of 5-10 cm from the microphone. When transmitting the red indicator (4) will light continuously. Your radio may be configured for 'Transmit Inhibit' under certain conditions (e.g. when the channel is in use by other users) in which case, the channel busy tone will sound when you press the PTT key to indicate that transmission is inhibited.

If your radio is equipped with a transmit time out timer (TOT), a warning tone will sound a few seconds before the transmission is cut off. The radio may be programmed to inhibit retransmission within a preset time.

#### **Call Termination**

Hang up the microphone in its holder when your conversation has ended.

## Channel With Selective Call Functions

### Address Selection

You can vary up to 3 digits to select the address of another radio.

Press the Address Select button (9 d), the  icon is displayed together with the right most digit indicator.

Use the Up/Down Scroll buttons (7) to select the desired digit. Press Address Select button (9 d) again to activate the second digit and use Up/Down Scroll buttons to select the digit. Repeat to activate and select the third digit if required.

The address may be used as soon as it is displayed. (See below - Sending a Selective Call)

### Status Selection S

If Function button (6) or one of the programmable option buttons has been configured for Status Selection, the status number may be changed in a similar way to that described above for Address Selection.

### Sending a Selective Call

When you have selected channel, address or status as required you are ready to transmit. You should only make a call when the channel is free (red indicator (4) does not flash). If in doubt, press the monitor button (5) to listen to the channel.

Depending on configuration of your radio, press Base Call button (9 a), or Variable Call button (9 b), or PTT (11) to set up the call. The red indicator lights.

After sending out your call please wait until the conversation is set up.

### Receiving a Selective Call

When a call is received, the alert tone for individual call or group call is heard, and the yellow indicator (4) flashes, fast for individual call and slow for group call.

The address of the incoming caller will be flashing on the display if your radio is programmed with the Caller Identity feature.

**Call Back:** Pressing the defined call button or PTT will automatically 'call back' to this number if your radio is programmed with the Call Back feature.

Please contact the person in charge of your radio system or your local Motorola representative for further information.

## Option Button Functions

The following functions may be applicable to your radio, activated by one of the function/option buttons.

- Call Buttons - When a Call button (Base Call / Variable Call) is pressed, a specified sequence of tones is transmitted to set up your call.
- Repeater Talkaround  $\rightarrow$  - This feature enables the transmit frequency on a channel to be switched to the same as the channel's receive frequency. This will allow a radio to communicate directly with another without the need to use a repeater.
- Call Forward  $\rightarrow$  - This feature allows you to pass on calls automatically to another radio, which may be your portable radio when you are away from your vehicle.
- Monitor  $\rightarrow$  - One option button (usually 5) may be programmed as Monitor. This feature allows the user to switch between different receiver settings programmed as Receive, Monitor 1 and Monitor 2.
- Scan  $\rightarrow$  - The scan feature will cause the radio to search through predefined lists of channels looking for a condition that will cause the radio to unmute. While searching for unmute conditions, the radio is in 'active scan' (green LED flashing and Scan icon on - display models only); having found the required conditions, the radio will 'land' on the channel ( display models - green LED off, Scan icon stays on ; non-display models - green channel LED on ).
- Nuisance Channel Delete - When in scan, if the radio repeatedly 'lands' (stops) on a channel that is currently of no interest, press this option button when listening to the 'nuisance channel', to temporarily remove the channel from the scan list (until the radio is turned off then on again).
- External Alarm enable/disable  $\rightarrow$  - Turns the external alarm signal, generated by selective call decode, on/off.
- Memory Channel (display models only) - Up to two option buttons may be programmed as Memory Channels. To select the channel, press the option button for a period of less than one second. Optionally, pressing the button for longer than one second selects the current channel as that button's memory channel.
- Voice Scrambler  $\rightarrow$  - When the radio is fitted with an optional speech scrambler module, two further features may be programmed onto the option buttons.
  - Coded/Clear speech - the scrambler module may be switched on and off to suit operational requirements.

– Key Select - Allows selection of the key used by the scrambler module.

- Emergency Operation - May be set up in a number of different ways The following description is an example of one way. In an emergency situation, press the emergency button e.g. function button (6). To avoid inadvertent activation of the emergency function, the button has to be pressed for a specified time. When the radio enters emergency, it will commence a preprogrammed cycle of alternating transmit and receive periods. The emergency procedure stops only when either the radio receives a special call from base, or reaches the maximum number of transmit /receive cycles.

**Note:** This option may not be programmed in your radio!

## Computer Software Copyright

The products described in this manual may include copyrighted computer programmes stored in semiconductor memories or other media. Laws in the United States of America and other countries preserve for Motorola Europe and Motorola Inc. certain exclusive rights for copyrighted computer programmes, including the right to copy or reproduce in any form the copyrighted computer programme. Accordingly, any copyrighted computer programmes contained in the products described in this manual may not be copied or reproduced in any manner without the express written permission of the holders of the rights. Furthermore, the purchase of these products shall not be deemed to grant either directly or by implication, estoppel, or otherwise, any licence under the copyrights, patents, or patent applications of the holders of the rights, except for the normal non-exclusive royalty free licence to use that arises by operation of the law in the sale of the product.





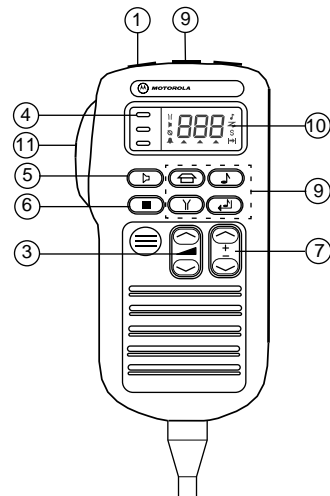
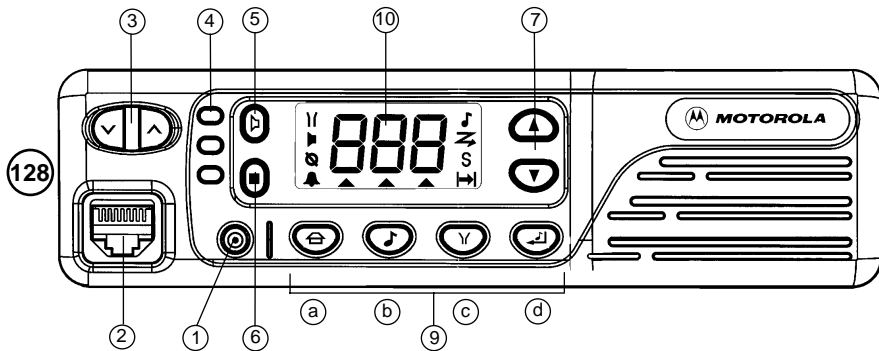
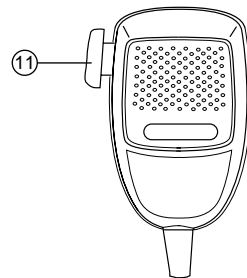
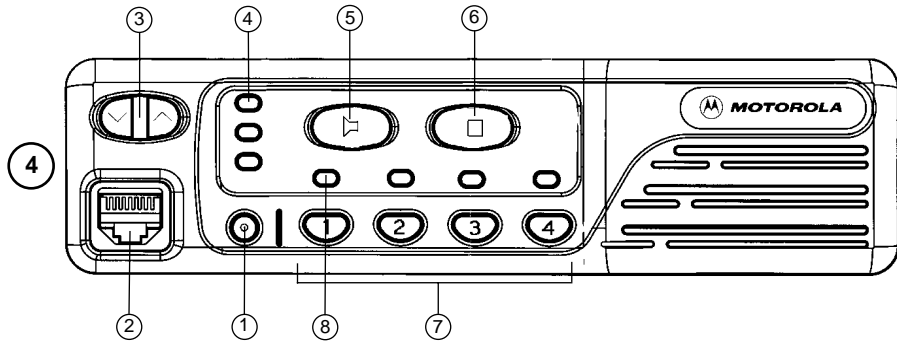

## Free Manuals Download Website

<http://myh66.com>

<http://usermanuals.us>

<http://www.somanuals.com>

<http://www.4manuals.cc>

<http://www.manual-lib.com>

<http://www.404manual.com>

<http://www.luxmanual.com>

<http://aubethermostatmanual.com>

Golf course search by state

<http://golfingnear.com>

Email search by domain

<http://emailbydomain.com>

Auto manuals search

<http://auto.somanuals.com>

TV manuals search

<http://tv.somanuals.com>