



**MOTOROLA**  
*intelligence everywhere™*

**ASTRO® XTS™ 1500**  
**Digital Portable Radio**  
**Model I**

**User Guide**

*6804113J52*

MOTOROLA, the Stylized M Logo, ASTRO, and CommPort are registered in the U.S. Patent & Trademark Office. All other product or service names are the property of their respective owners.

P25 radios contain technology patented by Digital Voice Systems, Inc.  
© Motorola, Inc. 2002. All Rights Reserved. Printed in the U.S.A. 9/18/03.

Motorola, Inc.  
8000 W. Sunrise Blvd.  
Ft. Lauderdale, FL 33322

## Product Safety and RF Exposure Compliance



Before using this product, read the operating instructions for safe usage contained in the Product Safety and RF Exposure booklet enclosed with your radio.

### ATTENTION!

This radio is restricted to occupational use only to satisfy FCC RF energy exposure requirements. Before using this product, read the RF energy awareness information and operating instructions in the Product Safety and RF Exposure booklet enclosed with your radio (Motorola Publication part number 6881095C98) to ensure compliance with RF energy exposure limits.

For a list of Motorola-approved antennas, batteries, and other accessories, visit the following web site which lists approved accessories:  
<http://www.motorola.com/cgiss/index.shtml>

### Computer Software Copyrights

The Motorola products described in this manual may include copyrighted Motorola computer programs stored in semiconductor memories or other media. Laws in the United States and other countries preserve for Motorola certain exclusive rights for copyrighted computer programs, including, but not limited to, the exclusive right to copy or reproduce in any form the copyrighted computer program. Accordingly, any copyrighted Motorola computer programs contained in the Motorola products described in this manual may not be copied, reproduced, modified, reverse-engineered, or distributed in any manner without the express written permission of Motorola. Furthermore, the purchase of Motorola products shall not be deemed to grant either directly or by implication, estoppel, or otherwise, any license under the copyrights, patents or patent applications of Motorola, except for the normal non-exclusive license to use that arises by operation of law in the sale of a product.

### Documentation Copyrights

No duplication or distribution of this document or any portion thereof shall take place without the express written permission of Motorola. No part of this manual may be reproduced, distributed, or transmitted in any form or by any means, electronic or mechanical, for any purpose without the express written permission of Motorola.

### Disclaimer

The information in this document is carefully examined, and is believed to be entirely reliable. However, no responsibility is assumed for inaccuracies. Furthermore, Motorola reserves the right to make changes to any products herein to improve readability, function, or design. Motorola does not assume any liability arising out of the applications or use of any product or circuit described herein; nor does it cover any license under its patent rights, nor the rights of others.

# ASTRO® XTS™ 1500 Digital Portable Radio, Model I Quick Reference Card

## Product Safety and RF Exposure Compliance



Before using this product, read the operating instructions for safe usage contained in the Product Safety and RF Exposure booklet enclosed with your radio.

### ATTENTION!

This radio is restricted to occupational use only to satisfy FCC RF energy exposure requirements. Before using this product, read the RF energy awareness information and operating instructions in the Product Safety and RF Exposure booklet enclosed with your radio (Motorola Publication part number 6881095C98) to ensure compliance with RF energy exposure limits.

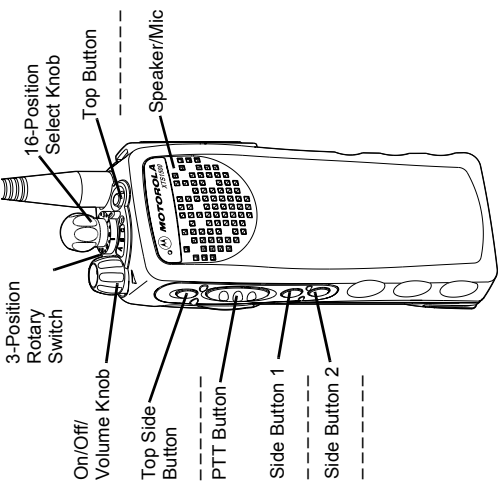

Write your radio's programmed features on the dotted lines.

## Radio On/Off

- 1 On - On/Off/Volume knob clockwise.
- 2 Off - On/Off/Volume knob counterclockwise.

## Zones/Channels

- 1 Zone - Move **Zone** switch to desired zone.
- 2 Channel - Turn **Channel Selector** switch to desired channel.

## Receiver/Transmit

- 1 Radio on and select zone/channel.
- 2 Listen for a transmission.  
**OR**  
Press and hold **Volume Set** button. Release **Volume Set** button.  
**OR**  
Press **Monitor** button and listen for activity.
- 3 Adjust volume, if necessary.
- 4 Press and hold **PTT** to transmit; release to listen.

## Send Emergency Alarm

- 1 Radio on and press **Emergency** button. You see red LED; you hear short, medium-pitched tone.

- 2 When dispatcher's acknowledgment is received, you hear four tones; alarm ends; radio exits emergency.

## Send Emergency Call

- 1 Radio on and press **Emergency** button. A short, medium-pitched tone sounds.
- 2 Press and hold **PTT**. Announce your emergency into the microphone.
- 3 Release **PTT** to end call.
- 4 Press and hold **Emergency** button for one second to exit.



# Special Radio Features

---

## Trunking System Controls

### Failsoft

The failsoft system ensures continuous radio communications during a trunked system failure. If a trunking system fails completely, the radio goes into failsoft operation, and automatically switches to its failsoft channel.

During failsoft operation:

- Your radio transmits and receives in conventional operation on a predetermined frequency.
- You hear a medium-pitched tone every 10 seconds.

When the trunking system returns to normal operation, your radio automatically leaves failsoft operation and returns to trunked operation.

### Out-of-Range

If you go out of the range of the system, and can no longer lock onto a control channel, you hear a low-pitched tone.

Your radio remains in this out-of-range condition until

- It locks onto a control channel,
- It locks onto a failsoft channel, or
- It is turned off.

## Site Lock

This feature allows your radio to lock onto a specific site and not roam among wide-area talkgroup sites. This feature should be used with caution, since it inhibits roaming to another site in a wide-area system.

### Lock or Unlock a Site

- Press the preprogrammed **Site Lock/Unlock** button.
- The site lock state changes.

## Site Change

You can force your radio to change to a new site.

### Change the Current Site

- 1 Press and hold down the preprogrammed **Site Search** button to manually force the change to a new site. You hear a tone while the radio scans for a new site.
    - Tone sounds
  - 2 When the radio finds a new site, the tone stops.
    - Tone stops
-

# Contents

---

Product Safety and RF Exposure Compliance .....	ii
Computer Software Copyrights .....	ii
Documentation Copyrights .....	ii
Disclaimer .....	ii
<b>Special Radio Features.....</b>	<b>i</b>
Trunking System Controls .....	i
Failsoft .....	i
Out-of-Range .....	i
Site Lock .....	ii
Site Change .....	ii
<b>General Radio Operation.....</b>	<b>1</b>
Notations Used in This Manual .....	1
XTS 1500 Model I Radio .....	2
Physical Features of the XTS 1500 Model I Radio .....	3
Programmable Features .....	4
LED Indicators .....	5
Alert Tones .....	5
Standard Accessories .....	8
Battery .....	8
Antenna .....	10
Belt Clip .....	11
Universal Connector Cover .....	12
Remove the Connector Cover .....	12
Attach the Connector Cover .....	12
Remote Speaker Microphone Adapter .....	13
Remove the Adapter .....	13
Attach the Adapter .....	13
Radio On and Off .....	14
Turn the Radio On .....	14
Turn the Radio Off .....	14
Zones and Channels .....	15
Select a Zone .....	15
Select a Channel .....	15
Receive / Transmit .....	16
Without Using the Volume Set and Monitor Buttons .....	16
Use the Preprogrammed Volume Set Button .....	17
Use the Preprogrammed Monitor Button .....	18

---

Conventional Mode Operation .....	19
<b>Common Radio Features .....</b>	<b>21</b>
Conventional Squelch Options .....	21
Analog Squelch .....	21
PL Defeat .....	21
Time-out Timer .....	22
Emergency .....	23
Send an Emergency Alarm .....	24
Send an Emergency Call .....	25
Scan .....	27
Turn Scan On and Off .....	27
Delete a Nuisance Channel .....	27
Conventional Scan Only .....	28
Telephone Calls (Trunking Only) .....	29
Answer a Phone Call .....	29
Private Calls (Trunking Only) .....	30
Answer a Private Call .....	30
Call Alert Paging .....	31
Answer a Call Alert Page .....	31
Repeater or Direct Operation .....	32
Select Repeater or Direct Operation .....	32
Mute .....	32
<b>Helpful Tips .....</b>	<b>33</b>
Radio Care .....	33
Cleaning .....	33
Handling .....	33
Service .....	34
Battery .....	35
Battery Life .....	35
Charging the Battery .....	35
Battery Recycling and Disposal .....	36
Antenna .....	37
Radio Operating Frequencies .....	37



---

<b>Accessories .....</b>	<b>39</b>
Antennas .....	39
Batteries .....	39
Carry Accessories .....	39
Belt Clips .....	39
Body-Worn .....	39
Chargers .....	40
Enhanced and Multi-Unit Line Cords .....	40
Surveillance Accessories .....	40
Earpieces .....	40
Headsets and Headset Accessories .....	42
Radio Interface Modules for Ear Microphones .....	42
Speaker, Remote Speaker .....	43
CommPort <sup>®</sup> Integrated Microphone/Receivers .....	43
Switches .....	43
<b>Glossary .....</b>	<b>45</b>
<b>Commercial Warranty .....</b>	<b>49</b>
<b>Index .....</b>	<b>55</b>

**Table 1: Channel Map**

Use the chart below to map the channels (Cx) and zones (Zx) for your radio.

	Z1	Z2	Z3
C1			
C2			
C3			
C4			
C5			
C6			
C7			
C8			
C9			
C10			
C11			
C12			
C13			
C14			
C15			
C16			

# General Radio Operation

---

## Notations Used in This Manual

You will notice the use of **WARNINGS**, **CAUTIONS**, and **Notes** throughout this manual. These notations are used to emphasize that safety hazards exist and that care must be taken or observed.



**An operational procedure, practice, condition, etc. exists which may result in injury or death if not carefully observed.**



An operational procedure, practice, condition, etc. exists which may result in damage to the equipment if not carefully observed.

**Note:** An operational procedure, practice, or condition, etc. which is essential to emphasize.

The following special notations identify certain items:

<i><b>Example</b></i>	<i><b>Description</b></i>
<b>Top</b> button	Buttons are shown in <b>bold</b> print.

## XTS 1500 Model I Radio

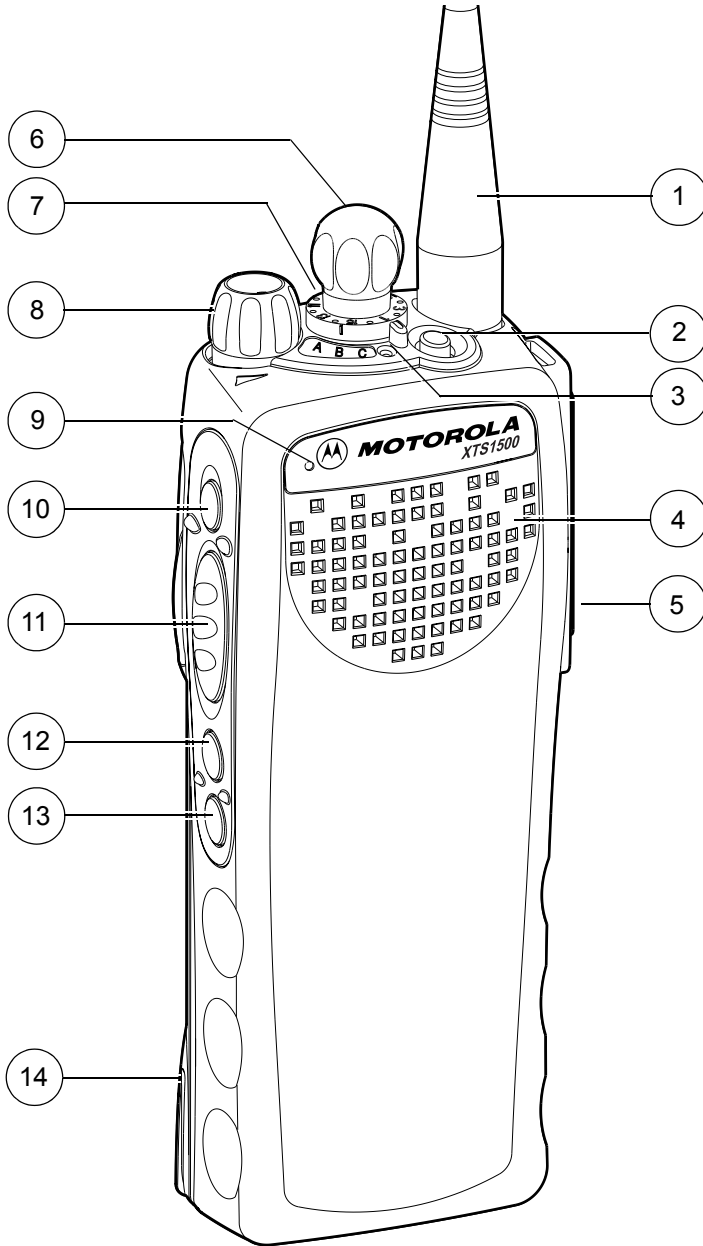

## Physical Features of the XTS 1500 Model I Radio

<i>Item</i>	<i>Page</i>	<i>Item</i>	<i>Page</i>
<b>1</b> Antenna	10	<b>8</b> <b>On/Off/Volume Control Knob</b>	14
<b>2</b> <b>Top Button</b> (programmable)		<b>9</b> Microphone	
<b>3</b> LED	5	<b>10</b> <b>Top Side (Select) Button</b> (programmable)	
<b>4</b> Speaker		<b>11</b> <b>Push-to-Talk (PTT) Button</b>	
<b>5</b> Universal Connector	12	<b>12</b> <b>Side Button 1</b> (programmable)	
<b>6</b> <b>16-Position Knob</b> (programmable)		<b>13</b> <b>Side Button 2</b> (programmable)	
<b>7</b> <b>3-Position Concentric Switch</b> (programmable)		<b>14</b> Battery	8

## Programmable Features

The programmable controls on your radio can be programmed by a qualified technician to operate certain software-activated features. The features that can be assigned to these controls, and the page numbers where these features can be found, are listed below.

**Table 1: Programmable Features**

<i>Feature</i>	<i>Page</i>	<i>Feature</i>	<i>Page</i>
Call Response	29	PL Defeat	21
Channel Selection	15	Repeater/Direct	32
Dynamic Priority	28	Scan On/Off	27
Emergency	23	Site Lock/Unlock	ii
Monitor	18	Site Search	ii
Mute	32	Volume Set	17
Nuisance Delete	27	Zone Selection	15
Phone	29		

**Any references in this manual to controls that are “preprogrammed” means that a qualified radio technician must use the radio’s programming software to assign a feature to a control.**

## LED Indicators

**Table 2: LED Indicators**

<i><b>This LED Color:</b></i>	<i><b>indicates:</b></i>
RED (Non-flashing)	Transmitting
RED (Flashing)	<ul style="list-style-type: none"> <li>• Channel Busy</li> </ul> OR <ul style="list-style-type: none"> <li>• Low Battery (lights while transmitting)</li> </ul>
GREEN (Flashing)	Receiving Individual Call

## Alert Tones

Your radio uses alert tones to inform you of radio conditions.

**Table 3: Alert Tones**

<i><b>You hear:</b></i>	<i><b>Tone Name</b></i>	<i><b>Heard:</b></i>
<i>Short, Low-Pitched Tone</i>	Invalid Key-Press	when the wrong key is pressed.
	Radio Self-Test Failed	when the radio fails the power-up self test.
	Reject	when an unauthorized request is made.
	Time-Out Timer Warning	four seconds before time out.

**Table 3: Alert Tones (Continued)**

<b><i>You hear:</i></b>	<b><i>Tone Name</i></b>	<b><i>Heard:</i></b>
<i>Long, Low-Pitched Tone</i>	No ACK Received	when the radio does not receive an acknowledgment.
	Time-Out Timer Timed Out	after time out.
	Talk Prohibit/ PTT Inhibit	when the PTT button is pressed, and transmissions are prevented.
	Out-of-Range	when the PTT button is pressed, but the radio is out of range of the system.
	Invalid Mode	when the radio is set to an unprogrammed channel.
	Individual Call Warning Tone	when the radio is in Individual Call without any activity for more than 6 seconds.
<i>A Group of Low-Pitched Tones (Busy Tone)</i>	Busy	when the system is busy.
<i>Short, Medium- Pitched Tone</i>	Valid Key-Press	when the correct key is pressed.
	Radio Self-Test Pass	when the radio passes its power-up self-test.
	Priority Channel Received	when activity on a priority channel is received.
	Emergency Alarm Entry	when entering the emergency state.
	Central Echo	when the central controller has received a request from a radio.



**Table 3: Alert Tones (Continued)**

<b><i>You hear:</i></b>	<b><i>Tone Name</i></b>	<b><i>Heard:</i></b>
<i>Long, Medium-Pitched Tone</i>	Volume Set	when the Volume Set button is pressed.
	Emergency Exit	upon exiting the emergency state.
<i>A Group of Medium-Pitched Tones</i>	Failsoft	when the trunking system fails.
	Automatic Call Back	when the voice channel is available from the previous request.
	Talk Permit	(When pressing the PTT button) verifies the system is accepting transmissions.
	Console Acknowledge	when a status, emergency alarm, or reprogram request acknowledgment is received.
	Received Individual Call	when a Call Alert, or Private Conversation Call is received.
<i>Short, High-Pitched Tone (Chirp)</i>	Low-Battery Chirp	when the battery is below the preset threshold value.
<i>Ringing</i>	Phone Call Received	when a landline phone call is received.

## Standard Accessories

### Battery



To avoid a possible explosion:

- **DO NOT** replace the battery in any area labeled “hazardous atmosphere”.
- **DO NOT** discard batteries in a fire.

### Charge the Battery

The Motorola approved battery shipped with your radio is uncharged. Prior to using a new battery, charge it for a minimum of 16 hours to ensure optimum capacity and performance.

For a list of Motorola approved batteries available for use with your XTS 1500 radio, see “Batteries” on page 39.

**Note:** When charging a battery attached to a radio, turn the radio off to ensure a full charge.

### ***Battery Charger***

To charge the battery, place the battery, with or without radio, in a Motorola-approved charger. The charger’s LED indicates the charging progress; see your charger’s user guide. For a list of chargers, see “Chargers” on page 40.

### Attach the Battery

- 1 With the radio off, fit the three extensions at the bottom of the battery into the bottom slots on the radio.

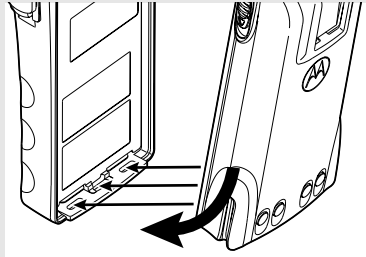

- 2 Press the top of the battery against the radio until both latches click into place.

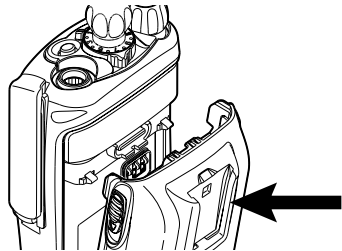

---

### Remove the Battery

- 1 With the radio off, slide down the latches on the sides of the battery.

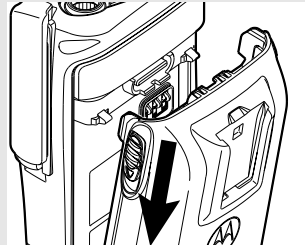

- 2 Pull the top of the battery away from the radio.

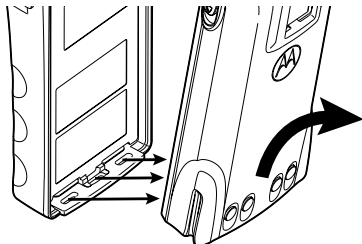

## Antenna

For information regarding other available antennas, see page 39.

### Attach the Antenna

With the radio off, turn the antenna clockwise to attach it.



### Remove the Antenna

With the radio off, turn the antenna counter-clockwise to remove it.

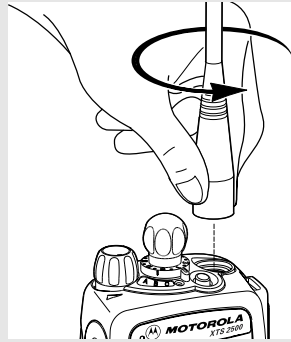

## Belt Clip

### Attach the Belt Clip

- 1 Align the grooves of the belt clip with those of the battery.

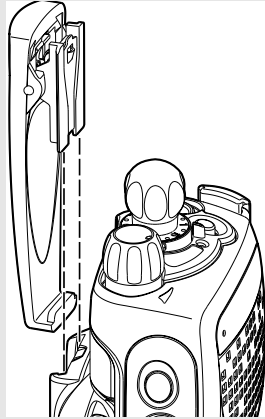

- 2 Press the belt clip downward until you hear a “click.”
- 

### Remove the Belt Clip

- 1 Use a flat-bladed object to press the belt clip tab away from the battery.

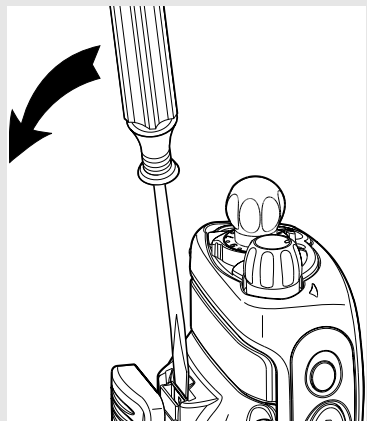

- 2 Slide the belt clip upward to remove it.
-

## Universal Connector Cover

The universal connector cover is located on the antenna side of the radio. It is used to connect certain accessories to the radio.

**Note:** To prevent damage to the connector, shield it with the connector cover when not in use.

### Remove the Connector Cover

- 1 Insert a flat-bladed screwdriver into the area between the bottom of the cover and the slot below the connector.
- 2 Hold the top of the cover with your thumb while you pry the bottom of the cover away from the radio with the screwdriver.

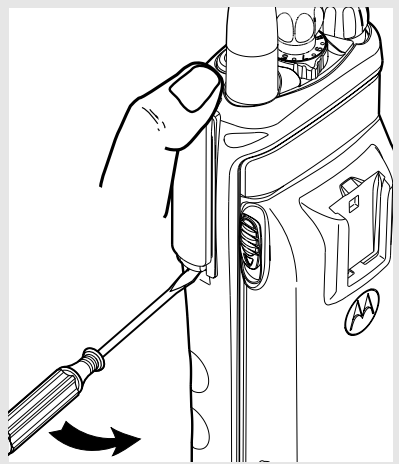

### Attach the Connector Cover

- 1 Insert the hooked end of the cover into the top of the connector. Press downward on the cover's top to seat it into the slot.
- 2 Press the cover's lower tab below the connector until it snaps in place.

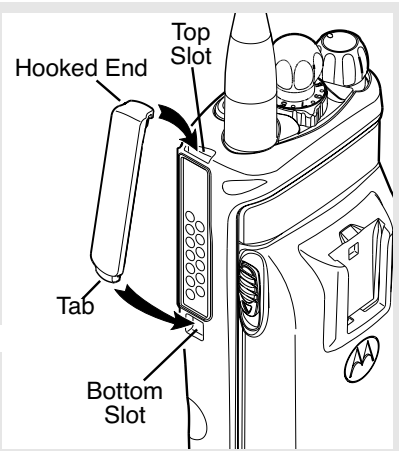

## Remote Speaker Microphone Adapter

The Remote Speaker Microphone (RSM) adapter is located on the back of the radio, just above the battery. **It must be used to connect the RSM accessories (see page 43) to the radio.** If the RSM is not used, the adapter should be removed.

### Remove the Adapter

Lift the larger side (below the antenna port) of the adapter away from the radio using your finger.

If you cannot easily remove the adapter with your finger, use a small, flat blade screwdriver to pry the larger end side of the adapter away from the radio.

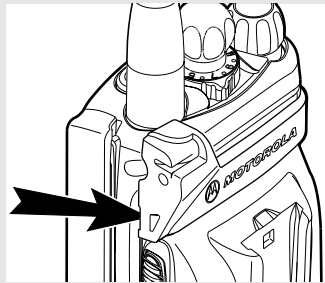

### Attach the Adapter

- 1 With the Motorola side of the adapter facing out, snap the smaller end of the adapter into place in the shroud indent, below the **On/Off Volume Control Knob**.

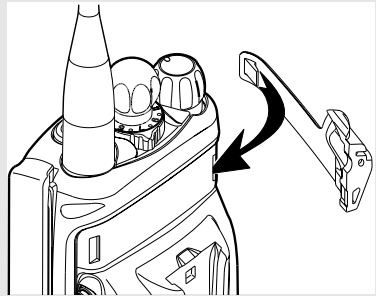

- 2 Snap the larger end of the adapter into place in the shroud indent, below the antenna port.

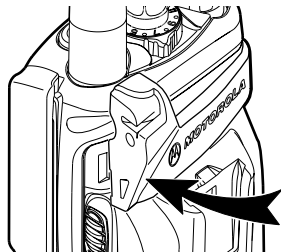

## Radio On and Off

### Turn the Radio On

Turn the **On/Off/Volume Control** knob clockwise.

- If the test is successful, you hear a medium-pitched tone.
- If the test is unsuccessful, you hear a low-pitched tone. Turn off the radio, check the battery, and turn the radio on.

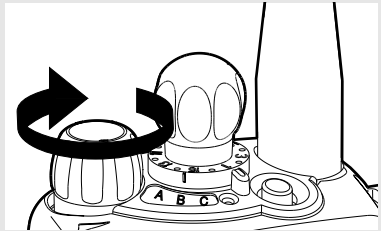

### Turn the Radio Off

Turn the **On/Off/Volume Control** knob counterclockwise until it clicks.

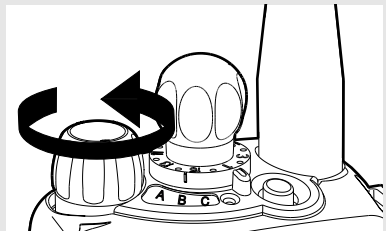



## Zones and Channels

A zone is a grouping of channels. A channel is a group of radio characteristics, such as transmit/receive frequency pairs.

Before you use your radio to receive or send messages, you should select the zone.

### Select a Zone

- 1 If a control on your radio has been preprogrammed as the **Zone** switch, move the **Zone** switch to the position for the zone you want.
- 2 If the zone you selected is unprogrammed, you hear a long, medium-pitched tone until you select a programmed zone.
  - Long, medium-pitched tone

---

### Select a Channel

- 1 After you selected the zone you want, turn the preprogrammed **Channel Selector** switch to the desired channel.
- 2 If the channel you selected is unprogrammed, you hear a long, medium-pitched tone until you select a programmed channel.



## Receive / Transmit

Radio users who switch from analog to digital radios often assume that the lack of static on a digital channel is an indication that the radio is not working properly. This is not the case. Digital technology quiets the transmission by removing the “noise” from the signal and allowing only the clear voice or data information to be heard.

This section emphasizes the importance of knowing how to monitor a channel for traffic before keying-up to send a transmission.

### Without Using the Volume Set and Monitor Buttons

- 1 Turn the radio on and select the desired zone and channel.
- 2 Listen for a transmission.
- 3 Adjust the **Volume Control** knob if necessary.

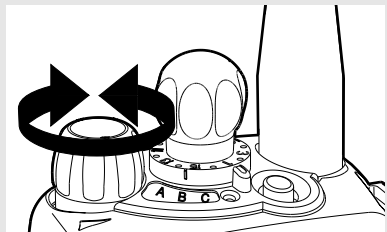

- 4 Press and hold the **PTT** button to transmit. The LED lights RED while transmitting.
- 5 Release the **PTT** button to receive (listen).

## Use the Preprogrammed Volume Set Button

- 1 Turn the radio on and select the desired zone and channel. See **Turn the Radio On**, page 14 and **Zones and Channels**, page 15.
- 2 Press and hold the **Volume Set** button to hear the volume set tone.
- 3 Release the **Volume Set** button.
- 4 Adjust the **Volume Control** Knob if necessary.

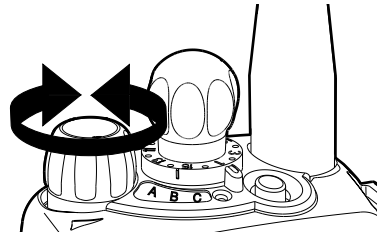

- 5 Press and hold the **PTT** button to transmit. LED lights RED while transmitting.
  - 6 Release the **PTT** button to receive (listen).
-

## Use the Preprogrammed Monitor Button

- 1 Turn the radio on and select the desired zone and channel.
- 2 Press the Monitor button and listen for activity. (See the following **Conventional Mode Operation.**)
- 3 Adjust the **Volume Control** knob if necessary.

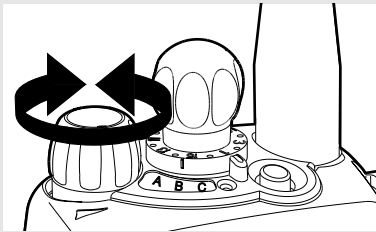

- 4 Press and hold the **PTT** button to transmit. The LED lights RED while transmitting.
- 5 Release the **PTT** button to receive (listen).

## Conventional Mode Operation

Your radio may be programmed to receive Private-Line® (PL) calls.

- 1** Momentarily press the **Monitor** button to listen for activity.
- 2** Press and hold the **Monitor** button to set continuous monitor operation. (The duration of the button press is programmable.)
- 3** Press the **Monitor** button again, or the **PTT** button, to return to the original squelch setting.

**Note:** If you try to transmit on a receive-only channel, you will hear an invalid tone until you release the **PTT** button.

# Notes

# Common Radio Features

---

## Conventional Squelch Options

### Analog Squelch

Tone Private Line (PL), Digital Private-Line (DPL), and carrier squelch can be available (preprogrammed) per channel.

When in...	this condition occurs:
Carrier squelch (C)	You hear all traffic on a channel.
PL, DPL	The radio responds only to your messages.

### PL Defeat

With this feature, you can override any coded squelch (DPL, PL, or network ID) that might be programmed to a channel.

Place the preprogrammed **PL Defeat** switch in the **PL Defeat** position. You can now hear any activity on the channel. The radio is muted if no activity is present.

## Time-out Timer

The time-out timer turns off your radio's transmitter. The timer is set for 60 seconds at the factory, but it can be programmed from 0 to 7.75 minutes (465 seconds) by a qualified radio technician.

- |          |  |   |
|----------|--|---|
| <b>1</b> | Hold down the <b>PTT</b> longer than the programmed time. You will hear a short, low-pitched warning tone, the transmission is cut-off, and the LED will go out until you release the <b>PTT</b> . | <ul style="list-style-type: none"><li>• Short warning tone</li><li>• Transmission is cut-off</li><li>• LED goes out</li></ul> |
| <b>2</b> | Release the <b>PTT</b> button.   | <ul style="list-style-type: none"><li>• LED re-lights</li><li>• Timer resets</li></ul>  |
| <b>3</b> | Press the <b>PTT</b> to re-transmit. Time-out timer restarts.  | <ul style="list-style-type: none"><li>• Timer restarts</li><li>• RED LED</li></ul>  |



## Emergency

If the top (orange) button is programmed to send an emergency signal, then this signal overrides any other communication over the selected channel.

Your radio can be programmed for the following:

- Emergency Alarm
- Emergency Alarm with Emergency Call
- Emergency Call

Consult a qualified radio technician for emergency programming of your radio.

## Send an Emergency Alarm

An Emergency Alarm will send a data transmission to the dispatcher, identifying the radio sending the emergency.

- 1 With your radio turned on, press the **Emergency** button. The red LED lights, and you hear a short, medium-pitched tone.
  - Red LED
  - Short tone

**Note:** To exit emergency at any time, press and hold the **Emergency** button for about a second.

- 2 When you receive the dispatcher's acknowledgment, you hear four tones, the alarm ends, and the radio exits the emergency mode.
  - Four tones
  - Alarm ends
  - Radio exits emergency

If no acknowledgement is received, the alarm ends after the number of retries is performed, and the radio exits the emergency mode.

  - Alarm ends
  - Radio exits emergency

**Note: For Emergency Alarm with Emergency Call:** The radio enters the Emergency Call state either after it receives the dispatcher's acknowledgment, or if you press the **PTT** button while in Emergency Alarm. Go to step 2 of "Send an Emergency Call" on page 25.

---

## Send an Emergency Call

An Emergency Call will send a type of dispatch giving your radio priority access to channels.

- 1 With your radio turned on, press the **Emergency** button. A short, medium-pitched tone sounds.
  - Short tone

**Note:** To exit emergency at any time, press and hold the **Emergency** button.

- 2 Press and hold the **PTT** button and announce your emergency into the microphone.
- 3 Release the **PTT** button to end the transmission and wait for a response from the dispatcher.
- 4 Press and hold the **Emergency** button for about a second to exit emergency.

The radio operates in the normal dispatch manner while in Emergency Call, except, if enabled, it will return to one of the following:

<b><i>Using this operation:</i></b>	<b><i>means you will talk...</i></b>
1. Tactical/Non-Revert	on the channel you selected before you entered the emergency state.
2. Non-Tactical/Revert	on a preprogrammed emergency channel. The emergency alarm is sent to this same channel.

**Note:** For ALL Emergency signals:

- You can change channels while in Emergency operation if the new channel is also programmed for Emergency. The emergency alarm or call continues on the new channel.
- If the new channel is NOT programmed for Emergency, an invalid tone sounds until you exit the Emergency state or change to a channel programmed for emergency.

## Scan

The scan feature allows you to monitor traffic on different channels by scanning a preprogrammed list of channels. The list must be preprogrammed by a qualified technician.

### Turn Scan On and Off

#### Use the Preprogrammed Scan On/Off Switch

Place the **Scan On/Off** Switch or Button in the “scan on” or “scan off” position.

### Delete a Nuisance Channel

When the radio scans to a channel that you do not wish to hear (nuisance channel), you can temporarily delete the channel from the scan list.

- 1 When the radio is locked onto the channel to be deleted, press the preprogrammed **Nuisance Delete** button.

Repeat this step to delete more channels.

**Note:** You cannot delete priority channels or the designated transmit channel.

- 2 The radio continues scanning the remaining channels in the list. To resume scanning the deleted channel, change channels or turn scan off and then back on again.

---

## Conventional Scan Only

### Make a Dynamic Priority Change

While the radio is scanning, the dynamic priority change feature lets you *temporarily* change any channel in a scan list (except the priority-one channel) to the priority-two channel. The replaced priority-two channel becomes a non-priority channel. This change remains in effect until scan is turned off, then scanning reverts back to the preprogrammed state.

- 1 When the radio is locked onto the channel to be designated as priority-two, press the preprogrammed **Dynamic Priority** button.

**Note:** The priority-one channel cannot be changed to priority-two.

- 2 The radio continues scanning the remaining channels in the list. To resume scanning the preprogrammed priority-two channel, you must leave and re-enter scan operation.
-

## Telephone Calls (Trunking Only)

Use your radio to receive standard phone calls. A landline phone can be used to call a radio.

### Answer a Phone Call

#### Use the Preprogrammed Call Response Button

- 1** When a phone call is received you hear telephone-type ringing and the LED flashes GREEN.
    - Telephone-type ringing
    - LED flashes GREEN
  - 2** Press the **Call Response** or **Phone** button within 20 seconds after the call indicators begin.
  - 3** Press and hold the **PTT** button to talk; release it to listen.
  - 4** Press the **Call Response** button to hang up and return to the home display.
-

## Private Calls (Trunking Only)

These one-to-one calls between two radios are not heard by others in the current talkgroup.

### Answer a Private Call

Use the Preprogrammed Call Response Button.

- 1 When a private call is received you hear two alert tones and the LED flashes GREEN.
    - Two alert tones
    - LED flashes GREEN
  - 2 Press the preprogrammed **Call Response** button within 20 seconds.
  - 3 Press and hold the **PTT** button to talk; release it to listen.
  - 4 Press the **Call Response** button to hang up.
-



## Call Alert Paging

Call Alert allows your radio to work like a pager.

### Answer a Call Alert Page

- 1 When a Call Alert Page is received, you hear four repeating alert tones and the LED flashes GREEN.
    - Four repeating tones
    - LED flashes GREEN
  - 2 Press and hold the **PTT** button to talk, release it to listen.
-

## Repeater or Direct Operation

Also known as TALKAROUND operation, **DIRECT** lets you bypass the repeater and connect directly to another radio. The transmit and receive frequencies are the same.

**REPEATER** operation increases the radio's range by connecting with other radios through a repeater. Transmit and receive frequencies are different.

### Select Repeater or Direct Operation

Place the preprogrammed  
**Repeater/Direct** switch in  
Repeater or Direct position.

## Mute

**Mute** is available on the Switches.

# Helpful Tips

---

## Radio Care

### Cleaning

To clean the external surfaces of your radio:

- 1 Combine one teaspoon of mild dishwashing detergent to one gallon of water (0.5% solution).
- 2 Apply the solution sparingly with a stiff, non-metallic, short-bristled brush, making sure excess detergent does not get entrapped near the connectors, controls or crevices. Dry the radio thoroughly with a soft, lint-free cloth.
- 3 Clean battery contacts with a lint-free cloth to remove dirt or grease.



**Caution**

**Do not use solvents to clean your radio. Spirits may permanently damage the radio housing.**

**Do not submerge the radio in the detergent solution.**

### Handling

- Do not pound, drop, or throw the radio. Never carry the radio by the antenna.
- Avoid subjecting the radio to an excess of liquids.
- Avoid subjecting the radio to corrosives, solvents or spirits.
- Do not disassemble the radio.
- Keep the accessory-connector cover in place until ready to use the connector. Replace the cover immediately once the accessory has been disconnected.

## Service

Proper repair and maintenance procedures will assure efficient operation and long life for this product. A Motorola maintenance agreement will provide expert service to keep this and all other communication equipment in perfect operating condition. A nationwide service organization is provided by Motorola to support maintenance services. Through its maintenance and installation program, Motorola makes available the finest service to those desiring reliable, continuous communications on a contract basis. For a contract service agreement, please contact your nearest Motorola service or sales representative, or an authorized Motorola dealer.

Express Service Plus (ESP) is an optional extended service coverage plan, which provides for the repair of this product for a period of three years from the date of shipment from the factory, or the date of delivery if purchased from an authorized Motorola two-way radio dealer. For more information about ESP, contact the Motorola Radio Support Center at 3761 South Central Avenue, Rockford, IL 61102 (800) 227-6772 / (847)725-4200.

## Battery

### Battery Life

Battery life is determined by several factors. Among the more critical are the regular overcharge of batteries and the average depth of discharge with each cycle. Typically, the greater the overcharge and the deeper the average discharge, the fewer cycles a battery will last. For example, a battery which is overcharged and discharges 100% several times a day, will last fewer cycles than a battery that receives less of an overcharge and is discharged to 50% per day. Further, a battery which receives minimal overcharging and averages only 25% discharge, will last even longer.

### Charging the Battery

Motorola batteries are designed specifically to be used with a Motorola charger and vice-versa. Charging in non-Motorola equipment may lead to battery damage and void the battery warranty. Motorola-authorized battery chargers may not charge batteries other than the ones listed on page 39.

The battery should be at about 77°F (25°C) (room temperature), whenever possible. Charging a cold battery (below 50° F [10°C]) may result in leakage of electrolyte and ultimately in failure of the battery. Charging a hot battery (above 95°F [35°C]) results in reduced discharge capacity, affecting the performance of the radio. Motorola rapid-rate battery chargers contain a temperature-sensing circuit to ensure that batteries are charged within the temperature limits stated above.

### Battery Charge Status

Your radio can indicate your battery's charge status by the following:

#### ***LED and Sounds***

- you see the LED flash red when the PTT Button is pressed indicating low battery
- you hear a low-battery “chirp” (short, high-pitched tone)

## **Battery Recycling and Disposal**

Nickel-cadmium (NiCd) rechargeable batteries can be recycled. However, recycling facilities may not be available in all areas. Under various U.S. state laws and the laws of several other countries, NiCd batteries must be recycled and cannot be disposed of in landfills or incinerators. Contact your local waste management agency for specific requirements and information in your area.

Motorola fully endorses and encourages the recycling of NiCd batteries. In the U.S. and Canada, Motorola participates in the nationwide Rechargeable Battery Recycling Corporation (RBRC) program for NiCd battery collection and recycling. Many retailers and dealers participate in this program.

For the location of the drop-off facility closest to you, access RBRC's Internet web site at [www.rbrc.com](http://www.rbrc.com) or call 1-800-8-BATTERY. This internet site and telephone number also provide other useful information concerning recycling options for consumers, businesses, and governmental agencies.

## Antenna

### Radio Operating Frequencies

Before installing the antenna, make sure it matches your radio's operating frequency. Antennas are frequency sensitive and are color coded according to their frequency range. The color code indicator is located in the center of the antenna's base.

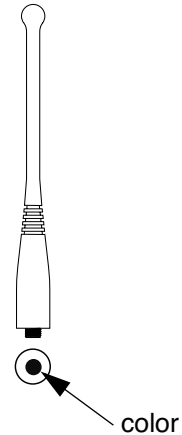

The following antenna types are compatible with your radio:

Antenna type	Approx. length		Insulator color code	Frequency range	Antenna kit no.
	in.	mm			
800 MHz Whip, Halfwave	7	175	RED	806-870 MHz	NAF5037
800 MHz Stubby, Quarterwave	3.3	83	WHITE	806-870 MHz	NAF5042
700/800 MHz Whip	7	185	GREEN	764-870 MHz	NAF5080

# Notes



# Accessories

---

Motorola provides the following approved accessories to improve the productivity of your XTS 1500 portable two-way radio.

For a list of Motorola-approved antennas, batteries, and other accessories, visit the following web site which lists approved accessories: <<http://www.motorola.com/cgiss/index.shtml>>

## Antennas

NAF5037	800 MHz whip, halfwave (806-870 MHz)
NAF5042	800 MHz stubby, quarterwave (806-870 MHz)
NAF5080	700/800 MHz whip (764-870 MHz)

## Batteries

NTN9815	NiCd High Capacity
NTN9816	NiCd High Capacity, Factory Mutual Intrinsically Safe
NTN9857	NiMH Ultra-High Capacity, Factory Mutual Intrinsically Safe
NTN9858	NiMH Ultra-High Capacity

## Carry Accessories

### Belt Clips

HLN6853	Belt Clip, 2 1/4 inch
---------	-----------------------

### Body-Worn

NNTN4115	Carrying case, Leather with 3" Swivel Belt Loop and T-strap
NNTN4116	Carrying case, Leather with 2.5" Swivel Belt Loop and T-strap

NNTN4117	Carrying case, Leather with 3" Belt Loop and T-strap
----------	--

## Chargers

NTN1177	Multi-Unit, Dual Rate, Rapid: 110 V
NTN1178	Multi-Unit, Dual Rate, Rapid: 240 V (3-prong UK plug)
NTN1179	Multi-Unit, Rapid, 240V (UK 13 MAP Plug)
NTN1667	Tri-Chemistry, 110V
NTN1668	Tri-Chemistry, 220V Single Unit Charger (2 Prong Euro Plug)
NTN1669	Tri-Chemistry, 230V
NTN1873	IMPRES™ Rapid, 110V Single Unit Charger
NTN1874	IMPRES™ Rapid, 220V Single Unit Charger
NTN1875	IMPRES™ Rapid, 240V Single Unit Charger
NTN7209	Single-Unit Dual Rate, Rapid w/o Cord
NTN4796	Multi-unit, tri-chemistry, rapid rate, 110 V

## Enhanced and Multi-Unit Line Cords

NTN7373	110 V interchangeable line
NTN7374	220 V interchangeable line (2-prong Euro plug)
NTN7375	240 V interchangeable line (3-prong UK plug)

## Surveillance Accessories

### Earpieces

BDN6641	Ear mic, high noise level up to 105 dB, grey (must order BDN6671 interface module)
---------	--

BDN6664	Earpiece with standard earphone, beige
BDN6665	Earpiece with extra-loud earphone (exceeds OSHA limits), beige
BDN6666	Earpiece with volume control, beige
BDN6667	Earpiece, mic and PTT combined, beige
BDN6668	Earpiece, mic and PTT separate, beige
BDN6669	Earpiece, mic and PTT combined, with extra-loud earphone (exceeds OSHA limits), beige
BDN6670	Earpiece, mic and PTT separate with extra-loud earphone (exceeds OSHA limits), beige
BDN6677	Ear mic, standard, noise up to 95 dB (must order BDN6671 interface module), black
BDN6678	Ear mic, standard, noise up to 95 dB (must order BDN6671 interface module), beige
BDN6726	Earpiece with standard earphone, black
BDN6727	Earpiece with extra-loud earphone (exceeds OSHA limits), black
BDN6728	Earpiece with volume control, black
BDN6729	Earpiece, mic and PTT combined, black
BDN6730	Earpiece, mic and PTT separate, black
BDN6731	Earpiece, mic and PTT combined, with extra-loud earphone (exceeds OSHA limits), black
BDN6732	Earpiece, mic and PTT separate, with extra-loud earphone (exceeds OSHA limits), black
BDN6780	Earbud, single with Mic and PTT combined, beige
BDN6781	Earbud, single, receive only, black

## Headsets and Headset Accessories

BDN6635	Heavy-duty VOX headset with noise-canceling boom mic (requires BDN6673 adapter)
BDN6636	Heavy-duty VOX headset with throat mic (requires BDN6673)
BDN6645	Noise-canceling boom mic headset with PTT on earcup
BDN6673	Headset adapter cable (for use with BDN6635 and BDN6645)
BDN6676	Jedi adapter
NMN1020	Safety helmet headset (requires BDN6676 adapter)
NMN6245	Light-weight headset
NMN6246	Ultralite headset with boom mic
NMN6258	Over-the-head headset with in-line PTT
NMN6259	Medium-weight, dual headset with NC mic
RMN4049	Jedi "TEMCO" temple transducer

## Radio Interface Modules for Ear Microphones

BDN6671	Push-to-talk (PTT) and voice-activated (VOX) interface module (for use with BDN6641, BDN6677 and BDN6678)
BDN6708	PTT interface module (for use with BDN6641, BDN6677 and BDN6678)

## Speaker, Remote Speaker

NMN6191	RSM noise-canceling (includes 6.0' coiled cord assembly, 3.5mm earjack, swivel clip, quick disconnect)
NMN6193	Remote speaker mic
ZMN6031	Speaker mic, 3-piece
ZMN6032	Speaker mic, 2-piece
ZMN6038	Speaker mic, 2-piece, extra loud
ZMN6039	Speaker mic, 3-piece, extra loud

## CommPort<sup>®</sup> Integrated Microphone/Receivers

NTN1624	CommPort with palm PTT
NTN1625	CommPort ear mic with PTT for noise levels up to 100 dB (requires BDN6676 adapter)
NTN1663	CommPort ear mic with ring PTT for noise levels up to 100 dB (requires BDN6676 adapter)
NTN1736	CommPort ear mic with snap-on side PTT for noise levels up to 100 dB (requires BDN6676 adapter)

## Switches

0180300E83	Remote PTT body switch
------------	------------------------

# Notes

# Glossary

---

This is a list of specialized terms used in this manual.

<b>ACK</b>	Acknowledgment of communication.
<b>Active Channel</b>	A channel that has traffic on it.
<b>Analog Signal</b>	An RF signal that has a continuous nature rather than a pulsed or discrete nature.
<b>ASTRO 25 Trunking</b>	Motorola standard for wireless digital trunked communications.
<b>ASTRO Conventional</b>	Motorola standard for wireless analog or digital conventional communications.
<b>Call Alert</b>	Privately page an individual by sending an audible tone.
<b>Carrier Squelch</b>	Feature that responds to the presence of an RF carrier by opening or unmuting (turning on) a receiver's audio circuit. A squelch circuit silences the radio when no signal is being received so that the user does not have to listen to noise.
<b>Central Controller</b>	A software controlled, computer-driven device that receives and generates data for the trunked radios assigned to it. It monitors and directs the operations of the trunked repeaters.
<b>Channel</b>	A group of characteristics such as transmit/receive frequency pairs, radio parameters, and encryption encoding.
<b>Control Channel</b>	In a trunking system, one of the channels that is used to provide a continuous, two-way/data communications path between the central controller and all radios on the system.
<b>Conventional</b>	Typically refers to radio-to-radio communications, sometimes through a repeater. (See Trunking.)

<b>Cursor</b>	A visual tracking marker (a blinking line) that indicates a location on the display.
<b>Digital Private Line (DPL)</b>	A type of coded squelch using data bursts. Similar to PL except a digital code is used instead of a tone.
<b>Digital Signal</b>	An RF signal that has a pulsed, or discrete nature, rather than a continuous nature.
<b>Dispatcher</b>	An individual who has radio system management duties.
<b>Dynamic Regrouping</b>	A feature that allows the dispatcher to temporarily reassign selected radios to a single special channel so they can communicate with each other.
<b>Failsoft</b>	A feature that allows communications to take place even though the central controller has failed. Each trunked repeater in the system will transmit a data word informing every radio that the system has gone into failsoft.
<b>FCC</b>	Federal Communications Commission.
<b>Hang Up</b>	Disconnect.
<b>LED</b>	Light-emitting diode.
<b>Monitor</b>	Check channel activity by pressing the Monitor button. If the channel is clear, you will hear static. If the channel is in use, you will hear conversation. It also serves as a way to check the volume level of the radio, as the radio will “open the squelch” when pressing the monitor button.
<b>Network Access Code</b>	Network Access Code (NAC) operates on digital channels to reduce voice channel interference between adjacent systems and sites.



<b>NiCd</b>	Nickel Cadmium.
<b>NiMH</b>	Nickel Metal Hydride.
<b>Non-tactical/Revert</b>	The user will talk on a preprogrammed emergency channel. The emergency alarm is sent on this same channel.
<b>Page</b>	A one-way alert, with audio and/or display messages.
<b>Personality</b>	A set of unique features specific to a radio.
<b>Preprogrammed</b>	A feature that has been assigned in advance by a qualified technician.
<b>Private (Conversation) Call</b>	Allows you respond to a private conversation with another radio user in the group.
<b>Private Line (PL)</b>	A sub-audible tone that is transmitted such that only receivers decoding this tone will hear the message.
<b>Programmable</b>	A radio control that can have a radio feature assigned to it.
<b>PTT</b>	Push-To-Talk — the <b>PTT</b> button engages the transmitter and puts the radio in transmit (send) operation when pressed.
<b>Radio Frequency (RF)</b>	The part of the general frequency spectrum between the audio and infrared light regions (about 10 kHz to 10,000,000 MHz).
<b>Repeater</b>	A conventional radio feature, where you talk through a receive/transmit facility (repeater), that re-transmits received signals in order to improve communications range and coverage.
<b>Selective Switch</b>	Any digital P25 traffic having the correct Network Access Code and the correct talkgroup.

<b>Squelch</b>	Special electronic circuitry added to the receiver of a radio which reduces, or squelches, unwanted signals before they are heard in the speaker.
<b>Standby</b>	An operating condition whereby the radio's speaker is muted but still continues to receive data.
<b>Tactical/Non-revert</b>	The user will talk on the channel that was selected before the radio entered the emergency state.
<b>Talkaround</b>	Bypass a repeater and talk directly to another unit for easy local unit-to-unit communications.
<b>Talkgroup</b>	An organization of radio users who communicate with each other.
<b>Trunking</b>	The automatic sharing of communications paths between a large number of users. (See Conventional.)
<b>Zone</b>	A grouping of channels.

# Commercial Warranty

---

## Limited Warranty

### MOTOROLA COMMUNICATION PRODUCTS

#### I. WHAT THIS WARRANTY COVERS AND FOR HOW LONG:

MOTOROLA INC. (“MOTOROLA”) warrants the MOTOROLA manufactured Communication Products listed below (“Product”) against defects in material and workmanship under normal use and service for a period of time from the date of purchase as scheduled below:

ASTRO XTS 1500 Portable Units	One (1) Year
Product Accessories	One (1) Year

Motorola, at its option, will at no charge either repair the Product (with new or reconditioned parts), replace it (with a new or reconditioned Product), or refund the purchase price of the Product during the warranty period provided it is returned in accordance with the terms of this warranty. Replaced parts or boards are warranted for the balance of the original applicable warranty period. All replaced parts of Product shall become the property of MOTOROLA.

This express limited warranty is extended by MOTOROLA to the original end user purchaser only and is not assignable or transferable to any other party. This is the complete warranty for the Product manufactured by MOTOROLA. MOTOROLA assumes no obligations or liability for additions or modifications to this warranty unless made in writing and signed by an officer of MOTOROLA. Unless made in a separate agreement between MOTOROLA and the original end user purchaser, MOTOROLA does not warrant the installation, maintenance or service of the Product.

MOTOROLA cannot be responsible in any way for any ancillary equipment not furnished by MOTOROLA which is attached to or used in connection with the Product, or for operation of the Product with any ancillary equipment, and all such equipment is expressly excluded from this warranty. Because each system which may use

the Product is unique, MOTOROLA disclaims liability for range, coverage, or operation of the system as a whole under this warranty.

## **II. GENERAL PROVISIONS:**

This warranty sets forth the full extent of MOTOROLA'S responsibilities regarding the Product. Repair, replacement or refund of the purchase price, at MOTOROLA's option, is the exclusive remedy. THIS WARRANTY IS GIVEN IN LIEU OF ALL OTHER EXPRESS WARRANTIES. IMPLIED WARRANTIES, INCLUDING WITHOUT LIMITATION, IMPLIED WARRANTIES OF MERCHANTABILITY AND FITNESS FOR A PARTICULAR PURPOSE, ARE LIMITED TO THE DURATION OF THIS LIMITED WARRANTY. IN NO EVENT SHALL MOTOROLA BE LIABLE FOR DAMAGES IN EXCESS OF THE PURCHASE PRICE OF THE PRODUCT, FOR ANY LOSS OF USE, LOSS OF TIME, INCONVENIENCE, COMMERCIAL LOSS, LOST PROFITS OR SAVINGS OR OTHER INCIDENTAL, SPECIAL OR CONSEQUENTIAL DAMAGES ARISING OUT OF THE USE OR INABILITY TO USE SUCH PRODUCT, TO THE FULL EXTENT SUCH MAY BE DISCLAIMED BY LAW.

## **III. STATE LAW RIGHTS:**

SOME STATES DO NOT ALLOW THE EXCLUSION OR LIMITATION OF INCIDENTAL OR CONSEQUENTIAL DAMAGES OR LIMITATION ON HOW LONG AN IMPLIED WARRANTY LASTS, SO THE ABOVE LIMITATION OR EXCLUSIONS MAY NOT APPLY.

This warranty gives specific legal rights, and there may be other rights which may vary from state to state.

## **IV. HOW TO GET WARRANTY SERVICE:**

You must provide proof of purchase (bearing the date of purchase and Product item serial number) in order to receive warranty service and, also, deliver or send the Product item, transportation and insurance prepaid, to an authorized warranty service location. Warranty service will be provided by Motorola through one of its authorized warranty service locations. If you first contact the company

which sold you the Product, it can facilitate your obtaining warranty service. You can also call Motorola at 1-888-567-7347 US/Canada.

**V. WHAT THIS WARRANTY DOES NOT COVER:**

- A) Defects or damage resulting from use of the Product in other than its normal and customary manner.
- B) Defects or damage from misuse, accident, water, or neglect.
- C) Defects or damage from improper testing, operation, maintenance, installation, alteration, modification, or adjustment.
- D) Breakage or damage to antennas unless caused directly by defects in material workmanship.
- E) A Product subjected to unauthorized Product modifications, disassemblies or repairs (including, without limitation, the addition to the Product of non-Motorola supplied equipment) which adversely affect performance of the Product or interfere with Motorola's normal warranty inspection and testing of the Product to verify any warranty claim.
- F) Product which has had the serial number removed or made illegible.
- G) Rechargeable batteries if:
  - any of the seals on the battery enclosure of cells are broken or show evidence of tampering.
  - the damage or defect is caused by charging or using the battery in equipment or service other than the Product for which it is specified.
- H) Freight costs to the repair depot.
- I) A Product which, due to illegal or unauthorized alteration of the software/firmware in the Product, does not function in accordance with MOTOROLA's published specifications or the FCC type acceptance labeling in effect for the Product at

the time the Product was initially distributed from MOTOROLA.

- J) Scratches or other cosmetic damage to Product surfaces that does not affect the operation of the Product.
- K) Normal and customary wear and tear.

**VI. PATENT AND SOFTWARE PROVISIONS:**

MOTOROLA will defend, at its own expense, any suit brought against the end user purchaser to the extent that it is based on a claim that the Product or parts infringe a United States patent, and MOTOROLA will pay those costs and damages finally awarded against the end user purchaser in any such suit which are attributable to any such claim, but such defense and payments are conditioned on the following:

- A) that MOTOROLA will be notified promptly in writing by such purchaser of any notice of such claim;
- B) that MOTOROLA will have sole control of the defense of such suit and all negotiations for its settlement or compromise; and
- C) should the Product or parts become, or in MOTOROLA's opinion be likely to become, the subject of a claim of infringement of a United States patent, that such purchaser will permit MOTOROLA, at its option and expense, either to procure for such purchaser the right to continue using the Product or parts or to replace or modify the same so that it becomes non-infringing or to grant such purchaser a credit for the Product or parts as depreciated and accept its return. The depreciation will be an equal amount per year over the lifetime of the Product or parts as established by MOTOROLA.

MOTOROLA will have no liability with respect to any claim of patent infringement which is based upon the combination of the Product or parts furnished hereunder with software, apparatus or devices not furnished by MOTOROLA, nor will MOTOROLA have any liability for

the use of ancillary equipment or software not furnished by MOTOROLA which is attached to or used in connection with the Product. The foregoing states the entire liability of MOTOROLA with respect to infringement of patents by the Product or any parts thereof.

Laws in the United States and other countries preserve for MOTOROLA certain exclusive rights for copyrighted MOTOROLA software such as the exclusive rights to reproduce in copies and distribute copies of such Motorola software. MOTOROLA software may be used in only the Product in which the software was originally embodied and such software in such Product may not be replaced, copied, distributed, modified in any way, or used to produce any derivative thereof. No other use including, without limitation, alteration, modification, reproduction, distribution, or reverse engineering of such MOTOROLA software or exercise of rights in such MOTOROLA software is permitted. No license is granted by implication, estoppel or otherwise under MOTOROLA patent rights or copyrights.

**VII. GOVERNING LAW:**

This Warranty is governed by the laws of the State of Illinois, USA.

## Notes



# Index

---

## A

- accessories
  - carry cases .....39
- alert tones .....5
- analog squelch .....21
- answer a private call .....30
- antenna
  - attach the antenna ..... 10
  - radio operating frequencies .....37
  - remove the antenna .....10
- antennas .....39

## B

- batteries and battery accessories 39
- battery
  - attach the battery .....9
  - battery charge status .....35
  - charging the battery .....8
  - recycling and disposal .....36
  - remove the battery .....9
- belt clip
  - attach the belt clip .....11
  - remove the belt clip .....11

## C

- call alert
  - answer a call alert .....31
- carry accessories
  - belt clips .....39
- channel
  - select a channel .....15
- chargers
  - enhanced and multi-unit line cords  
40
- conventional mode operation .....19

## E

- emergency
  - send an emergency alarm .....24
  - send an emergency call .....25

## F

- failsoft ..... i

## G

- glossary ..... 45

## L

- LED indicators ..... 5

## M

- monitor button ..... 18

## N

- notations used in this manual ..... 1

## O

- out-of-range ..... i

## P

- phone call
  - answer a phone call .....29
- physical features of the radio ..... 3
- PL defeat .....21
- programmable features ..... 4

## R

- radio care
  - cleaning .....33
  - handling .....33
- receive / transmit
  - use the preprogrammed monitor  
button ..... 18
  - use the preprogrammed volume  
set button ..... 17
  - without using the volume set and  
monitor buttons ..... 16
- remote speaker microphone adapter  
13
  - attach the adapter ..... 13
  - remove the adapter ..... 13

## Index

---

repeater or direct operation .....32  
repeater/direct switch .....32

### S

scan  
    delete a nuisance channel .....27  
    turn scan on and off .....27  
scan (conventional only)  
select a channel .....15  
select a zone .....15  
service .....34  
site change ..... ii  
site lock ..... ii  
surveillance accessories .....40  
    Commport integrated microphone/  
    receivers .....43  
    earpieces .....40  
    headsets and headset accessories  
    .....42  
    radio interface modules for ear  
    microphones .....42  
switches .....43

### T

time-out timer .....22  
Trunking System Controls ..... i  
turn the radio off .....14  
turn the radio on .....14

### U

universal connector cover  
    attach the connector cover .....12  
    remove the connector cover ....12

### V

volume set button .....17

### W

warranty .....49

### Z

zone  
    select a zone ..... 15

## Free Manuals Download Website

<http://myh66.com>

<http://usermanuals.us>

<http://www.somanuals.com>

<http://www.4manuals.cc>

<http://www.manual-lib.com>

<http://www.404manual.com>

<http://www.luxmanual.com>

<http://aubethermostatmanual.com>

Golf course search by state

<http://golfingnear.com>

Email search by domain

<http://emailbydomain.com>

Auto manuals search

<http://auto.somanuals.com>

TV manuals search

<http://tv.somanuals.com>