



MOTOROLA
intelligence everywhere™

Commercial Series Radio CP160

User Guide

6866550D05-O

Issue: December 2003

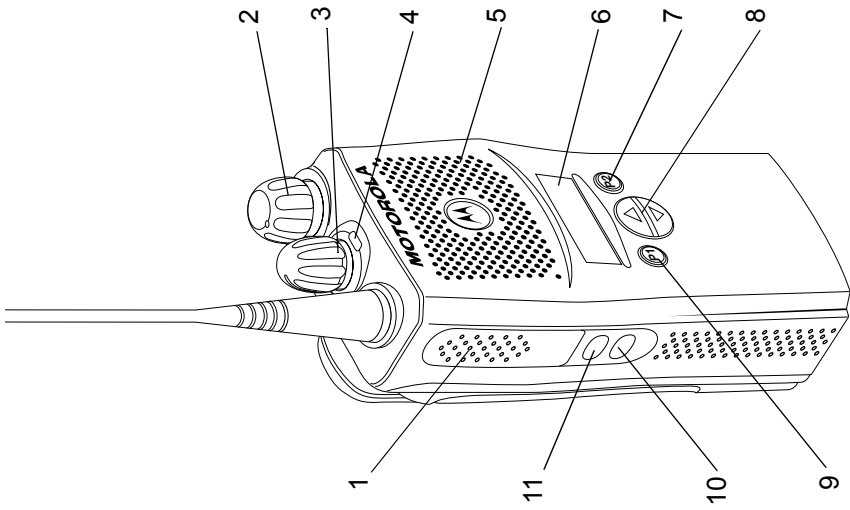
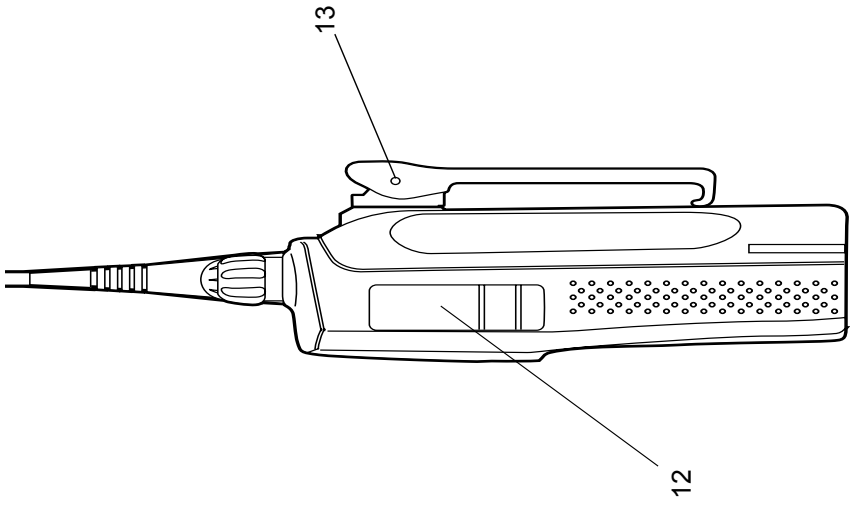

CONTENTS

Computer Software Copyrights	2
Radio Overview	3
Operation and Control Functions	3
Radio Controls	3
Programmable Buttons	4
Indicator Tones	8
Battery Charge Status	9
LED Indicator	9
LCD Display and Icons	10
Menu Buttons	11
Menu Navigation Chart	12
Getting Started	13
Battery Information	13
Charging Your Battery	13
Desktop Rapid Charger	14
Accessory Information	15
Attaching the Battery	15
Removing The Battery	15
Attaching The Antenna	16
Removing The Antenna	16
Attaching The Belt Clip	17
Removing The Belt Clip	17

Turning the Radio On or Off	18
Radio On Message	18
Adjusting the Volume	18
Selecting a Radio Channel	19
Home Revert Memory Channel (1&2)	19
Store Memory Channel (1&2)	19
Receiving a Call	20
Sending a Call	20
Monitoring	21
VOX Operation	21
Connecting a VOX Headset	21
Enable/Disable Headset Sidetone	22
VOX Headset	22
Non-VOX Headset With In-Line PTT	22
Keypad Lock/Unlock	22
Radio Calls	23
Receiving a Selective Call	23
Sending a Selective Call	23
Receiving a Call Alert Page	24
Sending a Call Alert Page	24
Repeater Or Talkaround Mode	25

Scan 27

Start System Scan 27

Stop System Scan 28

Start Auto Scan 28

Stop Auto Scan 28

Talkback 28

Delete a Nuisance Channel 29

 Restore Channels to the Scan List 29

Edit a Scan List 29

Add or Delete Channels 30

Prioritize a Channel in a Scan List 31

 Set Priority Channels 31

Phone 33

Access the Repeater 33

Receive a Phone Call 33

Disconnect a Phone Call 34

Make a Phone Call 34

Tone Preferences 35

Tones On/Off 37

Keypad On/Off Tones 37

Call Tone Tagging 38

Escalart 38

User Settings 39

Set Squelch Level 41

Set Power Level 41

Option Board On/Off 42

Set the Lights 42

Display the Software Version 43

Computer Software Copyright

The products described in this manual may include copyrighted computer programmes stored in semiconductor memories or other media. Laws in the United States of America and other countries preserve for Motorola Europe and Motorola Inc. certain exclusive rights for copyrighted computer programmes, including the right to copy or reproduce in any form the copyrighted computer programme. Accordingly, any copyrighted computer programmes contained in the products described in this manual may not be copied or reproduced in any manner without the express written permission of the holders of the rights. Furthermore, the purchase of these products shall not be deemed to grant either directly or by implication, estoppel, or otherwise, any licence under the copyrights, patents, or patent applications of the holders of the rights, except for the normal non-exclusive royalty free licence to use that arises by operation of the law in the sale of the product.

RADIO OVERVIEW

This user guide covers the operation of the CP160 Portable Radios.



Caution

Before using this product, read the operating instructions for safe usage contained in the Product Safety and RF Exposure booklet 6864117B25_ enclosed with your radio.

ATTENTION!

This radio is restricted to occupational use only to satisfy ICNIRP RF energy exposure requirements. Before using this product, read the RF energy awareness information and operating instructions in the Product Safety and RF Exposure booklet (Motorola Publication part number 6864117B25_) to ensure compliance with RF energy exposure limits.

OPERATION AND CONTROL FUNCTIONS

Radio Controls

The numbers below refer to the illustrations on the inside front cover.

- 1. Push-to-talk (PTT)**
Press and hold down this button to talk; release it to listen.
- 2. On-Off / Volume Knob**
Used to turn the radio on or off, and to adjust the radio's volume.

- 3. Channel Selector Knob**
Used to switch the radio to different channels.
- 4. LED Indicators**
Indicate radio status:
Green: Solid during power up routine; off after successful power up; flashing when scanning.
Red: Solid - transmitting; Flashing when transmitting - low battery;
Flashing - channel is busy receiving.
Yellow: Solid when radio is in monitor mode, or is sending a selective call or call alert;
Flashing - receiving a selective call or call alert.
- 5. Microphone/Speaker**
Hold the microphone 2.5 to 5 cm (1-2 inches) from your mouth, and speak clearly into it.
- 6. LCD Display**
An 8 character single line display with up to 9 radio status icons.
- 7. Front Button P2**
- 8. Menu Scroll Buttons**
- 9. Front Button P1**
- 10. Side Button 2**
- 11. Side Button 1**
- 12. Accessory Connector**
Connects remote microphones, remote earphones and other accessories. Replace dust cap when not in use.
- 13. Belt Clip**

Programmable Buttons

Your radio has four programmable buttons. Your dealer can program these buttons as shortcuts to various radio features.

Check with your dealer for a complete list of functions your radio supports.

Programmable buttons include:

- Side Buttons (S1 and S2)
- Front Buttons (P1 and P2)

Some buttons can access up to two features, depending on the type of button press:

- **short press**—quickly pressing and releasing the programmable buttons
- **long press**—pressing and holding the programmable buttons for a minimum of 2.5 seconds
- **hold down**—pressing and holding down the programmable buttons while checking status or making adjustments

The following table is a summary of programmable radio features and corresponding page references.

In the “Button” column, have your dealer record the name of the programmable button next to the feature that has been programmed to it.

Also, where appropriate, have your dealer indicate whether the button press requires a short press, a long press, or needs to be held down.

Feature	Indicator	Short Press	Long Press	Hold Down	Page	Button
Battery Indicator		—	—	Checks the battery charge status.	9	
Menu Mode	—	Ⓜ button enters Menu Mode and selects menu options. Once in Menu Mode, Ⓜ button is automatically re-assigned to exit Menu Mode.†		—	11	Ⓜ
Volume Set	—	—	—	Sounds a tone for adjusting the radio's volume level.	18	
Home Revert Memory Channel (1&2)	—	Allows instant access to the home channel.	—	—	19	
Store Memory Channel (1&2)	—		Stores current channel to the home channel.	—	19	
Monitor		A long press initiates Monitor. A short press cancels Monitor.		Monitors the selected channel for any activity.	21	

† This function is activated by EITHER a short OR a long press, but not both.

Feature	Indicator	Short Press	Long Press	Hold Down	Page	Button
Voice Operated Transmission (VOX)	—	Toggle VOX on and off.†		—	21	
Keypad Lock/Unlock	∅		Toggle keypad between locked and unlocked.		22	
Radio Call	—	Directly access radio call menu.†		—	23	
Repeater/Talkaround	↔	Toggles between using a repeater or transmitting directly to another radio.†		—	25	
Scan/Nuisance Channel Delete	↻	Starts or stops the Scan operation.	Deletes a nuisance channel while scanning.	—	27	
Edit Scan List	—	Add, delete, or prioritize channels.†		—	29	
Phone	☎	Directly access Phone mode.†		—	33	
Escalert	—	Toggle escalert on and off.†		—	38	
Squelch	—	Toggle squelch level between tight and normal squelch.†		—	41	
Power Level	LH	Toggle transmit power level between High and Low power.†		—	41	







† This function is activated by EITHER a short OR a long press, but not both.

Feature	Indicator	Short Press	Long Press	Hold Down	Page	Button
Option Board		Toggle the option board on and off.†		—	42	
Lights	—	Toggle keypad and display backlights on and off.†		—	42	

† This function is activated by EITHER a short OR a long press, but not both.

Indicator Tones

High pitched tone Low pitched tone

	Self Test Pass Tone
	Self Test Fail Tone
	Positive Indicator Tone
	Negative Indicator Tone
	Good Key Tone
	Bad Key Tone

Some programmable buttons use tones to indicate one of two modes:

Programmable Buttons	Positive Indicator Tone	Negative Indicator Tone
Scan	Start	Stop
Power Level	High	Low
Squelch	Tight	Normal
Repeater/Talkaround	Does not use repeater	Uses repeater
VOX	Enabled	Disabled
Silent Monitor/Open Squelch	—	Enabled
Home Revert Memory Channel (1&2)	—	Enabled
Store Memory Channel (1&2)	—	Stored
Menu Mode ^(P2)	—	Accessed
Radio Call	—	Enabled
Scan List Edit	—	Enabled
Phone Mode	—	Enabled
Option Board	Enabled	Disabled
Escalert	Enabled	Disabled

Battery Charge Status

You can check battery charge status if your dealer has preprogrammed one of the programmable buttons. Hold down the preprogrammed **Battery Indicator** button. The charge status is shown on the display.

Battery Level	Display
Full	▣▣▣▣
Good	▣▣▣▢
Fair	▣▣▢▢
Low	▣▢▢▢
Very Low	▢▢▢▢

LED Indicator

The LED shows radio status as follows:

LED	State	Indication
Radio Call		
Red	Solid	Radio transmitting.
Red	Flashing	Receiving.
Red	Flashing	Channel busy.
Scan		
Green	Flashing	Radio is scanning.
Call Alert		
Yellow	Flashing	Receiving a Call Alert
Yellow	Solid	Sending a Call Alert
Selective Call		
Yellow	Flashing	Receiving a Selective Call
Yellow	Solid	Sending a Selective Call
Monitor/Open Squelch		
Yellow	Solid	Radio in monitor mode.
Low Battery Level		
Red	Flashing	Flashing when transmitting.

LCD DISPLAY AND ICONS

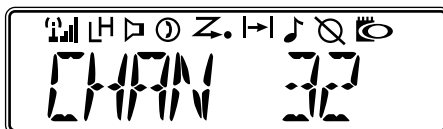

Displays radio Status, Addresses or Channel, on one line of 8 characters. The top line of the display shows radio status icons, explained in the table below:

Symbol	Name and Description
	Option Board Indicator Indicates that an option board is activated in the radio.
	Signal Strength Indicator The more bars, the stronger the signal being received by your radio.
	Power Level Indicator "L" lights when your radio is configured to transmit in Low Power. "H" lights when your radio is configured to transmit in High Power.
	Monitor Indicator The selected channel is being monitored.

Symbol	Name and Description
	Scan Indicator Indicates that the scan feature is activated.
	Priority Scan Indicator Indicates that the scan feature is activated. The dot is flashing during priority scan mode when scan has landed on a Priority 1 channel. The dot is steady during priority scan mode when scan has landed on a Priority 2 channel.
	Phone Indicator Phone mode is selected.
	Call Received Indicator A Selective Call or Call Alert has been received.
	Talkaround Indicator You are transmitting directly to another radio, not via a repeater.
	Keypad Lock The keypad has been locked.

Note: At extremely low temperatures, you may experience a slight delay in displaying new information. This is normal and does not affect the function of your radio.

MENU BUTTONS

Menu Button

If preprogrammed by your dealer, the two front buttons (P1) and (P2) can be used, in conjunction with other programmable features, to access and select menu options (P2); and exit menu mode (P1). The (P2) button can be preprogrammed by your dealer to either a short or long press to access the Menu Mode.

Exit the Menu

While in Menu Mode, the (P1) button is automatically assigned to completely exit the Menu Mode by a long press, or by a series of short presses to exit from a sub-level of the menu hierarchy.

The radio also exits the menu mode if there have been no inputs via the navigation buttons for the default "Inactivity Time" or after a selection has been made.

Once you have exited Menu Mode, the (P1) and (P2) buttons return to normal programmable condition.

Menu Scroll Buttons



Used to scroll while in Menu Mode.

Refer to the menu navigation chart for menu selectable features.

Navigate the Menu

▲ or ▼ to scroll through the menu options. If you scroll past the last option, the selection wraps around and starts again.

When you reach the required option, a short press of the (P2) button selects that option and enters the sub-menu.

▲ or ▼ to scroll through the sub-menu options. Select the option with a short press of the (P2) button.

MENU NAVIGATION CHART

(Refer to Menu Navigation guidelines—
lower, left-hand corner of this page)

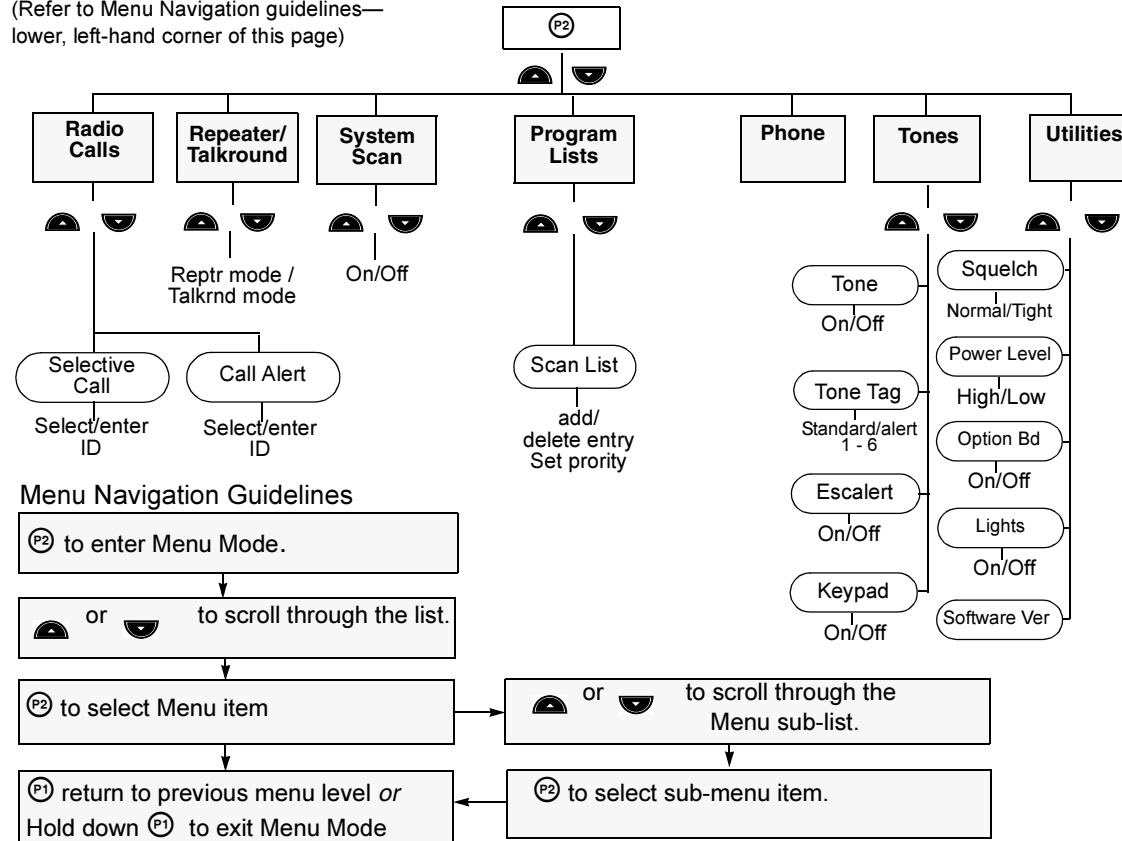

Menu Navigation Guidelines

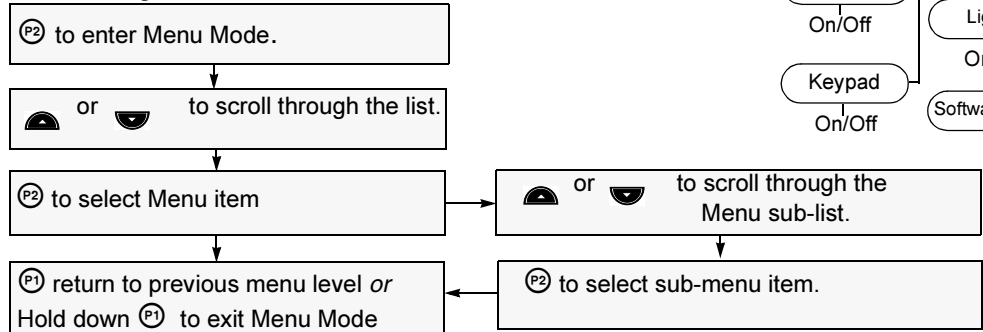

GETTING STARTED

BATTERY INFORMATION

Charging Your Battery

This radio is powered by either a nickel-metal hydride (NiMH), or a lithium-ion (Li-Ion) rechargeable battery. Charge the battery before use to ensure optimum capacity and performance. The battery was designed specifically to be used with a Motorola charger. Charging in non-Motorola equipment may lead to battery damage and void the battery warranty.

Note: When charging a battery attached to a radio, turn the radio off to ensure a full charge.

The battery should be at about 25°C (77°F) (room temperature), whenever possible. Charging a cold battery (below 10°C [50°F]) may result in leakage of electrolyte and ultimately in failure of the battery. Charging a hot battery (above 35°C [95°F]) results in reduced discharge capacity, affecting the performance of the radio. Motorola rapid-rate battery chargers contain a temperature-sensing circuit to ensure that batteries are charged within the temperature limits stated above.

If a battery is new, or its charge level is very low, you will need to charge it before you can use it. When the battery level is low and the radio is in transmit mode you will see the LED indicator flash red. Upon release of the PTT button, you will hear an alert tone.

Note: Batteries are shipped uncharged from the factory. Always charge a new battery 14 to 16 hours before initial use, regardless of the status indicated by the charger.

GETTING STARTED

Desktop Rapid Charger

To Charge the Battery

- 1 Turn the radio off.
- 2 Place the battery, with or without the radio, in the charger pocket.
 - The charger LED indicates the charging progress.

LED color	Status
No LED Indication	Battery inserted incorrectly or battery not detected.
Single Green Flash	Successful charger power-up.
Flashing Red ^a	Battery unchargeable or not making proper contact.
Red	Battery is charging.
Flashing Yellow	Battery in charger but waiting to be charged. The battery temperature may be too hot or too cold. The voltage may be lower than the predetermined threshold level for charging.
Flashing Green ^b	Battery 90% (or more) charged.
Green	Battery fully charged.

a Remove the battery from the charger and use a pencil eraser to clean the three metal contacts on the back of the battery. Replace the battery in the charger. If the LED indicator continues to flash red, consult your dealer.

b A standard battery may require 90 minutes to charge to 90% capacity.

ACCESSORY INFORMATION

Attaching the Battery

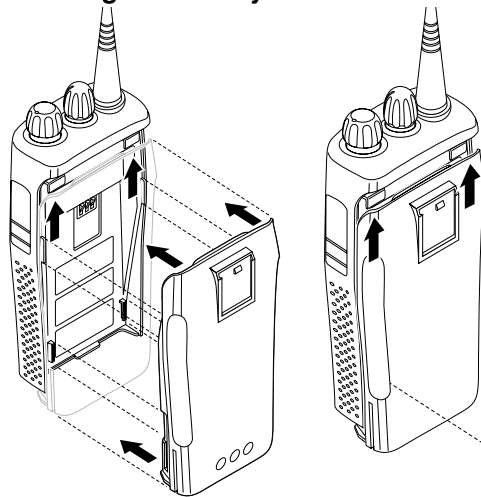

- 1 Align the battery to the battery rails on the back of the radio (approximately 1 cm from the top of the radio.)
- 2 Press the battery firmly to the radio and slide the battery upward until the latch snaps into place.
- 3 Slide the battery latch, located on radio bottom, into the lock position.

Removing the Battery

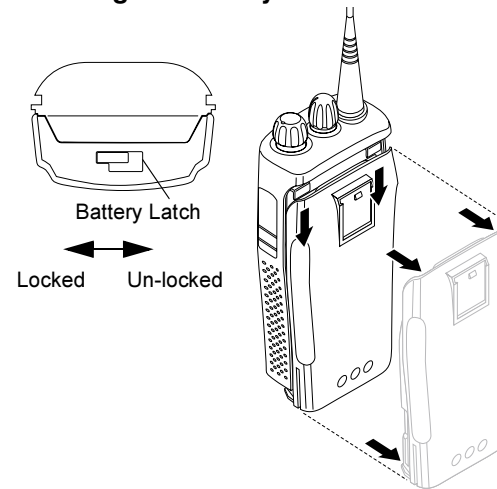

- 1 Turn off the radio if it is turned on.
- 2 Slide the battery latch into the unlock position. Disengage by pushing downward and holding the latch towards the front of the radio.
- 3 With the battery latch disengaged, slide the battery down from the top of the radio approximately 1 cm. Once the battery is free from the battery rails, lift it directly away from the radio.

GETTING STARTED

Attaching the Antenna

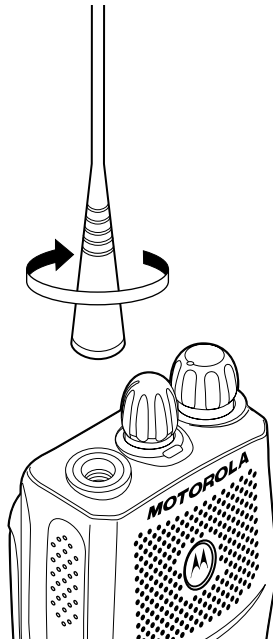

Turn the antenna clockwise to attach it.

Removing the Antenna

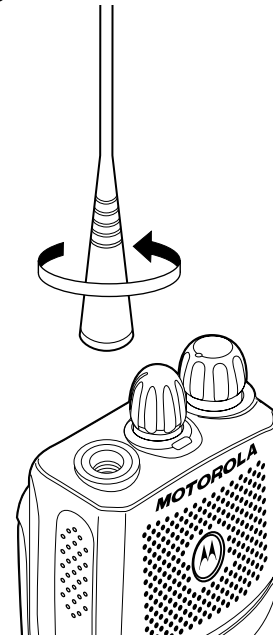

Turn the antenna counter-clockwise to remove it.

Attaching the Belt Clip

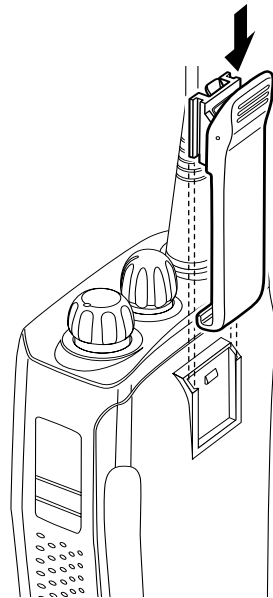

- 1 Align the grooves of the belt clip with those of the battery.
- 2 Press the belt clip downward until you hear a click.

Removing the Belt Clip

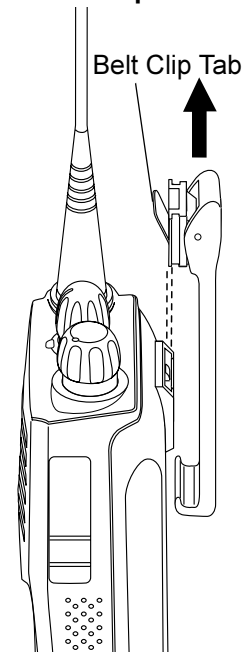



- 1 Use a key to press the belt clip tab away from the battery to unlock the belt clip.
- 2 Slide the belt clip upward to remove it.

GETTING STARTED

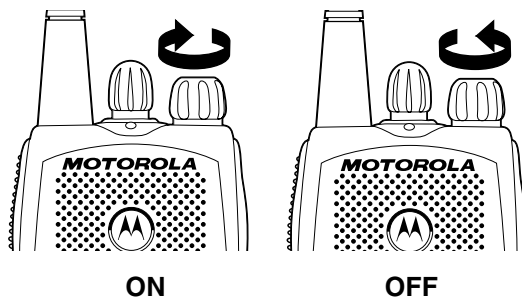
TURNING THE RADIO ON OR OFF



Turn the **On/Off/Volume Control** knob clockwise. If power-up is successful, you will hear the Self-Test Pass Tone () and see the display icons light momentarily and the LED flash green.

If the radio fails to power up, you will hear the Self Test Fail Tone (). The radio will need to be returned for re-programming.

Turn the **On/Off/Volume Control** knob counter-clockwise until you hear a click and both the display and LED indicators turn off.

RADIO ON MESSAGE

At power up the radio may display a message customised by your dealer, e.g.:

After this text has been displayed, the radio performs a self test routine. During the routine the Green LED lights. On completion of a successful self test the radio produces the Self-Test pass Tone, the Green LED indicator goes out and the display shows the channel that was in use at power down, typically:

This may be a number or an alias and will be the current channel.

ADJUSTING THE VOLUME

Turn the **On/Off/Volume Control** knob clockwise to increase the volume, or counterclockwise to decrease the volume.

—or— use the pre-programmed **Volume Set** button

- 1 Hold down the **Volume Set** button; you will hear a continuous tone.
- 2 Turn the **On/Off/Volume Control** knob to the desired volume level.
- 3 Release the **Volume Set** button.

SELECTING A RADIO CHANNEL

Your radio offers 32 channels.

Note: Due to government regulations, some channels may not be programmed. Ask your dealer for more information.

To select a channel, turn the **Channel Selector** knob clockwise or counterclockwise until you reach the desired channel.

Using Home Revert Memory Channels (1&2)

Two of the programmable buttons may be pre-programmed by your dealer as Memory Channel buttons, allowing you quick access to frequently used channels. A press of the button will take you to the assigned channel.

HOME REVERT MEMORY CHANNEL (1 & 2)

The Home Revert feature allows you to instantly access up to two of your favorite channels at the touch of a button.

Press the preprogrammed **Home Revert Memory Channel 1** button or **Home Revert Memory Channel 2** button.

STORE MEMORY CHANNEL (1 & 2)

The Store Memory Channel (1 & 2) feature allows you to store a channel for the Home Revert Memory Channel feature.

Use the **Channel Selector** knob to select the desired channel. Press the preprogrammed **Store Memory Channel 1** button or **Store Memory Channel 2** button to store that channel.

RECEIVING A CALL

- 1 Turn your radio on.
- 2 Adjust the radio's volume.
- 3 Select the desired channel.
- 4 Listen for voice activity. The LED indicator flashes red while your radio is receiving.
- 5 To respond, hold the radio vertically 2.5 to 5 cm (1 to 2 inches) from your mouth. Press the **PTT** to talk; release it to listen

Note: The system may have a limited call time and the call may be terminated automatically if this call time is exceeded.

SENDING A CALL

- 1 Turn your radio on.
- 2 Select the desired channel.
- 3 Monitor for traffic (using the pre-programmed **Monitor** button) before transmitting to ensure that you do not 'talk over' someone who is already transmitting.
- 3 Hold the radio vertically 2.5 to 5 cm (1 to 2 inches) from your mouth. Press the **PTT** to talk; release it to listen.

Note: Your radio may be configured for 'Transmit Inhibit' under certain conditions (e.g. when the channel is in use by others) in which case, the channel busy tone will sound when you press the PTT or call button to indicate that transmission is inhibited.

MONITORING

It is important to monitor traffic before transmitting to ensure that you do not “talk over” someone who is already transmitting.

- 1 Press and hold the preprogrammed **Monitor** button to access channel traffic.
 - 2 Once channel traffic has cleared, proceed with your call by pressing the **PTT** button.
 - 3 A long press of the preprogrammed **Monitor** button places the radio in Permanent Monitor mode.
 - You hear a high-pitched tone.
 - 4 A short press of the **Monitor** button cancels Permanent Monitor mode and returns the radio to normal operation.
-

VOX OPERATION

When hands-free operation is desired, your radio can be activated by voice alone using the VOX feature when you speak through an accessory that is connected to your radio.

Connecting a VOX Headset

- 1 Turn off your radio.
- 2 Connect the VOX accessory to your radio and turn the radio on.
- 3 To enable or disable VOX operation, press the preprogrammed **VOX** button.

Note: Pressing **PTT** disables VOX.

–or–

Select a channel that has been programmed for VOX by your dealer to enable VOX.

Note: You do not need to press a preprogrammed **VOX** button.

Note: Pressing the **PTT** button disables VOX.

- 4 Select a channel that has **not** been preprogrammed for VOX by your dealer to disable VOX.
-

ENABLE/DISABLE HEADSET SIDETONE

Your dealer can program your radio to hear your voice through the headset during transmit.

VOX Headset

- 1 Turn off your radio.
 - 2 Connect the VOX accessory to your radio.
 - 3 Turn the radio on. During transmit, the sidetone will be enabled, if programmed in the radio.
 - 4 To disable the headset sidetone, turn off your radio and turn the radio on again.
-

Non-VOX Headset with In-Line PTT

- 1 Turn off your radio.
 - 2 Connect the non-VOX accessory to your radio.
 - 3 Press and hold the In-line PTT on your headset.
 - 4 Turn the radio on and release the PTT once the radio has completed start-up.
 - 5 To disable the headset sidetone, turn off your radio and turn the radio on again.
-

KEYPAD LOCK/UNLOCK

To lock or unlock the keypad, long press the pre-programmed **Keypad Lock/Unlock** button.

Note: The  symbol appears on the display when the keypad is locked.

RADIO CALLS

RECEIVING A SELECTIVE CALL

When you receive a selective call:











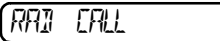

- The display shows 🎵 and the preprogrammed name or ID of the calling radio.
- The LED indicator flashes yellow, if programmed by your dealer/programmer.
- You hear two high-pitched tones.

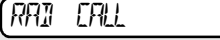
- 1 To acknowledge the call, press and release the **PTT** button.
- 2 Press and hold the **PTT** button to talk; release to listen.

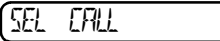
SENDING A SELECTIVE CALL

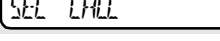
You can send a Selective Call to a particular radio or to a group of radios, as programmed by your dealer. Press the preprogrammed **Radio Call** button and proceed to step 4.

– or –

- 1  to enter menu mode
- 2  or  until 
- 3  to select 
- 4  or  until 
- 5  to select 
- 6  or  to locate the desired ID in the Radio Call List.
- 7 Press the **PTT** button to send the call.
- 8 Press and hold the **PTT** button to talk; release to listen.
- 9 When the call is completed,  until you exit menu mode.

RECEIVING A CALL ALERT PAGE

When you receive a Call Alert page:

- The display shows 🎵 and the preprogrammed name or ID of the calling radio.
- The LED indicator flashes yellow, if programmed by your dealer/programmer.
- You hear four high-pitched tones.

To acknowledge the page, press and release the **PTT** button; to cancel the page, press any other key.

SENDING A CALL ALERT PAGE

You can alert another person by sending a Call Alert page.

Press the preprogrammed **Radio Call** button and proceed to step 4.

– or –

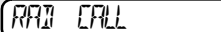

1  to enter menu mode

2  or  until 

3  to select 

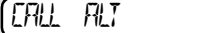
4  or  until 

5  to select 

6  or  to locate the desired ID in the Radio Call List.

7 Press the **PTT** button to send the page.

8 When the page is completed,
 until you exit menu mode.

REPEATER OR TALKAROUND MODE

Talkaround Mode enables you to communicate with another radio when either:









- the repeater is not operating
—or—
- your radio is out of the repeater's range but within communicating distance of another radio.

Note: The |→| symbol appears on the display when Talkaround Mode is selected.

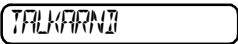
To Select either Repeater Mode or Talkaround Mode

Press the preprogrammed **Repeater/Talkaround** button to toggle between Repeater Mode and Talkaround Mode.

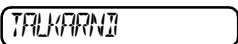
– or –

- 1  to enter menu mode.
- 2  or  until 
- 3  to select the current setting.
- 4  or  until 
-or- until 
- 5  to select the current setting.

RADIO CALLS

Notes:

English

SCAN

Your radio is equipped with the Scan feature, which allows you to monitor multiple channels for voice activity. The radio will stop on a channel when it detects activity on it.

Scan lists are assigned per channel, by your dealer/programmer. Your radio automatically switches to a channel, within that scan list, when it detects activity. You can edit these lists through your radio's menu.

- The LED indicator blinks green during scan mode; it stops blinking when the radio switches to an active channel.
- The  symbol appears on the display while in scan mode.

There are two types of Scan available in your radio:

- System Scan
- Auto Scan

START SYSTEM SCAN

Press the preprogrammed **Scan** button to start scan.

– or –

1 Select a channel that contains a Scan list.

2  to enter menu mode.

3  or  until 

4  to select 

The display shows the current scan status.

5  or  until 

6  to select the current setting.

SCAN



STOP SYSTEM SCAN

Press the preprogrammed **Scan** button to stop System Scan.

– or –

1  to enter menu mode.

2  or  until 

3  to select 

The display shows the current scan status.

4  or  until 

5  to select the current setting.

- The  symbol disappears from the display.

Note: Your dealer/programmer can preprogram your radio when exiting System Scan to automatically revert to the last scan channel that had activity on it or to automatically revert to the channel where scan was initiated.

START AUTO SCAN

Auto Scan automatically starts scanning once a channel with Auto Scan enabled is selected. Select a channel that has been preprogrammed for Auto Scan by your dealer/programmer.

STOP AUTO SCAN

Select a channel that has not been preprogrammed for Auto Scan by your dealer/programmer.

- The  symbol disappears from the display.

TALKBACK

The Talkback feature allows you to respond to a transmission while scanning. If transmission is detected on a channel while scanning, the radio will stop on that channel for a default period of time after activity has ceased. This is referred to as "hangtime". During this hangtime you may respond by pressing the **PTT** button.

Note: The LED scan indicator stops blinking while the radio is in hangtime. If the **PTT** button is not pressed after the preprogrammed hangtime, the radio returns to scanning channels.

DELETE A NUISANCE CHANNEL

Note: Your dealer/programmer must preprogram a button to access this feature.

If a channel continually generates unwanted calls or noise (a “nuisance” channel), you can temporarily remove it from the scan list:

- 1 While the radio is on the Nuisance Channel, press the preprogrammed **Nuisance Channel Delete** button until you hear a tone.
- 2 Release the **Nuisance Channel Delete** button. The nuisance channel is deleted.

Note: You cannot temporarily delete the channel that has been pre-programmed by your dealer/programmer as your designated scan channel, a priority channel, or the last remaining channel in the scan list.

Restore Channels to the Scan List

- 1 Power off the radio. Once the radio is powered on again, the deleted nuisance channels are restored to the scan list.

– or –

- 1 Press the preprogrammed **Scan** button to stop the scan.

- 2 Press the preprogrammed **Scan** button again to start scanning again. The Deleted Nuisance Channels are restored to the scan list.

– or –

- 1 Select a channel that has **not** been preprogrammed for scan by your dealer / programmer to stop Scan. Once you return to the original channel, the deleted nuisance channels are restored to the scan list.

EDIT A SCAN LIST

Your radio can support up to 16 Scan lists. Each Scan list can contain up to 16 channels. The same channel can be included in several Scan lists, and the same Scan list can be assigned to several channels. Scan lists are assigned per channel, by your dealer/programmer. When you edit a Scan list, you can either add, delete, or prioritize channels.

Note: Your radio cannot receive calls while you are editing a Scan list.

SCAN



ADD OR DELETE CHANNELS

1 Select a channel that contains a Scan list you want to edit.

2 **F2** to enter menu mode.

3  or  until 

4 **F2** to select 

5  or  until 

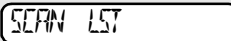

Note: One Scan list per channel is available.

6 **F2** to select 

7  or  until 

– or – until 

8 **F2** to select the current setting.

9  or  until you see the channel you want to add or delete.

10 **F2** to confirm your selection.

11 If you added a channel,

you see: 
– or –

If you delete a channel,

you see: 

12 **F2** to confirm the deletion.

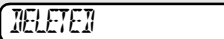
you see: 

13 **F1** to return to 

– or – 

14 **F1** until you exit menu mode.

PRIORITIZE A CHANNEL IN A SCAN LIST

You may want to check the activity on one or two channels more frequently than others. You can do this by prioritizing them:

Priority Channel	Scanning Sequence
None specified	Ch1→Ch2→Ch3→ Ch4→... Ch1
Channel 2 (Priority 1)	Ch2→Ch1→Ch2→Ch3→ Ch2→Ch4→Ch2→... Ch1
Channel 2 (Priority 1) and Channel 8 (Priority 2)	Ch2→Ch1→Ch8→Ch3→ Ch2→Ch4→Ch8→... Ch1



Note: If you are receiving on a non-priority channel and traffic becomes active on a priority channel, your radio will automatically switch to that priority channel and indicate the activity with a short tone.

Set Priority Channels

Note: You cannot assign the same priority to two different channels.

- 1 to enter menu mode.
 - 2 or until
 - 3 to select
 - 4 or until
 - 5 to select
 - 6 or until
 - 7 to select
 - 8 or until
 - or – until
 - 9 to select the desired priority level.
- You see the current priority channel.

SCAN

10  or  until you see the channel you want to prioritize.

– or – until
to select the current
channel the radio is
on.

SELECTED

– or – until
to de-prioritize the
current channel the
radio is on.

DISPABLED

11  to prioritize that channel.

you see:

SAVED

12  to return to

EXIT PRI

13  until you exit menu mode.

PHONE

Your radio allows you to place and receive telephone calls through a repeater (depending on phone line availability).

- ① appears on the display when you are in Phone mode.

ACCESS THE REPEATER

Your dealer/programmer can preprogram your radio in one of two ways to enter your access/de-access code to the repeater.

Immediate Auto – your radio will transmit the access/deaccess code automatically upon entering phone mode or disconnecting a phone call. You will hear a series of tones, and see your access/deaccess code on the display, indicating that an access/deaccess code is being sent automatically.

Delayed Auto – your radio will transmit the access code upon a **PTT** button press. The de-access code is sent automatically when you exit phone mode.

RECEIVE A PHONE CALL

When a phone call is received, a ringing tone sounds, alerting you to answer the phone call. Press the preprogrammed **Phone** button and skip to step 6.

– or –

1 Select a channel that has been programmed for telephone.

2  to enter menu mode.

3  or  until 

4  to select 

Note: The ① appears on the display.

5 Press and hold the **PTT** button to talk. Hold the radio in a vertical position with the microphone 1 to 2 inches (2.5 to 5 cm) away from your mouth. Release the **PTT** button when the other party wants to talk, both parties will need to speak in turn.

6 Disconnect the phone call when the conversation is completed.

PHONE

DISCONNECT A PHONE CALL

1 To disconnect a phone call if your radio has **Immediate Auto** or **Delayed Auto** programmed, exit Phone Mode.

2 Press the preprogrammed **Phone** button.
– or –
Press and hold  to disconnect the call.

Note:  disappears from the display.

MAKE A PHONE CALL

Note: Only the first 8 digits of the phone number will be displayed on your radio's display.

Press the preprogrammed **Phone** button and skip to step 6.

– or –



1 Select a channel that has been programmed for telephone.

2  to enter menu mode.

3  or  until 

4  to select 

5 When you hear a dial tone:

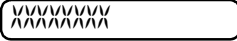
 or  to 
select a number from the phone list.

Note: To redial the last number dialed, press and release the **PTT** button immediately after the access code is sent. The radio sends the last number dialed.













6 Press and release the **PTT** button, if required for your radio.

7 When your party answers, press and hold the **PTT** button to talk. Hold the radio in a vertical position with the microphone 1 to 2 inches (2.5 to 5 cm) away from your mouth. Release the **PTT** button when the other party wants to talk, both parties will need to speak in turn.

8 Disconnect the phone call when the conversation is completed.

STONE PREFERENCE

You can use the radio's menu to access user-adjustable settings to customize the tones on your radio.

- 1  to enter menu mode.
 - 2  or  until 
 - 3  to select 
 - 4  or  until you see the feature you want to change (see the table on below).
 - 5  to select the feature. You see the feature's current setting.
 - 6  or  to see a list of available settings.
 - 7  to select the desired setting.
 - 8  until you exit the menu mode.
-

Tone Settings

Feature	What it Does	Settings
<i>TONE</i>	Turns all alert tones on or off.	<i>ON</i> <i>OFF</i>
<i>KPD TONE</i>	Turns the keypad tones on or off.	<i>ON</i> <i>OFF</i>
<i>TONE TAG</i>	Assigns a specific tone when receiving a specific type of radio call.	<i>STANDARD</i> <i>ALERT 1-6</i>
<i>ESCALERT</i>	Increases the volume of the alarm tones when a radio call is not answered.	<i>ON</i> <i>OFF</i>

TONES ON/OFF

You can program your radio to enable or disable all alert tones.

- 1 to enter Menu mode.
- 2 or until
- 3 to select
- 4 or until
- 5 to select
- 6 or until
- or – until
- 7 to select the desired setting.

KEYPAD ON/OFF TONES

You can program your radio to enable or disable all keypad tones.

Note: Tones for the programmable buttons , , and Side Buttons 1 and 2 can not be disabled.

- 1 to enter Menu mode.
- 2 or until
- 3 to select
- 4 or until
- 5 to select
- 6 or until
- or – until
- 7 to select the desired setting.

CALL TONE TAGGING

You can program your radio to sound a particular alert tone when receiving Selective Call or Call Alert (call tone tagging).

Note: Seven alert tones are available to select from in the list.

- 1 to enter menu mode.
- 2 or until
- 3 to select
- 4 or until
- 5 to select
- 6 or until
- or – until
- 7 to select the desired setting.
- 8 or until you see and hear the tone you want to use for this type of call.
- 9 to select the desired setting.
you see:
- 10 to return to
- 11 until you exit the menu mode.

ESCALERT

You can program your radio to increase the volume of the alarm tones when a radio call is not answered.













Press the preprogrammed **Escalert** button and proceed to step 5.

– or –

- 1 to enter menu mode.
- 2 or until
- 3 to select
- 4 or until
- 5 to select
- 6 or until
- or until
- 7 to select the desired setting.

USER SETTINGS

You can use the radio's menu to access user-adjustable settings to customize some of your radio features.

- 1  to enter menu mode.
- 2  or  until 
- 3  to select 
- 4  or  until you see the feature you want to change (see table on page 40).
- 5  to select the feature. You see the feature's current setting.
- 6  or  for available settings.
- 7  to select the desired setting.

Utilities Features

Feature	What it Does	Settings
SQUELCH	Changes the squelch of the radio to tight or normal.	TIGHT NORMAL
PWR LVL	Changes the power level of the radio to high or low.	HIGH LOW
OPT BRD	Enables or disables an option board.	ON OFF
LIGHT	Enables or disables the radio's keypad and display back-light.	ON OFF
SOFTWARE	Displays the radio's software version number.	XXXXXX

SET SQUELCH LEVEL

Use this feature to filter out (unwanted) calls and/or background noise. However, tightening squelch could cause calls from remote locations to be filtered out as well. In this case, normal squelch may be more desirable.

Press the preprogrammed **Squelch** button to toggle between tight and normal squelch.

– or –

- 1 to enter menu mode.
- 2 or until
- 3 to select
- 4 or until
- 5 to select
- 6 or until
- or – until
- 7 to select the current setting.

SET POWER LEVEL

Each channel in your radio has a predefined transmit power level that can be changed.

- *High power* (**H**) allows you to reach a radio that is farther away.
- *Low power* (**L**) to conserve the battery.

Note: The **L** or **H** symbol appears on the display when High/Low Power Level is selected.

To set the power level, press the preprogrammed **Power Level** button to toggle between low and high power.

– or –

- 1 to enter menu mode.
- 2 or until
- 3 to select
- 4 or until
- 5 to select
- 6 or until
- or – until
- 7 to select the current setting.















OPTION BOARD ON/OFF

Use this feature to enable or disable an option board.

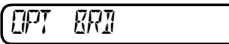
- The  symbol appears on the display when the option board feature is On.

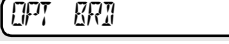

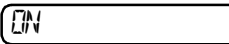
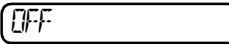









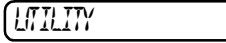

Press the preprogrammed **Option Board** button to toggle the option board on or off.

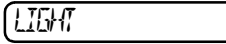
– or –

-  to enter menu mode.
-  or  until 
-  to select 
-  or  until 
-  to select 
-  or  until 
- or – until 
-  to select the current setting.











SET THE LIGHTS

Use this feature to enable or disable the radio's keypad and display backlight.

-  to enter menu mode.
-  or  until 
-  to select 
-  or  until 
-  to select 
-  or  until 
- or – until 
-  to select the current setting.

DISPLAY THE SOFTWARE VERSION

Use this feature to view the current software version of your radio.

- 1  to enter menu mode.
 - 2  or  until 
 - 3  to select 
 - 4  or  until 
 - 5  to view the software version.
 - 6  until you exit menu mode.
-

USER SETTINGS

English

44

Free Manuals Download Website

<http://myh66.com>

<http://usermanuals.us>

<http://www.somanuals.com>

<http://www.4manuals.cc>

<http://www.manual-lib.com>

<http://www.404manual.com>

<http://www.luxmanual.com>

<http://aubethermostatmanual.com>

Golf course search by state

<http://golfingnear.com>

Email search by domain

<http://emailbydomain.com>

Auto manuals search

<http://auto.somanuals.com>

TV manuals search

<http://tv.somanuals.com>