

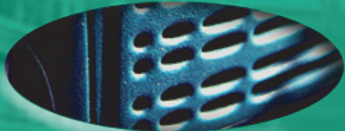

MOTOROLA

TWO-WAY RADIOS

contact



control

User Guide

GP330

Portable Radio



Professional Radio

BASIC USER GUIDE

CONTENTS

General Information	2
Operation and Control Functions	3
Radio Controls	3
Audio Signal Tones	4
Getting Started	5
Radio On-Off/Volume Control	5
Adjusting the Radio's Volume	5
Selecting a Radio Channel	5
Sending a Call	5
Receiving a Call	5
Battery Information	6
Battery Care and Tips	6
Recycling or Disposal of Batteries	7
Charging the Battery	7
Accessory Information	8
Attaching/Removing the Battery	8
Attaching/Removing the Belt Clip	8

Copyright Information

The Motorola products described in this manual may include copyrighted Motorola computer programs stored in semiconductor memories or other mediums. Laws in the United States and other countries preserve for Motorola certain exclusive rights for copyrighted computer programs, including the exclusive right to copy or reproduce in any form the copyrighted computer program. Accordingly, any copyrighted Motorola computer programs contained in the Motorola products described in this manual may not be copied or reproduced in any manner without the express written permission of Motorola. Furthermore, the purchase of Motorola products shall not be deemed to grant either directly or by implication, estoppel, or otherwise, any licence under the copyrights, patents, or patent applications of Motorola, except for the normal non-exclusive royalty-free licence to use that arises by operation of the law in the sale of a product.

GENERAL INFORMATION

This user guide covers the basic operation of the GP330 Portable Radio. Please consult your dealer for further, more detailed information which is contained in a full feature user guide 6866546D22.



Caution

Before using this product, read the operating instructions for safe usage contained in the Product Safety and RF Exposure booklet 6864117B25 enclosed with your radio.

ATTENTION!

This radio is restricted to occupational use only to satisfy ICNIRP RF energy exposure requirements. Before using this product, read the RF energy awareness information and operating instructions in the Product Safety and RF Exposure booklet (Motorola Publication part number 6864117B25) to ensure compliance with RF energy exposure limits.

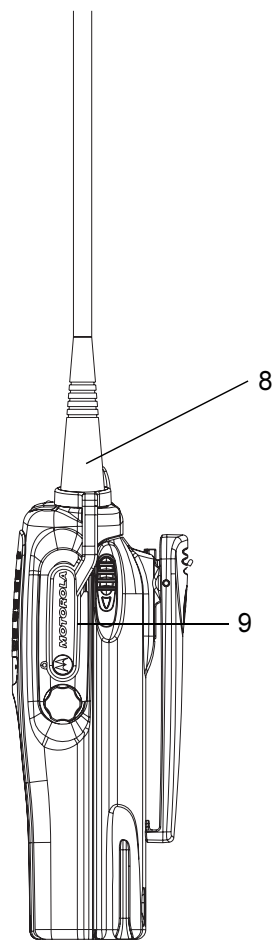
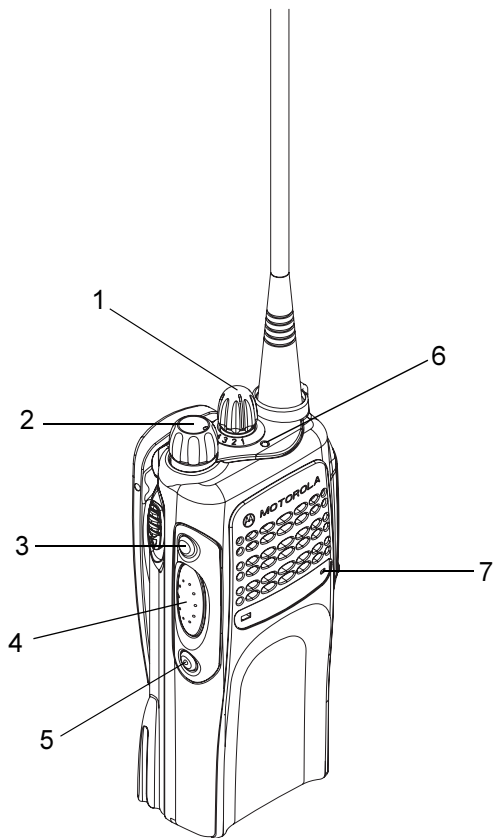

OPERATION AND CONTROL FUNCTIONS

Radio Controls

The numbers below refer to the illustrations on the inside front cover.

1. Channel Selector Knob (4 Position)
Used to switch the radio to different channels.
2. On-Off / Volume Knob
Used to turn the radio on or off, and to adjust the radio's volume.
3. Side Button 1 (programmable)
Recommended for Monitor/Cancel Button.
4. Push to Talk Button (PTT)
Press and hold down this button to talk, release it to listen.
5. Side Button 2 (programmable)
6. LED Indicator
Green: *Successful power up.*
Red: *Radio transmitting.*
Red Flashing: *Channel busy - when receiving.*
Yellow: *Radio called.*
Yellow Flashing: *Radio call reminder alert.*
Red Flashing: *Low battery warning - when transmitting.*
7. Microphone
Speak clearly into the microphone when sending a message.
8. Antenna
9. Accessory Connector
Connects headsets, remote speaker/microphones and other accessories. Replace attached dust cap when not in use.

Audio Signal Tones

High pitched tone 

Low pitched tone 

High pitched tones generally are positive indicators used for example to inform you of incoming calls, starting a feature and good status (e.g. radio power up OK).

Low pitched tones generally are negative indicators used for example to inform you of time restrictions, stopping a feature and bad status (e.g. error conditions).

Audio Indicators for Programmable Buttons

Some programmable buttons function as toggles, alternating between two different choices. These buttons use audio tones to indicate the change.

Programmable Buttons	High Pitched Tone	Low Pitched Tone
Tx Power	Radio transmits at high power	Radio transmits at low power
Monitor/Cancel	Radio operates in Monitor 1 or 2	Radio forced to monitor prior to transmitting
Call Forward	On - transfers your calls to another radio if you are absent	Off - Disables call forward when you return
Lone Worker	Enables Lone Worker function	Disables Lone Worker function
Whisper mode	On - allows you to talk quietly into microphone	Off - allows you to talk normally into microphone

GETTING STARTED

Radio On-Off/Volume Control

To turn the radio **on**, turn the **On-Off/Volume Control** knob clockwise.

To turn the radio **off**, turn the **On-Off/Volume Control** knob counterclockwise until you hear a click.

Adjusting the Radio's Volume

Turn the **On-Off/Volume Control** knob to adjust the volume level.

Selecting a Radio Channel

Turn the **Channel Selector** knob clockwise or counterclockwise until you reach the desired channel indicated on the Channel Selector knob graduation.

Sending a Call

1. Press the **PTT** button and speak clearly into the microphone.
Your mouth should be about 2.5 to 5 cm away from the microphone.
2. Release the **PTT** button when you finish speaking.

Receiving a Call

1. Turn your radio on and adjust the volume level.
2. If, at any time, a call is received, you will hear the call at the volume level you have set.

BATTERY INFORMATION

Battery Care and Tips

This product is powered by a nickel-cadmium (Ni-Cd), nickel-metal-hydride (NiMH), or lithium-ion rechargeable battery.

The following battery tips will help you obtain the highest performance and longest cycle life from your Motorola rechargeable battery.

- Charge your new battery overnight (**14-16 hrs**) before using it to obtain maximum battery capacity and performance.
- Charging in non-Motorola equipment may lead to battery damage and void the battery warranty.
- When charging a battery that is attached to the radio, turn the radio off to ensure a full charge.
- The battery should be at about 25°C/77°F (room temperature) whenever possible. Charging a cold battery (below 10°C/50° F) may result in leakage of electrolyte and ultimately, in failure of the battery.
- Charging a hot battery (above 35°C/95°F) results in reduced discharge capacity, affecting the performance of the radio. Motorola rapid-rate battery chargers contain a temperature-sensing circuit to ensure that the battery is charged within these temperature limits.
- New batteries can be stored up to two years without significant cycle loss. Store new/unused batteries in cool dry area.
- Batteries which have been in storage should be charged overnight.
- Do not return fully charged batteries to the charger for an “extra boost”. This action will **significantly** reduce battery life.
- Do not leave your radio and battery in the charger when not charging. Continuous charging will shorten battery life. (Do not use your charger as a radio stand.)
- For optimum battery life and operation use only Motorola brand chargers. They were designed to operate as an integrated energy system.

Recycling or Disposal of Batteries



At the end of its useful life, the NiCd battery can be recycled. However, recycling facilities may not be available in all areas.

Motorola endorses and encourages the recycling of all re-chargeable batteries. Contact your dealer for further information.

Charging the Battery

If a battery is new, or its charge level is very low, you will need to charge the battery before you can use it in your radio.

Note: Batteries are shipped uncharged from the factory. New batteries could prematurely indicate full charge, charge a new battery for **14-16 hrs** before initial use.

Charger LED	Status
Red	Battery is charging
Green	Battery is fully charged
Flashing Red *	Battery is unchargeable
Flashing Yellow	Charger is getting ready to charge
Flashing Green	Battery is 90% charged

* Battery is damaged. Please contact your dealer.

1. Place the radio with the battery attached, or the battery alone, in the charger.
2. The charger's LED indicates the charging progress.

Battery chargers will charge only the Motorola authorized batteries listed below; other batteries will not charge.

Part No.	Description
HNN9008	High-Capacity NiMH
HNN9009	Ultra-High-Capacity NiMH
HNN9010	Ultra-High-Capacity Factory Mutual NiMH
HNN9011	High-Capacity Factory Mutual NiCd
HNN9012	High-Capacity NiCd
HNN9013	Lithium-Ion

ACCESSORY INFORMATION

Attaching the Battery

1. Fit the extensions at the bottom of the battery into the slots at the bottom of the radio's body.
2. Press the top part of the battery towards the radio until you hear a click.

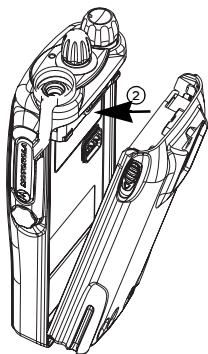

Attaching the Belt Clip

1. Align the grooves of the belt clip with those of the battery.
2. Press the belt clip downwards until a click is heard.

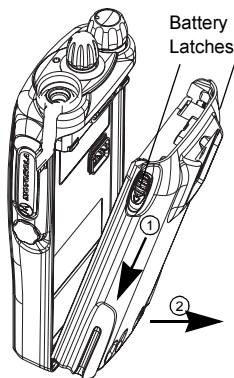

Battery Latches

Removing the Battery

Ensure radio is switched off.

1. Slide the battery latches, on both sides of the battery, downwards.
2. Pull the top part of the battery away from the radio's body, and remove the battery.

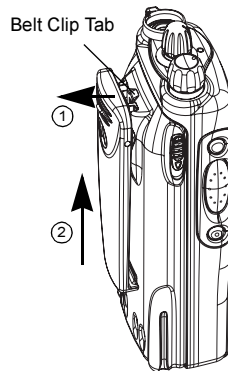

Belt Clip Tab

Removing the Belt Clip

1. Use a key to press the belt clip tab away from the battery.
2. Slide the belt clip upwards to remove it.

Free Manuals Download Website

<http://myh66.com>

<http://usermanuals.us>

<http://www.somanuals.com>

<http://www.4manuals.cc>

<http://www.manual-lib.com>

<http://www.404manual.com>

<http://www.luxmanual.com>

<http://aubethermostatmanual.com>

Golf course search by state

<http://golfingnear.com>

Email search by domain

<http://emailbydomain.com>

Auto manuals search

<http://auto.somanuals.com>

TV manuals search

<http://tv.somanuals.com>