

*User Guide*

*QIP2500 Series  
Set-Top Terminal*

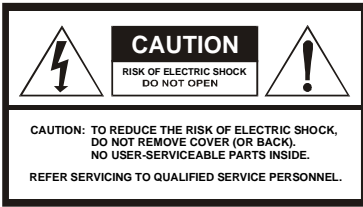



Graphical symbols and supplemental warning marking locations on bottom of terminal.

#### **WARNING**

TO REDUCE THE RISK OF FIRE OR ELECTRIC SHOCK HAZARD, DO NOT EXPOSE THIS APPLIANCE TO RAIN OR MOISTURE.

#### **CAUTION**

**TO PREVENT ELECTRICAL SHOCK, DO NOT USE THIS (POLARIZED) PLUG WITH AN EXTENSION CORD, RECEPTACLE, OR OTHER OUTLET UNLESS THE BLADES CAN BE FULLY INSERTED TO PREVENT BLADE EXPOSURE.**



The lightning flash with arrowhead symbol, within an equilateral triangle, is intended to alert the user to the presence of uninsulated "dangerous voltage" within the product's enclosure that may be of sufficient magnitude to constitute a risk of electric shock to persons.



The exclamation point, within an equilateral triangle, is intended to alert the user to the presence of important operating and maintenance (servicing) instructions in the literature accompanying the appliance.

**This installation should be made by a qualified service person and should conform to all local codes.**

#### **REPAIRS**

If you find the unit in need of repair, contact your system operator for repair or replacement.

#### **NOTE TO SYSTEM INSTALLER**

This reminder is provided to call the system installer's attention to Article 820-40 of the NEC that provides guidelines for proper grounding and, in particular, specifies that the cable ground shall be connected to the grounding system of the building, as close as possible to the point of cable entry as practical.

# IMPORTANT SAFETY INSTRUCTIONS

- 1** Read these instructions.
- 2** Keep these instructions.
- 3** Heed all warnings.
- 4** Follow all instructions.
- 5** Do not use this apparatus near water.
- 6** Clean only with dry cloth.
- 7** Do not block any ventilation openings. Install in accordance with the manufacturer's instructions.
- 8** Do not install near any heat sources such as radiators, heat registers, stoves, or other apparatus (including amplifiers) that produce heat.
- 9** Do not defeat the safety purpose of the polarized or grounding-type plug.
- 10** Protect the power cord from being walked on or punched particularly at plugs, convenience receptacles, and the point where they exit from the apparatus.
- 11** Use only attachments/accessories specified by the manufacturer.
- 12** Unplug this apparatus during lightning storms or when unused for long periods of time.
- 13** Refer all servicing to qualified service personnel. Servicing is required when the apparatus has been damaged in any way, such as power-supply cord or plug is damaged, liquid has been spilled or objects have fallen into the apparatus, the apparatus has been exposed to rain or moisture, does not operate normally, or has been dropped.

# Regulatory Information

## **Federal Communications Commission Radio and Television Interface Statement for a Class 'B' Device**

This equipment has been tested and found to comply with the limits for a Class B digital device, pursuant to part 15 of the FCC Rules. These limits are designed to provide reasonable protection against harmful interference in the residential installation. This equipment generates, uses and can radiate radio frequency energy and, if not installed and used in accordance with the instructions, may cause harmful interference to radio communications. However, there is no guarantee that interference will not occur in a particular installation.

If the equipment does cause harmful interference to radio or television reception, which can be determined by turning the equipment off and on, the user is encouraged to try to correct the interference by one of the following measures:

- Increase the separation between the equipment and the affected receiver
- Connect the equipment on a circuit different from the one the receiver is on
- Ensure that the cover plate for the security card is secured and tight

Changes or modification not expressly approved by the party responsible for compliance could void the user's authority to operate the equipment.

## Declaration of Conformity

According to 47 CFR, Parts 2 and 15 for Class B Personal Computers and Peripherals; and/or CPU Boards and Power Supplies used with Class B Personal Computers, Motorola, Inc., 6450 Sequence Drive, San Diego, CA 92121, 1-800-225-9446, declares under sole responsibility that the product identifies with 47 CFR Part 2 and 15 of the FCC Rules as a Class B digital device. Each product marketed is identical to the representative unit tested and found to be compliant with the standards. Records maintained continue to reflect the equipment being produced can be expected to be within the variation accepted, due to quantity production and testing on a statistical basis as required by 47 CFR 2.909. Operation is subject to the following condition: This device must accept any interference received, including interference that may cause undesired operation. The above named party is responsible for ensuring that the equipment complies with the standards of 47 CFR, Paragraphs 15.101 to 15.109. The Class B digital apparatus meets all requirements of the Canadian Interface Causing Equipment Regulations.

### U.S. GOVERNMENT RESTRICTED RIGHTS

The Product and documentation is provided with RESTRICTED RIGHTS. The use, duplication or disclosure by the Government is subject to restrictions as set forth in subdivision (c)(1)(ii) of The Rights in Technical Data and Computer Software clause at 52.227-7013. The contractor/manufacture is Motorola, Inc., Broadband Communications Sector, 101 Tournament Drive, Horsham, PA 19044.

## Canadian Compliance

This Class B digital apparatus complies with Canadian ICES-003. Cet appareil numérique de la classe B est conforme à la norme NMB-003 du Canada.

# Software License

**IMPORTANT:** PLEASE READ THIS SOFTWARE LICENSE ("LICENSE") CAREFULLY BEFORE YOU USE ANY SOFTWARE, FIRMWARE AND RELATED DOCUMENTATION ("SOFTWARE") PROVIDED WITH MOTOROLA'S DIGITAL CABLE RECEIVER OR HOME THEATER SYSTEM (EACH SHALL BE REFERRED TO IN THIS LICENSE AS A "RECEIVER"). BY USING THE RECEIVER AND/OR USING ANY OF THE SOFTWARE, YOU INDICATE YOUR ACCEPTANCE OF EACH OF THE TERMS OF THIS LICENSE. UPON ACCEPTANCE, THIS LICENSE WILL BE A LEGALLY BINDING AGREEMENT BETWEEN YOU AND MOTOROLA. THE TERMS OF THIS LICENSE APPLY TO YOU AND TO ANY SUBSEQUENT USER OF THIS SOFTWARE.

IF YOU DO NOT AGREE TO ALL OF THE TERMS OF THIS LICENSE (I) DO NOT USE THE SOFTWARE AND (II) RETURN THE RECEIVER AND THE SOFTWARE (COLLECTIVELY, "PRODUCT"), INCLUDING ALL COMPONENTS, DOCUMENTATION AND ANY OTHER MATERIALS PROVIDED WITH THE PRODUCT, TO YOUR POINT OF PURCHASE OR SERVICE PROVIDER, AS THE CASE MAY BE, FOR A FULL REFUND.

The Software includes associated media, any printed materials, and any "on-line" or electronic documentation. Software provided by third parties may be subject to separate end-user license agreements from the manufacturers of such Software. The Software is never sold. Motorola licenses the Software to the original customer and to any subsequent licensee for personal use only on the terms of this License. Motorola and its third party licensors retain the ownership of the Software.

## SOFTWARE LICENSE

### You may:

USE the Software only in connection with the operation of the Product.

TRANSFER the Software (including all component parts and printed materials) permanently to another person, but only if the person agrees to accept all of the terms of this License. If you transfer the Software, you must at the same time transfer the Product and all copies of the Software (if applicable) to the same person or destroy any copies not transferred.

TERMINATE this License by destroying the original and all copies of the Software (if applicable) in whatever form.

### You may not:

(1) Loan, distribute, rent, lease, give, sublicense or otherwise transfer the Software, in whole or in part, to any other person, except as permitted under the TRANSFER paragraph above. (2) Copy or translate the User Guide included with the Software, other than for personal use. (3) Copy, alter, translate, decompile, disassemble or reverse engineer the Software, including but not limited to, modifying the Software to make it operate on non-compatible hardware. (4) Remove, alter or cause not to be displayed, any copyright notices or startup message contained in the Software programs or documentation. (5) Export the Software or the Product components in violation of any United States export laws.

The Product is not designed or intended for use in on-line control of aircraft, air traffic, aircraft navigation or aircraft communications; or in design, construction, operation or maintenance of any nuclear facility. MOTOROLA AND ITS THIRD PARTY LICENSORS DISCLAIM ANY EXPRESS OR IMPLIED WARRANTY OF FITNESS FOR SUCH USES. YOU REPRESENT AND WARRANT THAT YOU SHALL NOT USE THE PRODUCT FOR SUCH PURPOSES.

Title to this Software, including the ownership of all copyrights, mask work rights, patents, trademarks and all other intellectual property rights subsisting in the foregoing, and all adaptations to and modifications of the foregoing shall at all times remain with Motorola and its third party licensors. Motorola retains all rights not expressly licensed under this License. The Software, including any images, graphics, photographs, animation, video, audio, music and text incorporated therein is owned by Motorola or its third party licensors and is protected by United States copyright laws and international treaty provisions. Except as otherwise expressly provided in this License, the copying, reproduction, distribution or preparation of derivative works of the Software, any portion of the Product or the documentation is strictly prohibited by such laws and treaty provisions. Nothing in this License constitutes a waiver of Motorola's rights under United States copyright law.

This License and your rights regarding any matter it addresses are governed by the laws of the Commonwealth of Pennsylvania, without reference to conflict of laws principles. THIS LICENSE SHALL TERMINATE AUTOMATICALLY if you fail to comply with the terms of this License.

Motorola is not responsible for any third party software that is provided as a bundled application, or otherwise, with the Software or that is downloaded to, or otherwise installed on, the Product.

# Contact Us

For technical support of your set-top, call Motorola Support at **1-866-668-2271** or **1-866-MOT-BCS1**.

For questions about your TV service, call your local service provider.

For Motorola consumer products, education, and support:

<http://www.motorola.com/broadband>

---

Copyright © 2005 by Motorola, Inc. All rights reserved. No part of this publication may be reproduced in any form or by any means or used to make any derivative work (such as translation, transformation or adaptation) without written permission from Motorola, Inc.

MOTOROLA and the Stylized M Logo are registered in the US Patent & Trademark Office. Dolby Digital manufactured under license from Dolby Laboratories Licensing Corporation. Dolby, ProLogic, and the double-D symbol are registered trademarks of Dolby Laboratories Licensing Corporation. Verizon is a registered trademark of Verizon Trademark Services LLC.

All other product or service names are the property of their respective owners.

Motorola reserves the right to revise this publication and to make changes in content from time to time without obligation on the part of Motorola to provide notification of such revision or change. Motorola provides this guide without warranty of any kind, either implied or expressed, including, but not limited to, the implied warranties of merchantability and fitness for a particular purpose. Motorola may make improvements or changes in the product(s) described in this manual at any time.

This device incorporates a copyright protection technology that is protected by U.S. patents and other intellectual property rights. Use of the copyright protection technology is granted by Macrovision for home and other limited pay-per-view uses only, unless otherwise authorized by Macrovision. Reverse engineering or disassembly is prohibited.

U.S. Patent Nos. 4631603, 4557216, 4819098 licensed for limited pay-per-view uses only.

## CONTENTS

Introduction .....	2
Front Panel .....	3
Rear Panel .....	4
Using the Remote Control – Example Only .....	6
Basic Operation.....	7
Electronic Program Guide .....	7
Audio Output Modes .....	7
Audio/Video Connections .....	8
Recording Your Connections .....	10
Connecting your QIP2500 .....	11
Standard TV Cabling .....	11
Standard VCR Cabling .....	12
Composite Video and S-Video .....	13
Composite VCR Cabling .....	14
Stereo Cabling (VCR to Stereo).....	15
Stereo Cabling (TV to Stereo).....	16
Baseband Cabling .....	17
Dolby Digital Cabling.....	18
Troubleshooting .....	19



**MOTOROLA**

## INTRODUCTION

Congratulations on receiving your state-of-the-art QIP2500 Digital Set-top Terminal. The QIP2500 brings unsurpassed digital audio and video quality to your TV viewing and enables electronic program guide (EPG) menus that make selecting and viewing programs convenient and easy. It's simple to set up and easy to operate. Based on local services, you can purchase Pay-Per-View special events and recent movies via Video-on-Demand (VOD). VOD is similar to renting a video, including the ability to pause, rewind, and fast-forward.

This guide introduces you to the features and operation of the QIP2500. The EPG provides access to the QIP2500 features.

*To get the most out of your QIP2500, be sure to read your EPG instruction manual or other literature supplied by your service provider.*

*Your QIP2500 includes or supports the following features:*

- *Superior all-digital video and sound experience*
- *On-screen graphics to support Electronic Program Guide (EPG)*
- *Extended services support, including Pay-Per-View (PPV) and Video-on-Demand (VOD)*
- *Remote control (supplied by your service provider)*
- *Parental control (using EPG)*
- *Favorite channel recall (using EPG)*
- *USB 1.1 connectivity (depending on local service offering)*

### NOTE

*EPG services and features such as VOD and PPV are enabled by your local service provider. Services may vary based on local offerings and promotions.*



## INTRODUCTION

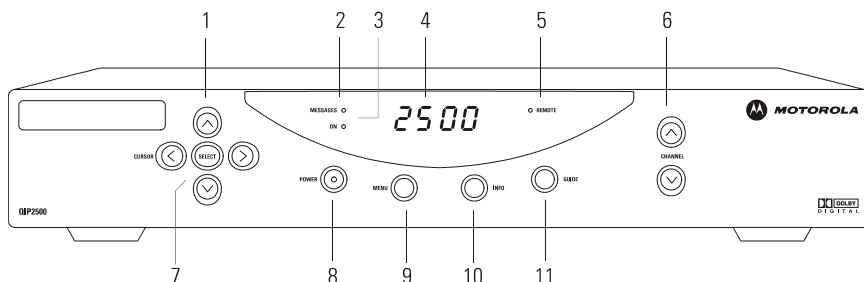

## Front Panel

The QIP2500 front panel has 11 keys and an LED display. Use the keys to perform basic functions, such as changing channels and turning the set-top on and off. Display the current channel or time of day on the LED display by changing the default settings in the electronic program guide.

Item	Description
1	CURSOR – Moves the cursor in menus and electronic program guide (EPG) screens
2	MESSAGES – Lights to indicate that a message is present
3	ON – Lights when the unit is turned on
4	DISPLAY – Displays current channel number or time of day
5	REMOTE – Flashes when a signal is received from the remote control
6	CHANNEL – Changes the channel up and down
7	SELECT – Selects menu options and tunes channels from the EPG
8	POWER – Turns the QIP2500 on and off
9	MENU – Displays the Main Menu
10	INFO – Displays current channel and program information
11	GUIDE – Displays the electronic program guide (EPG)

## INTRODUCTION

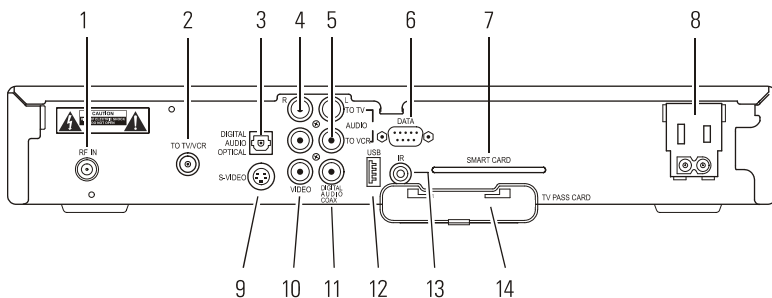

### Rear Panel

Before you begin installing the QIP2500, take a moment to become familiar with the rear panel connections.

These connectors are for home entertainment cabling. An AC power cord connects the QIP2500 to an electrical power outlet. For cabling diagrams, see “Connecting Your QIP2500.”

## **INTRODUCTION**

<b>Item</b>	<b>Description</b>
<b>1</b>	RF IN – Connects to and receives a cable signal from your service provider
<b>2</b>	TO TV/VCR – Connects to a TV or VCR
<b>3</b>	DIGITAL AUDIO OPTICAL – Connects to a digital A/V receiver (optional)
<b>4</b>	AUDIO OUT TO TV – RCA stereo outputs (R/L) that connect to your TV
<b>5</b>	AUDIO OUT TO VCR – RCA stereo outputs (R/L) that connect to your VCR
<b>6</b>	DATA – Serial data interface (check with your service provider before connecting any device to this port)
<b>7</b>	SMART CARD – Supports a Smart Card device (currently not enabled)
<b>8</b>	AC POWER – A two-plug AC power inlet used to power the QIP2500 (bottom) and another device (top), such as a TV or VCR
<b>9</b>	S-VIDEO – Connects to S-Video input of TV or VCR
<b>10</b>	VIDEO – RCA video output that connect to a TV, VCR, or other device
<b>11</b>	DIGITAL AUDIO COAX – Connects to a digital A/V (audio/video) receiver
<b>12</b>	USB – Connects to select USB 1.1 devices (check with your service provider before connecting any device to this port)
<b>13</b>	IR – Connects the optional Infrared (IR) blaster attachment
<b>14</b>	TV PASS CARD – For future use

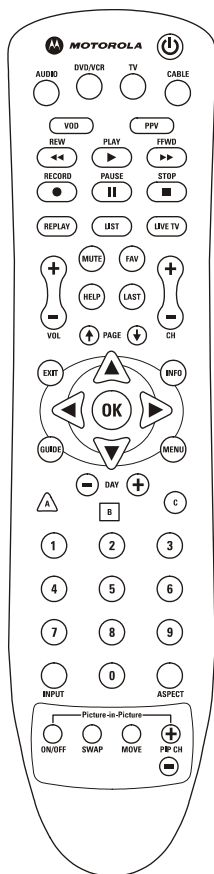
**USING THE REMOTE CONTROL – EXAMPLE ONLY**

Use a remote control to operate the QIP2500, TV, and VCR.

*Your remote control is provided by your local service provider and may be different from the example shown here.*

The remote control must be programmed for use. If your service provider has not programmed your remote control, refer to the remote control instruction guide supplied by your service provider for setup and operation instructions.

## BASIC OPERATION

### Turning Power On and Off

Press **POWER** on the front panel to turn the set-top on or off. When using the remote control, be sure you press **CABLE** before pressing **POWER**.

### Changing Channels

You can change channels in two ways:

- Press **CHANNEL ▲** or **▼** on the front panel of the set-top, or press **CHANNEL +** or **-** on the remote control to step through the channel selection.
- Enter the number of the channel you wish to view using the number keys on the remote control.

### Adjusting the Volume

Press **VOLUME +** or **-** on the remote control to adjust the volume. When you adjust the volume, the volume scale is displayed on the screen. Press **MUTE** on the remote control to turn the sound off and on again.

For best audio quality, use the remote control to set the set-top to approximately  $\frac{3}{4}$  of the maximum volume level and then adjust the audio levels on external devices, such as your TV or A/V Receiver.

### Electronic Program Guide

The electronic program guide (EPG) displays information about TV programs and enables you to access features such as Parental Control or Pay-Per-View. EPGs can vary in look and feel, depending on your service provider. Refer to the EPG instruction manual supplied by your service provider for detailed instructions.

### Audio Output Modes

The QIP2500 includes utilities that enable you to select and adjust its DIGITAL AUDIO (coaxial or optical) or AUDIO OUT (RCA-style) outputs. If your EPG takes advantage of these utilities, it provides menu choices to select and optimize the audio output and compression modes. For more information about audio output mode configuration, refer to your EPG user manual.



**MOTOROLA**

## AUDIO/VIDEO CONNECTIONS

Before you begin to install your QIP2500, review the following guidelines:

- For basic cable connections, use 75-ohm coaxial cables equipped with F-type connectors. You can find coaxial cables in your local electronics store.
- For audio or video outputs, use cables equipped with RCA-type connectors.
- For the digital audio optical output, use a Toslink cable.
- Disconnect power from the QIP2500 before connecting or changing cable connections.

Do not place anything on top of the QIP2500, especially other home video components.

### NOTE

*To prevent overheating, make sure the set-top has adequate ventilation. Never place anything on top of the QIP2500 digital cable receiver.*

## Important Safety Considerations

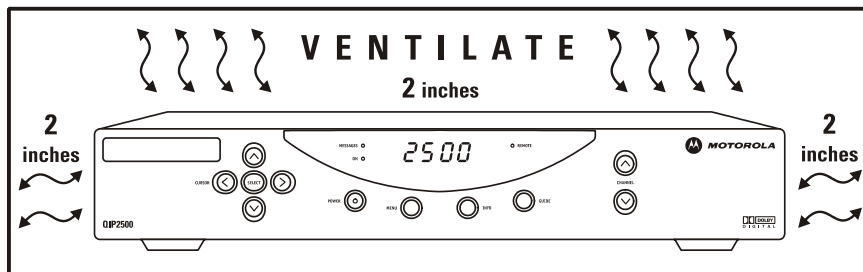

Follow these important safety guidelines when positioning and connecting the set-top:

- Position the set-top with at least two inches of space above and on all sides.
- Do not block the slots and openings on the set-top.
- Do not place anything on top of the set-top.
- Do not position the set-top in an enclosed space that would restrict airflow around the unit.
- Do not position the set-top near any external heat source that could raise the temperature around the unit. Do not place the set-top on top of another heat-producing electronic device.
- Allow for adequate ventilation around the set-top to maintain normal operating temperature. Do not place the set-top in a sealed enclosure without providing for adequate airflow.
- Do not plug the AC power cord into a switched power outlet.

## RECORDING YOUR CONNECTIONS

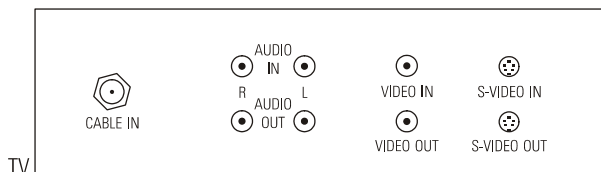
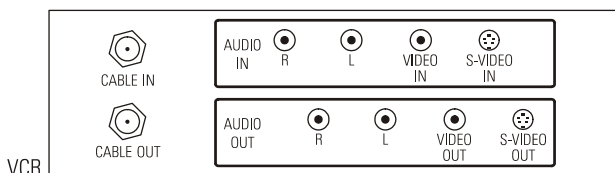
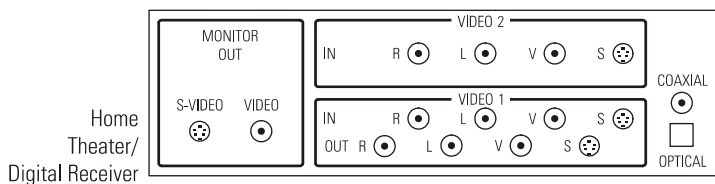
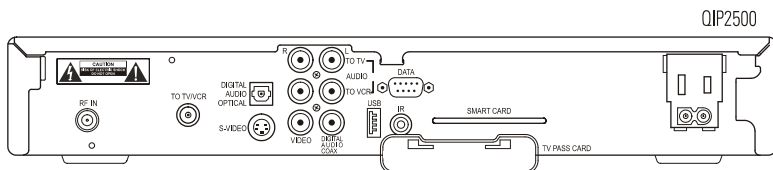

Use this diagram to record cable connections on the rear panel. Later, you can use this diagram to reconnect your system if you move the equipment or add new equipment.

Your home entertainment equipment may not have all connectors shown in the illustration, or it may have connectors that are not shown here.

*Disconnect the power from the QIP2500 before making or changing cable connections. Do not place another component or object on top of the QIP2500.*



## CONNECTING YOUR QIP2500

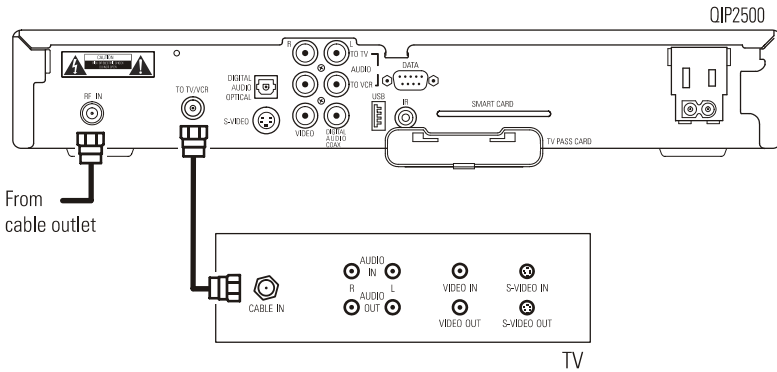

### Standard TV Cabling

Use 75-ohm coaxial cables to connect your set-top to a standard TV. This is the most common cable connection and it provides all of the basic features of the QIP2500.

If you connect the coaxial cable to the TO TV/VCR connector on the set-top and to the coaxial CABLE IN connector on the TV, you must tune your TV to channel 3 or 4.

The method shown will not provide stereo audio. Connect the set-top to the TV using standard RCA audio cables (left and right) to receive stereo audio on all channels, when available.

## CONNECTING YOUR QIP2500

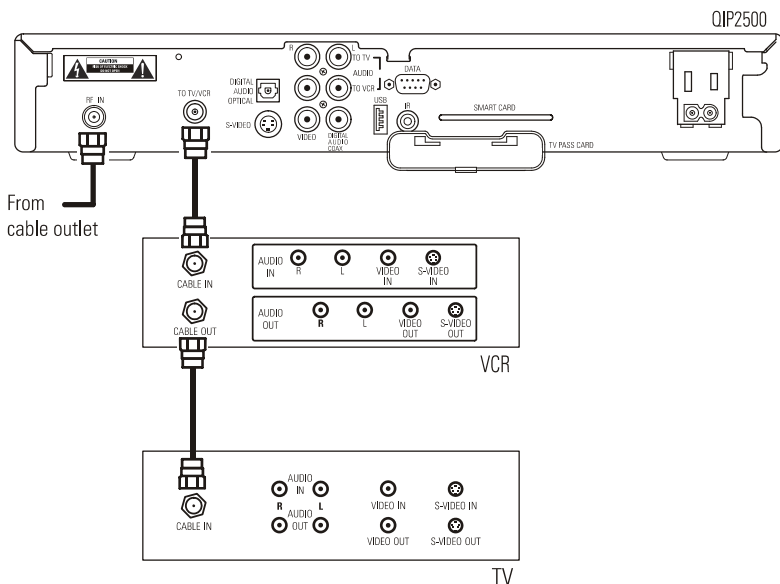

### Standard VCR Cabling

To connect your VCR, you will need 75-ohm coaxial cables. The method shown lets you record the program you are watching, including Pay-Per-View events. You can also view videotapes.

The method shown will not provide stereo audio. Connect the set-top to the TV using standard RCA audio cables (left and right) to receive stereo audio on all channels, when available.

## CONNECTING YOUR QIP2500

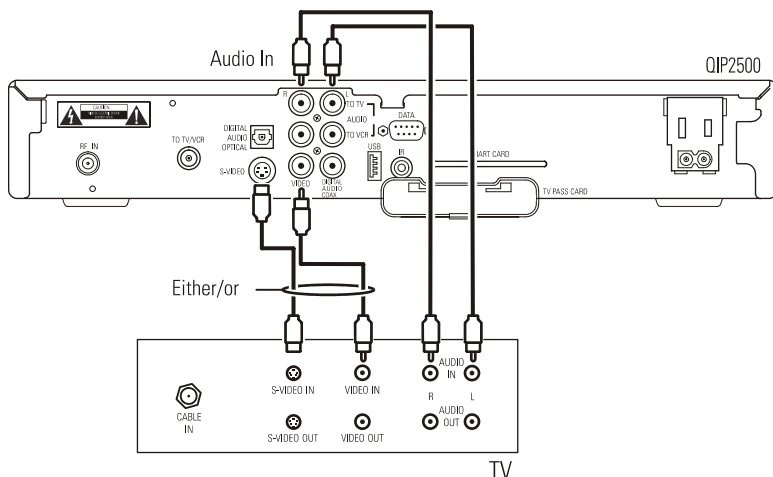

### Composite Video and S-Video

Connect the set-top using composite Video or S-Video outputs for stereo audio if available on your TV.

**Composite Video:** Connect an RCA-type cable from the VIDEO port on the set-top to the VIDEO IN port on the TV.

**OR**

**S-Video:** Connect an S-Video cable from the S-VIDEO port on the set-top to the S-VIDEO IN port on the TV.

*When connecting the video path, never connect baseband composite video and S-Video at the same time. Some entertainment equipment will not support both video inputs simultaneously.*

## CONNECTING YOUR QIP2500

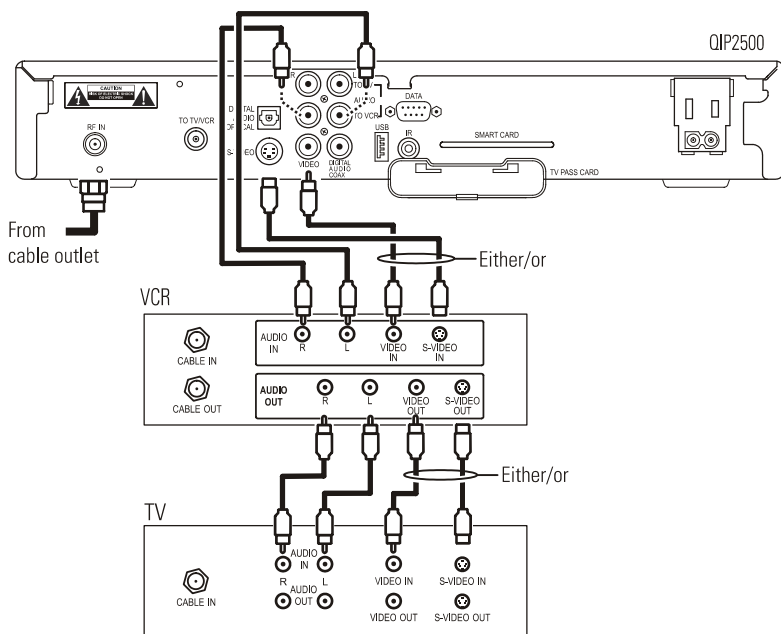

### Composite VCR Cabling

This diagram shows how to connect the set-top to a VCR using the audio connectors on the VCR.

*When connecting the video path, never connect baseband composite video and S-Video at the same time. Some entertainment equipment will not support both video inputs simultaneously.*

**CONNECTING YOUR QIP2500**

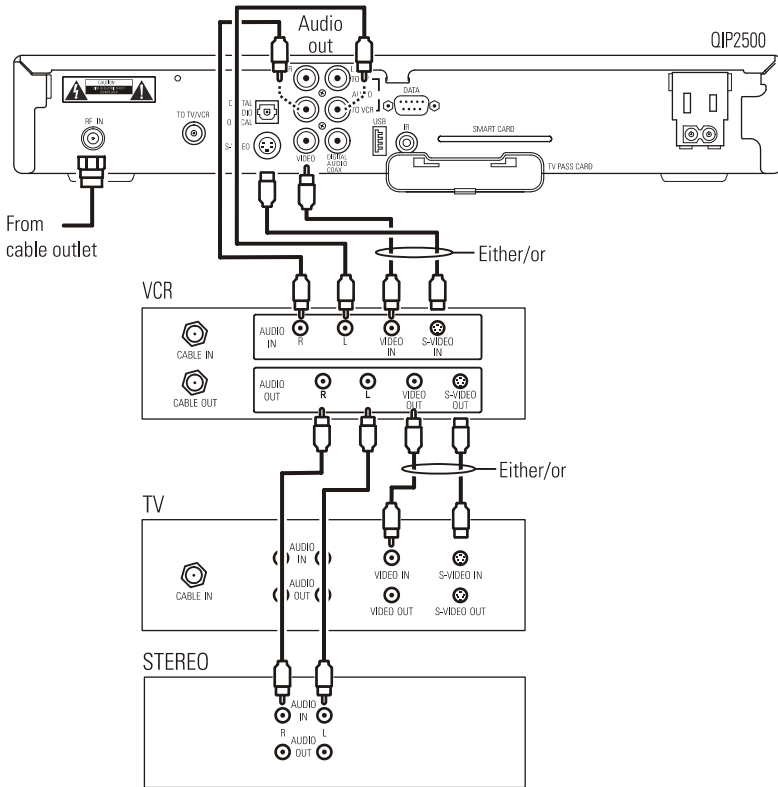

**Stereo Cabling (VCR to Stereo)**

This diagram shows how to connect the set-top to a stereo using the audio connectors on the VCR. The VCR sound is played through the stereo.

*When connecting the video path, never connect baseband composite video and S-Video at the same time. Some entertainment equipment will not support both video inputs simultaneously.*

## CONNECTING YOUR QIP2500

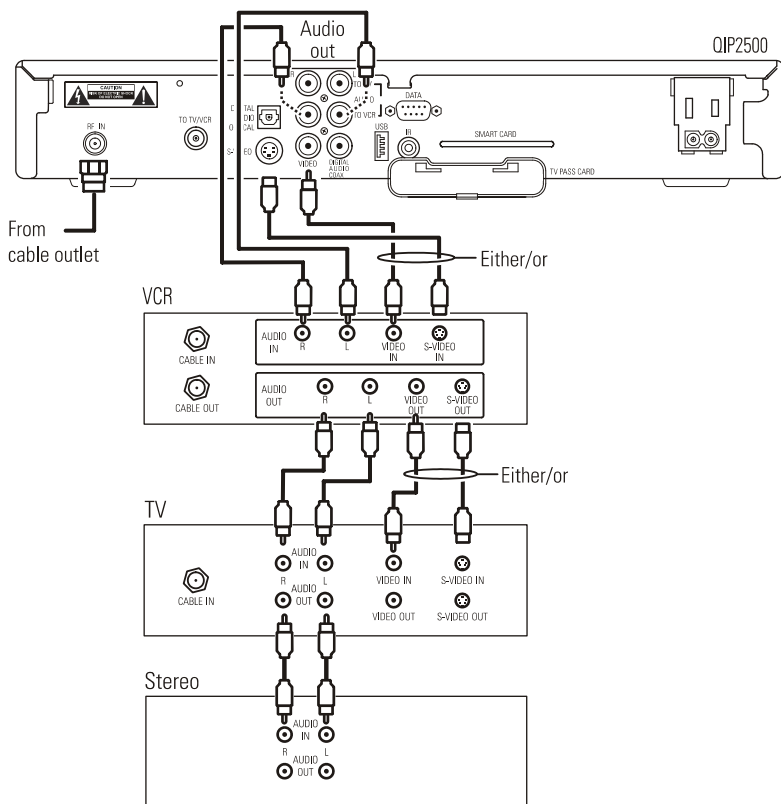

### Stereo Cabling (TV to Stereo)

This diagram shows how to connect the TV so that its sound plays through the stereo.

*When connecting the video path, never connect baseband composite video and S-Video at the same time. Some entertainment equipment will not support both video inputs simultaneously.*

**CONNECTING YOUR QIP2500**

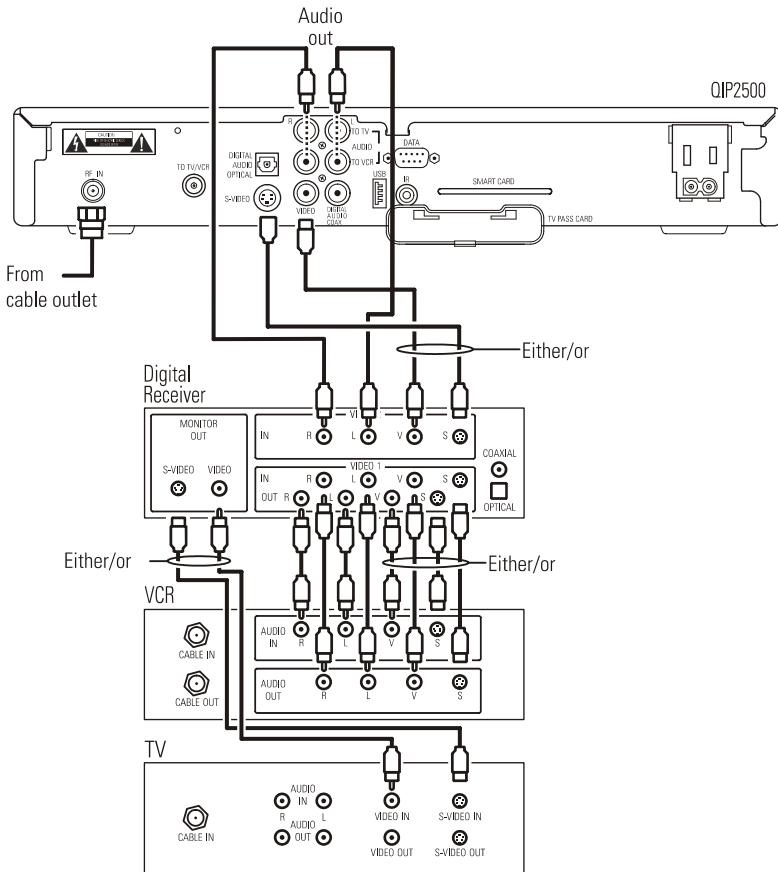

**Baseband Cabling**

This diagram shows baseband audio and video connections to a Dolby® Digital receiver. This setup lets you record on the VCR and play back with sound through the Dolby Digital receiver, but this setup does not support surround sound. To play back Dolby Digital 5.1 surround sound through the Dolby Digital receiver, see “Dolby Digital Cabling.”

**NOTE**

*In this diagram, the baseband connectors on the entertainment components are labeled R for right audio, L for left audio, V for video, and S for S-video.*

## CONNECTING YOUR QIP2500

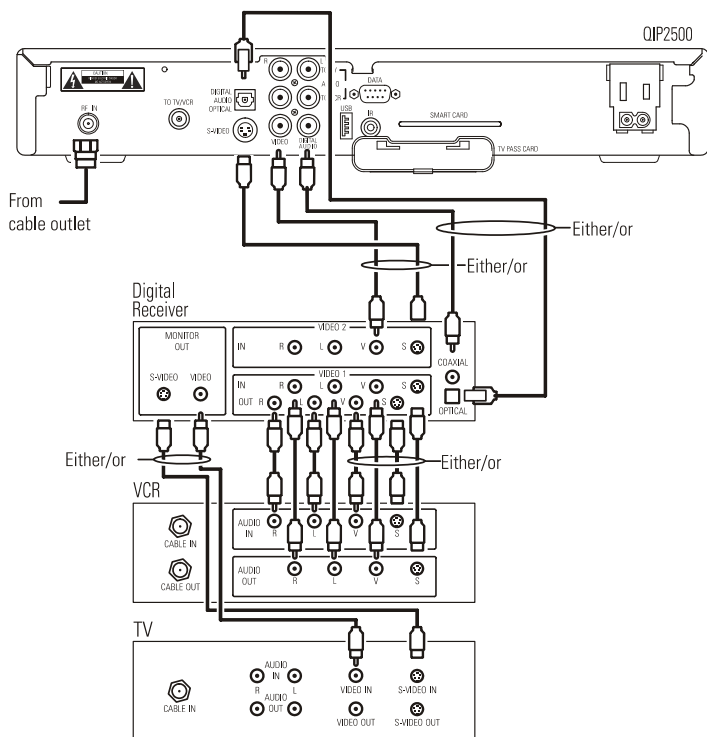

### Dolby Digital Cabling

This diagram shows audio and video connections to a Dolby Digital receiver. This setup lets you record on the VCR and play back with sound through the Dolby Digital receiver.

*To play back Dolby Digital 5.1 surround sound through the Dolby Digital receiver, you must connect the set-top to the receiver using the DIGITAL AUDIO COAX or DIGITAL AUDIO OPTICAL connections. The audio R and L connectors do not carry Dolby Digital 5.1.*

#### NOTE

*In this illustration, the baseband connectors on the entertainment components are labeled R for right audio, L for left audio, v for video, and s for S-video.*



## TROUBLESHOOTING

<b>Problem</b>	<b>Possible Solution</b>
<b>The set-top will not power on</b>	<p>Reconnect the power cord. Be sure the QIP2500 is plugged into an outlet that is always live.</p> <p>The set-top may have received a software update and may not power on while the new software is being installed. Try again in a few minutes.</p> <p>Verify that the AC power cord is connected to the set-top and an AC outlet. Unplug the set-top from the AC outlet, plug it back in, and then press the <b>POWER</b> button.</p> <p>If the set-top is connected to a switched outlet on another unit, verify that that unit is powered on. Unplug the set-top from the AC outlet, plug it back in, and then press the <b>POWER</b> button.</p> <p>Press the <b>POWER</b> button on the set-top front panel instead of the remote control. The batteries in the remote control may be depleted.</p>
<b>The remote control does not work</b>	<p>Press <b>CABLE</b> on the remote control to ensure the remote control is in <b>CABLE</b> mode.</p> <p>Be sure there are no obstructions between the remote control and the set-top. Aim the remote control directly at the set-top front panel, not the TV or VCR.</p> <p>Be sure that nothing is on the QIP2500 or blocking a clear line of sight between it and the remote control.</p> <p>Press and release operation keys one at a time, firmly and deliberately.</p> <p>Try changing channels using the buttons on the set-top front panel.</p> <p>Change the batteries in your remote.</p>



---

**There is no audio from the center and/or surround speakers of a home theater/digital receiver connected to the set-top**

Not all Dolby Digital<sup>®</sup> programs feature full 5:1 surround sound. In some cases, the programs may only contain left and right stereo audio.

Verify that the SPDIF cable (round coaxial connector or square optical connector) is firmly connected to the set-top and the home theater receiver.

Verify that the home theater receiver is set to a surround sound audio mode (Dolby Digital, Dolby Pro Logic<sup>®</sup> II, Dolby Pro Logic).

Verify that the receiver is properly configured to work with all connected speakers.

---

**There is no sound when viewing channels**

If the set-top audio output is connected to the TV, verify that the MUTE button on the TV has not been pressed. Press **MUTE** on the remote control to restore the volume level.

Check that the stereo is connected to the proper audio ports.

If the set-top audio output is connected to a home theater, verify that the receiver is set to the appropriate input source and the MUTE button on the receiver has not been pressed.

Be sure the audio cables are firmly connected between the set-top and the audio playback device (TV, receiver, or other device).

Turn your VCR on.

Make sure the TV or stereo volume is set to an appropriate level. For best audio level control, use the remote control to set the QIP2500 to approximately  $\frac{3}{4}$  of the maximum volume level and then adjust the audio levels of the external devices.

---

**Picture or sound is noisy on one channel**

Reconnect the cable and hand-tighten if loose.

---

**Sound from only one stereo speaker**

Hand-tighten or reconnect the cables properly. Be sure wires are not frayed and plugs are not bent or broken.

---

---

**There is no video on the TV screen**

Verify that the TV is powered on and set to the appropriate input source for the set-top.

Verify that the set-top is powered on and tuned to an authorized digital TV channel.

Verify that all video cables between the set-top and the TV are firmly connected (hand tighten if necessary).

Verify that the coaxial cable feed is firmly connected to the set-top and the wall jack.

If the set-top video output is connected to a home theater/digital receiver, verify that the receiver is powered on and set to the appropriate input source.

If you are watching TV using your VCR, be sure your VCR is on.

---

Visit our website at:  
[www.motorola.com](http://www.motorola.com)



522267-001  
5/05

MGBI

## Free Manuals Download Website

<http://myh66.com>

<http://usermanuals.us>

<http://www.somanuals.com>

<http://www.4manuals.cc>

<http://www.manual-lib.com>

<http://www.404manual.com>

<http://www.luxmanual.com>

<http://aubethermostatmanual.com>

Golf course search by state

<http://golfingnear.com>

Email search by domain

<http://emailbydomain.com>

Auto manuals search

<http://auto.somanuals.com>

TV manuals search

<http://tv.somanuals.com>