

INSTALLATION MANUAL

VIP1200/1216

Set-top Box





WARNING: TO PREVENT ELECTRIC SHOCK, DO NOT REMOVE COVER. NO USER SERVICEABLE PARTS INSIDE. REFER SERVICING TO QUALIFIED SERVICE PERSONNEL.

Graphical symbols and supplemental warning markings are located on the back and bottom of the terminal.

WARNING

TO REDUCE THE RISK OF FIRE OR SHOCK, DO NOT EXPOSE THIS APPLIANCE TO RAIN OR MOISTURE.



The lightning flash with arrowhead symbol within an equilateral triangle is intended to alert the user to the presence of uninsulated dangerous voltage within the product's enclosure that may be of sufficient magnitude to constitute a risk of electric shock to persons.



The exclamation point within an equilateral triangle is intended to alert the user to the presence of important operating and maintenance (servicing) instructions in the literature accompanying the appliance.

Product identification and supply rating are provided on the label found on the bottom of the unit.

IMPORTANT SAFETY INSTRUCTIONS

- Read these instructions.
- Keep these instructions.
- Heed all warnings.
- Follow all instructions.
- Do not use this apparatus near water.
- Clean only with a dry cloth.
- Do not block any ventilation openings. Install according to the manufacturer's instructions.
- Do not install near any heat sources, such as radiators, heat registers, stoves, or other apparatus (including amplifiers) that produce heat.
- Do not defeat the safety purpose of the polarized or grounding-type plug. A polarized plug has two blades with one wider than the other. A grounding type plug has two blades, and a third grounding prong. The wide blade or the third prong is provided for your safety. If the provided plug does not fit into your outlet, consult an electrician for replacement of the obsolete outlet.

- Protect the power cord from being walked on or pinched, particularly at plugs, convenience receptacles, and the point where they exit from the apparatus.
- Only use attachments/accessories specified by the manufacturer.
- Unplug this apparatus during lightning storms or when unused for long periods of time.
- Refer all servicing to qualified service personnel. Servicing is required when the apparatus has been damaged in any way, such as the power-supply cord or plug is damaged, liquid has been spilled or objects have fallen into the apparatus, the apparatus has been exposed to rain or moisture, does not operate normally, or has been dropped.

Follow these important safety guidelines when positioning and connecting your TV receiver:

- Do not block the slots and openings
- Do not place anything on top of the TV receiver
- Do not position the TV receiver in an enclosed space that would restrict airflow around the unit
- Do not position the TV receiver near any external heat source that could raise the temperature around the unit. Do not place the terminal on top of another heat-producing electronic device.
- Allow for adequate ventilation around the TV receiver to maintain normal operating temperature. Do not place it in a sealed enclosure without providing for adequate airflow.
- Do not plug the AC power cord into a switched power outlet.
- Do not vertically position the VIP1216 TV receiver containing a hard drive.

REGULATORY INFORMATION

Federal Communications Commission Radio and Television Interface Statement for a Class 'B' Device

This equipment has been tested and found to comply with the limits for a Class B digital device, pursuant to part 15 of the FCC Rules. These limits are designed to provide reasonable protection against harmful interference in the residential installation. This equipment generates, uses, and can radiate radio frequency energy and, if not installed and used in accordance with the instructions, may cause harmful interference to radio communications. However, there is no guarantee that interference will not occur in a particular installation.

If the equipment does cause harmful interference to radio or television reception, which can be determined by turning the equipment off and on, the user is encouraged to try to correct the interference by one of the following measures:

- Increase the separation between the equipment and the affected receiver
- Connect the equipment on a circuit different from the one the receiver is on
- Ensure that the cover plate for the security card is secured and tight

Changes or modification not expressly approved by the party responsible for compliance could void the user's authority to operate the equipment.

DECLARATION OF CONFORMITY

According to 47 CFR, Parts 2 and 15 for Class B Personal Computers and Peripherals; and/or CPU Boards and Power Supplies used with Class B Personal Computers, Motorola, Inc., 6450 Sequence Drive, San Diego, CA 92121, 1-800-225-9446, declares under sole responsibility that the product identifies with 47 CFR Part 2 and 15 of the FCC Rules as a Class B digital device. Each product marketed is identical to the representative unit tested and found to be compliant with the standards. Records maintained continue to reflect the equipment being produced can be expected to be within the variation accepted, due to quantity production and testing on a statistical basis as required by 47 CFR 2.909. Operation is subject to the following condition: This device must accept any interference received, including interference that may cause undesired operation. The above named party is responsible for ensuring that the equipment complies with the standards of 47 CFR, Paragraphs 15.101 to 15.109. The Class B digital apparatus meets all requirements of the Canadian Interface Causing Equipment Regulations.

CANADIAN COMPLIANCE

This Class B digital device complies with Canadian ICES-003. Cet appareil numérique de la classe B est conforme à la norme NMB-003 du Canada.

SOFTWARE LICENSE

IMPORTANT: PLEASE READ THIS SOFTWARE LICENSE (“LICENSE”) CAREFULLY BEFORE YOU USE ANY SOFTWARE, FIRMWARE, AND RELATED DOCUMENTATION (“SOFTWARE”) PROVIDED WITH MOTOROLA’S IP VIDEO RECEIVER OR HOME THEATER SYSTEM (EACH SHALL BE REFERRED TO IN THIS LICENSE AS A “RECEIVER”). BY USING THE RECEIVER AND/OR USING ANY OF THE SOFTWARE, YOU INDICATE YOUR ACCEPTANCE OF EACH OF THE TERMS OF THIS LICENSE. UPON ACCEPTANCE, THIS LICENSE WILL BE A LEGALLY-BINDING AGREEMENT BETWEEN YOU AND MOTOROLA. THE TERMS OF THIS LICENSE APPLY TO YOU AND TO ANY SUBSEQUENT USER OF THIS SOFTWARE.

IF YOU DO NOT AGREE TO ALL OF THE TERMS OF THIS LICENSE (I) DO NOT USE THE SOFTWARE AND (II) RETURN THE RECEIVER AND THE SOFTWARE (COLLECTIVELY, “PRODUCT”), INCLUDING ALL COMPONENTS, DOCUMENTATION, AND ANY OTHER MATERIALS PROVIDED WITH THE PRODUCT, TO YOUR POINT OF PURCHASE OR SERVICE PROVIDER, AS THE CASE MAY BE, FOR A FULL REFUND.

The Software includes associated media, any printed materials, and any “on-line” or electronic documentation. Software provided by third parties may be subject to separate end-user license agreements from the manufacturers of such Software. The Software is never sold. Motorola licenses the Software to the original customer and to any subsequent licensee for personal use only on the terms of this License. Motorola and its third party licensors retain the ownership of the Software.

You may:

USE the Software only in connection with the operation of the Product.

TRANSFER the Software (including all component parts and printed materials) permanently to another person, but only if the person agrees to accept all of the terms of this License. If you transfer the Software, you must at the same time transfer the Product and all copies of the Software (if applicable) to the same person or destroy any copies not transferred.

TERMINATE this License by destroying the original and all copies of the Software (if applicable) in whatever form.

You may not:

(1) Loan, distribute, rent, lease, give, sublicense, or otherwise transfer the Software, in whole or in part, to any other person, except as permitted under the TRANSFER paragraph above. (2) Copy or translate the User Guide included with the Software, other than for personal use. (3) Copy, alter, translate, decompile, disassemble, or reverse engineer the Software, including but not limited to modifying the Software to make it operate on non-compatible hardware. (4) Remove, alter, or cause not to be displayed any copyright notices or startup message contained in the Software programs or documentation. (5) Export the Software or the Product components in violation of any United States export laws.

The Product is not designed or intended for use in on-line control of aircraft, air traffic, aircraft navigation, or aircraft communications; or in design, construction, operation, or maintenance of any nuclear facility. MOTOROLA AND ITS THIRD PARTY LICENSORS DISCLAIM ANY EXPRESS OR IMPLIED WARRANTY OF FITNESS FOR SUCH USES. YOU REPRESENT AND WARRANT THAT YOU SHALL NOT USE THE PRODUCT FOR SUCH PURPOSES. Title to this Software, including the ownership of all copyrights, mask work rights, patents, trademarks, and all other intellectual property rights subsisting in the foregoing, and all adaptations to and modifications of the foregoing, shall at all times remain with Motorola and its third party licensors. Motorola retains all rights not expressly licensed under this License. The Software, including any images, graphics, photographs, animation, video, audio, music, and text incorporated therein is owned by Motorola or its third party licensors and is protected by United States copyright laws and international treaty provisions. Except as otherwise expressly provided in this License, the copying, reproduction, distribution, or preparation of derivative works of the Software, any portion of the Product, or the documentation is strictly prohibited by such laws and treaty provisions. Nothing in this License constitutes a waiver of Motorola's rights under United States copyright law.

This License and your rights regarding any matter it addresses are governed by the laws of the Commonwealth of Pennsylvania, without reference to conflict of laws principles. THIS LICENSE SHALL TERMINATE AUTOMATICALLY if you fail to comply with the terms of this License.

Motorola is not responsible for any third party software that is provided as a bundled application, or otherwise, with the Software or that is downloaded to, or otherwise installed on, the Product.

U.S. GOVERNMENT RESTRICTED RIGHTS

The Product and documentation is provided with RESTRICTED RIGHTS. The use, duplication or disclosure by the Government is subject to restrictions as set forth in subdivision (c)(1)(ii) of The Rights in Technical

Data and Computer Software clause at 52.227-7013. The contractor/manufacturer is Motorola, Inc., Connected Home Solutions, 101 Tournament Drive, Horsham, PA 19044.

CONTACT US

For questions about your TV service, call your service provider. To find out how to contact your service provider, refer to your *Feature Guide*.

For Motorola consumer products, education, and support:

http://broadband.motorola.com/consumers/home_entertainment.asp

For an overview of high-definition television (HDTV):

<http://broadband.motorola.com/consumers/hdtv>

COVERED UNDER ONE OR MORE U.S. PATENTS:

4577216, 4631603, 4790016, 4819098, 5109417, 5142656, 5216503, 5230038, 5345408, 5376968, 5497112, 5517250, 5530400, 5566089, 5579348, 5638128, 7034849, 7020879, 7017074, 7015928, 7002602, 6983370, 6917913, 6901420, 6895452, 6892304, 6879330, 6870538, 6853385, 6850252, 6836514, 6823353, 6822654, 6819330, 6810459, 6809734, 6807317, 6798420, 6792523, 6757820, 6757439, 6757343, 6751725, 6744472, 6738793, 6738072, 6734864, 6731295, 6721837, 6704358, 6700588, 6693643, 6667701, 6643798, 6573905, 6573846, 6570579, 6563511, 6556193, 6542160, 6538657, 6529935, 6529685, 6519287, 6516376, 6470370, 6466671, 6456746, 6449394, 6446037, 6442599, 6434583, 6424381, 6418529, 6278387, 6275834, 6272497, 6266686, 6243803, 6237016, 6222944, 6202130, 6189064, 6151362, 6148391, 6148387, 6133960, 6980596, 6829014, 6791622, 6563876, 6556250, 6438140, 6385248, 6385242, 6377713, 6262770, 6249547, 6167089, 6122321, 6100932, 6025878, 5949795, 5886736, 5844615, 5835730, 5809538, 5790177, 5703887, 6664826, 6300964, 6125147, 6122653, 6115072, 6108633, 6094636, 6067099, 6064450, 6058408, 5991865, 5970461, 5959659, 5953691, 5940072, 5935240, 5933160, 5926647, 5923385, 5909559, 5898601, 5892966, 5889949, 5886732, 5881279, 5812791, 5801785, 5801719, 5790842, 5774206, 5768429, 5754457, 5754456, 5751883, 5748046, 5715176, 5712665, 5677969, 5644355, 5623423, 5521918, 5253053, 4546387

© 2006 Motorola, Inc. All rights reserved. No part of this publication may be reproduced in any form or by any means or used to make any derivative work (such as translation, transformation, or adaptation) without written permission from Motorola, Inc.

MOTOROLA and the Stylized M logo are registered in the US Patent and Trademark Office. All other product or service names are the property of their respective owners.

Motorola reserves the right to revise this publication and to make changes in content from time to time without obligation on the part of Motorola to provide notification of such revision or change. Motorola provides this guide without warranty of any kind, implied or expressed, including, but not limited to, the implied warranties of merchantability and fitness for a particular purpose. Motorola may make improvements or changes in the product(s) described in this manual at any time.



CONTENTS

1 Introduction.....	1
Your Set-top Boxes.....	1
Front Panel.....	2
Rear Panel.....	3
Video Connection Options.....	4
Audio Connection Options.....	5
2 Connecting Your Set-top Box.....	7
Connecting to an HDTV — Video Only.....	8
Connecting to an HDTV — Audio Only.....	9
Connecting to a Home Theater Receiver — Audio Only.....	10
Connecting to a Stereo TV.....	11
Connecting to a Stereo TV and Stereo VCR.....	12
Connecting to a Home Theater Receiver, TV, and VCR.....	13
3 Troubleshooting.....	15



1 INTRODUCTION

Your set-top box has outputs for multiple audio and video devices; this Installation Manual will help provide the optimal connections to your television and home theater equipment.

Your Set-top Boxes

Every set-top box features high-definition TV (HDTV), which provides up to twice the color resolution and up to six times the sharpness of standard TV when connected to an HD-capable TV.

Your main TV's set-top box contains a Digital Video Recorder (DVR). The DVR can record standard-definition and high-definition programs on a hard drive. It also enables you to pause and rewind live programming. DVR functionality may be limited on some channels.

Other TVs in your home may be connected to another DVR or standard high-definition set-top box, or both.

Set-top boxes with hard drives are physically larger than those without hard drives.

1 INTRODUCTION

Front Panel

Set-top boxes with hard drives and those without hard drives have identical front-panel controls and lights; only the size varies.

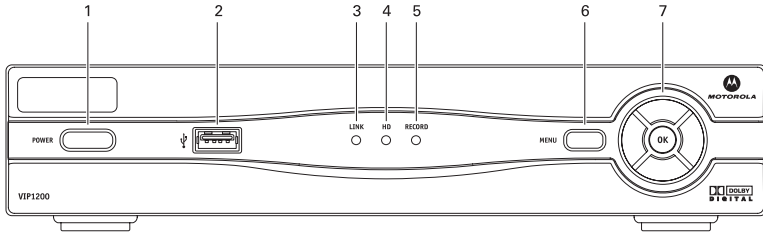

Key	Item	Function
1	POWER	If held for less than five seconds, turns the set-top box on or off If held for five seconds or longer, restarts the set-top box Lights green when the set-top box is on
2	USB	USB 2.0 connector
3	LINK	Lights green when receiving a stream
4	HD	Lights blue when receiving a high-definition program
5	RECORD	Lights red when you are recording a program with the PVR
6	MENU	Displays the on-screen menu
7	Up and down arrow keys	Changes the channel up and down
	Left and right arrow keys	Moves through the on-screen program guide and menu
	OK	Selects channels or menu options

1 INTRODUCTION

Rear Panel

Set-top boxes with hard drives and those without hard drives have identical rear-panel connectors; only the size varies.

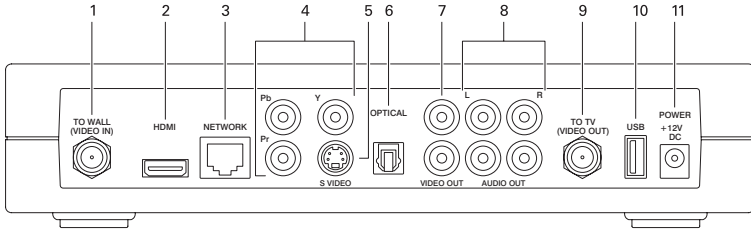

Key	Item	Function
1	TO WALL (VIDEO IN)	Coaxial input for home video network (HPNA)
2	HDMI	Connects to a high-definition TV or home theater receiver with an HDMI input (for a DVI input, use an HDMI-to-DVI adapter)
3	NETWORK	Ethernet 10/100Base-T RJ-45 port
4	Y PB PR	RCA-type component video outputs to an HDTV
5	S-VIDEO	High quality video output to a VCR or TV that accepts S-Video. It carries video <i>only</i> ; you must also connect to the TV or home theater receiver for audio.
6	OPTICAL	S/PDIF audio output to a digital home theater receiver
7	VIDEO OUT	RCA-type video outputs to a TV, VCR, DVD recorder, or other device
8	AUDIO OUT L AND R	Left and right RCA-type stereo audio outputs
9	TO TV (VIDEO OUT)	Coaxial output to a TV or VCR
10	USB	USB 2.0 connector
11	POWER +12V DC	Connector for the DC power adapter

1 INTRODUCTION

Video Connection Options

The set-top boxes offer the following video outputs:

HDTV HDMI or Y Pb Pr (component video)

Standard TV S-Video, RCA-type, or RF coaxial



To determine the available inputs on your TV, check the manual supplied with the TV or on the TV itself. When you are familiar with the available inputs on your TV, choose the optimal video connection based on the following guidelines.

If you are connecting to an HDTV, use *one* of:

Best	HDMI	Video and audio	<p>HDMI offers higher quality than component video. If your HDTV has an HDMI input, use the HDMI connector. HDMI carries video and audio. If you connect your HDTV using HDMI, no additional audio connections to the TV are necessary.</p> <p>If your HDTV has a DVI input, you can use an HDMI-to-DVI converter cable to connect to the set-top box HDMI connector. Use a cable with an HDMI connector on one end and a DVI connector on the other end. We do not recommend using an HDMI-to-DVI or DVI-to-HDMI adapter. Because DVI does not carry audio, a separate audio connection is required for a DVI TV.</p>
Good	Y Pb Pr	Video <i>only</i>	<p>The Y Pb Pr connectors provide component video, the most widely supported HDTV connection. If your HDTV only has Y Pb Pr inputs, use these connectors.</p>



1 INTRODUCTION

If you are connecting to a standard TV, use *one* of:

Best	S-Video 	Video <i>only</i>	This is the highest quality standard video output. If your standard TV has an S-Video input, connect it to the S-VIDEO output on your set-top box using the provided S-Video cable.
Very Good	RCA-type 	Video <i>only</i>	If your standard TV does not have an S-Video input, connect it to the VIDEO OUT connector on your set-top box using the provided RCA-type video cable.
Good	RF coaxial 	Video and audio	If your TV only has a coaxial RF input, use the coaxial TO TV (VIDEO OUT) connector.

Audio Connection Options

To connect your TV or home theater receiver for audio, depending on its capabilities, you can use *one* of the following audio outputs:

Best	OPTICAL 	If possible with your TV or home theater receiver, use the OPTICAL output to deliver S/PDIF Dolby® audio. In most cases, it offers better quality, including support for Dolby Digital 5.1 surround sound.
Good	AUDIO L and R 	If your TV or home theater receiver has no S/PDIF input, use the RCA-type AUDIO outputs to your TV or home theater receiver.



2 CONNECTING YOUR SET-TOP BOX

The following pages contain configuration diagrams designed to help you connect your set-top box. Identify the diagram that most closely matches your set up. After making the indicated connections, you will soon be enjoying the latest in home entertainment with IPTV.

Before you move or change components, disconnect the power cord from your set-top box and other components.

2 CONNECTING YOUR SET-TOP BOX

Connecting to an HDTV — Video Only

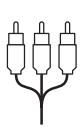

Y Pb Pr



HDMI

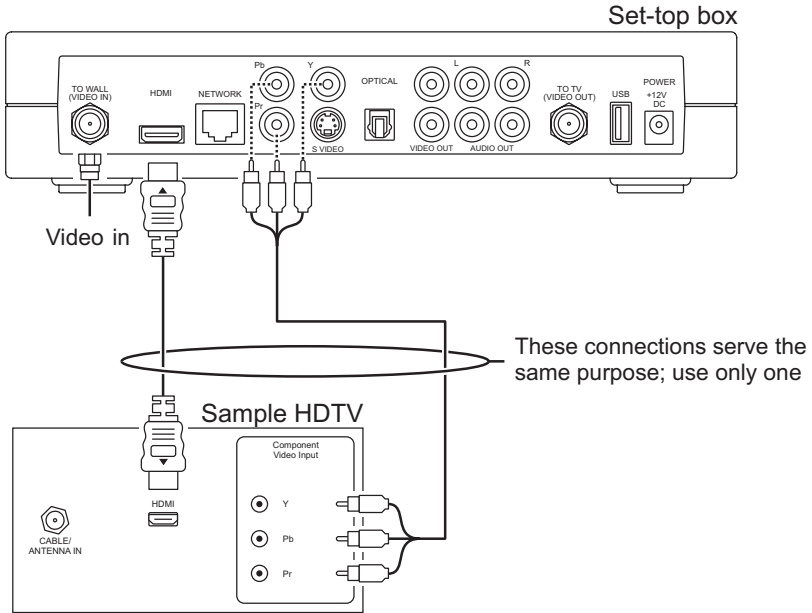

To determine your best connection, refer to “Video Connection Options.”

If you are connecting to a DVI or Y Pb Pr input on your TV, a separate audio connection is required. Refer to the next page.

If you are connecting to a home theater receiver, refer to “Connecting to a Home Theater Receiver — Audio Only.”

2 CONNECTING YOUR SET-TOP BOX

Connecting to an HDTV — Audio Only



RCA-type audio



Optical S/PDIF

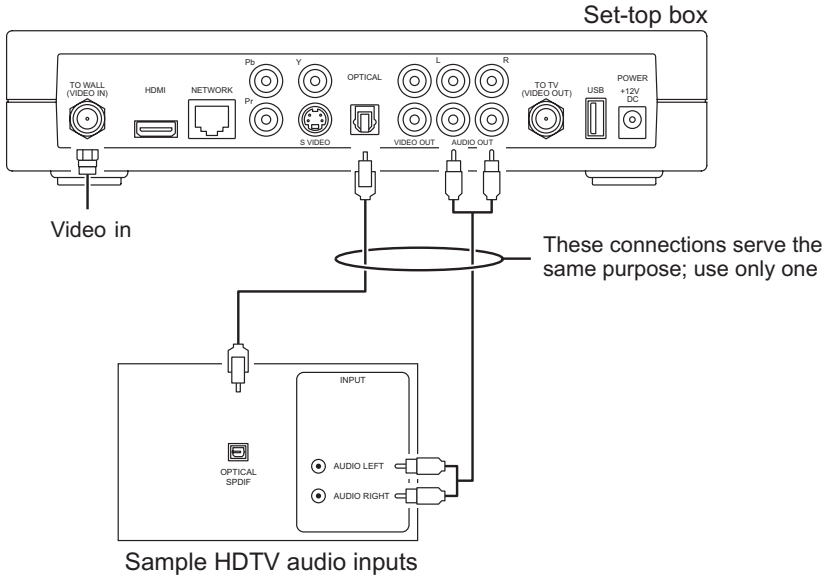

To determine your best connection, refer to “Audio Connection Options.”

2 CONNECTING YOUR SET-TOP BOX

Connecting to a Home Theater Receiver — Audio Only



RCA-type audio



Optical S/PDIF

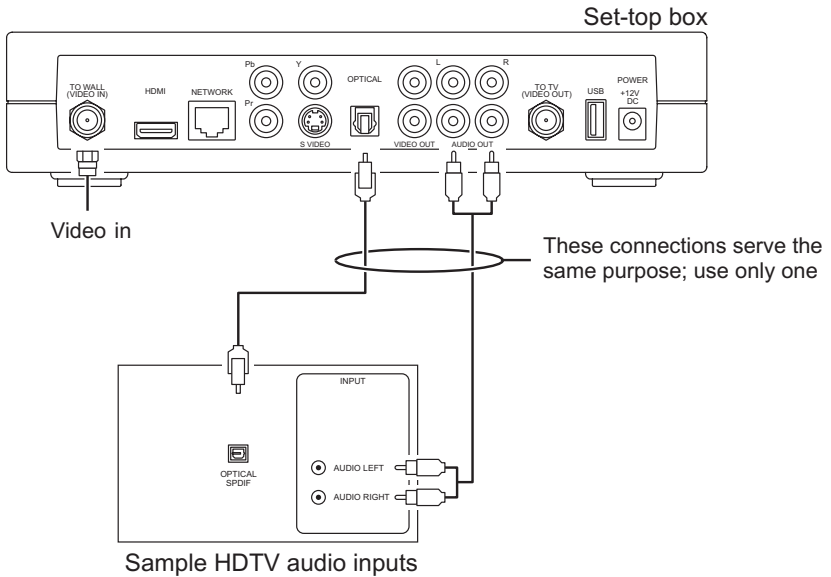

To determine your best connection, refer to “Audio Connection Options.”

2 CONNECTING YOUR SET-TOP BOX

Connecting to a Stereo TV

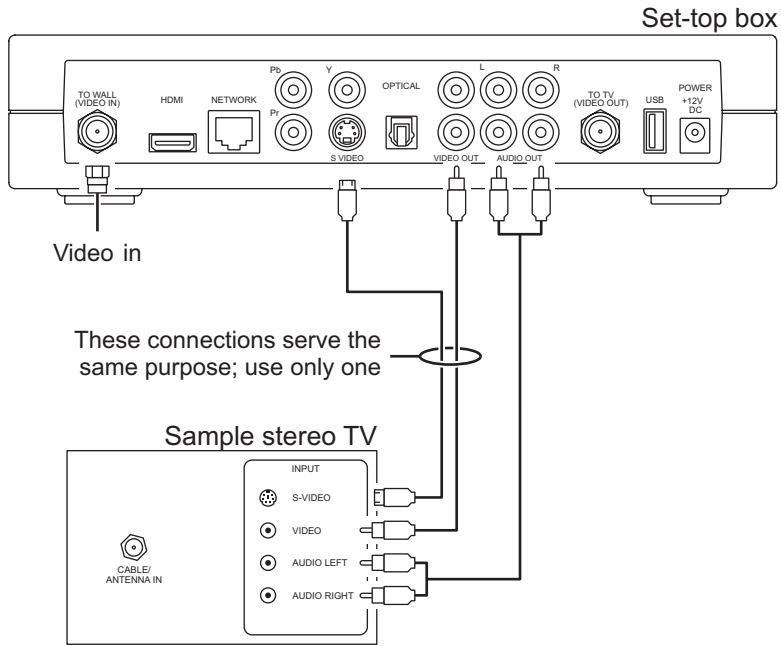
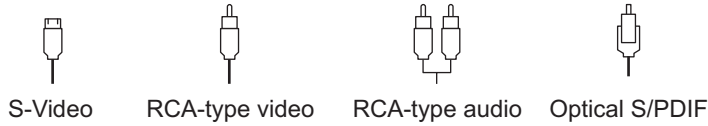

To determine your best connection, refer to “Video Connection Options.”

This video connection method does not support HD video. For more information, see “Connecting an HDTV — Video Only.”

2 CONNECTING YOUR SET-TOP BOX

Connecting to a Stereo TV and Stereo VCR

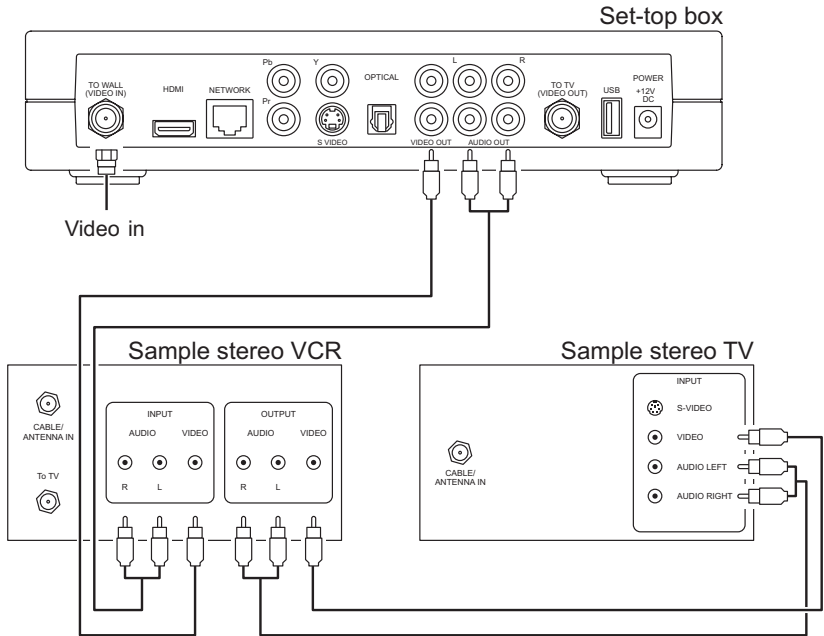
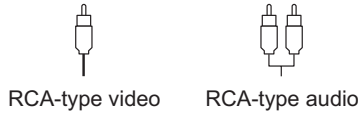

To determine your best connection, refer to “Video Connection Options.”

This video connection method does not support HD video. For more information, see “Connecting to an HDTV — Video Only.”

2 CONNECTING YOUR SET-TOP BOX

Connecting to a Home Theater Receiver, TV, and VCR

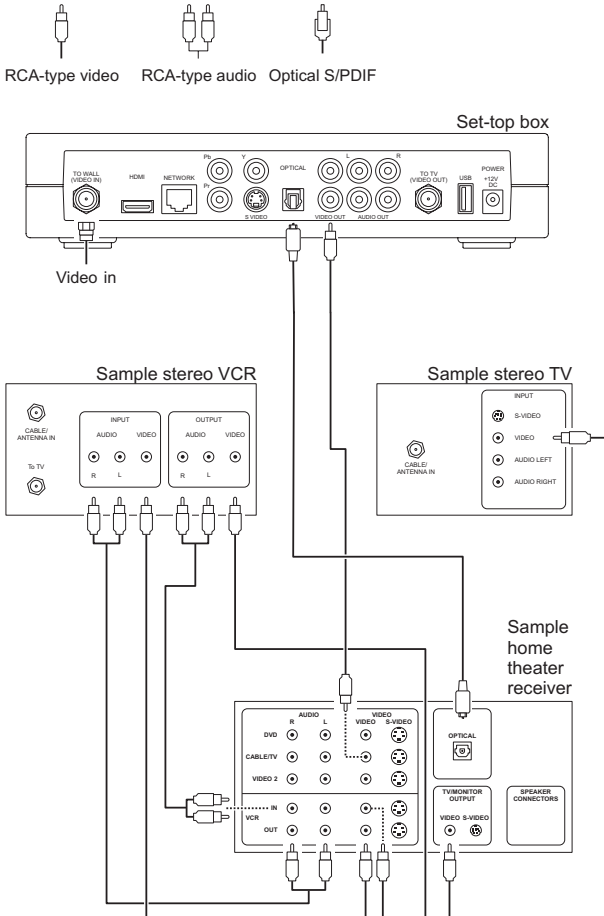

To determine your best connection, refer to “Video Connection Options.” This video connection method does not support HD video. For information, see “Connecting to an HDTV — Video Only.”



3 TROUBLESHOOTING

Before calling Tech Support, review this troubleshooting guide. If the suggestions do not help you quickly solve a problem, contact your TV service provider for further assistance.

Problem	Possible Solutions
The set-top box will not power on.	<p>Verify that the AC power cord is connected to the set-top box and an AC outlet. Unplug the set-top box from the outlet, plug it back in, and press the POWER button.</p> <p>If the set-top box is connected to a switched outlet on another device, such as a VCR or home theater receiver, verify that that unit is powered on. Unplug the set-top box from the AC outlet, plug it back in, and press the POWER button.</p> <p>Press the POWER button on the set-top box front panel instead of the remote control. The batteries in the remote control may be depleted.</p>
The remote control does not work.	<p>Verify that the TV is on.</p> <p>Verify that there are no obstructions between the remote control and the set-top box. Aim the remote control directly at the set-top box front panel, not the TV or VCR.</p> <p>The angle between the remote control and the set-top box may be too large. Stand in front of the set-top box and not too far to either side.</p> <p>Press and release operation keys one at a time, firmly and deliberately.</p> <p>Try changing the channels using the up and down arrow keys on the set-top box front panel. The light on the remote control should go on while you change the channel.</p> <p>Check the batteries in the remote control. Install new batteries if needed.</p>

3 TROUBLESHOOTING

<p>There is no audio when viewing TV channels.</p>	<p>Verify that the Mute button on the remote control has not been pressed. Press Mute on the remote control to restore sound.</p> <p>Verify that the set-top box audio output is connected to the TV or home theater receiver.</p> <p>If the set-top box audio output is connected to the TV, verify that the Mute button on the TV has not been pressed.</p> <p>If the set-top box audio output is connected to a home theater receiver, verify that the home theater receiver is set to the appropriate input source and its Mute button has not been pressed.</p> <p>Verify that you have the correct cables for the audio ports.</p> <p>Verify that the audio cables are firmly connected between the set-top box and the audio playback device (TV, home theater receiver, etc.).</p>
<p>There is no audio from the center and/or surround speakers of a home theater receiver connected to the set-top box.</p>	<p>Not all Dolby Digital programs feature full 5.1 Surround Sound. In some cases, the programs may only contain left and right stereo audio.</p> <p>Verify that the S/PDIF cable is firmly connected to the set-top box and the home theater receiver.</p> <p>Verify that the home theater receiver is set to a surround sound audio mode (Dolby Digital, Dolby Pro Logic® II, Dolby Pro Logic).</p> <p>Verify that the home theater receiver is properly configured to work with all connected speakers.</p>
<p>The set-top box is making a humming noise.</p>	<p>The set-top box includes an integrated hard drive and a fan for cooling. During normal operation, it emits a low humming noise, similar to a personal computer. The noise varies in volume occasionally when the speed of the internal fan adjusts to changes in the temperature around the set-top box. Please note the hard drive will stay on even when the set-top box is turned off.</p>



MOTOROLA

Motorola, Inc.
101 Tournament Drive
Horsham, PA 19044 U.S.A.

<http://www.motorola.com>

534978-001-b
11/06

Free Manuals Download Website

<http://myh66.com>

<http://usermanuals.us>

<http://www.somanuals.com>

<http://www.4manuals.cc>

<http://www.manual-lib.com>

<http://www.404manual.com>

<http://www.luxmanual.com>

<http://aubethermostatmanual.com>

Golf course search by state

<http://golfingnear.com>

Email search by domain

<http://emailbydomain.com>

Auto manuals search

<http://auto.somanuals.com>

TV manuals search

<http://tv.somanuals.com>