

Symbol LS7708

Product Reference Guide

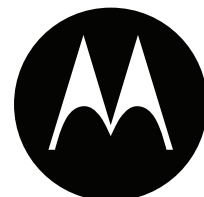

Symbol LS7708
Product Reference Guide

72E-69531-02

Revision A

February 2007



© Motorola, Inc. 2007. All rights reserved.

No part of this publication may be reproduced or used in any form, or by any electrical or mechanical means, without permission in writing from Motorola. This includes electronic or mechanical means, such as photocopying, recording, or information storage and retrieval systems. The material in this manual is subject to change without notice.

The software is provided strictly on an "as is" basis. All software, including firmware, furnished to the user is on a licensed basis. Motorola grants to the user a non-transferable and non-exclusive license to use each software or firmware program delivered hereunder (licensed program). Except as noted below, such license may not be assigned, sublicensed, or otherwise transferred by the user without prior written consent of Motorola. No right to copy a licensed program in whole or in part is granted, except as permitted under copyright law. The user shall not modify, merge, or incorporate any form or portion of a licensed program with other program material, create a derivative work from a licensed program, or use a licensed program in a network without written permission from Motorola. The user agrees to maintain Motorola's copyright notice on the licensed programs delivered hereunder, and to include the same on any authorized copies it makes, in whole or in part. The user agrees not to decompile, disassemble, decode, or reverse engineer any licensed program delivered to the user or any portion thereof.

Motorola reserves the right to make changes to any software or product to improve reliability, function, or design.

Motorola does not assume any product liability arising out of, or in connection with, the application or use of any product, circuit, or application described herein.

No license is granted, either expressly or by implication, estoppel, or otherwise under any Motorola intellectual property rights. An implied license only exists for equipment, circuits, and subsystems contained in Motorola products.

MOTOROLA and the Stylized M Logo are registered in the US Patent & Trademark Office. Symbol is a registered trademark of Symbol Technologies, Inc. All other product or service names are the property of their respective owners.

Motorola
One Symbol Plaza
Holtsville, New York 11742-1300
<http://www.symbol.com>

Revision History

Changes to the original manual are listed below:

Change	Date	Description
72E-69531-01	9/2004	Initial release.
72E-69413-02	2/2007	Update service information, add parameter bar codes for Bookland ISBN, new UPC supplemental decode options, report software version, report MIMIC version, report Synapse cable

Contents

About This Guide

Introduction	xv
Chapter Descriptions	xv
Notational Conventions	xvi
Related Publications	xvi
Service Information	xvi

Chapter 1. Getting Started

Introduction	1-3
Unpacking the Scanner	1-4
Input/Output Ports	1-5
Setting Up the Scanner	1-6
Power Options	1-6
Connecting the Host and Peripheral Cables	1-6
Routing Cables	1-8
Removing the Host Interface Cable	1-8
Configuring the Scanner	1-9
Synchronization of Settings	1-9
Mounting the Scanner to a Surface	1-10
Attaching the Mounting Bracket	1-10
Detaching the Scanner from the Mounting Bracket	1-13

Chapter 2. Scanning

Introduction	2-3
--------------------	-----

Active Scan Area	2-3
Scanning Bar Codes	2-3
Beeper Definitions	2-5
Selecting Beeper Volume	2-6
Sleep Mode	2-6
LED Definitions	2-6
Decode Zone	2-7
Integrated Electronic Article Surveillance (EAS)	2-8
LS7708 Interlock Cable and EAS	2-8
Installing the Electronic Article Surveillance (EAS)	2-8
CheckPoint EAS Model Compatibility	2-8
Considerations	2-8
CheckPoint Contact Information	2-8
Deactivation for Sensormatic EAS System	2-8

Chapter 3. Maintenance and Technical Specifications

Introduction	3-3
Maintenance	3-3
Replacing the Scanner Window	3-4
Troubleshooting	3-6
Technical Specifications	3-7
Scanner Signal Descriptions	3-9

Chapter 4. User Preferences

Introduction	4-3
Scanning Sequence Examples	4-3
Errors While Scanning	4-3
User Preferences Default Parameters	4-3
User Preferences	4-5
Set Default Parameter	4-5
Beeper Tone	4-5
Beeper Volume	4-7
Beep After Good Decode	4-9
Low Power Mode	4-10
Scan Pattern Mode	4-11
Timeout Between Decodes	4-12
Time Delay to Low Power Mode	4-13
Linear UPC/EAN Decode	4-15
UPC Half Block Stitching	4-16
EAS Interlock	4-17

Chapter 5. Keyboard Wedge Interface

Introduction	5-3
Connecting a Keyboard Wedge Interface	5-4
Keyboard Wedge Default Parameters	5-6
Keyboard Wedge Host Types	5-7
Keyboard Wedge Country Types (Country Codes)	5-9

Ignore Unknown Characters	5-14
Keystroke Delay	5-15
Intra-Keystroke Delay	5-17
Alternate Numeric Keypad Emulation	5-18
Caps Lock On	5-19
Caps Lock Override	5-20
Convert Wedge Data	5-21
Function Key Mapping	5-23
FN1 Substitution	5-24
Send Make Break	5-25
OnKeyboard Maps	5-26
ASCII Character Set	5-28

Chapter 6. RS-232 Host Interface

Introduction	6-3
Connecting an RS-232 Interface	6-4
RS-232 Default Parameters	6-6
RS-232 Host Parameters	6-7
RS-232 Host Types	6-9
Baud Rate	6-13
Parity	6-17
Check Receive Errors	6-20
Hardware Handshaking	6-21
Software Handshaking	6-24
Host Serial Response Time-out	6-26
RTS Line State	6-29
Stop Bit Select	6-30
Data Bits	6-31
Beep on <BEL>	6-32
Intercharacter Delay	6-33
Nixdorf Beep/LED Options	6-35
Ignore Unknown Characters	6-37
ASCII / Character Set	6-38

Chapter 7. USB Interface

Introduction	7-3
Connecting a USB Interface	7-3
USB Default Parameters	7-6
USB Host Parameters	7-7
USB Device Type	7-7
USB Country Keyboard Types (Country Codes)	7-9
USB Keystroke Delay	7-14
USB CAPS Lock Override	7-16
USB Ignore Unknown Characters	7-17
Emulate Keypad	7-18
USB Keyboard FN1 Substitution	7-19
Function Key Mapping	7-20
Simulated Caps Lock	7-21

Convert Case	7-22
ASCII Character Set	7-24

Chapter 8. IBM 468X/469X Interface

Introduction	8-3
Connecting to an IBM 468X/469X Host	8-4
IBM Default Parameters	8-5
IBM 468X/469X Host Parameters	8-6
Port Address	8-6
Convert Unknown to Code 39	8-8

Chapter 9. Synapse Interface

Introduction	9-3
Connecting a Synapse Interface Cable	9-5
Synapse Interface	9-6
“Plug and Play” Synapse Connection	9-6

Chapter 10. RS-232 Auxiliary Port

Introduction	10-3
Connecting a Device to the RS-232 Auxiliary Port	10-4
RS-232 Auxiliary Port Default Parameters	10-5
RS-232 Auxiliary Port Parameters	10-6
Baud Rate	10-6
Parity	10-9
Check Receive Errors	10-11
Check Receive Errors (continued)	10-12
Hardware Handshaking	10-12
Standard RTS/CTS	10-13
Software Handshaking	10-15
Serial Response Time-out	10-17
RTS Line State	10-20
Stop Bit Select	10-21
Data Bits	10-22

Chapter 11. Hand-Held Laser Scanner Port

Introduction	11-3
Connecting a Hand-Held Scanner	11-3
Hand-Held Laser Scanner Default Parameters	11-4
Hand-Held Laser Scanner Options	11-5
Programming Mode	11-5
Beep After Good Decode	11-7

Chapter 12. 123Scan

Introduction	12-3
Setting Up the 123Scan PC-Based Configuration Tool	12-3
123Scan Parameter	12-3

Chapter 13. Symbologies

Introduction	13-3
Scanning Sequence Examples	13-3
Errors While Scanning	13-3
Symbology Default Parameters	13-3
UPC/EAN	13-7
Enable/Disable UPC-A/UPC-E	13-7
Enable/Disable UPC-E1	13-9
Enable/Disable EAN-13/JAN-13/EAN-8/JAN-8	13-10
Enable/Disable Bookland EAN	13-12
Decode UPC/EAN Supplementals	13-13
UPC/EAN Supplemental Redundancy	13-22
Transmit UPC-A/UPC-E/UPC-E1 Check Digit	13-23
UPC-A Preamble	13-26
UPC-E Preamble	13-27
UPC-E1 Preamble	13-29
Convert UPC-E to UPC-A	13-31
Convert UPC-E1 to UPC-A	13-32
EAN Zero Extend	13-33
Bookland ISBN Format	13-34
UCC Coupon Extended Code	13-35
Code 128	13-36
Enable/Disable Code 128	13-36
Enable/Disable UCC/EAN-128	13-37
Enable/Disable ISBT 128	13-38
Code 128 Decode Performance	13-39
Code 128 Decode Performance Level	13-40
Code 39	13-42
Enable/Disable Code 39	13-42
Enable/Disable Trioptic Code 39	13-43
Convert Code 39 to Code 32	13-44
Code 32 Prefix	13-45
Set Lengths for Code 39	13-46
Code 39 Check Digit Verification	13-48
Transmit Code 39 Check Digit	13-49
Enable/Disable Code 39 Full ASCII	13-50
Code 39 Buffering (Scan & Store)	13-51
Code 39 Decode Performance	13-55
Code 39 Decode Performance Level	13-56
Code 93	13-58
Enable/Disable Code 93	13-58
Set Lengths for Code 93	13-59
Code 11	13-61
Enable/Disable Code 11	13-61
Set Lengths for Code 11	13-62
Code 11 Check Digit Verification	13-64
Transmit Code 11 Check Digits	13-66
Interleaved 2 of 5 (ITF)	13-67

Enable/Disable Interleaved 2 of 5	13-67
Set Lengths for Interleaved 2 of 5	13-68
1 2 of 5 Check Digit Verification	13-70
Transmit 1 2 of 5 Check Digit	13-72
Convert 1 2 of 5 to EAN-13	13-73
Discrete 2 of 5 (DTF)	13-74
Enable/Disable Discrete 2 of 5	13-74
Set Lengths for Discrete 2 of 5	13-75
Codabar (NW - 7)	13-78
Enable/Disable Codabar	13-78
Set Lengths for Codabar	13-79
CLSI Editing	13-82
NOTIS Editing	13-83
RSS (Reduced Space Symbology)	13-84
RSS 14	13-84
RSS Limited	13-85
RSS Expanded	13-86
Convert RSS to UPC/EAN	13-87
Symbology - Specific Security Levels	13-88
Redundancy Level	13-88
Security Level	13-91
Bi-directional Redundancy	13-93
Symbology - Intercharacter Gap	13-94

Chapter 14. Miscellaneous Scanner Options

Introduction	14-3
Scanning Sequence Examples	14-3
Errors While Scanning	14-3
Miscellaneous Default Parameters	14-3
Miscellaneous Scanner Parameters	14-4
Transmit Code ID Character	14-4
Prefix/Suffix Values	14-5
FN1 Substitution Values	14-6
Scan Data Options	14-7
Report Version	14-11
Report MIMIC Version	14-11
Report Synapse Cable	14-12

Appendix A. Standard Default Parameters

Appendix B. Programming Reference

Symbol Code Identifiers	B-3
AIM Code Identifiers	B-4

Appendix C. Sample Bar Codes

Code 39	C-3
---------------	-----

UPC/EAN.....	C-3
UPC-A, 100 %.....	C-3
EAN-13, 100 %.....	C-4
Code 128.....	C-4
Interleaved 2 of 5.....	C-5
RSS 14.....	C-5

Appendix D. Numeric Bar Codes

0.....	D-3
1.....	D-3
2.....	D-4
3.....	D-4
4.....	D-5
5.....	D-5
6.....	D-6
7.....	D-6
8.....	D-7
9.....	D-7
Cancel.....	D-8

Appendix E. Mounting Template

Mounting Template.....	E-3
------------------------	-----

Glossary

Index

Tell Us What You Think...

About This Guide

Introduction	xv
Chapter Descriptions	xv
Notational Conventions	xvi
Related Publications	xvi
Service Information	xvi

Introduction

The *Symbol LS7708 Product Reference Guide* provides general instructions for setting up, operating, maintaining, and troubleshooting the Symbol LS7708 scanner.

Chapter Descriptions

- *Chapter 1, Getting Started* provides a product overview and unpacking instructions.
- *Chapter 2, Scanning* describes parts of the scanner, beeper and LED definitions, and how to use the scanner in hand-held and hands-free modes.
- *Chapter 3, Maintenance and Technical Specifications* provides information on how to care for the scanner, troubleshooting, and technical specifications.
- *Chapter 4, User Preferences* provides the programming bar codes necessary for selecting user preference features for the scanner.
- *Chapter 5, Keyboard Wedge Interface* provides information for setting up the scanner for Keyboard Wedge operation.
- *Chapter 6, RS-232 Host Interface* provides information for setting up the scanner for RS-232 operation.
- *Chapter 7, USB Interface* provides information for setting up the scanner for USB operation.
- *Chapter 8, IBM 468X/469X Interface* provides information for setting up the scanner with IBM 468X/469X POS systems.
- *Chapter 9, Synapse Interface* provides information for expanding the primary scanner's capabilities by connecting a (secondary) hand-held scanner using a Synapse adapter at the host port.
- *Chapter 10, RS-232 Auxiliary Port* provides information for setting up the auxiliary device and optional hand-held laser scanner.
- *Chapter 11, Hand-Held Laser Scanner Port* provides information for expanding the primary scanner's capabilities by connecting a (secondary) hand-held scanner at the scanner port.
- *Chapter 12, 123Scan* describes this PC based scanner configuration tool and provides the bar code that enables communication with the 123Scan program.
- *Chapter 13, Symbologies* describes all symbology features and provides the programming bar codes necessary for selecting these features for the scanner.
- *Chapter 14, Miscellaneous Scanner Options* includes commonly used bar codes to customize how data is transmitted to the host device.
- *Appendix A, Standard Default Parameters* provides a table of all host devices and miscellaneous scanner defaults.
- *Appendix B, Programming Reference* provides a table of AIM code identifiers, ASCII character conversions, and keyboard maps.
- *Appendix C, Sample Bar Codes* includes sample bar codes.
- *Appendix D, Numeric Bar Codes* includes the numeric bar codes to scan for parameters requiring specific numeric values.
- *Appendix E, Mounting Template* includes a mounting template to assist in proper placement of the scanner when attaching it to a surface.

Notational Conventions

The following conventions are used in this document:

- Bullets (•) indicate:
 - action items
 - lists of alternatives
 - lists of required steps that are not necessarily sequential
- Sequential lists (e.g., those that describe step-by-step procedures) appear as numbered lists.
- Throughout the programming bar code menus, asterisks (*) are used to denote default parameter settings.

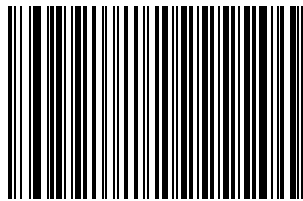

* Indicates Default ***Baud Rate 9600** Feature/Option

Related Publications

The *LS7708 Quick Reference Guide*, p/n 72-60830-01, provides general information to help the user get started with the scanner. It includes basic set-up and operation instructions.

For the latest versions of the *LS7708 Quick Reference Guide*, *Product Reference Guide*, and *Advanced Data Formatting Guide*, go to: <http://www.symbol.com/manuals>.

Service Information

If there is a problem with the equipment, contact the regional Global Customer Interaction Center. For contact number information, visit: www.symbol.com/contactsupport for a Customer Interaction Center in your area. Before calling, have the model number, serial number and several bar code symbols at hand.

Call the Global Customer Interaction Center from a phone near the scanning equipment so that the service person can try to troubleshoot the problem. If the equipment is found to be working properly and the problem is reading bar codes, the Support Center will request samples of the bar codes for analysis at our plant.

If the problem cannot be solved over the phone, it may be necessary to return the equipment for servicing. If that is necessary, the Global Customer Interaction Center will provide specific directions.



Motorola is not responsible for any damages incurred during shipment if the approved shipping container is not used. Shipping the units improperly can possibly void the warranty. If the original shipping container was not kept, contact Motorola to have another sent.

If the product was purchased from a Motorola Business Partner, contact that Business Partner for service.

1

Getting Started

Introduction	1-3
Unpacking the Scanner	1-4
Input/Output Ports	1-5
Setting Up the Scanner	1-6
Power Options	1-6
Connecting the Host and Peripheral Cables	1-6
Routing Cables	1-8
Removing the Host Interface Cable	1-8
Configuring the Scanner	1-9
Synchronization of Settings	1-9
Mounting the Scanner to a Surface	1-10
Attaching the Mounting Bracket	1-10
Detaching the Scanner from the Mounting Bracket	1-13

Introduction

The Symbol LS7708 scanner provides multiple scan patterns that support high throughput applications at the point of sale (POS). The rastering, 120-line, omni-directional scan pattern provides fast, intuitive, hands-free scanning. The scanner reads all retail symbologies and has multi-interface capability to interface to all popular POS devices. The scanner mounts on a counter top or vertical surface such as a wall.

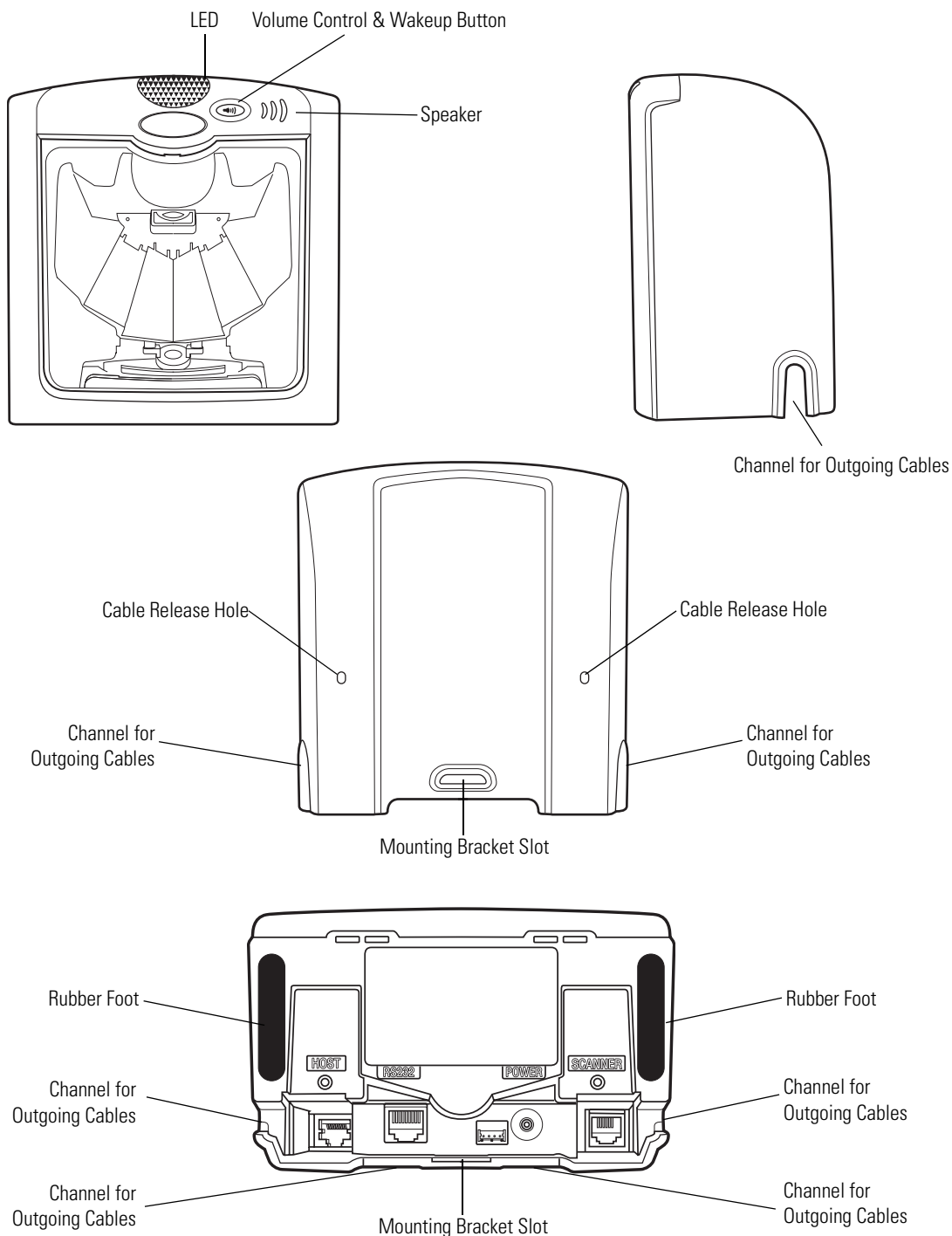

Figure 1-1. Symbol LS7708 Scanner Views

The Symbol LS7708 scanner supports the following interfaces:

- TTL-level RS-232 connection to a host. Set up communication between the scanner and the host either by scanning bar code menus or using the Windows-based programming tool 123Scan.
- Keyboard Wedge connection to a host. The host interprets scanned data as keystrokes.
International keyboards supported:
 - Windows™ environment: North American, German, French, Spanish, Italian, Swedish, UK English, Brazilian/Portuguese, and Japanese.
 - Windows XP/2000™ environment: French Canadian
 - Windows 95/98 environment: French Canadian
- Connection to IBM 468X/469X hosts. Set up communication between the scanner and the IBM terminal either by scanning bar code menus or using the Windows-based programming tool 123Scan.
- USB connection to a host. The scanner autodetects a USB host and defaults to the HID keyboard interface type. To select other USB interface types, scan programming bar code menus or use the Windows-based programming tool 123Scan.
 - International Keyboards supported (for Windows™ environment): North America, German, French, French International, Spanish, Italian, Swedish, British, and Japanese.
- Synapse capability that allows the scanner to connect to a wide variety of host systems using a Synapse and Synapse adapter cable. The scanner autodetects Synapse.

Unpacking the Scanner

Remove the scanner from its packing and inspect it for damage. The following items are included in the package:

- Scanner
- Mounting bracket and hardware
- *LS7708 Quick Reference Guide* (p/n 72-69530-xx)
- CD containing 123Scan software and *Symbol LS7708 Product Reference Guide* (p/n 72-69531-xx).

The package may also include the following:

- Power supply and cable
- RS-232C host interface cable
- Synapse Adapter and Synapse cable.

Some host terminals (e.g., IBM 46xx Series) supply power to the scanner, so an external power supply is not required. Contact a Motorola representative for more information.

If any items are missing or damaged, call the Global Customer Interaction Center. See [page xvi](#) for contact information. **KEEP THE PACKING.** It is the approved shipping container and should be used if it is ever necessary to return the equipment for servicing.

Input/Output Ports

The bottom of the scanner includes the ports in [Figure 1-2](#)

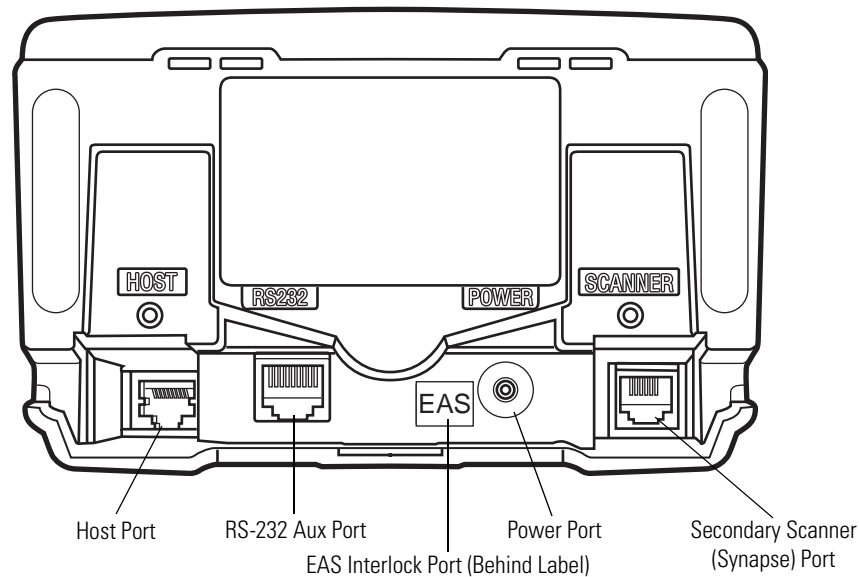

Figure 1-2. Scanner Ports

Power Port. When external power is required, the input to this port is 5V @ 500 mA maximum, 390 mA nominal, with no peripherals, 5V @ 1.5A maximum with peripherals.

Host Port. A 10-pin modular connector. Plug the host cable, the Synapse Adapter cable, or Synapse Power Regulator cable into this port.

Secondary (Hand-Held) Scanner Port. A 6-pin modular connector. Plug a Synapse-compatible hand-held laser scanner, such as the Symbol LS2208, into this port. This scanner can program the Symbol LS7708, and adapts to LS7708 decode parameters (i.e., code types, lengths, and check digits).

RS-232 Aux Port. A 10-pin modular connector. Use this as an auxiliary port to connect serial devices such as a scale or magstripe reader. Current draw on this port should not exceed 200 mA. The total current draw on the hand-held port and scanner port should not exceed 700 mA.



For detailed connection information, see the applicable host chapter.

Setting Up the Scanner

Power Options

Depending on the peripherals used, the scanner receives power from one of two sources:

- Via the host through the host cable: If the host can supply 500mA of power, the host cable is less than 8.5' long, and there are no peripheral devices in the configuration.
- Via an external power supply: When the host cannot provide sufficient power, the host cable length is more than 8.5' long, or a peripheral device is connected to the hand-held and/or scanner ports. The external supply connects directly into the DC port or through a host cable with an adapter or Y-connection.

When the scanner receives power, the green LED lights and three short high beeps sound, indicating that the scanner is operational.

Connecting the Host and Peripheral Cables

Connect the cables in the following order (see [Figure 1-3](#)):



The order of cable insertion is extremely important. Be sure to follow the steps below in order.

CAUTION

1. Plug the host interface cable modular connector into the host port on the scanner.
2. Connect peripheral device cables to the correct ports on the scanner, and the other end of the cables to the peripherals.
3. Connect the external power supply to the host cable, adapter, or power port (if needed, see [Power Options](#)).
4. Connect the host cable to the host.

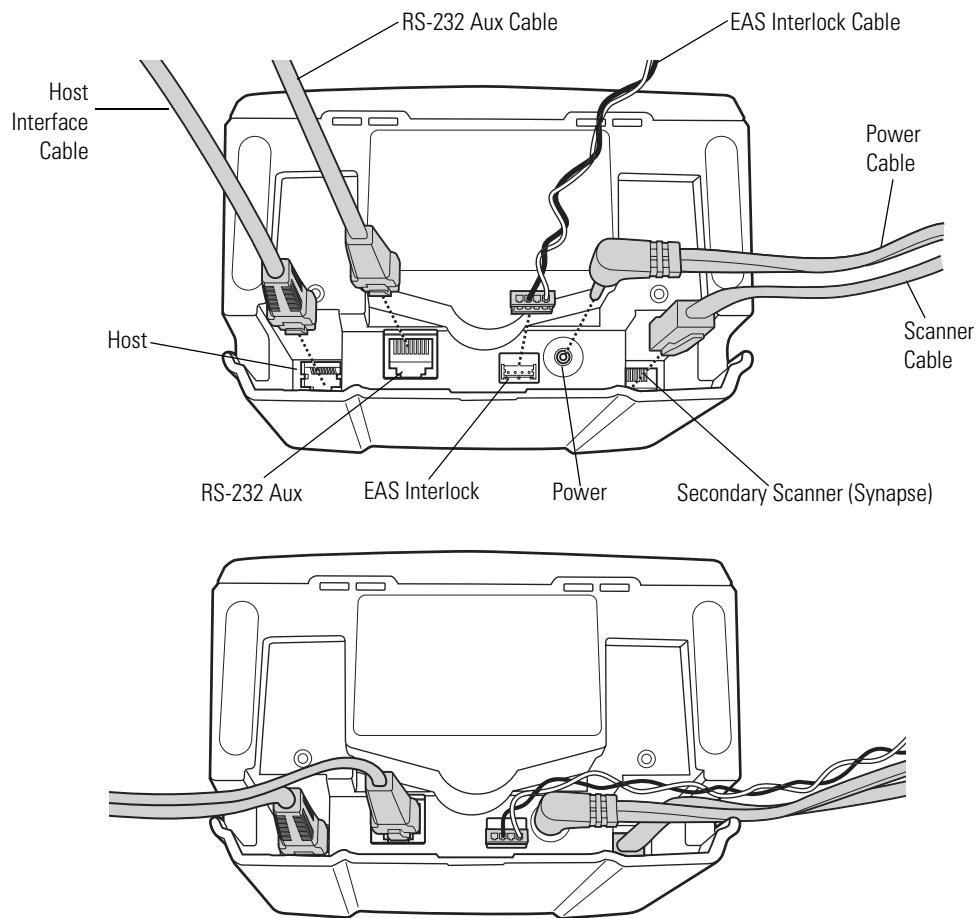

Figure 1-3. Scanner Connections



Note

Different hosts require different cables. The connectors illustrated in each host chapter are examples only. Connectors may be different from those illustrated, but the steps to connect the scanner are the same.

Routing Cables

The scanner case has several channels to route the outgoing cables so that they are organized and don't hinder the scanner's placement (see [Figure 1-1](#) and [Figure 1-3](#)). After placing the cable connectors in the appropriate scanner ports, route the cables through the nearest channel.

For a cable with a Y-connector (containing both power and interface connectors):

1. Connect the power and interface cables to the appropriate ports.
2. Route the cables according to the appropriate diagram in [Figure 1-4](#).

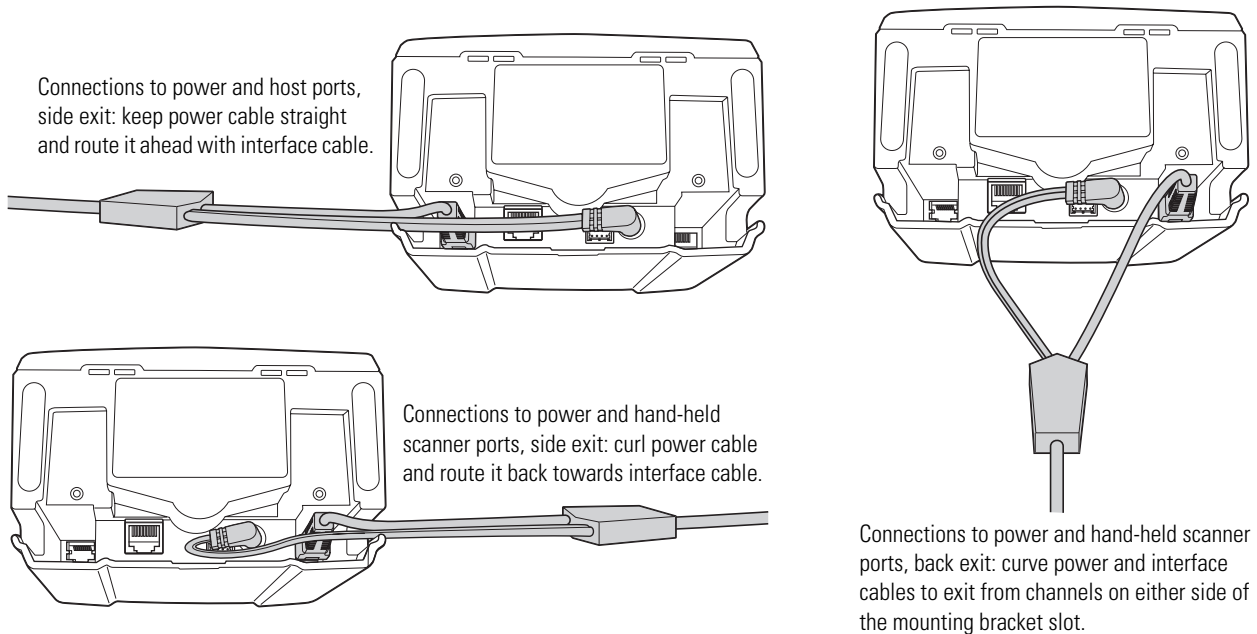

Figure 1-4. Cable Routing Options

Removing the Host Interface Cable

To remove the host interface cable:

1. Unplug the installed cable's modular connector by depressing the connector clip and gently pulling back. The two small holes on the back of the scanner case provide access to the connector clips. (See [Figure 1-5](#).)
2. Follow the steps for [Connecting the Host and Peripheral Cables on page 1-6](#) to connect a new cable.

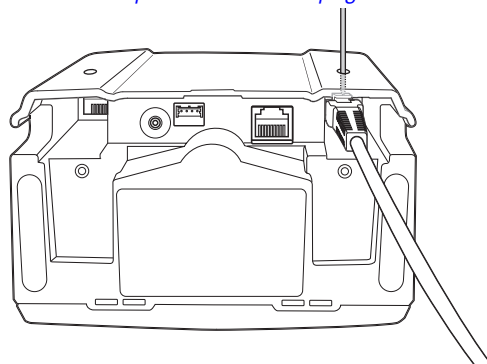

Figure 1-5. Unplugging the Cable Through the Cable Release Hole

Configuring the Scanner

To configure the scanner, use the bar codes in this manual, or use the 123Scan configuration program.

Refer to [Chapter 4, User Preferences](#) for information about programming the scanner using bar code menus. Refer to [Chapter 12, 123Scan](#) to configure the scanner using this configuration program. A help file is available in the program.

The scanner supports RS-232, IBM 468X/469X, Keyboard Wedge, USB, and Synapse to interface with a host system. Each host-specific chapter describes how to set up each of these connections.

Synchronization of Settings

Host Requested Setting Changes

The IBM 4683, IBM Handheld USB, and Synapse hosts can change a limited set of the scanner's settings. The 123Scan host maintains all the Symbol LS7708 scanner's settings. When a handheld scanner is connected, all setting changes the host requests are processed by both the LS7708 scanner and the handheld scanner. Only a limited set of handheld scanner settings are updated, including code type enable/disable, code type lengths, beeper settings, redundancy, and security level settings.

For example, if the IBM 4683 host requests to disable the Code 39 symbology, then Code 39 is disabled on both the LS7708 scanner and the handheld scanner.

Bar Code Menu Symbols Scanned on the Symbol LS7708 Scanner

A limited set of bar code menu symbols scanned on the Symbol LS7708 scanner are synchronized with the handheld scanner (if attached). These settings are code type enable/disable, code type lengths, beeper settings, redundancy, and security level settings.

Bar Code Menu Symbols Scanned on the Handheld Scanner

By default, the handheld scanner can program the Symbol LS7708 scanner's settings (primary only mode).

The handheld programming mode setting All Scanners Mode allows programming both the handheld scanner and the Symbol LS7708 scanner simultaneously. In this mode, scanning **Set Defaults** returns the LS7708 scanner to the default mode.

Another setting isolates the handheld scanner so that the bar code menu symbols scanned apply only to the handheld scanner. To return to the default functionality change the setting on the Symbol LS7708 scanner directly.

Regardless of the handheld scanner mode, all parameter changes requested by the host and via bar code menu settings on the Symbol LS7708 scanner are synchronized on the handheld scanner for applicable settings.

Mounting the Scanner to a Surface

The Symbol LS7708 is designed to sit on top of a counter or be mounted to a wall. The back of the scanner has a slot that accepts a mounting bracket to secure it to the mounting surface. The bracket accommodates either mounting option and, once attached to the scanner, keeps all cables securely in place.

Attaching the Mounting Bracket

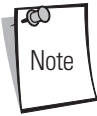

Before attaching the scanner to the mounting bracket, remove the oval-shaped rubber feet on the bottom of the scanner.

Freestanding Configuration

To set the scanner for freestanding configuration:

1. Connect all interface and power cables to the scanner (see [Figure 1-3 on page 1-7](#)). Route the cables appropriately for the mounting and cable configuration (see [Figure 1-4](#)).
2. Turn the scanner so its bottom is facing up and the connections are visible.
3. Orient the mounting bracket so that the plastic tab is facing down and toward the slot on the back of the scanner, and the square cushion on the mounting bracket is above the power cable.

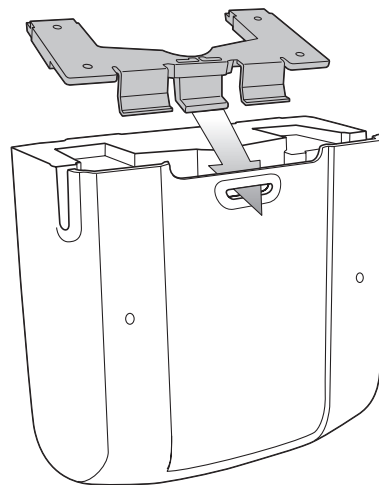

4. Tilt the plastic tab into the slot on the scanner, and rotate the opposite edge downward. As the bracket rotates, push it toward the slot so that the feet of the bracket lie flat against the scanner's bottom.

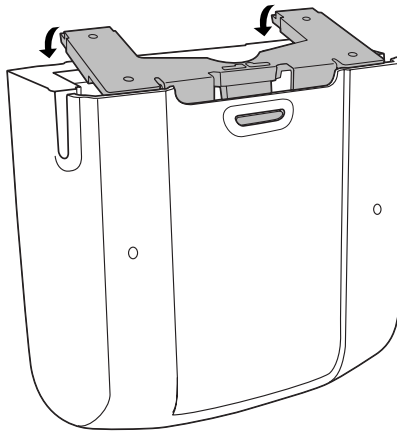

5. When the bracket is flat against the scanner bottom, release pressure so that the feet slide forward into the front of the scanner.

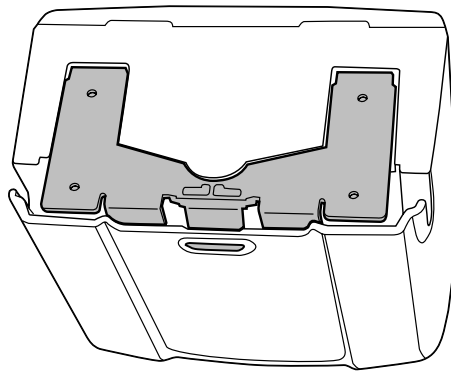

Attached Configuration

To attach the scanner to a mounting surface:

1. Determine the location for mounting the scanner.
2. Remove the square rubber feet that cover the screw holes on the mounting bracket.
3. Remove the two oblong-shaped bumpers on the scanner.
4. Use a pencil to mark the position of the mounting holes. (A mounting template is provided on [page E-3](#) in [Appendix E, Mounting Template.](#))
5. Place the mounting bracket in position over the drilled holes with its flat surface facing the mounting surface.

6. Insert screws through the holes and fasten to the mounting surface.

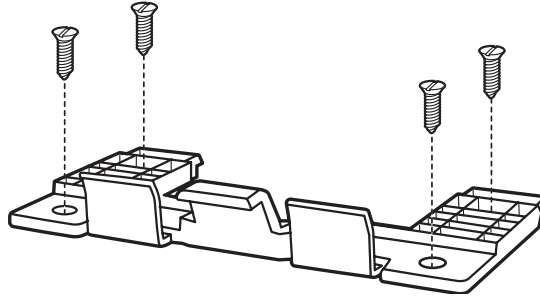

7. Align the slot at the back of the scanner with the plastic tab on the mounting bracket.

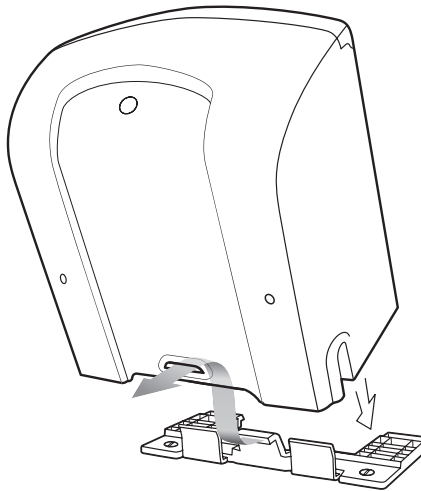

8. Angle the scanner slightly to allow the bracket hook to slide into the slot.
9. Push the scanner towards the plastic tab on the mounting bracket and rotate it so that it is perpendicular to the mounting surface.

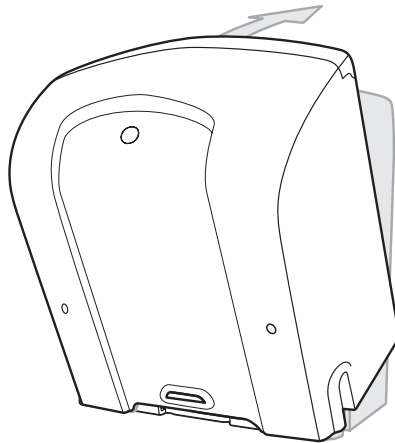

10. Release pressure on the scanner. The bracket locks into place.

Detaching the Scanner from the Mounting Bracket

To detach the scanner:

1. Grasp the scanner firmly on both sides.
2. Squeeze the back of the scanner slightly while pushing the scanner in the direction of the slot on the back.
3. Rotate the front of the scanner away from the mounting bracket until the bracket pops out of the slot.

2

Scanning

Introduction	2-3
Active Scan Area	2-3
Scanning Bar Codes	2-3
Beeper Definitions	2-5
Selecting Beeper Volume	2-6
Sleep Mode	2-6
LED Definitions	2-6
Decode Zone	2-7
Integrated Electronic Article Surveillance (EAS)	2-8
LS7708 Interlock Cable and EAS	2-8
Installing the Electronic Article Surveillance (EAS)	2-8
CheckPoint EAS Model Compatibility	2-8
Considerations	2-8
CheckPoint Contact Information	2-8
Deactivation for Sensormatic EAS System	2-8

Introduction

This chapter covers the techniques involved in scanning bar codes, beeper and LED definitions, and general instructions and tips about scanning. Refer to [Chapter 1, Getting Started](#) for information on scanner components, and connecting host cables and the power supply.

Active Scan Area

The active scan area is the area in front of the scanner window in which a bar code can be decoded. The dotted area in [Figure 2-1](#) represents the active scan area for the scanner.

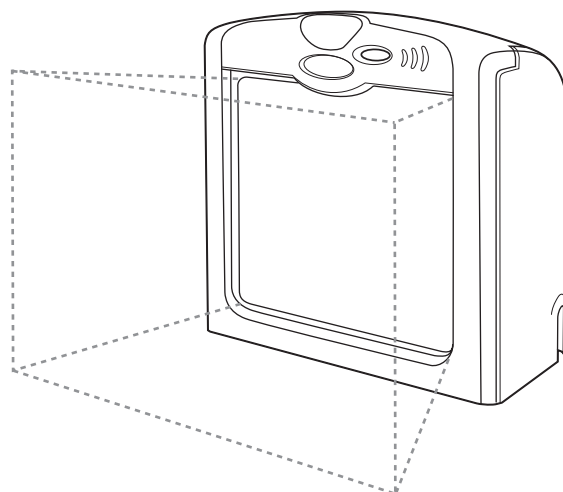

Figure 2-1. Symbol LS7708 Active Scan Area

Scanning Bar Codes

Install and program the scanner. (Refer to each host chapter and [Chapter 4, User Preferences](#), [Chapter 13, Symbologies](#), [Chapter 14, Miscellaneous Scanner Options](#), and [Advanced Data Formatting](#) for instructions on programming the scanner.) For assistance, contact the local supplier or call the Global Customer Interaction Center. See [page xvi](#) for contact information.

For the best scanning performance, the counter top or surface area covered by the active scan area should be a light, solid color. Avoid designs (e.g., stripes or patterns). A rastering, 120-line, omni-directional scan pattern provides rapid, orientation-free scanning.

To scan a bar code:

1. Ensure all cable connections are secure.
2. Orient the item with the bar code facing the scanner window.
3. Move the item through the active scan area in the direction of the arrows (swipe scanning, see [Figure 2-2](#)), or place the item in front of the scanner (presentation scanning, see [Figure 2-3](#)). Ensure that the scan lines cross every bar and space of the symbol.

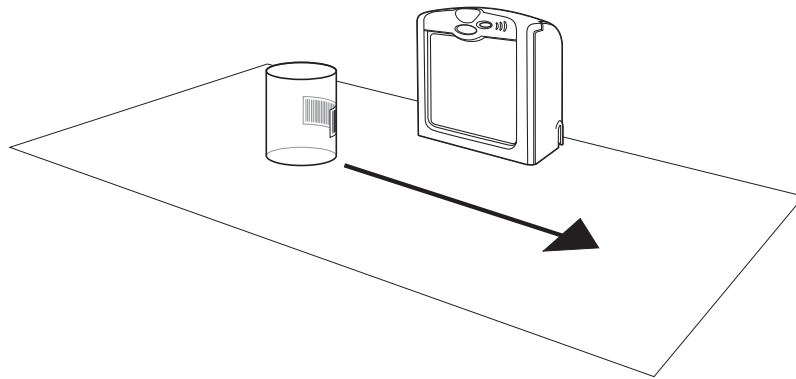
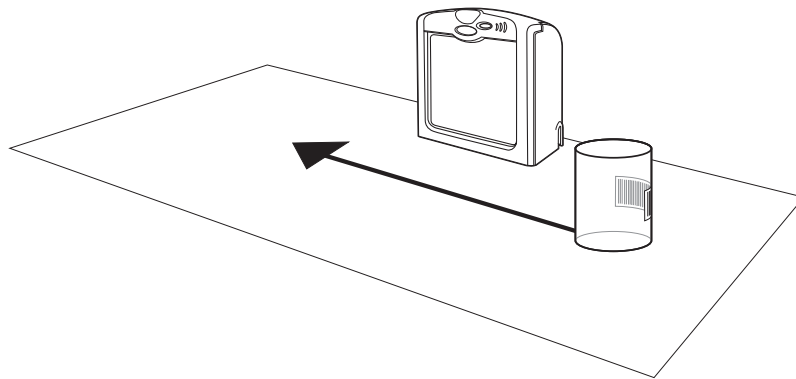

Figure 2-2. Scanning a Bar Code - Swipe Method

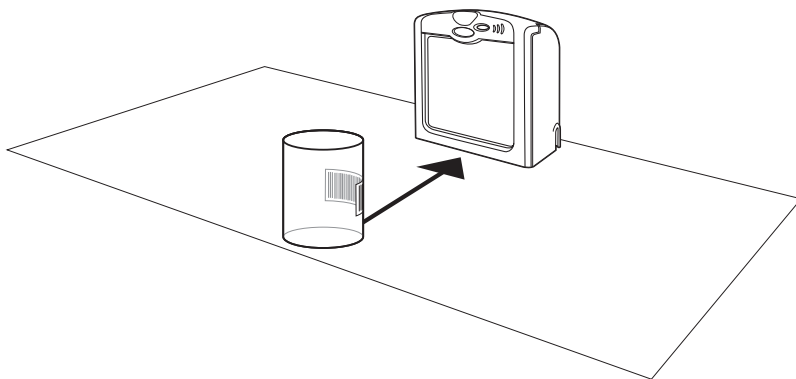

Figure 2-3. Scanning a Bar Code - Presentation Method

4. Upon successful decode, the scanner beeps and the green LED flashes.

For more information on beeper definitions, see [Table 2-1](#).

Beeper Definitions

The scanner communicates by emitting different beeper sequences. [Table 2-1](#) defines beeper sequences that occur during normal scanning and while programming the scanner.

Table 2-1. Standard Beeper Definitions

Beeper Sequence	Indication
Standard Use	
3 short high beeps	Power up.
Short high beep	A bar code was decoded (if decode beeper is enabled).
4 long low beeps	A transmission error was detected in a scanned symbol. The data is ignored. This occurs if the scanner is not properly configured. Check option settings. When scanning bar code menu symbols, indicates the handheld scanner does not support the setting; use the primary scanner instead.
5 low beeps	Conversion or format error.
Lo/hi/lo beep	ADF transmit error.
Hi/hi/hi/lo beep	RS-232 receive error on RS-232 host or RS-232 auxiliary port.
Parameter Menu Scanning	
Short high beep	Correct entry scanned or correct menu sequence performed.
Lo/hi beep	Input error, incorrect bar code or "Cancel" scanned, wrong entry, incorrect bar code programming sequence; remain in program mode.
Hi/lo beep	Keyboard parameter selected. Enter value using bar code keypad.
Hi/lo/hi/lo beep	Successful program exit with change in the parameter setting.
Lo/hi/lo/hi beep	Out of host parameter storage space. Scan Set Default Parameter on page 4-5 .
Lo/lo/lo/lo beep	Unsupported parameter.
Code 39 Buffering	
Hi/lo beep	New Code 39 data was entered into the buffer.
3 long high beeps	Code 39 buffer is full.
Lo/hi/lo beep	The Code 39 buffer was erased or there was an attempt to clear or transmit an empty buffer.
Lo/hi beep	A successful transmission of buffered data.
Host Specific	
USB only	
4 short high beeps	Scanner has not completed initialization. Wait several seconds and scan again.
Scanner emits a power-up beep sequence (3 short high beeps) after scanning a USB Device Type.	Communication with the bus must be established before the scanner can operate at the highest power level.
This power-up beep occurs more than once.	The USB bus may put the scanner in a state where power to the scanner is cycled on and off more than once. This is normal and usually happens when the PC cold boots.
RS-232 Host only	
1 short high beep	A <BEL> character is received and Beep on <BEL> is enabled.

Table 2-1. Standard Beeper Definitions

Beeper Sequence	Indication
RS-232 Auxiliary Port only	
1 short high beep	A complete block of data was received and sent to the host, either due to a carriage return or because the two-second serial response timeout has elapsed.
4 long low beeps	A data overrun condition has occurred. Do not scan data from other ports when large amounts of data are sent to the RS-232 auxiliary port.

Selecting Beeper Volume

The scanner emits a short beep when it successfully reads a bar code. To change the volume of the beep scan the beeper volume bar code on [page 4-7](#), or use the two-function Volume Control and Wakeup button (see [Figure 1-1 on page 1-3](#)) on the front of the scanner as follows:

1. Press and hold the button for approximately five seconds. The scanner cycles through three settings (low, medium, high) emitting a two-beep tone at each setting.
2. To select a particular setting, release the button after the desired two-beep tone is heard.

Sleep Mode

The scanner enters Sleep mode when it is inactive for a specified length of time. The scanner has two levels of sleep: laser and motor. In laser sleep mode, after ten seconds of inactivity the laser pulses at a 50% rate, then drops to 3% after a specified time. In motor sleep mode, the scanner turns off the motor and the laser.

To wake the scanner from sleep mode, press the Volume Control & Wakeup button (see [Figure 1-1](#)). In laser sleep mode, also wake the scanner by presenting a bar code to the scanner window.

LED Definitions

The scanner also communicates via an LED (see [Figure 1-1](#)). [Table 2-2](#) defines LED indications that occur during scanning.

Table 2-2. Standard LED Definitions

LED	Indication
Off	No power is applied to the scanner.
Green	The scanner is on and "ready to scan."
Momentary green flash	A bar code was successfully decoded.
Slow continuous red flashing, green on	The scanner is in programming mode.
Fast continuous red flashing, green on	There is an internal problem; the laser is shut off for regulatory reasons.
Green on (and laser blinking)	Scanner is in Low Power Blink mode.
Red and green on	Scanner is in Low Power Motor and Laser Shutdown mode.

Decode Zone

Figure 2-4 illustrates the area in which the scanner recognizes bar codes.

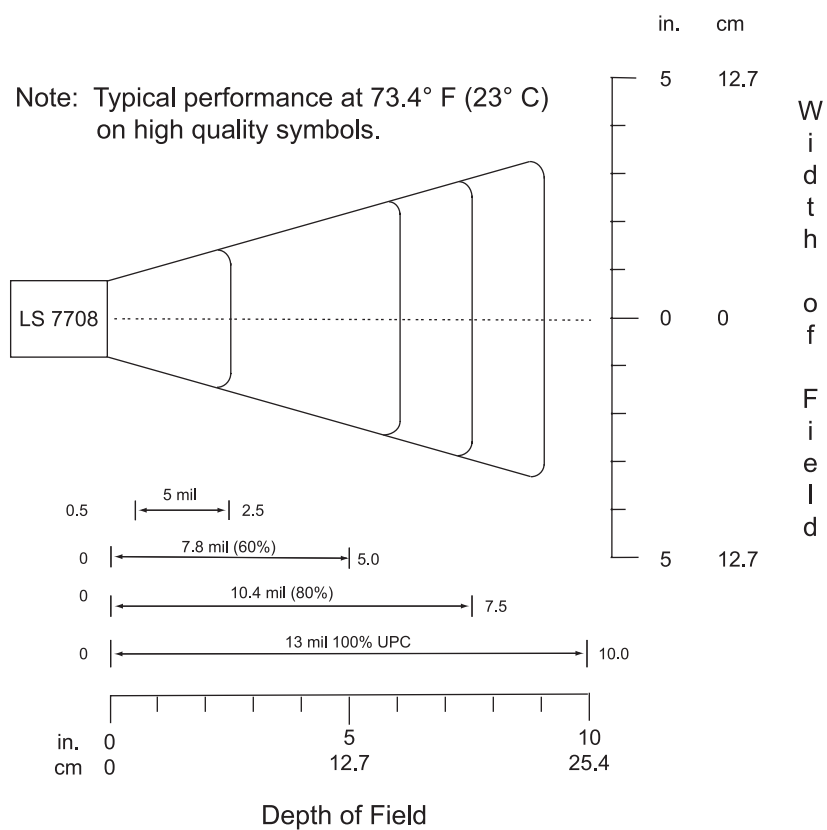

*Minimum distance determined by symbol length and scan angle

Figure 2-4. Symbol LS7708 Decode Zone

Integrated Electronic Article Surveillance (EAS)

The scanner includes an Electronic Article Surveillance (EAS) antenna. The scanner and EAS system can operate independently of each other, or using an exclusive interlock feature. The deactivation range is mapped suitable to the scanning range, so both can be accomplished almost simultaneously. The interlock feature requires a good decode signal to activate the EAS system.



CAUTION

Do not attempt to activate the interlock feature. Activation instructions are for a Motorola qualified technician only.

The scanner's integrated EAS deactivation antenna requires an EAS host cable. This Y-cable connects to the scanner's host port at one end, and splits to the host and the EAS system at the other end.

LS7708 Interlock Cable and EAS

To connect the EAS interlock feature to the scanner:

1. Peel off the EAS sticker on the bottom of the scanner (see [Figure 1-1 on page 1-3](#)). The sticker covers the EAS interlock port.
2. Plug the EAS interlock cable into the port (see [Figure 1-3 on page 1-7](#)).
3. Attach the other end to the EAS system.

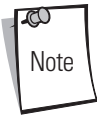

Be sure to scan the proper bar code on [page 4-17](#) to activate this feature.

Installing the Electronic Article Surveillance (EAS)

CheckPoint EAS Model Compatibility

The EAS cable is intended for use with CheckPoint CP-VII and CP-IX systems. It does not support CP-IV and other low-power receiver-based EAS deactivation systems.

Considerations

The CheckPoint CP-VII system generates a periodic burst of electromagnetic energy that deactivates EAS tags brought near the scanner. To avoid interference with the scanner's operation, take the following precautions when installing the EAS system:

- Position the EAS antenna box as far as possible from the scanner (at least 6 in. / 15.24 cm.)
- Position the EAS antenna, EAS antenna box, EAS control cable, and EAS controller box as far as possible from the scanner's host and power cables.

CheckPoint Contact Information

Contact your local Checkpoint representative to install the EAS cable to the Checkpoint Deactivation System.

To contact a representative:

- In the United States call: **800-257-5540 x4300**
- Outside the United States: **(609) 848-1800 x4300**

Deactivation for Sensormatic EAS System

To interface to Sensormatic systems, contact Motorola Product Management.

3

Maintenance and Technical Specifications

Introduction	3-3
Maintenance	3-3
Replacing the Scanner Window	3-4
Troubleshooting	3-6
Technical Specifications	3-7
Scanner Signal Descriptions	3-9

Introduction

This chapter covers suggested scanner maintenance, troubleshooting, technical specifications, and signal descriptions (pinouts).

Maintenance

Cleaning the exit window is the only maintenance required. A dirty window can affect scanning accuracy.

- Do not allow abrasive material to touch the window.
- Remove dirt particles with a damp cloth.
- Wipe the window using a tissue moistened with ammonia/water.
- Do not spray water or other cleaning liquids directly into the window.

Replacing the Scanner Window

To replace the scanner window:

1. Reach under the lip of the front panel and lift it away from the scanner.

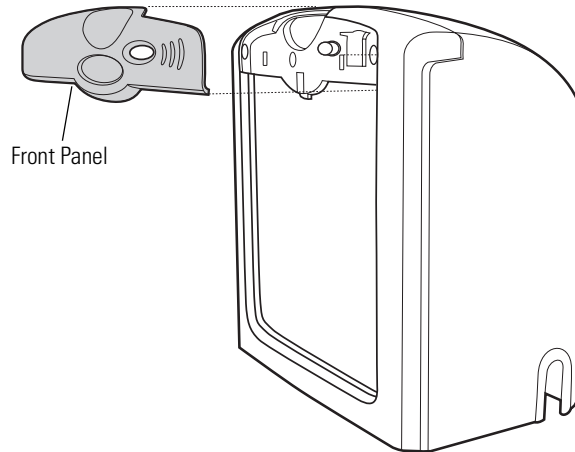

Figure 3-1. Removing the Front Panel

2. Unfasten the screws behind the panel that secure the window frame.)

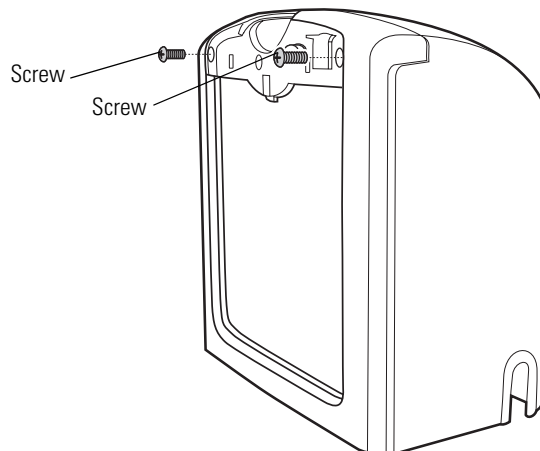

Figure 3-2. Unfastening the Screws that Secure the Window Frame

3. Tilt the loosened window frame forward far enough to gain access to the exit window.
4. Carefully remove the exit window from the window frame.

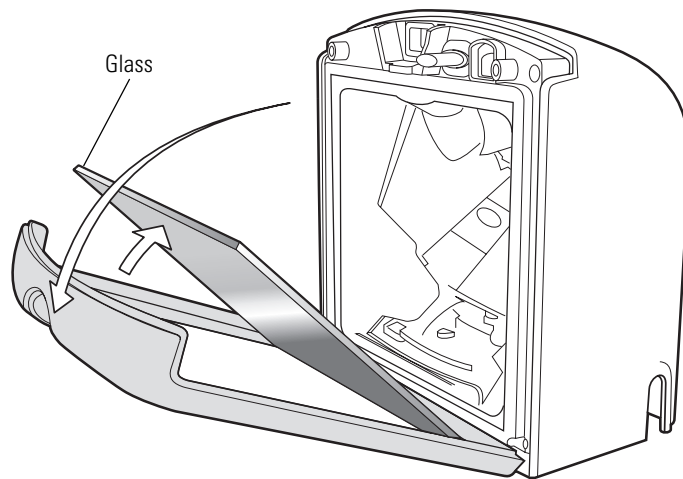

Figure 3-3. Removing and Replacing the Window Glass

5. Insert a new, clean exit window.
6. Tilt the window frame back into position.
7. Secure the window frame to the scanner using two screws.
8. Snap the front panel back into position.

Troubleshooting

Problem	Possible Causes	Possible Solutions
The omni-line scan pattern does not display when following the directions for installing the host cable on page 1-5 .	No power to the scanner.	Ensure the host has power and is on. If the scanner uses a separate power supply, ensure it's connected to a working AC outlet.
	Interface cable is not properly connected.	Check for loose cable connections.
Scan line(s) display, but bar code cannot be read.	Scanner is not programmed to read the bar code type.	Ensure scanner is programmed to read the bar code type being scanned.
	Bar code is damaged.	Try scanning other bar codes of the same bar code type.
	Bar code is too far from scanner.	Move the bar code closer to the scanner.
	The host has disabled scanning or overridden parameter settings.	See the technical person in charge of scanning.
Bar code is decoded, but not transmitted to the host.	Scanner is not programmed for the correct host type.	Scan the appropriate host type bar code.
Scanned data is incorrectly displayed on the host.	Scanner is not programmed to work with the host. Check scanner host type parameters or editing options.	<ul style="list-style-type: none"> • Ensure proper host is selected. • For RS-232, ensure the scanner's communication parameters match the host's settings. • For keyboard wedge, ensure scanner is programmed with the correct country code and that the CAPS LOCK key is off. • Ensure editing options (e.g., UPCE-to-UPCA Conversion) are properly programmed.
Although the green and red Power LEDs are on, the scanner does not produce the omni-directional scan pattern.	Scanner has gone into Low Power "Motor Sleep" Mode.	Press the Volume Control & Wakeup button to awaken the scanner.
USB or Synapse host not functioning properly.	Scanner does not recognize host.	Remove and reinsert external power supply to force cable to autodetect correct host.
An error occurs when connecting to a USB host.	Cables were installed in the incorrect order.	See Connecting the Host and Peripheral Cables on page 1-6 for the correct order of insertion.
Handheld scanner does not power on.	External power supply is not attached.	Connect an external power supply directly to the scanner, not to the host cable.
Auxiliary RS-232 device data is not received properly.	External power supply is not attached.	Connect an external power supply directly to the scanner, not to the host cable.
	Auxiliary device supplies TTL level RS-232 signals.	Use a device that supports standard RS-232 signal levels.
	Auxiliary settings are incorrect.	Use auxiliary RS-232 port settings, not the RS-232 host settings.



If after performing these checks the symbol still does not scan, contact the distributor or call the Global Customer Interaction Center. See [page xvi](#) for contact information.

Technical Specifications

Table 3-1. Technical Specifications

Item	Description
Physical Characteristics	
Dimensions:	
Without stand: Height	6.3 in. (16 cm)
Width	5.98 in. (15.2 cm)
Depth	3.73 in. (9.5 cm)
Weight	Scanner only: 2.04 lbs. (925 g)
Power Source	Power drawn from host terminal or external power supply; depends on host type.
Voltage	5.5 VDC to 4.75 VDC measured at host terminal or external power supply
Current	390mA (nominal) / 500 mA maximum with no peripheral
Power (nominal)	2 watts with no peripheral
Mounting Options	Integral mounting bracket
Color	Cash Register White or Twilight Black
Performance Characteristics	
Light Source	650nm visible laser diode
Print Contrast	25% minimum reflective difference
Scan Patterns	Static: 24 scan lines
	Raster: 120 scan lines
Scan Rate	Static: 2,400 scans/sec.
	Raster: 12,000 scans/sec.
Depth of Field	0-10 in./0-25.4 cm @ 13 mil (100% UPC/EAN)
Typical Working Range	5 mil: (38%) 0.5 to 2.5 in./ 1.27 to 6.4 cm 7.8 mil: (60%) 0 to 5 in./ 0 to 12.7 cm 10.4 mil: (80%) 0 to 7.5 in./ 0 to 19 cm 13 mil: (100%) 0 to 10.0 in./ 0 to 25.4 cm
Minimum Resolution	5 mil
Decode Capability	UPC/EAN/JAN, UPC/EAN with Supplementals, UCC/EAN 128, Code 128, ISBT 128, Code 39, Code 39 Trioptic, Interleaved 2 of 5, Discrete 2 of 5, Code 93, Code 11, Codabar, RSS Variants
Interfaces Supported	USB, RS-232, IBM® 468X/9X, Keyboard Wedge, and Synapse™ (allows connectivity to virtually every POS host type), SPCI (for 123Scan)
User Environment	
Operating Temperature	32° to 104°F (0° to 40°C)
Storage Temperature	-40° to 140°F (-40° to 60°C)
Humidity	5% to 95% (non-condensing)
Ambient Light Immunity	Immune to normal artificial indoor and natural outdoor (direct sunlight) lighting conditions. Fluorescent, Incandescent, Mercury Vapor and Sodium Vapor: 450 Ft Candles (4,844 Lux) Sunlight: 8000 Ft Candles (86,111 Lux)

Table 3-1. Technical Specifications (Continued)

Item	Description
EAS Support	Checkpoint Electronic Article Surveillance Antenna (EAS) Included Sensormatic - Contact Product Management
Regulatory	
Electrical Safety	Certified to UL60950, CSA C22.2 No.60950, EN60950
Laser Safety	CDRH Class IIa Laser Product IEC 60825 Class 1 Laser Product
EMC	CISPR 22 Class B, FCC Part 15 Class B, EN55024, EN61000-3-2, EN61000-3-3
¹ Refers to 100% UPC bar code (80% contrast) located 4 in. (10 cm) from the scanner.	

Scanner Signal Descriptions

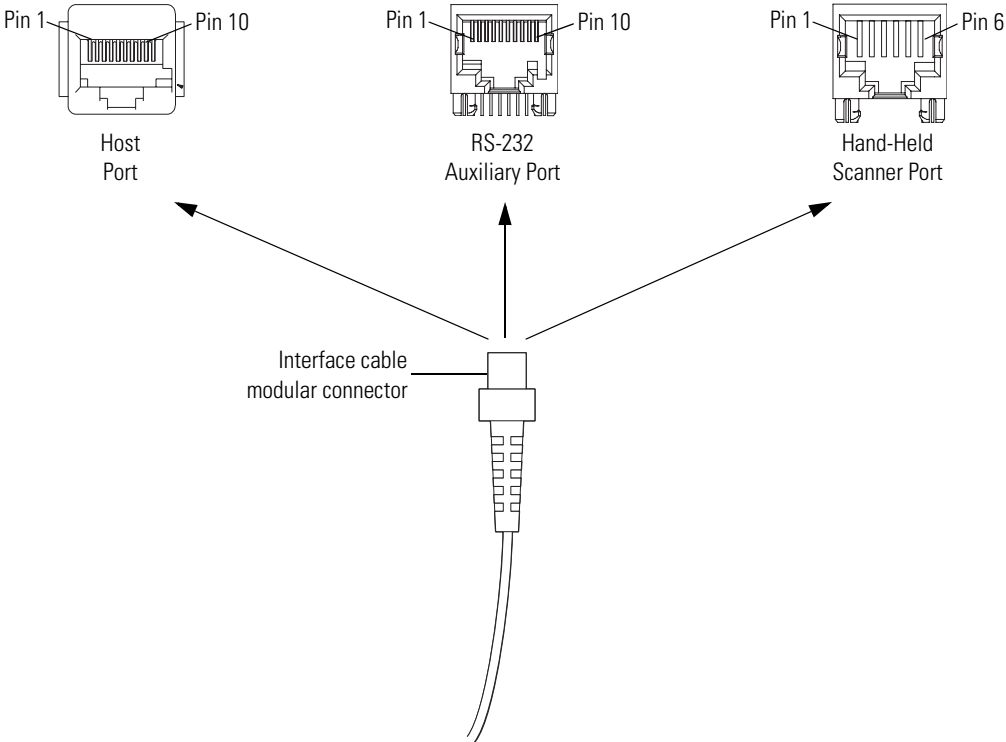
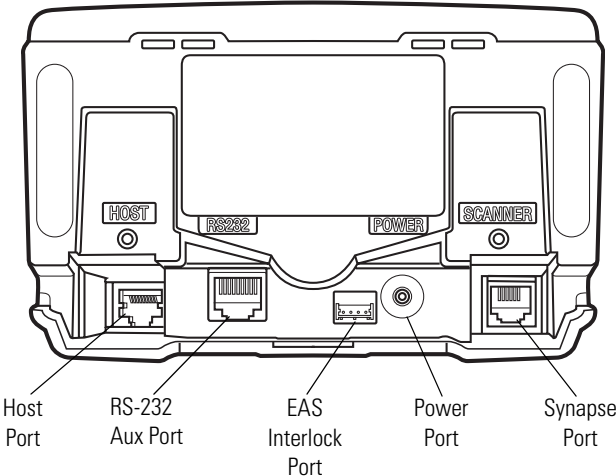

Figure 3-4. Cable Pinouts

The signal descriptions in [Table 3-2](#) apply to the connector on the scanner and are for reference only.

Table 3-2. Scanner/Host Signal Pin-outs

Pin	Symbol LS7708					
	IBM	Synapse	RS-232	Keyboard Wedge	USB	Download
1	Reserved	SynClock	Reserved	Reserved	Jump to Pin 6	Reserved
2	Power	Power	Power	Power	Power	Power
3	Ground	Ground	Ground	Ground	Ground	Ground
4	IBM_A(+)	Reserved	TxD	KeyClock	Reserved	TxD
5	Reserved	Reserved	RxD	TermData	D +	Reserved
6	IBM_B(-)	SynData	RTS	KeyData	Jump to Pin 1	RxD
7	Reserved	Reserved	CTS	TermClock	D -	Reserved
8	Reserved	Reserved	Reserved	Reserved	Reserved	Reserved
9	Reserved	Reserved	Reserved	Reserved	Reserved	Reserved
10	Reserved	Reserved	Reserved	Reserved	Reserved	Reserved

Table 3-3. RS-232 Auxiliary Port Pinouts

Pin #	Signal	Unterminated Wire*	Description
1	-		
2	DTR	Brown	Output, Data Terminal Ready
3	RXD	Orange	Input, Received Data
4	VCC	Red	5 volts
5	RTS	Green	Output, Ready to Send
6	GND	Black	Ground
7	CTS	Purple	Input, Clear to Send
8	-		
9	TXD	Yellow	Output, Transmitted Data
10	-		

*The RS-232 port can power a connected device, such as a scale, magstripe reader, or hand-held scanner. The device's mating connector is wired to the end of an unterminated cable. Contact the Global Customer Interaction Center to obtain an unterminated cable for this port. The following table lists unterminated wires and their functions.

If the device attached to the RS-232 Auxiliary Port is self-powered, do not connect the red wire (VCC) to the mating connector. This prevents the device from back-powering the LS7708.

Table 3-4. Hand-Held Scanner Port Pinouts

Pin 1	Pin 2	Pin 3	Pin 4	Pin 5	Pin 6
SYNDATA	SYNCLK	VCC	GND	-	-

Table 3-5. EAS Interlock Port Pinouts

Pin 1	Pin 2	Pin 3	Pin 4
VCC	GND	-	INTERLOCK

4

User Preferences

Introduction	4-3
Scanning Sequence Examples	4-3
Errors While Scanning	4-3
User Preferences Default Parameters	4-3
User Preferences	4-5
Set Default Parameter	4-5
Beeper Tone	4-5
Beeper Volume	4-7
Beep After Good Decode	4-9
Low Power Mode	4-10
Scan Pattern Mode	4-11
Timeout Between Decodes	4-12
Time Delay to Low Power Mode	4-13
Linear UPC/EAN Decode	4-15
UPC Half Block Stitching	4-16
EAS Interlock	4-17

Introduction

The scanner can be programmed to perform various functions or activate different features. This chapter describes each user preference feature and provides the programming bar codes necessary for selecting these features for the scanner. Before programming, follow the instructions in [Chapter 1, Getting Started](#).

The scanner is shipped with the settings shown in the [User Preferences Default Table on page 4-4](#) (also see [Appendix A, Standard Default Parameters](#) for all host device and miscellaneous scanner defaults).

To set feature values scan single bar codes or short bar code sequences. The settings are stored in non-volatile memory and are preserved even when the scanner is powered down. Scanning parameter setting bar codes with the primary scanner also changes settings on the auxiliary scanner.

If not using a Synapse or USB cable, select a host type (see the host chapter) after the power-up beeps. This only needs to be done once upon the first power-up when connected to a new host.

To return all features to their default values, scan the [Set All Defaults](#) bar code on page 4-5. Throughout the programming bar code menus, asterisks (*) indicate default values.

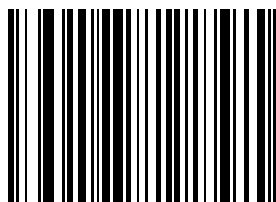

* Indicates Default — *High Beeper Frequency — Feature/Option

Scanning Sequence Examples

In most cases scanning only one bar code sets a specific parameter value. For example, to set the beeper tone to high, scan the High Frequency (beeper tone) bar code listed under [Beeper Tone on page 4-5](#). The scanner issues a short high beep and the LED turns green, signifying a successful parameter entry.

Other parameters, such as Serial Response Time-Out or setting Data Transmission Formats, require scanning several bar codes. Refer to [Host Serial Response Time-out on page 6-26](#) and [Scan Data Options on page 14-7](#) for descriptions of this procedure.

Errors While Scanning

Unless otherwise specified, if an error occurs during a scanning sequence, just re-scan the correct parameter.

User Preferences Default Parameters

[Table 4-1](#) lists the defaults for user preferences parameters. To change any option, scan the appropriate bar code(s) beginning in [User Preferences on page 4-5](#).



Refer to [Appendix A, Standard Default Parameters](#) for all user preferences, hosts, symbologies, and miscellaneous default parameters.

Table 4-1. User Preferences Default Table

Parameter	Default	Page Number
User Preferences		
Set Default Parameter	All Defaults	4-5
Beeper Tone	Medium	4-5
Beeper Volume	High	4-7
Beep After Good Decode	Enable	4-9
Low Power Mode	Low Power Blink Mode	4-10
Scan Pattern Mode	Rastering	4-11
Time-out Between Same Symbol	0.6 sec	4-12
Time-out Between Different Symbols	0.2 sec	4-12
Time Delay to Low Power Mode	30 Minutes	4-13
Linear UPC/EAN Decode	Disable	4-15
UPC Half Block Stitching	Enable	4-16
EAS Interlock	Disable	4-17

User Preferences



Scanning parameter setting bar codes with the primary scanner also changes settings on the auxiliary scanner.

Set Default Parameter

Scanning this bar code returns all parameters to the default values listed in [Table A-1 on page A-1](#).

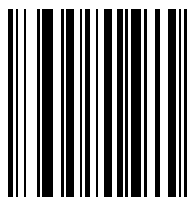

Set All Defaults

Beeper Tone

To select a decode beep frequency (tone), scan the **Low Frequency**, **Medium Frequency**, or **High Frequency** bar codes.

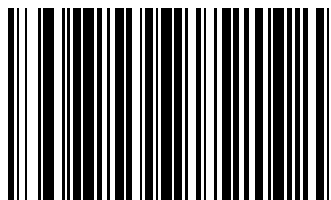

Low Frequency

Beeper Tone (continued)

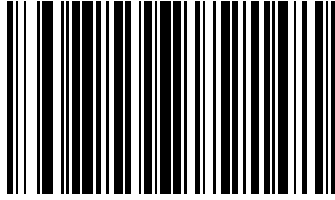

***Medium Frequency**

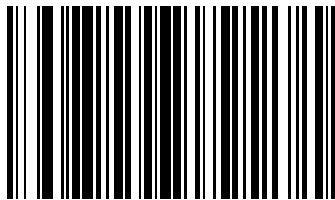

High Frequency

Beeper Volume

To select a beeper volume, scan one of the following bar codes.

Low Beeper Volume

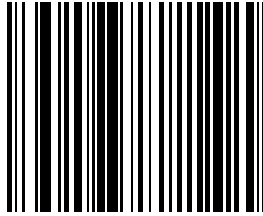

Low Beeper Volume

Medium Beeper Volume

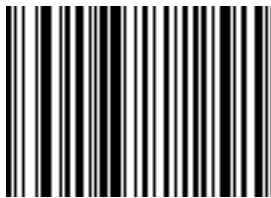

Medium Beeper Volume

High Beeper Volume

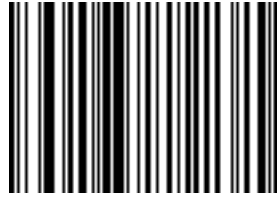

High Beeper Volume

Beep After Good Decode

Scan a bar code below to select whether or not the scanner beeps after a good decode. If **Do Not Beep After Good Decode** is selected, the beeper still operates during parameter menu scanning and indicates error conditions.

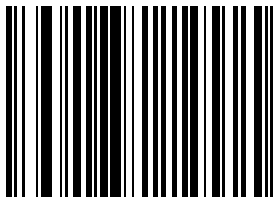

***Beep After Good Decode
(Enable)**

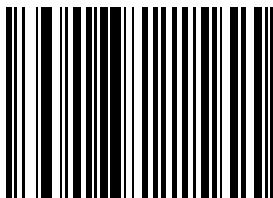

**Do Not Beep After Good Decode
(Disable)**

Low Power Mode

After a period of inactivity, the scanner enters a reduced power mode. This parameter controls how aggressively power is conserved, and therefore determines the method of waking the scanner up.

Low Power Blink

Selecting **Low Power Blink Mode** causes the scanner (after a period of inactivity) to blink the laser infrequently to save power. The green LED remains lit. To restore the scanner to full power mode, present a bar code.



***Low Power Blink Mode**

Motor and Laser Shut Down

Selecting **Motor and Laser Shut Down** causes the scanner (after a period of inactivity) to turn off the motor and laser. The red and green LEDs remain lit. Depress the Volume Control and Wakeup button (see [Figure 1-1 on page 1-3](#)) to awaken the scanner to its full power mode.

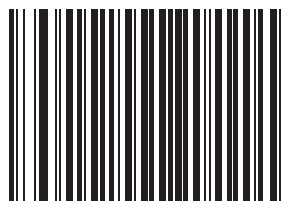

Low Power Motor and Laser Shut Down

Scan Pattern Mode

The Symbol LS7708 has a very aggressive scan pattern that is both omnidirectional and raster. To select a static omnidirectional pattern, scan the **Omnidirectional Pattern** bar code to change the scan pattern.

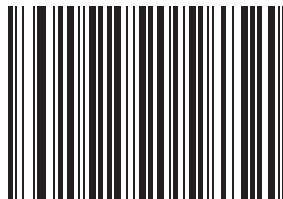

***Rastering Omnidirectional Pattern**



Omnidirectional Pattern

Timeout Between Decodes

Timeout Between Decodes, Same Symbol

This parameter sets the minimum time between decodes of the same symbol. It is programmable in 0.1-second increments from 0.0 to 9.9 seconds. Setting this above 0.4 seconds is recommended. The default for this parameter is 0.6 seconds.

Scan the bar code below to select a new timeout. Next, scan two numeric bar codes beginning in [Numeric Bar Codes on page D-1](#) that correspond to the desired timeout. Include a leading zero for single digit numbers. For example, to set a timeout of 0.5 seconds, scan the bar code below, then scan the "0" and "5" bar codes. If an error occurs, or to change the selection, scan **Cancel** on page [D-8](#).

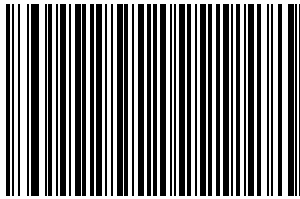

Timeout Between Same Symbol

Timeout Between Decodes, Different Symbol

This parameter sets the minimum time between decodes of different symbols. It is programmable in 0.1-second increments from 0.0 to 9.9 seconds. The default for this parameter is 0.2 seconds.

Scan the bar code below to select a new timeout. Next, scan two numeric bar codes beginning in [Numeric Bar Codes on page D-1](#) that correspond to the desired timeout. Include a leading zero for single digit numbers. For example, to set a timeout of 0.5 seconds, scan the bar code below, then scan the "0" and "5" bar codes. If an error occurs, or to change the selection, scan **Cancel** on page [D-8](#).



Timeout Between Different Symbol

Time Delay to Low Power Mode

This parameter sets the time that the scanner remains active after any scanning activity. Depending on the selection, the scanner enters a sleep mode 15, 30, 60, or 90 minutes after the last attempted decode. To awaken the scanner, see [Low Power Mode on page 4-10](#).



15 Minutes



***30 Minutes**

Time Delay to Low Power Mode (continued)

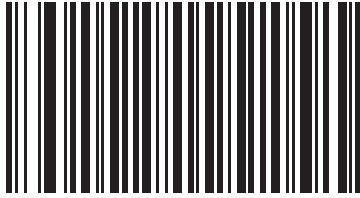

60 Minutes

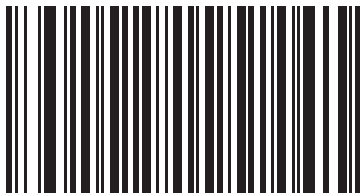

90 Minutes

Linear UPC/EAN Decode

This option applies to code types containing two adjacent blocks (e.g., UPC-A, EAN-8, EAN-13). When enabled, a bar code is transmitted only when both the left and right blocks are successfully decoded within one laser scan. Enable this option when bar codes are in proximity to each other.

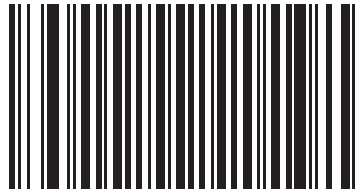

Enable Linear UPC/EAN Decode

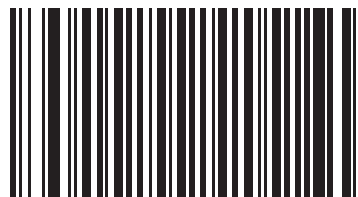

***Disable Linear UPC/EAN Decode**

UPC Half Block Stitching

This parameter enables UPC Half Block Stitching for the Symbol LS7708 omnidirectional scanner only.

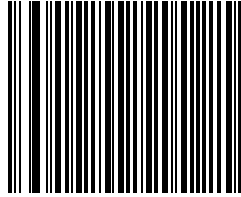

***Enable UPC Half Block Stitching**

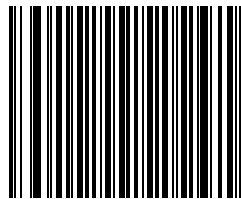

Disable UPC Half Block Stitching

EAS Interlock

Enable EAS Interlock

When enabled, the EAS tag is de-activated only when the associated bar code is decoded.

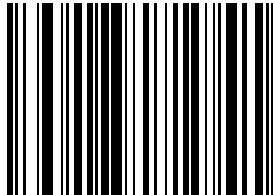

Enable EAS Interlock

Disable EAS Interlock

When disabled (default), the EAS tag is de-activated independently of any bar code scanning.

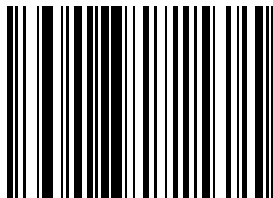

***Disable EAS Interlock**

5

Keyboard Wedge Interface

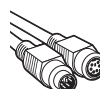

Introduction	5-3
Connecting a Keyboard Wedge Interface	5-4
Keyboard Wedge Default Parameters	5-6
Keyboard Wedge Host Types	5-7
Keyboard Wedge Country Types (Country Codes)	5-9
Ignore Unknown Characters	5-14
Keystroke Delay	5-15
Intra-Keystroke Delay	5-17
Alternate Numeric Keypad Emulation	5-18
Caps Lock On	5-19
Caps Lock Override	5-20
Convert Wedge Data	5-21
Function Key Mapping	5-23
FN1 Substitution	5-24
Send Make Break	5-25
OnKeyboard Maps	5-26
ASCII Character Set	5-28

Introduction

This chapter provides information for setting up the scanner with a Keyboard Wedge interface. Use this interface type to attach the scanner between the keyboard and host computer. The scanner translates bar code data into keystrokes which the host computer accepts as if they originate from the keyboard.

This mode of operation allows adding bar code reading functionality to a system designed for manual keyboard input. In this mode the keyboard keystrokes are simply passed through.

Throughout the programming bar code menus, asterisks (*) indicate default values.

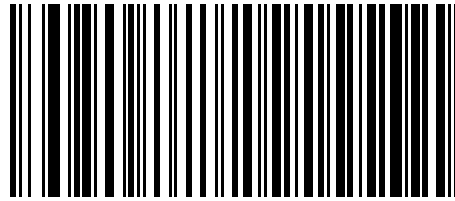

* Indicates Default — *North American — Feature/Option

Connecting a Keyboard Wedge Interface

To connect the Keyboard Wedge configuration (see [Figure 5-1](#)):

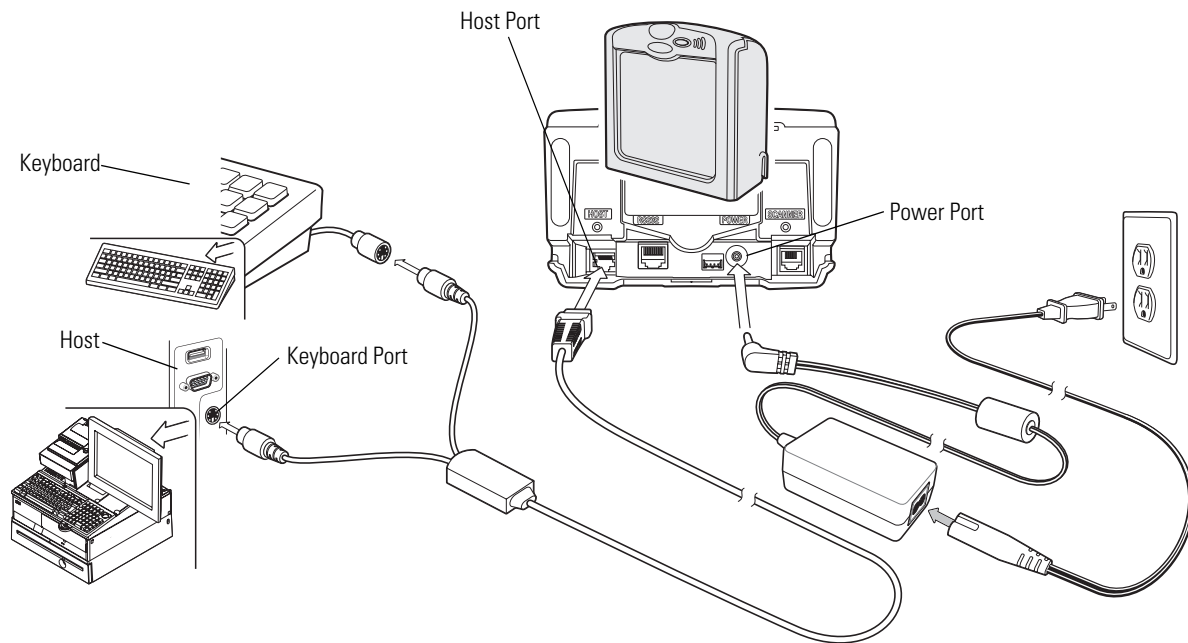

Figure 5-1. Keyboard Wedge Connection Without Peripherals - Power Supplied Externally

1. Switch off the host and unplug the keyboard connector.
2. Attach the modular connector of the Y-cable to the host port on the scanner.
3. Connect the round male DIN host connector of the Y-cable to the keyboard port on the host.
4. Connect the round female DIN keyboard connector of the Y-cable to the keyboard connector.
5. Connect the peripherals, if any, to their respective ports (see [Figure 5-2](#)).
6. Connect the power supply to the scanner's power port.
7. Ensure that all connections are secure.
8. Turn on the host system.
9. Scan the appropriate bar codes in this chapter or use 123Scan to configure the scanner.



Interface cables vary depending on configuration. The connectors may be different from the examples illustrated, but the steps to connect the scanner are the same. See [Chapter 1, Getting Started](#) for connection information.

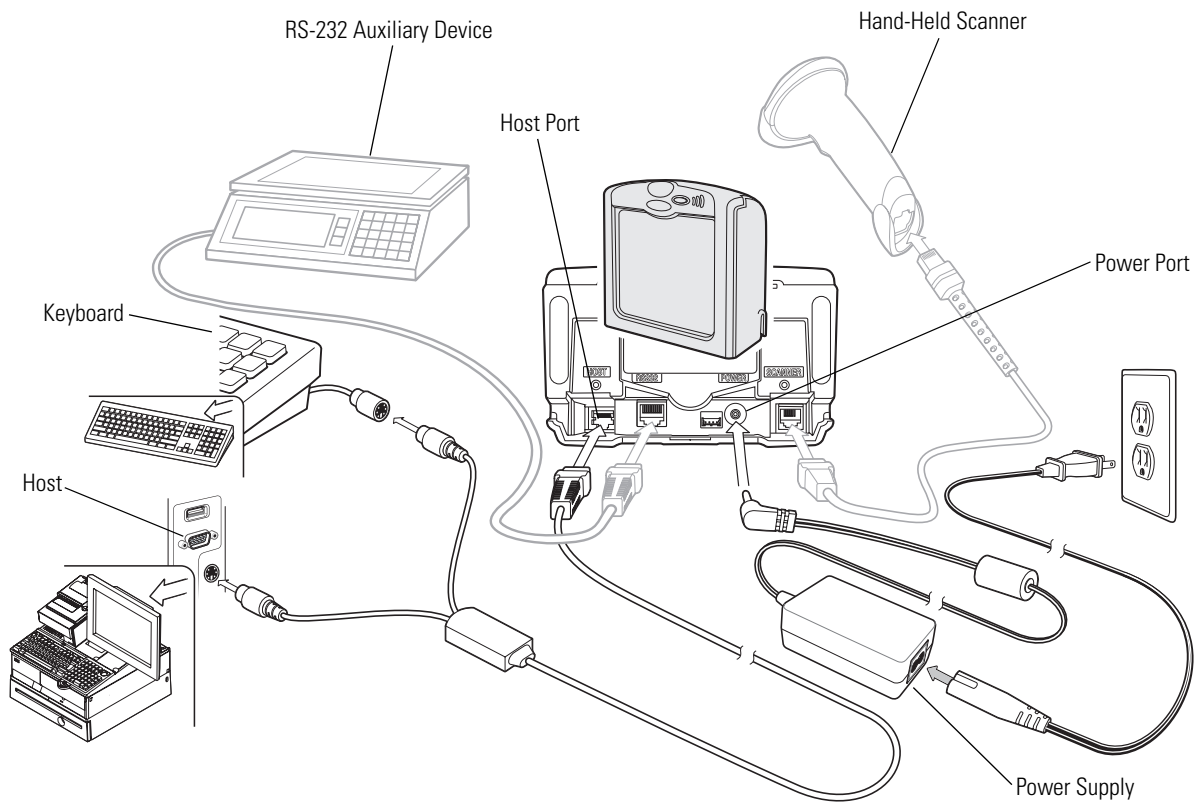
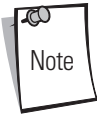

Figure 5-2. Keyboard Wedge Connection with Peripherals - Power Supplied Externally

Keyboard Wedge Default Parameters

Table 5-1 lists the defaults for Keyboard Wedge host parameters. To change any option, scan the appropriate bar code(s) beginning in *Keyboard Wedge Host Types* on page 5-7.



Note

Scanning parameter setting bar codes with the primary scanner also changes settings on the auxiliary scanner.



Note

See *Appendix A, Standard Default Parameters* for all user preferences, hosts, symbologies, and miscellaneous default parameters.

Table 5-1. Keyboard Wedge Host Default Table

Parameter	Default	Page Number
Keyboard Wedge Host Parameters		
Keyboard Wedge Host Type	IBM PC/AT & IBM PC Compatibles ¹	5-7
Country Types (Country Codes)	North American	5-9
Ignore Unknown Characters	Send Bar Codes	5-14
Keystroke Delay	No Delay	5-15
Intra-Keystroke Delay	Disable	5-17
Alternate Numeric Keypad Emulation	Disable	5-18
Caps Lock On	Disable	5-19
Caps Lock Override	Disable	5-20
Convert Wedge Data	No Convert	5-21
Function Key Mapping	Disable	5-23
FN1 Substitution	Disable	5-24
Send Make Break	Disable	5-25
¹ User selection is required to configure this interface and this is the most common selection.		

Keyboard Wedge Host Types

Select the keyboard wedge host by scanning one of the following bar codes.

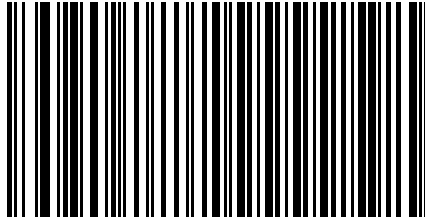

IBM PC/AT & IBM PC Compatibles¹

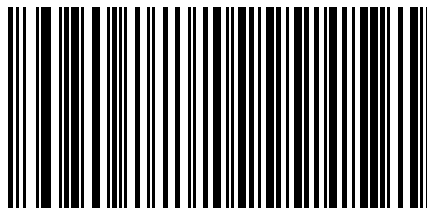

IBM PS/2 (Model 30)



¹User selection is required to configure this interface and this is the most common selection.

Keyboard Wedge Host Types (continued)

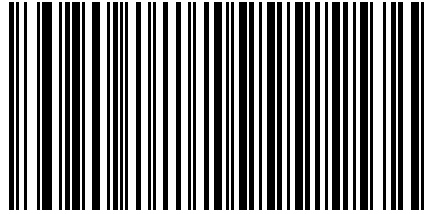

IBM AT NOTEBOOK

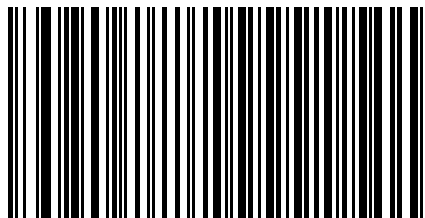

NCR 7052

Keyboard Wedge Country Types (Country Codes)

Scan the bar code corresponding to the keyboard type. If the particular keyboard type is not listed, see [Alternate Numeric Keypad Emulation on page 5-18](#).

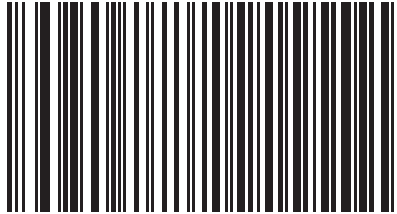

***North American**

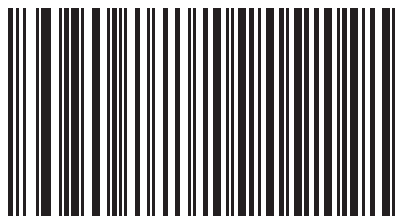

German Windows

Keyboard Wedge Country Types (continued)

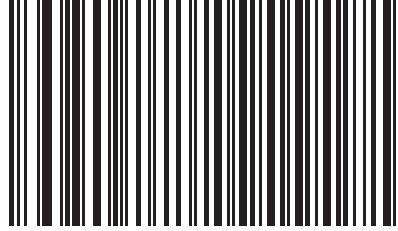

French Windows



French Canadian Win 95/98

Keyboard Wedge Country Types (continued)

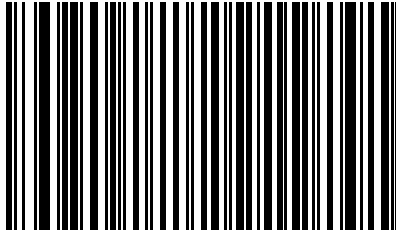

French Canadian Windows XP/2000

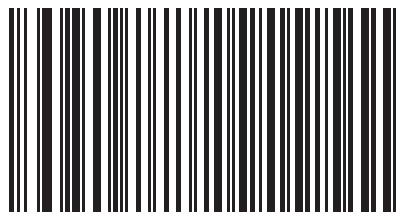

Spanish Windows

Keyboard Wedge Country Types (continued)

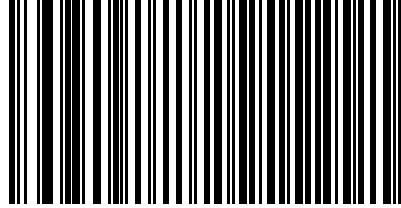

Italian Windows

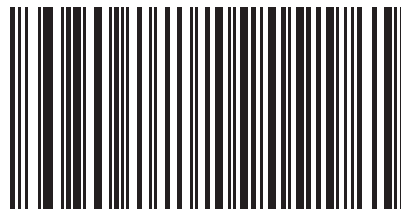

Swedish Windows

Keyboard Wedge Country Types (continued)

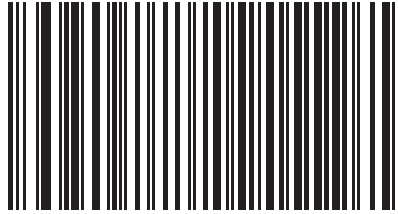

UK English Windows

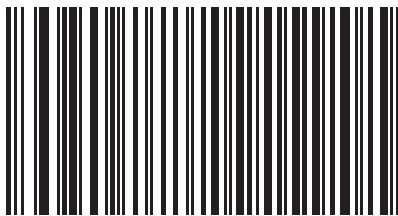

Japanese Windows

Keyboard Wedge Country Types (continued)

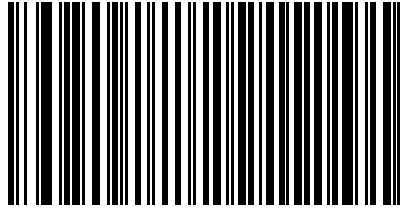

Brazilian/Portuguese Windows

Ignore Unknown Characters

Unknown characters are characters the host does not recognize. When **Send Bar Codes With Unknown Characters** is selected, all bar code data is sent except for unknown characters, and no error beeps sound on the scanner. When **Do Not Send Bar Codes With Unknown Characters** is selected, bar code data is sent up to the first unknown character and then four (error) beeps sound on the scanner.



***Send Bar Codes With Unknown Characters**

Ignore Unknown Characters (continued)

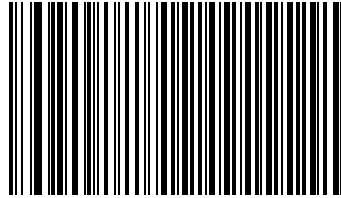

Do Not Send Bar Codes With Unknown Characters

Keystroke Delay

This is the delay in milliseconds between emulated keystrokes. Scan a bar code below to increase the delay when hosts require a slower transmission of data.

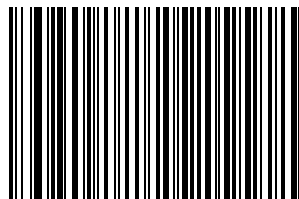

*** No Delay**

Keystroke Delay (continued)

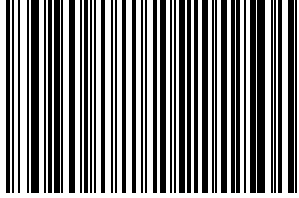

Medium Delay (20 msec)

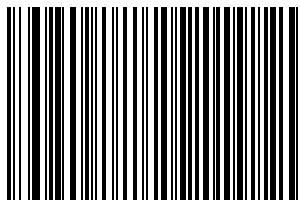

Long Delay (40 msec)

Intra-Keystroke Delay

Enable this to insert an additional delay between each emulated key depression and release. This sets the Keystroke Delay parameter to a minimum of 5 msec as well.

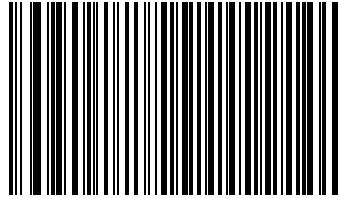

Enable

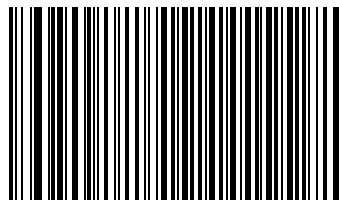

***Disable**

Alternate Numeric Keypad Emulation

This allows emulation of most other country keyboard types not listed in [Keyboard Wedge Country Types \(Country Codes\) on page 5-9](#) in a Microsoft operating system environment.

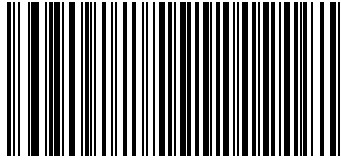

Enable Alternate Numeric Keypad

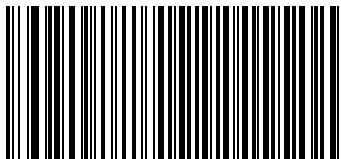

***Disable Alternate Numeric Keypad**

Caps Lock On

When enabled, the scanner emulates keystrokes as if the Caps Lock key is always pressed.

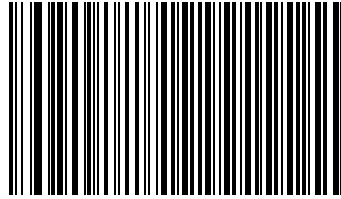

Enable Caps Lock On

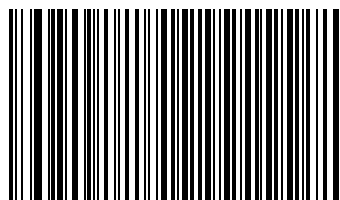

***Disable Caps Lock On**

Caps Lock Override

When enabled, on AT or AT Notebook hosts, the keyboard ignores the state of the Caps Lock key. Therefore, an 'A' in the bar code is sent as an 'A' regardless of the state of the keyboard's Caps Lock key.

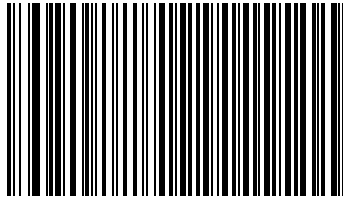

Enable Caps Lock Override

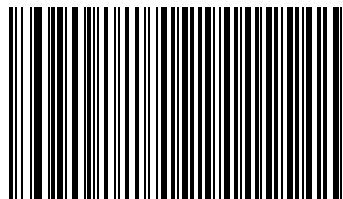

***Disable Caps Lock Override**



If both Caps Lock On and Caps Lock Override are enabled, Caps Lock Override takes precedence.

Convert Wedge Data

When enabled, the scanner converts all bar code data to the selected case.

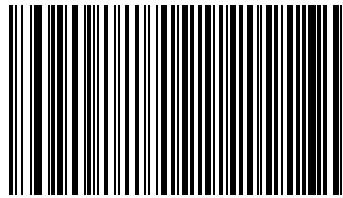

Convert to Upper Case

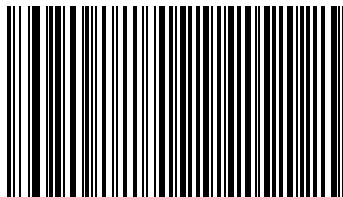

Convert to Lower Case

Convert Wedge Data (continued)

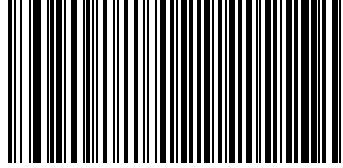

***No Convert**

Function Key Mapping

ASCII values under 32 are normally sent as a control-key sequences (see [Table 7-2 on page 7-24](#)). Enable this parameter to send the keys in bold in place of the standard key mapping. Items that do not have a bold entry remain the same whether or not this parameter is enabled.

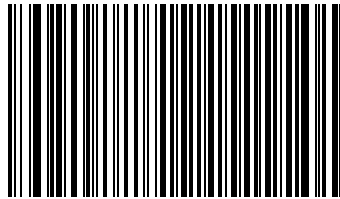

Enable

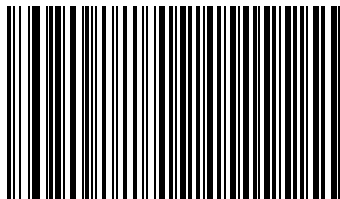

***Disable**

FN1 Substitution

Enable this to replace any FN1 characters in an EAN 128 bar code with a selected Key Category and Key Value (see [FN1 Substitution Values on page 14-6](#)).

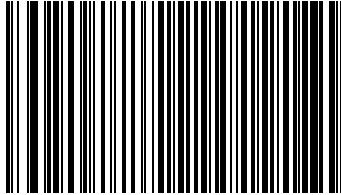

Enable

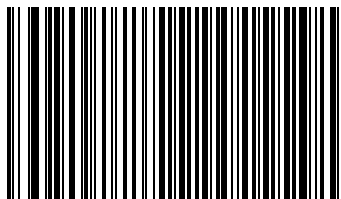

***Disable**

Send Make Break

When enabled, the scan codes for releasing a key are not sent.

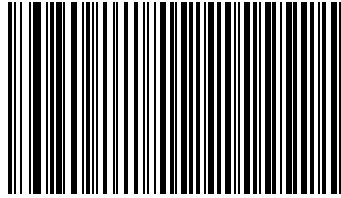

***Send Make and Break Scan Codes**

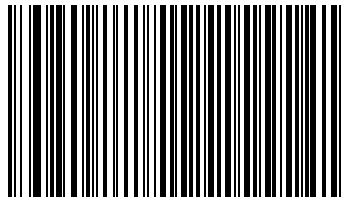

Send Make Scan Code Only

OnKeyboard Maps

The following keyboard maps are provided for prefix/suffix keystroke parameters. To program the prefix/suffix values, see the bar codes on page 14-5.

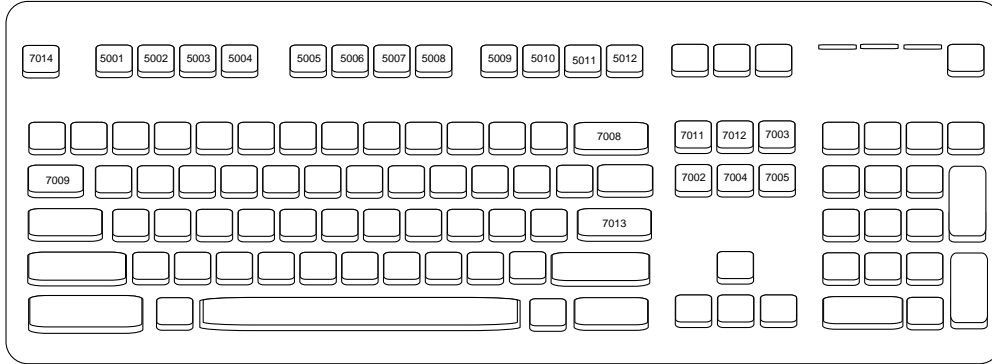

Figure 5-3. IBM PS2 Type Keyboard

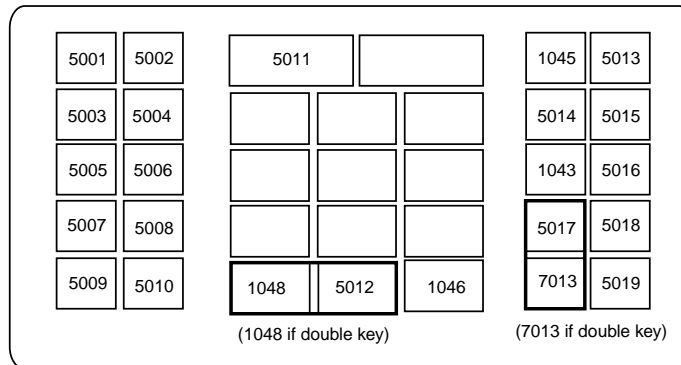

Figure 5-4. NCR 7052 32-Key

OnKeyboard Maps (continued)

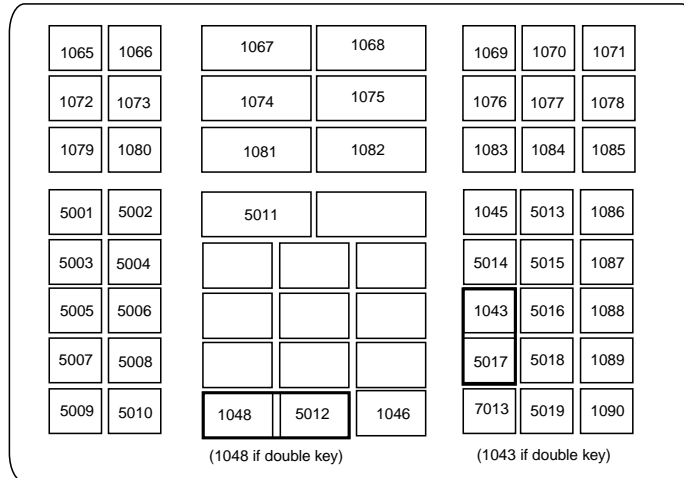
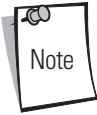

Figure 5-5. NCR 7052 58-Key

ASCII Character Set



Code 39 Full ASCII interprets the bar code special character (\$ + % /) preceding a Code 39 character and assigns an ASCII character value to the pair. For example, when Code 39 Full ASCII is enabled and a **+B** is scanned, it is interpreted as **b,%J** as **?**, and **%V** as **@**. Scanning **ABC%I** outputs the keystroke equivalent of **ABC >**.

Table 5-2. Keyboard Wedge ASCII Character Set

ASCII Value	Full ASCII Code 39 Encoded Character	Keystroke
1001	\$A	CTRL A
1002	\$B	CTRL B
1003	\$C	CTRL C
1004	\$D	CTRL D
1005	\$E	CTRL E
1006	\$F	CTRL F
1007	\$G	CTRL G
1008	\$H	CTRL H/ BACKSPACE ¹
1009	\$I	CTRL I/ HORIZONTAL TAB ¹
1010	\$J	CTRL J
1011	\$K	CTRL K
1012	\$L	CTRL L
1013	\$M	CTRL M/ ENTER ¹
1014	\$N	CTRL N
1015	\$O	CTRL O
1016	\$P	CTRL P
1017	\$Q	CTRL Q
1018	\$R	CTRL R
1019	\$S	CTRL S
1020	\$T	CTRL T
1021	\$U	CTRL U
1022	\$V	CTRL V
1023	\$W	CTRL W
1024	\$X	CTRL X
1025	\$Y	CTRL Y
1026	\$Z	CTRL Z
1027	%A	CTRL [/ESC ¹
1028	%B	CTRL \

¹The keystroke in bold is sent only if the "Function Key Mapping" is enabled. Otherwise, the unbolded keystroke is sent.

Table 5-2. Keyboard Wedge ASCII Character Set (Continued)

ASCII Value	Full ASCII Code 39 Encoded Character	Keystroke
1029	%C	CTRL]
1030	%D	CTRL 6
1031	%E	CTRL -
1032	Space	Space
1033	/A	!
1034	/B	"
1035	/C	#
1036	/D	\$
1037	/E	%
1038	/F	&
1039	/G	'
1040	/H	(
1041	/I)
1042	/J	*
1043	/K	+
1044	/L	,
1045	-	-
1046	.	.
1047	/O	/
1048	0	0
1049	1	1
1050	2	2
1051	3	3
1052	4	4
1053	5	5
1054	6	6
1055	7	7
1056	8	8
1057	9	9
1058	/Z	:
1059	%F	;
1060	%G	<
1061	%H	=

¹The keystroke in bold is sent only if the "Function Key Mapping" is enabled. Otherwise, the unbolded keystroke is sent.

Table 5-2. Keyboard Wedge ASCII Character Set (Continued)

ASCII Value	Full ASCII Code 39 Encoded Character	Keystroke
1062	%I	>
1063	%J	?
1064	%V	@
1065	A	A
1066	B	B
1067	C	C
1068	D	D
1069	E	E
1070	F	F
1071	G	G
1072	H	H
1073	I	I
1074	J	J
1075	K	K
1076	L	L
1077	M	M
1078	N	N
1079	O	O
1080	P	P
1081	Q	Q
1082	R	R
1083	S	S
1084	T	T
1085	U	U
1086	V	V
1087	W	W
1088	X	X
1089	Y	Y
1090	Z	Z
1091	%K	[
1092	%L	\
1093	%M]
1094	%N	^

¹The keystroke in bold is sent only if the "Function Key Mapping" is enabled. Otherwise, the unbolded keystroke is sent.

Table 5-2. Keyboard Wedge ASCII Character Set (Continued)

ASCII Value	Full ASCII Code 39 Encoded Character	Keystroke
1095	%O	—
1096	%W	'
1097	+A	a
1098	+B	b
1099	+C	c
1100	+D	d
1101	+E	e
1102	+F	f
1103	+G	g
1104	+H	h
1105	+I	i
1106	+J	j
1107	+K	k
1108	+L	l
1109	+M	m
1110	+N	n
1111	+O	o
1112	+P	p
1113	+Q	q
1114	+R	r
1115	+S	s
1116	+T	t
1117	+U	u
1118	+V	v
1119	+W	w
1120	+X	x
1121	+Y	y
1122	+Z	z
1123	%P	{
1124	%Q	
1125	%R	}
1126	%S	~
¹ The keystroke in bold is sent only if the "Function Key Mapping" is enabled. Otherwise, the unbolded keystroke is sent.		

Table 5-3. Keyboard Wedge ALT Key Character Set

ALT Keys	Keystroke
2065	ALT A
2066	ALT B
2067	ALT C
2068	ALT D
2069	ALT E
2070	ALT F
2071	ALT G
2072	ALT H
2073	ALT I
2074	ALT J
2075	ALT K
2076	ALT L
2077	ALT M
2078	ALT N
2079	ALT O
2080	ALT P
2081	ALT Q
2082	ALT R
2083	ALT S
2084	ALT T
2085	ALT U
2086	ALT V
2087	ALT W
2088	ALT X
2089	ALT Y
2090	ALT Z

Table 5-4. Keyboard Wedge GUI Key Character Set

GUI Keys	Keystrokes
3000	Right Control Key
3048	GUI 0
3049	GUI 1
3050	GUI 2
3051	GUI 3
3052	GUI 4
3053	GUI 5
3054	GUI 6
3055	GUI 7
3056	GUI 8
3057	GUI 9
3065	GUI A
3066	GUI B
3067	GUI C
3068	GUI D
3069	GUI E
3070	GUI F
3071	GUI G
3072	GUI H
3073	GUI I
3074	GUI J
3075	GUI K
3076	GUI L
3077	GUI M
3078	GUI N
3079	GUI O
3080	GUI P
3081	GUI Q
3082	GUI R
3083	GUI S
3084	GUI T
3085	GUI U
3086	GUI V
3087	GUI W
3088	GUI X
3089	GUI Y
3090	GUI Z

Table 5-5. Keyboard Wedge F Key Character Set

F Keys	Keystroke
5001	F1
5002	F2
5003	F3
5004	F4
5005	F5
5006	F6
5007	F7
5008	F8
5009	F9
5010	F10
5011	F11
5012	F12
5013	F13
5014	F14
5015	F15
5016	F16
5017	F17
5018	F18
5019	F19
5020	F20
5021	F21
5022	F22
5023	F23
5024	F24

Table 5-6. Keyboard Wedge Numeric Keypad Character Set

Numeric Keypad	Keystroke
6042	*
6043	+
6044	undefined
6045	-
6046	.
6047	/
6048	0
6049	1
6050	2
6051	3
6052	4
6053	5
6054	6
6055	7
6056	8
6057	9
6058	Enter
6059	Num Lock

Table 5-7. Keyboard Wedge Extended Keypad Character Set

Extended Keypad	Keystroke
7001	Break
7002	Delete
7003	Pg Up
7004	End
7005	Pg Dn
7006	Pause
7007	Scroll Lock
7008	Backspace
7009	Tab
7010	Print Screen
7011	Insert
7012	Home
7013	Enter
7014	Escape
7015	Up Arrow
7016	Dn Arrow
7017	Left Arrow
7018	Right Arrow

6

RS-232 Host Interface



Introduction	6-3
Connecting an RS-232 Interface	6-4
RS-232 Default Parameters	6-6
RS-232 Host Parameters	6-7
RS-232 Host Types	6-9
Baud Rate	6-13
Parity	6-17
Check Receive Errors	6-20
Hardware Handshaking	6-21
Software Handshaking	6-24
Host Serial Response Time-out	6-26
RTS Line State	6-29
Stop Bit Select	6-30
Data Bits	6-31
Beep on <BEL>	6-32
Intercharacter Delay	6-33
Nixdorf Beep/LED Options	6-35
Ignore Unknown Characters	6-37
ASCII / Character Set	6-38

Introduction

This chapter provides information for setting up the scanner with an RS-232 host. Use the RS-232 interface to attach the scanner to point-of-sale devices, host computers, or other devices with an available RS-232 port (e.g., com port). This scanner uses TTL RS-232 levels to interface with all PC's without additional hardware.



Particularly noisy electrical environments may require a cable with an RS-232 transceiver. To obtain this cable, contact the Global Customer Interaction Center.

If the particular host is not listed in [Table 6-2](#), set the communication parameters to match the host device. See the documentation for the host device.

Throughout the programming bar code menus, asterisks (*) indicate default values.

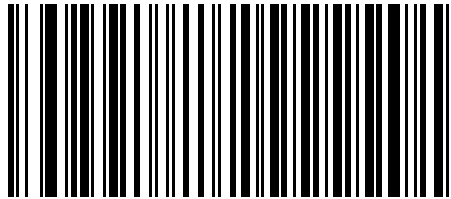

* Indicates Default * **Baud Rate 9600** Feature/Option

Connecting an RS-232 Interface

There are several possible configurations for connecting to an RS-232 host. The scanner connects directly to the host computer.

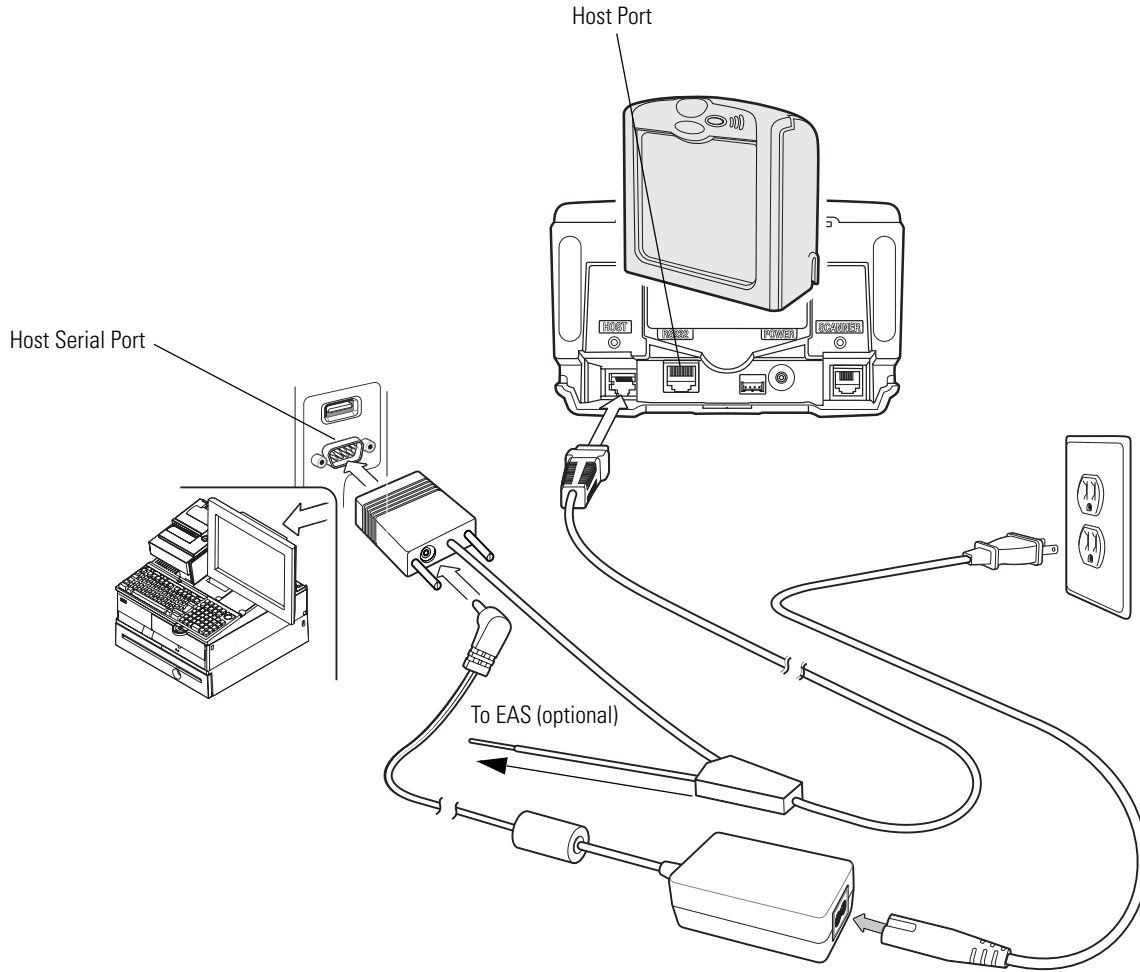

Figure 6-1. RS-232 Connection Without Peripherals - Power Supplied Externally

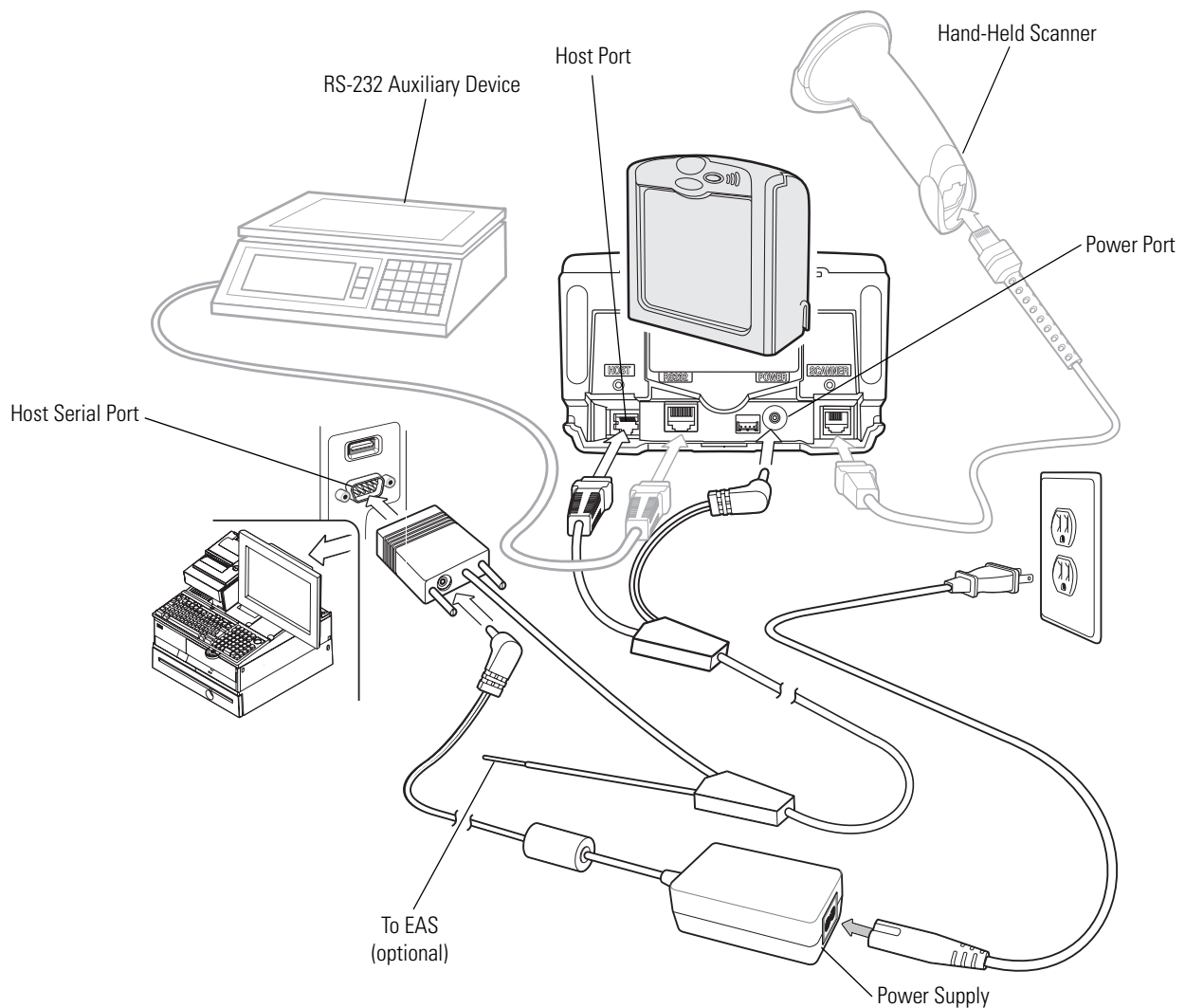

Figure 6-2. RS-232 Connection with Peripherals - Power Supplied Externally

1. Connect the RS-232 interface cable to the host port of the scanner.
2. Connect the other end of the interface cable to the serial port on the host.
3. Connect the peripherals, if any, to their respective ports (see [Figure 6-2](#)).
4. Connect the power supply.
5. Scan appropriate bar codes in this chapter or use 123Scan to match the host settings.



Interface cables vary depending on configuration. The connectors may be different from the examples illustrated, but the steps to connect the scanner are the same. See [Chapter 1, Getting Started](#) for connection information.

RS-232 Default Parameters

Table 6-1 lists the defaults for RS-232 host parameters. To change any option, scan the appropriate bar code(s) beginning in [RS-232 Host Parameters on page 6-7](#).

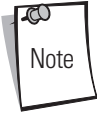

Note

Scanning parameter setting bar codes with the primary scanner also changes settings on the auxiliary scanner.



Note

See [Appendix A, Standard Default Parameters](#) for all user preferences, hosts, symbologies, and miscellaneous default parameters.

Table 6-1. RS-232 Host Default Table

Parameter	Default	Page Number
RS-232 Host Parameters		
RS-232 Host Types	Standard ¹	6-9
Baud Rate	9600	6-13
Parity	None	6-17
Check Receive Errors	Enable	6-20
Hardware Handshaking	None	6-21
Software Handshaking	None	6-24
Host Serial Response Time-out	2 Sec	6-26
RTS Line State	Low RTS	6-29
Stop Bit Select	1	6-30
Data Bits	8-Bit	6-31
Beep on <BEL>	Disable	6-32
Intercharacter Delay	0 msec	6-33
Nixdorf Beep/LED Option	Normal Operation	6-35
Ignore Unknown Characters	Send Bar Codes	6-37
¹ User selection is required to configure this interface and this is the most common selection.		

RS-232 Host Parameters

Various RS-232 hosts are set up with their own parameter default settings. Selecting the ICL, Fujitsu, Wincor-Nixdorf Mode A, Wincor-Nixdorf Mode B, Olivetti, Omron, or terminal sets the defaults listed in [Table 6-2](#).

Table 6-2. Terminal Specific RS-232

Parameter	Standard (Default)	ICL	Fujitsu	Wincor-Nixdorf Mode A	Wincor-Nixdorf Mode B/OPOS	Olivetti	Omron
Transmit Code ID	No	Yes	Yes	Yes	Yes	Yes	Yes
Data Transmission Format	Data as is	Data/Suffix	Data/Suffix	Data/Suffix	Data/Suffix	Prefix/Data/Suffix	Data/Suffix
Suffix	CR/LF (7013)	CR (1013)	CR (1013)	CR (1013)	CR (1013)	ETX (1002)	CR (1013)
Baud Rate	9600	9600	9600	9600	9600	9600	9600
Parity	None	Even	None	Odd	Odd	Even	None
Hardware Handshaking	None	RTS/CTS Option 3	None	RTS/CTS Option 3	RTS/CTS Option 3	None	None
Software Handshaking	None	None	None	None	None	Ack/Nak	None
Serial Response Time-out	2 Sec.	9.9 Sec.	2 Sec.	9.9 Sec.	9.9 Sec.	9.9 Sec.	9.9 Sec.
Stop Bit Select	One	One	One	One	One	One	One
ASCII Format	8-Bit	8-Bit	8-Bit	8-Bit	8-Bit	7-Bit	8-Bit
Beep On <BEL>	Disable	Disable	Disable	Disable	Disable	Disable	Disable
RTS Line State	Low	High	Low	Low	Low = No data to send	Low	High
Prefix	None	None	None	None	None	STX (1003)	None

*In the Nixdorf Mode B, if CTS is Low, scanning is disabled. When CTS is High, the user can scan bar codes.

**If Nixdorf Mode B is scanned without the scanner connected to the proper host, it may appear unable to scan. If this happens, scan a different RS-232 host type within 5 seconds of cycling power to the scanner.

Selecting the ICL, Fujitsu, Wincor-Nixdorf Mode A, Wincor-Nixdorf Mode B, OPOS, JPOS terminal enables the transmission of code ID characters listed in [Table 6-3](#). These code ID characters are not programmable and are separate from the Transmit Code ID feature. Do not enable the Transmit Code ID feature for these terminals.

Table 6-3. Terminal Specific Code ID Characters

	ICL	Fujitsu	Wincor-Nixdorf Mode A	Wincor-Nixdorf Mode B/OPOS	Olivetti	Omron
UPC-A	A	A	A	A	A	A
UPC-E	E	E	C	C	C	E
EAN-8/JAN-8	FF	FF	B	B	B	FF
EAN-13/JAN-13	F	F	A	A	A	F
Code 39	C <len>	None	M	M	M <len>	C <len>
Codabar	N <len>	None	N	N	N <len>	N <len>
Code 128	L <len>	None	K	K	K <len>	L <len>
I 2 of 5	I <len>	None	I	I	I <len>	I <len>
Code 93	None	None	L	L	L <len>	None
D 2 of 5	H <len>	None	H	H	H <len>	H <len>
UCC/EAN 128	L <len>	None	P	P	P <len>	L <len>
MSI	None	None	O	O	O <len>	None
Bookland EAN	F	F	A	A	A	F
IATA	H <len>	None	H	H	None	None
Unlisted Bar Codes	None	None	None	None	None	None
RSS						

RS-232 Host Types

To select an RS-232 host interface, scan one of the following bar codes.

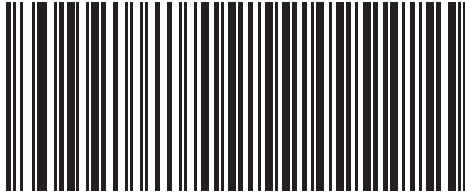

Standard RS-232¹



ICL RS-232



¹User selection is required to configure this interface and this is the most common selection.

RS-232 Host Types (continued)

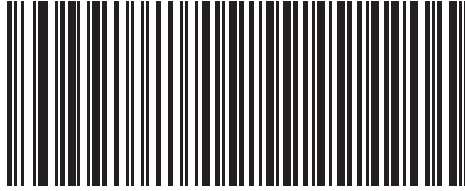

Wincor-Nixdorf RS-232 Mode A

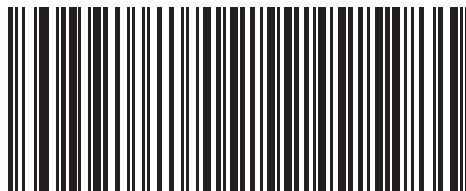

Wincor-Nixdorf RS-232 Mode B

RS-232 Host Types (continued)

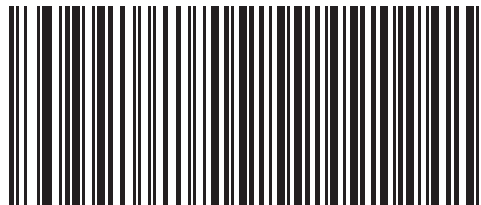

Fujitsu RS-232

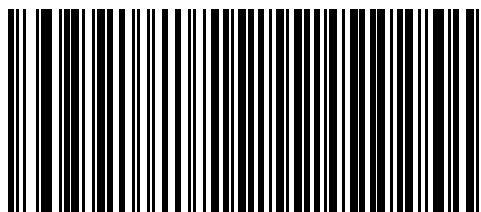

Olivetti ORS4500

RS-232 Host Types (continued)

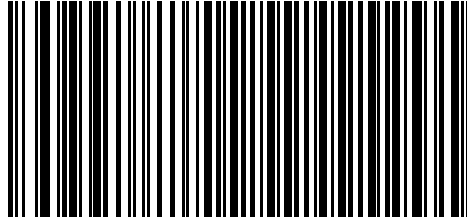

Omron

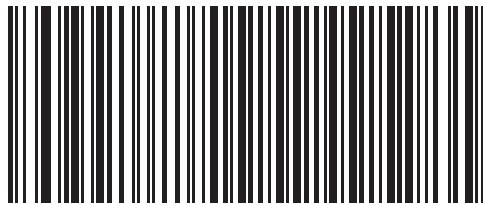

OPOS/JPOS

Baud Rate

Baud rate is the number of bits of data transmitted per second. Select the baud rate setting to match the baud rate setting of the host device. Otherwise, data may not reach the host device or may reach it in distorted form.

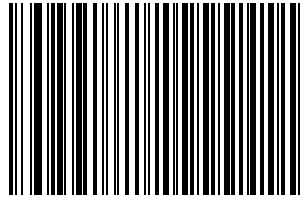

Baud Rate 600

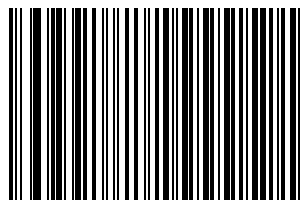

Baud Rate 1200

Baud Rate (continued)

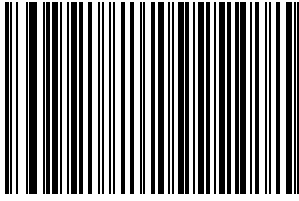

Baud Rate 2400

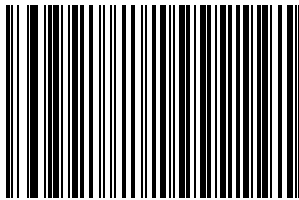

Baud Rate 4800

Baud Rate (continued)

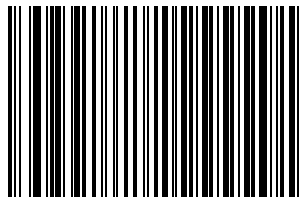

***Baud Rate 9600**

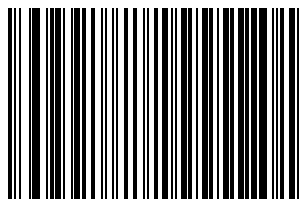

Baud Rate 19,200

Baud Rate (continued)

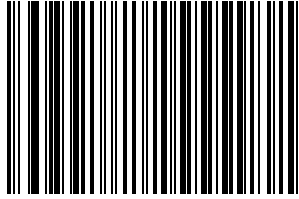

Baud Rate 38,400

Parity

A parity check bit is the most significant bit of each ASCII coded character. Select the parity type according to host device requirements.

Select **Odd** parity and the parity bit value is set to 0 or 1, based on data, to ensure that an odd number of 1 bits are contained in the coded character.

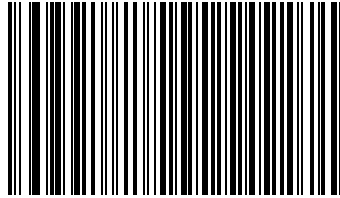

Odd

Select **Even** parity and the parity bit value is set to 0 or 1, based on data, to ensure that an even number of 1 bits are contained in the coded character.

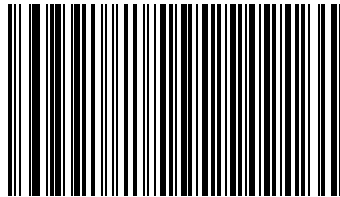

Even

Parity (continued)

Select **Mark** parity and the parity bit is always 1.

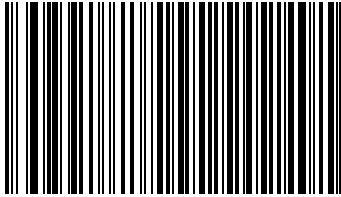

Mark

Select **Space** parity and the parity bit is always 0.

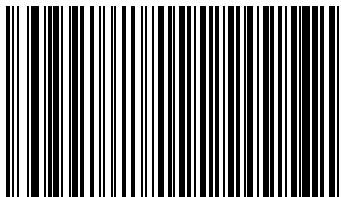

Space

Parity (continued)

Select **None** when no parity bit is required.

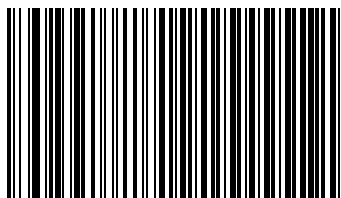

***None**

Check Receive Errors

Select whether or not the parity, framing, and overrun of received characters are checked. The parity value of received characters is verified against the parity parameter selected above.

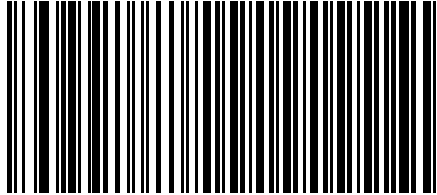

***Check For Received Errors**

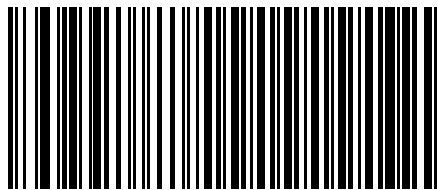

Do Not Check For Received Errors

Hardware Handshaking

The data interface consists of an RS-232 port designed to operate either with or without the hardware handshaking lines, *Request to Send (RTS)*, and *Clear to Send (CTS)*.

If Standard RTS/CTS handshaking is not selected, scan data is transmitted as it becomes available. If Standard RTS/CTS handshaking is selected, scan data is transmitted according to the following sequence:

- The scanner reads the CTS line for activity. If CTS is asserted, the scanner waits up to 2 seconds for the host to negate the CTS line. If, after 2 seconds (default), the CTS line is still asserted, the scanner sounds a transmit error, and any scanned data is lost.
- When the CTS line is negated, the scanner asserts the RTS line and waits up to 2 seconds for the host to assert CTS. When the host asserts CTS, data is transmitted. If, after 2 seconds (default), the CTS line is not asserted, the scanner sounds a transmit error, and discards the data.
- When data transmission is complete, the scanner negates RTS 10 msec after sending the last character.
- The host should respond by negating CTS. The scanner checks for a negated CTS upon the next transmission of data.

During the transmission of data, the CTS line should be asserted. If CTS is deasserted for more than 50 ms between characters, the transmission is aborted, the scanner sounds a transmission error, and the data is discarded.

If the above communications sequence fails, the scanner issues an error indication. In this case, the data is lost and must be rescanned.

If Hardware Handshaking and Software Handshaking are both enabled, Hardware Handshaking takes precedence.



The DTR signal is jumpered to the active state.

None

Scan the bar code below if no Hardware Handshaking is desired.

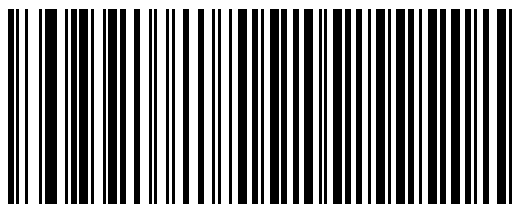

*None

Standard RTS/CTS

Scan the bar code below to select Standard RTS/CTS Hardware Handshaking.

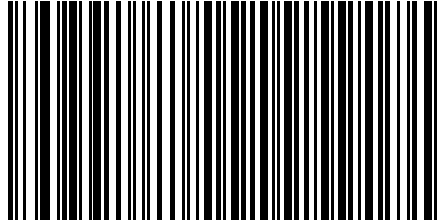

Standard RTS/CTS

RTS/CTS Option 1

When RTS/CTS Option 1 is selected, the scanner asserts RTS before transmitting and ignores the state of CTS. The scanner de-asserts RTS when the transmission is complete.

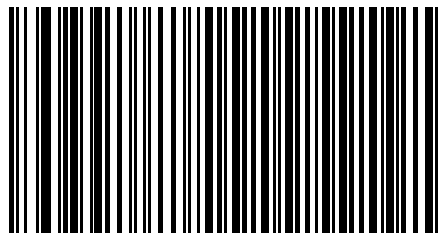

RTS/CTS Option 1

RTS/CTS Option 2

When Option 2 is selected, RTS is always high or low (user-programmed logic level). However, the scanner waits for CTS to be asserted before transmitting data. If CTS is not asserted within 2 seconds (default), the scanner issues an error indication and discards the data.

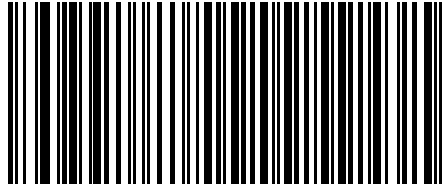

RTS/CTS Option 2

RTS/CTS Option 3

When Option 3 is selected, the scanner asserts RTS prior to any data transmission, regardless of the state of CTS. The scanner waits up to 2 seconds (default) for CTS to be asserted. If CTS is not asserted during this time, the scanner issues an error indication and discards the data. The scanner de-asserts RTS when transmission is complete.

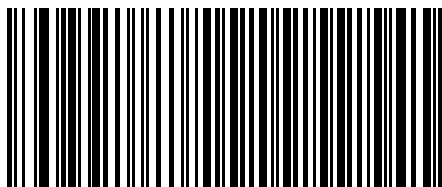

RTS/CTS Option 3

Software Handshaking

This parameter offers control of the data transmission process in addition to, or instead of, that offered by hardware handshaking. There are five options.

If Software Handshaking and Hardware Handshaking are both enabled, Hardware Handshaking takes precedence.

None

When this option is selected, data is transmitted immediately.

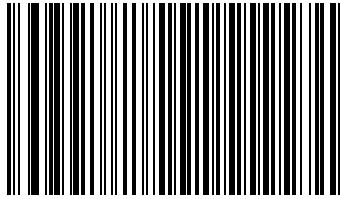

***None**

ACK/NAK

When this option is selected, after transmitting data, the scanner expects either an ACK or NAK response from the host. When a NAK is received, the scanner transmits the same data again and waits for either an ACK or NAK. After three unsuccessful attempts to send data when NAKs are received, the scanner issues an error indication and discards the data.

The scanner waits up to the programmable Host Serial Response Time-out to receive an ACK or NAK. If the scanner does not get a response in this time, it issues an error indication and discards the data. There are no retries when a time-out occurs.

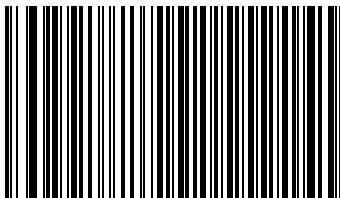

ACK/NAK

ENQ

When this option is selected, the scanner waits for an ENQ character from the host before transmitting data. If an ENQ is not received within the Host Serial Response Time-out, the scanner issues an error indication and discards the data. The host must transmit an ENQ character at least every Host Serial Response Time-out to prevent transmission errors.

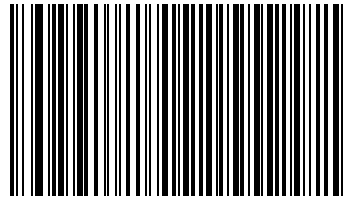

ENQ

ACK/NAK with ENQ

This combines the two previous options.

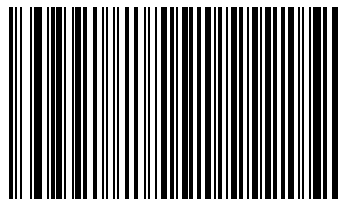

ACK/NAK with ENQ

XON/XOFF

An XOFF character turns the scanner transmission off until the scanner receives an XON character. There are two situations for XON/XOFF:

- XOFF is received before the scanner has data to send. When the scanner has data to send, it waits up to 2 seconds for an XON character before transmission. If the XON is not received within this time, the scanner issues an error indication and discards the data.
- XOFF is received during a transmission. Data transmission then stops after sending the current byte. When the scanner receives an XON character, it sends the rest of the data message. The scanner waits indefinitely for the XON.

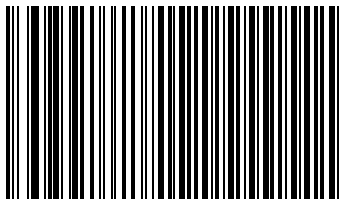

XON/XOFF

Host Serial Response Time-out

This parameter specifies how long the scanner waits for an ACK, NAK, or CTS before determining that a transmission error has occurred. This only applies when in one of the ACK/NAK Software Handshaking modes, or RTS/CTS Hardware Handshaking option.



*** Minimum: 2 Sec**

Host Serial Response Time-out (continued)

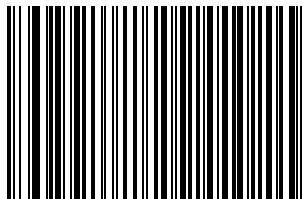

Low: 2.5 Sec

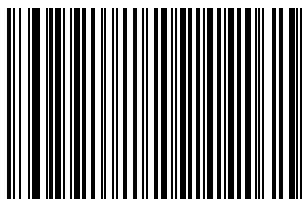

Medium: 5 Sec

Host Serial Response Time-out (continued)

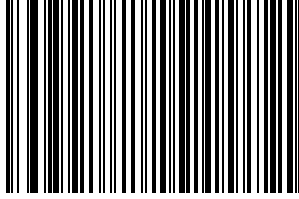

High: 7.5 Sec

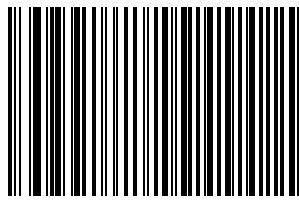

Maximum: 9.9 Sec

RTS Line State

This parameter sets the idle state of the Serial Host RTS line. Scan a bar code below to select **Low RTS** or **High RTS** line state.

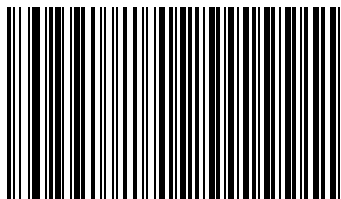

***Host: Low RTS**

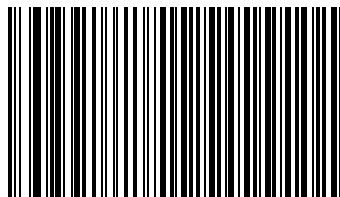

Host: High RTS

Stop Bit Select

The stop bit(s) at the end of each transmitted character marks the end of transmission of one character and prepares the receiving device for the next character in the serial data stream. The number of stop bits selected (one or two) depends on the number the receiving terminal is programmed to accommodate. Set the number of stop bits to match host device requirements.

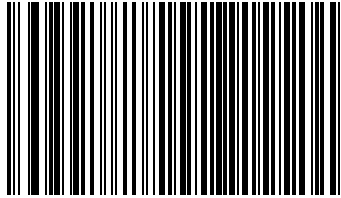

***1 Stop Bit**

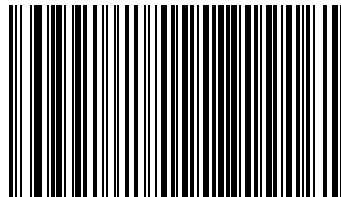

2 Stop Bits

Data Bits

This parameter allows the scanner to interface with devices requiring a 7-bit or 8-bit ASCII protocol.

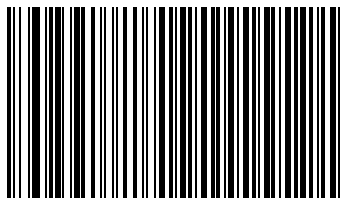

7-Bit

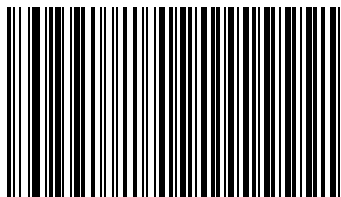

***8-Bit**

Beep on <BEL>

When this parameter is enabled, the scanner issues a beep when a <BEL> character is detected on the RS-232 serial line. <BEL> is issued to gain a user's attention to an illegal entry or other important event.

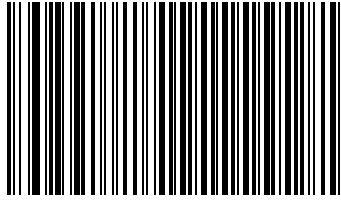

Beep On <BEL> Character (Enable)

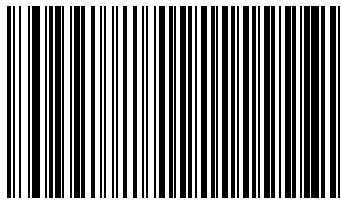

***Do Not Beep On <BEL> Character (Disable)**

Intercharacter Delay

This parameter specifies the intercharacter delay inserted between character transmissions.

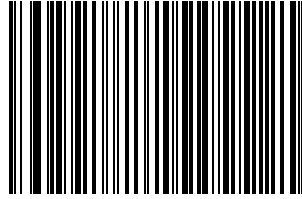

***Minimum: 0 msec**

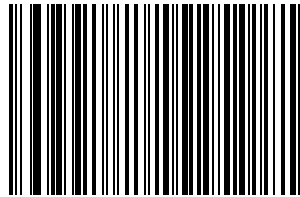

Low: 25 msec

Intercharacter Delay (continued)

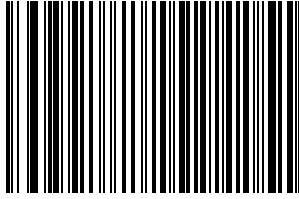

Medium: 50 msec

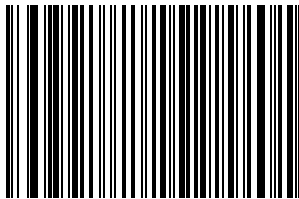

High: 75 msec

Intercharacter Delay (continued)

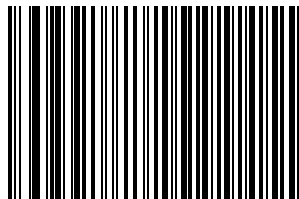

Maximum: 99 msec

Nixdorf Beep/LED Options

When Nixdorf Mode B is selected, this indicates when the scanner should beep and turn on its LED after a decode.

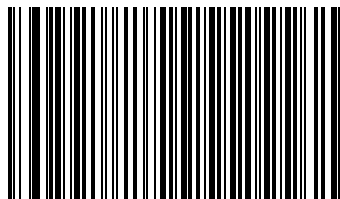

***Normal Operation
(Beep/LED immediately after decode)**

Nixdorf Beep/LED Options (continued)

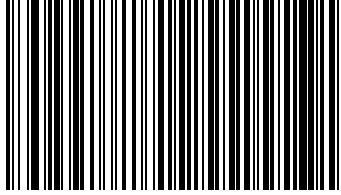

Beep/LED After Transmission

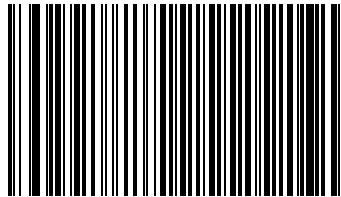

Beep/LED After CTS Pulse

Ignore Unknown Characters

Unknown characters are characters the host does not recognize. When **Send Bar Codes With Unknown Characters** is selected, all bar code data is send except for unknown characters, and no error beeps sound on the scanner. When **Do Not Send Bar Codes With Unknown Characters** is selected, bar code data is sent up to the first unknown character and then four (error) beeps sound on the scanner.

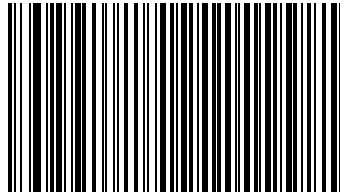

***Send Bar Code
(With Unknown Characters)**

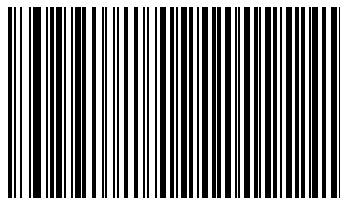

**Do Not Send Bar Codes
(With Unknown Characters)**

ASCII / Character Set

The values in [Table 6-4](#) can be assigned as prefixes or suffixes for ASCII character data transmission.

Table 6-4. ASCII Character Set

ASCII Value	Full ASCII Code 39 Encode Character	ASCII Character
1000	%U	NUL
1001	\$A	SOH
1002	\$B	STX
1003	\$C	ETX
1004	\$D	EOT
1005	\$E	ENQ
1006	\$F	ACK
1007	\$G	BELL
1008	\$H	BCKSPC
1009	\$I	HORIZ TAB
1010	\$J	LF/NW LN
1011	\$K	VT
1012	\$L	FF
1013	\$M	CR/ENTER
1014	\$N	SO
1015	\$O	SI
1016	\$P	DLE
1017	\$Q	DC1
1018	\$R	DC2
1019	\$S	DC3
1020	\$T	DC4
1021	\$U	NAK
1022	\$V	SYN
1023	\$W	ETB
1024	\$X	CAN
1025	\$Y	EM
1026	\$Z	SUB
1027	%A	ESC
1028	%B	FS
1029	%C	GS
1030	%D	RS
1031	%E	US
1032	Space	Space

Table 6-4. ASCII Character Set

ASCII Value	Full ASCII Code 39 Encode Character	ASCII Character
1033	/A	!
1034	/B	"
1035	/C	#
1036	/D	\$
1037	/E	%
1038	/F	&
1039	/G	'
1040	/H	(
1041	/I)
1042	/J	*
1043	/K	+
1044	/L	,
1045	-	-
1046	.	.
1047	/	/
1048	0	0
1049	1	1
1050	2	2
1051	3	3
1052	4	4
1053	5	5
1054	6	6
1057	7	7
1056	8	8
1057	9	9
1058	/Z	:
1059	%F	;
1060	%G	<
1061	%H	=
1062	%I	>
1063	%J	?
1064	%V	@
1065	A	A
1066	B	B
1067	C	C

Table 6-4. ASCII Character Set

ASCII Value	Full ASCII Code 39 Encode Character	ASCII Character
1068	D	D
1069	E	E
1070	F	F
1071	G	G
1072	H	H
1073	I	I
1074	J	J
1075	K	K
1076	L	L
1077	M	M
1078	N	N
1079	O	O
1080	P	P
1081	Q	Q
1082	R	R
1083	S	S
1084	T	T
1085	U	U
1086	V	V
1087	W	W
1088	X	X
1089	Y	Y
1090	Z	Z
1091	%K	[
1092	%L	\
1093	%M]
1094	%N	^
1095	%O	_
1096	%W	`
1097	+A	a
1098	+B	b
1099	+C	c
1100	+D	d
1101	+E	e
1102	+F	f

Table 6-4. ASCII Character Set

ASCII Value	Full ASCII Code 39 Encode Character	ASCII Character
1103	+G	g
1104	+H	h
1105	+I	i
1106	+J	j
1107	+K	k
1108	+L	l
1109	+M	m
1110	+N	n
1111	+O	o
1112	+P	p
1113	+Q	q
1114	+R	r
1115	+S	s
1116	+T	t
1117	+U	u
1118	+V	v
1119	+W	w
1120	+X	x
1121	+Y	y
1122	+Z	z
1123	%P	{
1124	%Q	
1125	%R	}
1126	%S	~
1127		Undefined
7013		ENTER

USB Interface

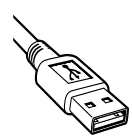

Introduction	7-3
Connecting a USB Interface	7-3
USB Default Parameters	7-6
USB Host Parameters	7-7
USB Device Type	7-7
USB Country Keyboard Types (Country Codes)	7-9
USB Keystroke Delay	7-14
USB CAPS Lock Override	7-16
USB Ignore Unknown Characters	7-17
Emulate Keypad	7-18
USB Keyboard FN1 Substitution	7-19
Function Key Mapping	7-20
Simulated Caps Lock	7-21
Convert Case	7-22
ASCII Character Set	7-24

Introduction

This chapter provides information on setting up the scanner with a USB host. The scanner attaches directly to a USB host computer.

If there are no peripherals included in the configuration and the host cable is less than 8.5' long, the host can power the scanner through the interface cable. If the configuration includes peripherals and/or the host cable is more than 8.5' long, an external power supply is necessary.

Throughout the programming bar code menus, asterisks (*) indicate default values.



Connecting a USB Interface

The scanner connects with USB-capable hosts including:

- Desktop PCs and Notebooks
- Apple™ iMac, G4, iBooks (North America only)
- IBM SurePOS terminals
- Sun, IBM, and other network computers that support more than one keyboard.

The following operating systems support the scanner through USB:

- Windows 98, 2000, ME, XP
- MacOS 8.5 and above
- IBM 4690 OS.

The scanner also interfaces with other USB hosts that support USB Human Interface Devices (HID). For more information on USB technology, hosts, and peripheral devices, visit www.symbol.com/usb.

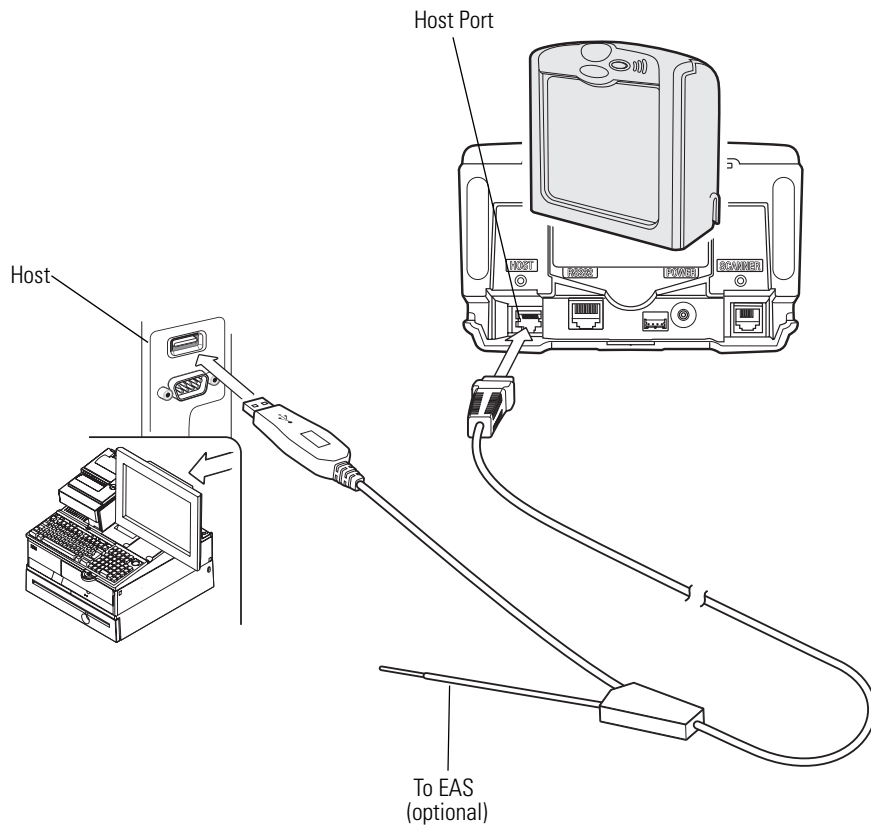

Figure 7-1. USB Connection Without Peripherals - Host Supplies Power

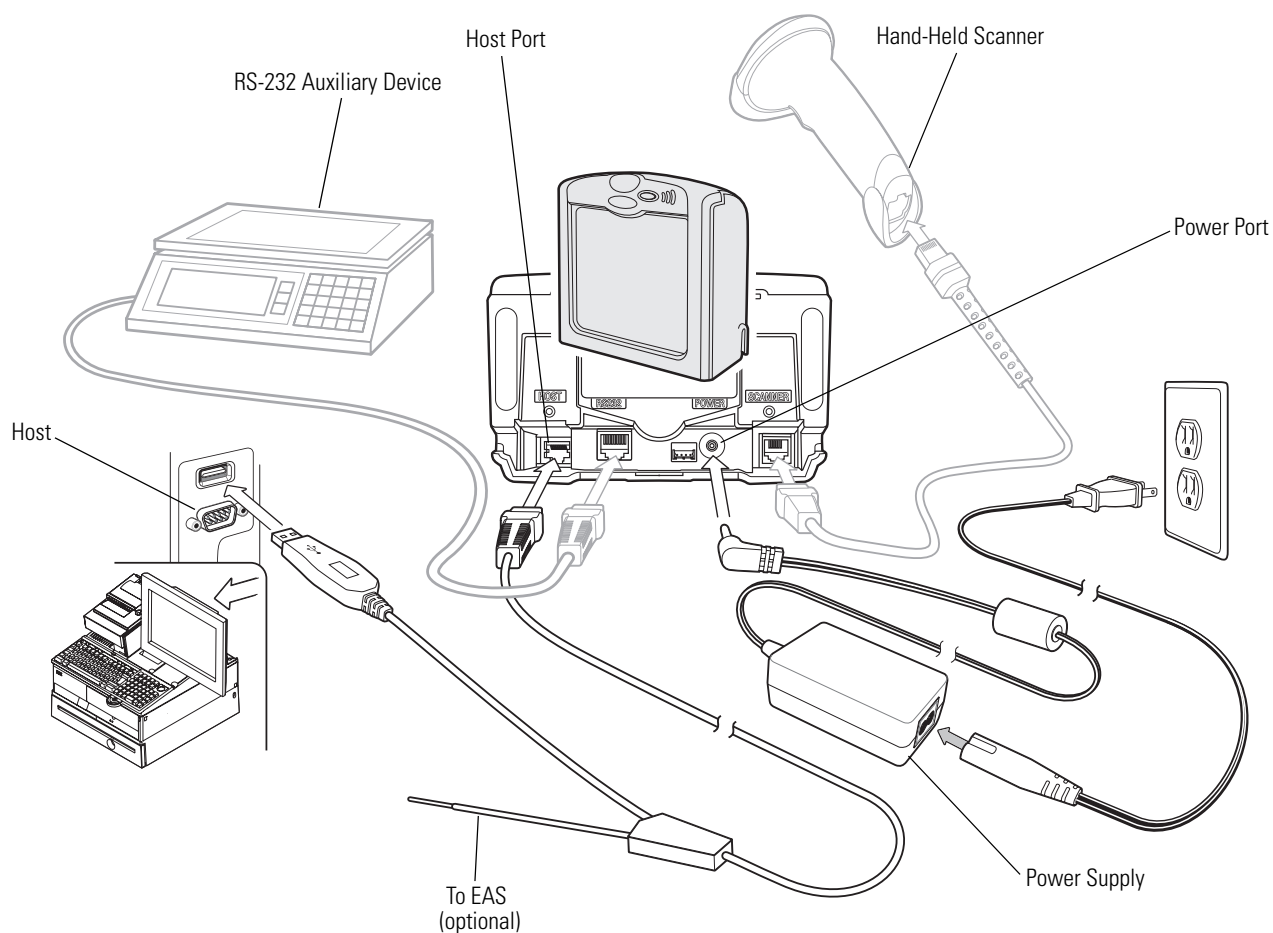

Figure 7-2. USB Connection With Peripherals - Power Supplied Externally

To set up the scanner:

1. Connect the USB interface cable to the host port of the scanner.
2. Connect the peripherals, if any, to their respective ports.
3. If connecting to peripherals, connect the power supply to the scanner's power port.
4. Plug the series A connector of the USB interface cable into the USB host or hub, or plug the Plus Power connector of the USB interface cable in an available port of the IBM SurePOS terminal.
5. Select the USB device type. See [USB Device Type on page 7-7](#).
6. On first installation when using Windows, the software displays a prompt to select or install the "Human Interface Device" driver. To install the "Human Interface Device" driver provided by Windows click **Next** through all the choices and click **Finished** on the last choice. The scanner powers up during this installation.
7. If not using a North American keyboard, scan the appropriate country bar code under [USB Country Keyboard Types \(Country Codes\) on page 7-9](#).



Note

Interface cables vary depending on configuration. The connectors may be different from the examples illustrated, but the steps to connect the scanner are the same. See [Chapter 1, Getting Started](#) for connection information.

USB Default Parameters

Table 7-1 lists the defaults for USB host parameters. To change any option, scan the appropriate bar code(s) beginning in *USB Host Parameters on page 7-7*.

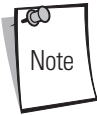

Note

Scanning parameter setting bar codes with the primary scanner also changes settings on the auxiliary scanner.



Note

See *Appendix A, Standard Default Parameters* for all user preferences, hosts, symbologies, and miscellaneous default parameters.

Table 7-1. USB Host Default Table

Parameter	Default	Page Number
USB Host Parameters		
USB Device Type	HID (Human Interface Device) Keyboard Emulation	7-7
USB Country Keyboard Types (Country Codes)	North American	7-9
USB Keystroke Delay	No Delay	7-14
USB CAPS Lock Override	Disable	7-16
USB Ignore Unknown Characters	Send Bar Codes	7-17
Emulate Keypad	Disable	7-18
USB Keyboard FN1 Substitution	Disable	7-19
Function Key Mapping	Disable	7-20
Simulated Caps Lock	Disable	7-21
Convert Case	Disable	7-22

USB Host Parameters

USB Device Type

Select the desired USB device type.



When changing USB Device Types, the scanner automatically restarts and issues the standard startup beep sequences.

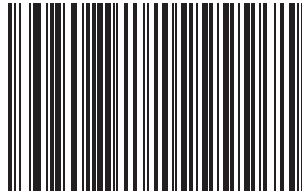

***HID Keyboard Emulation**

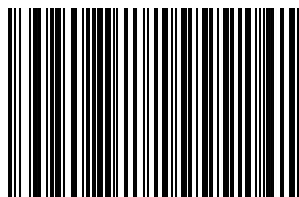

IBM Table Top USB

USB Device Type (continued)



IBM Hand-Held USB



OPOS

USB Country Keyboard Types (Country Codes)

Scan the bar code corresponding to the keyboard type. This setting applies only to the USB HID Keyboard Emulation device.



When changing Country Selection, the scanner automatically restarts and issues the standard startup beep sequences.

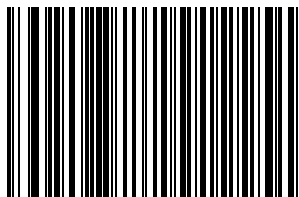

North American, Standard USB Keyboard

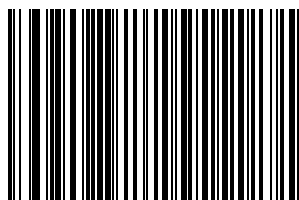

French, Windows

USB Country Keyboard Types (continued)

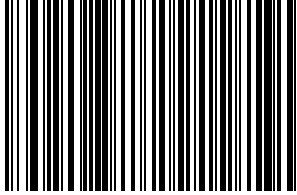

German, Windows

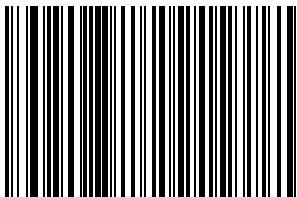

French Canadian, Windows

USB Country Keyboard Types (continued)



French Canadian, Windows 2000/XP

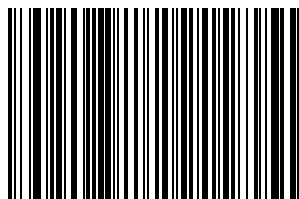

Spanish (Traditional), Windows

USB Country Keyboard Types (continued)

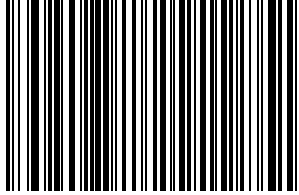

Italian, Windows

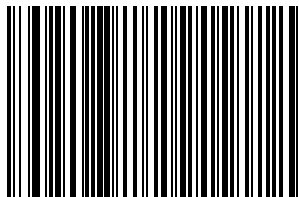

Swedish, Windows

USB Country Keyboard Types (continued)

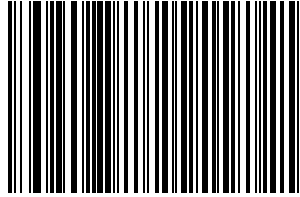

UK English, Windows

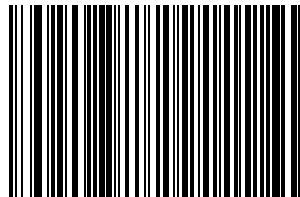

Japanese, Windows (ASCII)

USB Country Keyboard Types (continued)

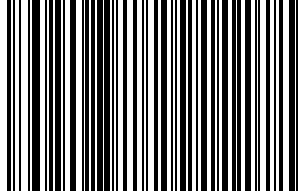

Portuguese-Brazilian, Windows

USB Keystroke Delay

This parameter sets the delay, in milliseconds, between emulated keystrokes. Scan one of the following bar codes to increase the delay when hosts require a slower transmission of data.

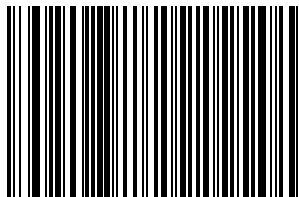

No Delay

USB Keystroke Delay (continued)

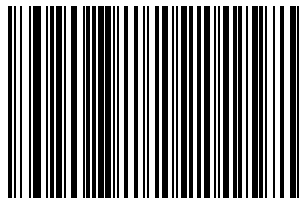

Medium Delay (20 msec)

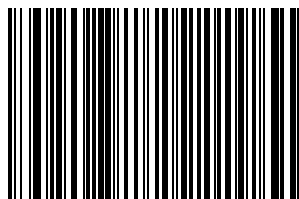

Long Delay (40 msec)

USB CAPS Lock Override

This option applies only to the HID Keyboard Emulation device. When enabled, the case of the data is preserved regardless of the state of the caps lock key. This setting is always enabled for the Japanese, Windows (ASCII) keyboard type and can not be disabled.

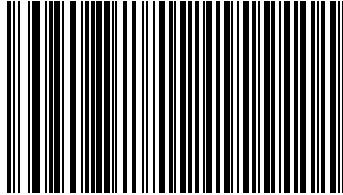

**Override Caps Lock Key
(Enable)**



**Do Not Override Caps Lock Key
(Disable)**

USB Ignore Unknown Characters

This option applies only to the HID Keyboard Emulation device and IBM device. Unknown characters are characters the host does not recognize. When **Send Bar Codes With Unknown Characters** is selected, all bar code data is sent except for unknown characters, and no error beeps sound. When **Do Not Send Bar Codes With Unknown Characters** is selected, bar codes containing at least one unknown character are not sent to the host, and an error beep sounds.

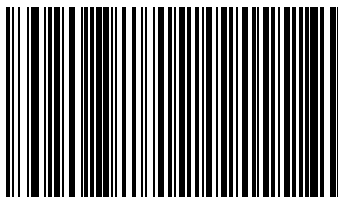

***Send Bar Codes With Unknown Characters**

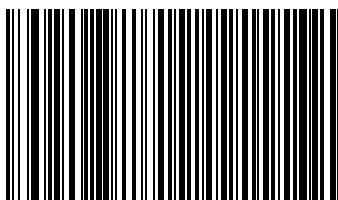

Do Not Send Bar Codes With Unknown Characters

Emulate Keypad

When enabled, all characters are sent as ASCII sequences over the numeric keypad. For example ASCII A would be sent as "ALT make" 0 6 5 "ALT Break."

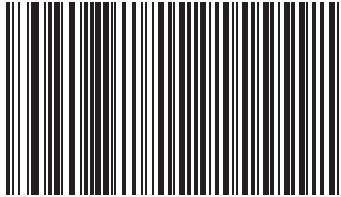

***Disable Keypad Emulation**

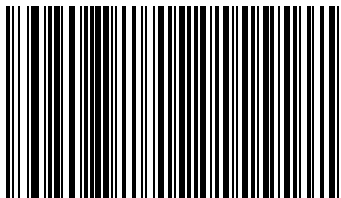

Enable Keypad Emulation

USB Keyboard FN1 Substitution

This option applies only to the USB HID Keyboard Emulation device. Enable this to replace any FN1 characters in an EAN 128 bar code with a selected Key Category and value (see [FN1 Substitution Values on page 14-6](#) to set the Key Category and Key Value).

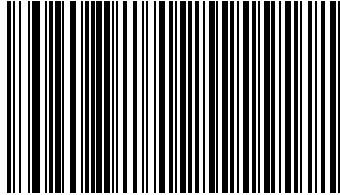

Enable

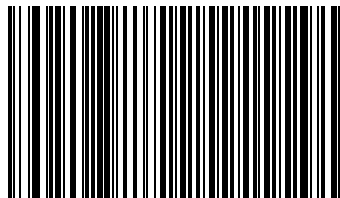

***Disable**

Function Key Mapping

ASCII values under 32 are normally sent as a control-key sequences (see [Table 7-2 on page 7-24](#)). Enable this parameter to send the keys in bold in place of the standard key mapping. Items that do not have a bold entry remain the same whether or not this parameter is enabled.

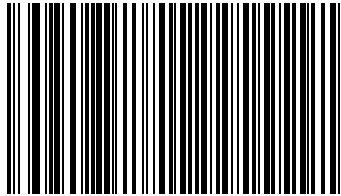

***Disable Function Key Mapping**

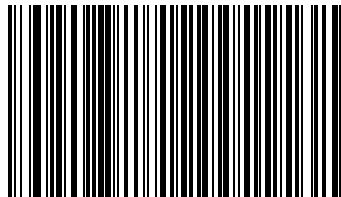

Enable Function Key Mapping

Simulated Caps Lock

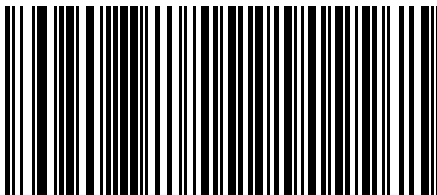

***Disable Simulated Caps Lock**

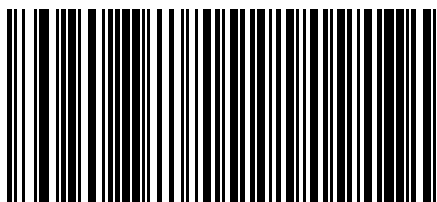

Enable Simulated Caps Lock

Convert Case

When enabled, the scanner converts all bar code data to the selected case.

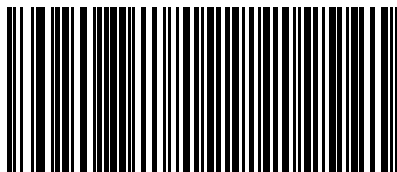

***No Case Conversion**

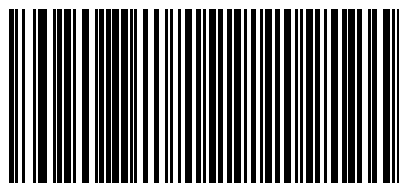

Convert All to Upper Case

Convert Case (continued)

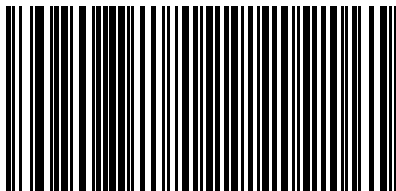

Convert All to Lower Case

ASCII Character Set

Table 7-2. USB ASCII Character Set

ASCII Value	Full ASCII Code 39 Encode Char.	Keystroke
1001	\$A	CTRL A
1002	\$B	CTRL B
1003	\$C	CTRL C
1004	\$D	CTRL D
1005	\$E	CTRL E
1006	\$F	CTRL F
1007	\$G	CTRL G
1008	\$H	CTRL H/ BACKSPACE^a
1009	\$I	CTRL I/ HORIZONTAL TAB^a
1010	\$J	CTRL J
1011	\$K	CTRL K
1012	\$L	CTRL L
1013	\$M	CTRL M/ ENTER^a
1014	\$N	CTRL N
1015	\$O	CTRL O
1016	\$P	CTRL P
1017	\$Q	CTRL Q
1018	\$R	CTRL R
1019	\$S	CTRL S
1020	\$T	CTRL T
1021	\$U	CTRL U
1022	\$V	CTRL V
1023	\$W	CTRL W
1024	\$X	CTRL X
1025	\$Y	CTRL Y
1026	\$Z	CTRL Z
1027	%A	NONE/ ESC^a
1028	%B	NONE
1029	%C	NONE
1030	%D	NONE
1031	%E	NONE
1032	Space	Space

Table 7-2. USB ASCII Character Set (Continued)

1033	/A	!
1034	/B	'
1035	/C	#
1036	/D	E
1037	/E	%
1038	/F	&
1039	/G	'
1040	/H	(
1041	/I)
1042	/J	*
1043	/K	+
1044	/L	,
1045	-	-
1046	.	.
1047	/	/
1048	0	0
1049	1	1
1050	2	2
1051	3	3
1052	4	4
1053	5	5
1054	6	6
1055	7	7
1056	8	8
1057	9	9
1058	/Z	:
1059	%F	;
1060	%G	<
1061	%H	=
1062	%I	>
1063	%J	?
1064	%V	@
1065	A	A
1066	B	B
1067	C	C
1068	D	D
1069	E	E

Table 7-2. USB ASCII Character Set (Continued)

1070	F	F
1071	G	G
1072	H	H
1073	I	I
1074	J	J
1075	K	K
1076	L	L
1077	M	M
1078	N	N
1079	O	O
1080	P	P
1081	Q	Q
1082	R	R
1083	S	S
1084	T	T
1085	U	U
1086	V	V
1087	W	W
1088	X	X
1089	Y	Y
1090	Z	Z
1091	%K	[
1092	%L	\
1093	%M]
1094	%N	^
1095	%O	_
1096	%W	`
1097	+A	a
1098	+B	b
1099	+C	c
1100	+D	d
1101	+E	e
1102	+F	f
1103	+G	g
1104	+H	h
1105	+I	i
1106	+J	j

Table 7-2. USB ASCII Character Set (Continued)

1107	+K	k
1108	+L	l
1109	+M	m
1110	+N	n
1111	+O	o
1112	+P	p
1113	+Q	q
1114	+R	r
1115	+S	s
1116	+T	t
1117	+U	u
1118	+V	v
1119	+W	w
1120	+X	x
1121	+Y	y
1122	+Z	z
1123	%P	{
1124	%Q	
1125	%R	}
1126	%S	~
ALT Keys	Keystroke	
2065	ALT A	
2066	ALT B	
2067	ALT C	
2068	ALT D	
2069	ALT E	
2070	ALT F	
2071	ALT G	
2072	ALT H	
2073	ALT I	
2074	ALT J	
2075	ALT K	
2076	ALT L	
2077	ALT M	
2078	ALT N	
2079	ALT O	
2080	ALT P	

Table 7-2. USB ASCII Character Set (Continued)

2081	ALT Q
2082	ALT R
2083	ALT S
2084	ALT T
2085	ALT U
2086	ALT V
2087	ALT W
2088	ALT X
2089	ALT Y
2090	ALT Z
GUI Shift Keys The Apple™ iMac keyboard has an apple key on either side of the space bar. Windows-based systems have a GUI key to the left of the left ALT key, and to the right of the right ALT key.	
Other Value	Keystroke
3000	Right Control Key
3048	GUI 0
3049	GUI 1
3050	GUI 2
3051	GUI 3
3052	GUI 4
3053	GUI 5
3054	GUI 6
3055	GUI 7
3056	GUI 8
3057	GUI 9
3065	GUI A
3066	GUI B
3067	GUI C
3068	GUI D
3069	GUI E
3070	GUI F
3071	GUI G
3072	GUI H
3073	GUI I
3074	GUI J
3075	GUI K
3076	GUI L

Table 7-2. USB ASCII Character Set (Continued)

3077	GUI M
3078	GUI N
3079	GUI O
3080	GUI P
3081	GUI Q
3082	GUI R
3083	GUI S
3084	GUI T
3085	GUI U
3086	GUI V
3087	GUI W
3088	GUI X
3089	GUI Y
3090	GUI Z
F Keys	Keystroke
5001	F1
5002	F2
5003	F3
5004	F4
5005	F5
5006	F6
5007	F7
5008	F8
5009	F9
5010	F10
5011	F11
5012	F12
5013	F13
5014	F14
5015	F15
5016	F16
5017	F17
5018	F18
5019	F19
5020	F20
5021	F21
5022	F22

Table 7-2. USB ASCII Character Set (Continued)

5023	F23
5024	F24
Numeric Keypad	Keystroke
6042	*
6043	+
6045	-
6046	.
6047	/
6048	0
6049	1
6050	2
6051	3
6052	4
6053	5
6054	6
6055	7
6056	8
6057	9
6058	Enter
6059	Num Lock
Extended Keypad	Keystroke
7001	Break
7002	Delete
7003	PgUp
7004	End
7005	Pg Dn
7006	Pause
7007	Scroll Lock
7008	Backspace
7009	Tab
7010	Print Screen
7011	Insert
7012	Home
7013	Enter
7014	Escape

Table 7-2. USB ASCII Character Set (Continued)

7015	Up Arrow
7016	Down Arrow
7017	Left Arrow
7018	Right Arrow

a. The Keystroke in bold is sent only if the "Function Key Mapping" parameter is enabled. Otherwise, the unbolded keystroke is sent.

8

IBM 468X/469X Interface

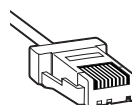

Introduction	8-3
Connecting to an IBM 468X/469X Host	8-4
IBM Default Parameters	8-5
IBM 468X/469X Host Parameters	8-6
Port Address	8-6
Convert Unknown to Code 39	8-8

Introduction

This chapter provides information on setting up the scanner with an IBM 468X/469X host.

Throughout the programming bar code menus, asterisks (*) indicate default values.

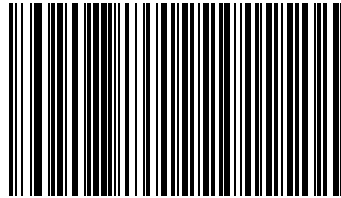

* Indicates Default — ***Disable Convert Unknown to Code 39** — Feature/Option

Connecting to an IBM 468X/469X Host

The scanner connects directly to an IBM host interface. This configuration requires an external power supply regardless of whether peripherals are attached.

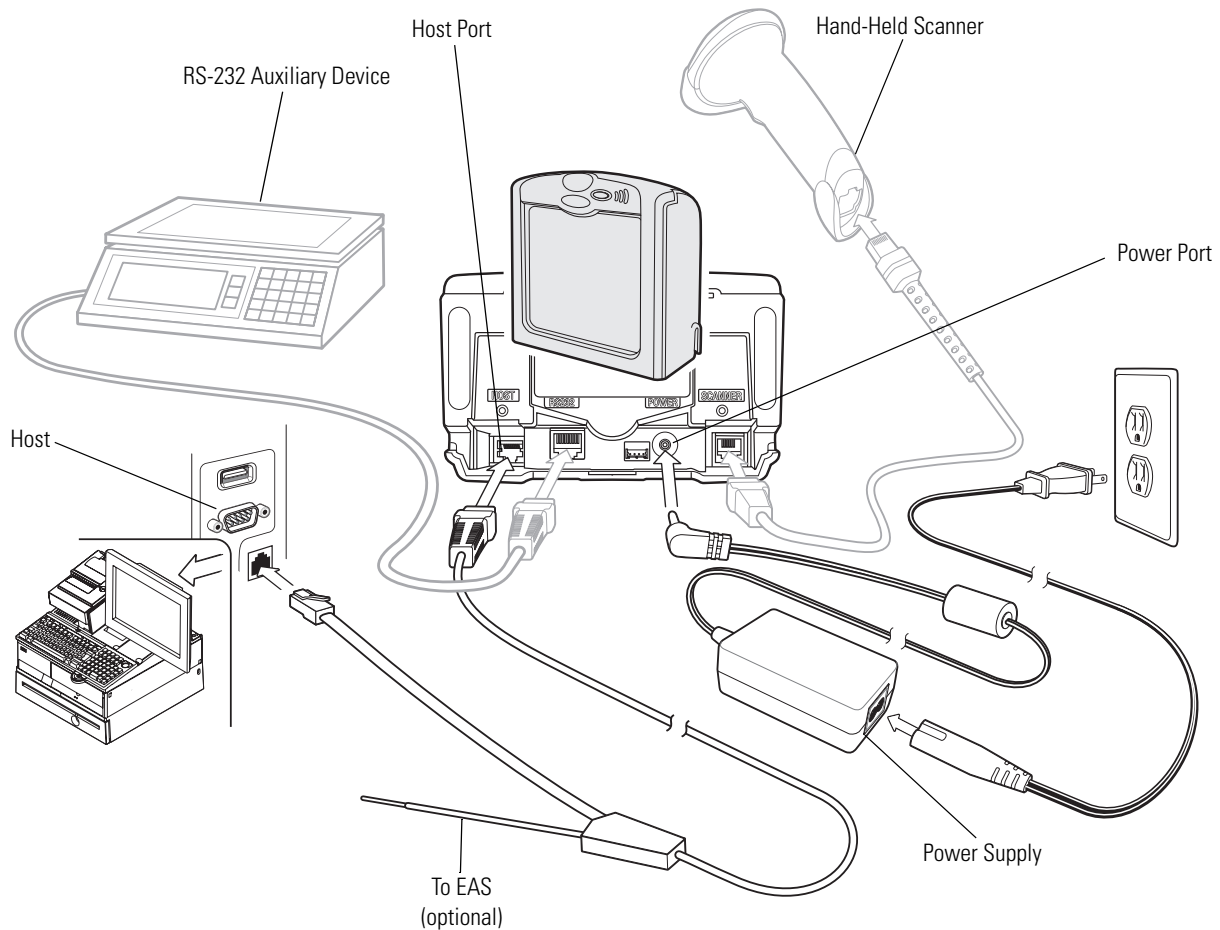

Figure 8-1. IBM Connection - Power Supplied Externally, with or without Peripherals

1. Connect the interface cable to the host port of the scanner.
2. Connect the other end of the interface cable to the appropriate port on the host (typically, Port 9).
3. Connect the peripherals, if any, to their respective ports (see [Figure 8-1](#)).
4. Connect the power supply to the scanner's power port.
5. Scan the appropriate bar codes in this chapter or use 123Scan to configure the scanner.



Interface cables vary depending on configuration. The connectors may be different from the examples illustrated, but the steps to connect the scanner are the same. See [Chapter 1, Getting Started](#) for connection information.



The only required configuration is the port number. The host system controls most other scanner parameters.

IBM Default Parameters

Table 8-1 lists the defaults for IBM host parameters. To change any option, scan the appropriate bar code(s) beginning in [IBM 468X/469X Host Parameters on page 8-6](#).



Scanning parameter setting bar codes with the primary scanner also changes settings on the auxiliary scanner.



See [Appendix A, Standard Default Parameters](#) for all user preferences, hosts, symbologies, and miscellaneous default parameters.

Table 8-1. IBM Host Default Table

Parameter	Default	Page Number
IBM 468X/469X Host Parameters		
Port Address	None Selected ¹	8-6
Convert Unknown to Code 39	Disable	8-8
¹ User selection is required to configure this interface and this is the most common selection.		

IBM 468X/469X Host Parameters

Port Address

This parameter sets the IBM 468X/469X port used.



Scanning one of these bar codes enables the RS-485 interface on the scanner.

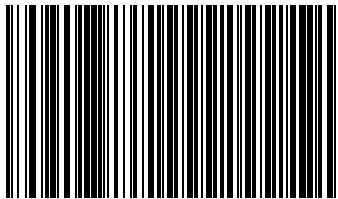

*** None Selected**

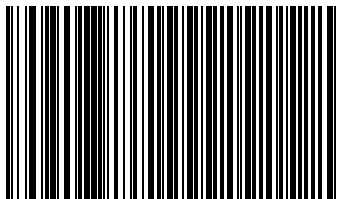

Hand-held Scanner Emulation (Port 9B)¹



¹User selection is required to configure this interface and this is the most common selection.

Port Address (continued)

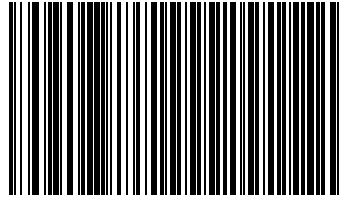

Hand-Held Scanner Emulation (Port 5B)

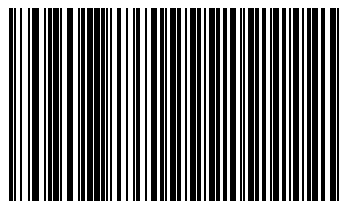
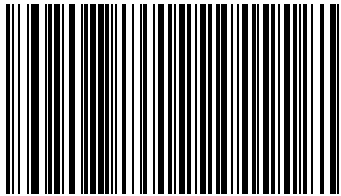

Table-top Scanner Emulation (Port 17)

Convert Unknown to Code 39

Scan a bar code below to enable or disable the conversion of unknown bar code type data to Code 39.



Enable Convert Unknown to Code 39

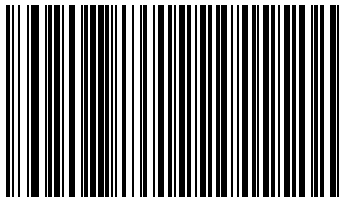

Disable Convert Unknown to Code 39

9

Synapse Interface

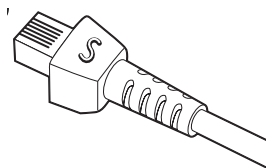

Introduction	9-3
Connecting a Synapse Interface Cable	9-5
Synapse Interface	9-6
“Plug and Play” Synapse Connection	9-6

Introduction

Synapse Smart cables interface to a variety of hosts. The appropriate Synapse Smart cable has built-in intelligence to detect the host to which it is connected. An external power supply is required.

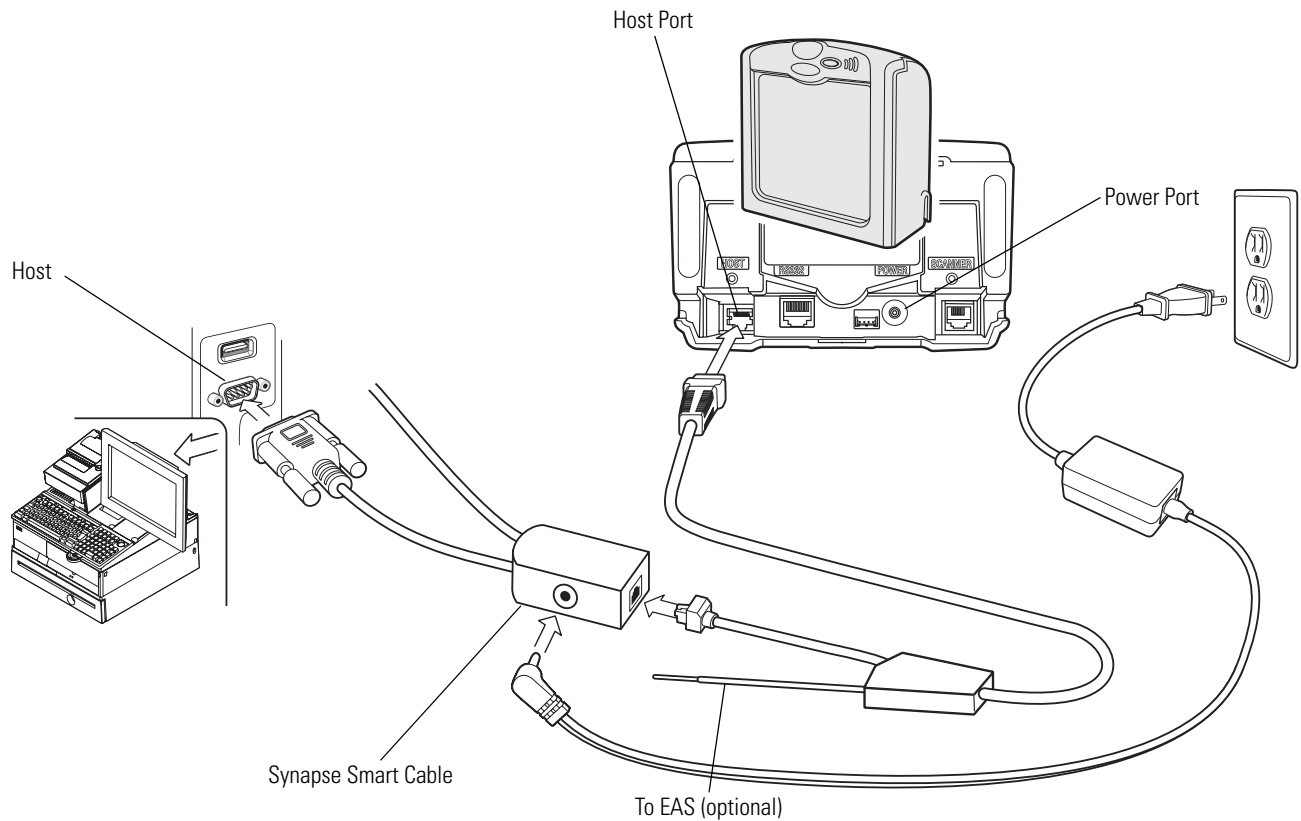

Figure 9-1. Synapse Connection Without Peripherals - Power Supplied Externally via Y-Cable



Interface cables vary depending on configuration. The connectors may be different from the examples illustrated, but the steps to connect the scanner are the same. See [Chapter 1, Getting Started](#) for connection information.

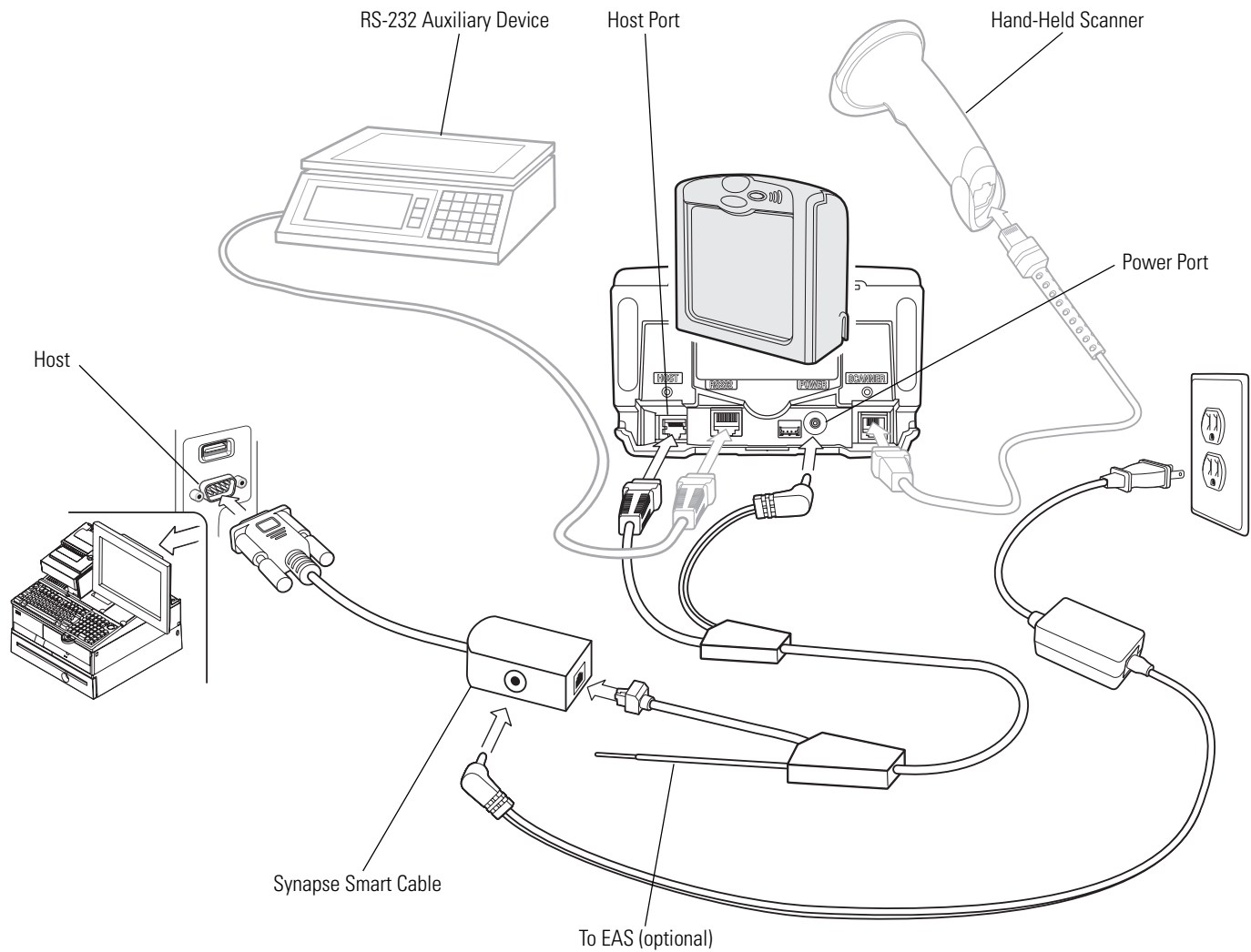

Figure 9-2. Synapse Connection With Peripherals - Power Supplied Externally via Y-Cable



See [Figure 1-4 on page 1-8](#) for correct cable routing options when using a Y-connector cable.

Connecting a Synapse Interface Cable

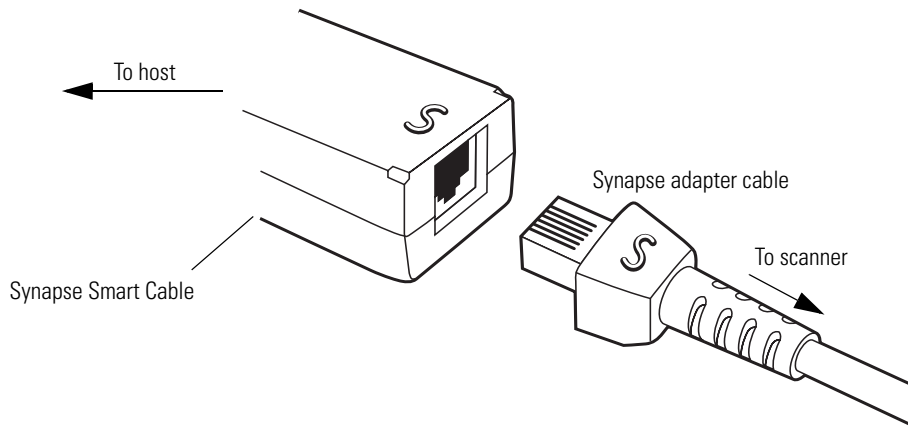

Figure 9-3. Synapse Cable Connection

The Synapse interface consists of two components:

- The Synapse adapter cable, which connects to the scanner's host port on one end, and to the Synapse Smart cable on the other
- The Synapse Smart cable, which connects to the host computer on one end, and the Synapse adapter cable on the other. The Synapse Smart cable detects the host type and programs itself accordingly.

To connect the Synapse interface:

1. Plug the Synapse adapter cable (p/n 25-32463-xx) into the host port of the scanner, as described in [Connecting the Host and Peripheral Cables on page 1-6](#).
2. Align the 'S' on the Synapse adapter cable with the 'S' on the Synapse Smart cable and plug the cable in.
3. Connect the other end of the Synapse Smart cable to the host.



Note

See the *Synapse Interface Guide* provided with the Synapse cable for detailed setup instructions.

Synapse Interface

The auto-detection of a Synapse cable varies in duration depending on the type of Synapse connection.

To disconnect and reconnect the scanner from a Synapse cable that is connected to a live host, use the “Plug and Play” setting. Do not change this setting from the default if an on-board wedge host is enabled.

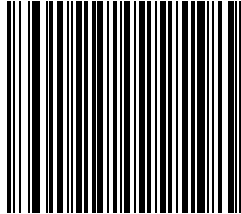

***Standard Synapse Connection**

“Plug and Play” Synapse Connection

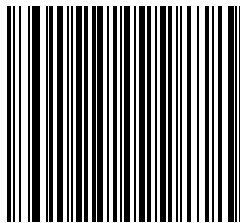

“Plug and Play” Synapse Connection

10

RS-232 Auxiliary Port



Introduction	10-3
Connecting a Device to the RS-232 Auxiliary Port.....	10-4
RS-232 Auxiliary Port Default Parameters.....	10-5
RS-232 Auxiliary Port Parameters	10-6
Baud Rate	10-6
Parity.....	10-9
Check Receive Errors	10-11
Check Receive Errors (continued).....	10-12
Hardware Handshaking	10-12
Standard RTS/CTS	10-13
Software Handshaking.....	10-15
Serial Response Time-out	10-17
RTS Line State	10-20
Stop Bit Select	10-21
Data Bits.....	10-22

Introduction

This chapter describes how to set up the RS-232 auxiliary port. This port is used to connect the Symbol LS7708 to a variety of peripherals, such as scales, magnetic stripe readers, and other devices.



The RS-232 auxiliary port interprets a two-second timeout in data transmission as a signal that a complete block of data has been received. Sending a carriage return also signals a complete block of data, and allows the user to continue scanning more quickly.



Data overrun occurs when data is received at the RS-232 auxiliary port faster than the host can transmit it. The primary scanner and auxiliary hand-held scanner ports take precedence over the RS-232 port. If large amounts of data are sent to the RS-232 auxiliary port, abstain from scanning data on the other ports.

Asterisks (*) indicate default values for programming bar code menus.

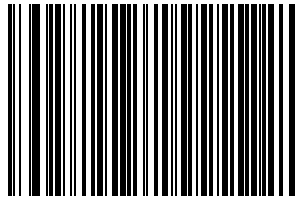

*Indicates Default — ***Baud Rate 9600** — Feature/Option

Connecting a Device to the RS-232 Auxiliary Port

The RS-232 auxiliary port is used to connect to a peripheral device such as a scale or magstripe reader. When an RS-232 device is connected to the scanner, an external power supply is necessary.

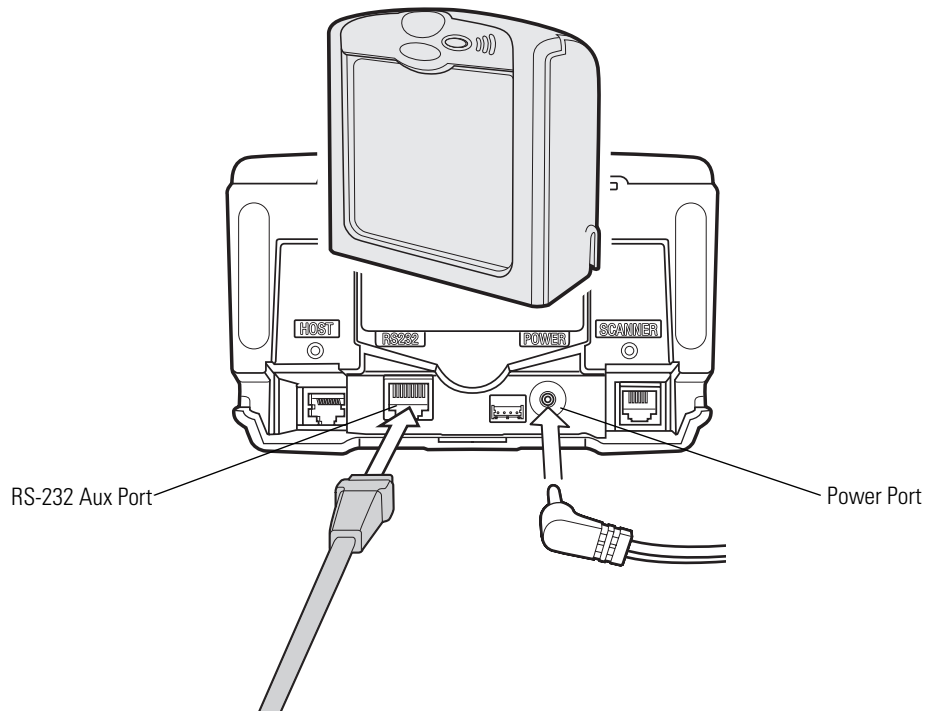

Figure 10-1. RS-232 Auxiliary Port Connection

To connect an auxiliary device to the RS-232 auxiliary port:

1. Connect the RS-232 interface cable to the auxiliary port of the scanner.
2. Connect the other end of the RS-232 cable to the serial port on the auxiliary device.
3. Connect the power supply.
4. Scan appropriate bar codes in this chapter to match the auxiliary device settings.



Note

Interface cables vary depending on configuration. The connectors may be different from the examples illustrated, but the steps to connect the scanner are the same. See [Chapter 1, Getting Started](#) for connection information.

RS-232 Auxiliary Port Default Parameters

Table 10-1 lists the defaults for RS-232 auxiliary parameters. To change any option, scan the appropriate bar code(s) beginning in *RS-232 Auxiliary Port Parameters on page 10-6*.

Table 10-1. RS-232 Auxiliary Port Default Parameters

Parameter	Default	Page Number
Baud Rate	9600	10-6
Parity	None	10-9
Check Receive Errors	Enable	10-11
Hardware Handshaking	None	10-12
Software Handshaking	None	10-15
Serial Response Time-out	2 Sec	10-17
RTS Line State	Low RTS	10-20
Stop Bit Select	1	10-21
Data Bits	8-Bit	10-22

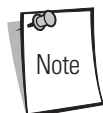

See [Appendix A, Standard Default Parameters](#) for all user preferences, hosts, symbologies, and miscellaneous default parameters.

RS-232 Auxiliary Port Parameters

Baud Rate

Baud rate is the number of bits of data transmitted per second. Select a baud rate to match the baud rate setting of the host device. Otherwise, data may not reach the host device or may reach it in distorted form.

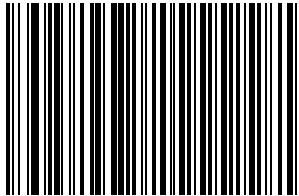

Baud Rate 1200

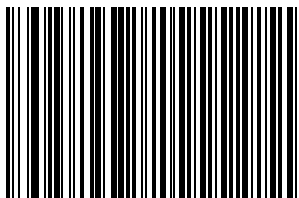

Baud Rate 2400

Baud Rate (continued)

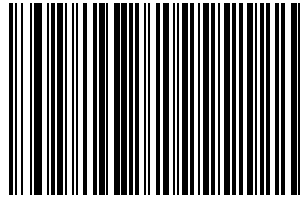

Baud Rate 4800

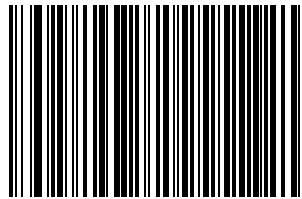

***Baud Rate 9600**

Baud Rate (continued)

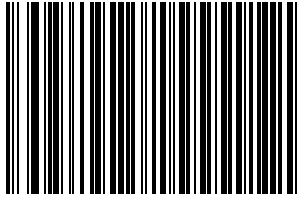

Baud Rate 19,200

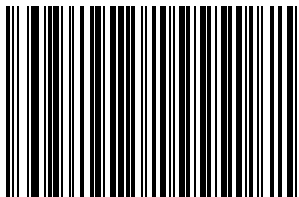

Baud Rate 38,400

Parity

A parity check bit is the most significant bit of each ASCII coded character. Select the parity type according to host device requirements.

Select **Odd** parity and the parity bit value is set to 0 or 1, based on data, to ensure that an odd number of 1 bits are contained in the coded character.

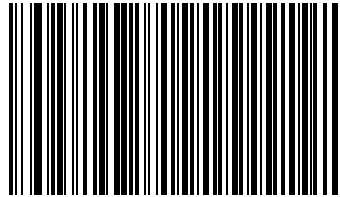

Odd

Select **Even** parity and the parity bit value is set to 0 or 1, based on data, to ensure that an even number of 1 bits are contained in the coded character.

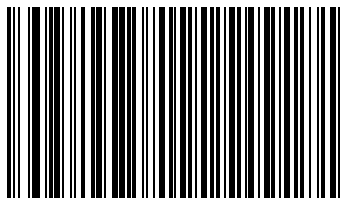

Even

Parity (continued)

Select **Mark** parity and the parity bit is always 1.

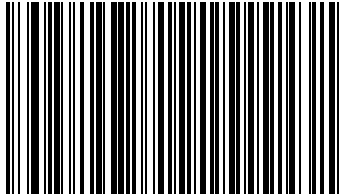

Mark

Select **Space** parity and the parity bit is always 0.

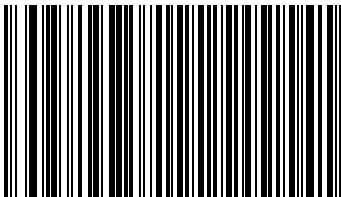

Space

Parity (continued)

Select **None** when no parity bit is required.

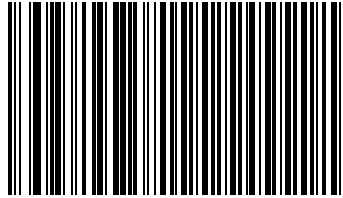

***None**

Check Receive Errors

Select whether or not the parity, framing, and overrun of received characters are checked. The parity value of received characters is verified against the parity parameter selected above.

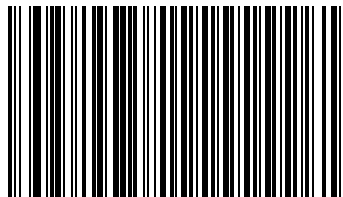

***Check For Received Errors**

Check Receive Errors (continued)

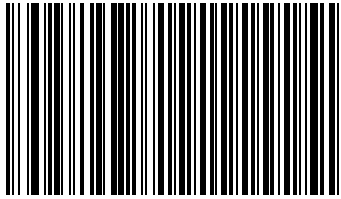

Do Not Check For Received Errors

Hardware Handshaking

The data interface consists of an RS-232 port designed to operate either with or without the hardware handshaking lines, *Request to Send (RTS)*, and *Clear to Send (CTS)*.

If Standard RTS/CTS handshaking is not selected, scan data is transmitted as it becomes available. If Standard RTS/CTS handshaking is selected, scan data is transmitted according to the following sequence:

- The scanner reads the CTS line for activity. If CTS is asserted, the scanner waits up to 2 seconds for the host to negate the CTS line. If, after 2 seconds (default), the CTS line is still asserted, the scanner sounds a transmit error, and any scanned data is lost.
- When the CTS line is negated, the scanner asserts the RTS line and waits up to 2 seconds for the host to assert CTS. When the host asserts CTS, data is transmitted. If, after 2 seconds (default), the CTS line is not asserted, the scanner sounds a transmit error, and discards the data.
- When data transmission is complete, the scanner negates RTS 10 msec after sending the last character.
- The host should respond by negating CTS. The scanner checks for a negated CTS upon the next transmission of data.

During the transmission of data, the CTS line should be asserted. If CTS is deasserted for more than 50 ms between characters, the transmission is aborted, the scanner sounds a transmission error, and the data is discarded.

If the above communications sequence fails, the scanner issues an error indication. In this case, the data is lost and must be rescanned.

If Hardware Handshaking and Software Handshaking are both enabled, Hardware Handshaking takes precedence.



The DTR signal is jumpered to the active state.

Note

None

Scan the bar code below if no Hardware Handshaking is desired.

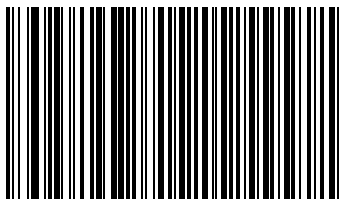

***None**

Standard RTS/CTS

Scan the bar code below to select Standard RTS/CTS Hardware Handshaking.

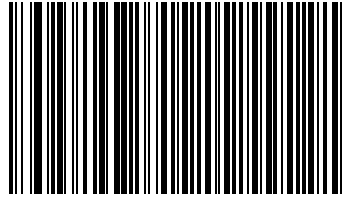

Standard RTS/CTS

RTS/CTS Option 1

When RTS/CTS Option 1 is selected, the scanner asserts RTS before transmitting and ignores the state of CTS. The scanner de-asserts RTS when the transmission is complete.

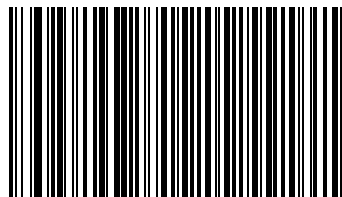

RTS/CTS Option 1

RTS/CTS Option 2

When Option 2 is selected, RTS is always high or low (user-programmed logic level). However, the scanner waits for CTS to be asserted before transmitting data. If CTS is not asserted within 2 seconds (default), the scanner issues an error indication and discards the data.

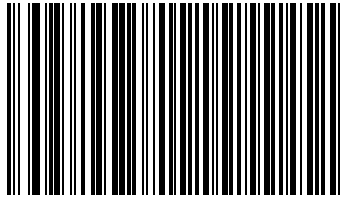

RTS/CTS Option 2

RTS/CTS Option 3

When Option 3 is selected, the scanner asserts RTS prior to any data transmission, regardless of the state of CTS. The scanner waits up to 2 seconds (default) for CTS to be asserted. If CTS is not asserted during this time, the scanner issues an error indication and discards the data. The scanner de-asserts RTS when transmission is complete.

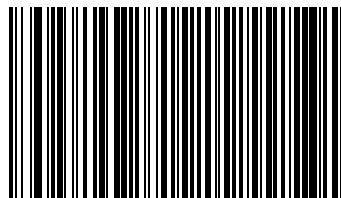

RTS/CTS Option 3

Software Handshaking

This parameter offers control of the data transmission process in addition to, or instead of, that offered by hardware handshaking. There are five options.

If Software Handshaking and Hardware Handshaking are both enabled, Hardware Handshaking takes precedence.

None

When this option is selected, data is transmitted immediately.

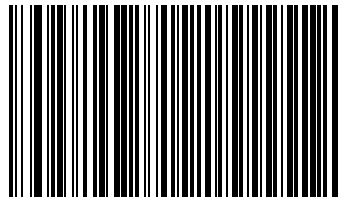

***None**

ACK/NAK

When this option is selected, after transmitting data, the scanner expects either an ACK or NAK response from the host. When a NAK is received, the scanner transmits the same data again and waits for either an ACK or NAK. After three unsuccessful attempts to send data when NAKs are received, the scanner issues an error indication and discards the data.

The scanner waits up to the programmable Host Serial Response Time-out to receive an ACK or NAK. If the scanner does not get a response in this time, it issues an error indication and discards the data. There are no retries when a time-out occurs.

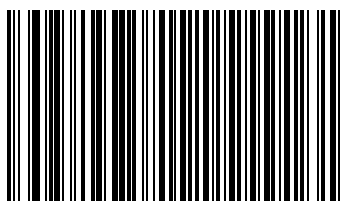

ACK/NAK

Software Handshaking (continued)

ENQ

When this option is selected, the scanner waits for an ENQ character from the host before transmitting data. If an ENQ is not received within the Host Serial Response Time-out, the scanner issues an error indication and discards the data. The host must transmit an ENQ character at least every Host Serial Response Time-out to prevent transmission errors.

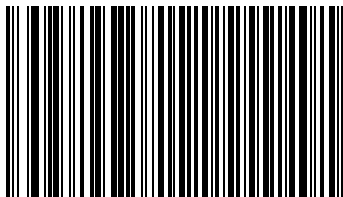

ENQ

ACK/NAK with ENQ

This combines the two previous options.

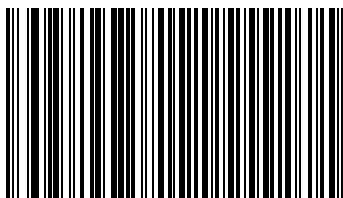

ACK/NAK with ENQ

Software Handshaking (continued)

XON/XOFF

An XOFF character turns the scanner transmission off until the scanner receives an XON character. There are two situations for XON/XOFF:

- XOFF is received before the scanner has data to send. When the scanner has data to send, it waits up to 2 seconds for an XON character before transmission. If the XON is not received within this time, the scanner issues an error indication and discards the data.
- XOFF is received during a transmission. Data transmission then stops after sending the current byte. When the scanner receives an XON character, it sends the rest of the data message. The scanner waits indefinitely for the XON.

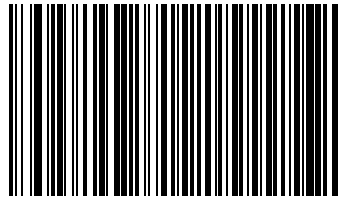

XON/XOFF

Serial Response Time-out

This parameter specifies how long the scanner waits for an ACK, NAK, or CTS before determining that a transmission error has occurred. This only applies when in one of the ACK/NAK Software Handshaking modes, or RTS/CTS Hardware Handshaking option.

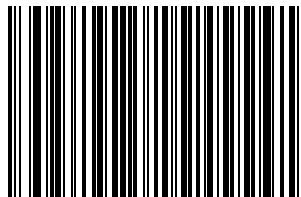

*** Minimum: 2 Sec**

Serial Response Time-out (continued)

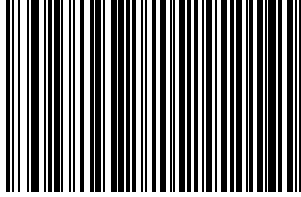

Low: 2.5 Sec

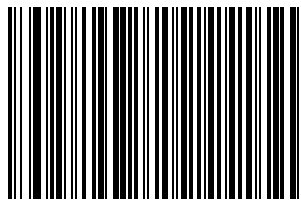

Medium: 5 Sec

Serial Response Time-out (continued)

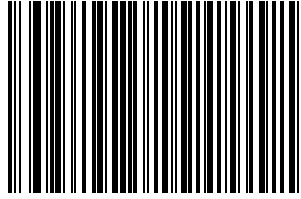

High: 7.5 Sec

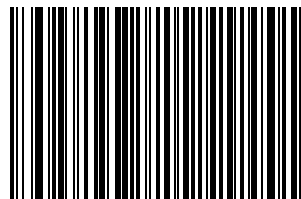

Maximum: 9.9 Sec

RTS Line State

This parameter sets the idle state of the Serial Host RTS line. Scan a bar code below to select **Low RTS** or **High RTS** line state.

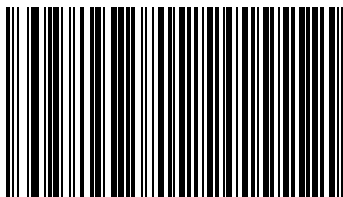

***Host: Low RTS**

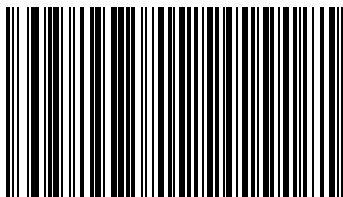

Host: High RTS

Stop Bit Select

The stop bit(s) at the end of each transmitted character marks the end of transmission of one character and prepares the receiving device for the next character in the serial data stream. The number of stop bits selected (one or two) depends on the number the receiving terminal is programmed to accommodate. Set the number of stop bits to match host device requirements.

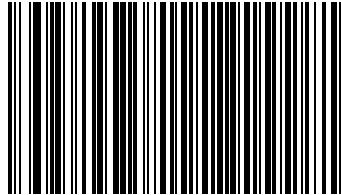

***1 Stop Bit**

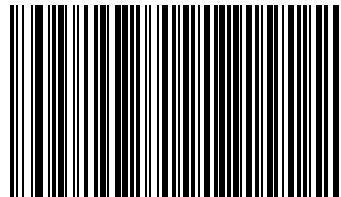

2 Stop Bits

Data Bits

This parameter allows the scanner to interface with devices requiring a 7-bit or 8-bit ASCII protocol.



7-Bit

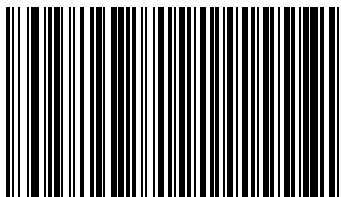

***8-Bit**

11

Hand-Held Laser Scanner Port

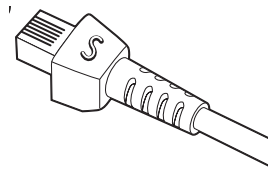

Introduction	11-3
Connecting a Hand-Held Scanner	11-3
Hand-Held Laser Scanner Default Parameters	11-4
Hand-Held Laser Scanner Options	11-5
Programming Mode	11-5
Beep After Good Decode	11-7

Introduction

Connecting a Hand-Held Scanner

Connect the hand-held scanner's Synapse Adapter cable to the Scanner port of the Symbol LS7708. In most cases, the hand-held laser scanner configures itself.



When using the hand-held scanner port, connect an external power supply to the power port.

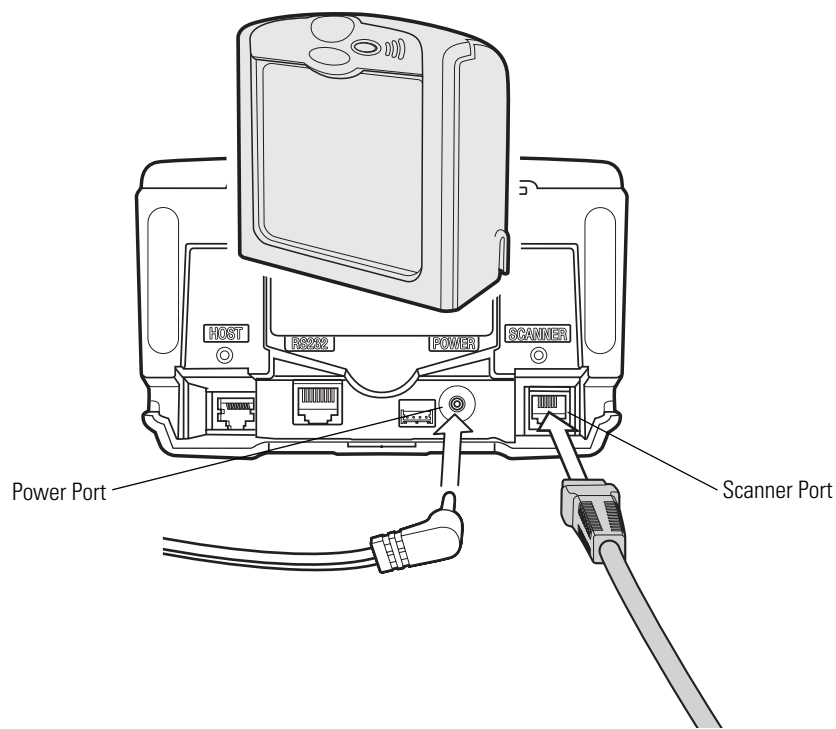

Figure 11-1. Connecting to a Hand-Held Laser Scanner



Interface cables vary depending on configuration. The connectors may be different from the examples illustrated, but the steps to connect the scanner are the same. See [Chapter 1, Getting Started](#) for connection information.

When the hand-held laser scanner is connected to the Scanner port of the primary scanner, the hand-held scanner auto-configures and inherits some of the primary scanner's decode parameters. Any changes to the primary scanner's settings are automatically reflected back to the hand-held scanner. Programming bar codes are provided to:

- program only the hand-held laser scanner
- program only the Symbol LS7708
- program both scanners simultaneously.

Some hand-held scanners do not support these programming modes. Parameter bar codes affect only these scanners, not the primary scanner, regardless of the programming mode selected.

When this type of hand-held scanner is connected, program the primary scanner by scanning parameter bar codes with the primary scanner.

To determine the type of hand-held scanner used, plug the scanner into the Scanner port. Using the hand-held scanner, scan a parameter bar code. If the primary scanner issues a warble beep, the hand-held scanner supports the programming modes. If the hand-held scanner issues a warble beep, it does not support these modes.

Hand-Held Laser Scanner Default Parameters

Table 11-1 lists the defaults for Hand-Held Laser Scanner Port parameters. To change any option, **using the primary scanner only**, scan the appropriate bar code(s) beginning in [Hand-Held Laser Scanner Options on page 11-5](#).

Table 11-1. Hand-Held Laser Scanner Default Parameters

Parameter	Default	Page Number
Programming Mode	Program Primary Scanner Only	11-5
Beep After Good Decode	Disable	11-7

Hand-Held Laser Scanner Options

Programming Mode

Program Hand-Held Scanner Only

If enabled, scanning parameter bar codes changes the settings on the hand-held laser scanner only, and does not affect the Symbol LS7708 (primary scanner). The primary scanner does not recognize changes made to the decode parameters (i.e., code types, lengths, or check digits). However, changing these parameters on the primary scanner overrides the hand-held scanner settings.

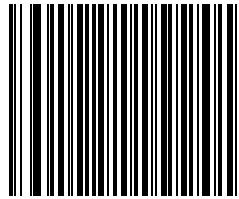

Program Hand-Held Scanner Only



Important: Use the primary scanner to scan this bar code.

Program Primary Scanner Only

If enabled, scanning parameter bar codes only changes the settings on the primary scanner (LS7708) and does not affect the hand-held laser scanner. Any changes made to the decode parameters (i.e., code types, lengths or check digits) also apply to the hand-held scanner. This mode is useful for programming the primary scanner using the hand-held scanner.

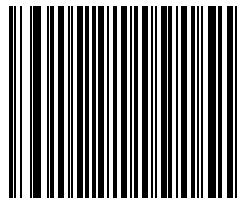

Program Primary Scanner Only



Important: Use the primary scanner to scan this bar code.

Program All Scanners

When this mode is enabled, scanning parameter bar codes changes the settings on the primary scanner (LS7708) and the hand-held scanner. If either scanner does not recognize a particular parameter bar code (the parameter was not meant for that scanner), that scanner emits an error beep. The other scanner emits a warble tone.

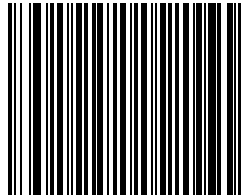

Program All Scanners



CAUTION

Important: Use the primary scanner to scan this bar code.

Beep After Good Decode

This parameter affects the hand-held scanner only. When enabled, the scanner connects to the Scanner port beeps after a successful decode.

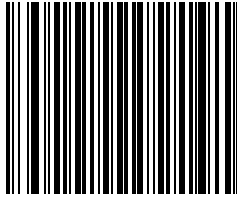

Beep After Good Decode

This parameter affects the hand-held scanner only. When disabled, the scanner connected to the Scanner port does not beep after a successful decode. Beeps for parameter menu scanning and serial communications are not affected.

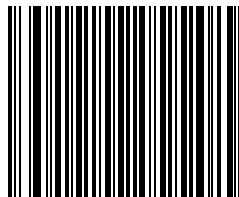

Do Not Beep After Good Decode

12

123Scan

Introduction	12-3
Setting Up the 123Scan PC-Based Configuration Tool	12-3
123Scan Parameter	12-3

Introduction

123Scan is a Windows® based utility that programs the scanner with all parameters including Advanced Data Formatting (ADF) Rules. An ADF rule modifies bar code data before it is sent to the host. This ensures compatibility between bar coded data and the host application; the scanner is programmed rather than modifying the host software. Scanners can be programmed via PC download or by scanning a sheet of bar codes generated by the utility. Scanner programming is saved in a file that can be distributed electronically by e-mail. A help file is built into the 123Scan program.

Setting Up the 123Scan PC-Based Configuration Tool

To communicate with the 123Scan program, load 123Scan onto a Windows PC, then use an RS-232 cable to connect the scanner to the PC (see [Connecting an RS-232 Interface on page 6-4](#)).

123Scan Parameter

To enable the 123Scan interface on the scanner, scan the bar code below. Refer to 123Scan instructions for programming the scanner.



123Scan Configuration

13

Symbologies

Introduction	13-3
Scanning Sequence Examples	13-3
Errors While Scanning	13-3
Symbology Default Parameters	13-3
UPC/EAN	13-7
Enable/Disable UPC-A/UPC-E	13-7
Enable/Disable UPC-E1	13-9
Enable/Disable EAN-13/JAN-13/EAN-8/JAN-8	13-10
Enable/Disable Bookland EAN	13-12
Decode UPC/EAN Supplementals	13-13
UPC/EAN Supplemental Redundancy	13-22
Transmit UPC-A/UPC-E/UPC-E1 Check Digit	13-23
UPC-A Preamble	13-26
UPC-E Preamble	13-27
UPC-E1 Preamble	13-29
Convert UPC-E to UPC-A	13-31
Convert UPC-E1 to UPC-A	13-32
EAN Zero Extend	13-33
Bookland ISBN Format	13-34
UCC Coupon Extended Code	13-35
Code 128	13-36
Enable/Disable Code 128	13-36
Enable/Disable UCC/EAN-128	13-37
Enable/Disable ISBT 128	13-38
Code 128 Decode Performance	13-39
Code 128 Decode Performance Level	13-40

Code 39	13-42
Enable/Disable Code 39	13-42
Enable/Disable Trioptic Code 39	13-43
Convert Code 39 to Code 32	13-44
Code 32 Prefix	13-45
Set Lengths for Code 39	13-46
Code 39 Check Digit Verification	13-48
Transmit Code 39 Check Digit	13-49
Enable/Disable Code 39 Full ASCII	13-50
Code 39 Buffering (Scan & Store)	13-51
Code 39 Decode Performance	13-55
Code 39 Decode Performance Level	13-56
Code 93	13-58
Enable/Disable Code 93	13-58
Set Lengths for Code 93	13-59
Code 11	13-61
Enable/Disable Code 11	13-61
Set Lengths for Code 11	13-62
Code 11 Check Digit Verification	13-64
Transmit Code 11 Check Digits	13-66
Interleaved 2 of 5 (ITF)	13-67
Enable/Disable Interleaved 2 of 5	13-67
Set Lengths for Interleaved 2 of 5	13-68
I 2 of 5 Check Digit Verification	13-70
Transmit I 2 of 5 Check Digit	13-72
Convert I 2 of 5 to EAN-13	13-73
Discrete 2 of 5 (DTF)	13-74
Enable/Disable Discrete 2 of 5	13-74
Set Lengths for Discrete 2 of 5	13-75
Codabar (NW - 7)	13-78
Enable/Disable Codabar	13-78
Set Lengths for Codabar	13-79
CLSI Editing	13-82
NOTIS Editing	13-83
RSS (Reduced Space Symbology)	13-84
RSS 14	13-84
RSS Limited	13-85
RSS Expanded	13-86
Convert RSS to UPC/EAN	13-87
Symbology - Specific Security Levels	13-88
Redundancy Level	13-88
Security Level	13-91
Bi-directional Redundancy	13-93
Symbology - Intercharacter Gap	13-94

Introduction

This chapter describes all symbology features and provides the programming bar codes necessary for selecting these features for the Symbol LS7708 scanner. Before programming, follow the instructions in [Chapter 1, Getting Started](#). Throughout the programming bar code menus, asterisks (*) indicate default values.

The scanner is shipped with the settings shown in [Appendix A, Standard Default Parameters](#). If the default values suit the requirements, programming is not necessary. To set feature values, scan single bar codes or short bar code sequences. Scanning parameter setting bar codes with the primary scanner also changes settings on the auxiliary scanner.

To return all features to their default values, scan the [Set All Defaults](#) bar code on page 4-5.

If not using a Synapse or USB cable, select a host type. Refer to each host chapter for specific host information.

Scanning Sequence Examples

In most cases scanning one bar code sets a specific parameter value. For example, to transmit bar code data without the UPC-A check digit, simply scan the **Do Not Transmit UPC-A Check Digit** bar code listed under [Transmit UPC-A/UPC-E/UPC-E1 Check Digit on page 13-23](#). The scanner issues a short high beep and the LED turns green, signifying a successful parameter entry.

Other parameters, such as **Set Length(s) for D 2 of 5** require scanning several bar codes in sequence. See the individual parameter, like **Set Length(s) for D 2 of 5**, for this procedure.

Errors While Scanning

Unless otherwise specified, if an error occurs during a scanning sequence, just re-scan the correct parameter.

Symbology Default Parameters

[Table 13-1](#) lists the defaults for all symbologies parameters. To change any option, scan the appropriate bar code(s) provided in this chapter.



Scanning parameter setting bar codes with the primary scanner also changes settings on the auxiliary scanner.

See [Appendix A, Standard Default Parameters](#) for all user preferences, hosts, symbologies and miscellaneous default parameters

Table 13-1. Symbology Default Parameters Table

Parameter	Default	Page Number
UPC/EAN		
UPC-A	Enable	13-7
UPC-E	Enable	13-8
UPC-E1	Disable	13-9
EAN-8/JAN-8	Enable	13-10
EAN-13/JAN-13	Enable	13-10
Bookland EAN	Disable	13-12
¹ User selection is required to configure this interface and this is the most common selection.		

Table 13-1. Symbology Default Parameters Table (Continued)

Parameter	Default	Page Number
Decode UPC/EAN Supplementals (2 and 5 digits)	Ignore	13-13
Decode UPC/EAN Supplemental Redundancy	20	13-22
Transmit UPC-A Check Digit	Transmit	13-23
Transmit UPC-E Check Digit	Transmit	13-24
Transmit UPC-E1 Check Digit	Transmit	13-24
UPC-A Preamble	System Character	13-26
UPC-E Preamble	System Character	13-27
UPC-E1 Preamble	System Character	13-29
Convert UPC-E to A	Disable	13-31
Convert UPC-E1 to A	Disable	13-32
EAN-8 Zero Extend	Disable	13-33
Bookland ISBN Format	ISBN-10	13-34
UCC Coupon Extended Code	Disable	13-35
Code 128		
Code 128	Enable	13-36
UCC/EAN-128	Enable	13-37
ISBT 128 (non-concatenated)	Enable	13-38
Code 128 Decode Performance	Enable	13-39
Code 128 Decode Performance Level	Level 3	13-40
Code 39		
Code 39	Enable	13-42
Trioptic Code 39	Disable	13-43
Convert Code 39 to Code 32 (Italian Farmer Code)	Disable	13-44
Code 32 Prefix	Disable	13-45
Set Length(s) for Code 39	2 to 55	13-46
Code 39 Check Digit Verification	Disable	13-48
Transmit Code 39 Check Digit	Do Not Transmit	13-49
Code 39 Full ASCII Conversion	Disable	13-50
¹ User selection is required to configure this interface and this is the most common selection.		

Table 13-1. Symbology Default Parameters Table (Continued)

Parameter	Default	Page Number
Buffer Code 39	Disable	13-51
Code 39 Decode Performance	Enable	13-55
Code 39 Decode Performance Level	Level 3	13-56
Code 93		
Code 93	Disable	13-58
Set Length(s) for Code 93	4 to 55	13-59
Code 11		
Code 11	Disable	13-61
Set Lengths for Code 11	4 to 55	13-62
Code 11 Check Digit Verification	Disable	13-64
Transmit Code 11 Check Digit	Do Not Transmit	13-66
Interleaved 2 of 5 (ITF)		
Interleaved 2 of 5 (ITF)	Disable	13-67
Set Length(s) for I 2 of 5	14	13-68
I 2 of 5 Check Digit Verification	Disable	13-70
Transmit I 2 of 5 Check Digit	Do Not Transmit	13-72
Convert I 2 of 5 to EAN 13	Disable	13-73
Discrete 2 of 5 (DTF)		
Discrete 2 of 5	Disable	13-74
Set Length(s) for D 2 of 5	12	13-75
Codabar (NW - 7)		
Codabar	Disable	13-78
Set Lengths for Codabar	5 to 55	13-79
CLSI Editing	Disable	13-82
NOTIS Editing	Disable	13-83
RSS (Reduced Space Symbology)		
RSS 14	Enable	13-84
RSS Limited	Disable	13-85
¹ User selection is required to configure this interface and this is the most common selection.		

Table 13-1. Symbology Default Parameters Table (Continued)

Parameter	Default	Page Number
RSS Expanded	Enable	13-86
Convert RSS to UPC/EAN	Disable	13-87
Symbology - Specific Security Levels		
Redundancy Security Levels	1	13-88
Security Level	1	13-91
Bi-directional Redundancy	Disable	13-93
Symbology - Intercharacter Gap		
Intercharacter Gaps	Normal	13-94
¹ User selection is required to configure this interface and this is the most common selection.		

UPC/EAN

Enable/Disable UPC-A/UPC-E

To enable or disable UPC-A or UPC-E, scan the appropriate bar code below.

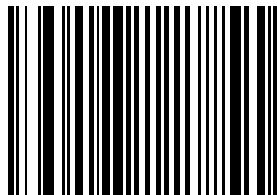

***Enable UPC-A**

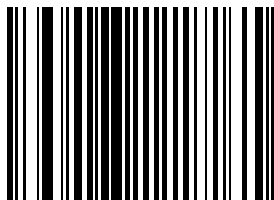

Disable UPC-A

Enable/Disable UPC-A/UPC-E (continued)

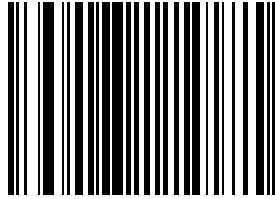

***Enable UPC-E**

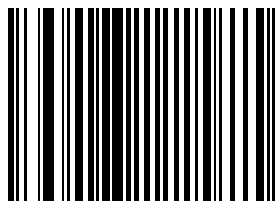

Disable UPC-E

Enable/Disable UPC-E1

To enable or disable UPC-E1, scan the appropriate bar code below.



UPC-E1 is not a UCC (Uniform Code Council) approved symbology.

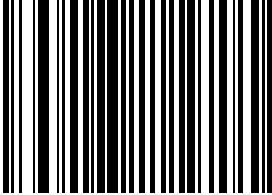

Enable UPC-E1

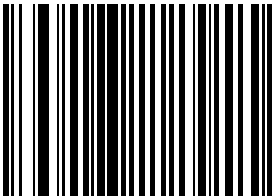

***Disable UPC-E1**

Enable/Disable EAN-13/JAN-13/EAN-8/JAN-8

To enable or disable EAN-13/JAN-13 or EAN-8/JAN-8, scan the appropriate bar code below.

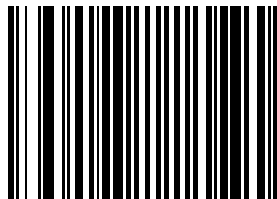

***Enable EAN-13/JAN-13**

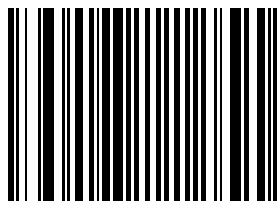

Disable EAN-13/JAN-13

Enable/Disable EAN-13/JAN-13/EAN-8/JAN-8 (continued)

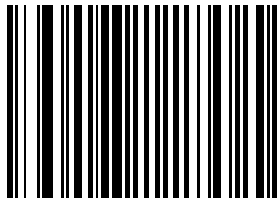

***Enable EAN-8/JAN-8**

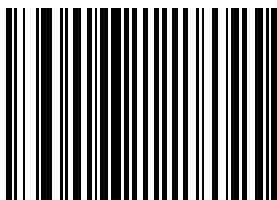

Disable EAN-8/JAN-8

Enable/Disable Bookland EAN

To enable or disable Bookland EAN, scan the appropriate bar code below.

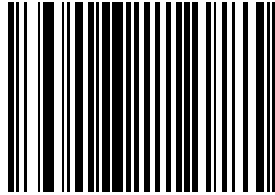

Enable Bookland EAN

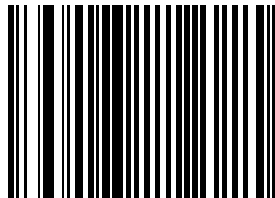

***Disable Bookland EAN**



If you enable Bookland EAN, select a [Bookland ISBN Format on page 13-34](#). Also select either Decode UPC/EAN Supplementals, Autodiscriminate UPC/EAN Supplementals, or Enable 978/979 Supplemental Mode in [Decode UPC/EAN Supplementals on page 13-13](#).

Decode UPC/EAN Supplementals

Supplementals are bar codes appended according to specific format conventions (e.g., UPC-A+2, UPC-E+2, EAN 13+2). The following options are available:

- If you select **Ignore UPC/EAN with Supplementals**, and the scanner is presented with a UPC/EAN plus supplemental symbol, the scanner decodes UPC/EAN and ignores the supplemental characters.
- If you select **Decode UPC/EAN with Supplementals**, the scanner only decodes UPC/EAN symbols with supplemental characters, and ignores symbols without supplementals.
- If you select **Autodiscriminate UPC/EAN Supplementals**, the scanner decodes UPC/EAN symbols with supplemental characters immediately. If the symbol does not have a supplemental, the scanner must decode the bar code the number of times set via [UPC/EAN Supplemental Redundancy on page 13-22](#) before transmitting its data to confirm that there is no supplemental.
- If you select one of the following **Supplemental Mode** options, the scanner immediately transmits EAN-13 bar codes starting with that prefix that have supplemental characters. If the symbol does not have a supplemental, the scanner must decode the bar code the number of times set via [UPC/EAN Supplemental Redundancy on page 13-22](#) before transmitting its data to confirm that there is no supplemental. The scanner transmits UPC/EAN bar codes that do not have that prefix immediately.
 - **Enable 378/379 Supplemental Mode**
 - **Enable 978/979 Supplemental Mode**



If you select 978/979 Supplemental Mode and are scanning Bookland EAN bar codes, see [Enable/Disable Bookland EAN on page 13-12](#) to enable Bookland EAN, and select a format using [Bookland ISBN Format on page 13-34](#).

- **Enable 977 Supplemental Mode**
- **Enable 414/419/434/439 Supplemental Mode**
- **Enable 491 Supplemental Mode**
- **Enable Smart Supplemental Mode** - applies to EAN-13 bar codes starting with any prefix listed previously.
- **Supplemental User-Programmable Type 1** - applies to EAN-13 bar codes starting with a 3-digit user-defined prefix. Set this 3-digit prefix using **Supplemental User-Programmable 1**.
- **Supplemental User-Programmable Type 1 and 2** - applies to EAN-13 bar codes starting with either of two 3-digit user-defined prefixes. Set the 3-digit prefixes using **Supplemental User-Programmable 1** and **Supplemental User-Programmable 2**.
- **Smart Supplemental Plus User-Programmable 1** - applies to EAN-13 bar codes starting with any prefix listed previously or the user-defined prefix set using **Supplemental User-Programmable 1**.
- **Smart Supplemental Plus User-Programmable 1 and 2** - applies to EAN-13 bar codes starting with any prefix listed previously or one of the two user-defined prefixes set using **Supplemental User-Programmable 1** and **Supplemental User-Programmable 2**.
- Select **Supplemental User-Programmable 1** to set a 3-digit prefix. Then select the 3 digits using the numeric bar codes beginning on page [D-1](#).
- Select **Supplemental User-Programmable 2** to set a second 3-digit prefix. Then select the 3 digits using the numeric bar codes beginning on page [D-1](#).



To minimize the risk of invalid data transmission, select either to decode or ignore supplemental characters.

Decode UPC/EAN Supplementals (continued)

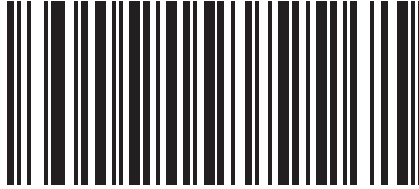

***Ignore UPC/EAN With Supplementals**

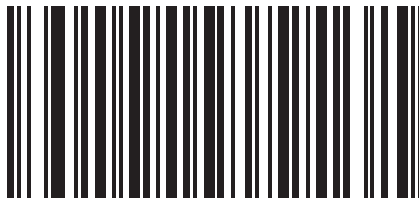

Decode UPC/EAN Only With Supplementals

Decode UPC/EAN Supplementals (continued)

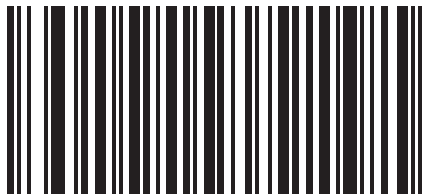

Autodiscriminate UPC/EAN Supplementals

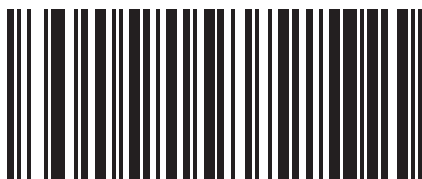

Enable 378/379 Supplemental Mode

Decode UPC/EAN Supplementals (continued)

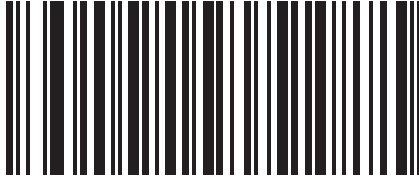

Enable 978/979 Supplemental Mode

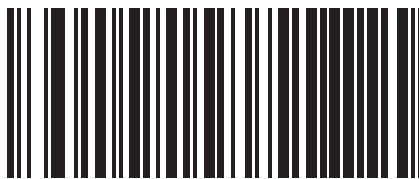

Enable 977 Supplemental Mode

Decode UPC/EAN Supplementals (continued)

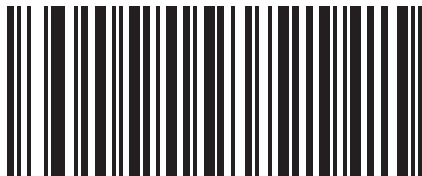

Enable 414/419/434/439 Supplemental Mode

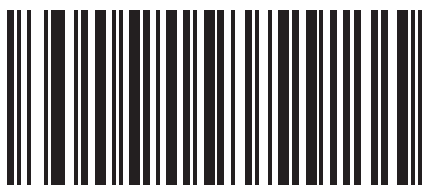

Enable 491 Supplemental Mode

Decode UPC/EAN Supplementals (continued)



Enable Smart Supplemental Mode

Decode UPC/EAN Supplementals (continued)

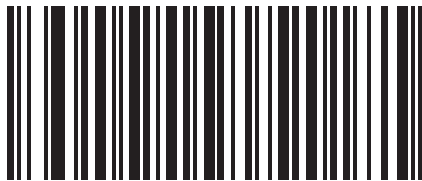

Supplemental User-Programmable Type 1



Supplemental User-Programmable Type 1 and 2

Decode UPC/EAN Supplementals (continued)



Smart Supplemental Plus User-Programmable 1

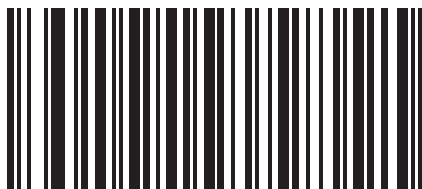

Smart Supplemental Plus User-Programmable 1 and 2

Decode UPC/EAN Supplementals (continued)



Supplemental User-Programmable 1



Supplemental User-Programmable 2

UPC/EAN Supplemental Redundancy

With **Autodiscriminate UPC/EAN Supplementals** or one of the supplemental modes selected, this option adjusts the number of times a symbol without supplementals is decoded before transmission. The range is from two to thirty times. Five or above is recommended when decoding a mix of UPC/EAN symbols with and without supplementals, and the autodiscriminate option is selected. The default is set at 20.

Scan the bar code below to set a decode redundancy value. Next, scan two numeric bar codes beginning on page [D-1](#) in [Appendix D, Numeric Bar Codes](#). Single digit numbers must have a leading zero. If an error occurs, or to change the selection, scan **Cancel** on page [D-8](#).

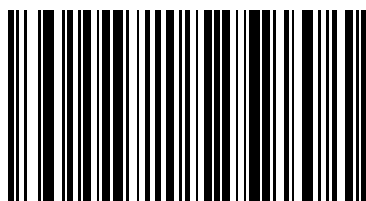

UPC/EAN Supplemental Redundancy

Transmit UPC-A/UPC-E/UPC-E1 Check Digit

The check digit is the last character of the symbol used to verify the integrity of the data. Scan the appropriate bar code below to transmit the bar code data with or without the UPC-A, UPC-E or UPC-E1 check digit. It is always verified to guarantee the integrity of the data.

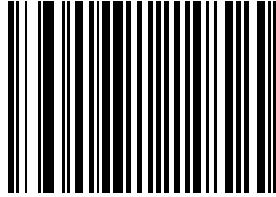

***Transmit UPC-A Check Digit**

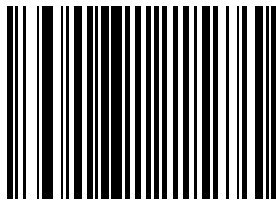

Do Not Transmit UPC-A Check Digit

Transmit UPC-A/UPC-E/UPC-E1 Check Digit (continued)

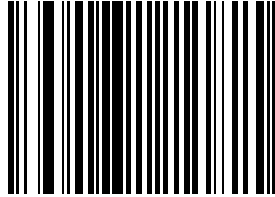

***Transmit UPC-E Check Digit**

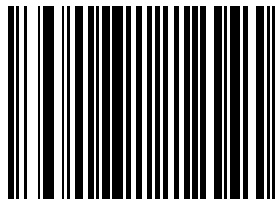

Do Not Transmit UPC-E Check Digit

Transmit UPC-A/UPC-E/UPC-E1 Check Digit (continued)

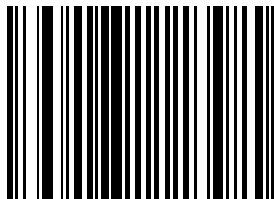

***Transmit UPC-E1 Check Digit**

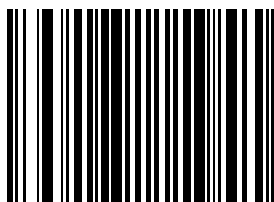

Do Not Transmit UPC-E1 Check Digit

UPC-A Preamble

Preamble characters are part of the UPC symbol consisting of Country Code and System Character. Three options are given for transmitting UPC-A preamble to the host device: transmit System Character only, transmit System Character and Country Code ("0" for USA), and no preamble transmitted. Select the appropriate option to match the host system.

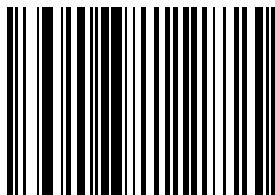

No Preamble
(<DATA>)

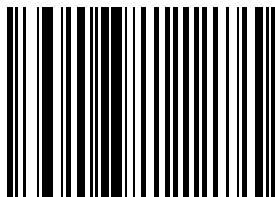

***System Character**
(<SYSTEM CHARACTER> <DATA>)

UPC-A Preamble (continued)

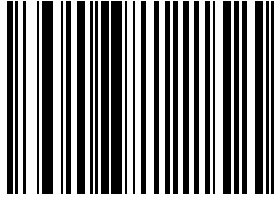

System Character & Country Code
(< COUNTRY CODE> <SYSTEM CHARACTER> <DATA>)

UPC-E Preamble

Preamble characters are part of the UPC symbol consisting of Country Code and System Character. Three options are given for transmitting UPC-E preamble to the host device: transmit System Character only, transmit System Character and Country Code ("0" for USA), and no preamble transmitted. Select the appropriate option to match the host system.

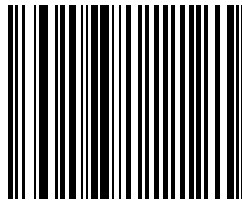

No Preamble
(<DATA>)

UPC-E Preamble (continued)

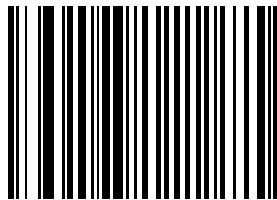

***System Character**
(<SYSTEM CHARACTER> <DATA>)

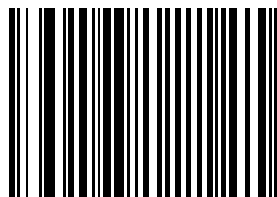

System Character & Country Code
(< COUNTRY CODE> <SYSTEM CHARACTER> <DATA>)

UPC-E1 Preamble

Preamble characters are part of the UPC symbol consisting of Country Code and System Character. Three options are given for transmitting UPC-E1 preamble to the host device: transmit System Character only, transmit System Character and Country Code ("0" for USA), and no preamble transmitted. Select the appropriate option to match the host system.

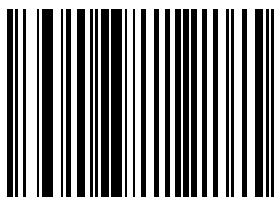

No Preamble
(<DATA>)

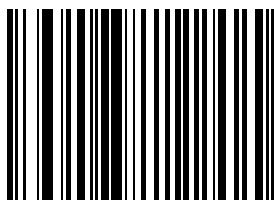

***System Character**
(<SYSTEM CHARACTER> <DATA>)

UPC-E1 Preamble (continued)

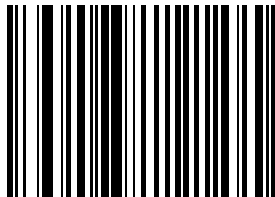

System Character & Country Code
(< COUNTRY CODE> <SYSTEM CHARACTER> <DATA>)

Convert UPC-E to UPC-A

When enabled, UPC-E (zero suppressed) decoded data is converted to UPC-A format before transmission. After conversion, the data follows UPC-A format and is affected by UPC-A programming selections (e.g., Preamble, Check Digit).

When disabled, UPC-E decoded data is transmitted as UPC-E data, without conversion.

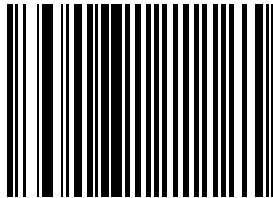

**Convert UPC-E to UPC-A
(Enable)**

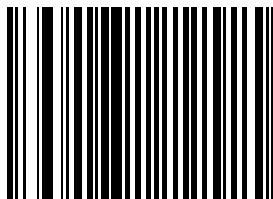

***Do Not Convert UPC-E to UPC-A
(Disable)**

Convert UPC-E1 to UPC-A

When enabled, UPC-E1 decoded data is converted to UPC-A format before transmission. After conversion, the data follows UPC-A format and is affected by UPC-A programming selections (e.g., Preamble, Check Digit).

When disabled, UPC-E1 decoded data is transmitted as UPC-E1 data, without conversion.

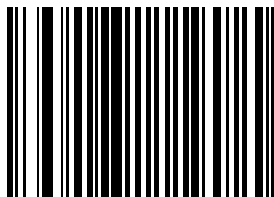

**Convert UPC-E1 to UPC-A
(Enable)**

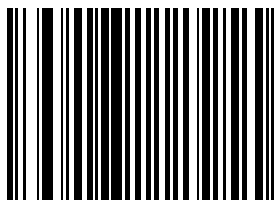

***Do Not Convert UPC-E1 to UPC-A
(Disable)**

EAN Zero Extend

When enabled, this parameter adds five leading zeros to decoded EAN-8 symbols to make them compatible in format to EAN-13 symbols.

When disabled, EAN-8 symbols are transmitted as is.

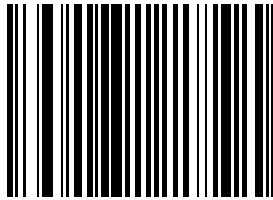

Enable EAN Zero Extend

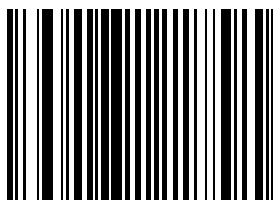

***Disable EAN Zero Extend**

Bookland ISBN Format

If you enabled Bookland EAN using [Enable/Disable Bookland EAN on page 13-12](#), select one of the following formats for Bookland data:

- **Bookland ISBN-10** - The scanner reports Bookland data starting with 978 in traditional 10-digit format with the special Bookland check digit for backward-compatibility. Data starting with 979 is not considered Bookland in this mode.
- **Bookland ISBN-13** - The scanner reports Bookland data (starting with either 978 or 979) as EAN-13 in 13-digit format to meet the 2007 ISBN-13 protocol.

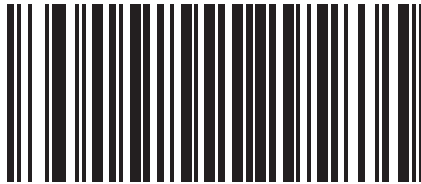

***Bookland ISBN-10**



Bookland ISBN-13



Note

For Bookland EAN to function properly, first enable Bookland EAN using [Enable/Disable Bookland EAN on page 13-12](#), then select either Decode UPC/EAN Supplementals, Autodiscriminate UPC/EAN Supplementals, or Enable 978/979 Supplemental Mode in [Decode UPC/EAN Supplementals on page 13-13](#).

UCC Coupon Extended Code

The UCC Coupon Extended Code is an additional bar code adjacent to a UCC Coupon Code. To enable or disable UCC Coupon Extended Code, scan the appropriate bar code below.

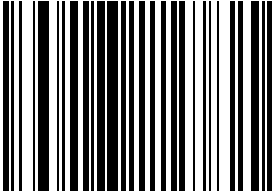

Enable UCC Coupon Extended Code

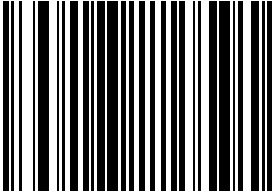

***Disable UCC Coupon Extended Code**

Code 128

Enable/Disable Code 128

To enable or disable Code 128, scan the appropriate bar code below.

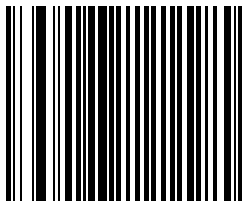

***Enable Code 128**

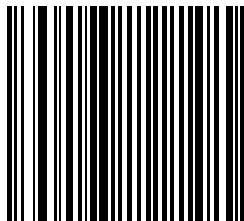

Disable Code 128

Enable/Disable UCC/EAN-128

To enable or disable UCC/EAN-128, scan the appropriate bar code below.

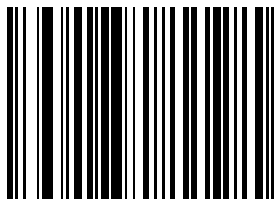

***Enable UCC/EAN-128**

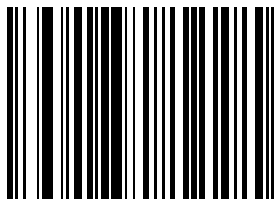

Disable UCC/EAN-128

Enable/Disable ISBT 128

ISBT 128 is a variant of Code 128 used in the blood banking industry. To enable or disable ISBT 128, scan the appropriate bar code below. Concatenation of the ISBT data, if required, must be performed in the host.

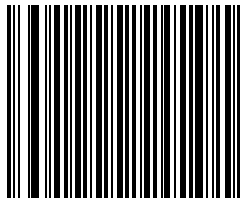

***Enable ISBT 128**



Disable ISBT 128

Code 128 Decode Performance

This option offers three levels of decode performance or “aggressiveness” for Code 128 symbols. Increasing the performance level reduces the amount of required bar code orientation, which is useful when scanning very long and/or truncated bar codes. Increased levels reduce decode security.

If this option is enabled, select a Decode Performance level from the following pages to suit performance needs.



***Enable Code 128 Decode Performance**



Disable Code 128 Decode Performance

Code 128 Decode Performance Level

This option offers three levels of decode performance or “aggressiveness” for Code 128 symbols. Increasing the performance level reduces the amount of required bar code orientation, which is useful when scanning very long and/or truncated bar codes. Increased levels reduce decode security.

This option must be enabled (see Code 128 Decode Performance Enable).

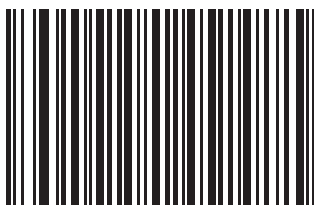

Code 128 Decode Performance Level 1



Code 128 Decode Performance Level 2

Code 128 Decode Performance Level (continued)

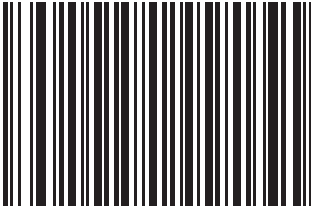

***Code 128 Decode Performance Level 3**

Code 39

Enable/Disable Code 39

To enable or disable Code 39, scan the appropriate bar code below.

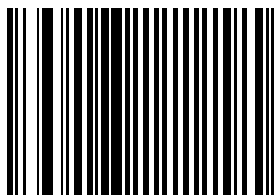

***Enable Code 39**

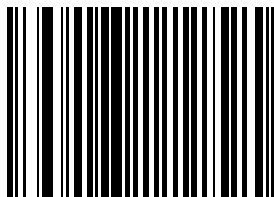

Disable Code 39



Note

When a large gap bar code is encountered, refer to [Symbology - Intercharacter Gap on page 13-94](#).

Enable/Disable Trioptic Code 39

Trioptic Code 39 is a variant of Code 39 used in the marking of computer tape cartridges. Trioptic Code 39 symbols always contain six characters. To enable or disable Trioptic Code 39, scan the appropriate bar code below.

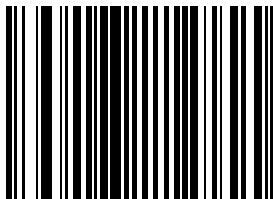

Enable Trioptic Code 39

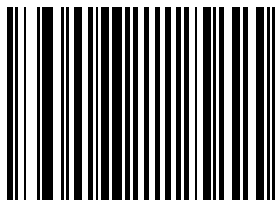

***Disable Trioptic Code 39**



Note

Trioptic Code 39 and Code 39 Full ASCII should not be enabled simultaneously.

Convert Code 39 to Code 32

Code 32 is a variant of Code 39 used by the Italian pharmaceutical industry. Scan the appropriate bar code below to enable or disable converting Code 39 to Code 32.

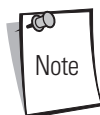

Code 39 must be enabled in order for this parameter to function.

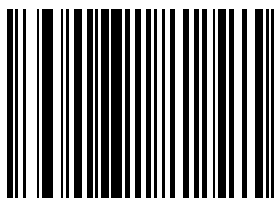

Enable Convert Code 39 to Code 32

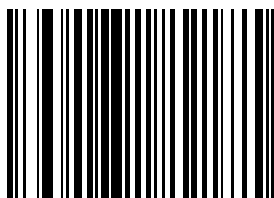

***Disable Convert Code 39 to Code 32**

Code 32 Prefix

Scan the appropriate bar code below to enable or disable adding the prefix character "A" to all Code 32 bar codes.



Convert Code 39 to Code 32 must be enabled for this parameter to function.

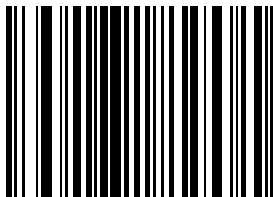

Enable Code 32 Prefix

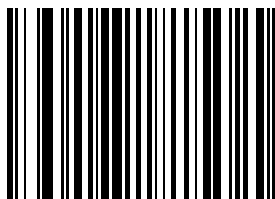

***Disable Code 32 Prefix**

Set Lengths for Code 39

The length of a code refers to the number of characters (i.e., human readable characters), including check digit(s) the code contains. Lengths for Code 39 may be set for any length, one or two discrete lengths, or lengths within a specific range. If Code 39 Full ASCII is enabled, **Length Within a Range** or **Any Length** are the preferred options.



When setting lengths for different bar code types by scanning single digit numbers, single digit numbers must always be preceded by a leading zero.

One Discrete Length - This option allows decoding of only those Code 39 symbols containing a selected length. Lengths are selected from the numeric bar codes beginning on page [D-1](#) in [Appendix D, Numeric Bar Codes](#). For example, to decode only Code 39 symbols with 14 characters, scan **Code 39 - One Discrete Length**, then scan **1** followed by **4**. If an error occurs, or to change the selection, scan **Cancel** on page [D-8](#).

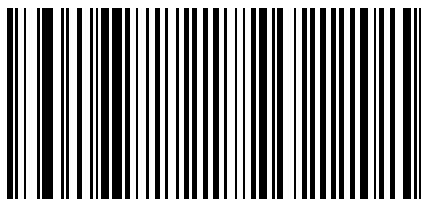

Code 39 - One Discrete Length

Two Discrete Lengths - This option allows decoding of only those Code 39 symbols containing either of two selected lengths. Lengths are selected from the numeric bar codes beginning on page [D-1](#) in [Appendix D, Numeric Bar Codes](#). For example, to decode only those Code 39 symbols containing either 2 or 14 characters, select **Code 39 - Two Discrete Lengths**, then scan **0**, **2**, **1**, and then **4**. If an error occurs, or to change the selection, scan **Cancel** on page [D-8](#).

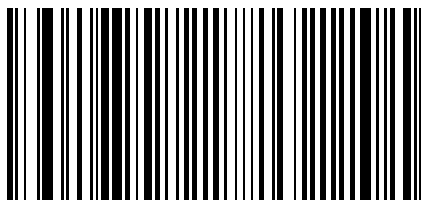

Code 39 - Two Discrete Lengths

Set Lengths for Code 39 (continued)

Length Within Range - This option allows decoding of a Code 39 symbol with a specific length range. The length range is selected from numeric bar codes beginning on page D-1 in [Appendix D, Numeric Bar Codes](#). For example, to decode Code 39 symbols containing between 4 and 12 characters, first scan **Code 39 - Length Within Range**. Then scan **0, 4, 1, and 2** (single digit numbers must always be preceded by a leading zero). If an error occurs, or to change the selection, scan **Cancel** on page D-8.

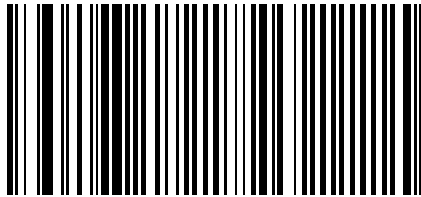

Code 39 - Length Within Range

Any Length - Scanning this option allows decoding of Code 39 symbols containing any number of characters within the scanner capability.

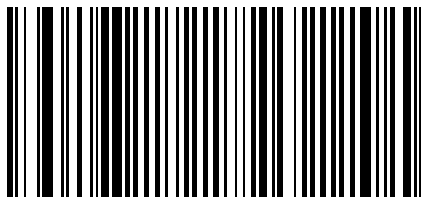

Code 39 - Any Length

Code 39 Check Digit Verification

When this feature is enabled, the scanner checks the integrity of all Code 39 symbols to verify that the data complies with specified check digit algorithm. Only those Code 39 symbols which include a modulo 43 check digit are decoded when this feature is enabled. This feature should only be enabled if the code 39 symbols contain a modulo 43 check digit.

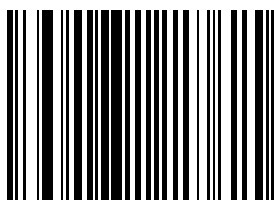

Enable Code 39 Check Digit

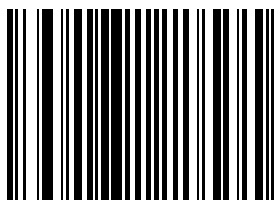

***Disable Code 39 Check Digit**

Transmit Code 39 Check Digit

Scan a bar code below to transmit Code 39 data with or without the check digit.

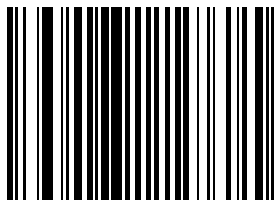

**Transmit Code 39 Check Digit
(Enable)**

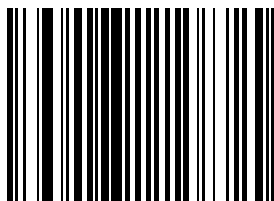

***Do Not Transmit Code 39 Check Digit
(Disable)**



Note

Code 39 Check Digit Verification must be enabled for this parameter to function.

Enable/Disable Code 39 Full ASCII

Code 39 Full ASCII is a variant of Code 39 which pairs characters to encode the full ASCII character set. To enable or disable Code 39 Full ASCII, scan the appropriate bar code below.

Code 39 Full ASCII to Full ASCII Correlation is host-dependent, and therefore described in the "ASCII Character Set" Table for the appropriate interface.

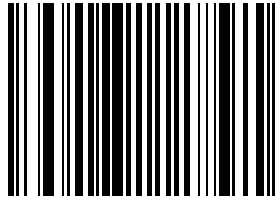

Enable Code 39 Full ASCII

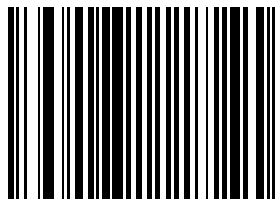

***Disable Code 39 Full ASCII**



Note

Trioctic Code 39 and Code 39 Full ASCII should not be enabled simultaneously.

Code 39 Buffering (Scan & Store)

This feature allows the scanner to accumulate data from multiple Code 39 symbols.

When the Scan and Store option (Buffer Code 39) is selected, all Code 39 symbols having a leading space as a first character are temporarily buffered in the unit to be transmitted later. The leading space is not buffered.

Decode of a valid Code 39 symbol with no leading space causes transmission in sequence of all buffered data in a first-in first-out format, plus transmission of the “triggering” symbol. See the following pages for further details.

When the **Do Not Buffer Code 39** option is selected, all decoded Code 39 symbols are transmitted immediately without being stored in the buffer.

This feature affects Code 39 only. If **Buffer Code 39** is selected, Motorola recommends configuring the scanner to decode Code 39 symbology only.

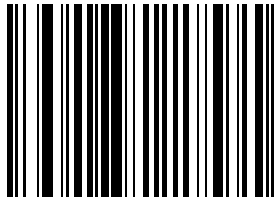

**Buffer Code 39
(Enable)**

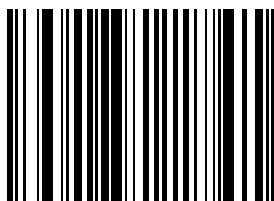

***Do Not Buffer Code 39**

While there is data in the transmission buffer, selecting **Do Not Buffer Code 39** is not allowed. The buffer holds 200 bytes of information.

To disable Code 39 buffering when there is data in the transmission buffer, first force the buffer transmission (see [Transmit Buffer on page 13-53](#)) or clear the buffer.

Buffer Data

To buffer data, Code 39 buffering must be enabled and a Code 39 symbol must be read with a space immediately following the start pattern.

- Unless the data overflows the transmission buffer, the scanner issues a lo/hi beep to indicate successful decode and buffering. (For overflow conditions, see [Overfilling Transmission Buffer](#).)
- The scanner adds the decoded data excluding the leading space to the transmission buffer.
- No transmission occurs.

Clear Transmission Buffer

To clear the transmission buffer, scan the **Clear Buffer** bar code below, which contains only a start character, a dash (minus), and a stop character.

- The scanner issues a short hi/lo/hi beep.
- The scanner erases the transmission buffer.
- No transmission occurs.

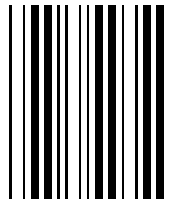

Clear Buffer

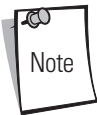

The Clear Buffer contains only the dash (minus) character. In order to scan this command, be sure Code 39 length is set to include length 1.

Transmit Buffer

There are two methods to transmit the Code 39 buffer.

1. Scan the **Transmit Buffer** bar code below. Only a start character, a plus (+), and a stop character.

- The scanner transmits and clears the buffer.
- The scanner issues a lo/hi beep.

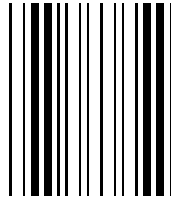

Transmit Buffer

2. Scan a Code 39 bar code with a leading character other than a space.

- The scanner issues a hi/lo beep to indicate a good decode and that buffering of the decode data has occurred.
- The scanner transmits and clears the buffer.
- The scanner signals that the buffer was transmitted with a lo/hi beep.



Note

The Transmit Buffer contains only a plus (+) character. In order to scan this command, be sure Code 39 length is set to include length 1.

Overfilling Transmission Buffer

The Code 39 buffer holds 200 characters. If the symbol just read results in an overflow of the transmission buffer:

- The scanner indicates that the symbol was rejected by issuing three long, high beeps.
- No transmission occurs. The data in the buffer is not affected.

Attempt to Transmit an Empty Buffer

If the symbol just read was the **Transmit Buffer** symbol and the Code 39 buffer is empty:

- A short lo/hi/lo beep signals that the buffer is empty.
- No transmission occurs.
- The buffer remains empty.

Code 39 Decode Performance

This option offers three levels of decode performance or “aggressiveness” for Code 39 symbols. Increasing the performance level reduces the amount of required bar code orientation, which is useful when scanning very long and/or truncated bar codes. Increased levels reduce decode security.

If this option is enabled, it is possible to select a Decode Performance level from the following pages to suit performance needs.



This option only works with Code 39 One Discrete Length.

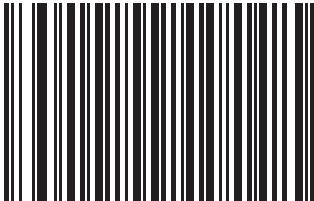

***Enable Code 39 Decode Performance**

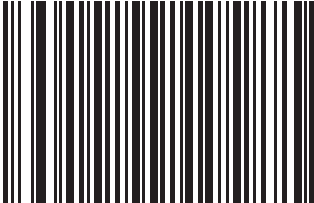

Disable Code 39 Decode Performance

Code 39 Decode Performance Level

This option offers three levels of decode performance or “aggressiveness” for Code 39 symbols. Increasing the performance level reduces the amount of required bar code orientation, which is useful when scanning very long and/or truncated bar codes. Increased levels reduce decode security.

This option must be enabled (see Code 39 Decode Performance).

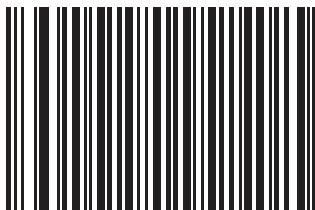

Code 39 Decode Performance Level 1



Code 39 Decode Performance Level 2

Code 39 Decode Performance Level (continued)

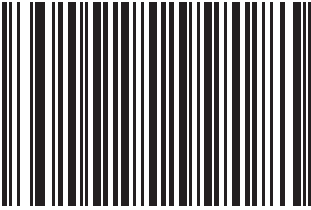

***Code 39 Decode Performance Level 3**

Code 93

Enable/Disable Code 93

To enable or disable Code 93, scan the appropriate bar code below.

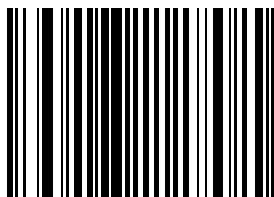

Enable Code 93

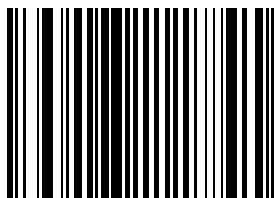

***Disable Code 93**

Set Lengths for Code 93

The length of a code refers to the number of characters (i.e., human readable characters), including check digit(s) the code contains. Lengths for Code 93 may be set for any length, one or two discrete lengths, or lengths within a specific range. discrete lengths, or lengths within a specific range.



When setting lengths for different bar code types by scanning single digit numbers, single digit numbers must always be preceded by a leading zero.

One Discrete Length - This option allows decoding of only those Code 93 symbols containing a selected length. Lengths are selected from the numeric bar codes beginning on page [D-1](#) in [Appendix D, Numeric Bar Codes](#). For example, to decode only Code 93 symbols with 14 characters, scan **Code 93 - One Discrete Length**, then scan **1** followed by **4**. If an error occurs, or to change the selection, scan **Cancel** on page [D-8](#).

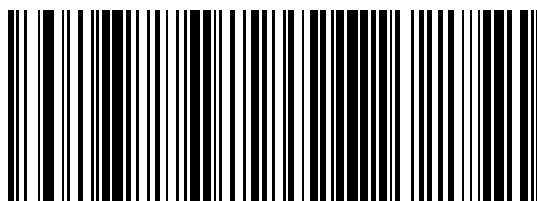

Code 93 - One Discrete Length

Two Discrete Lengths - This option allows decoding of only those Code 93 symbols containing either of two selected lengths. Lengths are selected from the numeric bar codes beginning on page [D-1](#) in [Appendix D, Numeric Bar Codes](#). For example, to decode only those Code 93 symbols containing either 2 or 14 characters, select **Code 93 - Two Discrete Lengths**, then scan **0, 2, 1**, and then **4**. If an error occurs, or to change the selection, scan **Cancel** on page [D-8](#).

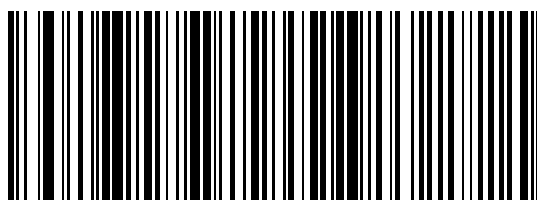

Code 93 - Two Discrete Lengths

Set Lengths for Code 93 (continued)

Length Within Range - This option allows decoding of a Code 93 symbol with a specific length range. The length range is selected from numeric bar codes beginning on page [D-1](#) in [Appendix D, Numeric Bar Codes](#). For example, to decode Code 93 symbols containing between 4 and 12 characters, first scan **Code 93 - Length Within Range**. Then scan **0, 4, 1,** and **2** (single digit numbers must always be preceded by a leading zero). If an error occurs, or to change the selection, scan **Cancel** on page [D-8](#).

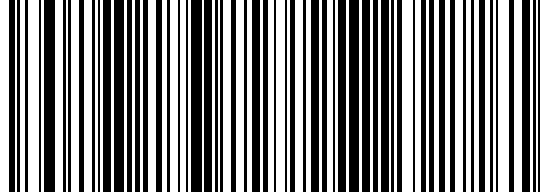

Code 93 - Length Within Range

Any Length - Scanning this option allows decoding of Code 93 symbols containing any number of characters within the scanner's capability.

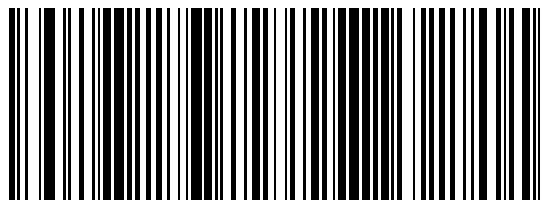

Code 93 - Any Length

Code 11

Enable/Disable Code 11

To enable or disable Code 11, scan the appropriate bar code below.

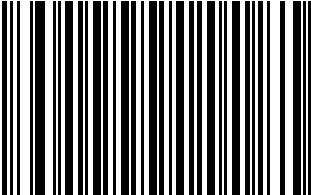

Enable Code 11

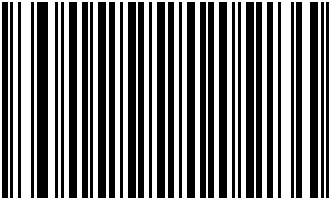

***Disable Code 11**

Set Lengths for Code 11

The length of a code refers to the number of characters (i.e., human readable characters), including check digit(s) the code contains. Lengths for Code 11 may be set for any length, one or two discrete lengths, or lengths within a specific range. discrete lengths, or lengths within a specific range.



When setting lengths for different bar code types by scanning single digit numbers, single digit numbers must always be preceded by a leading zero.

One Discrete Length - This option allows decoding of only those Code 11 symbols containing a selected length. Lengths are selected from the numeric bar codes beginning on page [D-1](#) in [Appendix D, Numeric Bar Codes](#). For example, to decode only Code 11 symbols with 14 characters, scan **Code 11 - One Discrete Length**, then scan **1** followed by **4**. If an error occurs, or to change the selection, scan **Cancel** on page [D-8](#).



Code 11 - One Discrete Length

Two Discrete Lengths - This option allows decoding of only those Code 11 symbols containing either of two selected lengths. Lengths are selected from the numeric bar codes beginning on page [D-1](#) in [Appendix D, Numeric Bar Codes](#). For example, to decode only those Code 11 symbols containing either 2 or 14 characters, select **Code 11 - Two Discrete Lengths**, then scan **0, 2, 1**, and then **4**. If an error occurs, or to change the selection, scan **Cancel** on page [D-8](#).



Code 11 - Two Discrete Lengths

Set Lengths for Code 11 (Continued)

Length Within Range - This option allows decoding of a Code 11 symbol with a specific length range. The length range is selected from numeric bar codes beginning on page D-1 in [Appendix D, Numeric Bar Codes](#). For example, to decode Code 11 symbols containing between 4 and 12 characters, first scan **Code 11 - Length Within Range**. Then scan **0, 4, 1,** and **2** (single digit numbers must always be preceded by a leading zero). If an error occurs, or to change the selection, scan **Cancel** on page D-8.



Code 11 - Length Within Range

Any Length - Scanning this option allows decoding of Code 11 symbols containing any number of characters within the scanner capability.



Code 11 - Any Length

Code 11 Check Digit Verification

This feature allows the scanner to check the integrity of all Code 11 symbols to verify that the data complies with the specified check digit algorithm. This selects the check digit mechanism for the decoded Code 11 bar code. The options are to check for one check digit, check for two check digits, or disable the feature.

To enable this feature, scan the bar code below corresponding to the number of check digits encoded in the Code 11 symbols.

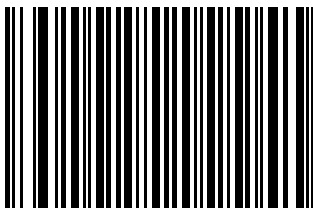

***Disable**

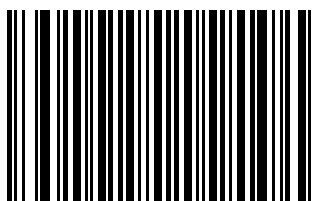

One Check Digit

Code 11 Check Digit Verification (continued)

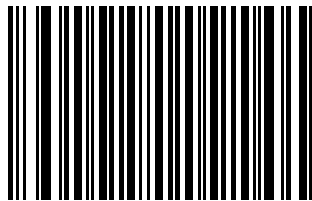

Two Check Digits

Transmit Code 11 Check Digits

This feature selects whether or not to transmit the Code 11 check digit(s).

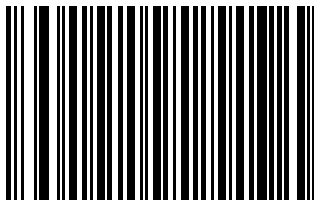

**Transmit Code 11 Check Digit
(Enable)**

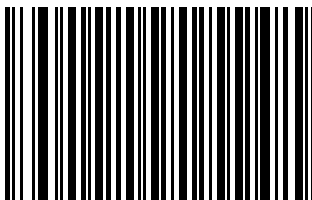

***Do Not Transmit Code 11 Check Digit
(Disable)**



Code 11 Check Digit Verification must be enabled for this parameter to function.

Interleaved 2 of 5 (ITF)

Enable/Disable Interleaved 2 of 5

To enable or disable Interleaved 2 of 5, scan the appropriate bar code below, and select an Interleaved 2 of 5 length from the following pages.

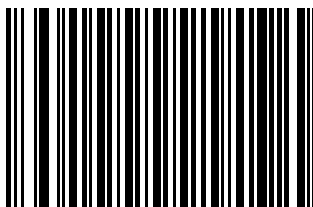

Enable Interleaved 2 of 5

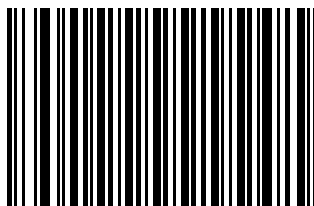

***Disable Interleaved 2 of 5**

Set Lengths for Interleaved 2 of 5

The length of a code refers to the number of characters (i.e., human readable characters), including check digit(s) the code contains. Lengths for I 2 of 5 may be set for any length, one or two discrete lengths, or lengths within a specific range.



Note

When setting lengths for different bar code types by scanning single digit numbers, single digit numbers must always be preceded by a leading zero.

One Discrete Length - This option allows decoding of only those I 2 of 5 symbols containing a selected length. Lengths are selected from the numeric bar codes beginning on page [D-1](#) in [Appendix D, Numeric Bar Codes](#). For example, to decode only I 2 of 5 symbols with 14 characters, scan **I 2 of 5 - One Discrete Length**, then scan **1** followed by **4**. If an error occurs, or to change the selection, scan **Cancel** on page [D-8](#).

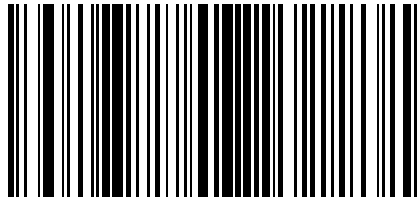

I 2 of 5 - One Discrete Length

Two Discrete Lengths - This option allows decoding of only those I 2 of 5 symbols containing either of two selected lengths. Lengths are selected from the numeric bar codes beginning on page [D-1](#) in [Appendix D, Numeric Bar Codes](#). For example, to decode only those I 2 of 5 symbols containing either 2 or 14 characters, select **I 2 of 5 - Two Discrete Lengths**, then scan **0, 2, 1**, and then **4**. If an error occurs, or to change the selection, scan **Cancel** on page [D-8](#).

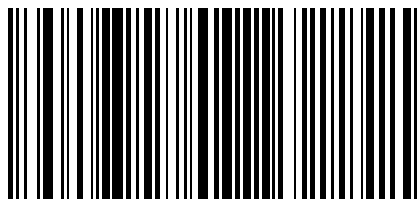

I 2 of 5 - Two Discrete Lengths

Set Lengths for Interleaved 2 of 5 (continued)

Length Within Range - This option allows decoding of an I 2 of 5 symbol with a specific length range. The length range is selected from numeric bar codes beginning on page D-1 in [Appendix D, Numeric Bar Codes](#). For example, to decode I 2 of 5 symbols containing between 4 and 12 characters, first scan **I 2 of 5 - Length Within Range**. Then scan **0, 4, 1, and 2** (single digit numbers must always be preceded by a leading zero). If an error occurs, or to change the selection, scan **Cancel** on page D-8.

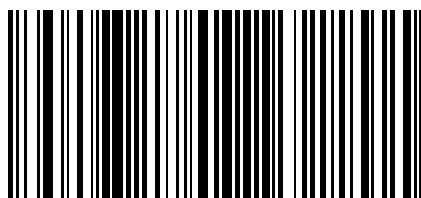

I 2 of 5 - Length Within Range

Any Length - Scanning this option allows decoding of I 2 of 5 symbols containing any number of characters within the scanner capability.



Due to the construction of the I 2 of 5 symbology, it is possible for a scan line covering only a portion of the code to be interpreted as a complete scan, yielding less data than is actually encoded in the bar code. To prevent this from happening, it is strongly recommended that specific lengths (**I 2 of 5 - One Discrete Length - Two Discrete Lengths**) be selected for I 2 of 5 applications.

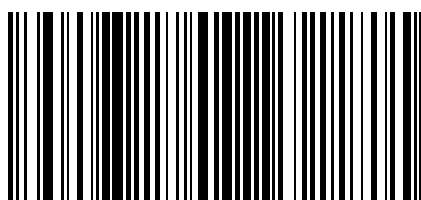

I 2 of 5 - Any Length

12 of 5 Check Digit Verification

When this feature is enabled, the scanner checks the integrity of all 12 of 5 symbols to verify the data complies with either the specified Uniform Symbology Specification (USS), or the Optical Product Code Council (OPCC) check digit algorithm.

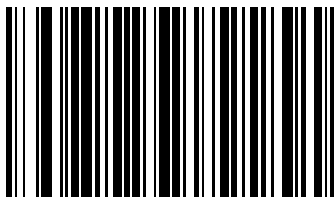

***Disable**

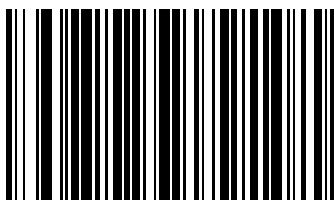

USS Check Digit

12 of 5 Check Digit Verification (continued)

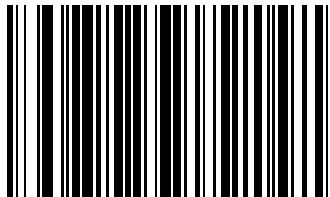

OPCC Check Digit

Transmit 1 2 of 5 Check Digit

Scan the appropriate bar code below to transmit 1 2 of 5 data with or without the check digit.

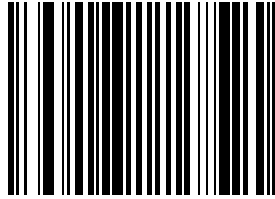

**Transmit 1 2 of 5 Check Digit
(Enable)**

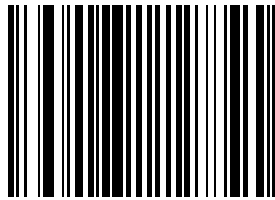

***Do Not Transmit 1 2 of 5 Check Digit
(Disable)**

Convert I 2 of 5 to EAN-13

This parameter converts a 14 character I 2 of 5 code into EAN-13, and transmits to the host as EAN-13. In order to accomplish this, the I 2 of 5 code must be enabled, and the code must have a leading zero and a valid EAN-13 check digit.

Scanning a single bar code below, **Convert I 2 of 5 to EAN-13 (Enable)**, accomplishes this function.

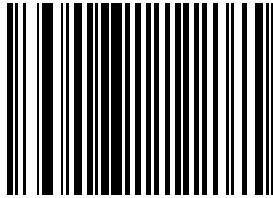

**Convert I 2 of 5 to EAN-13
(Enable)**

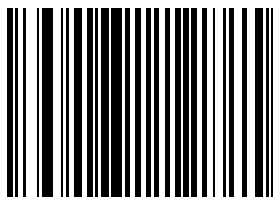

***Do Not Convert I 2 of 5 to EAN-13
(Disable)**

Discrete 2 of 5 (DTF)

Enable/Disable Discrete 2 of 5

To enable or disable Discrete 2 of 5, scan the appropriate bar code below.

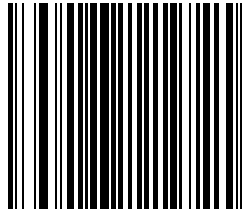

Enable Discrete 2 of 5

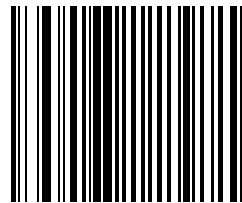

***Disable Discrete 2 of 5**

Set Lengths for Discrete 2 of 5

The length of a code refers to the number of characters (i.e., human readable characters), including check digit(s) the code contains. Lengths for D 2 of 5 may be set for any length, one or two discrete lengths, or lengths within a specific range.



When setting lengths for different bar code types by scanning single digit numbers, single digit numbers must always be preceded by a leading zero.

One Discrete Length - This option allows decoding of only those D 2 of 5 symbols containing a selected length. Lengths are selected from the numeric bar codes beginning on page [D-1](#) in [D](#). For example, to decode only D 2 of 5 symbols with 14 characters, scan **D 2 of 5 - One Discrete Length**, then scan **1** followed by **4**. If an error occurs, or to change the selection, scan **Cancel** on page [D-8](#).

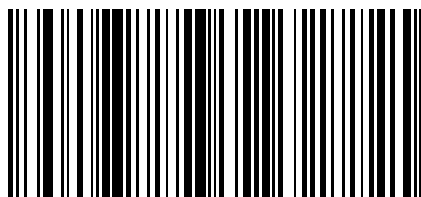

D 2 of 5 - One Discrete Length

Set Lengths for Discrete 2 of 5 (continued)

Two Discrete Lengths - This option allows decoding of only those D 2 of 5 symbols containing either of two selected lengths. Lengths are selected from the numeric bar codes beginning on page [D-1](#) in [Appendix D, Numeric Bar Codes](#). For example, to decode only those D 2 of 5 symbols containing either 2 or 14 characters, select **D 2 of 5 - Two Discrete Lengths**, then scan **0, 2, 1**, and then **4**. If an error occurs, or to change the selection, scan **Cancel** on page [D-8](#).

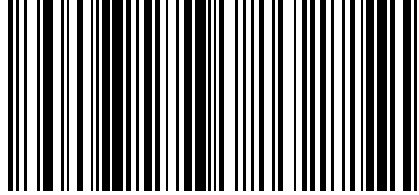

D 2 of 5 - Two Discrete Lengths

Length Within Range - This option allows decoding of a D 2 of 5 symbol with a specific length range. The length range is selected from numeric bar codes beginning on page [D-1](#) in [Appendix D, Numeric Bar Codes](#). For example, to decode D 2 of 5 symbols containing between 4 and 12 characters, first scan **D 2 of 5 - Length Within Range**. Then scan **0, 4, 1**, and **2** (single digit numbers must always be preceded by a leading zero). If an error occurs, or to change the selection, scan **Cancel** on page [D-8](#).

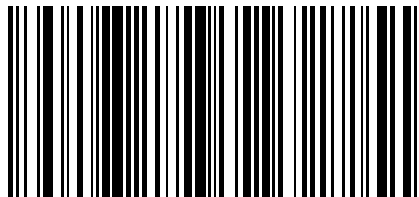

D 2 of 5 - Length Within Range

Set Lengths for Discrete 2 of 5 (continued)

Any Length - Scanning this option allows decoding of D 2 of 5 symbols containing any number of characters within the scanner capability.



Due to the construction of the D 2 of 5 symbology, it is possible for a scan line covering only a portion of the code to be interpreted as a complete scan, yielding less data than is actually encoded in the bar code. To prevent this from happening, it is strongly recommended that specific lengths (**D 2 of 5 - One Discrete Length - Two Discrete Lengths**) be selected for D 2 of 5 applications.

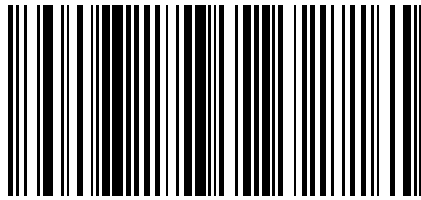

D 2 of 5 - Any Length

Codabar (NW - 7)

Enable/Disable Codabar

To enable or disable Codabar, scan the appropriate bar code below.

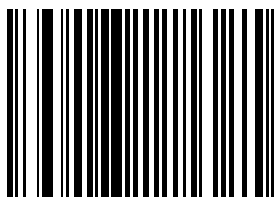

Enable Codabar

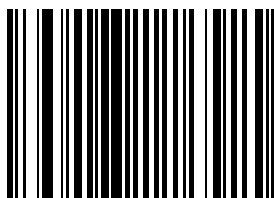

***Disable Codabar**



Note

When a large gap bar code is encountered, see [Symbology - Intercharacter Gap on page 13-94](#).

Set Lengths for Codabar

The length of a code refers to the number of characters (i.e., human readable characters), including check digit(s) the code contains. Lengths for Codabar may be set for any length, one or two discrete lengths, or lengths within a specific range.



When setting lengths for different bar code types by scanning single digit numbers, single digit numbers must always be preceded by a leading zero.

One Discrete Length - This option allows decoding of only those Codabar symbols containing a selected length. Lengths are selected from the numeric bar codes beginning on page [D-1](#) in [Appendix D, Numeric Bar Codes](#). For example, to decode only Codabar symbols with 14 characters, scan **Codabar - One Discrete Length**, then scan **1** followed by **4**. If an error occurs, or to change the selection, scan **Cancel** on page [D-8](#).

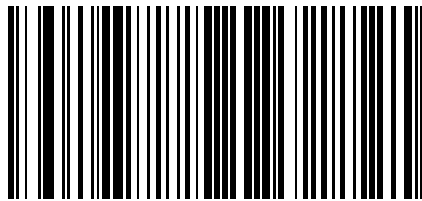

Codabar - One Discrete Length

Set Lengths for Codabar (continued)

Two Discrete Lengths - This option allows decoding of only those Codabar symbols containing either of two selected lengths. Lengths are selected from the numeric bar codes beginning on page D-1 in [Appendix D, Numeric Bar Codes](#). For example, to decode only those Codabar symbols containing either 2 or 14 characters, select **Codabar - Two Discrete Lengths**, then scan **0, 2, 1**, and then **4**. If an error occurs, or to change the selection, scan **Cancel** on page D-8.

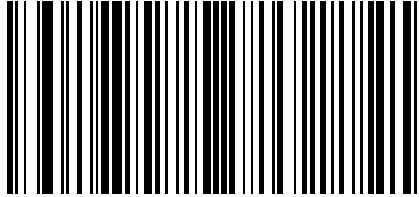

Codabar - Two Discrete Lengths

Length Within Range - This option allows decoding of a Codabar symbol with a specific length range. The length range is selected from numeric bar codes beginning on page D-1 in [Appendix D, Numeric Bar Codes](#). For example, to decode Codabar symbols containing between 4 and 12 characters, first scan **Codabar - Length Within Range**. Then scan **0, 4, 1**, and **2** (single digit numbers must always be preceded by a leading zero). If an error occurs, or to change the selection, scan **Cancel** on page D-8.

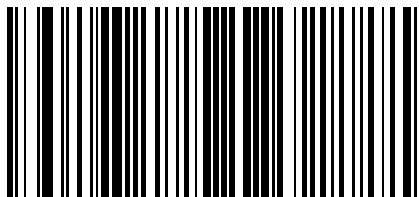

Codabar - Length Within Range

Set Lengths for Codabar (continued)

Any Length - Scanning this option allows decoding of Codabar symbols containing any number of characters within the scanner capability.

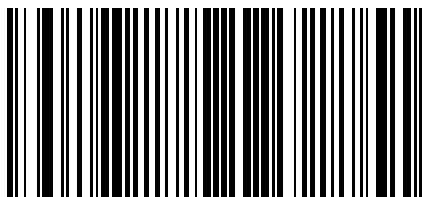

Codabar - Any Length

CLSI Editing

When enabled, this parameter strips the start and stop characters and inserts a space after the first, fifth, and tenth characters of a 14-character Codabar symbol. Enable this feature if the host system requires this data format.



Symbol length does not include start and stop characters.

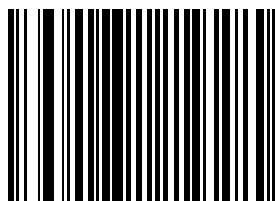

Enable CLSI Editing

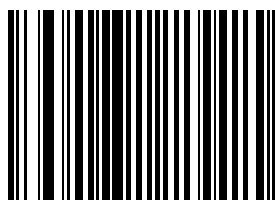

***Disable CLSI Editing**

NOTIS Editing

When enabled, this parameter strips the start and stop characters from a decoded Codabar symbol. Enable this feature if the host system requires this data format.

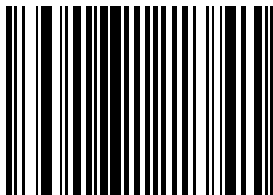

Enable NOTIS Editing

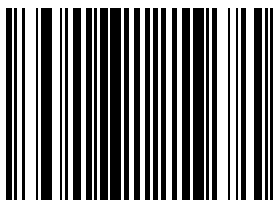

***Disable NOTIS Editing**

RSS (Reduced Space Symbology)

The variants of RSS are RSS 14, RSS Expanded, and RSS Limited. The limited and expanded versions have stacked variants. Scan the appropriate bar code below to enable or disable each variant of RSS.

RSS 14

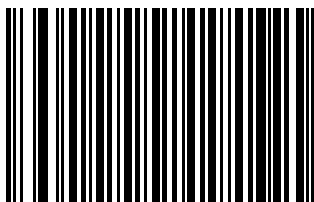

***Enable RSS 14**

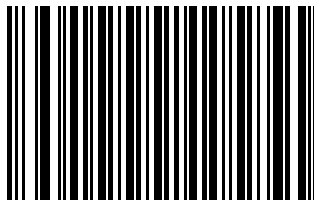

Disable RSS 14

RSS Limited

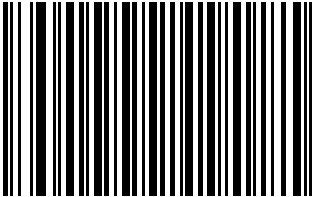

Enable RSS Limited

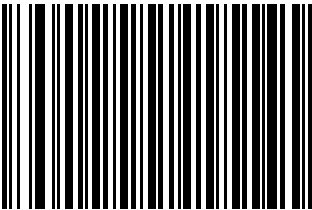

***Disable RSS Limited**

RSS Expanded

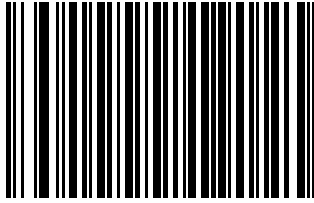

***Enable RSS Expanded**

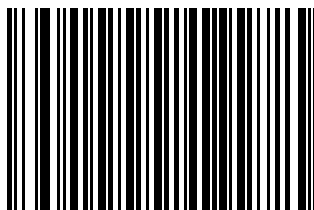

Disable RSS Expanded

Convert RSS to UPC/EAN

This parameter only applies to RSS-14 and RSS Limited symbols not decoded as part of a Composite symbol. When this conversion is enabled, RSS-14 and RSS Limited symbols encoding a single zero as the first digit have the leading '010' stripped and the bar code reported as EAN-13.

Bar codes beginning with two or more zeros but not six zeros have the leading '0100' stripped and the bar code reported as UPC-A. The UPC-A Preamble parameter to transmit the system character and country code applies to converted bar codes. Note that neither the system character nor the check digit can be stripped.

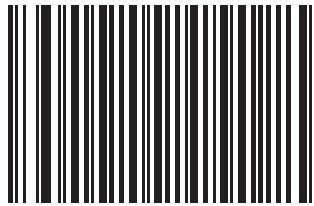

Enable Convert RSS to UPC/EAN



***Disable Convert RSS to UPC/EAN**

Symbology - Specific Security Levels

Redundancy Level

The Symbol LS7708 offer four levels of decode redundancy. Higher redundancy levels are selected for decreasing levels of bar code quality. As redundancy levels increase, the scanner's aggressiveness decreases.

Select the redundancy level appropriate for the bar code quality.

Redundancy Level 1

The following code types must be successfully read twice before being decoded:

Table 13-2. Redundancy Level 1 Code Types

Code Type	Length
Codabar	8 characters or less
MSI	4 characters or less
D 2 of 5	8 characters or less
I 2 of 5	8 characters or less

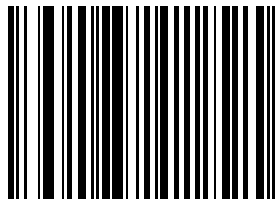

***Redundancy Level 1**

Redundancy Level 2

The following code types must be successfully read twice before being decoded:

Table 13-3. Redundancy Level 2 Code Types

Code Type	Length
All	All

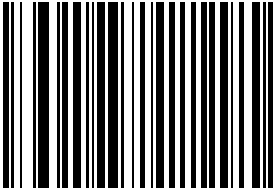

Redundancy Level 2

Redundancy Level 3

Level 3 ensures that the enabled linear bar code types are read twice before reporting a good decode. The following codes must be read three times:

Table 13-4. Redundancy Level 3 Code Types

Code Type	Length
MSI	4 characters or less
D 2 of 5	8 characters or less
I 2 of 5	8 characters or less
Codabar	8 characters or less

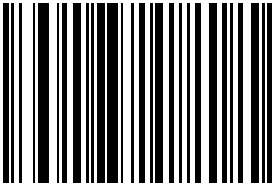

Redundancy Level 3

Redundancy Level 4

The following code types must be successfully read three times before being decoded:

Table 13-5. Redundancy Level 4 Code Types

Code Type	Length
All	All

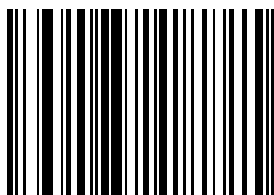

Redundancy Level 4

Security Level

The Symbol LS7708 offer four levels of decode security for the delta bar codes. These include the Code 128 family, UPC/EAN, Code 93 and Scanlet. Increasing levels of security are provided for decreasing levels of bar code quality. There is an inverse relationship between security and scanner aggressiveness, so be sure to choose only that level of security necessary for any given application.

Security Level 0

This is the default setting. It allows the fastest scanner operation while providing minimum security for most "in-spec" bar codes. Some level of misdecodes is expected.

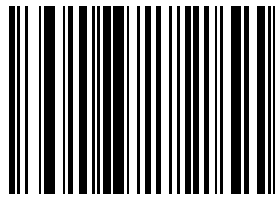

*** Security Level 0**

Security Level 1

This setting allows the optimum scanner speed that provides sufficient security in decoding most "in-spec" bar codes. This level should eliminate most misdecodes.

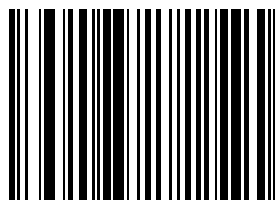

Security Level 1

Security Level (continued)

Security Level 2

Choose this option if Security Level 1 fails to eliminate misdecodes.

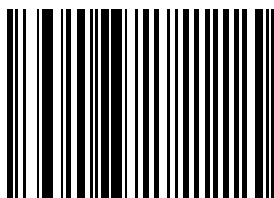

Security Level 2

Security Level 3

If Security Level 2 has been tried, and misdecodes are still occurring, select this security level. Be advised, selecting this option is an extreme measure against misdecoding severely out of spec bar codes. Selection of this level of security may significantly impair the decoding ability of the scanner. If this level of security is necessary, try to improve the quality of the bar codes being scanned.

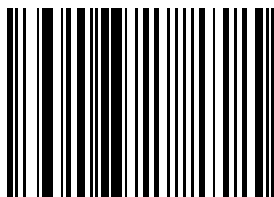

Security Level 3

Bi-directional Redundancy

Bi-Directional Redundancy is used for added security to linear code type security levels. When enabled, a bar code must be successfully scanned in both directions (forward and reverse) before reporting a good decode.

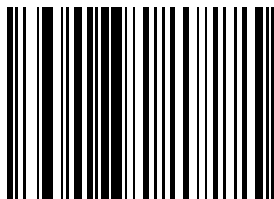

Enable Bi-directional Redundancy

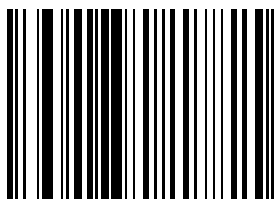

***Disable Bi-directional Redundancy**

Symbology - Intercharacter Gap

The Code 39 and Codabar symbologies have an intercharacter gap that is customarily quite small. Due to various bar code-printing technologies, this gap may grow larger than the maximum size allowed, causing the scanner to be unable to decode the symbol. If this problem is encountered, then the "Large Intercharacter Gaps" parameter should be scanned, to tolerate these out-of-specification barcodes.



***Normal Intercharacter Gaps**



Large Intercharacter Gaps

Miscellaneous Scanner Options

Introduction	14-3
Scanning Sequence Examples	14-3
Errors While Scanning	14-3
Miscellaneous Default Parameters	14-3
Miscellaneous Scanner Parameters	14-4
Transmit Code ID Character	14-4
Prefix/Suffix Values	14-5
FN1 Substitution Values	14-6
Scan Data Options	14-7
Report Version	14-11
Report MIMIC Version	14-11
Report Synapse Cable	14-12

Introduction

This chapter includes bar codes used to customize how data is transmitted to the host device. Also see each host chapter for the appropriate host connections and host device features for the scanner. Before programming, follow the instructions in [Chapter 1, Getting Started](#).

The scanner is shipped with the settings shown in the [Table 14-1](#) (also see [Appendix A, Standard Default Parameters](#) for all host device and miscellaneous scanner defaults). If the default values are suitable, programming is not necessary. Set feature values by scanning single bar codes or short bar code sequences.

Throughout the programming bar code menus, asterisks (*) indicate default values.

Scanning Sequence Examples

In most cases, scan only one bar code to set a specific parameter value. Other parameters, such as **Prefix Value**, require scanning several bar codes in sequence. See individual parameters for descriptions of this procedure.

Errors While Scanning

Unless otherwise specified, if an error occurs during a scanning sequence, just re-scan the correct parameter.

Miscellaneous Default Parameters

[Table 14-1](#) lists the defaults for miscellaneous scanner options parameters. To change any option, scan the appropriate bar code(s) beginning in [Miscellaneous Scanner Parameters on page 14-4](#).



Note

Scanning parameter setting bar codes with the primary scanner also changes settings on the auxiliary scanner.



Note

See [Appendix A, Standard Default Parameters](#) for all user preferences, hosts, symbologies, and miscellaneous default parameters.

Table 14-1. Miscellaneous Scanner Options Default Table

Parameter	Default	Page Number
Transmit Code ID Character	Disable	14-4
Prefix Value	None	14-5
Suffix Value	<CR><LF>	14-5
FN1 Substitution Values	7013	14-6
Scan Data Options	Data as is	14-7
Report Version		14-11
Report MIMIC Version		14-11
Report Synapse Cable		14-12

Miscellaneous Scanner Parameters

Transmit Code ID Character

A Code ID character identifies the code type of a scanned bar code. This is useful when the scanner is decoding more than one code type. In addition to any single character prefix already selected, the Code ID character is inserted between the prefix and the decoded symbol.

Select no Code ID character, a Symbol Code ID character, or an AIM Code ID character. For Code ID Characters, see [Appendix B, Programming Reference](#), [AIM Code Identifiers on page B-4](#), and [AIM Code Identifiers on page B-4](#).

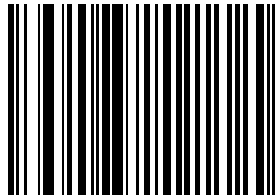

Symbol Code ID Character

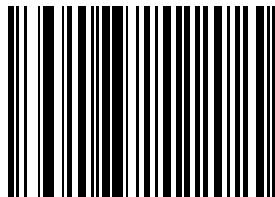

AIM Code ID Character

Transmit Code ID Character (continued)

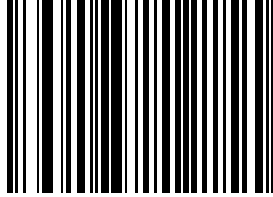

***None**

Prefix/Suffix Values

A prefix/suffix may be appended to scan data for use in data editing. These values are set by scanning a four-digit number (i.e., four bar codes) that corresponds to key codes for various terminals. Code 39 Full ASCII to Full ASCII Correlation is host-dependent, and therefore described in the ASCII Character Set table for the appropriate interface. See [Appendix D, Numeric Bar Codes](#) for numeric bar codes. If an error occurs, or to change the selection, scan **Cancel** on page [D-8](#).

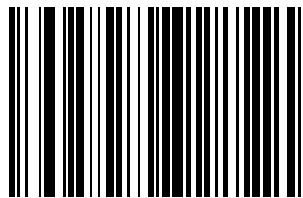

**Scan Prefix
(ADF Value 2)**

Prefix/Suffix Values (continued)

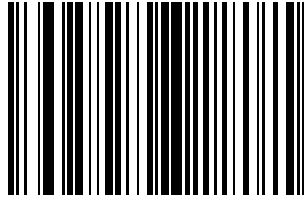

**Scan Suffix
(ADF Value 1)**

FN1 Substitution Values

The Wedge and USB HID Keyboard hosts support a FN1 Substitution feature. If enabled, this feature substitutes any FN1 character (0x1b) in an EAN128 bar code for this value. This value defaults to 7013 (Enter Key).

1. Scan the bar code below.

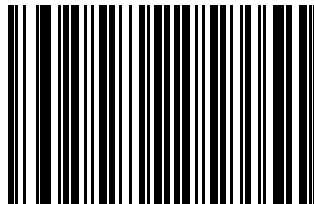

2. Look up the keystroke for FN1 Substitution in the *ASCII Character Set* table for the currently installed host interface. Enter the 4-digit ASCII value by scanning each digit in the [Numeric Bar Codes on page D-1](#).

Scan Data Options

To change the Scan Data Transmission Format, scan the **Scan Options** bar code below. Then select one of four options:

- Data As Is
- <DATA> <SUFFIX>
- <PREFIX> <DATA>
- <PREFIX> <DATA> <SUFFIX>.

After making a selection, scan the **Enter** bar code on page [14-10](#). If a mistake occurs, scan the **Data Format Cancel** bar code on page [14-10](#).

To append a carriage return/enter after each bar code scanned, scan the following bar codes in order:

1. <SCAN OPTIONS>
2. <DATA> <SUFFIX>
3. Enter (on page [14-10](#))

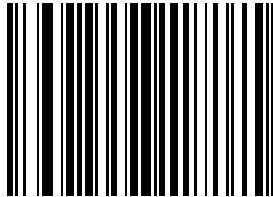

Scan Options

Scan Data Transmission Format (continued)

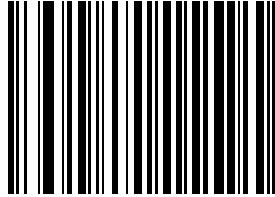

***Data As Is**

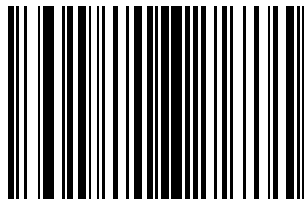

<DATA> <SUFFIX>

Scan Data Transmission Format (continued)

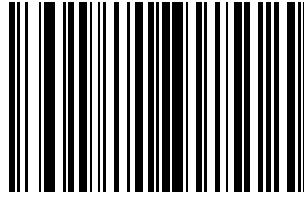

<PREFIX> <DATA>

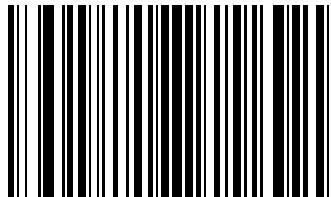

<PREFIX> <DATA> <SUFFIX>

Scan Data Transmission Format (continued)

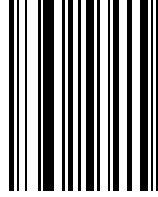

Enter

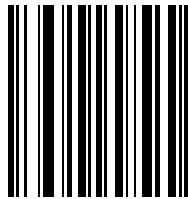

Data Format Cancel

Report Version

Scan the bar code below to report the software revision installed in the scanner's primary microprocessor.

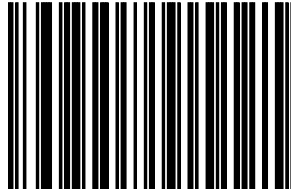

Report Software Version

Report MIMIC Version

Scan the bar code below to report the MIMIC software revision installed in the scanner's secondary microprocessor. Motorola scanners that do not use MIMIC architecture report nothing.

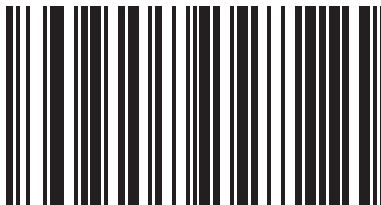

Report MIMIC Software Version

Report Synapse Cable

Scan the bar code below to report the software revision of the attached Synapse cable. If the scanner does not detect an attached Synapse cable, it reports *Synapse not attached*.

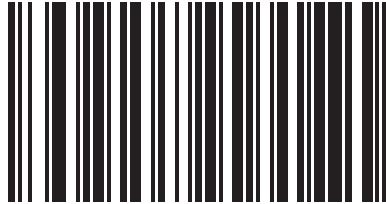

Report Synapse Cable



Standard Default Parameters

Table A-1. Standard Default Parameters Table

Parameter	Default	Page Number
User Preferences		
Set Default Parameter	All Defaults	4-5
Beeper Tone	Medium	4-5
Beeper Volume	High	4-7
Beep After Good Decode	Enable	4-9
Low Power Mode	Low Power Blink Mode	4-10
Scan Pattern Mode	Rastering	4-11
EAS Interlock	Disable	4-17
Time-out Between Same Symbol	0.6 sec	4-12
Time-out Between Different Symbols	0.2 sec	4-12
Time Delay to Low Power Mode	30 Minutes	4-13
Linear UPC/EAN Decode	Disable	4-15
¹ User selection is required to configure this interface and this is the most common selection.		

Table A-1. Standard Default Parameters Table (Continued)

Parameter	Default	Page Number
UPC Half Block Stitching	Enable	4-16
EAS Interlock	Disable	4-17
Keyboard Wedge Host Parameters		
Keyboard Wedge Host Type	IBM PC/AT& IBM PC Compatibles ¹	5-7
Country Types (Country Codes)	North American	5-9
Ignore Unknown Characters	Transmit	5-14
Keystroke Delay	No Delay	5-15
Inter-Keystroke Delay	Disable	5-17
Alternate Numeric Keypad Emulation	Disable	5-18
Caps Lock On	Disable	5-19
Caps Lock Override	Disable	5-20
Convert Wedge Data	No Convert	5-21
Function Key Mapping	Disable	5-23
FN1 Substitution	Disable	5-24
Send Make Break	Disable	5-25
RS-232 Host Parameters		
RS-232 Host Types	Standard ¹	6-9
Baud Rate	9600	6-13
Parity	None	6-17
Check Receive Errors	Enable	6-20
Hardware Handshaking	None	6-21
Software Handshaking	None	6-24
Host Serial Response Time-out	2 Sec	6-26
RTS Line State	Low RTS	6-29
Stop Bit Select	1	6-30
Data Bits	8-Bit	6-31
Beep on <BEL>	Disable	6-32
¹ User selection is required to configure this interface and this is the most common selection.		

Table A-1. Standard Default Parameters Table (Continued)

Parameter	Default	Page Number
Intercharacter Delay	0 msec	6-33
Nixdorf Beep/LED Options	Normal Operation	6-35
Ignore Unknown Characters	Send Bar Codes	6-37
USB Host Parameters		
USB Device Type	HID (Human Interface Device) Keyboard Emulation	7-7
USB Country Keyboard Types (Country Codes)	North American	7-9
USB Keystroke Delay	No Delay	7-14
USB CAPS Lock Override	Disable	7-16
USB Ignore Unknown Characters	Send Bar Codes	7-17
Emulate Keypad	Disable	7-18
USB Keyboard FN1 Substitution	Disable	7-19
Function Key Mapping	Disable	7-20
Simulated Caps Lock	Disable	7-21
Convert Case	Disable	7-22
IBM 468X/469X Host Parameters		
Port Address	None Selected ¹	8-6
Convert Unknown Bar Code 39	Disable	8-8
RS-232 Auxiliary Port Parameters		
Baud Rate	9600	10-6
Parity	None	10-9
Check Receive Errors	Enable	10-11
Hardware Handshaking	None	10-12
Software Handshaking	None	10-21
Serial Response Time-out	2 sec	10-17
RTS Line State	Low RTS	10-20
Stop Bit Select	1	10-21
Data Bits	8-Bit	10-22
¹ User selection is required to configure this interface and this is the most common selection.		

Table A-1. Standard Default Parameters Table (Continued)

Parameter	Default	Page Number
Hand-Held Laser Scanner Parameters		
Programming Mode	Program Primary Scanner Only	11-5
Beep After Good Decode	Disable	11-7
123Scan Configuration Tool		
123Scan	None ¹	12-3
UPC/EAN		
UPC-A	Enable	13-7
UPC-E	Enable	13-8
UPC-E1	Disable	13-9
EAN-8/JAN-8	Enable	13-10
EAN-13/JAN-13	Enable	13-10
Bookland EAN	Disable	13-12
Decode UPC/EAN Supplementals (2 and 5 digits)	Ignore	13-13
Decode UPC/EAN Supplemental Redundancy	20	13-22
Transmit UPC-A Check Digit	Transmit	13-23
Transmit UPC-E Check Digit	Transmit	13-24
Transmit UPC-E1 Check Digit	Transmit	13-24
UPC-A Preamble	System Character	13-26
UPC-E Preamble	System Character	13-27
UPC-E1 Preamble	System Character	13-29
Convert UPC-E to A	Disable	13-31
Convert UPC-E1 to A	Disable	13-32
EAN-8 Zero Extend	Disable	13-33
Bookland ISBN Format	ISBN-10	13-34
UCC Coupon Extended Code	Disable	13-35
Code 128		
Code 128	Enable	13-36
¹ User selection is required to configure this interface and this is the most common selection.		

Table A-1. Standard Default Parameters Table (Continued)

Parameter	Default	Page Number
UCC/EAN-128	Enable	13-37
ISBT 128 (non-concatenated)	Enable	13-38
Code 128 Decode Performance	Enable	13-39
Code 128 Decode Performance Level	Level 3	13-40
Code 39		
Code 39	Enable	13-42
Trioptic Code 39	Disable	13-43
Convert Code 39 to Code 32 (Italian Farmer Code)	Disable	13-44
Code 32 Prefix	Disable	13-45
Set Length(s) for Code 39	2 to 55	13-46
Code 39 Check Digit Verification	Disable	13-48
Transmit Code 39 Check Digit	Do Not Transmit	13-49
Code 39 Full ASCII Conversion	Disable	13-50
Buffer Code 39	Disable	13-51
Code 39 Decode Performance	Enable	13-55
Code 39 Decode Performance Level	Level 3	13-56
Code 93		
Code 93	Disable	13-58
Set Length(s) for Code 93	4 to 55	13-59
Code 11		
Code 11	Disable	13-61
Set Lengths for Code 11	4 to 55	13-62
Code 11 Check Digit Verification	Disable	13-64
Transmit Code 11 Check Digit	Do Not Transmit	13-66
Interleaved 2 of 5 (ITF)		
Interleaved 2 of 5 (ITF)	Disable	13-67
Set Length(s) for I 2 of 5	14	13-68
I 2 of 5 Check Digit Verification	Disable	13-70
¹ User selection is required to configure this interface and this is the most common selection.		

Table A-1. Standard Default Parameters Table (Continued)

Parameter	Default	Page Number
Transmit I 2 of 5 Check Digit	Do Not Transmit	13-72
Convert I 2 of 5 to EAN 13	Disable	13-73
Discrete 2 of 5 (DTF)		
Discrete 2 of 5	Disable	13-74
Set Length(s) for D 2 of 5	12	13-75
Codabar (NW - 7)		
Codabar	Disable	13-78
Set Lengths for Codabar	5 to 55	13-79
CLSI Editing	Disable	13-82
NOTIS Editing	Disable	13-83
RSS (Reduced Space Symbology)		
RSS 14	Enable	13-84
RSS Limited	Disable	13-85
RSS Expanded	Enable	13-86
Convert RSS to UPC/EAN	Disable	13-87
Symbology - Specific Security Levels		
Redundancy Security Levels	1	13-88
Security Level	1	13-91
Bi-directional Redundancy	Disable	13-93
Symbology - Intercharacter Gap		
Intercharacter Gaps	Normal	13-94
Miscellaneous Scanner Options		
Transmit Code ID Character	Disable	14-4
Prefix Value	None	14-5
Suffix Value	<CR><LF>	14-5
FN1 Substitution Values	7013	14-6
Scan Data Options	Data "as is"	14-7
Report Version		14-11
¹ User selection is required to configure this interface and this is the most common selection.		

Table A-1. Standard Default Parameters Table (Continued)

Parameter	Default	Page Number
Report MIMIC Version		14-11
Report Synapse Cable		14-12
¹ User selection is required to configure this interface and this is the most common selection.		

B

Programming Reference

Symbol Code Identifiers	B-3
AIM Code Identifiers	B-4

Symbol Code Identifiers

Table B-1. Code Characters

Code Character	Code Type
A	UPC/EAN
B	Code 39, Code 39 Full ASCII, Code 32
C	Codabar
D	Code 128, ISBT 128
E	Code 93
F	Interleaved 2 of 5
G	Discrete 2 of 5, IATA
H	Code 11
K	UCC/EAN-128
L	Bookland EAN
M	Code 39 Trioptic
N	Coupon Code
R	RSS

AIM Code Identifiers

Each AIM Code Identifier contains the three-character string **jcm** where:

- j = Flag Character (ASCII 93)
- c = Code Character
- m = Modifier Character

Table B-2. AIM Code Characters

Code Character	Code Type
A	Code 39, Code 39 Full ASCII, Code 32
C	Code 128 (all variants), Coupon (Code 128 portion)
E	UPC/EAN, Coupon (UPC/EAN portion)
F	Codabar
G	Code 93
H	Code 11
I	Interleaved 2 of 5
S	Discrete 2 of 5, IATA
X	Bookland EAN, Code 39 Trioptic
e	RSS

The modifier character is the sum of the applicable option values based on [Table B-3](#).

Table B-3. Modifier Characters

Code Type	Option Value	Option
Code 39		
	0	No Check character.
	1	Reader has checked one check character.
	3	Reader has checked and stripped check character.
	4	Reader has performed Full ASCII character conversion.
	5	Reader has performed Full ASCII character conversion and checked one check character.
	7	Reader has performed Full ASCII character conversion and checked and stripped check character.
	Example: A Full ASCII bar code with check character W, A+I+MI+DW , is transmitted as JA7 Aimld where $7 = (3+4)$.	
Trioptic Code 39		
	0	No option specified at this time. Always transmit 0.
	Example: A Trioptic bar code 412356 is transmitted as JX0 412356	
Code 128		
	0	Standard data packet, No Function code 1 in first symbol position.
	1	Function code 1 in first symbol character position.
	2	Function code 1 in second symbol character position.
	Example: A Code (EAN) 128 bar code with Function 1 character in the first position, FNC1 Aim Id is transmitted as JC1 Aimld	
I 2 of 5		
	0	No check digit processing.
	1	Reader has validated check digit.
	3	Reader has validated and stripped check digit.
	Example: An I 2 of 5 bar code without check digit, 4123, is transmitted as JIO 4123	
Codabar		
	0	Standard Codabar
	1	ABC Codabar
	Example: A standard Codabar bar code, 4123, is transmitted as JF0 4123	
Code 93		
	0	No options specified at this time. Always transmit 0.
	Example: A Code 93 bar code 012345678905 is transmitted as JG00 12345678905	
D 2 of 5		
	0	No options specified at this time. Always transmit 0.
	Example: A D 2 of 5 bar code 4123, is transmitted as JS0 4123	

Table B-3. Modifier Characters

Code Type	Option Value	Option
I 2 of 5		
	0	No check digit processing.
	1	Reader has validated check digit.
	3	Reader has validated and stripped check digit.
	Example: An I 2 of 5 bar code without check digit, 4123, is transmitted as JIO 4123	
Codabar		
	0	Standard Codabar
	1	ABC Codabar
	Example: A standard Codabar bar code, 4123, is transmitted as JFO 4123	
Code 93		
	0	No options specified at this time. Always transmit 0.
	Example: A Code 93 bar code 012345678905 is transmitted as JGO 012345678905	
D 2 of 5		
	0	No options specified at this time. Always transmit 0.
	Example: A D 2 of 5 bar code 4123, is transmitted as JSO 4123	
UPC/EAN		
	0	Standard packet in full EAN country code format, which is 13 digits for UPC-A, UPC-E, and EAN-13 (not including supplemental data).
	1	Two digit supplement data only.
	2	Five digit supplement data only.
	3	Combined data packet comprising 13 digits from a UPC-A, UPC-E, or EAN-13 symbol and 2 or 5 digits from a supplemental symbol.
	4	EAN-8 data packet.
	Example: A UPCA bar code 012345678905 is transmitted as JE00 012345678905	
Bookland EAN		
	0	No options specified at this time. Always transmit 0.
	Example: A Bookland EAN bar code 123456789X is transmitted as JX0 123456789X	
RSS Family		
		No option specified at this time. Always transmit 0. RSS-14 and RSS-Limited transmit with an Application Identifier "01". Note: In UCC/EAN-128 emulation mode, RSS is transmitted using Code 128 rules (i.e.,]C1).
	Example: An RSS-14 bar code 100123456788902 is transmitted as Je 001100123456788902.	



Sample Bar Codes

Code 39.....	C-3
UPC/EAN	C-3
UPC-A, 100 %	C-3
EAN-13, 100 %	C-4
Code 128.....	C-4
Interleaved 2 of 5	C-5
RSS 14	C-5

Code 39



UPC/EAN

UPC-A, 100 %



EAN-13, 100 %



Code 128



Interleaved 2 of 5



RSS 14



RSS 14 must be enabled to read the bar code below (see [RSS 14 on page 13-84](#)).





Numeric Bar Codes

0	D-3
1	D-3
2	D-4
3	D-4
4	D-5
5	D-5
6	D-6
7	D-6
8	D-7
9	D-7
Cancel	D-8

0

For parameters requiring specific numeric values, scan the appropriately numbered bar code(s).

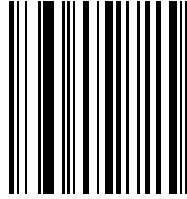

0

1

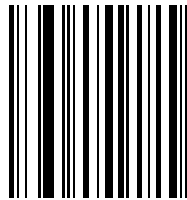

1

2

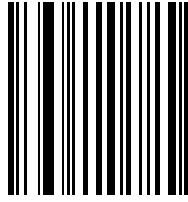

2

3

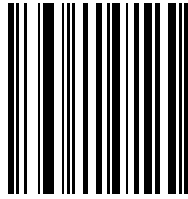

3

4

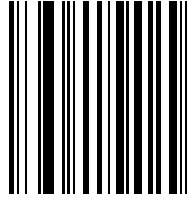

4

5

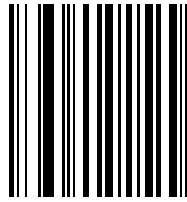

5

6

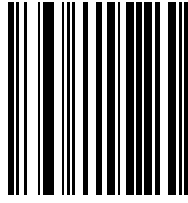

6

7

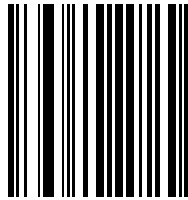

7

8

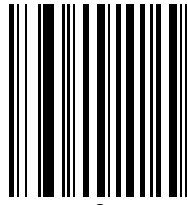

8

9

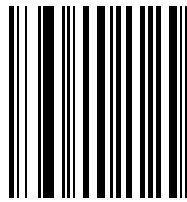

9

Cancel

If an error occurs or to change a selection, scan the bar code below.

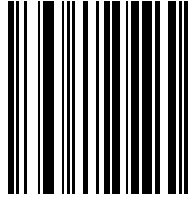

Cancel

E

Mounting Template

Mounting Template

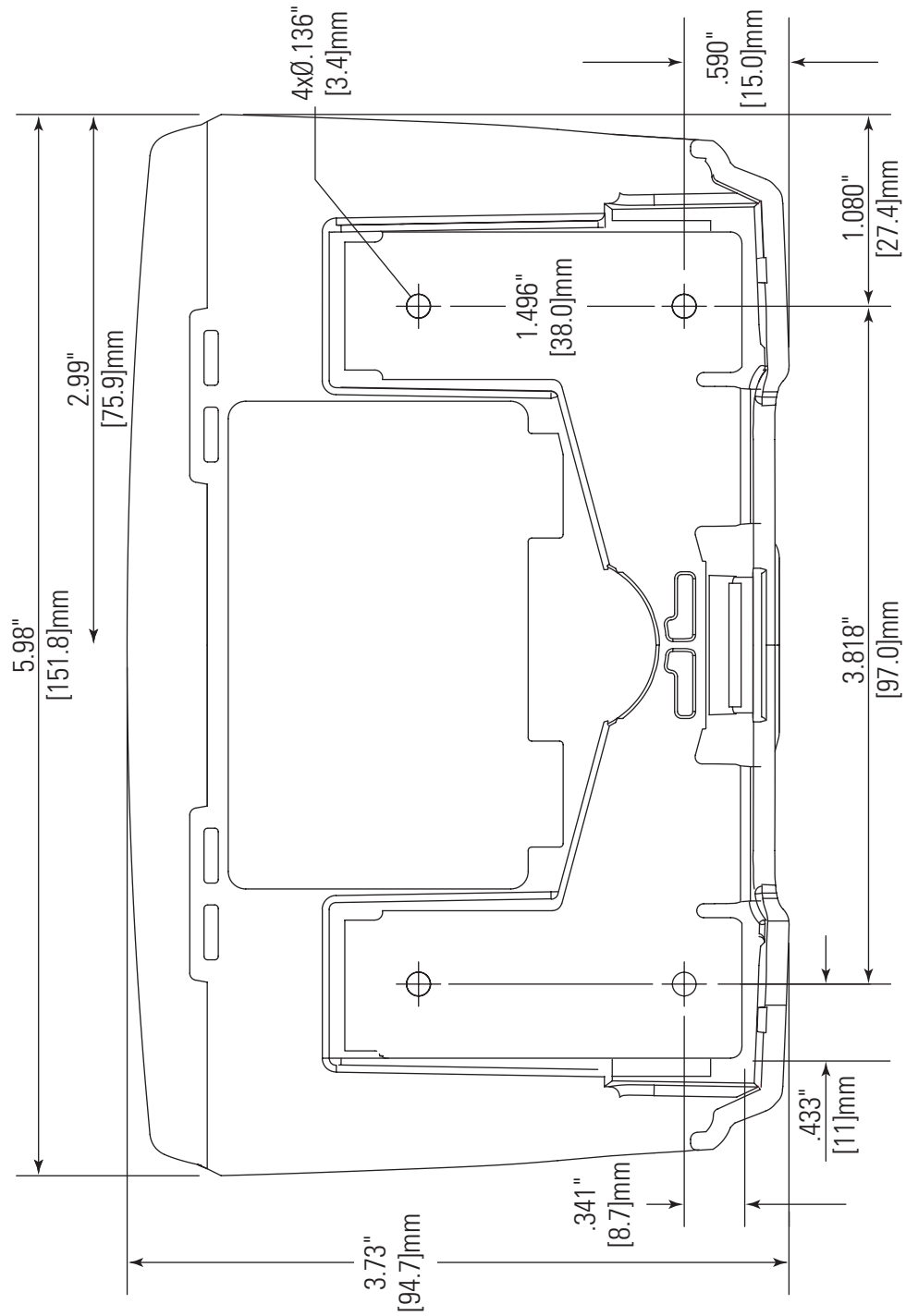

Glossary

Aperture	The opening in an optical system defined by a lens or baffle that establishes the field of view.
AIM	The Automatic Identification Manufacturers Inc., a trade association.
ASCII	American Standard Code for Information Interchange. A 7 bit-plus-parity code representing 128 letters, numerals, punctuation marks, and control characters. It is a standard data transmission code in the U.S.
Autodiscrimination	The ability of an interface controller to determine the code type of a scanned bar code. After this determination is made, the information content is decoded.
Bar	The dark element in a printed bar code symbol.
Bar Code Density	The number of characters represented per unit of measurement (e.g., characters per inch).
Bar Height	The dimension of a bar measured perpendicular to the bar width.
Bar Width	Thickness of a bar measured from the edge closest to the symbol start character to the trailing edge of the same bar.
Baud Rate	A measure of the data flow or number of signaling events occurring per second. When one bit is the standard "event," this is a measure of bits per second (bps). For example, a baud rate of 50 means transmission of 50 bits of data per second.
Bit	Binary digit. One bit is the basic unit of binary information. Generally, eight consecutive bits compose one byte of data. The pattern of 0 and 1 values within the byte determines its meaning.

Byte	On an addressable boundary, eight adjacent binary digits (0 and 1) combined in a pattern to represent a specific character or numeric value. Bits are numbered from the right, 0 through 7, with bit 0 the low-order bit. One byte in memory is used to store one ASCII character.
CDRH	Center for Devices and Radiological Health. A federal agency responsible for regulating laser product safety. This agency specifies various laser operation classes based on power output during operation.
CDRH Class 1	This is the lowest power CDRH laser classification. This class is considered intrinsically safe, even if all laser output were directed into the eye's pupil. There are no special operating procedures for this class.
CDRH Class 2	No additional software mechanisms are needed to conform to this limit. Laser operation in this class poses no danger for unintentional direct human exposure.
Character	A pattern of bars and spaces which either directly represents data or indicates a control function, such as a number, letter, punctuation mark, or communications control contained in a message.
Character Set	Those characters available for encoding in a particular bar code symbology.
Check Digit	A digit used to verify a correct symbol decode. The scanner inserts the decoded data into an arithmetic formula and checks that the resulting number matches the encoded check digit. Check digits are required for UPC but are optional for other symbologies. Using check digits decreases the chance of substitution errors when a symbol is decoded.
Codabar	A discrete self-checking code with a character set consisting of digits 0 to 9 and six additional characters: (- \$: / , +).
Code 128	A high density symbology which allows the controller to encode all 128 ASCII characters without adding extra symbol elements.
Code 3 of 9 (Code 39)	A versatile and widely used alphanumeric bar code symbology with a set of 43 character types, including all uppercase letters, numerals from 0 to 9, and 7 special characters (- . / + % \$ and space). The code name is derived from the fact that 3 of 9 elements representing a character are wide, while the remaining 6 are narrow.
Code 93	An industrial symbology compatible with Code 39 but offering a full character ASCII set and a higher coding density than Code 39.
Code Length	Number of data characters in a bar code between the start and stop characters, not including those characters.
Continuous Code	A bar code or symbol in which all spaces within the symbol are parts of characters. There are no intercharacter gaps in a continuous code. The absence of gaps allows for greater information density.
Dead Zone	An area within a scanner's field of view, in which specular reflection may prevent a successful decode.
Decode	To recognize a bar code symbology (e.g., UPC/EAN) and then analyze the content of the specific bar code scanned.
Decode Algorithm	A decoding scheme that converts pulse widths into data representation of the letters or numbers encoded within a bar code symbol.
Depth of Field	The range between minimum and maximum distances at which a scanner can read a symbol with a certain minimum element width.
Discrete Code	A bar code or symbol in which the spaces between characters (intercharacter gaps) are not part of the code.

Discrete 2 of 5	A binary bar code symbology representing each character by a group of five bars, two of which are wide. The location of wide bars in the group determines which character is encoded; spaces are insignificant. Only numeric characters (0 to 9) and START/STOP characters may be encoded.
EAN	European Article Number. This European/International version of the UPC provides its own coding format and symbology standards. Element dimensions are specified metrically. EAN is used primarily in retail.
Element	Generic term for a bar or space.
Encoded Area	Total linear dimension occupied by all characters of a code pattern, including start/stop characters and data.
Host Computer	A computer that serves other terminals in a network, providing such services as computation, database access, supervisory programs, and network control.
IEC	International Electrotechnical Commission. This international agency regulates laser safety by specifying various laser operation classes based on power output during operation.
IEC (825) Class 1	This is the lowest power IEC laser classification. Conformity is ensured through a software restriction of 120 seconds of laser operation within any 1000 second window and an automatic laser shutdown if the scanner's oscillating mirror fails.
Intercharacter Gap	The space between two adjacent bar code characters in a discrete code.
Interleaved Bar Code	A bar code in which characters are paired together, using bars to represent the first character and the intervening spaces to represent the second.
Interleaved 2 of 5	A binary bar code symbology representing character pairs in groups of five bars and five interleaved spaces. Interleaving provides for greater information density. The location of wide elements (bar/spaces) within each group determines which characters are encoded. This continuous code type uses no intercharacter spaces. Only numeric (0 to 9) and START/STOP characters may be encoded.
LASER - Light Amplification by Stimulated Emission of Radiation	The laser is an intense light source. Light from a laser is all the same frequency, unlike the output of an incandescent bulb. Laser light is typically coherent and has a high energy density.
Laser Diode	A gallium-arsenide semiconductor type of laser connected to a power source to generate a laser beam. This laser type is a compact source of coherent light.
LED Indicator	A semiconductor diode (LED - Light Emitting Diode) used as an indicator, often in digital displays. The semiconductor uses applied voltage to produce light of a certain frequency determined by the semiconductor's particular chemical composition.
MIL	1 mil = 1 thousandth of an inch.
Misread (Misdecode)	A condition which occurs when the data output of a reader or interface controller does not agree with the data encoded within a bar code symbol.
Nominal	The exact (or ideal) intended value for a specified parameter. Tolerances are specified as positive and negative deviations from this value.
Nominal Size	Standard size for a bar code symbol. Most UPC/EAN codes are used over a range of magnifications (e.g., from 0.80 to 2.00 of nominal).
Parameter	A variable that can have different values assigned to it.
Percent Decode	The average probability that a single scan of a bar code would result in a successful decode. In a well-designed bar code scanning system, that probability should approach near 100%.

Print Contrast Signal (PCS)	Measurement of the contrast (brightness difference) between the bars and spaces of a symbol. A minimum PCS value is needed for a bar code symbol to be scannable. $PCS = (RL - RD) / RL$, where RL is the reflectance factor of the background and RD the reflectance factor of the dark bars.
Programming Mode	The state in which a scanner is configured for parameter values. See SCANNING MODE.
Quiet Zone	A clear space, containing no dark marks, which precedes the start character of a bar code symbol and follows the stop character.
Reflectance	Amount of light returned from an illuminated surface.
Resolution	The narrowest element dimension which is distinguished by a particular reading device or printed with a particular device or method.
RSS	Reduced Space Symbology: A family of space efficient symbologies developed by UCC.EAN.
Scan Area	Area intended to contain a symbol.
Scanner	An electronic device used to scan bar code symbols and produce a digitized pattern that corresponds to the bars and spaces of the symbol. Its three main components are: <ol style="list-style-type: none"> 1. Light source (laser or photoelectric cell) - illuminates a bar code. 2. Photodetector - registers the difference in reflected light (more light reflected from spaces). 3. Signal conditioning circuit - transforms optical detector output into a digitized bar pattern.
Scanning Mode	The scanner is energized, programmed, and ready to read a bar code.
Scanning Sequence	A method of programming or configuring parameters for a bar code reading system by scanning bar code menus.
Self-Checking Code	A symbology that uses a checking algorithm to detect encoding errors within the characters of a bar code symbol.
Space	The lighter element of a bar code formed by the background between bars.
Specular Reflection	The mirror-like direct reflection of light from a surface, which can cause difficulty decoding a bar code.
Start/Stop Character	A pattern of bars and spaces that provides the scanner with start and stop reading instructions and scanning direction. The start and stop characters are normally to the left and right margins of a horizontal code.
Substrate	A foundation material on which a substance or image is placed.
Symbol	A scannable unit that encodes data within the conventions of a certain symbology, usually including start/stop characters, quiet zones, data characters, and check characters.
Symbol Aspect Ratio	The ratio of symbol height to symbol width.
Symbol Height	The distance between the outside edges of the quiet zones of the first row and the last row.
Symbol Length	Length of symbol measured from the beginning of the quiet zone (margin) adjacent to the start character to the end of the quiet zone (margin) adjacent to a stop character.

Symbology	The structural rules and conventions for representing data within a particular bar code type (e.g. UPC/EAN, Code 39).
Tolerance	Allowable deviation from the nominal bar or space width.
UPC	Universal Product Code. A relatively complex numeric symbology. Each character consists of two bars and two spaces, each of which is any of four widths. The standard symbology for retail food packages in the United States.
Visible Laser Diode (VLD)	A solid state device which produces visible laser light.

Numerics

123Scan parameters 10-6, 12-3

A

active scan area 2-3
AIM code identifiers B-4
aiming 2-7
ASCII values 6-38

B

bar codes
 123Scan 10-6, 12-3
 beep after good decode 4-9
 beeper tone 4-5
 beeper volume 4-7
 code 11
 lengths 13-63
 code 39
 transmit buffer 13-53
data options 14-4
 prefix/suffix values 14-5
 transmit code ID character 14-4
discrete 2 of 5
 lengths 13-77
IBM 468X/469X
 convert unknown to code 39 8-8
 default parameters 8-5
IBM 468X/469X parameters
 port address 8-6
interleaved 2 of 5 13-67

 convert to EAN-13 13-73
 lengths 13-68, 13-69
keyboard wedge
 alternate numeric keypad emulation ... 5-18
 caps lock on 5-19
 caps lock override 5-20
 country keyboard types (country codes) . 5-9
 default table 5-6
 host types 5-7, 5-8
 ignore unknown characters 5-14
 intra-keystroke delay 5-17
 keystroke delay 5-15
linear code type security level 13-88
miscellaneous
 scan data options 14-7
numeric bar codes D-8
report mimic version 14-11
report synapse cable 14-12
report version 14-11
RS-232
 ASCII format 6-31, 10-22
 baud rate 6-13, 10-6
 beep on bel 6-32
 check receive errors 6-20, 10-11
 default table 6-6
 hardware handshaking 6-21, 10-12
 host serial response time-out 6-26
 host types 6-9, 6-10, 6-11, 6-12
 intercharacter delay 6-33
 parity 6-17, 10-9
 RTS line state 6-29, 10-20

software handshaking	6-24, 10-15
stop bit select	6-30, 10-21
set defaults	4-5
symbolologies	
bookland EAN	13-12
bookland ISBN	13-34
buffering	13-51
codabar	13-78
codabar CLSI editing	13-82
codabar lengths	13-79
codabar NOTIS editing	13-83
code 11	13-61
code 11 lengths	13-62
code 128	13-36
code 39	13-42
code 39 check digit verification	13-48
code 39 full ASCII	13-50
code 39 lengths	13-46
code 39 transmit check digit	13-49
code 93	13-58
code 93 lengths	13-59
convert UPC-E to UPC-A	13-31
convert UPC-E1 to UPC-A	13-32
default table	13-3
discrete 2 of 5	13-74
discrete 2 of 5 lengths	13-75
EAN zero extend	13-33
EAN-13/EAN-8	13-10, 13-11
I 2 of 5 check digit verification	13-70
I 2 of 5 convert to EAN-13	13-73
I 2 of 5 transmit check digit	13-72
ISBT 128	13-38
supplementals	13-13
UCC coupon extended code	13-35
UCC/EAN-128	13-37
UPC-A preamble	13-26
UPC-A/E/E1 check digit	13-23, 13-24, 13-25
UPC-A/UPC-E	13-7, 13-8
UPC-E preamble	13-27
UPC-E1	13-9
UPC/EAN supplemental redundancy	13-22
time delay to low power mode	4-13
timeout between decodes	4-12
USB	
caps lock override	7-16
country keyboard types	7-9, 7-11, 7-12
default table	7-6
device type	7-7, 7-8
keystroke delay	7-14, 7-15
unknown characters	7-17
beeper volume	2-6
C	
cables	
installing	1-6
removing cables	1-8
character set	6-38

codabar bar codes	
CLSI editing	13-82
codabar	13-78
lengths	13-79
NOTIS editing	13-83
code 11 bar codes	
code 11	13-61
lengths	13-62
code 128 bar codes	
code 128	13-36
ISBT 128	13-38
UCC/EAN-128	13-37
code 39 bar codes	
buffering	13-51
check digit verification	13-48
code 39	13-42
full ASCII	13-50
lengths	13-46
transmit check digit	13-49
code 93 bar codes	
code 93	13-58
lengths	13-59
code ID characters	
AIM	B-4
code identifiers	
Symbol code IDs	B-3
customer interaction center	.xvi

D

default parameters	4-3
IBM 468X/469X	8-5
keyboard wedge	5-6
miscellaneous scanner options	14-3
RS-232	6-6
standard default table	13-3, A-1
symbolologies	13-3
USB	7-6
user preferences	4-4
discrete 2 of 5 bar codes	
discrete 2 of 5	13-74
lengths	13-75

E

EAS	2-8
EAS interlock	
disable	4-17
enable	4-17

F

freestanding mounting bracket configuration	1-10
---	------

H

hand-held laser scanner	
connecting	11-3

- hand-held laser scanner options 11-5
 - beep after good decode 11-7
 - program all scanners 11-6
 - program hand-held scanner only 11-5
 - program primary scanner only 11-5
 - host types
 - keyboard wedge 5-7, 5-8
 - RS-232 6-9, 6-10, 6-11, 6-12
 - I**
 - IBM 468X/469X connection 8-4
 - IBM 468X/469X default parameters 8-5
 - IBM 468X/469X parameters 8-6
 - input/output ports 1-5
 - power-in port 1-5
 - interleaved 2 of 5 bar codes
 - check digit verification 13-70
 - convert to EAN-13 13-73
 - transmit check digit 13-72
 - K**
 - keyboard wedge connection 5-4
 - keyboard wedge default parameters 5-6
 - M**
 - maintenance 3-3
 - miscellaneous scanner parameters 14-3
 - mounting bracket attached configuration 1-11
 - N**
 - notational conventions xvi
 - P**
 - parameters
 - IBM 468X/469X 8-6
 - RS-232 6-7
 - USB 7-7
 - pinouts
 - scanner signal descriptions 3-9
 - prefix/suffix values 6-38
 - R**
 - replacing the scanner window 3-4
 - report mimic version 14-11
 - report synapse cable 14-12
 - report version 14-11
 - routing cables 1-8
 - RS-232 connection 6-4
 - RS-232 default parameters 6-6
 - RS-232 parameters 6-7, 6-9, 6-10, 6-11, 6-12
 - S**
 - scanner defaults 4-3
 - scanning
 - aiming 2-7
 - errors 4-3, 13-3, 14-3
 - sequence example 4-3, 13-3, 14-3
 - service information xvi
 - setup
 - connecting a USB interface 7-3
 - connecting an RS-232 interface 6-4
 - connecting keyboard wedge interface 5-4
 - connecting to an IBM 468X/469X host 8-4
 - installing the cable 1-6
 - replacing the scanner window 3-4
 - routing cables 1-8
 - unpacking 1-4
 - signal descriptions 3-9
 - sleep mode 2-6
 - specifications 3-7
 - standard default parameters 13-3, A-1
 - standard defaults 4-3
 - supported devices 1-4
 - symbology default parameters 13-3
- T**
 - technical specifications 3-7
 - U**
 - unpacking 1-4
 - UPC/EAN bar codes
 - bookland EAN 13-12
 - bookland ISBN 13-34
 - check digit 13-23, 13-24, 13-25
 - convert UPC-E to UPC-A 13-31
 - convert UPC-E1 to UPC-A 13-32
 - EAN zero extend 13-33
 - EAN-13/EAN-8 13-10, 13-11
 - supplemental redundancy 13-22
 - supplementals 13-13
 - UCC coupon extended code 13-35
 - UPC-A preamble 13-26
 - UPC-A/UPC-E 13-7, 13-8
 - UPC-E preamble 13-27
 - UPC-E1 13-9
 - USB connection 7-3
 - USB default parameters 7-6
 - USB parameters 7-7
 - user preferences parameters 4-4
 - W**
 - waking from sleep mode 2-6

Tell Us What You Think...

We'd like to know what you think about this Manual. Please take a moment to fill out this questionnaire and fax this form to: (631) 738-3318, or mail to:

Motorola
One Symbol Plaza M/S B-10
Holtsville, NY 11742-1300
Attention: Technical Publications Manager
Advanced Data Capture Division

IMPORTANT: If you need product support, please call the appropriate customer support number provided. Unfortunately, we cannot provide customer support at the fax number above.

Manual Title: _____
(please include revision level)

How familiar were you with this product before using this manual?

Very familiar Slightly familiar Not at all familiar

Did this manual meet your needs? If not, please explain.

What topics need to be added to the index, if applicable?

What topics do you feel need to be better discussed? Please be specific.

What can we do to further improve our manuals?

Thank you for your input—We value your comments.

Motorola
One Symbol Plaza
Holtsville, New York 11742-1300
<http://www.symbol.com>



72E-69531-02
Revision A - February 2007

Free Manuals Download Website

<http://myh66.com>

<http://usermanuals.us>

<http://www.somanuals.com>

<http://www.4manuals.cc>

<http://www.manual-lib.com>

<http://www.404manual.com>

<http://www.luxmanual.com>

<http://aubethermostatmanual.com>

Golf course search by state

<http://golfingnear.com>

Email search by domain

<http://emailbydomain.com>

Auto manuals search

<http://auto.somanuals.com>

TV manuals search

<http://tv.somanuals.com>