



MOTOMANUAL

L2
GSM

motorola.com

HELLOMOTO

Introducing your new Motorola L2 GSM wireless phone. Here's a quick anatomy lesson.

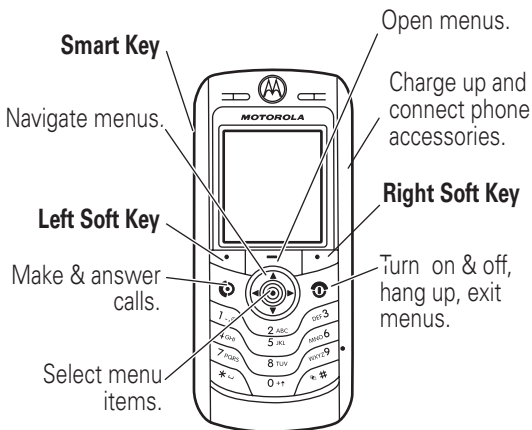

Motorola, Inc.
Consumer Advocacy Office
1307 East Algonquin Road
Schaumburg, IL 60196

www.hellomoto.com

Certain mobile phone features are dependent on the capabilities and settings of your service provider's network. Additionally, certain features may not be activated by your service provider, and/or the provider's network settings may limit the feature's functionality. Always contact your service provider about feature availability and functionality. All features, functionality, and other product specifications, as well as the information contained in this user's guide are based upon the latest available information and are believed to be accurate at the time of printing. Motorola reserves the right to change or modify any information or specifications without notice or obligation.

MOTOROLA and the Stylized - Logo are registered in the US Patent & Trademark Office. The Bluetooth trademarks are owned by their proprietor and used by Motorola, Inc. under license. Java and all other Java-based marks are trademarks or registered trademarks of Sun Microsystems, Inc. in the U.S. and other countries. All other product or service names are the property of their respective owners.

© Motorola, Inc., 2006.

Caution: Changes or modifications made in the radio phone, not expressly approved by Motorola, will void the user's authority to operate the equipment.

Software Copyright Notice

The Motorola products described in this manual may include copyrighted Motorola and third-party software stored in semiconductor memories or other media. Laws in the United States and other countries preserve for Motorola and third-party software providers certain exclusive rights for copyrighted software, such as the exclusive rights to distribute or

reproduce the copyrighted software. Accordingly, any copyrighted software contained in the Motorola products may not be modified, reverse-engineered, distributed, or reproduced in any manner to the extent allowed by law. Furthermore, the purchase of the Motorola products shall not be deemed to grant either directly or by implication, estoppel, or otherwise, any license under the copyrights, patents, or patent applications of Motorola or any third-party software provider, except for the normal, non-exclusive, royalty-free license to use that arises by operation of law in the sale of a product.

Manual Number: 6809500A40-0

contents

menu map	6	answer options	35
essentials	8	calls	36
about this guide	8	turn off a call alert . . .	36
SIM card	9	recent calls	36
battery	10	redial	37
turn it on & off	12	return a call	38
make a call	12	notepad	38
answer a call	13	hold or mute a call . . .	38
your phone number . .	13	call waiting	39
main attractions	14	caller ID	39
cable connections . . .	14	emergency calls	39
Bluetooth® wireless .	14	international calls . . .	40
basics	19	1-touch dial	40
display	19	voicemail	41
menus	22	other features	42
create SMS	24	advanced calling	42
volume	28	phonebook	44
navigation key	29	messages	48
handsfree speaker . . .	29	personalizing	50
codes & passwords . .	30	call times & costs . . .	52
lock & unlock phone .	30	handsfree	53
customize	32	data & fax calls	54
ring style	32	network	55
time & date	33	personal organizer . . .	56
wallpaper	33	security	57
screen saver	34	fun & games	58
display appearance . .	34		

service and repairs	60
SAR Data	61
index	63

menu map

main menu



Phonebook



Recent Calls

- Received Calls
- Dialed Calls
- Notepad
- Call Times *
- Call Cost
- Data Times *
- Data Volumes *



Messages

- Create Message
- Message Inbox
- Outbox
- Drafts
- MMS Templates
- Quick Notes
- Browser Msgs
- Info Services
- Voicemail



Tools

- SIM Tool Kit Apps *
- Calculator
- Datebook
- Shortcuts
- Alarm Clock
- Dialing Services
 - Fixed Dial
 - Service Dial*
 - Quick Dial
 - Voice Dial



Games & Apps



Web Access

- Browser
- Web Shortcuts
- Stored Pages
- History
- Go To URL
- Browser Setup
- Web Sessions*



Multimedia

- Pictures
- Sounds
- Videos



Bluetooth Link

- Handsfree
- Device History
- Setup



Settings

- (see next page)

* optional features

This is the standard main menu layout. Your phone's menu may be a little different.

settings menu



Personalize

- Home Screen
- Main Menu
- Color Style
- Greeting
- Wallpaper
- Screen Saver



Ring Styles

- Style
- Style Detail



Connection

- Bluetooth Link
- Sync



Call Forward *

- Voice Calls
- Fax Calls
- Data Calls
- Cancel All
- Forward Status



In-Call Setup

- In-Call Timer
- Call Cost Setup
- My Caller ID
- Talk and Fax
- Answer Options
- Call Waiting



Initial Setup

- Time and Date
- 1-Touch Dial
- Display Timeout
- Backlight
- TTY Setup *
- Scroll
- Language
- Contrast
- Brightness
- DTMF
- Master Reset
- Master Clear



Phone Status

- My Tel. Numbers
- Active Line
- Battery Meter
- Software Update
- Other Information



Headset

- Auto Answer
- Voice Dial



Car Settings

- Auto Answer
- Auto Handsfree
- Power-Off Delay
- Charger Time



Network

- New Network
- Network Setup
- Available Networks
- My Network List
- Service Tone
- Network Jingle *
- Call Drop Tone



Security

- Phone Lock
- Lock Keypad *
- Lock Application
- Fixed Dial
- Restrict Calls
- Call Barring *
- SIM PIN
- New Passwords
- Certificate Mgmt *



Java Settings

- Java Application Loader
- Delete All Apps
- Java System
- App Vibration
- App Volume
- App Backlight

* optional features



essentials



CAUTION: Before using the phone for the first time, read the *Important Safety and Legal Information* included in the gray-edged pages at the back of this guide.

about this guide

This guide shows how to locate a menu feature as follows:

Find it: Press  > **Recent Calls** > **Dialed Calls**

This example shows that, from the home screen, you press  to open the menu, highlight and select  **Recent Calls**, then highlight and select **Dialed Calls**.

Press  to scroll to and highlight a menu feature. Press the *center key*  to select the highlighted menu feature.

symbols



This means a feature is network/subscription dependent and may not be available in all areas. Contact your service provider for more information.



This means a feature requires an optional accessory.

SIM card

Your *Subscriber Identity Module* (SIM) card contains personal information like your phone number and phonebook entries.

Caution: Don't bend or scratch your SIM card. Keep it away from static electricity, water, and dirt.

1



2

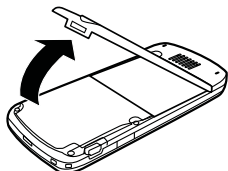

3

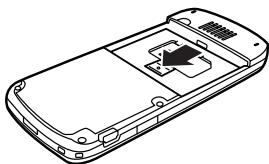

4

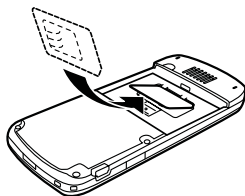

5

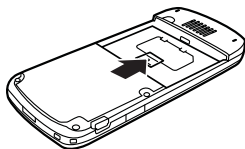

battery

battery installation

6

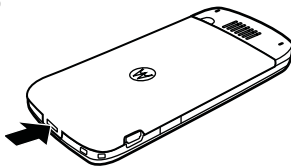

7

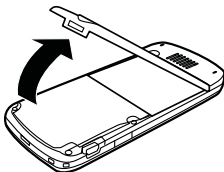

8

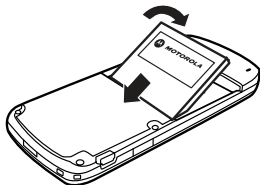

9

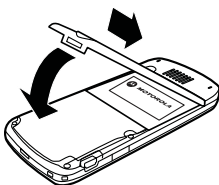

battery charging

New batteries are not fully charged. Plug the travel charger into your phone and an electrical outlet. Your phone display shows **Charge Complete** when finished.

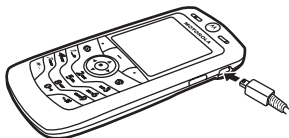

Tip: Relax, you can't overcharge your phone battery. It will perform best after you fully charge and discharge it a few times.

You can charge your phone battery by connecting a cable from your phone's mini-USB port to a USB port on a computer. Both your phone and the computer must be turned on, and your computer must have the correct software drivers installed. Cables and software drivers are available in Motorola Original data kits, sold separately.



If your phone battery is completely drained, a PC USB charger will not charge it. Use the travel charger.

battery tips

Battery life depends on the network, signal strength, temperature, features, and accessories you use.

- Always use Motorola Original batteries and chargers. The warranty does not cover damage caused by non-Motorola batteries and/or chargers.
- New batteries or batteries stored for a long time may take more time to charge.
- When charging your battery, keep it near room temperature.
- When storing your battery, keep it uncharged in a cool, dark, dry place, such as a refrigerator.
- Never expose batteries to temperatures below -10°C (14°F) or above 45°C (113°F). Always take your phone with you when you leave your vehicle.
- It is normal for batteries to gradually wear down and require longer charging times. If you notice a change in



your battery life, it is probably time to purchase a new battery.



Contact your local recycling center for proper battery disposal.

Warning: Never dispose batteries in a fire because they may explode.

Before using your phone, read the battery safety information in the “Safety and General Information” section included in this guide.

turn it on & off

To turn on your phone, press and hold  for a few seconds until the display turns on, and release. If prompted, enter your 4-digit unlock code.

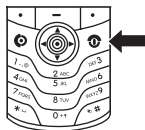

Caution: If you enter an incorrect PIN code 3 times in a row, your SIM card is disabled and your display shows **SIM Blocked**. Contact your service provider.

To turn off your phone, press and hold  for 2 seconds.

make a call

Enter a phone number and press  to make a call.

To “hang up,” press .

To maintain high audio quality during calls, please note the location of the phone's microphone (as indicated by the arrow) and keep this area free of obstruction while in use.

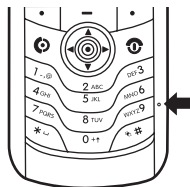



answer a call



When your phone rings and/or vibrates, just press  to answer.

To “hang up,” press .

your phone number

From the home screen, press   to see your number.

Tip: Want to see your phone number while you’re on a call? Press  > **My Tel. Numbers**.

You can edit the name and phone number stored on your SIM card. From the home screen, press  , select an entry, and press the **Edit** key. If you don’t know your phone number, contact your service provider. 

main attractions

You can do much more with your phone than make and receive calls!

cable connections

Note: Motorola Original USB data cable and supporting software may be sold together with the phone or separately. Check your computer or hand-held device to determine the type of cable you need. To **transfer data** between your phone and computer, you must install the software included with the Motorola Original data kit. See the data kit user's guide for more information. To make **data and fax calls** through a connected computer, see page 54.



 Your phone has a mini-USB port so you can connect it to a computer to transfer data.

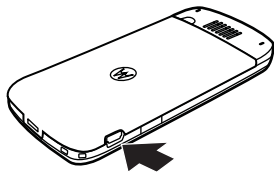

Bluetooth® wireless

Your phone supports Bluetooth wireless *pairing* (also called *linking* or *bonding*). You can pair your phone with a Bluetooth headset or car kit, or pair your phone with a computer to exchange and synchronize files.

Note: The use of wireless devices and their accessories may be prohibited or restricted in certain areas. Always obey the laws and regulations on the use of these products.

turn Bluetooth power on or off

Find it: Press  > **Bluetooth Link** > **Setup** > **Power** > **On**

If Bluetooth **Power** is **On**, your phone can automatically pair with the handsfree device you have used before. Just turn on the device or move it near the phone.

Note: To extend battery life, use the above procedure and set Bluetooth **Power** to **Off** when not in use. Your phone will not pair with devices until you set Bluetooth **Power** back to **On** and pair your phone with the devices again.

pair with a headset or handsfree device

Before you try to pair your phone with a device, make sure your phone's Bluetooth power is **on** and the device is **on** and **ready** in *pairing* or *bonding* mode (see the user's guide for the device). You can pair your phone with only one device at a time.

Find it: Press  > **Bluetooth Link** > **Handsfree** > **[Look For Devices]** 

Your phone lists the devices it finds within range.

10 Highlight a device in the list and press the **Select** key.

11 If necessary, enter the device passkey (such as 0000) and press the **Ok** key.

When your phone is paired, the Bluetooth indicator  shows in the home screen.



Tip: For information about your headset or handsfree device, refer to the instructions that came with it.

copy objects to another device

You can use Bluetooth pairing to copy a media object, phonebook entry, datebook event, or bookmark from your phone to a computer or other device.











Note: Preloaded multimedia objects cannot be copied.





- 12 Highlight the object on your phone that you want to copy to the other device.
- 13 Press  > **Mark** (or press **0** to mark objects) and then press  > **Copy Marked Files** (for media objects), **Send** (for datebook events), or **Share Phonebook Entry** (for phonebook entries).
- 14 Select a recognized device name, or **[Look For Devices]** to search for the device where you want to copy the object.

advanced Bluetooth features

features	
make phone visible to other device	Allow a Bluetooth device to discover your phone:  > Bluetooth Link > Setup > Find Me



features	
pair with recognized device	<p>Pair your phone with a recognized handsfree device: </p> <p> > Bluetooth Link > Handsfree > Look for Devices</p>
drop pairing with device	<p>Highlight the device name and press the Drop key. </p>
switch to device during call	<p>Switch to a headset or car kit during a call: </p> <p> > Use Bluetooth</p>
move multimedia object to device	<p>Move a multimedia object to another device: </p> <p>Note: Preloaded multimedia objects cannot be moved.</p> <p>Highlight the object, press  > Move, select the device name.</p> <p>Caution: Moving an object deletes the original object from your phone.</p>
copy media objects, datebook events, and phonebook entries	<p>Highlight the object you want to copy to another location.</p> <p>Press  > Mark (or press 0 to mark objects) and then press  > Copy Marked Files (for media objects), or press Send (for datebook events and phonebook entries).</p>

features	
print media objects, datebook events, and phonebook entries	<p>Highlight the object you want to print to a printer.</p> <p>Press  > Mark (or press 0 to mark objects) and then press  > Print Marked Files (for media objects), or press Print (for datebook events and phonebook entries).</p>
select print templates	<p>You can select desired print templates in the Print Options screen. After you have selected Print Marked Files or Print select Template > Change > View (press navigation key up or down to view different templates) > Select > [Print]</p> <p>Note: For Border Free picture printing, select Copy Marked Files instead of Print Marked Files. Preloaded pictures cannot be printed.</p>
edit device properties	<p>Edit the properties of a recognized device: </p> <p>Highlight the device name, press the Edit key.</p>
set Bluetooth options	<p>Highlight the device name, press  > Bluetooth Link > Setup </p>

basics



See page 1 for a basic phone diagram.

display

The *home screen* shows when you turn on the phone. To dial a number from the home screen, press number keys and .

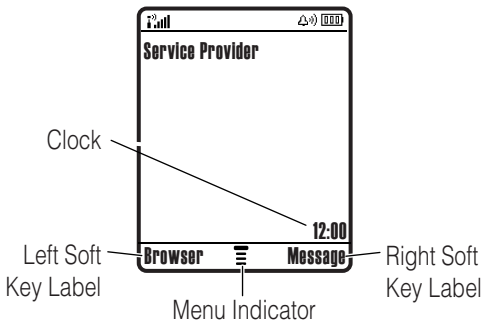
Note: Your home screen may look different from the one below, depending on your service provider.



The *Menu Indicator*  shows that you can press  to open the menu. *Soft Key Labels* show the current soft key functions. For soft key locations, see page 1.

Your home screen might show news from your service provider at the bottom. To change this news view, press  > **Settings** > **Personalize** > **Home Screen** > **Headlines** > **Off**.



Status indicators may be shown at the top of the home screen:

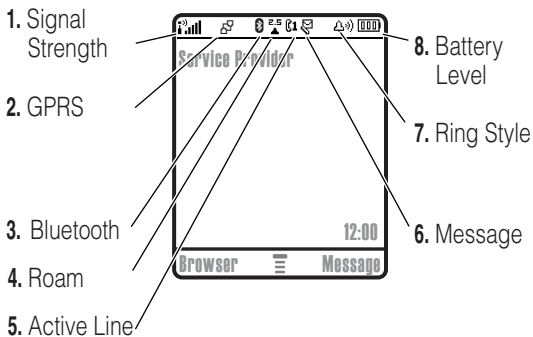

15 Signal Strength Indicator – Vertical bars show the strength of the network connection. You can't make or receive calls when or shows.

16 GPRS Indicator – Shows when your phone is using a *General Packet Radio Service* (GPRS) network connection. Indicators can include:



17

= GPRS PDP context active

= GPRS packet data available

18 Bluetooth Indicator – Shows when a Bluetooth® connection is active ().



19 Roam Indicator – Shows when your phone is seeking or using a network outside your home network. Indicators can include:



20

= 2G home

= 2G roam

= 2.5G home

= 2.5G roam

21 Active Line Indicator – Shows to indicate an active call, or to indicate when call forwarding is on. Indicators for dual-line-enabled SIM cards can include:



22

= line 1 active

= line 1 active, call forward on

= line 2 active

= line 2 active, call forward on

23 Message Indicator – Shows when you receive a new message. Indicators can include:



24

= text message

= voice message

25 Ring Style Indicator – Shows the ring style setting.

26

= loud ring

= vibrate & ring

= soft ring

= vibrate then ring

= vibrate

= silent





27 Battery Level Indicator – Vertical bars show the battery charge level. Recharge the battery when your phone shows **Low Battery**.

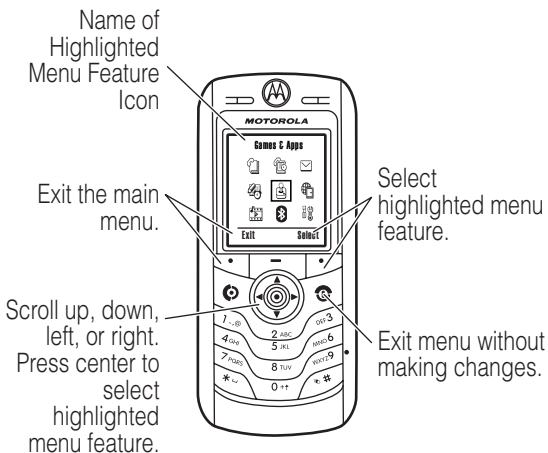



menus

From the home screen, press  to enter the main menu.



The following menu icons may be available, depending on your service provider and service subscription options.

menu features	
 Phonebook	 Web Access
 Recent Calls	 Multimedia

menu features	
 Messages	 Bluetooth Link
 Tools	 Settings
 Games & Apps	

Some features require you to select an option from a list:

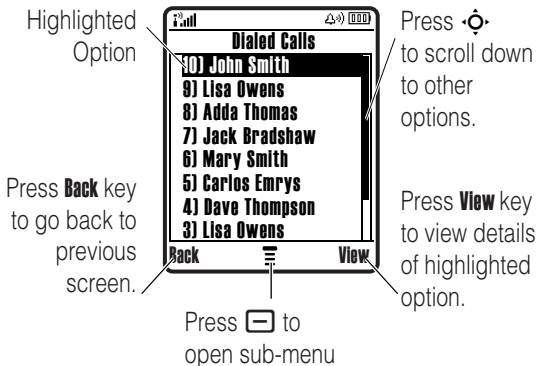

- Scroll up or down to highlight the option you want.
- In a numbered list, press a number key to highlight an option.
- In an alphabetized list, press a key repeatedly to cycle through its letters and highlight the closest matching list option.
- When an option has a list of possible settings, scroll left or right to select the setting.

- When an option has a list of possible numeric values, press a number key to set the value.

create SMS

To create a new message, enter text.

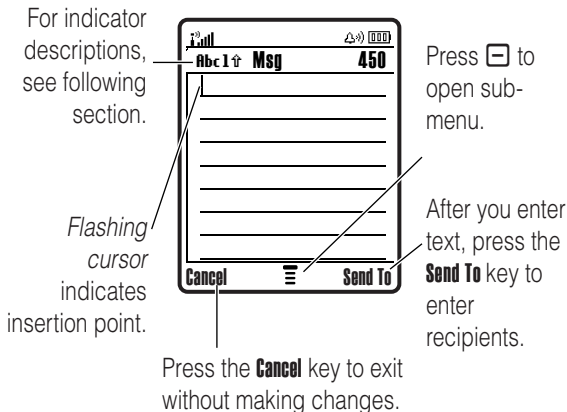

Press in a text entry view to select an entry mode:





entry modes	
or 1	Your Primary text entry mode can be set to any iTAP™ or tap 1 mode.
or 2	Your Secondary text entry mode can be set to any iTAP or tap 2 mode, or set to None if you don't want a secondary entry mode.

entry modes	
123	Numeric mode enters numbers only.
@	Symbol mode enters symbols only.

To set your primary and secondary text entry modes, press  > **Entry Setup** in a text entry view and select **Primary Setup** or **Secondary Setup**.

Tip: WANT TO BE LOUD IN YOUR MESSAGE? Press  in a text entry view to change text case to all capital letters (**ABC**), next letter capital (**Abc**), or no capitals (**abc**).

iTAP™ mode

Press  in a text entry view to switch to iTAP mode. If you don't see  or , press  > **Entry Setup** to set iTAP mode as your primary or secondary text entry mode.

iTAP mode lets you enter words using one key press per letter. The iTAP software combines your key presses into common words, and predicts each word as you enter it.

For example, if you press **7 7 6 4**, your display shows:

Press **Delete** key to delete last letter.

Press **Select** key to lock highlighted combination.

Press **⬆** up to accept **Program**.

Press **⬆** right to highlight another combination. Press **⊗** to enter **Prog** and a space.

- If you want a different word (such as **Progress**), continue pressing keypad keys to enter the remaining letters.
- To enter numbers quickly, press and hold a number key to temporarily switch to numeric mode. Press the number keys to enter the numbers you want. Enter a space to change back to iTAP mode.
- Press **1** to enter punctuation or other characters.

tap mode

Press **#** in a text entry view to switch to tap mode. If you don't see **Abc 1** or **Abc 2**, press **☰ > Entry Setup** to set tap mode as your primary or secondary text entry mode.

To enter text in tap mode, press a keypad key repeatedly to cycle through the letters and number on the key. Repeat this step to enter each letter.

For example, if you press **8** one time, your display shows:

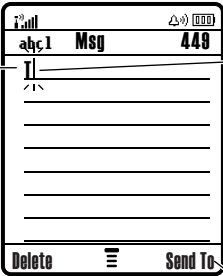

The screenshot shows a text entry interface. At the top, there are status icons for signal strength, battery, and a numeric keypad icon. Below that, the text 'abc1' is on the left and 'Msg' is in the center, with '449' on the right. The main text area contains 'I' at the insertion point, with a cursor below it. The bottom of the screen has three buttons: 'Delete', a menu icon, and 'Send To'.

Character displays at insertion point.

After 2 seconds, character is accepted and cursor moves to next position.

Press the **Delete** key to delete character to left of insertion point.

After you enter text, press the **Send To** key to enter recipients.



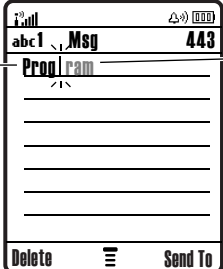

When you enter three or more characters in a row, your phone may guess the rest of the word. For example, if you enter **prog** your display might show:



The screenshot shows a text entry interface. At the top, there are status icons for signal strength, battery, and a numeric keypad icon. Below that, the text 'abc1' is on the left and 'Msg' is in the center, with '443' on the right. The main text area contains 'Program' at the insertion point, with a cursor below it. The bottom of the screen has three buttons: 'Delete', a menu icon, and 'Send To'.

Character displays at insertion point.

Press **⊙** right to accept **Program**, or press ***** to reject it and enter a space after **Prog**.

- The first character of every sentence is capitalized. If necessary, press   down to change the character to lowercase before the cursor moves to the next position.
- Press   to move the flashing cursor to enter or edit message text.
- If you don't want to save your text or text edits, press  to exit without saving.
- *Tap extended* mode cycles through additional special characters and symbols as you repeatedly press a keypad key.

numeric mode

Press  in a text entry view until you see **123**. Press the number keys to enter the numbers you want.

symbol mode

Press  in a text entry view until you see **@**. Press a keypad key to show its symbols at the bottom of the display. Highlight the symbol you want, then press the **Select** key.

volume

Press the the navigation key  left or right to:

- increase or decrease earpiece volume during a call

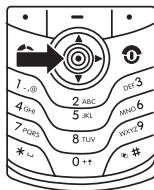

- increase or decrease the ringer volume setting when the home screen is displayed
- turn off an incoming call alert

Tip: At the lowest volume setting, press the navigation key (◂◂◂) left to set your ringer to **Vibrate**. Press it again to switch to the **Silent** alert. To turn **Vibrate** or ringer alerts back on, press the navigation key (◂◂◂) to the right.

Note: The navigation key (◂◂◂) does not adjust ringer volume when headlines are active (it changes channels). Headlines are service provider dependent.

navigation key

Press the *navigation key* ◂◂◂ up, down, left, or right to scroll and highlight items in the display. When you highlight something, press the *center key* ◂◂◂ to select it. The center key usually performs the same function as the right soft key.



handsfree speaker

You can use your phone's handsfree speaker to make calls without holding the phone to your ear.

During a call, press the **Speaker** key to turn the handsfree speaker on. Your display shows **Spkrphone On** until you turn it off or end the call.

Note: The handsfree speaker won't work when your phone is connected to a handsfree car kit or headset.

codes & passwords

Your phone's 4-digit **unlock code** is originally set to **1234**. The 6-digit **security code** is originally set to **000000**. If your service provider didn't change these codes, you should change them:

Find it: Press  > **Settings** > **Security** > **New Passwords**

If you forget your unlock code: At the **Enter Unlock Code** prompt, try entering 1234 or the last four digits of your phone number. If that doesn't work, press  and enter your 6-digit security code instead.

If you forget other codes: If you forget your security code, SIM PIN code, PIN2 code, or call barring password, contact your service provider.

lock & unlock phone



You can lock your phone to keep others from using it. To lock or unlock your phone, you need the 4-digit unlock code.

To **manually lock** your phone: Press  > **Settings** > **Security** > **Phone Lock** > **Lock Now**.

To **automatically lock** your phone whenever you turn it off: Press  > **Settings** > **Security** > **Phone Lock** > **Automatic Lock** > **On**.

Note: You can make emergency calls on a locked phone (see page 39). A locked phone still rings or vibrates for incoming calls or messages, **but you need to unlock it to answer**.

lock & unlock keypad

You can lock your keypad to prevent accidental key presses.
Press   to lock or unlock the keypad.

customize

ring style

Each ring style profile uses a different set of sounds or vibrations for incoming calls and other events. Here are the profiles you can choose:

 Loud

 Vibrate

 Vibe Then Ring

 Soft

 Vibe & Ring

 Silent

The ring style profile's indicator shows at the top of your home screen. To choose your profile:

Find it: Press  > **Settings** > **Ring Styles** > **Style:** *style name*

change alerts in a ring style

You can change the alerts for incoming calls and other events. Your changes are saved in the current ring style profile.

Find it: Press  > **Settings** > **Ring Styles** > **Style Detail**

Note: *Style* represents the current ring style. You can't set an alert for the **Silent** ring style setting.

28 Highlight **Calls** (or **Line 1** or **Line 2** for dual-line phones), then press the **Change** key to change it.

29 Highlight the alert you want, then press the **Select** key.

30 Press the **Back** key to save the alert setting.

time & date

Your phone needs the time and date for the datebook.

To synchronize the time and date with the network:
Press  > **Settings** > **Initial Setup** > **Time and Date** > **Autoupdate**
> **On**



To set the time and date: Press  > **Settings** > **Initial Setup**
> **Time and Date** > *time* or *date*.

Note: If your home screen shows news information from your service provider, you must turn off the news view to see a clock. Press  > **Settings** > **Personalize** > **Home Screen** > **Headlines** > **Off**.



wallpaper

Set a picture or animation as a wallpaper (background) image in your home screen.

Find it: Press  > **Settings** > **Personalize** > **Wallpaper**

options	
Picture	Select an image for your wallpaper, or None for no wallpaper.
Layout	Select Center to center the image in the display, Tile to repeat the image across the display, or Fit-to-screen to stretch the image across the display.

screen saver

Set a picture or animation as a screen saver. The screen saver shows when no activity is detected for a specified time.

Tip: This feature helps save your screen, but not your battery. To extend battery life, turn off the screen saver.

Find it: Press  > **Settings** > **Personalize** > **Screen Saver**

options	
Picture	Select an image for your screen saver, or None for no screen saver.
Delay	Select the length of inactivity before the screen saver shows.

display appearance

To choose a phone **color style** that sets the look and feel of your phone's display: Press  > **Settings** > **Personalize** > **Color Style**.

To set your display **contrast**: Press  > **Settings** > **Initial Setup** > **Contrast**.

To save battery life, your **backlight** turns off when you're not using your phone. The backlight turns back on when you press a key. To set how long your phone waits before the backlight turns off:

Press  > **Settings** > **Initial Setup** > **Backlight**.

Note: Your **keypad backlight** is light dependent and will only illuminate when the light conditions are low.

To save battery life, the **display** can turn off when you're not using your phone. The display turns back on when you press a key. To set how long your phone waits before the display turns off:

Press  > **Settings** > **Initial Setup** > **Display Timeout**.

answer options

You can use additional, alternative methods to answer an incoming call. To activate or deactivate an answer option:

Find it: Press  > **Settings** > **In-Call Setup** > **Answer Options** > **Multi-key** > **On** or **Off**

calls

To make and answer calls, see page 12.

turn off a call alert

You can press  to turn off a call alert before answering the call.

recent calls



Your phone keeps lists of incoming and outgoing calls, even for calls that didn't connect. The most recent calls are listed first. The oldest calls are deleted as new calls are added.

Shortcut: Press  from the home screen to see the dialed calls list.

Find it: Press  > **Recent Calls**

31 Highlight **Received Calls** or **Dialed Calls**, then press the **Select** key.

32 Highlight a call. A ✓ next to a call means the call connected.



- To call the number, press .
- To see call details (like time and date), press the **View** key.
- To see the **Last Calls Menu**, press . This menu can include:

options	
Store	Create a phonebook entry with the number in the No. field. Store does not appear if the number is already stored.
Delete	Delete the entry.
Delete All	Delete all entries in the list.
Hide ID/Show ID	Hide or show your caller ID for the next call.
Send Message	Open a new text message with the number in the To field.
Add Digits	Add digits after the number.
Attach Number	Attach a number from the phonebook or recent calls lists.
Talk then Fax	Talk and then send a fax in the same call (see page 55). 

redial

33 Press  from the home screen to see the dialed calls list.

34 Highlight the entry you want to call, then press .

If you hear a **busy signal** and you see **Call Failed, Number Busy**, you can press  or the **Retry** key to redial the number. When the call goes through, your phone rings or vibrates one time, shows **Redial Successful**, and connects the call. 

return a call

Your phone keeps a record of your unanswered calls, and shows **X Missed Calls**, where **X** is the number of missed calls.



35 Press the **View** key to see the received calls list.

36 Highlight the call you want to return, then press .

notepad

The last set of digits entered on the keypad are stored in *notepad* memory. This can be the last phone number you called, or a number that you “jot down” during a call for later use. To see the number stored in the notepad:

Find it: Press  > **Recent Calls** > **Notepad**

- To call the number, press .
- To create a phonebook entry with the number in the **No.** field, press the **Store** key.
- To open the **Dialing Menu** to attach a number or insert a special character, press .

hold or mute a call

Press  > **Hold** to put all active calls on hold.

Press the **Mute** key (if available) or  > **Mute** to put all active calls on mute.

call waiting

When you're on a call, you'll hear an alert if you receive a second call.



Press  to answer the new call.

- To switch between calls, press the **Switch** key.
- To connect the two calls, press the **Link** key.
- To end the call on hold, press  > **End Call On Hold**.

To turn the call waiting feature on or off:

Find it: Press  > **Settings** > **In-Call Setup** > **Call Waiting**

caller ID

Calling line identification (caller ID) shows the phone number for an incoming call in your display.



Your phone shows the caller's name when they're stored in your phonebook, or **Incoming Call** when caller ID information isn't available.

You can set your phone to play a different ringer ID for an entry stored in your phonebook (see page 45).

To show or hide **your phone number** from the next person you call, enter the phone number and press

 > **Hide ID/Show ID**.

emergency calls

Your service provider programs one or more emergency phone numbers, such as 911 or 112, that you can call under

any circumstances, even when your phone is locked or the SIM card is not inserted.

Note: Emergency numbers vary by country. Your phone's preprogrammed emergency number(s) may not work in all locations, and sometimes an emergency call cannot be placed due to network, environmental, or interference issues.

37 Press the keypad keys to dial the emergency number.

38 Press  to call the emergency number.

international calls

If your phone service includes international dialing, press and hold  to insert your local international access code (indicated by +). Then, press the keypad keys to dial the country code and phone number.





1-touch dial

To call phonebook entries 1 through 9, press and hold the single-digit speed dial number for one second.

You can set 1-touch dial to call the entries in your phone's memory phonebook, your SIM card's phonebook, or your Fixed Dial list:

Find it: Press  > **Settings** > **Initial Setup** > **1 Touch Dial**
> **Phone, SIM, or Fixed Dial**

To add a new phonebook entry, see page 44. To edit the **Speed No.** for a phonebook entry, press  > **Phonebook**, highlight the entry, and press  > **Edit**.

voicemail

Your network stores the voicemail messages you receive. To listen to your messages, call your voicemail number.



Note: Your service provider may include additional information about using this feature.

When you **receive** a voicemail message, your phone shows the voicemail message indicator  and **New Voicemail**. Press the **CALL** key to listen to the message.



To **check** voicemail messages:













Find it: Press  > **Messages** > **Voicemail**











Your phone may prompt you to store your voicemail phone number. If you don't know your voicemail number, contact your service provider.



Note: You can't store a **p** (pause), **w** (wait), or **n** (number) character in this number. If you want to store a voicemail number with these characters, create a phonebook entry for it. Then, you can use the entry to call your voicemail.

other features





advanced calling







features	
conference call	During a call: Dial next number, press  , press the Link key. 
transfer a call	During a call:  > Transfer , dial transfer number, press  
attach a phone number	Dial an area code or prefix for a phonebook number, then:  > Attach Number 
speed dial	Speed dial a phonebook entry: Enter the speed dial number, press  , then press  . To add a phonebook entry, see page 44. Tip: If you forget Aunt Mildred's speed dial number, press  > Phonebook , highlight her entry, and press the View key. 
call forwarding	Set up or cancel call forwarding:  > Settings > Call Forward 

features	
restrict calls	<p>Restrict outgoing or incoming calls: </p> <p> > Settings > Security > Restrict Calls</p>
call barring	<p>Restrict outgoing or incoming calls: </p> <p> > Settings > Security > Call Barring</p>
TTY calls	<p>Set up your phone for use with an optional TTY device: </p> <p> > Settings > Initial Setup > TTY Setup</p>
change phone line	<p>If you have a dual-line-enabled SIM card, you can change your line to make and receive calls from your other phone number. </p> <p> > Settings > Phone Status > Active Line</p> <p>The active line indicator shows the active phone line (see page 21).</p>
fixed dial	<p>When you turn on fixed dialing, you can call only numbers stored in the fixed dial list. </p> <p>Turn fixed dialing on or off:</p> <p> > Settings > Security > Fixed Dial</p> <p>Use the fixed dial list:</p> <p> > Tools > Dialing Services > Fixed Dial</p>

features	
DTMF tones	<p>Activate DTMF tones:</p> <p> > Settings > Initial Setup > DTMF</p> <p>To send DTMF tones during a call, just press number keys or highlight a number in the phonebook or recent calls lists and press  > Send Tones.</p>



phonebook

features	
add new entry	<p> > Phonebook  > New > Phone Number</p> <p>Shortcut: Enter a phone number in the home screen, then press the Store key to create an entry for that number.</p> <p>Tip: One phone isn't enough for some people. When creating a phonebook entry, select MORE to store another number for the same Name.</p>
dial number	<p>Call a number stored in the phonebook:</p> <p> > Phonebook, highlight the phonebook entry, press </p> <p>Shortcut: In the phonebook, press keypad keys to enter the first letters of an entry name, then press the Search key to jump to the entry.</p>









features	
record a voice name	<p>When creating a phonebook entry, highlight Voice Name and press the Record key. Press and release the voice key and say the entry's name (within 2 seconds). When prompted, press and release the voice key and repeat the name.</p> <p>Note: The Voice Name option isn't available in entries stored on the SIM card.</p>
voice dial number	<p>Voice dial a number stored in the phonebook:</p> <p> > Tools > Dialing Services > Voice Dial</p>
set ringer ID for entry	<p>Assign a ring alert (ringer ID) to an entry:</p> <p> > Phonebook > <i>entry</i>  > Edit > Ringer ID > <i>ringer name</i></p> <p>Note: The Ringer ID option isn't available in entries stored on the SIM card.</p> <p>Activate ringer IDs:</p> <p> > Settings > Ring Styles > <i>style Detail</i> > Ringer IDs</p>
set picture ID for entry	<p>Assign a photo or picture to show when you receive a call from an entry:</p> <p> > Phonebook > <i>entry</i>  > Edit > Picture</p> <p>Note: The Picture option isn't available in entries stored on the SIM card.</p>





















features	
set category for entry	<p>☐ > Phonebook > <i>entry</i> ☐ > Edit > Category > <i>category name</i></p> <p>Note: The Category option isn't available in entries stored on the SIM card.</p>
set category view	<p>☐ > Phonebook</p> <p>☐ > Categories > <i>category view</i></p> <p>You can show All entries, entries in a predefined category (Business, Personal, General, VIPs), or entries in a category you create.</p>
set primary number or address	<p>Set the primary number for an entry with multiple numbers:</p> <p>☐ > Phonebook, highlight the entry, press ☐ > Set Primary > <i>number or address</i></p> <p>Note: The Set Primary option isn't available in entries stored on the SIM card.</p> <p>Tip: In Primary number view mode, you can still peek at other numbers stored for the same name. Highlight the name and press ⬅️ or ➡️ to see the other numbers.</p>

features	
create group mailing list	<p>You can put several phonebook entries in a group mailing list, then send a multimedia message to the list. To create a list:</p> <p>☐ > Phonebook ☐ > New > Mailing List</p> <p>You can select the list name as an address for multimedia messages.</p> <p>Note: A Mailing List cannot include entries stored on the SIM card.</p>
sort phonebook list	<p>Set the order in which entries are listed:</p> <p>☐ > Phonebook ☐ > Setup > Sort by > <i>sort order</i></p> <p>You can sort the phonebook list by Name, Speed No., Voice Name, or Email. When sorting by name, you can see All numbers or just the Primary number for each name.</p>
copy phonebook entry	<p>Copy an entry from the phone to the SIM card, or from the SIM card to the phone:</p> <p>☐ > Phonebook, highlight the entry, press ☐ > Copy > Entries > To</p>
send phonebook entry in a text message	<p>Send a phonebook entry in a text message:</p> <p>☐ > Insert > Contact Info > Phonebook (highlight phonebook entries), press Add > Done</p>









features	
send phonebook entry over Bluetooth® connection	<p>Send a phonebook entry to another phone, computer, or device:</p> <ul style="list-style-type: none">  > Phonebook, highlight the entry, press  > Share Phonebook Entry > Look for Devices

messages

features	
send text message	<p> > Messages > Create Message > New Short Message > enter text > Send To > press center key  to select recipient > Send</p> 
send multimedia message	<p> > Messages > Create Message > New Multimedia Msg</p> 
send voice message	<p> > Messages > Create Message > New Voice Msg</p> <p>To record the voice message, press the Record key, speak, then press the Stop key. Your phone inserts the voice recording into a message.</p> 
use a multimedia template	<p>Open a multimedia message with preloaded animations:</p> <p> > Messages > Create Message > MMS Templates</p> 

features		
read messages	<p> > Messages > Message Inbox</p> <p>Icons next to each message indicate if it is read  or unread . Icons can also indicate if the message is locked , urgent , low priority , or has an attachment .</p> <p>To see message options like Lock or Delete, highlight a message and press .</p>	
store message objects	<p>Go to a multimedia message press:</p> <p> > Store</p>	
store text messages on your SIM card	<p>To store incoming text messages on your SIM card, press:</p> <p> > Messages >  > Inbox Setup > Text Msg Setup > Store To: > SIM</p>	
browser messages	<p>Read messages received by your micro-browser:</p> <p> > Messages > Browser Msgs</p>	
info services	<p>Read subscription-based information services messages:</p> <p> > Messages > Info Services</p>	
change message service center number	<p>You can change the message service center number.</p> <p> > Messages >  > Inbox Setup > Text Msg Setup > [Service Centre No.]</p>	

personalizing

features	
language	Set menu language:  > Settings > Initial Setup > Language
scroll	Set the highlight bar to stop or wrap around in menu lists:  > Settings > Initial Setup > Scroll
activate ringer IDs	Activate ringer IDs assigned to phonebook entries and categories:  > Settings > Ring Styles > <i>style</i> Detail > Ringer IDs
ring volume	 > Settings > Ring Styles > <i>style</i> Detail > Ring Volume
keypad volume	 > Settings > Ring Styles > <i>style</i> Detail > Key Volume
reminders	Set reminder alerts for messages that you receive:  > Settings > Ring Styles > <i>style</i> Detail > Reminders
news view	If your service provider broadcasts news information that always appears in your home screen, you can turn the news view on or off:  > Settings > Personalize > Home Screen > Headlines > On or Off 

features	
menu view	Show the main menu as graphic icons or as a text-based list: ☰ > Settings > Personalize > Main Menu > View
main menu	Reorder your phone's main menu: ☰ > Settings > Personalize > Main Menu > Reorder
show/hide menu icons	Show or hide menu feature icons in the home screen: ☰ > Settings > Personalize > Home Screen > Home Keys > Icons
shortcuts	Create a shortcut to a menu item: Highlight the menu item, then press and hold ☰. Use a shortcut: Press ☰, then press the shortcut number.
master reset	Reset the phone to the default settings: ☰ > Settings > Initial Setup > Master Reset This phone will be reset to default settings.

features

master clear

Erase all downloaded files and clear all settings and entries you made **except** SIM card information, unlock code, security code, and lifetime timer:







 > Settings > Initial Setup > Master Clear

Caution: Master clear **erases all information you have entered** (including phonebook and datebook entries) **and content you have downloaded** (including photos and sounds) stored in your phone's memory. After you erase the information, you can't recover it.

call times & costs



Network connection time is the elapsed time from the moment you connect to your service provider's network to the moment you end the call by pressing . This time includes busy signals and ringing.









The amount of network connection time you track on your resettable timer may not equal the amount of time for which you are billed by your service provider. For billing information, contact your service provider.

features		
call times	Show call timers:  > Recent Calls > Call Times	
in-call timer	Show time or cost information during a call:  > Settings > In-Call Setup > In-Call Timer	
call cost	Show call cost trackers:  > Recent Calls > Call Cost	

handsfree



Note: The use of wireless devices and their accessories may be prohibited or restricted in certain areas. Always obey the laws and regulations on the use of these products.

features		
speakerphone	Activate the speakerphone during a call: Press the Speaker key (if available, or  > Spkrphone On).	
auto answer (car kit or headset)	Automatically answer calls when connected to a car kit or headset:  > Settings > Car Settings or Headset > Auto Answer	

features		
voice dial (headset)	Enable voice dial with headset send/end key:	
	 > Settings > Headset > Voice Dial	
auto handsfree (car kit)	Automatically route calls to a car kit when connected:	
	 > Settings > Car Settings > Auto Handsfree	
power-off delay (car kit)	Set the phone to stay on for a specified time after the ignition is switched off:	
	 > Settings > Car Settings > Power-Off Delay	
charger time (car kit)	Charge the phone for a specified time after the ignition is switched off:	
	 > Settings > Car Settings > Charger Time	

data & fax calls

To connect your phone with a USB cable, see page 14.

features		
send data or fax	Connect your phone to the device, then place the call through the device application.	
receive data or fax	Connect your phone to the device, then answer the call through the device application.	

features

talk then fax

Connect your phone to the device, enter fax number, press



> **Talk then Fax**, then press to make the call.

using sync

You can call an Internet server and synchronize your phonebook and datebook entries with the server.



To **set up** an Internet sync partner, press > **Settings** > **Connection** > **Sync** > **[New Entry]**. Enter the server details, including **Server URL** (you can omit **http://**) and **Data Path** (the folder below the URL where your data is stored).

To **synchronize files** with a partner you set up, select the partner from the list in > **Settings** > **Connection** > **Sync**.

network

features











network settings

See network information and adjust network settings:



> **Settings** > **Network**

personal organizer











features	
set alarm	 > Tools > Alarm Clock > [New Alarm] > Enable
turn off alarm	When an alarm happens: To turn off the alarm, press the Disable key or  . To set an 8 minute delay, press the Snooze key.
add new datebook event	 > Tools > Datebook , highlight the day, press  , press  > New
see datebook event	See or edit event details:  > Tools > Datebook , highlight the day, press  , press the View key
event reminder	When an event reminder happens: To see reminder details, press the View key. To close the reminder, press the Exit key.
send datebook event to another device	Send a datebook event to another phone, computer, or device:  > Tools > Datebook , highlight the day, press  , highlight the event, press  > Send
calculator	 > Tools > Calculator

features	
currency converter	<p>☰ > Tools > Calculator ☰ > Exchange Rate</p> <p>Enter exchange rate, press the Ok key, enter amount, and press</p> <p>☰ > Convert Currency.</p>

security

features	
SIM PIN	<p>Lock or unlock the SIM card:</p> <p>☰ > Settings > Security > SIM PIN</p> <p>Caution: If you enter an incorrect PIN code 3 times in a row, your SIM card is disabled and your display shows SIM Blocked.</p>
lock feature	☰ > Settings > Security > Lock Application
manage certificates	<p>Enable or disable Internet access certificates stored on your phone: </p> <p>☰ > Settings > Security > Certificate Mgmt</p> <p>Certificates are used to verify the identity and security of Web sites when you download files or share information.</p>

fun & games

features		
manage pictures	Manage pictures and animations:  > Multimedia > Pictures	
manage video clips	 > Multimedia > Videos	
manage sounds	Manage ring tones and music that you have downloaded or composed:  > Multimedia > Sounds	
create ring tones	Create ring tones that you can use with your phone:  > Multimedia > Sounds > [New iMelody]	
start micro-browser	 > Web Access > Browser	
download objects from Web page	Download a picture, sound, or other object from a Web page:  > Web Access > Browser , go to the page that links to the file, highlight the link, and select it. Note: Normal airtime and/or carrier usage charges apply.	
Web sessions	Select or create a Web session:  > Web Access > Web Sessions	

features

download game or application

You can download a Java™ game or application the same way you download pictures or other objects:



 > **Web Access** > **Browser**, go to the page that links to the file, highlight the link, and select it.

Note: Normal airtime and/or carrier usage charges apply.

start game or application

Start a Java™ game or application:



 > **Games & Apps**, highlight the game or application, press the **Select** key

service and repairs

If you have questions or need assistance, we're here to help.

Go to www.motorola.com/consumer/support, where you can select from a number of customer care options. You can also contact the Motorola Customer Support Center at 1-800-331-6456 (United States), 1-888-390-6456 (TTY/TDD United States for hearing impaired), or 1-800-461-4575 (Canada).

Specific Absorption Rate Data

The model wireless phone meets the government's requirements for exposure to radio waves.

Your wireless phone is a radio transmitter and receiver. It is designed and manufactured not to exceed limits for exposure to radio frequency (RF) energy set by the Federal Communications Commission (FCC) of the U.S. Government and by the Canadian regulatory authorities. These limits are part of comprehensive guidelines and establish permitted levels of RF energy for the general population. The guidelines are based on standards that were developed by independent scientific organizations through periodic and thorough evaluation of scientific studies. The standards include a substantial safety margin designed to assure the safety of all persons, regardless of age or health.

The exposure standard for wireless mobile phones employs a unit of measurement known as the Specific Absorption Rate, or SAR. The SAR limit set by the FCC and by the Canadian regulatory authorities is 1.6 W/kg.¹ Tests for SAR are conducted using standard operating positions accepted by the FCC and by Industry Canada with the phone transmitting at its highest certified power level in all tested frequency bands. Although the SAR is determined at the highest certified power level, the actual SAR level of the phone while operating can be well below the maximum value. This is because the phone is designed to operate at multiple power levels so as to use only the power required to reach the network. In general, the closer you are to a wireless base station, the lower the power output.

Before a phone model is available for sale to the public in the U.S. and Canada, it must be tested and certified to the FCC and Industry Canada that it does not exceed the limit established by each government for safe exposure. The tests are performed in positions and locations (e.g., at the ear and worn on the body) reported to the FCC and available for review by

Industry Canada. The highest SAR value for this model phone when tested for use at the ear is 1.54 W/kg, and when worn on the body, as described in this user guide, is 0.45 W/kg. The SAR value for this product in its data transmission mode (body-worn use) is 0.22 W/kg. (Body-worn measurements differ among phone models, depending upon available accessories and regulatory requirements).²

While there may be differences between the SAR levels of various phones and at various positions, they all meet the governmental requirements for safe exposure. Please note that improvements to this product model could cause differences in the SAR value for later products; in all cases, products are designed to be within the guidelines.

Additional information on Specific Absorption Rates (SAR) can be found on the Cellular Telecommunications & Internet Association (CTIA) Web site:

<http://www.phonefacts.net>.

or the Canadian Wireless Telecommunications Association (CWTA) Web site:

<http://www.cwta.ca>.

1. In the United States and Canada, the SAR limit for mobile phones used by the public is 1.6 watts/kg (W/kg) averaged over one gram of tissue. The standard incorporates a substantial margin of safety to give additional protection for the public and to account for any variations in measurements.
2. The SAR information includes the Motorola testing protocol, assessment procedure, and measurement uncertainty range for this product.

index

A

- accessories 8, 53
- accessory connector port 1
- active line indicator 21
- active line, changing 43
- alarm clock 56
- alert
 - set 29, 32
 - turn off 29, 36
- animation 58
- answer a call 13, 35
- attach a number 37, 42

B

- backlight 34
- battery 10
- battery indicator 22
- battery life, extending 11, 15, 34, 35
- bluetooth
 - indicator 20
- Bluetooth connection 14, 16, 48, 56
- brightness 34
- browser messages 49
- browser. See micro-browser

C

- cables 14
- calculator 56
- call
 - answer 13, 35
 - end 12, 13
 - make 12, 44
- call barring 43
- call cost 53
- call forward indicator 21
- call forwarding 42
- call timers 53
- call waiting 39
- caller ID 37, 39, 45
- car kit 53
- center key 1, 29
- certificate management 57
- clock 33
- codes 30
- conference call 42
- copy files 16

D

- data call 54
- date, setting 33
- datebook 56
- dial a phone number 12, 43,

44
dialed calls 36
display 19, 34, 50
download media objects 49,
58
DTMF tones 44

E

earpiece volume 29
emergency number 39
end a call 12, 13
end key 1, 12, 13
Enter Unlock Code message
30

F

fax call 37, 54, 55
fixed dial 43
forward calls 42

G

games 59
GPRS indicator 20
group mailing list 47

H

handsfree speaker 29
headset 53
headset jack 1
hold a call 38

home screen 19, 50, 51

I

in-call indicator 21
Incoming Call message 39
information services 49
international access code 40
iTAP text entry mode 25

J

Java applications 59

K

keypad 31, 50

L

language 50
linking. See Bluetooth con-
nection
lock
 application 57
 keypad 31
 phone 30
 SIM card 57
Low Battery message 22

M

make a call 12, 44
master clear 52
master reset 51

menu 22, 50, 51
menu icons 22, 51
menu indicator 19
menu key 1, 8
message 48, 49
message indicator 21
message reminders 50
micro-browser 49, 58, 59
Missed Calls message 38
multimedia message 48, 49
music 58
mute a call 38

N

navigation key 1, 8, 29
network settings 55
news 19, 50
notepad 38
number. See phone number
numeric entry mode 28

O

object exchange 16
1-touch dial 40
optional accessory 8
optional feature 8

P

pairing. See Bluetooth connection
passwords. See codes

personalize 50
phone number 13, 43, 44
phonebook 37, 40, 42, 44
photo 58
picture 58
picture ID 39, 45
PIN code 12, 57
power key 1, 12

R

received calls 36
recent calls 36
redial 37
reminders 50
restrict calls 43
return a call 38
ring style indicator 21
ring style, setting 29, 32
ring tone 58
ringer ID 39, 45, 50
ringer volume 29, 50
roam indicator 21

S

screen saver 34
security code 30
send key 1, 12, 13
shortcuts 51
signal strength indicator 20
SIM 49
SIM Blocked message 12,

57

SIM card 9, 12, 57

soft keys 1, 19

speakerphone 53

speed dial 42

store your number 13

symbol entry mode 28

synchronizing 55

T

tap text entry mode 26

telephone number. See

phone number

text entry 24

text message 48, 49

time, setting 33

timers 53

transfer a call 42

TTY device 43

turn on/off 12

U

unlock

application 57

keypad 31

phone 12, 30

SIM card 57

unlock code 30

USB cables 14

V

video clip 58

voice dial 45, 54

voice message 48

voice name, recording 45

voicemail 41

voicemail message indicator

21, 41

volume 28, 50

W

wallpaper 33

Web pages 58

Web sessions 58

wireless connection. See

Bluetooth connection

Y

your phone number 13

U.S. patent Re. 34,976



MOTOROLA

***IMPORTANT SAFETY AND
LEGAL INFORMATION >***

Software Copyright Notice

The Motorola products described in this manual may include copyrighted Motorola and third-party software stored in semiconductor memories or other media. Laws in the United States and other countries preserve for Motorola and third-party software providers certain exclusive rights for copyrighted software, such as the exclusive rights to distribute or reproduce the copyrighted software. Accordingly, any copyrighted software contained in the Motorola products may not be modified, reverse-engineered, distributed, or reproduced in any manner to the extent allowed by law. Furthermore, the purchase of the Motorola products shall not be deemed to grant either directly or by implication, estoppel, or otherwise, any license under the copyrights, patents, or patent applications of Motorola or any third-party software provider, except for the normal, non-exclusive, royalty-free license to use that arises by operation of law in the sale of a product.

Manual Number: 6809497A47-0

Contents

Safety Information	4
Exposure To Radio Frequency (RF) Energy.....	4
Operational Precautions.....	4
RF Energy Interference/Compatibility.....	5
Driving Precautions.....	7
Operational Warnings.....	7
Choking Hazards.....	9
Glass Parts.....	9
Seizures/Blackouts.....	9
Repetitive Motion.....	9
Warranty	11
What Does this Warranty Cover?.....	11
Who Is Covered?.....	14
What Will Motorola Do?.....	14
How to Obtain Warranty Service or Other Information.....	14
What Other Limitations Are There?.....	15
Hearing Aid Compatibility	17
WHO Information	19
Product Registration	19
Export Law Assurances	20
Wireless: The New Recyclable	20
Smart Practices While Driving	21

Safety and General Information

This section contains important information on the safe and efficient operation of your mobile device. Read this information before using your mobile device.*

Exposure To Radio Frequency (RF) Energy

Your mobile device contains a transmitter and receiver. When it is ON, it receives and transmits RF energy. When you communicate with your mobile device, the system handling your call controls the power level at which your mobile device transmits.

Your Motorola mobile device is designed to comply with local regulatory requirements in your country concerning exposure of human beings to RF energy.

Operational Precautions

For optimal mobile device performance and to be sure that human exposure to RF energy does not exceed the guidelines set forth in the relevant standards, always follow these instructions and precautions.

External Antenna Care

If your mobile device has an external antenna, use only a Motorola-supplied or approved replacement antenna. Use of unauthorized antennas, modifications, or attachments could damage the mobile device and/or may result in your device not complying with local regulatory requirements in your country.

* The information provided in this document supersedes the general safety information in user's guides published prior to September 1, 2005.

DO NOT hold the external antenna when the mobile device is IN USE. Holding the external antenna affects call quality and may cause the mobile device to operate at a higher power level than needed.

Product Operation

When placing or receiving a phone call, hold your mobile device just like you would a landline phone.

If you wear the mobile device on your body, always place the mobile device in a Motorola-supplied or approved clip, holder, holster, case, or body harness. If you do not use a body-worn accessory supplied or approved by Motorola, keep the mobile device and its antenna at least 2.5 centimeters (1 inch) from your body when transmitting.

When using any data feature of the mobile device, with or without an accessory cable, position the mobile device and its antenna at least 2.5 centimeters (1 inch) from your body.

Using accessories not supplied or approved by Motorola may cause your mobile device to exceed RF energy exposure guidelines. For a list of Motorola-supplied or approved accessories, visit our website at www.motorola.com.

RF Energy Interference/Compatibility

Nearly every electronic device is subject to RF energy interference from external sources if inadequately shielded, designed, or otherwise configured for RF energy compatibility. In some circumstances your mobile device may cause interference with other devices.

This device complies with Part 15 of the FCC Rules. Operation is subject to the following two conditions: (1) this device may not cause harmful interference, and (2) this device must accept any interference received, including interference that may cause undesired operation.

Follow Instructions to Avoid Interference Problems

Turn off your mobile device in any location where posted notices instruct you to do so. These locations include hospitals or health care facilities that may be using equipment that is sensitive to external RF energy.

In an aircraft, turn off your mobile device whenever instructed to do so by airline staff. If your mobile device offers an airplane mode or similar feature, consult airline staff about using it in flight.

Pacemakers

If you have a pacemaker, consult your physician before using this device.

Persons with pacemakers should observe the following precautions:

- ALWAYS keep the mobile device more than 20 centimeters (8 inches) from your pacemaker when the mobile device is turned ON.
- DO NOT carry the mobile device in the breast pocket.
- Use the ear opposite the pacemaker to minimize the potential for interference.
- Turn OFF the mobile device immediately if you have any reason to suspect that interference is taking place.

Hearing Aids

Some digital mobile devices may interfere with some hearing aids. In the event of such interference, you may want to consult your hearing aid manufacturer or physician to discuss alternatives.

Other Medical Devices

If you use any other personal medical device, consult your physician or the manufacturer of your device to determine if it is adequately shielded from RF energy.

Driving Precautions

Check the laws and regulations on the use of mobile devices in the area where you drive. Always obey them.

When using your mobile device while driving, please:

- Give full attention to driving and to the road. Using a mobile device may be distracting. Discontinue a call if you can't concentrate on driving.
- Use handsfree operation, if available.
- Pull off the road and park before making or answering a call if driving conditions so require.

Responsible driving practices can be found in the “Smart Practices While Driving” section at the end of this guide and/or at the Motorola website: www.motorola.com/callsmart.

Operational Warnings

Obey all posted signs when using mobile devices in public areas, such as health care facilities or blasting areas.

Automobile Air Bags

Do not place a mobile device in the air bag deployment area.

Potentially Explosive Atmospheres

Areas with potentially explosive atmospheres are often but not always posted, and can include fueling areas such as below decks on boats, fuel or chemical transfer or storage facilities, or areas where the air contains chemicals or particles, such as grain, dust, or metal powders.

When you are in such an area, turn off your mobile device, and do not remove, install, or charge batteries. In such areas, sparks can occur and cause an explosion or fire.

Damaged Products





If your mobile device or battery has been submerged in water, punctured, or subjected to a severe fall, do not use it until you take it to a Motorola Authorized Service Center. Do not attempt to dry it with an external heat source, such as a microwave oven.

Batteries and Chargers

If jewelry, keys, beaded chains, or other conductive materials touch exposed battery terminals, this could complete an electrical circuit (short circuit), become very hot, and could cause damage or injury. Be careful when handling a charged battery, particularly when placing it inside a pocket, purse, or other container with metal objects. **Use only Motorola Original™ batteries and chargers.**

Caution: To avoid risk of personal injury, do not dispose of your battery in a fire.

Your battery, charger, or mobile device may contain symbols, defined as follows:

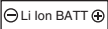
Symbol	Definition
	Important safety information follows.
	Do not dispose of your battery or mobile device in a fire.
	Your battery or mobile device may require recycling in accordance with local laws. Contact your local regulatory authorities for more information.
	Do not throw your battery or mobile device in the trash.
	Your mobile device contains an internal lithium ion battery.

Choking Hazards

Your mobile device or its accessories may include detachable parts, which may present a choking hazard to small children. Keep your mobile device and its accessories away from small children.

Glass Parts

Some parts of your mobile device may be made of glass. This glass could break if the product is dropped on a hard surface or receives a substantial impact. If glass breaks, do not touch or attempt to remove. Stop using your mobile device until the glass is replaced by a qualified service center.

Seizures/Blackouts

Some people may be susceptible to epileptic seizures or blackouts when exposed to flashing lights, such as when playing video games. These may occur even if a person has never had a previous seizure or blackout.

If you have experienced seizures or blackouts, or if you have a family history of such occurrences, please consult with your physician before playing video games or enabling a flashing-lights feature (if available) on your mobile device.

Discontinue use and consult a physician if any of the following symptoms occur: convulsion, eye or muscle twitching, loss of awareness, involuntary movements, or disorientation. It is always a good idea to hold the screen away from your eyes, leave the lights on in the room, take a 15-minute break every hour, and stop use if you are very tired.

Repetitive Motion

When you repetitively perform actions such as pressing keys or entering finger-written characters, you may experience occasional discomfort in your hands, arms, shoulders, neck, or other parts of your body. If you

continue to have discomfort during or after such use, stop use and see a physician.

Motorola Limited Warranty for the United States and Canada

What Does this Warranty Cover?

Subject to the exclusions contained below, Motorola, Inc. warrants its telephones, pagers, messaging devices, and consumer and professional two-way radios (excluding commercial, government or industrial radios) that operate via Family Radio Service or General Mobile Radio Service, Motorola-branded or certified accessories sold for use with these Products ("Accessories") and Motorola software contained on CD-ROMs or other tangible media and sold for use with these Products ("Software") to be free from defects in materials and workmanship under normal consumer usage for the period(s) outlined below. This limited warranty is a consumer's exclusive remedy, and applies as follows to new Motorola Products, Accessories and Software purchased by consumers in the United States or Canada, which are accompanied by this written warranty:

Products and Accessories

Products Covered	Length of Coverage
Products and Accessories as defined above, unless otherwise provided for below.	One (1) year from the date of purchase by the first consumer purchaser of the product unless otherwise provided for below.
Decorative Accessories and Cases. Decorative covers, bezels, PhoneWrap™ covers and cases.	Limited lifetime warranty for the lifetime of ownership by the first consumer purchaser of the product.

Products Covered	Length of Coverage
Monaural Headsets. Ear buds and boom headsets that transmit mono sound through a wired connection.	Limited lifetime warranty for the lifetime of ownership by the first consumer purchaser of the product.
Consumer and Professional Two-Way Radio Accessories.	Ninety (90) days from the date of purchase by the first consumer purchaser of the product.
Products and Accessories that are Repaired or Replaced.	The balance of the original warranty or for ninety (90) days from the date returned to the consumer, whichever is longer.

Exclusions

Normal Wear and Tear. Periodic maintenance, repair and replacement of parts due to normal wear and tear are excluded from coverage.

Batteries. Only batteries whose fully charged capacity falls below 80% of their rated capacity and batteries that leak are covered by this limited warranty.

Abuse & Misuse. Defects or damage that result from: (a) improper operation, storage, misuse or abuse, accident or neglect, such as physical damage (cracks, scratches, etc.) to the surface of the product resulting from misuse; (b) contact with liquid, water, rain, extreme humidity or heavy perspiration, sand, dirt or the like, extreme heat, or food; (c) use of the Products or Accessories for commercial purposes or subjecting the Product or Accessory to abnormal usage or conditions; or (d) other acts which are not the fault of Motorola, are excluded from coverage.

Use of Non-Motorola Products and Accessories. Defects or damage that result from the use of Non-Motorola branded or certified Products, Accessories, Software or other peripheral equipment are excluded from coverage.

Unauthorized Service or Modification. Defects or damages resulting from service, testing, adjustment, installation, maintenance, alteration, or modification in any way by someone other than Motorola, or its authorized service centers, are excluded from coverage.

Altered Products. Products or Accessories with (a) serial numbers or date tags that have been removed, altered or obliterated; (b) broken seals or that show evidence of tampering; (c) mismatched board serial numbers; or (d) nonconforming or non-Motorola housings, or parts, are excluded from coverage.

Communication Services. Defects, damages, or the failure of Products, Accessories or Software due to any communication service or signal you may subscribe to or use with the Products Accessories or Software is excluded from coverage.

Software

Products Covered	Length of Coverage
Software. Applies only to physical defects in the media that embodies the copy of the software (e.g. CD-ROM, or floppy disk).	Ninety (90) days from the date of purchase.

Exclusions

Software Embodied in Physical Media. No warranty is made that the software will meet your requirements or will work in combination with any hardware or software applications provided by third parties, that the operation of the software products will be uninterrupted or error free, or that all defects in the software products will be corrected.

Software NOT Embodied in Physical Media. Software that is not embodied in physical media (e.g. software that is downloaded from the internet), is provided "as is" and without warranty.

Who Is Covered?

This warranty extends only to the first consumer purchaser, and is not transferable.

What Will Motorola Do?

Motorola, at its option, will at no charge repair, replace or refund the purchase price of any Products, Accessories or Software that does not conform to this warranty. We may use functionally equivalent reconditioned/refurbished/pre-owned or new Products, Accessories or parts. No data, software or applications added to your Product, Accessory or Software, including but not limited to personal contacts, games and ringer tones, will be reinstalled. To avoid losing such data, software and applications please create a back up prior to requesting service.

How to Obtain Warranty Service or Other Information

USA	Phones 1-800-331-6456 Pagers 1-800-548-9954 Two-Way Radios and Messaging Devices 1-800-353-2729
Canada	All Products 1-800-461-4575
TTY	1-888-390-6456
For Accessories and Software , please call the telephone number designated above for the product with which they are used.	

You will receive instructions on how to ship the Products, Accessories or Software, at your expense, to a Motorola Authorized Repair Center. To obtain service, you must include: (a) a copy of your receipt, bill of sale or other comparable proof of purchase; (b) a written description of the problem; (c) the name of your service provider, if applicable; (d) the name and location of the installation facility (if applicable) and, most importantly; (e) your address and telephone number.

What Other Limitations Are There?

ANY IMPLIED WARRANTIES, INCLUDING WITHOUT LIMITATION THE IMPLIED WARRANTIES OF MERCHANTABILITY AND FITNESS FOR A PARTICULAR PURPOSE, SHALL BE LIMITED TO THE DURATION OF THIS LIMITED WARRANTY, OTHERWISE THE REPAIR, REPLACEMENT, OR REFUND AS PROVIDED UNDER THIS EXPRESS LIMITED WARRANTY IS THE EXCLUSIVE REMEDY OF THE CONSUMER, AND IS PROVIDED IN LIEU OF ALL OTHER WARRANTIES, EXPRESS OR IMPLIED. IN NO EVENT SHALL MOTOROLA BE LIABLE, WHETHER IN CONTRACT OR TORT (INCLUDING NEGLIGENCE) FOR DAMAGES IN EXCESS OF THE PURCHASE PRICE OF THE PRODUCT, ACCESSORY OR SOFTWARE, OR FOR ANY INDIRECT, INCIDENTAL, SPECIAL OR CONSEQUENTIAL DAMAGES OF ANY KIND, OR LOSS OF REVENUE OR PROFITS, LOSS OF BUSINESS, LOSS OF INFORMATION OR DATA, SOFTWARE OR APPLICATIONS OR OTHER FINANCIAL LOSS ARISING OUT OF OR IN CONNECTION WITH THE ABILITY OR INABILITY TO USE THE PRODUCTS, ACCESSORIES OR SOFTWARE TO THE FULL EXTENT THESE DAMAGES MAY BE DISCLAIMED BY LAW.

Some states and jurisdictions do not allow the limitation or exclusion of incidental or consequential damages, or limitation on the length of an implied warranty, so the above limitations or exclusions may not apply to you. This warranty gives you specific legal rights, and you may also have other rights that vary from state to state or from one jurisdiction to another.

Laws in the United States and other countries preserve for Motorola certain exclusive rights for copyrighted Motorola software such as the exclusive rights to reproduce and distribute copies of the Motorola software. Motorola software may only be copied into, used in, and redistributed with, the Products associated with such Motorola software. No other use, including without limitation disassembly of such Motorola software or exercise of the exclusive rights reserved for Motorola, is permitted.

Hearing Aid Compatibility with Mobile Phones

Some Motorola phones are measured for compatibility with hearing aids. If the box for your particular model has “Rated for Hearing Aids” printed on it, the following explanation applies.

When some mobile phones are used near some hearing devices (hearing aids and cochlear implants), users may detect a buzzing, humming, or whining noise. Some hearing devices are more immune than others to this interference noise, and phones also vary in the amount of interference they generate.

The wireless telephone industry has developed ratings for some of their mobile phones, to assist hearing device users in finding phones that may be compatible with their hearing devices. Not all phones have been rated. Phones that are rated have the rating on their box or a label on the box.

The ratings are not guarantees. Results will vary depending on the user’s hearing device and hearing loss. If your hearing device happens to be vulnerable to interference, you may not be able to use a rated phone successfully. Trying out the phone with your hearing device is the best way to evaluate it for your personal needs.

M-Ratings: Phones rated M3 or M4 meet FCC requirements and are likely to generate less interference to hearing devices than phones that are not labeled. M4 is the better/higher of the two ratings.

T-Ratings: Phones rated T3 or T4 meet FCC requirements and are likely to be more usable with a hearing device’s telecoil (“T Switch” or “Telephone Switch”) than unrated phones. T4 is the better/higher of the two ratings. (Note that not all hearing devices have telecoils in them.)

Hearing devices may also be measured for immunity to this type of interference. Your hearing device manufacturer or hearing health

professional may help you find results for your hearing device. The more immune your hearing aid is, the less likely you are to experience interference noise from mobile phones.

Information from the World Health Organization

Present scientific information does not indicate the need for any special precautions for the use of mobile phones. If you are concerned, you may want to limit your own or your children's RF exposure by limiting the length of calls or by using handsfree devices to keep mobile phones away from your head and body.

Source: WHO Fact Sheet 193

Further information: <http://www.who.int./peh-emf>

Product Registration

Online Product Registration:

<http://www.motorola.com/warranty>

Product registration is an important step toward enjoying your new Motorola product. Registering helps us facilitate warranty service, and permits us to contact you should your product require an update or other service. Registration is for U.S. residents only and is not required for warranty coverage.

Please retain your original dated sales receipt for your records. For warranty service of your Motorola Personal Communications Product you will need to provide a copy of your dated sales receipt to confirm warranty status.

Thank you for choosing a Motorola product.

Export Law Assurances

This product is controlled under the export regulations of the United States of America and Canada. The Governments of the United States of America and Canada may restrict the exportation or re-exportation of this product to certain destinations. For further information contact the U.S. Department of Commerce or the Canadian Department of Foreign Affairs and International Trade.

Wireless: The New Recyclable

Your wireless phone can be recycled. Recycling your wireless phone reduces the amount of waste disposed in landfills and allows recycled materials to be incorporated into new products.

The Cellular Telecommunications Industry Association (CTIA) and its members encourage consumers to recycle their phones and have taken steps to promote the collection and environmentally sound recycling of end-of-life wireless devices.

As a wireless phone user, you have an important role in ensuring that this phone is recycled properly. When it comes time to give this phone up or trade it in for a new one, please remember that the phone, the charger, and many of its accessories can be recycled. It's easy. To learn more about CTIA's Recycling Program for Used Wireless Devices, please visit us at <http://promo.motorola.com/recycle/phones/whyrecycle.html>

Smart Practices While Driving

Drive Safe, Call Smart SM

Check the laws and regulations on the use of mobile devices and their accessories in the areas where you drive. Always obey them. The use of these devices may be prohibited or restricted in certain areas. Contact www.motorola.com/callsmart for more information.

Your mobile device lets you communicate by voice and data—almost anywhere, anytime, wherever wireless service is available and safe conditions allow. When driving a car, driving is your first responsibility. If you choose to use your mobile device while driving, remember the following tips:

- **Get to know your Motorola mobile device and its features such as speed dial and redial.** If available, these features help you to place your call without taking your attention off the road.
- **When available, use a handsfree device.** If possible, add an additional layer of convenience to your mobile device with one of the many Motorola Original™ handsfree accessories available today.
- **Position your mobile device within easy reach.** Be able to access your mobile device without removing your eyes from the road. If you receive an incoming call at an inconvenient time, if possible, let your voice mail answer it for you.
- **Let the person you are speaking with know you are driving; if necessary, suspend the call in heavy traffic or hazardous weather conditions.** Rain, sleet, snow, ice, and even heavy traffic can be hazardous.
- **Do not take notes or look up phone numbers while driving.** Jotting down a “to do” list or going through your address book

takes attention away from your primary responsibility—driving safely.

- **Dial sensibly and assess the traffic; if possible, place calls when your car is not moving or before pulling into traffic.** If you must make a call while moving, dial only a few numbers, check the road and your mirrors, then continue.
- **Do not engage in stressful or emotional conversations that may be distracting.** Make people you are talking with aware you are driving and suspend conversations that can divert your attention away from the road.
- **Use your mobile device to call for help.** Dial 911 or other local emergency number in the case of fire, traffic accident, or medical emergencies.*
- **Use your mobile device to help others in emergencies.** If you see an auto accident, crime in progress, or other serious emergency where lives are in danger, call 911 or other local emergency number, as you would want others to do for you.*
- **Call roadside assistance or a special non-emergency wireless assistance number when necessary.** If you see a broken-down vehicle posing no serious hazard, a broken traffic signal, a minor traffic accident where no one appears injured, or a vehicle you know to be stolen, call roadside assistance or other special non-emergency wireless number.*

* Wherever wireless phone service is available.

Free Manuals Download Website

<http://myh66.com>

<http://usermanuals.us>

<http://www.somanuals.com>

<http://www.4manuals.cc>

<http://www.manual-lib.com>

<http://www.404manual.com>

<http://www.luxmanual.com>

<http://aubethermostatmanual.com>

Golf course search by state

<http://golfingnear.com>

Email search by domain

<http://emailbydomain.com>

Auto manuals search

<http://auto.somanuals.com>

TV manuals search

<http://tv.somanuals.com>