

## Two-Way Radio User's Guide



MR355/MR356

KEM-PK14190-94B

The MR Series is approved for use in the US only.

### For More Information

For further information, you may call Motorola at 1-800-638-5119, or e-mail us at [giantintl@callcenter.com](mailto:giantintl@callcenter.com) or visit us on the Internet at [www.motorola.com](http://www.motorola.com).

## Safety and General Information

### Important Information on Safe and Efficient Operation

#### Read This Information Before Using Your Radio.

The information provided in this document supersedes the general safety information in user guides published prior to December 1, 2002.

#### Transmit and Receive Procedure

Your two-way radio contains a transmitter and a receiver. To control your exposure and ensure compliance with the general population/uncontrolled environment exposure limits, always adhere to the following procedure:

- Transmit no more than 50% of the time.
- To receive calls, release the PTT button.
- To transmit (talk), press the Push-to-Talk (PTT) button.

Transmitting 50% of the time, or less, is important because the radio generates measurable RF energy exposure only when transmitting (in terms of measuring standards compliance).

#### Exposure to Radio Frequency Energy

Your Motorola two-way radio complies with the following RF energy exposure standards and guidelines:

- United States Federal Communications Commission, Code of Federal Regulations; 47CFR part 2 sub-part J.
- American National Standards Institute (ANSI)/Institute of Electrical and Electronic Engineers (IEEE) C95. 1-1992.
- Institute of Electrical and Electronics Engineers (IEEE) C95. 1-1999 Edition.
- International Commission on Non-Ionizing Radiation Protection (ICNIRP) 1998.
- Ministry of Health (Canada) Safety Code 6. Limits of Human Exposure to Radiofrequency Electromagnetic Fields in the Frequency Range from 3 KHz to 300 GHz, 1999.
- Australian Communications Authority Radiocommunications (Electromagnetic Radiation—Human Exposure) Standard, 2003.
- ANATEL ANNEX to Resolution No. 303 of July 2, 2002 "Regulation of limitation of exposure to electrical, magnetic and electromagnetic fields in the radio frequency range between 9 KHz and 300GHz".

To ensure optimal radio performance and make sure human exposure to radio frequency electromagnetic energy is within the guidelines set forth in the above standards, always adhere to the following procedures.

#### Portable Radio Operation and EME Exposure

##### Antenna Care

Use only the supplied or an approved replacement antenna. Unauthorized antennas, modifications, or attachments could damage the radio and may violate FCC regulations.

Do NOT hold the antenna when the radio is "IN USE." Holding the antenna affects its effective range.

##### Body-Worn Operation

To maintain compliances with FCC guidelines if you wear a radio on your body when transmitting always place the radio in a Motorola-supplied or approved clip holder, holster, case or body harness for this product. Use of non-Motorola-approved accessories may exceed FCC guidelines.

If you do not use one of the Motorola-supplied or approved body-worn accessories and are not using the radio held in the normal use position, **ensure the radio and its antenna are at least 1 inch (2.5 cm) from your body when transmitting.**

##### Data Operation

If applicable, when using any data feature of the radio with or without an accessory cable, **position the radio and its antenna at least one inch (2.5 cm) from the body.**

##### Approved Accessories

For a list of approved Motorola accessories, visit our Web site at [www.motorola.com](http://www.motorola.com).

##### Electromagnetic Interference/Compatibility

**Note:** Nearly every electronic device is susceptible to electromagnetic interference (EMI) if inadequately shielded, designed or otherwise configured for electromagnetic compatibility. This device complies with Part 15 of the FCC Rules. Operation is subject to the following two conditions:

1. This device may not cause harmful interference; and
2. This device must accept any interference received, including interference that may cause undesired operation.

##### Facilities

To avoid electromagnetic interference and/or compatibility conflicts, turn off your radio in any facility where posted notices instruct you to do so. Hospitals or health care facilities may be using equipment that is sensitive to external RF energy.

##### Aircraft

When instructed to do so, turn off your radio when onboard an aircraft. Any use of a radio must be in accordance with applicable regulations per airline crew instructions.

##### Medical Devices – Pacemakers

The Advanced Medical Technology Association recommends that a minimum separation of 6 inches (15 cm) be maintained between a handheld wireless radio and a pacemaker. These recommendations are consistent with the independent research by and recommendations of the U.S. Food and Drug Administration.

People with pacemakers should:

- ALWAYS keep the radio more than 6 inches (15 cm) from their pacemaker when the radio is turned ON.
- Not carry the radio in the breast pocket.
- Use the ear opposite the pacemaker to minimize the potential for interference.
- Turn the radio OFF immediately if there is any reason to suspect that interference is taking place.

##### Medical Devices – Hearing Aids

Some digital wireless radios may interfere with some hearing aids. In the event of such interference, you may want to consult your hearing aid manufacturer to discuss alternatives.

##### Medical Devices – Other

If you use any other personal medical device, consult the manufacturer of your device to determine if it is adequately shielded from RF energy. Your physician may be able to assist you in obtaining this information.

#### Safety and General Use While Driving

Check the laws and regulations regarding the use of radios in the area where you drive, and always obey them. If you do use your radio while driving, please:

- Give full attention to driving and to the road.
- Use hands-free operation, if available.
- Pull off the road and park before making or answering a call if driving conditions so require.

The use of a two-way radio while engaged in activities requiring concentration may cause distraction or otherwise impair your ability to safely participate in such activities. Always use technology safely.

Do not place a portable radio in the area over an air bag or in the air bag deployment area. Air bags inflate with great force. If a portable radio is placed in the air bag deployment area and the air bag inflates, the radio may be propelled with great force and cause serious injury to occupants of the vehicle.

##### Potentially Explosive Atmospheres

Turn off your radio prior to entering any area with a potentially explosive atmosphere. Only radio types that are especially qualified should be used in such areas as "Intrinsically Safe." Do not remove, install or charge batteries in such areas. Sparks in a potentially explosive atmosphere can cause an explosion or fire resulting in bodily injury or even death.

**Note:** The areas with potentially explosive atmospheres referred to above include fueling areas such as below decks on boats, fuel or chemical transfer or storage facilities, areas where the air contains chemicals or particles (such as grain, dust or metal powders) and any other area where you would normally be advised to turn off your vehicle engine. Areas with potentially explosive atmospheres are often—but not always—posted.

##### Blasting Caps and Areas

To avoid possible interference with blasting operations, turn off your radio when you are near electrical blasting caps, in a blasting area, or in areas posted "Turn off two-way radios." Obey all signs and instructions.

#### Operational Cautions

##### Antennas

**Do not use any portable radio that has a damaged antenna.** If a damaged antenna comes into contact with your skin, a minor burn can result.

##### Batteries

All batteries can cause property damage and/or bodily injury such as burns if a conductive material—like jewelry, keys or beaded chains—touch exposed terminals. The conductive material may complete an electrical circuit (short circuit) and become quite hot. Exercise care in handling any charged battery, particularly when placing it inside a pocket, purse or other container with metal objects.

Exercise care when removing NiMH or AA batteries. Do not use sharp or conductive tools to remove either of these batteries.

##### Battery Charger Safety Instructions:

#### Save these Instructions

1. Do not expose the charger to rain or snow.
2. Do not operate or disassemble the charger if it has received a sharp blow, or has been dropped or damaged in any way.
3. Never alter the AC cord or plug provided with the unit. If the plug will not fit the outlet, have the proper outlet installed by a qualified electrician. An improper condition can result in a risk of electric shock.
4. To reduce the risk of damage to the cord or plug, pull the plug rather than the cord when disconnecting the charger from the AC receptacle.
5. To reduce the risk of electric shock, unplug the charger from the outlet before attempting any maintenance or cleaning.
6. Use of an attachment not recommended or sold by Motorola may result in a risk of fire, electric shock or personal injury.
7. Make sure the cord is located so it will not be stepped on, tripped over or subjected to damage or stress.
8. An extension cord should not be used unless absolutely necessary. Use of an improper extension cord could result in a risk of a fire and/or electric shock. If an extension cord must be used, make sure that:
  - The pins on the plug of the extension cord are the same number, size and shape as those on the plug of the charger.
  - The extension cord is properly wired and in good condition.
  - The extension cord size is 18 AWG for lengths up to 100 feet, and 16 AWG for lengths up to 150 feet.
9. The supply cord of the AC adaptor cannot be replaced. If the cord is damaged, call customer service at 1-800-638-5119 or e-mail us at [giantintl@callcenter.com](mailto:giantintl@callcenter.com).

## FCC Licensing Information

Your Motorola radio operates on General Mobile Radio Service (GMRS) frequencies and is subject to the Rules and Regulations of the Federal Communications Commission (FCC). The FCC requires that all operators using GMRS frequencies obtain a radio license before operating their equipment. To obtain the FCC forms, please visit the FCC's Web site at [wireless.fcc.gov/uls/index.htm?job=home](http://wireless.fcc.gov/uls/index.htm?job=home) to source form 605 and 159, which includes all the instructions you will need.

If you wish to have the document faxed or mailed, or if you have questions, please use the following contact information:

For a fax: Contact the Fax-On-Demand system	For mail service: Call the FCC Forms Hotline	If you have questions about the FCC License: Call the FCC
1-202-418-0177	1-800-418-FORM (3676)	1-888-CALL-FCC (225-5322)

Changes or modifications not expressly approved by Motorola may void the user's authority granted by the FCC to operate this radio and should not be made. To comply with FCC requirements, transmitter adjustments should be made only by or under the supervision of a person certified as technically qualified to perform transmitter maintenance and repairs in the private land mobile and fixed services as certified by an organization representative of the user of those services. Replacement of any transmitter component (crystal, semiconductor, etc.) not authorized by the FCC equipment authorization for this radio could violate FCC rules.

**Note:** Use of this radio outside the country where it was intended to be distributed is subject to government regulations and may be prohibited.

## Control Buttons

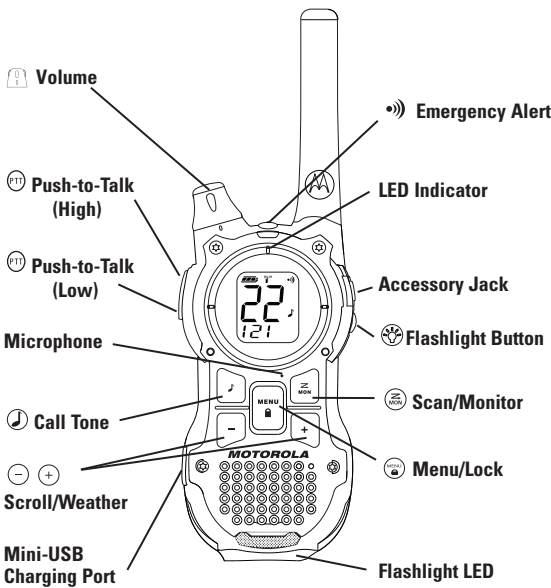

## Display Screen Guide

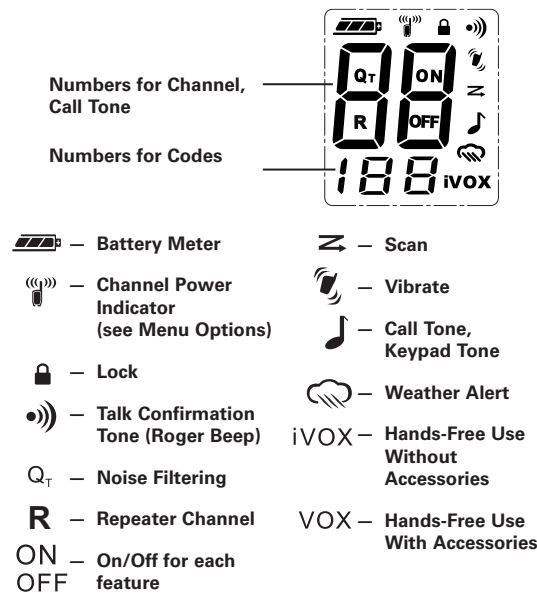

## Getting Started

#### Installing the Batteries

Each radio can use either 1 NiMH rechargeable battery pack or 3 AA alkaline batteries and beeps when the batteries are low.



#### Installing NiMH Rechargeable Battery Pack (Optional Accessory)

1. Turn the radio off.
2. With the back of the radio facing you, lift the battery cover latch up and remove the cover.
3. Remove the NiMH battery pack from the clear plastic bag (do not disassemble or unwrap the battery pack).
4. Insert the NiMH battery pack with the diagram facing you. (The ribbon should be underneath the battery pack and should wrap around the right side of the pack for easy removal.)
5. Reposition the battery cover and press down to secure.

#### Installing the Three AA Alkaline Batteries

1. Turn the radio off.
2. With the back of the radio facing you, lift the battery cover latch up and remove the cover.
3. Insert the three AA alkaline batteries with + and - polarity as shown inside. (The ribbon should be underneath the AA alkaline batteries and should wrap around the right side of the batteries.)
4. Reposition the battery cover and press down to secure.

#### Radio Battery Meter

The radio battery icon shows the battery charge level, from full  to empty . When the radio has one segment left, the radio chirps periodically or after releasing  (Low Battery Alert).

#### Removing the NiMH Battery Pack (Optional Accessory)

1. Turn the radio off.
2. With the back of the radio facing you, lift the battery latch up to release the battery cover and remove the cover.
3. Remove the NiMH battery pack by pulling the ribbon attached to the radio.
4. Reposition the battery cover and press down to secure.

#### Removing the Three AA Alkaline Batteries

1. Turn the radio off.
2. With the back of the radio facing you, lift the battery latch up to release the battery cover and remove the cover.
3. Gently remove each alkaline battery by easing each battery out individually.
4. Reposition the battery cover and press down to secure.

#### Notes

- Exercise care when removing NiMH or AA batteries. Do not use sharp or conductive tools to remove either of these batteries.
- Remove the batteries before storing your radio for extended periods of time. Batteries corrode over time and may cause permanent damage to your radio.

#### Using the Battery Charger (Optional Accessory)

The battery charger provides drop-in charging convenience for NiMH batteries and can be placed on any flat surface, such as a desk or workbench. Charge the NiMH battery overnight (at least 16 hours) before using it for the first time. After the initial charge, an empty battery is fully charged within 14 hours.

1. Follow the steps above to install a NiMH Battery Pack.
2. Plug the AC power supply cord into the jack on the desk stand.
3. Plug the AC power supply into a standard wall outlet.
4. With a radio facing forward, slide it into one of the charging pockets.
5. When charging in the battery charger, the red light on the charger base will glow continuously.

#### Using the mini-USB Charging Connector

The mini-USB charging connector is a handy port that allows you to conveniently charge your NiMH battery pack. This is an alternative to charging your NiMH battery pack in the Battery Charger desk stand using the AC wall adaptor and especially useful when used while traveling.

#### Available mini-USB charging options (Optional Accessories):



1. Wall travel charger
2. Vehicle charger
3. Mini-USB computer cable

If using a computer, the computer must be turned on.

This and other accessories (sold separately) are available for your radio. For more information, visit our Web site at [www.motorola.com](http://www.motorola.com) or [shop.giantintl.com](http://shop.giantintl.com).

1. Plug your mini-USB cable or charger into a power source as is appropriate for your accessory.
2. Plug the cable into the mini-USB port on the bottom of your radio.
3. An empty battery will be fully charged in 14 hours.
4. The LED indicator light on the radio will glow to indicate that the battery is charging.

#### Notes

- The light will remain red after the NiMH battery pack is fully charged.
- When moving between hot and cold temperatures, do not charge the NiMH battery pack until the battery temperature acclimates (usually about 20 minutes).
- For optimal battery life, remove the radio from the charger within 16 hours. Do not store the radio while connected to the charger.
- If the radio is kept on while charging, the charging time will be extended.
- Even though the charger is connected, you may not be able to transmit a message if the battery is completely empty . Allow time for the battery to charge to 1 bar  before attempting to transmit a message.

#### Attaching and Removing the Belt Clip

1. Attach belt clip to pocket or belt strap.
2. Align the belt clip post with the hole in the back of the radio.
3. Gently push until the clip clicks in place.

#### To Remove



1. Push down on the release tab at the top of the belt clip to release the catch.
2. Pull the belt clip away from the back of the radio.



#### Turning your Radio On and Off

Turn  clockwise to turn the radio on and counterclockwise to turn the radio off.

1. In the ON position, the radio chirps and briefly shows all feature icons available on the radio.
2. The display screen then shows the current channel, code and all features that are enabled.

#### Setting the Volume



Press and hold  for three seconds while rotating  until you reach a comfortable listening level.

1. Rotate  clockwise to increase the volume.
2. Rotate  counterclockwise to decrease the volume.

Do not hold the radio close to your ear. If the volume is set to an uncomfortable level, it could hurt your ear.

## Talking and Listening

To communicate, all radios in your group must be set to the same channel and Interference Eliminator Code.



1. To talk, press and hold .
2. When you are finished talking, release .

For maximum clarity, hold the radio two to three inches away from your mouth and speak directly into the microphone. Do not cover the microphone while talking.

#### Talk Range



Your radio is designed to maximize performance and improve transmission range. Do not use the radios closer than five feet apart.

#### Power Boost

To boost your radio's power up to high power, press the top portion of the  button when talking. If you know your party is close by, you can conserve your battery's energy by pushing the lower part of the  button to use less power.

**Note:** If you are on an FRS only channel (see "Channels and Frequencies" tables on overleaf for details) the radio will only use low power when either portion of the  is pressed.

#### Monitor Button

Pressing and holding  for three seconds allows you to listen to the volume level of the radio when you are not receiving. This allows you to adjust the volume, if necessary. You can also press  to check for activity on the current channel before you talk.







#### Push-to-Talk Timeout Timer

To prevent accidental transmissions and save battery life, the radio emits a continuous warning tone and stops transmitting if you press  for 60 continuous seconds.

## Menu Options

#### Selecting the Channel

Your radio has 22 channels plus 8 repeater channels. The channel is the frequency the radio uses to transmit. Channels 8-14 are FRS 0.5 watt only and all other channels are GMRS. (See the "Channels and Frequencies" tables on overleaf for details.)





1. With the radio on, press . When the radio is on a 0.5 watt channel,  displays. When the radio is on a 1.5 watts channel,  displays. The current channel flashes.
2. Press  or  and select an unused or quiet channel.
3. Press  to save the channel setting or  to continue set up.



The 8 repeater channels are disabled by default. See "Enabling Repeater Channels" on overleaf for information on setting the radio to a repeater channel.

#### Selecting the Interference Eliminator Code

Interference Eliminator Codes help minimize interference by blocking transmissions from unknown sources. Your radio has 121 Interference Eliminator Codes. Codes 1 – 38 are analog tones. Codes 39 – 121 are digital codes. 0 is the off position, no analog or digital codes are enabled.

#### To set the code for a channel:

1. Press  until the code starts to flash.
2. Press  or  to select the code.
3. Press  to save the code setting or  to continue set up.

You can set a different code for each channel using this procedure. An extended press of  or  allows you to scroll through the Interference Code rapidly so you can quickly reach the code you want.







When setting codes for repeater channels 15R-22R, this code value is only used for receiving. The transmitted code can be set separately for repeater access. See "Selecting the Repeater Access (TX) Code" on overleaf for additional information.

**Note:** You must set the Interference Eliminator Code to 0 to communicate with radios that do not have Interference Eliminator Codes.

#### Setting and Transmitting Call Tones

Your radio can transmit different call tones to other radios in your group so you can alert them that you want to talk. Your radio has 10 call tones from which to choose, including 5 animal sounds and 5 regular call tones.

#### To set a call tone:

1. Press  three times until the current call tone setting flashes and  appears.
2. Press  or  to change and hear the call tone.
3. Press  to set the new call tone or  to continue set up.

To transmit your call tone to other radios set to the same channel and Interference Eliminator Code as your radio, press .

**Note:** Setting the call to 0 disables the call tone feature.

#### Hands-Free Use Without Accessories (iVOX)

You can use the iVOX feature to transmit hands-free without the need for any headset accessories. Once iVOX is turned on, the radio detects your voice and transmits when you speak into the internal microphone.



- Press ⏻ until iVOX appears on the display. The current setting On/Off will flash.
- Press ⏪ or ⏩ to select On or Off.
- Press ⏹ to set or ⏻ to continue set up.

#### Hands-Free Use With Accessories ( VOX )

You can transmit hands-free more reliably with the use of optional headset accessories. Once VOX is turned on, the radio detects your voice and transmits when you speak.

Many accessories (sold separately) are available for your radio. For more information, visit our Web site at [www.motorola.com](http://www.motorola.com) or [shop.giantintl.com](http://shop.giantintl.com).

- Turn the radio off and plug the VOX accessory into the accessory port.
- Turn the radio on. VOX shows on the display.
- Adjust the volume appropriately by rotating ⏮. Lower the volume before placing the accessory on your head or in your ear.
- To turn off, simply remove accessory.

**Note:** There is a short delay between the time you start talking and when the radio transmits. There is a short delay before the transmission is completed.

#### Setting the Sensitivity Level When in VOX Mode

Adjusting the radio’s sensitivity level helps minimize the possibility of unintended noises triggering a transmission and helps the radio pick up soft voices.

- Press ⏻ until VOX and the level setting (1 - 3) appear on the display.
- Press ⏪ or ⏩ to select the sensitivity level.
- Press ⏹ to set or ⏻ to continue set up.

<b>3 = High Sensitivity</b> for quiet environments
<b>2 = Medium Sensitivity</b> for most environments
<b>1 = Low Sensitivity</b> for noisy environments

**Note:** When you connect a headset, the radio is automatically set to the last chosen sensitivity level.

#### Q<sub>1</sub> Noise Filtering

The Q<sub>1</sub> noise-filtering feature helps to ensure uninterrupted communication with other Motorola radios that have this feature. This feature also filters out unwanted transmissions from other radios. This is useful in places where there is heavy radio traffic, such as amusement parks or ski resorts.

**Note:** Q<sub>1</sub> noise filtering is not available when the radio is scanning.

*To turn Q<sub>1</sub> noise filtering on or off:*

- Press ⏻ until Q<sub>1</sub> displays. The current setting On/Off will flash.
- Press ⏪ or ⏩ to turn noise filtering On or Off.
- Press ⏹ to confirm your selection or ⏻ to continue set up.

*To transmit to a radio that has Q<sub>1</sub> noise filtering turned on:*

- Select the same channel and Interference Eliminator Code as the other radio.
- Press ⏮ to send a call tone. This allows your voice to pass through the Q<sub>1</sub> noise filter on the receiving radio.
- Press ⏹ and speak normally.

**Note:** If you skip step 2, the beginning of your message may not be heard on the receiving radio. For a 30-second period, starting after the last transmission, all transmissions received on the selected channel and code will pass through the Q<sub>1</sub> noise filter.

#### VibraCall™ Alert

VibraCall™ is a vibrating alert that notifies you that your radio is receiving a message. This is useful in noisy environments. When the alert is on, the radio vibrates once every 30 seconds when you receive a message on the channel and code you set.

- To turn vibrating alerts on, press ⏻ until 🔔 is displayed. The current setting will flash.
- Press ⏪ or ⏩ to change the setting to On/Off.
- Press ⏹ to set or ⏻ to continue set up.

#### Keypad Tones

You may enable or disable the speaker key tones. You will hear the key tone each time a button is pushed.

- Press ⏻ until 🔊 appears. The current setting On/Off will flash.
- Press either ⏪ or ⏩ to turn On or Off.
- Press ⏹ to confirm or ⏻ to continue set up.

**Note:** When the key tone feature is off, the following are not disabled:

- Transmit timeout alert tone
- Call tone
- Low battery alert tone or
- The transmitted talk confirmation tone

#### Transmitting a Talk Confirmation Tone

You can set your radio to transmit a unique tone when you finish transmitting. It is like saying “Roger” or “Over” to let others know you are finished talking. Talk Confirmation Tone is disabled in repeater mode on channels 15R-22R.

- With the radio on, press ⏻ until the 🔊 appears. The current setting On/Off flashes.

- Press ⏪ or ⏩ to turn On or Off.
- Press ⏹ to set or ⏻ to continue setup.

#### Enabling Repeater Channels

Use of a repeater can greatly increase the radio range and coverage area. Repeater use must be coordinated with the owner of the repeater. Be sure to understand and follow the sharing and usage rules for each repeater system.

- With the radio on, press ⏻ until the **R** appears. The current setting ON/OFF will flash.
- Press ⏪ or ⏩ to select ON or OFF.
- Press ⏹ to save the setting or ⏻ to continue set up.

After enabling the repeater channels, you will be able to select channels 15R-22R. Refer to the “Selecting the Channel” section on page one.

#### Selecting the Repeater Access (TX) Code

When a repeater channel is selected, an additional menu option is available for setting the transmitted Interference Eliminator Code. Many repeaters will require a specific value setting to activate the repeater on your transmissions. See the table “**INTERFERENCE ELIMINATOR TONE / CODE VALUES**” for detailed information.

- With the radio on, press ⏻ repeatedly until the 🔔, the **R**, and the current setting flash.
- Press ⏪ or ⏩ to select the code.
- Press ⏹ or ⏻ to exit menu mode.

You can set a different code for each channel using this procedure. An extended press of ⏪ or ⏩ allows you to scroll through the Interference Code rapidly so you can quickly reach the code you want. 0 is the off position.

## Special Features

#### Emergency Alert Mode

The Emergency Alert feature can be used to signal members in your group of your need for urgent help. MR series radios will operate in an automatic “hands-free” emergency control mode for a total of 30 seconds after activating the Emergency Alert. MR series radios in your group will automatically advance the speaker volume to the maximum setting and sound a warbling alert tone for 8 seconds. The alert tone is emitted from your own radio speaker and the receiving radios in your group. After the 8 second alert, any spoken words or incidental sounds at your end will be transmitted to the group for 22 seconds. For the 30 second duration of Emergency Alert mode, MR series radio controls and buttons will be locked to maximize reception of the emergency message.

- Press and hold the Emergency Alert button for 3 seconds.
- Release the button after the LED Indicator glows red and the alert tone begins to sound. There is no need to continue to hold the Emergency Alert button or use PTT for your message to be transmitted.
- After the alert tone ends you may speak into the microphone. Your voice or incidental sounds will be transmitted. The LED indicator will continue to glow for the duration of the 22 second period.
- After 30 seconds your radio speaker will emit a Talk Confirmation Tone and the LED Indicator will extinguish. Operation then returns to normal two-way mode.

**Note:** All Motorola Talkabout EM, MJ, and MR series radios are fully compatible with the Emergency Alert feature. Radios other than EM, MJ, MR series can receive the emergency alert signal, but will not respond with adjusted volume settings, locked controls, or a warbling alert tone. Users of other radio models set to the same channel and Interference Eliminator Code will hear a steady tone for 8 seconds followed by the voice transmission for 22 seconds.

**Warning:** The Emergency Alert feature should only be used in the event of an actual emergency. Motorola is not responsible if there is no response to the emergency alert from the receiving group.

#### Built-in Flashlight

Press and hold the flashlight button to turn and keep the light on. The switch functions as a momentary control for the light.

**Note:** Turn off the flashlight when not in use to conserve battery power.

#### Keypad Lock

*To avoid accidentally changing your radio settings:*

- Press and hold ⏻ until 🔒 displays.
- When in lock mode, you can turn the radio on and off, adjust the volume, receive, transmit, send a call tone, and monitor channels. All other functions are locked.

To unlock the radio, press and hold ⏻ until 🔒 is no longer displayed.

#### Scanning Channels

Use scan to search the 22 channels for transmissions from unknown parties, to find someone in your group who has accidentally changed channels, or to quickly find unused channels for your own use.

There is a priority feature and 2 modes of scanning (basic and advanced) to make your search more effective. The basic scan mode uses the channel and code combinations for each of the 22 channels as you have set them (or with the default code value of 1). The “Advanced Scan” mode will scan all channels for any and all codes, detect any code in use, and use that code value temporarily for that channel.

Priority is given to the “home channel,” that is, the channel (and Interference Eliminator Code) your radio is set to when you start the scan. This means the initial channel (and code setting) is scanned more often than the other 21 channels, and your radio will respond quickly to any activity occurring on the home channel as a priority.

*To start Scanning:*

- Briefly press the 🔍 key. The scan 🔍 will appear in the display, and the radio will begin to scroll through the channel and code combinations.

- When the radio detects channel activity matching the channel and code combination, it stops scrolling and you can hear the transmission.
- To respond and talk to the person transmitting, press ⏹ within five seconds after the end of the transmission.
- The radio will resume scrolling through the channels five seconds after the end of any received activity.
- To stop scanning, briefly press the ⏻ key.

*To start Advanced Scanning:*

- Set the Interference Eliminator Code to “zero” or OFF.
- Briefly press the 🔍 key. The scan 🔍 will appear in the display, and the radio will begin to scroll through the channels. No Interference Eliminator Codes will filter what is heard.
- When the radio detects channel activity with ANY code (or NO code), it stops scrolling and you can hear the transmission. Any Interference Eliminator Code that may be in use by that party will be detected and displayed.

- To respond and talk to the person transmitting, press ⏹ within five seconds of the end of the transmission. The radio will transmit using the newly detected Interference Eliminator Code.
- The radio will resume scrolling through the channels five seconds after the end of any received activity.
- To stop scanning, briefly press the 🔍 key.

#### Scanning Notes:

- If you press ⏹ while the radio is scrolling through inactive channels, the transmission will be on the “home channel”. Scanning will resume five seconds after the end of your transmission. You may press the 🔍 key to stop scanning at any time.
- If the radio stops on an undesired transmission, you may immediately resume the scan by briefly pressing ⏪ or ⏩.
- If the radio repeatedly stops on an undesired transmission, you may temporarily remove that channel from the scan list by pressing and holding ⏪ or ⏩ for three seconds. You may remove more than one channel in this way.
- To restore the removed channel(s) to the scan list, turn the radio off and then back on, or exit and re-enter the scanning mode by pressing 🔍.
- You cannot remove the home channel from the scan list.
- In Advanced Scan, the detected code will only be used for one transmission. You must note the code, exit scan, and set that detected code on that channel to permanently use the detected code.

## Weather Receiver

Your radio can tune in to broadcasts by the United States National Oceanic and Atmospheric Administration (NOAA) Weather Radio.

You can listen to a weather channel (see “Weather Channels and Frequencies” table for details) or set your radio to alert you to emergency weather broadcasts that interrupt routine broadcasts. When you listen to a weather channel, you cannot use your radio in scan mode or for two-way communications.

NOAA has transmitters located throughout the United States. These transmitters broadcast watches, forecasts, and other information 24 hours a day.

**Note:** NOAA weather radio stations are assigned to cover specific areas and service may be limited. Please check with your local weather office for frequency and details, or visit [www.weather.gov/nwr](http://www.weather.gov/nwr) in the US to view the appropriate transmitter for your area.

The use of the NOAA logo does not provide an endorsement or implied endorsement by NOAA’s National Weather Service.

#### Turning Weather Channel Reception On and Off

- To turn weather reception on, press ⏪ and hold for 3 seconds.
- To turn off, press ⏪ or turn the radio off and then back on.

#### Setting the Weather Channel

Your radio receives weather frequencies:

- After turning weather reception on, press ⏻. The current channel flashes.
- Press ⏪ or ⏩ to select the appropriate channel with good reception in your area.
- Press ⏹ to save the weather channel setting.

#### Setting the Weather Alert

Your radio can be set to respond to NOAA Weather Radio emergency messages. A special alarm tone sounds an alert and turns on the weather receiver to give you immediate weather and emergency information.

- After turning weather reception on, press ⏻ twice. On/Off displays.
- Press ⏪ or ⏩ to select On/Off. If you activate Weather Alert and return to two-way mode, 🔔 will display.
- Press ⏹ to save the Weather Alert setting.
- Press ⏪ to return to two-way mode.

As with two-way radio reception, weather channel reception depends on how close you are to a transmitter and whether you are indoors or outdoors. Because weather channels are transmitted without codes, they may contain static or noise. Weather Alert will not function while actively transmitting or receiving in two-way mode.

FRS / GMRS SIMPLEX CHANNELS AND FREQUENCIES					
CHANNEL	FREQ (MHz)	TYPE	CHANNEL	FREQ (MHz)	TYPE
1	462.5625	GMRS/FRS	12	467.6625	FRS
2	462.5875	GMRS/FRS	13	467.6875	FRS
3	462.6125	GMRS/FRS	14	467.7125	FRS
4	462.6375	GMRS/FRS	15	462.5500	GMRS
5	462.6625	GMRS/FRS	16	462.5750	GMRS
6	462.6875	GMRS/FRS	17	462.6000	GMRS
7	462.7125	GMRS/FRS	18	462.6250	GMRS
8	467.5625	FRS	19	462.6500	GMRS
9	467.5875	FRS	20	462.6750	GMRS
10	467.6125	FRS	21	462.7000	GMRS
11	467.6375	FRS	22	462.7250	GMRS

GMRS DUPLEX REPEATER CHANNEL FREQUENCIES					
CHANNEL	RX (MHz)	TX (MHz)	CHANNEL	RX (MHz)	TX (MHz)
15R	462.5500	467.5500	19R	462.6500	467.6500
16R	462.5750	467.5750	20R	462.6750	467.6750
17R	462.6000	467.6000	21R	462.7000	467.7000
18R	462.6250	467.6250	22R	462.7250	467.7250

WEATHER CHANNELS AND FREQUENCIES					
CHANNEL	RX (MHz)	CHANNEL	RX (MHz)	CHANNEL	RX (MHz)
WX1	162.550	WX5	162.450	WX9	161.775
WX2	162.400	WX6	162.500	WX10	161.750
WX3	162.475	WX7	162.525	WX11	162.000
WX4	162.425	WX8	161.650		

INTERFERENCE ELIMINATOR TONE / CODE VALUES					
CODE	(Hz)	CODE	(CTAL)	CODE	(CTAL)
1	67.0	39	023	81	315
2	71.9	40	025	82	331
3	74.4	41	026	83	343
4	77.0	42	031	84	346
5	79.7	43	032	85	351
6	82.5	44	043	86	364
7	85.4	45	047	87	365
8	88.5	46	051	88	371
9	91.5	47	054	89	411
10	94.8	48	065	90	412
11	97.4	49	071	91	413
12	100.0	50	072	92	423
13	103.5	51	073	93	431
14	107.2	52	074	94	432
15	110.9	53	114	95	445
16	114.8	54	115	96	464
17	118.8	55	116	97	465
18	123.0	56	125	98	466
19	127.3	57	131	99	503
20	131.8	58	132	100	506
21	136.5	59	134	101	516
22	141.3	60	143	102	532
23	146.2	61	152	103	546
24	151.4	62	155	104	565
25	156.7	63	156	105	606
26	162.2	64	162	106	612
27	167.9	65	165	107	624
28	173.8	66	172	108	627
29	179.9	67	174	109	631
30	186.2	68	205	110	632
31	192.8	69	223	111	654
32	203.5	70	226	112	662
33	210.7	71	243	113	664
34	218.1	72	244	114	703
35	225.7	73	245	115	712
36	233.6	74	251	116	723
37	241.8	75	261	117	731
38	250.3	76	263	118	732
		77	265	119	734
		78	271	120	743
		79	306	121	754
		80	311		

INTERFERENCE ELIMINATOR TONE / CODE VALUES					
CODE	(Hz)	CODE	(CTAL)	CODE	(CTAL)
1	67.0	39	023	81	315
2	71.9	40	025	82	331
3	74.4	41	026	83	343
4	77.0	42	031	84	346
5	79.7	43	032	85	351
6	82.5	44	043	86	364
7	85.4	45	047	87	365
8	88.5	46	051	88	371
9	91.5	47	054	89	411
10	94.8	48	065	90	412
11	97.4	49	071	91	413
12	100.0	50	072	92	423
13	103.5	51	073	93	431
14	107.2	52	074	94	432
15	110.9	53	114	95	445
16	114.8	54	115	96	464
17	118.8	55	116	97	465
18	123.0	56	125	98	466
19	127.3	57	131	99	503
20	131.8	58	132	100	506
21	136.5	59	134	101	516
22	141.3	60	143	102	532
23	146.2	61	152	103	546
24	151.4	62	155	104	565
25	156.7	63	156	105	606
26	162.2	64	162	106	612
27	167.9	65	165	107	624
28	173.8	66	172	108	627
29	179.9	67	174	109	631
30	186.2	68			

## Free Manuals Download Website

<http://myh66.com>

<http://usermanuals.us>

<http://www.somanuals.com>

<http://www.4manuals.cc>

<http://www.manual-lib.com>

<http://www.404manual.com>

<http://www.luxmanual.com>

<http://aubethermostatmanual.com>

Golf course search by state

<http://golfingnear.com>

Email search by domain

<http://emailbydomain.com>

Auto manuals search

<http://auto.somanuals.com>

TV manuals search

<http://tv.somanuals.com>