



NINTENDO 3DS™ XL

# Operations Manual

Preparations

Using Software

Adjusting System Settings

Troubleshooting

6204846M



**Nintendo of Europe GmbH**  
Nintendo Center, 63760 Großostheim  
[www.nintendo-europe.com](http://www.nintendo-europe.com)

**UK and Ireland:**  
Nintendo UK  
PO Box 952, Portsmouth, PO6 9DY  
[www.nintendo.co.uk](http://www.nintendo.co.uk)



PRINTED IN CHINA

Please read this Operations Manual, including the Health and Safety Information section (pages 12 to 21), before use and follow all the instructions carefully. If this product is to be used by young children, this manual should be read and explained to them by an adult. Please keep this manual for future reference.

**Note:** See page 4 for a complete list of items included with the system.

*This seal is your assurance that Nintendo has reviewed this product and that it has met our standards for excellence in workmanship, reliability and entertainment value. Always look for this seal when buying games and accessories to ensure complete compatibility with your Nintendo Product.*



Thank you for selecting the Nintendo 3DS™ XL system.

Please note that Nintendo may amend or update the manual included with this product from time to time. Nintendo therefore recommends checking for the latest version of this manual on your local Nintendo website in the support section for this product. Please note this service may not be available in some countries.

Thank you for purchasing the Nintendo 3DS™ XL system. Please read this Operations Manual before use, paying careful attention to the Health and Safety Information section on pages 12 – 21, and follow all the instructions carefully. **If this product is to be used by young children, this manual should be read and explained to them by an adult.** Please keep this manual for future reference.

**Note:** In this manual, the term "Nintendo DSi™ system" also refers to the Nintendo DSi™ XL system.

## Set Contents

Before using this system, ensure that the contents listed below are all present.

- Nintendo 3DS XL system x 1**  
(SPR-001(EUR))



- Nintendo 3DS XL stylus x 1**  
(SPR-004)

**Note:** The stylus is located in the stylus holder on the side of the system (page 25).



- SDHC Memory Card (4GB) x 1**

**Note:** The SDHC Card is inserted in the SD Card slot (page 34).  
The SDHC Card is a third-party accessory not manufactured by Nintendo.



- AR Cards x 6**

**Note:** These are used in conjunction with the built-in application, AR Games: Augmented Reality (page 65).



- Quick-Start Guide x 1**

- Nintendo 3DS XL Operations Manual x 1**

- Parental Controls Leaflet x 1**



### This package does not include an AC adapter.

To recharge your system, you will need a Nintendo 3DS AC adapter (WAP-002(UKV) / WAP-002(EUR)) (sold separately).

You can also use the AC adapter included with the Nintendo 3DS™, Nintendo DSi and Nintendo DSi XL systems.

AC adapter included with Nintendo 3DS / Nintendo DSi / Nintendo DSi XL



AC adapter included with Nintendo DS™ / Nintendo DS™ Lite



# NINTENDO 3DS™ XL

Here is what you can do with your Nintendo 3DS XL system!



The use of the 3D feature by children aged six and under may cause vision damage. Therefore it is recommended that:

- Only children over six should use the system in 3D mode.
- If children aged six and under have access to the system, parents or legal guardians should restrict the display of 3D images using the Parental Controls feature (page 78).

Enjoy games in vivid 3D (page 32).



Note: 3D content will only be displayed on Nintendo 3DS software titles. Nintendo DS / Nintendo DSi software titles cannot display 3D content.

Take 3D photos and videos using the two outer cameras (page 58).



Use software from other systems in the Nintendo DS family (page 44).



Nintendo 3DS software



Nintendo DS / Nintendo DSi software

The following software comes pre-installed on the system.



Nintendo 3DS Camera

Take 3D photos and videos using this application. Page 58



Nintendo eShop

View information and videos about various software, and download new software. Page 64



Nintendo 3DS Sound

Listen to music and record sounds. Page 61



AR GAMES  
Augmented Reality

Use the AR Cards that come with the system together with the outer cameras to create believable augmented reality games. Page 65



Mii MAKER

Make yourself and other people into Mii™ characters! Page 62



FACE RAIDERS

A shooting game that turns your face, or the faces of your friends, into the enemies! Page 66



StreetPass  
Mii PLAZA

Mii characters you meet through StreetPass will appear here. Page 63



Activity Log

Record the number of steps you take while carrying your Nintendo 3DS XL system and the length of time you spend using software. Page 67

The downloadable title Nintendo Letter Box is pre-installed on the SDHC Card.



Exchange handwritten letters with registered friends (page 49) using SpotPass and StreetPass functionality.

Note:

- For detailed information on this software, refer to its electronic manual (page 40).
- For more information on downloadable software, see page 47.

There may also be other downloadable content pre-installed on the SDHC Card. Such content will appear as extra icons on the HOME Menu, and can be accessed by selecting these icons.

Note: If you delete Nintendo Letter Box or other pre-installed downloadable content, they can be redownloaded from Nintendo eShop. (There are certain cases where software may be temporarily or permanently withdrawn from Nintendo eShop. Should this happen, you will no longer be able to redownload that software.)

Your Nintendo 3DS XL system will automatically search for wireless access points and connect to the internet and exchange data at various times, including while in Sleep Mode (when the system is closed but the power is on).

**Note:** Data received via SpotPass is saved to the SD Card.



You must configure Internet Settings to be able to connect to wireless access points (page 70).

**Note:**

- Data cannot be transmitted if the power or wireless functions are off (page 22).
- SpotPass functionality may not be available if an active software title is using certain features or functionality.
- SpotPass functionality is not available during local wireless communication (page 37) or while playing Nintendo DS / Nintendo DSi software.
- Depending on the type of data received, the notification LED may not light up.

**The Nintendo 3DS XL Charging Cradle (SPR-007) (sold separately) can help make recharging more convenient.**

If the system is attached to the charging cradle when not in use, the battery won't lose power during Sleep Mode.

**Note:** For information about battery life, see page 31.

**Note:** The illustration above shows the UK version of the AC adapter.

Your Nintendo 3DS XL system automatically searches for and exchanges data with other Nintendo 3DS / Nintendo 3DS XL systems when you carry it around, such as when you're out walking or when you travel by train.

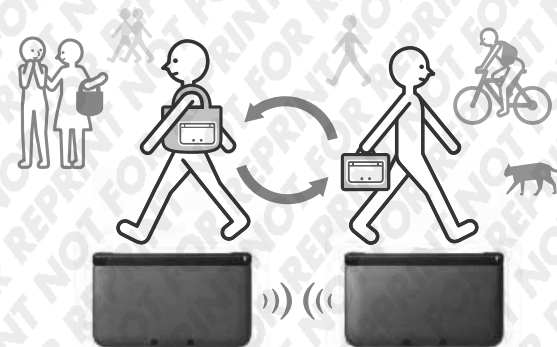

Data will automatically be exchanged if you walk past someone who has the same software title registered with StreetPass while the system is in Sleep Mode (closed while the power is on), as well as at other times.

**Successful StreetPass exchange**



Your StreetPass settings are saved on the Nintendo 3DS XL.

**Note:**

- A maximum of 12 software titles can use StreetPass at any one time.
- Contact Mode settings for Nintendo DS / Nintendo DSi software titles are not saved and must be configured while playing compatible titles. Furthermore, it is not possible to exchange StreetPass data for Nintendo 3DS software titles while Nintendo DS / Nintendo DSi software titles are in use.
- Data cannot be transmitted if the power or wireless functions are off (page 22).
- StreetPass functionality may not be available if an active software title is using certain features or functionality. StreetPass functionality is not available during local wireless communication (page 37) or when connected to the internet.

# Contents

• Set Contents	4
• Health and Safety Information (Please read)	12

## Preparations

Component Names and Functions	22
Using the Touch Screen	25
Touch Screen Controls	25
Recharging	26
How to Recharge your Nintendo 3DS XL System	27
Turning the power on and off	28
Configuring the System for the First Time	28
Using the Keyboards	30
Power LED	31
Battery Life	31
Adjusting 3D Images	32
How to View 3D Images Properly	32
Adjusting the Strength of 3D Images	33
Using SD Cards	34
If Your SD Card is Full...	35

## Using Software

HOME Menu	36
Software Icons	38
Opening Software	39
Electronic Manuals	40
Adjusting Brightness / Power-Saving Mode	40
Taking Photos	41
Creating Folders on the HOME Menu	42

Card-Based Software	44
Using Game Cards	45

Download Software	47
Opening Software	47

Game Notes	48
------------	----

Friend list	49
Friend List	49
Friend Registration	50
Editing your Friend Card / Viewing Friend Cards	51
Communicating with Friends	52
Friend List Settings	53

Notifications	54
Receiving Notifications	54
Viewing Notifications	55
Stopping Notifications	55

Internet Browser	56
Using the Browser	57

Nintendo 3DS Camera	58
Taking Photos and Videos	58
Viewing Photos and Videos	60

Nintendo 3DS Sound	61
--------------------	----

Mii Maker	62
-----------	----

StreetPass Mii Plaza	63
----------------------	----

Nintendo eShop	64
----------------	----

AR Games: Augmented Reality	65
-----------------------------	----

Face Raiders	66
--------------	----

Activity Log	67
--------------	----

Download Play	68
---------------	----

## Adjusting System Settings

System Settings	69
-----------------	----

Internet Settings	70
Required Items for Internet Connection	71
Connecting to the Internet	72
SpotPass Settings	76
Nintendo DS Connections	77
If an Error Code Appears	77

Parental Controls	78
Options That Can Be Restricted	78
Configuring Parental Controls	79
Removing Parental Controls Restrictions	80

Data Management	82
-----------------	----

Other Settings	83
Outer Cameras	84
System Transfer	86
System Update	91
Format System Memory	91

## Troubleshooting

Replacing the Nintendo 3DS XL Battery Pack	92
--	----

Troubleshooting	94
-----------------	----

• Technical Specifications	104
----------------------------	-----

• Index	106
---------	-----

• Contact Information	109
-----------------------	-----

## Health and Safety Information (Please read)

Be sure to observe the following Health and Safety Information carefully during use of the product. Failure to do so could result in accidents and / or injury.

### ■ The use of this product by children

IF THIS PRODUCT IS TO BE USED BY YOUNG CHILDREN, THIS MANUAL SHOULD BE READ AND EXPLAINED TO THEM BY AN ADULT OR LEGAL GUARDIAN. PARENTS OR LEGAL GUARDIANS SHOULD MONITOR CHILDREN WHEN PLAYING VIDEO GAMES. YOUNG CHILDREN SHOULD BE SUPERVISED AND ASSISTED WHILE PLAYING.

**WARNING – 3D Feature Not Suitable for Children aged six and under**  
Please refer to the warning regarding the 3D feature (page 13).

### ■ If the system doesn't operate properly

If you suspect your system isn't functioning as it should, refer to the Troubleshooting section on pages 94 – 102.

If you notice any damage to the system, or any unusual sounds, smells or smoke emanating from it, please do the following:



**Press and hold the POWER Button to turn off the power**

**Note:** Touching the product in this state could be dangerous, so be careful when pressing the POWER Button.



**Remove the AC adapter and any other accessories**

**Note:** Be sure to remove the AC adapter plug from the plug socket before detaching the DC connector plug from the system.



**Contact Nintendo Customer Support (pages 109 – 111)**

**Note:** Do not attempt to repair the system yourself. To do so could cause injury.

### Guide to Warning Levels

The following warnings indicate the severity of the consequences, should you fail to observe the correct procedures.



#### WARNING

Failing to observe the precautionary steps could result in death or serious personal injury (or damage to property).



#### CAUTION

Failing to observe the precautionary steps could result in personal injury (or damage to property).

#### CAREFUL USAGE

Failing to use the product properly could result in damage to property.

The following symbols appear inside warnings:

#### Prohibition Symbols



Prohibited



Disassembly prohibited



Handling prohibited

#### Instructional Symbol



Information

## Health and Safety Information

Be sure to observe the following to ensure your well-being during the use of this product.



### WARNING – USING 3D FEATURE



- The use of the 3D feature by children aged six and under may cause vision damage. Therefore it is recommended that only children over six should use the system in 3D mode and if children aged six and under have access to the system, parents or legal guardians should restrict the display of 3D images using the Parental Controls feature (page 78).
- If there is any difference in vision between your left and right eyes, or if you tend to see using only one eye, you may have difficulty in seeing 3D images clearly, or your eyes may become tired. Observe careful usage and take a break of 10 to 15 minutes every half hour. If you experience any of the symptoms listed below, adjust the 3D effects to a comfortable level or set the display to only use 2D images.
- Do not view unclear 3D images for extended periods of time. Prolonged viewing of unclear 3D images, such as double images, can lead to eye strain, dryness of the eyes, headaches, stiff shoulders, nausea, dizziness, motion sickness, fatigue and / or discomfort.
- Everyone has a different way of viewing 3D images. For information on how to view 3D images properly, please refer to the relevant pages of the Operations Manual. If you experience any of the symptoms above, adjust the 3D effects to a comfortable level or set the display to use only 2D images. Depending on your physical condition and your surrounding environment, you may be unable to see 3D images properly. If this is the case, disable the 3D feature.
- Please refrain from using the 3D feature while travelling as a passenger in cars or on public transport. Constant shaking can lead to 3D images becoming unclear, causing nausea and eye strain.

### ■ Be sure to observe the following to ensure your well-being during the use of this product:

- Do not attempt to use this system if you are feeling tired or unwell. Depending on your physical condition, doing so can lead to fatigue and discomfort.
- If you experience fatigue or discomfort in your eyes, head, shoulders or anywhere else, stop playing immediately and take a break. If the symptoms persist, set the display to only use 2D images.
- Avoid excessively long play sessions. Take a break of 10 to 15 minutes every half hour when using the 3D feature, or every hour when not using the 3D feature, even if you don't think you need it.



### WARNING – SEIZURES



- Some people (about 1 in 4000) may have seizures or blackouts triggered by light flashes or patterns, and this may occur while they are watching TV or playing video games, even if they have never had a seizure before.
- Anyone who has ever experienced seizures, loss of awareness or any other symptom linked to an epileptic condition should consult a doctor before playing video games.
- Parents or legal guardians should monitor children when they play video games. Stop play and consult a doctor if you or your child have any unusual symptoms, such as:

**Convulsions**  
Altered vision

**Eye or muscle twitching**  
Involuntary movements

**Loss of awareness**  
Disorientation

### ■ To reduce the likelihood of a seizure when playing video games, follow these precautions:

1. Do not play if you are tired or need sleep.
2. Play in a well-lit room.
3. Take a break of 10 to 15 minutes every hour (every half hour when using the 3D feature).

**WARNING – EYE STRAIN AND MOTION SICKNESS**

- Playing video games can make your eyes hurt after a sustained period of time, and perhaps sooner if using the 3D feature. Playing video games can also cause motion sickness in some players. Follow these instructions to avoid eye strain, dizziness or nausea:
- Avoid excessively long play sessions. Parents or legal guardians should monitor their children for appropriate play.
  - Take a break of 10 to 15 minutes every half hour when using the 3D feature, or every hour when not using the 3D feature, even if you don't think you need it.
  - If your eyes become tired or sore while playing, or if you feel dizzy or nauseated, stop and rest for several hours before playing again.
  - If you continue to have any of the above symptoms or other discomfort during or after play, stop playing and see a doctor.

**WARNING – REPETITIVE MOTION INJURIES**

- Playing video games can make your muscles, joints or skin hurt after a few hours. Follow these instructions to avoid problems such as tendonitis, carpal tunnel syndrome or skin irritation:
- Avoid excessively long play sessions. Parents or legal guardians should monitor their children for appropriate play.
  - Take a break of 10 to 15 minutes every hour (every half hour when using the 3D feature), even if you don't think you need it.
  - When using the stylus, you do not need to grip it tightly or press it hard against the screen. Doing so may cause fatigue or discomfort.
  - If your hands, wrists, or arms become tired or sore while playing, or if you feel symptoms such as **tingling, numbness, burning or stiffness**, stop and rest them for several hours before playing again.
  - If you continue to have any of the above symptoms or other discomfort during or after play, stop playing and see a doctor.

**WARNING – BATTERY LEAKAGE**

- The Nintendo 3DS XL system contains a rechargeable lithium ion battery pack. Leakage or combustion of the battery pack can cause personal injury as well as damage to your Nintendo 3DS XL system.

**To avoid battery leakage and / or combustion:**

- Do not damage the battery.
- Do not expose the battery to excessive physical shock, vibration, or liquids.
- Do not disassemble, deform or attempt to repair the battery.
- Do not expose the battery to heat or dispose of it in a fire.
- Do not touch the terminals of the battery or cause a short circuit between the terminals with a metal object.
- Do not peel or damage the battery label.
- Use a compatible AC adapter.
- The battery pack of the Nintendo 3DS XL system is only to be recharged under adult supervision.
- The battery is to be removed from the Nintendo 3DS XL system before disposing of the unit.

If the battery pack leaks, do not touch it. To ensure any leaked fluid on the system doesn't come into contact with your hands, wipe the exterior of the system thoroughly with a soft, slightly damp cloth. If the leaked fluid comes into contact with your hands or any other part of your body, rinse it away with water. If liquid leaking from a battery pack comes into contact with your eyes, it can cause injury. Immediately rinse your eyes with plenty of water and consult a doctor.

**WARNING – RADIO FREQUENCY INTERFERENCE**

- The Nintendo 3DS XL system can emit radio waves that can affect the operation of nearby electronics, including cardiac pacemakers.
- Do not operate the Nintendo 3DS XL system within 25 centimetres (10 inches) of a pacemaker while using wireless communication. If you have a pacemaker or other implanted medical device, do not use wireless communication without first consulting your doctor or the manufacturer of your medical device.

**Important Safety Information for use of Nintendo 3DS XL on board aeroplanes, in hospitals and airports**

- Operation of the Nintendo 3DS XL system with wireless communication NOT active may be allowed on board aeroplanes, in hospitals, and in airports as with any other non-wireless device.
- You will know when wireless communication is active on your Nintendo 3DS XL system when the yellow wireless LED is lit, to indicate that communication is enabled, or is blinking, to indicate that wireless communication is in progress. The wireless LED will blink when you are using in-game multiplayer features or transferring a game / feature to / from another unit. Observe and follow all regulations and rules regarding the use of wireless devices in locations such as hospitals, airports, or on board an aeroplane.
- In order to comply with airline regulations, do not use wireless communication functions while on board an aeroplane. Operation in these locations may interfere with or cause malfunctions of equipment, with resulting injuries to persons or damage to property.

**IMPORTANT:** The Nintendo 3DS XL system allows you to disable wireless communication for all system features. To enable / disable wireless communication, use the wireless switch on the system.

**WARNING – WIRELESS COMMUNICATION**

- The Nintendo 3DS XL system offers various applications allowing your Nintendo 3DS XL system to communicate using wireless communication. You can disable wireless communication by using the wireless switch of the Nintendo 3DS XL system.

**IMPORTANT:** The Nintendo 3DS XL system may automatically connect to the internet when wireless communication is enabled. If you want to avoid such connection, please disable all wireless communication by using the wireless switch of the Nintendo 3DS XL system. A broadband internet connection and a wireless access point or a Nintendo Wi-Fi USB Connector are required in order to enjoy certain Nintendo 3DS Services. You are responsible for any internet connection fees. We therefore recommend you make sure that you have high-speed internet access, with no restrictions on usage and downloading time, before using such services in order to avoid additional internet charges being incurred when using such services. The Nintendo 3DS Services are not available in all countries; visit <http://3dservices.nintendo-europe.com> for details. The Nintendo 3DS Services are governed by the Nintendo 3DS Service User Agreement and Privacy Policy. For more details please visit <http://3dservices.nintendo-europe.com>.

**Keep the following in mind regarding the use of wireless communication:**



- If you post, send or otherwise make available any information or content through wireless communication please make sure not to include any information that can be used to identify you personally, such as your name, email address, your address or your telephone number, as others may be allowed to see such information and content. In particular, when choosing a user name or nickname for your Mii characters, please do not use your real name as others may be able to view your user name and the nicknames of your Mii characters when using wireless communication.
- Friend codes and friend cards are a part of a system that allows you to establish a friendship with other users, so that you can play, communicate and interact with people you know. If you exchange friend codes or friend cards with strangers, there is a risk that you could receive information or messages with offensive language or inappropriate content and that strangers may see information about you that you do not want strangers to see. We therefore recommend that you do not give your friend codes to people you don't know and that you do not share friend cards with people you don't know.
- Do not engage in harmful, illegal, offensive or otherwise inappropriate activity that might cause problems for other users. In particular, do not post, send or otherwise make available any information or content that threatens, abuses or harasses other persons, infringes on the rights of others (such as copyrights, portrait rights, privacy rights, rights of publicity or trademarks) or that may make other people feel uncomfortable. In particular, when sending, posting or making available photos, images or videos displaying other people, make sure to obtain their permission beforehand. If inappropriate content is reported or confirmed, you may be subject to penalties such as being banned from the Nintendo 3DS Services.

As far as Nintendo servers are involved in any wireless communication, please note that Nintendo servers may become temporarily unavailable without prior notice due to maintenance following any problems.



Please read the following carefully to ensure the correct use of this product.

## WARNING

-  **Do not disassemble or try to repair the system**
-  **Do not expose the battery to heat or dispose of it in a fire**
-  **Do not expose the system to heat sources such as heaters or stoves, and try not to expose the system to direct sunlight for extended periods of time**  
Failure to observe this precaution could result in the battery pack leaking, combusting or exploding, which can in turn lead to fire and / or electrocution. Also, certain degrees of heat can lead to the battery pack becoming deformed or damaged.

-  **Use a compatible AC adapter and battery pack**  
Using an incompatible AC adapter or battery pack can lead to battery leakage, combustion or explosion, which can in turn lead to fire and / or electrocution.  
Use the Nintendo 3DS XL Battery Pack (SPR-003) and Nintendo 3DS AC adapter (WAP-002(UK)/WAP-002(EUR)) (sold separately) only.









-  **Do not touch the terminals of the battery with any foreign materials or metal objects, and do not damage the battery pack**  
Doing so can lead to combustion, explosions, electrocution and / or short-circuits.  
Do not use the system with travel transformers, incandescent-specific light dimmers, or in-car AC / DC adapters or chargers.



-  **Use the AC adapter and battery pack only with compatible systems**  
Using the AC adapter and / or battery pack with an incompatible unit can cause fire, battery leakage, combustion, explosion or electric shocks.
  - The Nintendo 3DS XL Battery Pack (SPR-003) is for use with the Nintendo 3DS XL system only.
  - The Nintendo 3DS AC adapter (WAP-002(UK)/WAP-002(EUR)) (sold separately) can be used with the following:
    - Nintendo 3DS (CTR-001(EUR))
    - Nintendo 3DS XL (SPR-001(EUR))
    - Nintendo DSi (TWL-001(EUR))
    - Nintendo DSi XL (UTL-001(EUR))

-  **Do not spill liquids on, or insert any foreign materials into, the system**  
This can lead to fire, electric shocks and / or malfunctions.  
If the Nintendo 3DS XL system comes into contact with liquids, immediately turn the power off, remove the AC adapter, remove the battery cover and battery, then wipe the exterior clean with a soft, slightly damp cloth (use water only). Do not wipe the interior of the Nintendo 3DS XL system with any liquids.

-  **Do not touch the AC adapter connector or any other connector on the system with your fingers or metal objects**  
Doing so can lead to fire, electrocution, short-circuits and / or malfunctions.

-  **Do not touch the system or AC adapter while charging during a thunderstorm**  
Doing so could lead to electrocution from conducted lightning.
-  **Do not use the system in very humid environments or in places with high levels of dust or soot**  
This could lead to fire, electrocution and / or malfunction. This could also cause mould to grow on the camera lenses.
-  **Do not expose the system to excessive physical shock such as dropping it or treading on it**  
This could lead to damaged screens or the battery pack overheating, which could lead to burns or other injuries.  
**Note:** Touching the system while it is damaged can be dangerous. Doing so can lead to injuries, so do not attempt to touch damaged areas.
-  **Do not get too close to the infrared transceiver**  
Looking directly into the infrared transceiver can lead to impaired vision and other problems.
-  **Do not use excessive volume for headphones**  
Using headphones at loud volumes for long periods of time could result in impaired hearing. When using headphones, keep the volume at a level that allows you to hear background sounds. If you notice problems such as fatigue or ringing in the ears, discontinue use. If the symptoms persist, consult a doctor.
-  **Touching the system more than necessary while it is damaged can lead to injury**  
Make no attempt to touch the areas that have sustained damage.
-  **Do not place the system, or accessories such as SD Cards, within easy reach of young children or pets, or in places where there is a risk it could fall into their reach**  
Children may place the AC adapter, stylus, system accessories or other parts into their mouths and cause themselves harm as a result.
-  **Keep the cradle connector clean**  
Failure to do so could lead to fire, overheating, electric shocks, inability to charge and other malfunctions. Clean at regular intervals to ensure the cradle connector remains clean. Avoid applying unnecessary pressure as this could lead to damage.



-  **Important safety information for use of Nintendo 3DS XL on board aeroplanes, in hospitals and airports**
  - Operation of the Nintendo 3DS XL system with wireless communication NOT active may be allowed on board aeroplanes, in hospitals, and in airports as with any other non-wireless device.
  - You will know when wireless communication is active on your Nintendo 3DS XL system when the yellow wireless LED is lit, to indicate that communication is enabled, or is blinking, to indicate that wireless communication is in progress. The wireless LED will blink when you are using in-game multiplayer features or transferring a game / feature to / from another unit. Observe and follow all regulations and rules regarding the use of wireless devices in locations such as hospitals, airports, or on board aeroplanes.
  - In order to comply with airline regulations, do not use in-game multiplayer functions, or use wireless communication in any other way while on board an aeroplane. Operation in these locations may interfere with or cause malfunctions of equipment, with resulting injuries to persons or damage to property.

**Do not use while driving, cycling or walking**

- Use of the system while driving is an offence and it is dangerous.
- Use of the system while walking or cycling can lead to accidents.

**Be aware of your surroundings while using the system**

Failing to take care could lead to injury, damage to household equipment and other malfunctions.

- You will probably move around while using the camera function to take photographs or play certain games, so be careful that all areas that you might move into are clear. Make sure that furniture, objects and people are out of the play area so you don't accidentally bump into them while playing.



**Do not expose the Nintendo 3DS XL system to high temperatures**

The Nintendo 3DS XL system is designed for use at temperatures of 5–35°C. Using the system in hot environments (e.g. under a duvet or other non-ventilated environment) can lead to the system temperature rising sharply, which may cause burns. Use of the system for prolonged periods while charging, can increase the temperature of the system. Touching the system while it is hot may cause burns.

**Use the stylus properly**

Incorrect use can lead to injury or damage.

- Do not use the stylus for any purpose other than to operate the Nintendo 3DS XL system.
- Do not bend or apply unnecessary force to the stylus during use.
- Do not use damaged or distorted styli.

**Be sure to connect the AC adapter to the correct voltage (AC 220 – 240V)**

Failure to do so could lead to fire, overheating, electrocution and other malfunctions. Do not use voltage transformers intended for use abroad or plugs that deliver reduced amounts of electricity.

**Do not use the AC adapter if the cable or plug is damaged**

Doing so can lead to fire and / or electrocution.

- Avoid tightly wrapping, treading on, pulling, twisting or making adjustments to the cord.
- Avoid placing heavy objects on the cord, especially on the DC connector plug.
- If the system has been damaged or the cord broken, do not attempt to use it.
- Do not expose the cord to extreme heat sources such as heaters or stoves.
- If the external flexible cable or cord of the AC adapter becomes damaged, please contact Nintendo Customer Support for information about replacement parts. In order to avoid any potential hazards, do not attempt to repair the adapter yourself.
- If the system is charging while being used, be careful not to pull on or entangle the power cord.
- Use of the AC adapter by children should only be allowed with the full supervision of a parent or legal guardian.

**Keep the AC plug clean by wiping with a dry cloth**

Attempting to use the system when it is unclear or dusty could lead to fire, electrocution or short circuits.

**Do not plug too many devices into the plug sockets or multi-plug adaptors, and do not connect multiple multi-plugs together**

Doing so could lead to fire or electrocution.

**Be sure to plug in and remove the AC adapter properly**

Failure to do so could lead to fire, electrocution or short circuits.

Failing to insert the AC adapter properly into the plug socket may allow metal objects (such as paperclips or metallic straps) to come into contact with the prongs of the plug.

To remove the AC adapter, grip the body of the plug securely and pull it straight out of the plug socket.

If the system is to be used by children, a parent or legal guardian should ensure that they do not allow the child to touch the prongs of the plug with metal objects when plugging the AC adapter in.

The AC adapter should be plugged into an easily accessible socket that is near the equipment to be charged.

**Do not use the system with wet hands**

This can lead to accidents, malfunction, injury or damage to property.

**CAUTION**

**Do not apply unnecessary pressure to the LCD screens or subject them to extreme shock**

Doing so could lead to injury or malfunction.

If the LCD screens should break, avoid contact with any leaking fluid. Repair of damaged LCD screens is not covered by the warranty and must be paid for separately.

**Do not put the system into your back pocket**

Subjecting the system and LCD screens to excessive force, for example sitting on them, can damage them and lead to injury or malfunction.



**Keep your fingers clear of the hinge**



**Purchase a strong wrist strap**

Should you use a wrist strap, please be aware that home-made or weak straps may break, leading to injury or damage.

**Do not swing the system by its strap**

Doing so could lead to the strap breaking and the system being dropped or thrown. This could result in damage to the system or surrounding objects, and injury to yourself or others.

## CAREFUL USAGE

- The AC adapter used with the Nintendo 3DS XL system should be regularly examined for damage to the cord, plug enclosure and other parts.
- The Nintendo 3DS XL system is not intended for children under 3 years old.
- The AC adapter is for indoor use only.

### Do not repeatedly turn the power on and off

Doing so can lead to malfunction and loss of data on SD Cards and in the System Memory.

### First, always turn the power of your Nintendo 3DS XL system off before loading or removing a Game Card / SD Card. Insert the Game Card / SD Card completely without forcing either the Game Card / SD Card or the Nintendo 3DS XL system

Failure to do so can affect save data and cause damage to the system or accessories.

### Only use compatible accessories

The use of the following devices can lead to malfunction or incorrect functionality:

- Accessories which are incompatible with the software being used.
- Devices and accessories that are not approved for use by Nintendo.
- Broken or damaged accessories.

### Do not move the Circle Pad violently from side to side

This may damage the controller and could affect game play.

### Do not damage the Touch Screen

Doing so can lead to malfunction.

- Use either the included stylus (SPR-004) or the item specified by the software for on-screen commands. Do not use pens, metal objects or any other instrument (including fingernails) that could leave scratches on the screen.
- Do not apply unnecessary pressure to, scrape objects across or stab at the Touch Screen.
- Do not use the Touch Screen with sand, lint, crumbs or other abrasive materials on it as these could leave scratches. If the Touch Screen is dirty, use a soft cloth to wipe it clean.
- The upper screen is not touch sensitive. Do not attempt to use the stylus on it.

### Do not expose the cameras to direct sunlight for an extended period of time, and do not directly photograph the Sun or other intense light sources

Doing so could lead to malfunction of the cameras or discolouration of the photographed images.

- Images taken by the cameras may be brighter or darker or have slightly different colours than the actual objects photographed. There may also be permanent light or dark spots on the images. Neither of these cases indicates a defective product.
- If the lenses get dirty, wipe them gently with a dry, soft cloth or cotton swab to clean them. Be very careful not to press on the camera lenses when cleaning, as this may cause damage.

### Do not place the system directly in front of air-conditioning units or in areas which experience sudden changes in temperature and / or are subject to condensation

Condensation in the system can lead to malfunction.

### Taking the Nintendo 3DS XL system from a cold environment to a warm one

To avoid condensation in the system, close the system, place it into a plastic bag and remove the air from the bag. Leave the system for approximately 60 minutes, until it warms up to the temperature of its surroundings, before using it.

### If condensation has formed on the system

Turn the system off and leave it for approximately 60 minutes in a warm environment, until all water droplets have dried, before using it again.

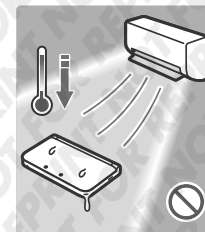

### Do not blow into the connectors of the system or Game Cards

Doing so can cause vapour to enter, which may damage the Game Card and / or Nintendo 3DS XL system.

### Do not store the system in a bag or other container while it is open

Doing so can lead to damage to the LCD screens and the system.

### Do not allow the system to come into contact with paint thinner, alcohol or any other solvent

Doing so can damage the plastic and result in the coating coming off. Be careful not to handle the system after using products like nail varnish remover. To clean the system, dampen a cloth with mildly soapy water, carefully wring out all excess water and then wipe the system clean. After cleaning, wipe the system down again with a soft, dry cloth. The Nintendo 3DS XL should be disconnected from the AC adapter before cleaning.

### When disposing of the battery, follow appropriate local guidelines and regulations

For information on battery disposal, contact your local solid waste authority (page 103).



### Use of Information

- The facility to record audio and images on your Nintendo 3DS XL system is intended to be for personal use only and not for use by third parties. Additionally, there are specifically prohibited types of use. Taking unauthorised video or audio recordings of people and making them public may be an invasion of privacy and should be avoided.
- This system should not be used for illegal activity or the perversion of justice. Such activities could result in legal action.
- Once any kind of audio or video data has been transmitted from your Nintendo 3DS XL system, it may be copied and / or modified freely by third parties. Upon agreeing to transmit your data, you will not be able to limit its use or delete it thereafter.

### IMPORTANT: ANY UNAUTHORISED TECHNICAL MODIFICATION OF THE HARDWARE OR SOFTWARE OF YOUR Nintendo 3DS XL SYSTEM, OR USE OF ANY UNAUTHORISED DEVICES WITH YOUR SYSTEM, MAY RENDER YOUR SYSTEM PERMANENTLY UNPLAYABLE AND RESULT IN REMOVAL OF UNAUTHORISED CONTENT.

Your Nintendo 3DS XL system and software are not designed for use with any unauthorised device and / or any unauthorised software. Please note that the Nintendo warranties do not cover any defects to or defects caused by unauthorised devices, software, modifications and / or non-licensed accessories. Furthermore, such use may lead to injury to yourself or others and may cause performance issues and / or damage to your Nintendo 3DS XL system and related services. Nintendo (as well as any Nintendo licensees or distributors) is not responsible for any damage or loss caused by the use of such devices, software, modifications or non-licensed accessories.

**Important!** After the Nintendo 3DS XL system is updated, any existing or future unauthorised technical modification of the hardware or software of your Nintendo 3DS XL system, or use of an unauthorised device in connection with your system, may render the system permanently unplayable. Content deriving from the unauthorised modification of the hardware or software of your Nintendo 3DS XL system may be removed. Failure to accept the update may render games unplayable.



## Component Names and Functions

The functions of these components are explained in this Operations Manual.

### Notification LED

Notifies you of the status of the system by flashing and changing colour.

- Received SpotPass notification**  
(flashes blue for five seconds) (Page 54)
- Received StreetPass communication**  
(flashes green for five seconds) (Page 54)
- Friend has come online**  
(flashes orange for five seconds) (Page 53)
- Battery power is low**  
(flashes red) (Page 31)



**3D Depth Slider** (Page 33)  
Adjusts the depth of 3D images.



### Wireless LED

Lights up yellow when wireless communication is enabled, and remains off when wireless communication is disabled. Flashes yellow when data is being sent or received.

**Note:** When in Sleep Mode, the wireless LED will light or flash more dimly.



### Wireless Switch

Activate / deactivate wireless communication.

**Note:** To use this feature with Nintendo DS / Nintendo DSi software titles, it must be activated before starting the game. Pushing the wireless switch after loading a software title will not enable wireless communication functionality.

### Microphone

Used by software with microphone functionality.



**POWER Button** (⏻) (Page 28)



**Power LED** (⏻) (Page 31)  
Lights up when the power is on.



**Recharge LED** (🔋) (Page 27)  
Lights up orange while the battery is recharging.

### LCD Screen (3D Screen) (Page 32)

Displays 3D content.

### LCD Screen (Touch Screen) (Page 25)

Touch sensitive screen that enables for tactile interaction.

### Inner Camera

Used by software with camera functionality.

### Speaker (L)

### Speaker (R)

### Control Buttons (A, B, X and Y Buttons)

### Circle Pad

Used by software that supports Circle Pad input.

**Note:** If the Circle Pad is not working properly, please refer to page 96.



### Volume Control

Slide to adjust the volume.

**Note:** The camera's shutter sound will always be played at a fixed volume, regardless of the current volume setting.

### SELECT

**HOME Button** (🏠) (Page 36)  
Displays the HOME Menu.

### START

### Audio Jack

For connection of commercially available stereo headphones. When connected, no sound will be played through the speakers.

**Note:** Please use accessories that are licensed by Nintendo.

### Control Pad

**Battery Cover** (Page 92)

Can be removed to replace the Nintendo 3DS XL Battery Pack.

**Note:** Please refrain from removing unless it is absolutely necessary.

**Infrared Transceiver**

Sends and receives signals for software with infrared functionality.

**L Button**

**Outer Cameras**

(Page 58)  
Used by software with camera functionality. These two cameras allow 3D photographs / videos to be taken.

**Camera LED**

This LED lights up when the outer cameras are in use.

**Game Card Slot** (Page 45)

For loading Nintendo 3DS Game Cards, Nintendo DS Game Cards, Nintendo DSi Game Cards and Nintendo DSi enhanced Game Cards.

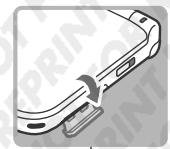

**SD Card Slot**

(Page 34)  
Used for inserting SD Cards (SD Memory Cards or SDHC Memory Cards). The included SDHC Card comes pre-inserted into the system.

**Wrist Strap Attachment**

For attachment of a wrist strap (sold separately).

**Stylus Holder** (Page 25)

Used to store the Nintendo 3DS XL stylus.

**R Button**



**AC Adapter Connector** (Page 27)

Allows connection of the Nintendo 3DS AC adapter (WAP-002(UKV) / WAP-002(EUR)) (sold separately).



**Cradle Connector**

(Page 27)  
Allows recharging via the Nintendo 3DS XL charging cradle (SPR-007) (sold separately).

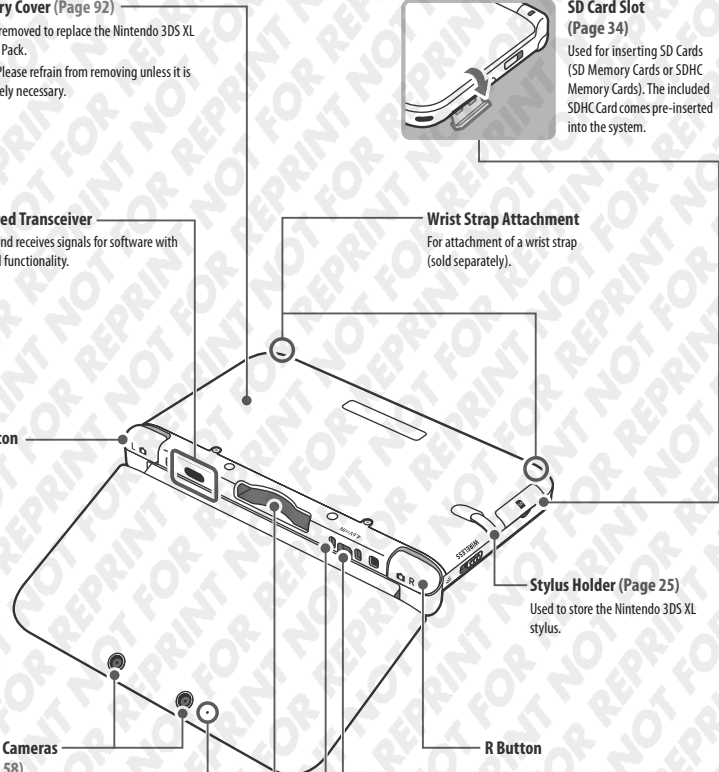

**Using the Touch Screen**

The lower screen, or Touch Screen, is touch sensitive. For software that supports this control feature, use the included Nintendo 3DS XL stylus.

**To use the Nintendo 3DS XL stylus, simply remove it from the stylus holder.**

When you are finished with the stylus, place it firmly back into the stylus holder.

**Note:** Do not attempt to place anything other than the Nintendo 3DS XL stylus (SPR-004) into the stylus holder.

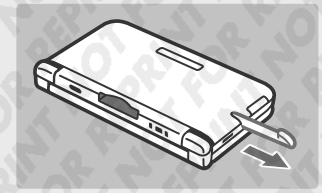

**Touch Screen Controls**

The following terms are used to describe the use of the stylus on the Touch Screen in this manual.

**Touch**

Gently pressing the Touch Screen with the stylus is called "touching" (or "tapping").



**Slide**

Tracing over the Touch Screen with the stylus held gently against it is called "sliding".

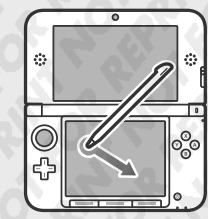

**If you cannot operate the Touch Screen properly**

Go to the **HOME Menu** and into the System Settings, then select TOUCH SCREEN to calibrate the Touch Screen (page 83). If you are having trouble operating the **HOME Menu** via the Touch Screen, you can start the system on the **Touch Screen Calibration Screen** by pressing the **POWER Button** while pressing and holding **L Button + R Button + X Button**.

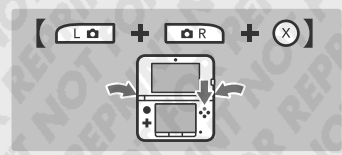

While holding down the L, R and X Buttons...



...press the POWER Button.



## Recharging

You must charge the battery pack before you use your Nintendo 3DS XL system for the first time.

### Recharging Time: 3 Hrs 30 Mins (Approx.)



The system takes approximately 3 hours 30 minutes to fully recharge when off. Charging time may vary if the system is being used while charging, or depending on the level of charge remaining in the battery.

### Recharging Temperature: 5 – 35 degrees Celsius



Attempting to charge the battery pack while the ambient temperature is outside this range may degrade the battery pack and prevent it from charging. If the ambient temperature is low, the batteries may not charge completely.

### Repeated Recharging and Battery Life



Battery life decreases slightly over time as the battery is continually used and recharged. After 500 recharges, battery life may be reduced to 70% of the battery life at the time of purchase.

### Greatly Decreased Usage Time



If you feel the usage time has noticeably reduced, replace the battery pack. Replacement battery packs are sold separately (page 92). Please contact Nintendo Customer Support for further information on where to purchase a replacement (pages 109 – 111).



### This package does not include an AC adapter.

To recharge your system, you will need a Nintendo 3DS AC adapter (WAP-002(UKV) / WAP-002(EUR)) (sold separately).

You can also use the AC adapter included with the Nintendo 3DS, Nintendo DSi and Nintendo DSi XL systems.

AC adapter included with Nintendo 3DS / Nintendo DSi / Nintendo DSi XL



AC adapter included with Nintendo DS / Nintendo DS Lite



## How to Recharge your Nintendo 3DS XL System

To recharge your Nintendo 3DS XL system, you will need the Nintendo 3DS AC adapter (WAP-002(UKV) / WAP-002(EUR)) (sold separately). Alternatively, you can use one of the AC adapters packaged with the Nintendo 3DS, Nintendo DSi or Nintendo DSi XL systems (page 4).

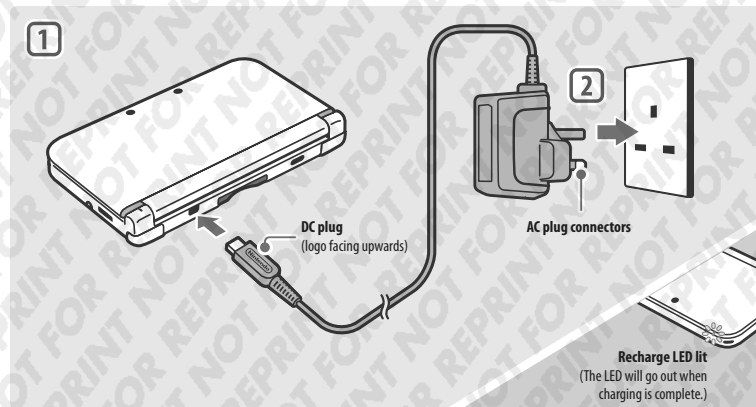

**Note:** The illustration above shows the UK version of the AC adapter.

### 1 Connect the DC connector plug to the Nintendo 3DS XL system

**Note:**

- Be sure the DC connector plug is the right way up before inserting it into the system to avoid damaging either the DC connector plug or the Nintendo 3DS XL system.

### 2 Insert the AC adapter plug into a standard 220 – 240V AC plug socket

Be sure the AC adapter plug is fully inserted. Please see pages 16 – 20 for precautions regarding use of the AC adapter.

### When Recharging is Complete

Remove the AC adapter plug from the plug socket and remove the DC connector plug from the Nintendo 3DS XL system.

**Note:**

- If you play a game while the system is recharging, the recharge LED may not always turn off once charging has completed. This is not a malfunction.
- To detach the system from the AC adapter, hold the system and the DC connector plug, not the cable, while you remove it.

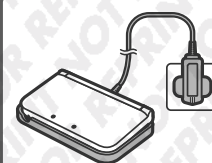

### The Nintendo 3DS XL Charging Cradle (SPR-007) (sold separately) can help make recharging more convenient.

You can recharge your Nintendo 3DS XL system simply by placing it into the cradle.

**Note:** The illustration above shows the UK version of the AC adapter.



## Turning the power on and off

The POWER Button is used to turn the system both on and off. You must configure the System Settings the first time the power is turned on.

Turn the system on by pressing the POWER Button. The power LED will light up when the system has been turned on.

### Note:

- It may take several seconds for the HOME Menu to display after the power is turned on.
- For information about the power LED and battery life, see page 31.

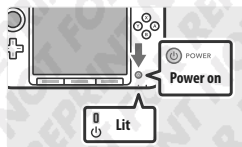

## Sleep Mode and Turning the Power Off

### Sleep Mode

Close your Nintendo 3DS XL system during play to activate Sleep Mode. SpotPass (page 8) and StreetPass (page 9) remain active when the system is in Sleep Mode, but power consumption is greatly reduced.

**Note:** Some software cannot enter Sleep Mode while in use or while carrying out specific tasks. For example, Nintendo 3DS Sound cannot enter Sleep Mode during playback.

### Turning the power off

Press the POWER Button to display the POWER Menu. From here, touch POWER OFF to turn the power off. Alternatively, pressing and holding the POWER Button has the same effect.

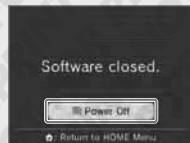

## Configuring the system for the first time

You must configure the system after turning it on for the first time. If this system is to be used by children, an adult should perform these steps. The following steps should be performed with the stylus on the Touch Screen (page 25).

### 1 Set the system language

Touch the language you would like to use, then touch OK.



### 2 Calibrate the 3D Screen

Follow the on-screen instructions in order to view 3D images correctly (see "Adjusting 3D Images" on page 32).

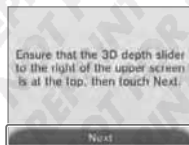

### 3 Set the date and time

Touch  and  to set the date and time, then touch OK.



### 4 Enter a user name

#### Note:

- For information on keyboard usage, see page 30.
- Names can be a maximum of 10 characters.
- The name you choose will be visible on other Nintendo 3DS and Nintendo DS systems via wireless communication, so do not include words or phrases that others may find offensive. The use of inappropriate language may result in the display of your name being restricted on other Nintendo 3DS systems.



### 5 Enter your date of birth

Touch  and  to enter your date of birth.



### 6 Select your country of residence, then your region

Touch OK to confirm.



### 7 Accept the Nintendo 3DS Service User Agreement and Privacy Policy

After reading the information, touch I ACCEPT. If you would rather accept these terms later, touch LATER.

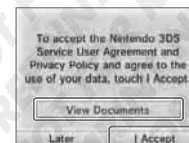

### 8 Configure your internet settings (page 70)

Connecting to the internet allows various types of data to be exchanged via SpotPass and wireless play to be used with supported software titles. To set this later, touch SET LATER.

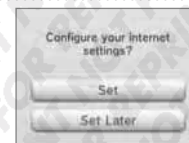

### 9 Set Parental Controls (page 78)

Set up Parental Controls to limit children's access to certain content and functionality. To continue without applying any restrictions, touch SET LATER.

**Note:** The use of the 3D feature by children aged six and under may cause vision damage. To prevent the use of the 3D feature, this feature can be manually turned off by selecting the appropriate option under the Parental Controls settings.

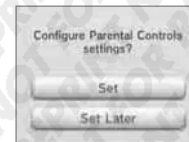

Your system is now ready to be used. Press the HOME Button to enter the HOME Menu (page 36) and begin using your Nintendo 3DS XL system.

## Using the Keyboards

A keyboard will be displayed on the Touch Screen when you are required to input characters. Touch a character to enter it.

### Standard

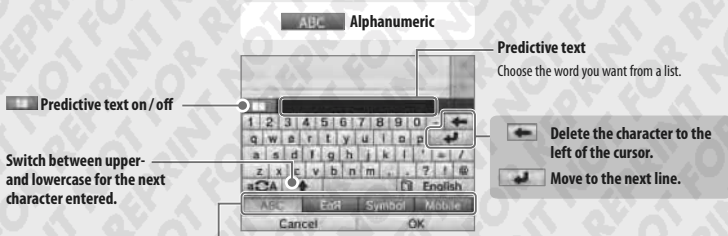

### Switch between input modes

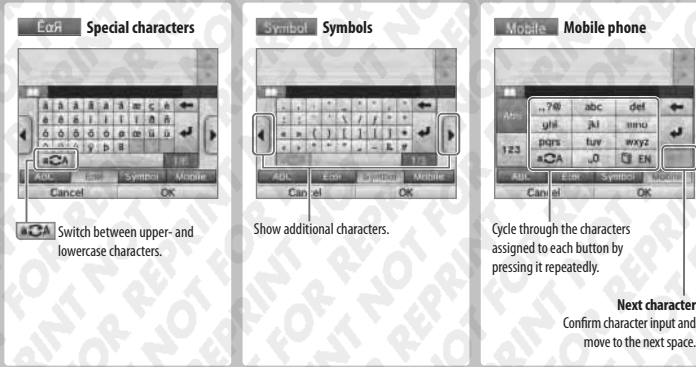

### Numeric Keyboard



## Power LED

The power LED lights up blue when the system is turned on, turns red when the battery charge is low and flashes red when the battery is starting to run out.

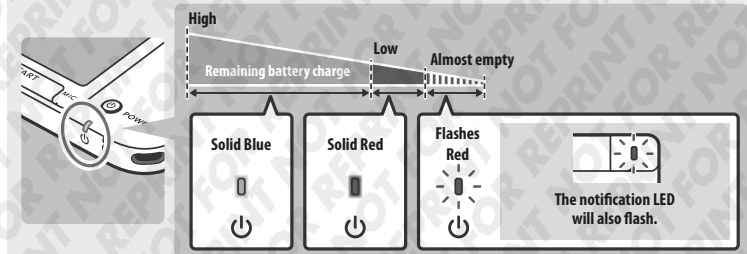

**Note:** If the power LED is red, save your game quickly and recharge. If the battery charge runs out before you save, you may lose unsaved data. If the LED is blue and slowly brightens and dims, the system is in Sleep Mode (page 28), which will conserve battery power.

## Battery Life

Battery life will vary depending on a number of factors, such as the software being used, the quantity of wireless data sent and received and the ambient temperature. As such, these times should only be taken as rough estimates. Using the camera features may reduce the battery time below the figures shown below.

Playing Nintendo 3DS software: **approx. 3.5 – 6.5 hours**  
Playing Nintendo DS software: **approx. 6 – 10 hours**

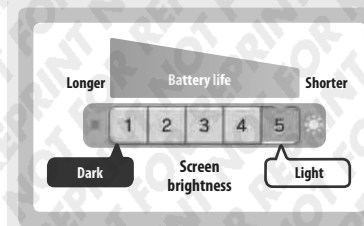

The battery life will change depending on the brightness of the LCD screens. The system is set to "5" at purchase (for information on changing the brightness levels, see page 40).

**Note:** Power-saving mode changes the brightness and colour gradient automatically according to the content being displayed, to extend the battery life for a longer period of time (for information on how to enable power-saving mode, see page 40).

Leaving the system in Sleep Mode (page 28) greatly reduces power consumption while leaving wireless communication such as SpotPass and StreetPass active. If the battery is fully charged, the system can remain in Sleep Mode for 3 days.

**Note:** The power LED slowly pulses when the system is in Sleep Mode. Some software titles do not allow the system to enter Sleep Mode while in use. Closing the system while using such software will result in the power LED remaining solidly lit. For example, Nintendo 3DS Sound cannot enter Sleep Mode during playback.





## Adjusting 3D Images

The 3D Screen allows you to view 3D images. Use the 3D depth slider to adjust the 3D effects to a comfortable level.

The 3D effects generated by the Nintendo 3DS XL are created using the binocular disparity of the eyes (the ability to interpret 3D images due to the difference in position of the left and right eye). By manipulating the 3D Screen so that the left eye sees only the left image and the right eye only sees the right image, vivid and convincing 3D effects can be produced.

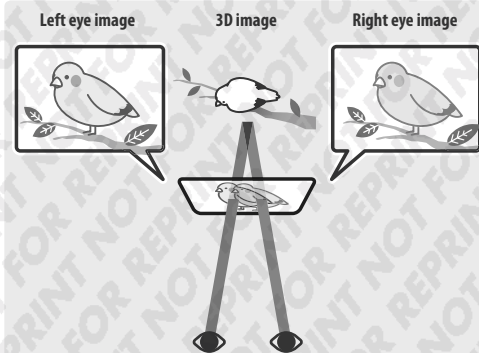

Tilting the screen or viewing it from an angle interferes with the 3D effect, and can cause the screen to appear dark or cause you to see a double image.



## How to View 3D Images Properly

Follow the steps below to ensure that 3D images appear properly.

**1** Look directly into the 3D Screen.



**2** Hold the 3D Screen 30 – 40 cm away from your eyes. Adjust the distance until you can see the 3D images easily.

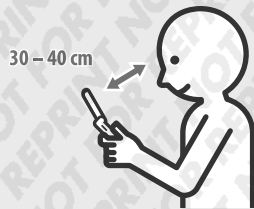

## Adjusting the Strength of 3D Images

Use the 3D depth slider next to the 3D Screen to increase or decrease the 3D effect. If placing the 3D depth slider at the top (strongest 3D effect) makes the 3D images difficult to see, move it downwards little by little until you reach a point where the 3D images are distinct and easy to see. As you become more accustomed to the 3D feature, you may find that raising the 3D depth slider results in better effects.

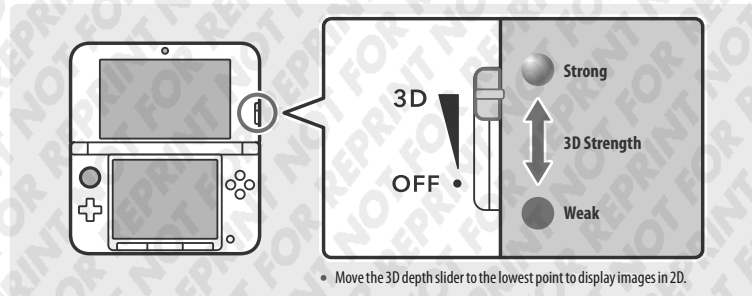

### Note:

- Adjusting the 3D depth slider while viewing content that does not support the 3D feature will not result in 3D images being displayed.
- Certain types of content, including 3D videos and photos, do not allow adjustments in 3D strength. When viewing such content, adjusting the slider will only switch between 2D and 3D images. If you find the 3D effect to be uncomfortably strong while viewing these types of content, it may help to hold the system at a greater distance from your face. If you still find it difficult to see, then try viewing the content in 2D.
- Display of 3D images can be disabled in Parental Controls (page 78).
- Do not view 3D images in direct sunlight or in the direct path of other strong light sources. This may make the 3D images difficult to see.
- 3D images may be difficult to see depending on your surroundings (page 96).

## Precautions for viewing 3D Images

The use of the 3D feature by children aged six and under may cause vision damage. Everyone will have a different way of viewing 3D images. If you see a double image or are unable to see 3D images even when viewing them correctly and with the proper settings, please use the 2D display only. You may need to adjust the 3D depth depending on your physical condition, the content of the images and your surrounding environment. If you experience double vision, headaches, nausea, tired eyes or any sudden changes in your condition, stop playing immediately and take a break.

For health and safety advice on 3D images, see page 13.



## Using SD Cards

Nintendo 3DS XL supports SD Memory Cards (hereafter SD Cards) up to 2 GB, and SDHC Memory Cards (hereafter SD Cards) between 4 GB and 32 GB.

The included SDHC Card comes pre-inserted into the SD Card slot on your Nintendo 3DS XL system. You can use an SD Card to back up photo data or to store music to play back (the type of data you can save varies between software titles).

**Note:** With the exception of Nintendo DSiWare™ (page 64), all downloaded software is stored on the SD Card. Downloaded software (including its save data) cannot be moved or copied individually between SD Cards.

### Using MiniSD / MicroSD Cards

An SD Card adapter is required to use MiniSD or microSD Cards.

When using an SD Card adapter, be sure to remove the entire adapter (not just the card) from the system after use. Leaving the adapter in the system could result in damage or malfunction.



### How to Remove

Turn the power off before attempting to insert or remove an SD Card. Failure to observe this step could damage the system or the SD Card and destroy data.

**Note:** If prompted during a game to remove the SD Card, there is no need to turn off the power.



Press on the SD Card until it makes a clicking sound and pops out, then remove it.

### How to Insert

#### 1 Open the SD Card slot cover

Do not pull or twist the slot cover forcefully. Doing so could stretch or deform it, and you will not be able to close it fully.



#### 2 Insert the SD Card into the SD Card slot

Push it gently but firmly until it clicks into place, then replace the slot cover.



The label should face down.

### SD Card Write-Protection Switch

When the SD Card's write-protection switch is in the lower position, it is locked and data cannot be written to it or erased. To enable these functions, the switch should be in the upper position.

Write-protection switch



### If your SD Card is full...

To free up space on a full SD Card, delete photo, video or sound files you no longer need via Data Management in the System Settings (page 82). Alternatively, transfer all of the data from your current SD Card to one with a larger capacity. You can save software to another SD Card, but cannot later combine the contents of multiple SD Cards.

In order to transfer data, you will need a computer and a commercially available SD Card reader / writer and should transfer the entire "Nintendo 3DS" folder to the target SD Card.



#### Note:

- Always copy the folder to the root of the SD Card.
- Download software (including save data) is stored inside the "Nintendo 3DS" folder. Photo data is not stored in this folder. Do not modify, move, delete or change the names of files in this folder.

### Precautions for Copying Software

Always copy the entire "Nintendo 3DS" folder.

If updated data is saved on the new SD Card, you may not be able to use the same software with the original SD Card. You should only use one SD Card with a software title at a time; the same software cannot be copied to multiple SD Cards for use as backups of your progress. Ensure that you only use the new SD Card.

#### You cannot copy data using the following methods

Download software saved on multiple SD Cards cannot be consolidated onto a single SD Card. Copying new data over existing data will render the target data unusable.



If the contents of the "Nintendo 3DS" folder are modified or if individual files are copied from one "Nintendo 3DS" folder to another, they will be rendered unusable.

The entire "Nintendo 3DS" folder must be copied without any modification in order to use the data.





## HOME Menu

The **HOME Menu** is displayed when you turn on the power. Everything on the Nintendo 3DS XL system can be accessed from here.

Software titles can be launched from the **HOME Menu** by touching the icon that corresponds to the title you want to play. The **HOME Menu** also shows the time and date, current wireless communication mode and the number of steps you've taken that day.

Look out for  on a software icon to instantly tell when a title has received new information or an update via SpotPass.

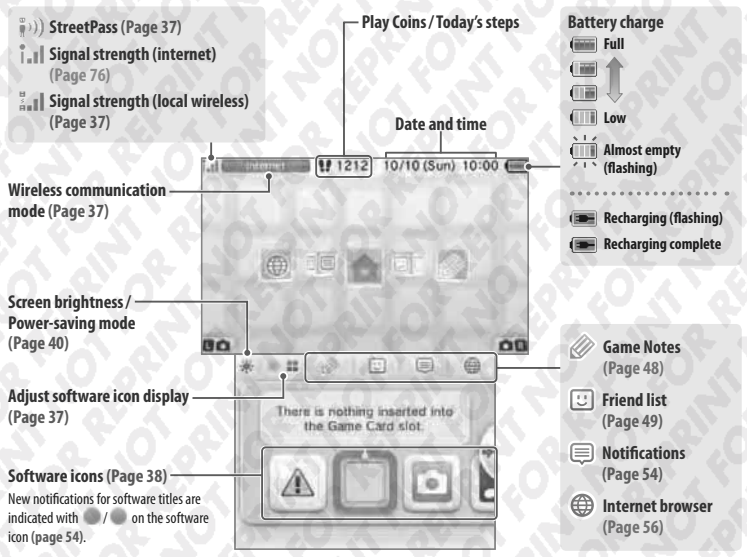

### Note:

- Press the L or R Buttons to activate the cameras and take photos (page 41).
- Content displayed on the upper screen differs according to the software being used. The display rotates more quickly when the microphone picks up more noise.

## Play Coins / Today's steps



If you walk around with your Nintendo 3DS XL system, it will count your steps. Every 100 steps you take, you earn a Play Coin. You can earn up to 10 Play Coins per day, and a maximum of 300 in total. These can then be used in compatible software titles.

### Note:

- Steps are counted when the system is closed and the power is on.
- A maximum of seven days' worth of step data can be recorded while Nintendo DS / Nintendo DSi software titles are left running. You will have to turn the software off once before you can record more.

## Scrolling / Adjusting and Moving Software Icons

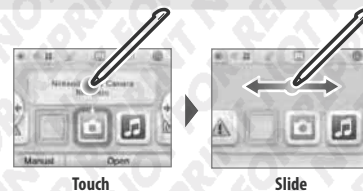

### Scrolling

Touch an icon, then slide the stylus to the left or right to scroll through the available software icons. Touching  /  on the sides of the screen has the same function.



### Adjusting the Display and Moving Software Icons

#### Adjusting software icon display

Touch  /  to change the layout of the software icons shown on screen.











#### Moving software icons

To move an icon, touch and hold the stylus over the icon until it detaches, then drag it to where you want to place it and release the stylus.

Dragging an icon on top of another icon will swap the two icons.

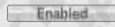
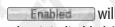
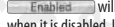

## Wireless communication modes

	This indicates that an internet connection has been established (page 70).
	This indicates that the system is searching for other users who have StreetPass activated (page 9). Registering Nintendo 3DS software for use with StreetPass allows the system to automatically search for other users to exchange information with. This status will be shown together with  .
	This indicates that the system is communicating with other Nintendo 3DS / Nintendo 3DS XL systems in your vicinity. Features such as local friend registration (page 50) and Download Play (page 68) options make use of the local wireless function. During wireless communication mode, the signal-strength icon  is displayed. Stronger signal strength means better data transmissions.
	 will be displayed when wireless communication is enabled, and  when it is disabled. Use the wireless switch to enable / disable wireless communication (page 22).
	 will be shown when enabled, and  when disabled.

## Software Icons

Free software received via SpotPass and software downloaded via Nintendo eShop are added as icons on the **HOME Menu**. A maximum of 300 items can be stored on an SD Card. The different types of software title icon are explained below.

### Card software icons

#### Nintendo 3DS Game Card



#### Nintendo DS / Nintendo DSi Game Card



The software title's icon appears after a Game Card is inserted into the Game Card slot.

### Built-in application icons



#### Health and Safety Information

Read important health and safety information for your system.



#### Nintendo 3DS Camera (Page 58)

Take 3D photos and videos using this application.



#### Nintendo 3DS Sound (Page 61)

Listen to music and record sounds.



#### Mii Maker (Page 62)

Make yourself and other people into Mii characters!



#### StreetPass Mii Plaza (Page 63)

Mii characters you meet through StreetPass (page 9) will appear here.



#### Nintendo eShop (Page 64)

View information and videos about various software, and download new software.



#### AR Games: Augmented Reality (Page 65)

Use the AR Cards together with the outer cameras to create believable augmented reality games.



#### Face Raiders (Page 66)

A shooting game that turns your face, or the faces of your friends, into the enemies!



#### Activity Log (Page 67)

Record the number of steps you take while carrying your Nintendo 3DS XL system and the length of time you spend using software.



#### Download Play (Page 68)

Download demos and play multiplayer games!



#### System Settings (Page 69)

Adjust Nintendo 3DS XL system settings.



#### Gift icon

This icon appears when a new application is added to the **HOME Menu**. Touch a gift icon to unwrap it.

**Note:** The icon will flash if the application has not yet finished downloading. Place the system into Sleep Mode within range of a compatible internet access point to complete the download.

- Any software or video content that is pre-installed on the SDHC Card will also be displayed on the **HOME Menu** (page 7).

## Opening Software

Touch the software icon, then touch **OPEN**.



### Closing / Suspending software

Press the **HOME** Button during game play to suspend a software title and display the **HOME Menu**. Touch **RESUME** or press the **HOME** Button again to resume play, or touch **CLOSE** on the **HOME Menu** to close the software.



#### When suspended...

When a software title is suspended, you can adjust screen brightness and also access Game Notes, the friend list, Notifications, the internet browser, camera mode and instruction manuals. Other software titles can be launched, but you must close the suspended title to do this.

#### Note:

- Depending on the state of the software (wireless communication or other cameras in use, etc.), the **HOME Menu** may not be displayed, or certain functions may not be accessible. Some software titles do not make use of certain **HOME Menu** functions.
- Nintendo DS / Nintendo DSi software titles cannot be suspended.

#### Save before closing software

Any unsaved data will be lost if you close a software title without saving.

#### Do not remove suspended software or turn off the power

Do not remove suspended Game Card software, SD Card, or turn the power off while in this state. Doing so can cause data corruption or loss.

## Electronic Manuals

If a software title includes an electronic manual, the **MANUAL** option will be displayed when you select its icon. Touch this to view the manual. Manuals can be viewed while a software title is suspended.



## Viewing manuals

### 1 Choose an item from the contents

Slide up and down to scroll through the contents of the manual and touch the page you want to view.

**Note:** Press the Y Button to change the language of the manual.



### 2 View the page

Slide up and down to scroll through the contents of the page. Slide left and right to switch pages.

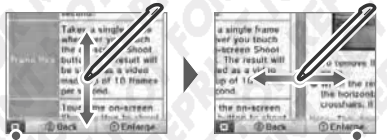

Close manual

Change the font size

## Adjusting Brightness / Power-Saving Mode

Touch on the **HOME Menu** to display the brightness settings.

### Screen brightness

Touch a number to change the brightness level.



### Power-saving mode

Enabling this mode will automatically adjust the brightness of the screen depending on what is being displayed in order to conserve battery power. Disabling it ensures that you can maintain a constant brightness level, but results in shorter continuous play time. This function is set to off by default.

## Brightness levels and battery life

Increasing screen brightness will decrease battery life, and vice versa. Please bear this in mind when you adjust your brightness settings (page 31).

**Note:** Because brighter screen settings require more power, the power LED may change from blue to red. If the battery is nearly empty, the system may turn off suddenly.

## Brightness settings and power-saving mode with Nintendo DS / Nintendo DSi software titles

Nintendo DS / Nintendo DSi software titles cannot access the **HOME Menu**. Press the **HOME** Button to pause the software, then use the following commands to adjust brightness and power-saving mode settings.



Press and hold **START**, then press the following:

- + Up: Increase brightness
- + Down: Decrease brightness
- + Left: Disable power-saving mode
- + Right: Enable power-saving mode

## Taking Photos

Press the L Button or R Button on the **HOME Menu** to switch to camera mode.

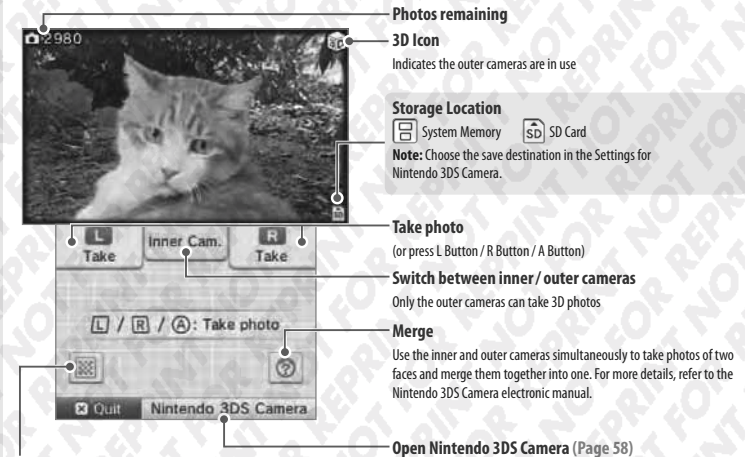

### Read QR Code

If you point the camera at a QR Code for Nintendo eShop or a QR Code with a website URL, you can go directly to the relevant page in Nintendo eShop or the internet browser (page 56).

**Note:** Photos you've taken can be viewed in Nintendo 3DS Camera (page 60).

## Creating Folders on the HOME Menu

You can create folders on the **HOME Menu** to organise your software icons. You can create up to a maximum of 60 separate folders, and each folder can hold up to 60 software icons.

### 1 On the HOME Menu, touch (an empty slot)



### 2 Touch CREATE FOLDER

 (a folder icon) will appear in the empty space.



### 3 Move software icons into the new folder

- To move an icon, touch and hold the stylus over the icon until it detaches. Drag it above the folder icon, and the folder will open. Finally, drag the icon to wherever you would like to place it within the folder, and release the stylus.
- If you would like to move an icon back out of a folder, simply drag it in the same way out of the folder area.

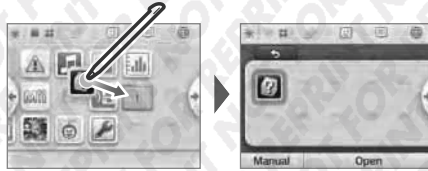

Drag an icon out of the folder area to remove it from the folder



### 4 Touch to close the folder

When you want to open the folder again, simply select it and touch OPEN.

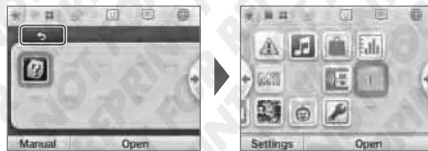

## Adjusting software icon display

Touch  to change the layout of the software icons shown on screen.



## Icons that cannot be moved into folders

The following software icons cannot be moved into folders. In addition, you cannot place a folder inside another folder.

- The Game Card icon
- The Nintendo eShop icon
- The System Settings icon

## Folder Settings

Select a folder icon and then touch SETTINGS to change the folder's name or delete it entirely.



RENAME	Allows you to enter a new name for the folder. <b>Note:</b> The first character of the folder's name will be displayed on its icon in the <b>HOME Menu</b> .
DELETE	Allows you to remove the folder from the <b>HOME Menu</b> . <b>Note:</b> You cannot delete a folder while there are any software icons inside it.



## Card-Based Software

How to use Game Cards with your Nintendo 3DS XL.

**Note:** If the system language is set to Dutch, Portuguese or Russian, non-Nintendo 3DS titles will default to English. In some cases, this may be adjustable within the software.

Nintendo 3DS, Nintendo DS, Nintendo DSi and Nintendo DSi enhanced software can be used on Nintendo 3DS XL systems.

### Nintendo 3DS Game Card



### Nintendo DS / Nintendo DSi Game Card



#### Note:

- 3D content will only be displayed on Nintendo 3DS software titles. Nintendo DS / Nintendo DSi software titles cannot display 3D content.
- SpotPass, StreetPass and the **HOME Menu** cannot be used while Nintendo DS / Nintendo DSi software is in use.
- Only Nintendo 3DS and Nintendo DSi software titles matching the region of the system will work. Software titles from different regions may not function.
- Nintendo 3DS software titles cannot be used with Nintendo DS, Nintendo DS Lite, Nintendo DSi or Nintendo DSi XL systems.

## Pan European Game Information (PEGI) age rating system

### Age rating categories

**3**

Titles rated 3 are suitable for ages 3 and older

**7**

Titles rated 7 are suitable for ages 7 and older

**12**

Titles rated 12 are suitable for ages 12 and older

**16**

Titles rated 16 are suitable for ages 16 and older

**18**

Titles rated 18 are suitable for ages 18 and older

### Content descriptors

Content descriptors are shown on the game packaging where applicable. These icons indicate the main reasons for a game's age rating.



The 'Online' logo indicates that a game allows the player to have access to online game play with other players.

The PEGI system was established to help parents and guardians make informed decisions when buying computer and video games. It replaced a number of national age rating systems with a single system now used throughout most of Europe. For further information about PEGI visit <http://www.pegi.info>.

**Note:** The PEGI rating does not indicate difficulty of a game; it provides information about the age suitability of a game based on its content.

## Using Game Cards

### 1 Insert a Game Card into the Game Card slot

#### Note:

- If you have trouble inserting the Game Card, remove it and check that it is facing the right direction with the label facing away from the system. Forcing the card in when it is facing the wrong direction could lead to damage.
- Only insert or remove Game Cards from the Game Card slot while the **HOME Menu** is displayed or the power is off. (If you have suspended a software title, make sure you have closed it before removing its Game Card.)



### Check which way the Game Card is facing

The Nintendo 3DS / Nintendo 3DS XL / Nintendo DS / Nintendo DSi logos on the card and on the system should face in the same direction.

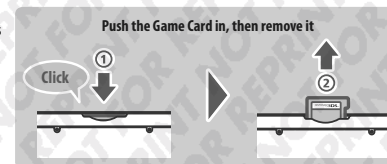

### 2 Touch the Game Card icon, then touch OPEN

Nintendo DS / Nintendo DSi titles are displayed in an expanded format by default. To load the software at its original resolution, hold down either **START** or **SELECT**, then touch **OPEN** to launch the software. Keep **START** or **SELECT** held down until the software has started.



### 3 For further information, refer to the instruction manual for the software you are using.

## Closing Software

Press the **HOME** Button to bring up the **HOME Menu**, then touch **CLOSE** to end a software title. (Any unsaved data will be lost if you close a software title without saving.)

- Touch **RESUME** to return to the point where the software title was suspended.
- To close Nintendo DS / Nintendo DSi software titles, first save your data, then press the **HOME** Button and touch **OK**.

**Note:** If you press the **POWER** Button, the software title will close and the **POWER Menu** will be displayed.

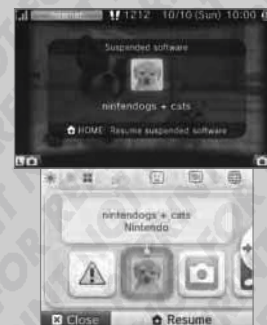

## Game Card System Updates

Some Game Cards contain system update data. Such Game Cards will display a message if a system update is required in order to use the Game Card. Follow the instructions to update your system (page 91).



## Incompatible Nintendo 3DS and Nintendo DS Software and Accessories

The following software titles and accessories are not compatible with Nintendo 3DS XL.



**Nintendo 3DS Charging Cradle**  
(CTR-007)



**Nintendo 3DS Circle Pad Pro**  
(CTR-009)



**Nintendo DS Browser**  
Nintendo DS Memory Expansion Pak (NTR-011)  
Nintendo DS Lite Memory Expansion Pak (USG-007)



**Nintendo DS Rumble Pak**  
(NTR-008)

In addition to these products, it is not possible to use any accessories that would connect to the Nintendo DS or Nintendo DS Lite systems via the Game Boy Advance™ Game Pak slot or anything that functions in conjunction with a Game Boy Advance Game Pak. For more details, visit [support.nintendo.com](http://support.nintendo.com).



## Download Software

Enjoy free software downloaded via SpotPass or software purchased via Nintendo eShop.

Nintendo 3DS XL is equipped with RF module (802.11), which has a radiated output power of less than 10 mW e.i.r.p. and a maximum spectrum power density of less than -30 dBW/1MHz e.i.r.p. These parameters can be maintained when operated within a temperature range of 0 to 40 degrees Celsius. In accordance with this, Nintendo 3DS XL is categorised as Class 1 equipment according to Commission Decision 2000/299/EC.

With the exception of Nintendo DSiWare (page 64), downloaded software is saved to an SD Card. The corresponding icons are displayed in the **HOME Menu** (page 36).

### You can get new software by...

- Receiving free software via SpotPass (page 8).
- Purchasing software via Nintendo eShop (page 64).
- Downloading demo versions.

### Precautions for Download Software

- Because some software is transmitted automatically via SpotPass (page 8), it is advised that you keep an SD Card inserted at all times.
- Up to 40 Nintendo DSiWare titles (page 64) can be stored in the System Memory and up to 300 download software titles can be stored on an SD Card.
- Download software (including its save data) can only be used on the system it was originally downloaded to. Software that you save on an SD Card cannot be used with other Nintendo 3DS / Nintendo 3DS XL systems.
- Demo versions of software may have limitations such as a time limit or number of uses. If you exceed this limit and try to open the software, a message will be displayed. Follow the instructions to delete the software or open Nintendo eShop.
- If the system language is set to Dutch, Portuguese or Russian, Nintendo DSiWare titles will default to English. In some cases, this may be adjustable within the software.
- Only Nintendo 3DS software and Nintendo DSiWare matching the region of the system will work. Software titles from different regions may not function.

### Opening Software

#### 1 Touch the software icon, then touch OPEN

Nintendo DSiWare titles are displayed in an expanded format by default. To load the software at its original resolution, hold down either START or SELECT when launching the software. Keep START or SELECT held down until the software has started.



#### 2 For further instructions, refer to the instruction manual for the software you are using

- How to view the software manual (page 40)
- About software ratings (page 44)
- How to close a software title (page 45)





## Game Notes

Use this application to take notes, even while playing a Nintendo 3DS software title! Just suspend the software and take notes while looking at the software screen.

Touch on the **HOME Menu** to show a list of all the notes you've created.

- You can save up to 16 pages of notes. Note pages can be saved as photo data and viewed in Nintendo 3DS Camera (page 58).
- To create a note while a Nintendo 3DS software title is running, press the HOME Button to suspend the software title and bring up the **HOME Menu**, then launch Game Notes.



### 1 Select a note to edit



- Pens
- Eraser

Choose from three coloured pens to write with, and erase things with the eraser.

#### Switching screens

Touch this icon during a suspended game to change the display on the upper screen.

##### Display both screens



##### Display upper screen



##### Display lower screen



- Notes saved as photo data on an SD Card can be viewed in Nintendo 3DS Camera (page 58).
- Make this note blank.

### 2 Touch when finished

This saves the note and sends you back to the **Game Notes Screen**.



## Friend List

Play and communicate with registered friends via the internet, wherever they may be.

You can receive notifications via the friend list when registered friends go online (connect to the internet).

Touch on the **HOME Menu** to open your friend list. When you open it for the first time, you'll be asked to create a friend card by following the on-screen prompts.

To view the friend list while a Nintendo 3DS software title is running, press the HOME Button to bring up the **HOME Menu**, then launch the friend list.

**Note:** The friend list can only be used with Nintendo 3DS software titles. To use wireless play with Nintendo DS / Nintendo DSi software titles, the relevant settings need to be configured within the software.



### Things you'll need...

#### Personal Mii

In order to create your own friend card, you first need to create your own Personal Mii using Mii Maker (page 62).

#### Internet Connection

This is required to see when friends go online (page 70).

### Friend List



**Register Friend** (Page 50)

#### Viewing Friend Cards

 (Page 51)

- Edit your friend card
- View a friend's friend card

#### Friend List Settings

 (Page 53)

- Friend notification settings
- Delete friend card

## Friend Registration

You can register up to 100 friends on your friend list.

### Local

Touch LOCAL to connect to another Nintendo 3DS / Nintendo 3DS XL user within range and register each other.



### Find the friend card of the person you want to register as a friend and touch it.

Your friend cards will be exchanged and you will be registered on each other's friend lists.



### Internet

Touch INTERNET to register friends by exchanging friend codes. You can check your friend code by looking at your friend card.



Enter the friend code belonging to the person you want to register.



### You are not yet registered on the other system

Your friend will be provisionally registered. Enter the name of the person you want to register. (When the person registers you in return, the status will change and you will become fully registered friends. That person's name and Mii will then be displayed.)



### You are already registered on the other system

The data from the other person's friend card will be received automatically and they will be registered as a friend.



## Do not share your friend code with people you do not know

The friend list is a system intended for use by you and people you know. Posting your friend code on online forums or sharing it with people you do not know can result in you receiving unwanted data or status messages containing language that you may find offensive. Do not share your friend code with people you do not know.

## Editing Your Friend Card / Viewing Friend Cards

Select your friend card from the friend list to edit your details, or view friend cards belonging to other people. Your friend card is indicated by a crown icon.

### Editing your friend card

Select your friend card to edit your message and favourite title.

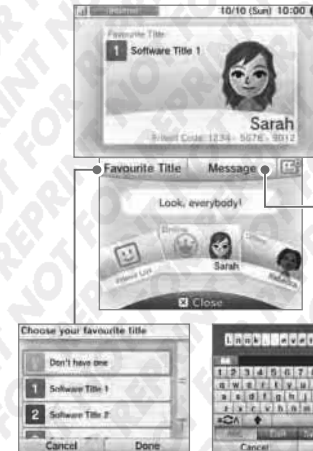

Choose your favourite title from software titles you've played).

Enter a status message of up to 16 characters. This will be visible to your friends.

### Note:

- Touch in the lower screen to register a new friend.
- Please refrain from including personal information or language that other people may find offensive in your status messages. Certain words are prohibited by the system and cannot be entered.
- If you receive a Mii whose name is shown as ???, this means that the creator is probably a blocked user. For more information, please refer to the Mii Maker electronic manual.

### Viewing friend cards

Select the friend card you'd like to view.

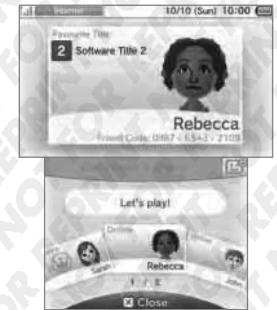

The friend's favourite title or title he / she is currently playing will be displayed on the upper screen.

## Communicating with Friends

When a friend goes online, the information shown on his / her friend card changes and you can see the title he / she is currently playing, if any.

### Online



### Offline



#### Note:

- To see a friend's online status, that friend must have selected YES when asked if they want to show friends their online status. This can be changed at any time in the friend list settings.
- To participate in the game your friend is playing, you must have the same Game Card inserted in your system, or have the same software saved on your system.
- If you are currently using a software title which cannot connect to the internet, you will not be able to go online.

## Joining a Friend's Game

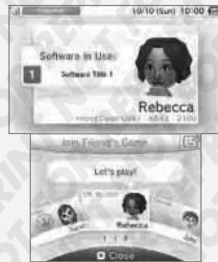

If you can join in a game that one of your friends is playing, the information shown on his / her friend card will change. Touch JOIN FRIEND'S GAME to join the game.

**Note:** You can only join if you have a compatible software title. For more information, refer to the software instruction manual.



## Notification LED

The notification LED on the system will flash orange for five seconds when a friend goes online.

If a friend is playing a game you can join, a  will appear over the  icon.

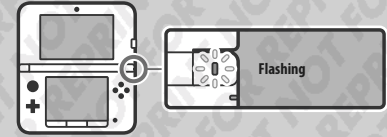

## Friend Card Order

When you are online, friend cards will be displayed in the following order:

Your friend card → Friends whose game you can join → Friends playing a game → Online friends → Offline friends → Provisionally registered friends

## Friend List Settings

Set your status notifications and delete friends from your friend list.

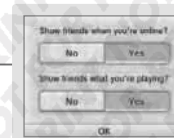

Choose whether to show your online status and the title you're playing.



Delete friend cards from your list.

**Note:** Friends will not be notified if their friend cards are deleted.



## Notifications

You can receive notifications from SpotPass, StreetPass and other sources.

Touch on the **HOME Menu** to show a list of notifications.

To view notifications while a Nintendo 3DS software title is running, press the HOME Button to bring up the **HOME Menu**, then launch the Notifications application.



### Notification Types

<b>SpotPass</b>	Notifications from Nintendo and software titles.
<b>StreetPass</b>	Notifications received via StreetPass (see page 9 for more information on StreetPass).

### Receiving Notifications

Your Nintendo 3DS XL system can receive notifications when...

- The power is on (page 28).
- Wireless communication has been enabled using the wireless switch (page 22).
- An internet connection has been configured (page 70). StreetPass notifications do not require an internet connection.

**Note:**

- Software titles may send some notifications while you are not connected to the internet.
- StreetPass notifications do not require an internet connection.
- Notifications cannot be sent from Nintendo DS / Nintendo DSi software titles.



### Receiving Notifications

The notification LED flashes when the Nintendo 3DS XL system receives a notification. It will flash green for StreetPass notifications and blue for SpotPass notifications. In both cases, it will flash for five seconds. Additionally, when a notification is received, or will be displayed on the notification icon and icons for the respective software titles on the **HOME Menu**.

**Note:** When receiving notifications while the system is in Sleep Mode, the notification LED will flash for five seconds, then remain lit. When you open the system, it will go out.

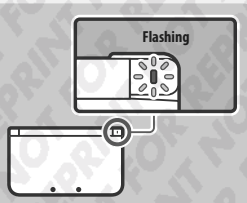

### Viewing Notifications

Touch a notification to view it.



Slide the slider up or down to scroll through the notifications.

- Unread notifications will be indicated by for StreetPass or for SpotPass notifications.
- A maximum of 12 StreetPass and 100 SpotPass notifications can be stored on the system. If these limitations or the storage size is exceeded (eg. if there are a lot of notifications containing images), older notifications will be erased, starting with the oldest.

### Stopping notifications

#### Stopping notifications from software titles

Touch **OPT OUT OF NOTIFICATIONS FOR THIS SOFTWARE** inside a notification then follow the on-screen prompts.

**Note:** Notifications that do not require an internet connection, such as those from software titles, cannot be stopped from the Notifications list. These are delivered during play and the method of stopping these notifications differs between software titles.

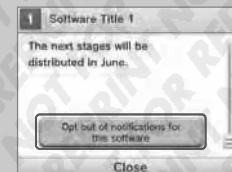

#### Stopping notifications from StreetPass

Touch **DEACTIVATE StreetPass FOR THIS TITLE**, then adjust the settings in **StreetPass Management** in the System Settings to deactivate StreetPass. Once StreetPass has been deactivated, you will no longer receive these notifications for this title (page 82).

**Note:**

- To restart notifications, adjust the settings within the software. Refer to the instruction manual for more detailed information.
- Notifications from Nintendo contain important information for all users and cannot be opted out of.



## Internet Browser

View web pages on the internet using intuitive stylus controls.

Touch on the **HOME Menu** to start the internet browser. When using the browser for the first time, follow the on-screen setup instructions.

### Note:

- An internet connection is required in order to view web pages (page 70).
- The browser can be launched while playing Nintendo 3DS software by pressing the HOME Button and selecting it from the **HOME Menu**.
- Depending on the software, it may not be possible to launch the browser during play.



When you start the browser, the menu shown below will be displayed. Touch an option to select it.

### Menu

**Search**  
Enter text to search for.  
 (shown with search engine set to Google)

**Bookmarks**  
View the list of pages you have bookmarked and open pages from the list.

**Add Bookmark**  
Bookmark the current page.

**Settings**  
Change browser settings.

**Page Info**  
View the title, address and security information of the current page.

**Enter URL**  
Enter a web address (URL) directly.

**Hide Menu**

**Instruction Manual**  
The browser contains an instruction manual with detailed information on how to use it.

**Close** **Manual** **Hide**

**Close** **Bookmarks** **Add** **URL**

## Using the Browser

Slide the stylus on the lower screen to move around the page. Touch links on the lower screen to open them.

### Slide to move



### Touch links

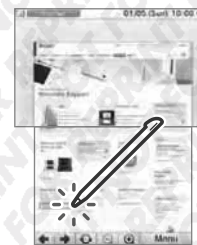

### Toolbar

← → ↺ ↻ ⊕ ⊖ Menu

Display the menu (Page 56).

Decrease / increase the zoom level.

Displayed as while loading the page; touch to stop loading the page.  
Displayed as once the page has loaded; touch to reload the page.

Display the previous / next page in the browser history.

### Note:

- Content requiring plug-ins, such as video or music files, cannot be played or displayed.
- Large pages may not be fully downloaded or displayed. If this happens, try reloading the page by touching RELOAD. This may load the rest of the page.

## Protecting Children from Harmful Sites

You can use the Parental Controls settings of your Nintendo 3DS XL system (page 78) to restrict use of the browser in order to prevent children from accessing harmful or inappropriate sites.



# Nintendo 3DS Camera



Take photos and videos in full 3D!



For detailed controls information, consult the electronic manual.

## Taking Photos and Videos

The two cameras mounted on the exterior of the system are used to take 3D photos. Each camera takes one photo: the left camera takes one for the left eye, and the right camera for the right eye. These photos are then combined and appear in 3D on the 3D Screen (page 32).

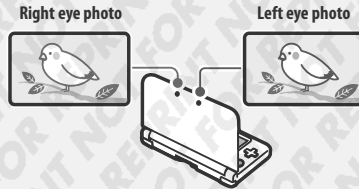

## Tips for the best 3D visuals

Ensure that you leave a minimum of 30 cm between the subject and the Nintendo 3DS XL system when taking photos / videos. Getting too close to the subject will cause it to become blurred and out of focus, and can result in a blurred photo / video with a double image.



Taking a photo / video while too close to the subject will result in a blurred or double image.

The closer the subject is when you take the photo / video, the stronger the 3D effect.

One metre is the optimal distance for 3D photos / videos and will give a vivid image.

Having objects far away in the background while taking a photo / video will add to the 3D effect.

## Taking Photos / Videos

Touch / or press L Button / R Button / A Button to take a picture or start recording video.



## Nintendo 3DS Camera Features

Nintendo 3DS Camera contains a number of features to ensure you make the most unique creations possible!

Camera Modes		Video Modes
<b>Sparkle</b> 	<b>Merge</b> 	<b>Frame Pick (take multiple photos to create a stop-motion video)</b> 
<b>Dream</b> 	<b>Pinhole</b> 	 <b>Clip Link (record several segments and link them together)</b> 
<b>Low-light</b> 	<b>Mystery</b> 	  

### Note:

- You can use the Low-light camera mode when taking videos.
- There are also other features not listed here, such as crosshairs, a timer, brightness and contrast adjustment, etc.

## Viewing Photos and Videos

Touch VIEW PHOTOS / VIDEOS to view the photos and videos you've taken.

Touch a thumbnail to display the photo / video.

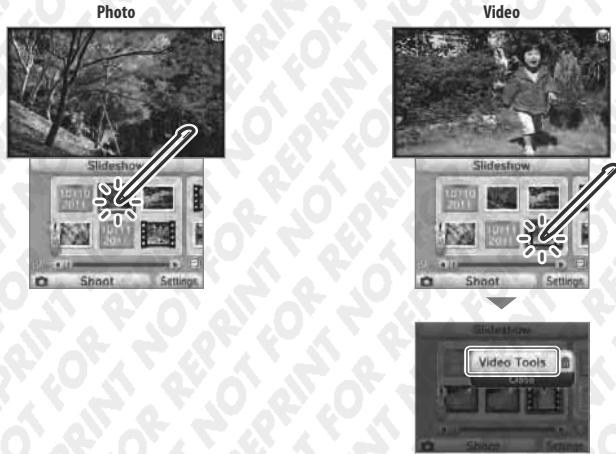

Select VIDEO TOOLS to play the video with extra options.

## Extra Features

### Graffiti

Create your own unique images by decorating your photos.



### Tweaking Videos

Adjust the playback speed and sound pitch, or even play videos in reverse!



• You can also view a slideshow, which will automatically transition between your photos and videos.



# Nintendo 3DS Sound

With Nintendo 3DS Sound, you can play music stored on SD Cards. You can also record sounds using the microphone and then edit them to create entirely new sounds!

**Note:** For information on the types of music file that can be played, consult the electronic manual.

For detailed controls information, consult the electronic manual.



### Listen to Music

Listen to music stored on an SD Card. You can adjust the music as you go along, such as changing playback speed and sound pitch, and turning on a karaoke mode.



### Record Sounds

You can record sounds of up to 10 seconds. You can then adjust the sound by changing playback speed, sound pitch and even voice.



### StreetPass

This software contains two StreetPass features: StreetPass Hit Parade and StreetPass Compatibility. StreetPass Hit Parade lets you see the most popular songs around, while StreetPass Compatibility compares your music tastes with other users.

• To use these features, add music to a StreetPass playlist and activate StreetPass.





# Mii MAKER

Create Mii characters for yourself, family members and friends using the wealth of facial features available!



For detailed controls information, consult the electronic manual.

## Use a Photo

Take a photo of your face to create your Mii, then tweak the facial features as much as you want. You can also design a new Mii from scratch.



Select a face.



Retake

Next

## Register up to 100!

You can register up to 100 Mii characters in Mii Maker.

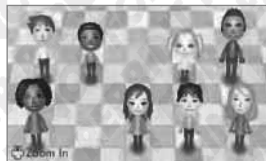

Zoom In



Back

Edit

Erase

- You can also receive Mii characters from a friend's Nintendo 3DS / Nintendo 3DS XL system or from the Mii Channel on the Wii™ console.

These Mii characters can even show up in Mii-compatible games!



The screenshots above are from **PILOTWINGS RESORT™** for Nintendo 3DS.

All Mii features and likenesses are the intellectual property of Nintendo and cannot be distributed freely or used for personal gain.

Using Software

Mii Maker



StreetPass

# Mii PLAZA

Bring Mii characters together in the plaza! Mii characters you meet through StreetPass (page 9) and wireless play will appear here – and you can even play some simple games via StreetPass!



For detailed controls information, consult the electronic manual.

## Use StreetPass to collect Mii characters and send your StreetPass Mii to others!

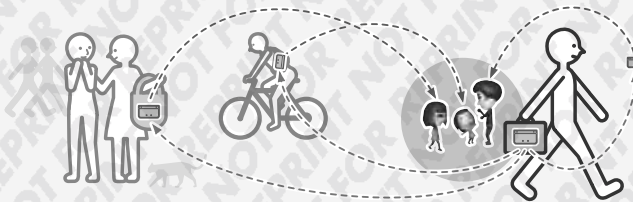

Mii characters will gather here. These Mii characters may be from StreetPass Mii Plaza, or even from other software titles.



Sarah

## Play Games

Play some small games with the Mii characters you encounter!



Puzzle Swap



StreetPass Quest

Using Software

StreetPass Mii Plaza





# Nintendo eShop

Connect to the internet and view information and videos about various software, and download software for your Nintendo 3DS XL system. To purchase software, you need to add funds to your Nintendo eShop account.

**Note:**

- Nintendo 3DS software and Nintendo DSiWare from regions other than Europe / Australia may not function.
- If a child will be using the system, you can restrict the use of credit cards, or the purchase of goods and services, via Parental Controls (page 78).



For detailed controls information, consult the electronic manual.

## Downloadable Software

### Nintendo 3DS download software

You can download software exclusively available via Nintendo eShop.

### Virtual Console

Play classic titles from systems such as Game Boy™ and Game Boy™ Color on your Nintendo 3DS XL system!

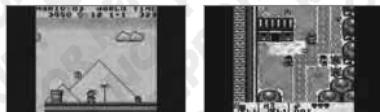

### Nintendo DSiWare

You can purchase Nintendo DSiWare straight from Nintendo eShop. Nintendo DSiWare includes a range of software titles, from useful tools to quick and simple games!

### Precautions Regarding the Use of Nintendo eShop

- In order to use Nintendo eShop, you must first agree to the Nintendo 3DS Service User Agreement and Privacy Policy, and then set up an internet connection.
- You can add funds using a credit card or Nintendo eShop Card.
- Nintendo eShop Cards sold in the European Economic Area and Switzerland can only be used with Nintendo systems sold in the same regions.
- You cannot add an amount of funds that would cause the balance of your Nintendo eShop account to exceed the maximum allowed funds.
- The fund value of a Nintendo eShop Card cannot be split between multiple accounts.
- Nintendo will not reissue, refund or accept inquiries regarding Nintendo eShop Cards except under circumstances where this is required by law. Nintendo eShop Cards, funds and purchased software cannot be refunded, returned, transferred or exchanged for cash.
- Once registered on a Nintendo 3DS / Nintendo 3DS XL system, Nintendo eShop activation numbers cannot be used again.
- The purchasing of software on Nintendo eShop constitutes a licence agreement between Nintendo and the purchaser. For details, open the System Settings from the HOME Menu, select INTERNET SETTINGS, OTHER INFORMATION, then USER AGREEMENT.
- Age rating information is displayed before confirmation of software purchase. Please take this information into consideration when making purchases (page 44).
- If you use the DELETE ACCOUNT option in the Nintendo eShop application, your remaining funds, purchased/downloaded software and purchase / download history will all be deleted.



# AR GAMES

Augmented Reality

These augmented reality games use the AR Cards that come packaged with the Nintendo 3DS XL system. Place an AR Card in the sights of your system's outer cameras, and boxes, monsters, everything will come bursting out!



For detailed controls information, consult the electronic manual.

There are six AR Cards included with the system. Begin with the ? Card.



? Card



Character Cards

To play the AR Games, place an AR Card on a flat, well-lit surface. Adjust the distance and angle, keeping the AR Card within the sights of the outer cameras, until it is recognised correctly. The games are played by moving the system around while keeping the AR Card in sight.

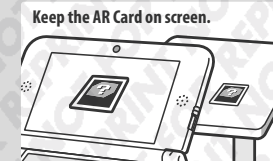
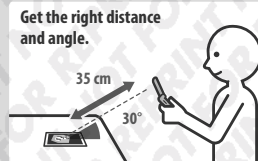

Game Selection Screen





# FACE RAIDERS

Gather lots of faces and battle them in this fast-paced game!

For detailed controls information, consult the electronic manual.



Face Raiders involves moving your system around and shooting the relentless hordes of attacking faces! Begin the game by taking a photo.

Note: For more information about facial recognition, see page 100.

Take a photo then play the game,  
moving the system around as you play!



- After you win a stage, the face you used for that round will be saved. Collect lots of faces to unlock new stages and add more variety to the enemies you encounter! Try taking pictures of your family and friends to expand your collection.



# Activity Log

The Activity Log keeps track of the number of steps taken when you take your Nintendo 3DS XL system out with you. It also records your play time on software titles.

Note: Steps are counted when the system is closed and the power is on.

For detailed controls information, consult the electronic manual.



Display the number of steps you've taken while carrying your Nintendo 3DS XL system and the time you've spent on software titles.

Display a list of software titles you've played, including the time spent on each and the number of times it's been played.



### Daily Records

Steps: 3,984

Play Time: 3 files / 1:10

Nintendo 3DS Camera	0:38
Nintendo 3DS Sound	0:26
Activity Log	0:06

### Software Library

Total Time Played: 5:20

No. Times Played: 12

Average Play Time: 0:26

First Played: 12/04/2011

Last Played: 01/05/2011

File	Play Time	No. Times Played
111	0:38	12
112	0:26	11

See the amount of time spent on each software title.

See various charts related to the software you've used on your system.



# Download Play

With Download Play, you can play certain multiplayer games with other users even if you have only one copy of the game. You can also send and receive demos of certain software titles.

Download Play is compatible with Nintendo 3DS, Nintendo DSi, Nintendo DS Lite, Nintendo DSi and Nintendo DSi XL systems.

**Note:** Download Play content from Nintendo 3DS titles can only be played on a Nintendo 3DS/Nintendo 3DS XL system.

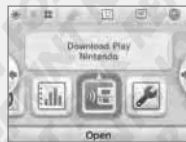

## Download Play-compatible software (host)



## No software (client)



### Steps for the Host System

- 1 Launch the software title from the HOME Menu.

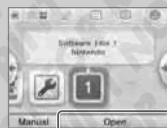

Follow the instructions in the instruction manual of the software you are using.

### Steps for Client Systems

- 1 Open Download Play from the HOME Menu.

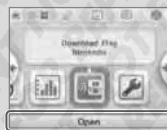

- 2 For Nintendo 3DS software titles, touch . For Nintendo DS / Nintendo DSi software titles, touch .



- 3 Touch the panel for the software you want to use. Follow the instructions in the instruction manual of the software you are using.



# System Settings

Configure your internet settings, Parental Controls and other basic system settings here.

Touch the System Settings icon on the HOME Menu to open the System Settings.

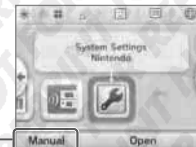

For detailed information, consult the electronic manual.

<b>INTERNET SETTINGS</b>	Configure your connection to the internet (page 70).
<b>PARENTAL CONTROLS</b>	Restrict the use of software, content that can be purchased and downloaded, and system functions such as 3D images (page 78).
<b>DATA MANAGEMENT</b>	Manage data such as Nintendo 3DS download software, Nintendo DSiWare and StreetPass data. You can also clear your blocked-user settings (page 82).
<b>PROFILE</b>	Change your user name, date of birth and other settings (page 83).
<b>DATE &amp; TIME</b>	Change the date and time (page 83).
<b>TOUCH SCREEN</b>	Calibrate the Touch Screen (page 83).
<b>3D CALIBRATION</b>	Calibrate the 3D Screen (page 83).
<b>SOUND</b>	Change the sound output settings (page 83).
<b>MIC TEST</b>	Check that the microphone is working correctly (page 83).
<b>OUTER CAMERAS</b>	Calibrate the outer cameras (page 84).
<b>CIRCLE PAD</b>	Calibrate the Circle Pad (page 83).
<b>OTHER SETTINGS</b>	
<b>SYSTEM TRANSFER</b>	Transfer data from your Nintendo DSi or Nintendo DSi XL system to your Nintendo 3DS XL system, or between Nintendo 3DS / Nintendo 3DS XL systems (page 86).
<b>LANGUAGE</b>	Change the language of the system (page 83).
<b>SYSTEM UPDATE</b>	Update the system software (page 91).
<b>FORMAT SYSTEM MEMORY</b>	Format the system to erase data stored in the System Memory, such as photographs, software and save data (page 91).



## Internet Settings

Connect your Nintendo 3DS XL system to the internet to open up even more options.

There are lots of fun and useful options to enjoy, such as shopping for content using Nintendo eShop, receiving notifications and free software through SpotPass and playing online with people all over the world.

### Nintendo eShop

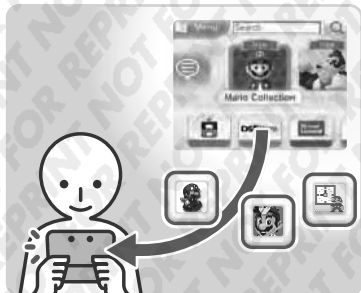

Purchase content for your Nintendo 3DS XL system, such as Nintendo 3DS download software, Nintendo DSiWare and classic games from other systems with Virtual Console (page 64).

### SpotPass

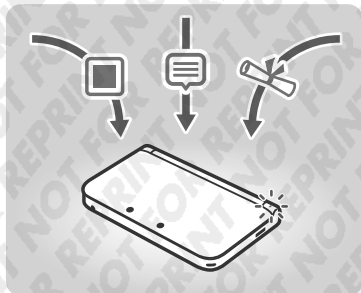

By leaving your system turned on, it can automatically receive data even if the system is closed (page 8).

### Online Play

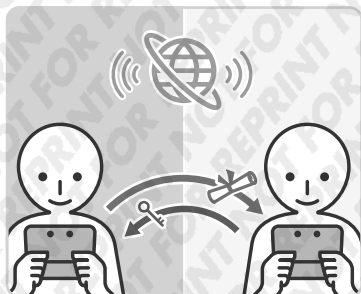

Connect to the internet to play with friends and people all over the world.

**Note:** Functionality differs depending on the software. For more information, please refer to the software manual.

### Internet Browser



Gives you easy access to online content.

## Required Items for Internet Connection

A wireless connection is required to connect your Nintendo 3DS XL system to the internet. A computer is needed to configure the settings on your wireless access point (router).

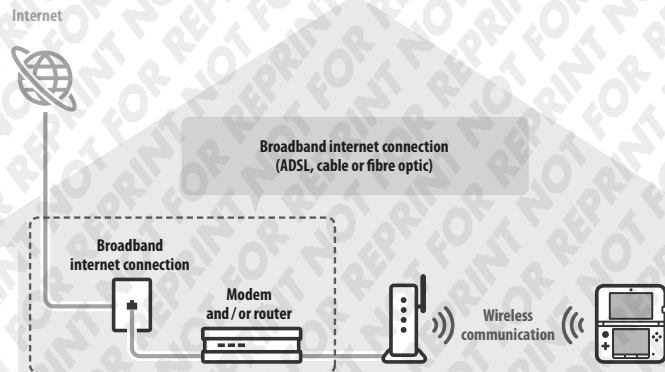

### Wireless access points

#### Note:

- It is easiest to connect to wireless access points which support AOS5™ or Wi-Fi Protected Setup™.
- Use an access point which supports the 802.11b and/or 802.11g standards. Access points which only support 802.11a are incompatible.
- To see a list of compatible access points (routers) that have been confirmed to work with the Nintendo 3DS XL system, visit [support.nintendo.com](http://support.nintendo.com).

## Connecting to the Internet

Once you have everything you need to connect to the internet, you can start configuring the settings on your Nintendo 3DS XL system.

**Note:** In order to connect to the internet when using a Nintendo DS Game Card, you must configure Nintendo DS Connections (page 77).

### 1 Touch CONNECTION SETTINGS



### 2 Touch NEW CONNECTION



#### Find your Ideal Settings with the Tutorial

Touch TUTORIAL to receive help with the connection setup process. Follow the instructions on-screen and select options to configure the right settings for your connection.

- For AOSS guidance, see page 73.
- For Wi-Fi Protected Setup guidance, see page 74.
- For guidance on searching for and configuring access points, see page 75.



#### Setting Up a Connection without the Tutorial

If you would rather set up your connection without assistance, touch MANUAL SETUP instead, then select from the options displayed to configure your connection.

- For AOSS guidance, see page 73.
- For Wi-Fi Protected Setup guidance, see page 74.
- For guidance on searching for and configuring access points, see page 75.



## Connecting using AOSS

If your access point supports AOSS, you can set up a connection quickly and easily. Refer to the instruction manual for your access point in addition to this manual.

**Note:** Using AOSS may cause your access point settings to change. If your computer is connected to the access point without using AOSS, it may no longer be able to connect after using AOSS. Establishing a connection using an access point found through a search will not change any of the access point's settings (page 75).

### 1 Touch AOSS

**Note:** If you are using the tutorial and you have selected , start from step 2.



### 2 Steps for the access point

Press and hold the AOSS button on the access point until the AOSS light flashes twice in succession.

**Note:** If you have tried and failed several times to set up a connection using AOSS, wait approximately 5 minutes before trying again.



### 3 Once the Setup Complete Screen appears, touch OK to begin a connection test

- If the test is successful, setup is complete.
- Failure to establish a connection can sometimes occur after AOSS setup is complete. If this happens, please wait a short while before trying to reconnect.

## Connecting using Wi-Fi Protected Setup

You can set up a connection quickly and easily using Wi-Fi Protected Setup. Refer to the instruction manual of your access point for further information.

### 1 Touch

**Note:** If you are using the tutorial and you have selected  start from step 2.



### 2 Touch the connection method supported by your access point



### 3 Steps for the access point

**Note:** It may take around 2 minutes to complete setup.

#### For Push-Button Connection

Press and hold the Wi-Fi Protected Setup button on the access point until the LED blinks.



#### For PIN Connection

A PIN will be displayed on the Touch Screen. Enter the code into the access point settings, then touch NEXT.

**Note:** After configuring the access point, touch NEXT on the Touch Screen of your Nintendo 3DS XL system.



### 4 Once the Setup Complete Screen appears, touch OK to begin a connection test

- If the test is successful, setup is complete.
- Failure to establish a connection can sometimes occur after Wi-Fi Protected Setup is complete. If this happens, please wait a short while before trying to reconnect.

## Searching for and Connecting to an Access Point

You can use this method to search for and connect to an access point if your access point does not support AOSS or Wi-Fi Protected Setup. You should also consult the instruction manual that came with your access point.

### 1 Touch SEARCH FOR ACCESS POINT

**Note:** If you are using the tutorial and have selected DONT KNOW / NONE OF THESE or OTHER, start from step 2.

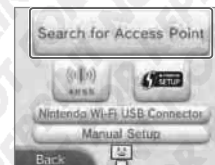

### 2 Select an access point

**Note:** Touch the name of the access point you want to connect to (its SSID, ESSID or network name). If you do not know this name, please consult the settings of the access point you are using.

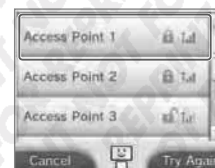

### 3 Enter the security key and touch OK

- This step only applies if the access point is secured. If you do not know the security key, please consult the settings of the access point you are using.
- The characters for the key you entered will be hidden by asterisks (\*).

**Note:** A security key is the password set for your access point and is required to enable your Nintendo 3DS XL system to make an internet connection. It may also be called an encryption key or network password.

### 4 Touch OK to save your settings

### 5 Touch OK to perform a connection test

- If the test is successful, setup is complete.
- If connection fails and an error appears, follow the instructions given in the error message.

## About the and icons

Access points marked with  require you to enter the security key registered with the access point.

 Secured access point. A key is required.

 Key not required.

The  icon is an indicator of the current wireless signal strength. There are four levels of signal strength. Stronger reception will provide smoother wireless communications play.

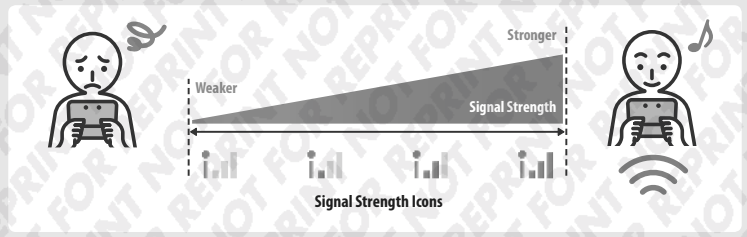

## Security Types

The Nintendo 3DS XL system is compatible with the following security types. You must choose the correct security type for your access point to be able to establish a connection.

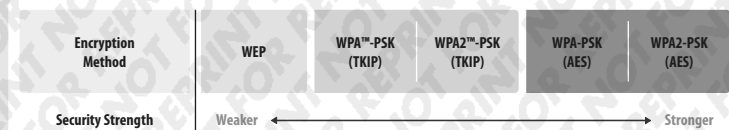

**Note:** Nintendo DS software only supports WEP. To connect to the internet using Nintendo DS software, touch NINTENDO DS CONNECTIONS to set up an access point using WEP (page 77).

## SpotPass Settings

Set whether to receive software automatically and whether to send system information to Nintendo.

- Select AUTOMATIC SOFTWARE DOWNLOADS, and then YES, and you will be able to receive software distributed via SpotPass.
- Select SENDING OF SYSTEM INFORMATION and then YES, and information about software you play and your system settings, etc. will be sent to Nintendo automatically. This information will be used to help in the development of future products.



## Nintendo DS Connections

Set up an internet connection for use with Nintendo DS software.

**Note:** The only access point security type supported by Nintendo DS software is WEP.

### 1 Touch NINTENDO DS CONNECTIONS

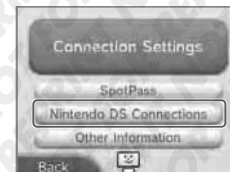

### 2 Refer to the Nintendo Wi-Fi Connection Instruction Booklet included with Nintendo DS software titles for details on how to connect

**Note:** Nintendo Wi-Fi Connection configuration cannot be deleted or moved from the Nintendo DS Connections option on the Nintendo 3DS XL system.



## If an Error Code Appears

An error message and error code will appear if the internet connection settings are incorrect or if the connection test fails. Follow the instructions given in the on-screen error message.

### For error codes that appear when setting up Nintendo DS Connections or when playing Nintendo DS software

Nintendo DS Connections may not have been configured correctly. Check the Nintendo Wi-Fi Connection Instruction Booklet included with Nintendo DS software for details on the error code given.

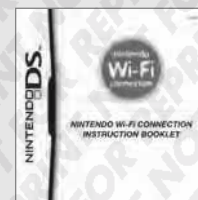

### For error codes that appear when playing Nintendo DSI software

The internet connection configured for the Nintendo 3DS XL system may not be correct. Select CONNECTION TEST from Internet Settings to start the connection test, then follow the instructions given in the error message.





## Parental Controls

Use this option to restrict children from playing games, making purchases or using certain functions of the Nintendo 3DS XL system (such as the display of 3D images).

### Options that can be restricted

The following options can be restricted. Please configure these options as necessary when allowing children to use the Nintendo 3DS XL system.

**Note:** Setting Parental Controls restrictions for any of the options below will also restrict the Internet Settings, Outer Cameras, System Transfer and Format System Memory functions. You will have to enter the Parental Controls PIN in order to use these functions.



<b>SOFTWARE RATING</b>	Restricts the use of Nintendo 3DS and Nintendo DSi software based on software rating systems (page 44). <b>Note:</b> Nintendo 3DS software received via Download Play is also restricted, but this setting cannot restrict Nintendo DS software or software received via DS Download Play.
<b>INTERNET BROWSER</b>	Restricts use of the internet browser and prevents the viewing of web pages.
<b>NINTENDO 3DS SHOPPING SERVICES</b>	Prevents the purchase of goods and services, and the use of credit cards with Nintendo 3DS shopping services.
<b>DISPLAY OF 3D IMAGES</b>	Restricts the display of 3D images. All images will display in 2D.
<b>SHARING IMAGES / AUDIO / VIDEO / LONG TEXT DATA</b>	Restricts the wireless transfer of data that could be used to carry personal information, such as photos, images, sounds, videos and long messages. <b>Note:</b> This setting cannot restrict Nintendo DS software.
<b>ONLINE INTERACTION</b>	Restricts communication with other Nintendo 3DS, Nintendo 3DS XL, Nintendo DSi and Nintendo DSi XL systems over the internet. <b>Note:</b> This setting cannot restrict Nintendo DS software.
<b>StreetPass</b>	Restricts communication with other Nintendo 3DS / Nintendo 3DS XL systems using StreetPass. <b>Note:</b> This setting cannot restrict Nintendo DS / Nintendo DSi software.
<b>FRIEND REGISTRATION</b>	Restricts the registration of new friends.
<b>DS DOWNLOAD PLAY</b>	Restricts the use of DS Download Play.
<b>VIEWING DISTRIBUTED VIDEOS</b>	Restricts viewing of distributed videos to those suitable for all ages. This setting does not apply to game-related videos found on Nintendo eShop, which can be restricted using the separate Software Rating setting. <b>Note:</b> For some distributed video playback software, this setting may also restrict the use of the software itself.

**Note:** You can only use one configuration per system. Should you need to create restrictions for several children, we suggest setting up Parental Controls for the youngest child.

### Configuring Parental Controls

Touch PARENTAL CONTROLS to begin the configuration (page 69).

**1 Follow the instructions on the screen**  
Information about Parental Controls will appear on the screen. Follow the instructions to proceed with configuration.

**2 Enter a four-digit PIN, then touch OK**  
To ensure the information entered is correct, you will be asked to enter your PIN twice.  
**Note:** Your PIN is required to change Parental Controls settings as well as remove them temporarily. Be careful not to forget it.



**3 Select a secret question, then touch OK**



**4 Enter an answer of at least four characters to the secret question, then touch OK**  
**Note:**  
• You must answer the secret question if you forget the PIN. Be careful not to forget your answer.  
• See page 30 for details on using the keyboard.



**5 Touch PARENTAL CONTROLS SETTINGS**



**6 Touch the option you want to configure and follow the instructions on-screen**  
Touch DONE to finish configuring Parental Controls settings.





## Removing Parental Controls Restrictions

Enter the PIN to temporarily remove Parental Controls restrictions, or change the Parental Controls settings in System Settings.

### Temporarily removing Parental Controls restrictions

Select a restricted item. The **PIN Entry Screen** will appear. Enter the PIN and then touch OK.



### Changing settings

#### 1 Touch PARENTAL CONTROLS in System Settings



#### 2 Touch CHANGE

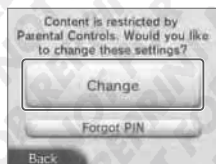

#### 3 Enter the PIN



#### 4 Touch OK

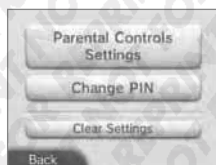

#### 5 Touch the option for the setting you want to change

Touch PARENTAL CONTROLS SETTINGS to change restriction settings, CHANGE PIN to change the PIN or CLEAR SETTINGS to cancel Parental Controls restrictions. Follow the instructions on-screen to proceed.

## If you have forgotten your PIN or secret question answer...

If you have forgotten your PIN or secret question answer, follow the steps below.

#### 1 Touch FORGOT PIN on the first screen that appears after touching PARENTAL CONTROLS in System Settings, or touch I FORGOT on the PIN Entry Screen



#### 2 Enter the answer to your secret question

**Note:** You will then be taken to Parental Controls settings.



## If you have forgotten your secret question answer

#### 3 Touch I FORGOT

#### 4 An enquiry number will be displayed

For further information about obtaining the master key, please contact Nintendo Customer Support by phone or email (pages 109 – 111).  
For detailed information, please refer to the Support section at [support.nintendo.com](http://support.nintendo.com).

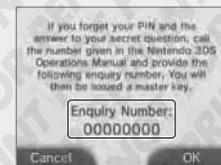

#### 5 Touch OK

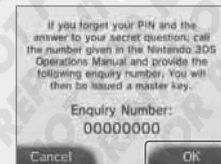

#### 6 Enter the master key, then touch OK

**Note:** You will then be taken to Parental Controls settings.





## Data Management

Check or delete software, data and settings saved to the System Memory or the SD Card.

You can check or delete downloaded software, check or configure software using StreetPass functionality and reset the blocked-user settings. Select DATA MANAGEMENT from System Settings, then select the corresponding option.



<b>Nintendo 3DS Data Management</b>	SOFTWARE	Check or delete Nintendo 3DS download software or Virtual Console software. <b>Note:</b> You can store up to 300 Nintendo 3DS titles on an SD Card.
	EXTRA DATA	Check or delete extra data (e.g. data received via SpotPass) on your Nintendo 3DS XL system.
	ADD-ON CONTENT	Check or delete add-on content (including software update data) downloaded for compatible Nintendo 3DS software.
<b>Nintendo DSiWare Data Management</b>	Check Nintendo DSiWare saved to the System Memory or an SD Card. You can also copy Nintendo DSiWare between the System Memory and an SD Card or delete it. <b>Note:</b> You can store up to 40 Nintendo DSiWare titles in the System Memory.	
<b>StreetPass MANAGEMENT</b>	View a list of software that supports StreetPass. You can also deactivate StreetPass for any software title.	
<b>RESET BLOCKED-USER SETTINGS</b>	Resetting blocked-user settings will remove all previously applied restrictions and allow the receipt of data from all users.	

### Note:

- You can store over 300 pieces of extra data / add-on content on an SD Card, but only the first 300 will be shown in Data Management.
- Nintendo DSiWare cannot be launched from an SD Card. Copy it to the System Memory before playing.
- If you copy a software title to a location where the same software title is already saved, the existing software will be overwritten by the one you are copying. Be careful when copying software in order to avoid overwriting save data.



## Other Settings

Change your user information and configure various other settings.

Touch ◀/▶ at the sides of the screen to change pages.

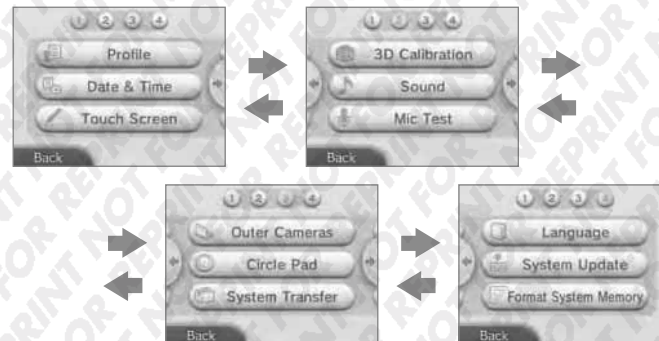

PROFILE	Set your user name, date of birth, region and Nintendo DS profile. <b>Note:</b> Your Nintendo DS profile includes a colour and message that are used in some Nintendo DS and Nintendo DSi software. (Characters that are not supported by Nintendo DS or Nintendo DSi software will be displayed as ?.)
DATE & TIME	Change the date and time.
TOUCH SCREEN	Calibrate the Touch Screen when it is not working properly.
3D CALIBRATION	Calibrate the 3D Screen.
SOUND	Change the speaker sound output settings.
MIC TEST	Check that the microphone is working correctly. If the icon on the lower screen changes colour when you speak or gently blow into the microphone, the microphone is functional.
OUTER CAMERAS	Calibrate the outer cameras (page 84).
CIRCLE PAD	Calibrate the Circle Pad when controls do not seem to operate properly or when in-game movement seems to occur even when not using the Circle Pad.
SYSTEM TRANSFER	Transfer data from your Nintendo DSi or Nintendo DSi XL system to your Nintendo 3DS XL system, or between Nintendo 3DS / Nintendo 3DS XL systems (page 86).
LANGUAGE	Change the language of the system.
SYSTEM UPDATE	Update the system software (page 91).
FORMAT SYSTEM MEMORY	Format the system to erase data stored in the System Memory, such as photographs, software and save data (page 91).

## Outer Cameras

Exposing the Nintendo 3DS XL system to shocks or placing it in hot environments when using the outer cameras can result in poorly focused 3D images. For the best results when using the cameras, follow the steps below.

**Note:** Incorrectly calibrating the cameras can lead to these problems worsening. Recalibrate the cameras whenever necessary.

- 1 Ensure the 3D depth slider is at the top, then touch NEXT

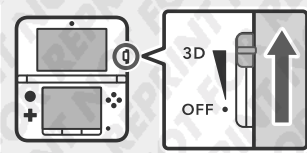

- 2 Touch AUTOMATIC SETUP  
Touch REVERT TO DEFAULT SETTINGS to restore the default settings.



- 3 Touch NEXT to take a photo to be used as the basis of the calibration

Taking care not to have anything in the foreground, choose a bright, outdoor object that is over 20 metres from the Nintendo 3DS XL that fills the screen. Auto-calibration will begin when the three lights  on the upper screen to become lit. Hold the system steady until the auto-calibration process is complete.



The three lights  on the upper screen may not become lit in the following cases.



When contrast levels are low



When objects appear in the foreground

**Note:** There may be other problems in addition to those above that prevent the auto-calibration process from completing. If you experience problems, try using a different object for auto-calibration (for cases where auto-calibration doesn't complete, you can calibrate the cameras manually (page 85)).

**Note:** The auto-calibration process can be completed without taking an ideal photo, but this may result in incorrect calibration. Repeat the auto-calibration process with a different subject if you notice problems with the 3D images.

## Calibrating the Outer Cameras Manually

Vertical axis issues in the 3D images can be corrected using manual calibration. Use this when automatic calibration doesn't correct the issues.

- 1 Ensure the 3D depth slider is at the top, then touch NEXT

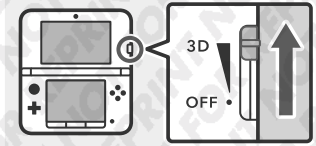

- 2 Touch MANUAL SETUP



- 3 Touch NEXT, then use the L Button or R Button to take a photo of the image you want to use during the calibration

**Note:**

- Place the system on a steady surface, with the image you want to take appearing directly in front and in the centre of the screen.
- Using a simple, yet distinct image like the one shown below, can help the calibration process proceed smoothly.

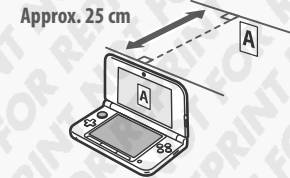

- 4 Adjusting the image on the upper screen to overlap properly

- Adjustments can be made to the vertical axis. The left and right arrows can be used to help align the image properly, but these adjustments will not be saved.
- Even if other objects appearing in the image being used for calibration do not overlap properly, the calibration process will still work.
- Images used for calibration that are taken from above or from an angle might not line up perfectly.

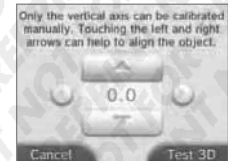

- 5 Touch TEST 3D and follow the on-screen instructions

## System Transfer

Transfer data from your Nintendo DSi or Nintendo DSi XL system to your Nintendo 3DS XL system, or transfer data between Nintendo 3DS / Nintendo 3DS XL systems.

### Note:

- You will need to be connected to the internet to transfer data. The systems will also connect to each other via Local Play. It is recommended that both systems be placed close together in an area with stable internet access (page 76).
- To prevent the systems from running out of power during the transfer, ensure that the battery on each system is well charged, or plug in the AC adapter before starting the transfer. If the battery charge is too low, you will not be able to transfer data.
- Closing your Nintendo 3DS XL system at this time will not activate Sleep Mode. Additionally, please do not turn the power off while data transfer is taking place.

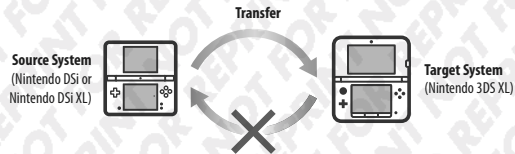

Transfer Nintendo DSiWare and photos / recordings from a Nintendo DSi / Nintendo DSi XL system to a Nintendo 3DS XL system.

Transfer from a Nintendo DSi System

**Note:** You cannot transfer from a Nintendo 3DS XL system to a Nintendo DSi or Nintendo DSi XL system. Also, be aware that once a transfer has been performed, it cannot be undone.

### Download the Transfer Tool

In order to transfer data from a previous system (Nintendo DSi or Nintendo DSi XL) to your Nintendo 3DS XL system, you first need to download the free Nintendo 3DS System Transfer tool from the Nintendo DSi Shop on the previous system.

**Note:** For more information on the Nintendo DSi Shop, please refer to your Nintendo DSi or Nintendo DSi XL Operations Manual.



Transfer between Nintendo 3DS Systems

Transfer save data for built-in applications, Nintendo eShop balance / account activity etc. between Nintendo 3DS / Nintendo 3DS XL systems.

### Note:

- All data on the source system is transferred to the target system. You cannot choose individual items to transfer between Nintendo 3DS / Nintendo 3DS XL systems.
- You can transfer Nintendo 3DS / Nintendo 3DS XL system data a maximum of five times. The remaining available transfers will be displayed before the transfer begins.
- Even if individual software/settings on the system are changed between transfers (e.g. you download new software from Nintendo eShop), the transfer count will not be reset.

## Nintendo DSi / Nintendo DSi XL → Nintendo 3DS XL Transfer

The following data can be transferred.

Nintendo Wi-Fi Connection Configuration	Transfers Internet Settings (Nintendo DS Connections) and Nintendo Wi-Fi Connection ID.
Photos & Recordings	Transfers photos and recordings from the Nintendo DSi Camera and Nintendo DSi Sound software pre-installed on the Nintendo DSi or Nintendo DSi XL system.
Nintendo DSiWare	Transfers Nintendo DSiWare.

### Precautions for Transferring Nintendo Wi-Fi Connection Configuration

- The Nintendo Wi-Fi Connection Configuration on the Nintendo 3DS XL system that you want to transfer the data onto will be overwritten.
- Your Nintendo Wi-Fi Connection ID will be deleted from the source system during transfer. For more information about your Nintendo Wi-Fi Connection ID, please refer to your Nintendo DSi or Nintendo DSi XL Operations Manual.
- Settings for Advanced Setup (connections 4 – 6) will not be transferred.

### Precautions for Transferring Photos & Recordings

All the photos and recordings saved to the System Memory of the Nintendo 3DS XL system will be deleted. If you do not want any of the photos and recordings on your Nintendo 3DS XL to be deleted, copy them onto an SD Card before carrying out the transfer.



#### If There Are Photos & Recordings in the System Memory of the Nintendo 3DS XL System

Copy any photos and recordings from the System Memory to an SD Card before performing the transfer.

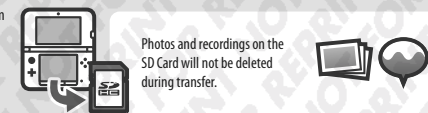

**Note:** If you want to transfer photos which you have saved to an SD Card being used with the source system, you will first need to copy them to the System Memory of the source system.

## Precautions for Transferring Nintendo DSiWare

Only the software itself will be transferred to the target system. Save data is not transferred. Both the software and the save data will be deleted from the source system. Please be sure that it is OK to have your save data deleted before you start the transfer process.



**Note:** The data will be saved on the System Memory of the target system. If there is not enough space in the target system's System Memory, you will not be able to transfer data. To free up space, go to Data Management in the System Settings to copy any Nintendo DSiWare already saved on the system to the SD Card and delete them from the System Memory (page 82).

## If purchased Nintendo DSiWare has been deleted or copied to an SD Card

If you have purchased any Nintendo DSiWare titles that have subsequently been deleted or copied to an SD Card, you can still transfer the software even though it is no longer in the System Memory of the source system. For such software, the actual software will not be transferred to the target system, but it will be downloadable from the Nintendo eShop at no extra cost.

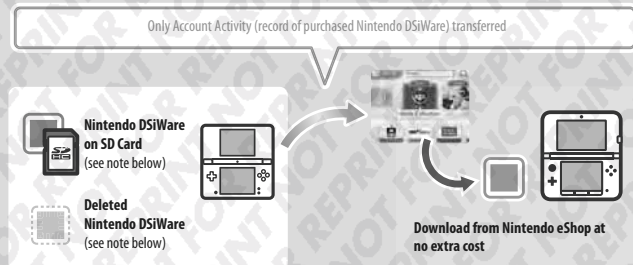

**Note:** In order to play Nintendo DSiWare titles on the source Nintendo DSi system after they have been transferred, you will need to use Nintendo DSi Points to purchase them again.

### Note:

- Nintendo DSiWare that is free or is not available on Nintendo eShop cannot be transferred. For details on Nintendo DSiWare that cannot be transferred, visit the Nintendo website.
- You cannot transfer Nintendo DSi Points or any software that was pre-installed on the source Nintendo DSi or Nintendo DSi XL system.
- Software that already exists on the target system will not be transferred.

## Nintendo 3DS / Nintendo 3DS XL → Nintendo 3DS / Nintendo 3DS XL Transfer

All of the following data is transferred.

Nintendo DS Software Settings	Transfers Internet Settings (Nintendo DS Connections) and Nintendo Wi-Fi Connection ID.
Pre-installed Application Save Data	Transfers data such as the friend list, Nintendo 3DS Camera photos, Nintendo 3DS Sound recordings and Mii Maker Mii characters from the pre-installed applications on the Nintendo 3DS / Nintendo 3DS XL system.
Nintendo DSiWare	Transfers Nintendo DSiWare (and its save data) stored on the System Memory.
SD Card Data Usage Rights	Transfers usage rights for data stored on the SD Card (e.g. download software and its save data, add-on content, etc.). The SD Card can then be used with the target system.
Nintendo eShop Account Activity / Balance	Transfers your Nintendo eShop account activity and balance to the target system. This will be merged with that of the target system.

## Precautions for Transferring

After transferring data, all data on the source system will be deleted. The SD Card from the source system will be usable only with the target system.

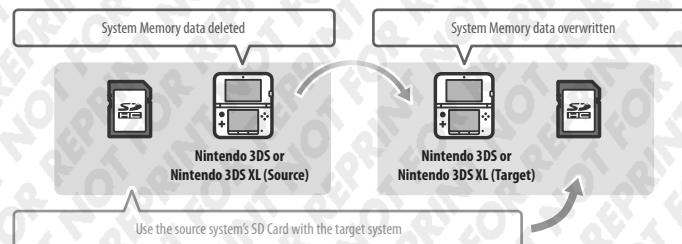

**Note:** With the exception of Nintendo DSiWare, the data in the target system's System Memory (e.g. pre-installed application save data) will be deleted and overwritten with the data from the source system. If you have data such as photos and recordings, copy these to an SD Card first.

## Download Software Precautions

- Data stored on the target system's SD Card, such as Nintendo 3DS download software and its save data, will not be usable after the transfer. The software can be re-downloaded from Nintendo eShop.
- Nintendo DSiWare and its save data on the target system's SD Card should be moved to the target system's System Memory before the transfer. It will then remain usable after the transfer.
- If the same download software has been downloaded on both systems, its data on the target system's Account Activity will be deleted and replaced with the data from the source system. Also, the old save data on the target system (and / or SD Card) will no longer be usable.

## Nintendo eShop Balance Precautions

If the total Nintendo eShop balance of the source and target systems exceeds the maximum allowed funds, the system transfer will not proceed.

## Nintendo DSi → Nintendo 3DS XL

**1** On the Nintendo 3DS XL System  
Touch **TRANSFER FROM A NINTENDO DSi SYSTEM**

Read the warning message about transferring data, then touch NEXT.



**2** Touch **RECEIVE FROM A NINTENDO DSi SYSTEM**

Follow the on-screen instructions to proceed.

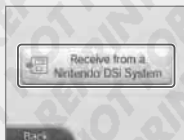

**3** On the Nintendo DSi / Nintendo DSi XL System  
Select the **Nintendo 3DS Transfer Tool** icon on the Nintendo DSi Menu

Follow the on-screen instructions to proceed.



## Nintendo 3DS / Nintendo 3DS XL → Nintendo 3DS / Nintendo 3DS XL

**1** Source / Target Systems  
Touch **TRANSFER BETWEEN NINTENDO 3DS SYSTEMS**

Read the warning message about transferring data, then touch I AGREE.



**2** Source System  
Touch **SEND FROM THIS SYSTEM**  
Target System  
Touch **RECEIVE FROM A NINTENDO 3DS SYSTEM**

Follow the on-screen instructions to proceed.

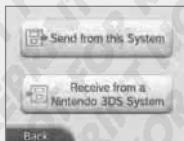

## System Update

Update the **HOME Menu** and applications, and add new applications.

You must be connected to the internet to perform system updates. Configure your internet connection settings before using system update (page 70). (When performing a system update from a Game Card, an internet connection is not necessary.)

**Note:** System updates cannot be carried out if the battery charge is running low.

## REGARDING SYSTEM UPDATES

**IMPORTANT:** After the Nintendo 3DS XL system is updated, any existing or future unauthorised technical modification of the hardware or software of your Nintendo 3DS XL system, or use of an unauthorised device in connection with your system, may render the system permanently unplayable. Content deriving from the unauthorised modification of the hardware or software of your Nintendo 3DS XL system may be removed. Failure to accept the update may render games unplayable.

## REGARDING AUTOMATIC SYSTEM UPDATES

From time to time, the Nintendo 3DS XL system will carry out automatic updates, such as updates to a list which prevents the use of words that may cause users discomfort, and / or updates to an internal database of wireless access points which allow you to access online services provided by Nintendo.

No prior notice for these or other such minor automatic updates will be displayed on the screen. For other system updates, a notice will be displayed on the screen, and you will need to select I ACCEPT to install such updates.

## Format System Memory

Select this option to delete all data saved to the system, and return it to factory settings.

**Note:** The system version will remain at the current version even if you format the System Memory.

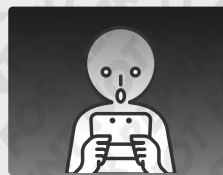

If you opt to format your system, the following data will be deleted and cannot be recovered:

- Content saved in the System Memory such as friend list, notification and step data
- Application save data
- All photos saved to the System Memory
- Changes made to the System Settings
- Software saved to the system (see first note below) and its save data
- Software saved to the SD Card (see first note below) and its save data (if an SD Card that contains software or save data is not inserted when the formatting occurs, the data on that SD Card will not be deleted but it will become unusable.)

**Note:**

- Software can be redownloaded from Nintendo eShop at no extra cost. Please note that there are certain cases where software may be temporarily or permanently withdrawn from Nintendo eShop. Should this happen, you will no longer be able to redownload that software.
- When you format the System Memory, photos and recordings on the SD Card and your Nintendo eShop Account Activity and balance will not be deleted. When giving your Nintendo 3DS XL system to another person permanently, please ensure you delete your Account Activity in Nintendo eShop and use a computer to delete data on the SD Card.

## Replacing the Nintendo 3DS XL Battery Pack

Repeated charging will decrease battery life and reduce the length of time you can use the system before recharging. If usage time is noticeably reduced, replace the battery pack using the procedure detailed below.

Please contact Nintendo Customer Support for further information on where to purchase a replacement (pages 109 – 111).

### Replacing the Nintendo 3DS XL Battery Pack

- If the system is used by a young child, a parent or legal guardian should replace the battery pack for them.
- Always turn the power off and disconnect the AC adapter before replacing the battery pack.

#### 1 Unscrew the battery cover

Use a screwdriver to loosen the two screws securing the battery cover.

**Note:** Using the wrong type of screwdriver may damage the head of the screw, leaving you unable to remove the battery cover.

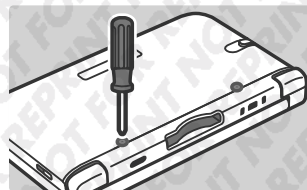

#### 2 Release the four clasps on the sides

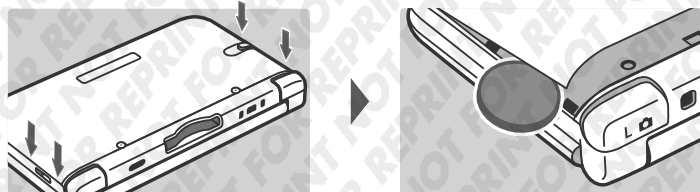

Slide a coin or similar item in between the battery cover and the system, and prise the two carefully apart.

**Note:**

- Do not insert your fingernails in between the battery cover and the system, as this could result in injury.
- Do not use excessive force, as this could result in damage to your Nintendo 3DS XL system and/or to the battery cover.

#### 3 Remove the battery cover and battery pack

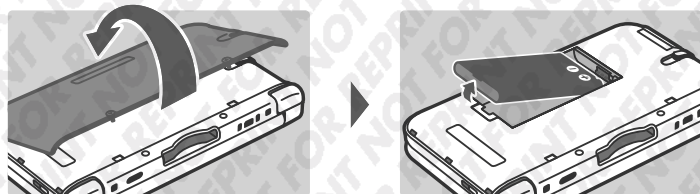

Remove the battery pack as shown.

#### 4 Wait at least 10 seconds, then insert a new battery pack

Insert the new battery pack as shown.

**Note:**

- Ensure that the battery is facing in the right direction.
- Inserting the new battery pack immediately after removing the old one can result in the power LED not functioning correctly.

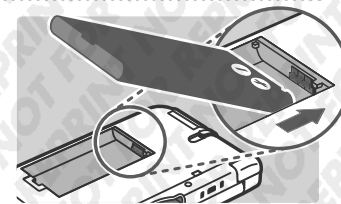

#### 5 Replace the battery cover, and tighten the two screws

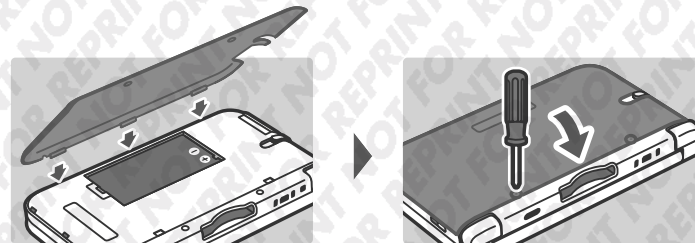

- When replacing the battery cover, apply pressure until the four clasps on the sides click firmly into place.
- After removing the battery, the date and time settings will be reset. You should set them again by opening System Settings from the HOME Menu, selecting OTHER SETTINGS and then DATE & TIME.

**Note:** Always replace the battery cover. If the system is subjected to a shock while the cover is off, the battery could be damaged leading to fire or explosion.

#### Battery Disposal

- Apply some tape over the positive (+) and negative (-) connectors.
- Do not remove the label.
- Do not attempt to disassemble the battery pack.
- Do not damage the battery.

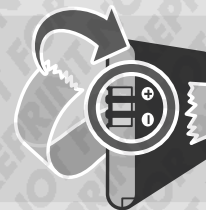

The Nintendo 3DS XL system contains a lithium-ion rechargeable battery pack. Please dispose of this product in accordance with local regulations.

- Discarding batteries in your general household waste can be harmful to the environment. When disposing of the battery pack, follow appropriate local guidelines and regulations.
- In accordance with the Directive on Batteries and Accumulators and Waste Batteries and Accumulators (2006/66/EC), battery collection and recycling schemes should be in place in all EU Member States.

## Troubleshooting

Before contacting Nintendo Customer Support, please use this section of the manual to determine the cause of the problem.



**Note:** If the problem involves a game or accessory, please also refer to the corresponding manual / documentation.

Problem	Solution
<p><b>I can't recharge the Nintendo 3DS XL Battery Pack / The recharge LED is not lit</b></p>	<ul style="list-style-type: none"> <li>Are you using a Nintendo 3DS AC adapter?</li> <li>Use the Nintendo 3DS AC adapter (WAP-002(UKV)/WAP-002(EUR)) (sold separately). The Nintendo DSi Power Supply is also compatible.</li> <li>Is the Nintendo 3DS AC adapter firmly inserted into the system and a plug socket?</li> <li>Unplug the AC adapter and wait approximately 30 seconds before plugging it in again. Make sure the AC adapter is securely connected to both the Nintendo 3DS XL system and the plug socket.</li> <li>Is the battery pack being recharged in a location with an ambient temperature between 5 – 35° C?</li> <li>Recharge the battery pack in a location with an ambient temperature between 5 – 35° C. You may not be able to recharge the battery pack in a location outside of this temperature range.</li> <li>Is the battery pack connected properly?</li> <li>If the system won't turn on and, when you plug in the AC adapter, the recharge LED lights up then immediately turns dark, the battery pack may not be connected correctly. Make sure that the battery pack is connected properly (page 92).</li> <li>Is the recharge LED lit?</li> <li>If the recharge LED is blinking, there is a chance that the battery pack is not connected properly. If you experience this, contact Nintendo Customer Support (pages 109 – 111).</li> </ul>
<p><b>The Nintendo 3DS XL system will not turn on</b></p>	<ul style="list-style-type: none"> <li>Is the battery pack connected properly?</li> <li>If the system won't turn on and, when you plug in the AC adapter, the recharge LED lights up then immediately turns dark, the battery pack may not be connected correctly. Make sure that the battery pack is connected properly (page 92).</li> </ul>
<p><b>The Nintendo 3DS XL system is hot</b></p>	<ul style="list-style-type: none"> <li>Is the battery pack being charged in an area with a high temperature, or being charged for extended periods of time?</li> <li>Doing so can lead to the system temperature rising sharply. Charge the battery pack in a location with an ambient temperature between 5 – 35° C. Touching the system while it is hot may cause burns.</li> </ul>
<p><b>I charged the Nintendo 3DS XL Battery Pack, but I can't play for long periods of time / It takes a long time to charge the battery pack</b></p>	<ul style="list-style-type: none"> <li>Are you playing a game or recharging the battery pack in a location with an ambient temperature less than 5° C?</li> <li>In environments with a temperature less than 5° C, you will not be able to play games for long periods of time, and the battery pack will take longer than usual to recharge.</li> </ul> <p><b>Battery Life</b> Repeated charging will decrease battery life, reducing the length of time you can use the system. If usage time is noticeably reduced, replace the battery pack. Contact Nintendo Customer Support for further information on where to purchase a replacement (pages 109 – 111).</p>

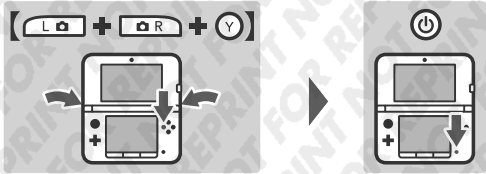
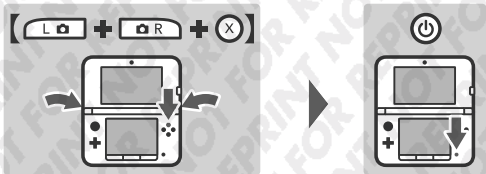

Problem	Solution
<p><b>The battery pack has expanded</b></p>	<ul style="list-style-type: none"> <li>Lithium-ion batteries are subject to degradation over time and can expand through repeated recharging. This is not a malfunction or a potential safety hazard. Please replace the battery pack if its expansion is affecting battery life (page 92).</li> <li>If the battery pack leaks, do not touch it and contact Nintendo Customer Support (pages 109 – 111).</li> </ul>
<p><b>There is no video or audio output</b></p>	<ul style="list-style-type: none"> <li>Is the power LED lit?</li> <li>Press the POWER Button to turn the power on.</li> <li>Has the system been charged?</li> <li>Recharge the system.</li> <li>Has the Game Card been correctly inserted?</li> <li>Insert the Game Card gently but firmly until it clicks into place.</li> <li>Is the system in Sleep Mode?</li> <li>If the system is in this state, exit Sleep Mode. For more information on how to exit Sleep Mode, refer to the manual of the software title you are using.</li> </ul>
<p><b>There are black or bright dots on the LCD screens that do not go away / There are dark or light patches on the LCD screens</b></p>	<ul style="list-style-type: none"> <li>Small numbers of stuck or dead pixels are a characteristic of LCD screens. These are normal and should not be considered as a defect. The 3D Screen and Touch Screen have different specifications, so their colour displays and levels of brightness may differ.</li> </ul>
<p><b>The brightness differs between LCD screens</b></p>	<ul style="list-style-type: none"> <li>The technical specifications of the upper and lower screens are different, which means their brightness levels can also be different. This is normal and should not be considered as a defect.</li> </ul>
<p><b>The screen hue changes suddenly The brightness changes and it becomes difficult to see bright colours</b></p>	<ul style="list-style-type: none"> <li>Is power-saving mode on?</li> <li>Power-saving mode changes the brightness and colour gradient automatically according to the content being displayed, to extend the battery charges for longer periods of time. This can lead to pale colours whitening and other colours changing. To maintain fixed colour and brightness level, turn power-saving mode off (page 40).</li> </ul>
<p><b>3D images cannot be seen or are difficult to see</b></p>	<ul style="list-style-type: none"> <li>Are you using Nintendo DS / Nintendo DSi software?</li> <li>Nintendo DS / Nintendo DSi software titles cannot display 3D content.</li> <li>Does the content you are viewing support the 3D feature?</li> <li>Some software and types of content do not support the display of 3D images. Try viewing 3D images in a different Nintendo 3DS software title.</li> <li>Is the 3D depth slider set to the lowest level?</li> <li>Adjust the 3D depth slider to a level that is comfortable for you (page 33).</li> <li>Is the 3D Screen properly calibrated?</li> <li>Hold the 3D Screen 30 – 40 cm away from your eyes (page 32). (If there is any difference in vision between your left and right eyes, or if you tend to see using only one eye, the 3D effects may not work properly or at all. For users with any difference in vision between their left and right eyes, it is advised that you correct your vision before use, for example using spectacles.)</li> <li>Is the 3D Screen dirty?</li> <li>If there are fingerprints or other marks on the screen, wipe it using a soft, clean cloth.</li> </ul>







Problem	Solution
<p><b>3D images cannot be seen or are difficult to see</b></p>	<ul style="list-style-type: none"> <li>Have you attached a commercially available protective sheet to the 3D Screen?</li> <li>Certain products can obscure the clarity of 3D images. Please make sure you only use a protective sheet that has been licensed by Nintendo. Refer to the instruction information that comes with the product for details on how to apply.</li> <li>Are you in direct sunlight or an area with a strong light source?</li> <li>Using the system in areas with strong light sources can cause the light to reflect on the screen, rendering it difficult to see.</li> <li>Are Parental Controls configured?</li> <li>Disable the Parental Controls item which restricts the display of 3D images (page 80).</li> <li>Are you looking at the lower screen?</li> <li>This screen cannot display 3D content.</li> </ul> <p>The 3D effects generated by the Nintendo 3DS XL are created using the binocular disparity of the eyes. Everyone will have a different way of viewing 3D images. If you see a double image or are unable to see 3D images even when viewing them correctly and with the proper settings, please use the 2D display only (page 33).</p>
<p><b>The Circle Pad doesn't work properly</b></p>	<ul style="list-style-type: none"> <li>Does Circle Pad input match what you see on screen?</li> <li>In rare cases, the Circle Pad's input may stop working properly after long periods of use or being used forcefully. If the in-game movements do not match the Circle Pad input, use the CIRCLE PAD option in System Settings to calibrate the input (page 69).</li> </ul> <p><b>Note:</b> If movements are being input despite the Circle Pad not being used, and you are unable to use the buttons or Touch Screen, turn the system off, then start it again on the <b>Circle Pad Calibration Screen</b> by pressing the POWER Button while pressing and holding L Button + R Button + Y Button.</p> 
<p><b>The Touch Screen doesn't work properly</b></p>	<ul style="list-style-type: none"> <li>Does the Touch Screen input match what you see on screen?</li> <li>If the in-game movements do not match the Touch Screen input, use the TOUCH SCREEN option in System Settings to calibrate the input (page 69).</li> </ul> <p><b>Note:</b> If you are unable to use the Touch Screen to perform this procedure, turn the system off, then start it again on the <b>Touch Screen Calibration Screen</b> by pressing the POWER Button while pressing and holding L Button + R Button + X Button.</p> 

Problem	Solution
<p><b>The Touch Screen doesn't work properly</b></p>	<ul style="list-style-type: none"> <li>Have you attached a commercially available protective sheet to the Touch Screen?</li> <li>If you have applied a commercially available protective sheet to the Touch Screen, refer to its instruction manual and be sure it has been applied correctly before attempting to calibrate the Touch Screen. Please make sure you only use a protective sheet that has been licensed by Nintendo.</li> </ul> 
<p><b>When playing a game that requires you to move the system, the game responds when the system is not being moved or the game doesn't respond correctly to the movements</b></p>	<ul style="list-style-type: none"> <li>The built-in motion sensor may be producing incorrect input.</li> <li>If the system is subjected to sudden changes in temperature or physical shocks, the sensor can start to produce false responses. In these cases, carry out the following steps to recalibrate the sensor.</li> </ul> <p>On the <b>HOME Menu</b>, press and hold the Y Button and B Button for 3 seconds to open the <b>Motion Sensor Calibration Screen</b>. Place the system on a level surface and touch <b>CALIBRATE</b> or <b>REVERT TO DEFAULT SETTINGS</b>.</p>  <p><b>Press and hold Y Button and B Button for 3 seconds</b></p> <p><b>Place the system on a level surface and touch CALIBRATE</b></p> <p><b>Note:</b> When CALIBRATE is touched, the system will consider the position it is in to be level. The settings for the motion sensor will be adjusted accordingly.</p>
<p><b>The screen goes completely black and the system won't respond / The system freezes up</b></p>	<ul style="list-style-type: none"> <li>If the screen stays black when you turn the system on or when you exit Sleep Mode (reopen the system after closing it while the power is on), or the screen suddenly goes black during gameplay and the system stops responding, turn the system off by holding the POWER Button down until the Power LED goes out, then press the POWER Button again to turn the system back on.</li> </ul>
<p><b>No sound from the speakers</b></p>	<ul style="list-style-type: none"> <li>Is the volume set to the lowest level?</li> <li>Try adjusting the volume by using the volume control on the side of the system.</li> <li>Are headphones connected?</li> <li>If headphones are attached to the Nintendo 3DS XL, no sound will come through the speakers.</li> </ul> <p><b>Note:</b> The camera's shutter sound will always be played at a fixed volume, regardless of the current setting of the volume control and even if headphones are connected.</p>
<p><b>No audio from headphones</b></p>	<ul style="list-style-type: none"> <li>Is the volume set to the lowest level?</li> <li>Try adjusting the volume by using the volume control on the side of the system.</li> <li>Is the plug of the headphones firmly inserted?</li> <li>Make sure the plug of the headphones is securely plugged into the audio jack.</li> </ul>

Problem	Solution
<b>I can't use the microphone / My voice isn't recognised</b>	<ul style="list-style-type: none"> <li>• Does this software title or section of it use the microphone?                             <ul style="list-style-type: none"> <li>➤ The microphone is only usable in software titles or sections of software titles that support it.</li> </ul> </li> <li>• Is the microphone working properly?                             <ul style="list-style-type: none"> <li>➤ Select MIC TEST in System Settings to confirm that the microphone is functioning properly (page 69).</li> </ul> </li> <li>• Are voices other than your own, such as those of family and friends, recognised correctly?                             <ul style="list-style-type: none"> <li>➤ There are individual differences in speech recognition rates. Some voices are more difficult to recognise than others.</li> </ul> </li> <li>• Is a headset with microphone attached?                             <ul style="list-style-type: none"> <li>➤ Try removing the headset with microphone and using the system microphone instead.</li> </ul> </li> </ul>
<b>The microphone reacts unexpectedly / There is feedback* coming from the speakers</b>	<ul style="list-style-type: none"> <li>• Is the system being used in a noisy environment, or in a place where the volume is very high?                             <ul style="list-style-type: none"> <li>➤ The microphone may be reacting to audio output from the speaker or ambient noise. Try to move away from the source of the noise, reduce the speaker volume, use headphones or try to prevent any background noises.</li> </ul> </li> </ul> <p><b>* What is "feedback"?</b>                      Feedback is the term used to refer to the high-pitched screeching sound caused by a loop being created when sounds picked up by the microphone are played back through the speakers and are then picked up again by the microphone.</p> <ul style="list-style-type: none"> <li>• Is a headset with microphone attached?                             <ul style="list-style-type: none"> <li>➤ Headsets with microphones can sometimes cause feedback. Try removing the headset with microphone.</li> </ul> </li> </ul>
<b>My steps aren't being counted</b>	<ul style="list-style-type: none"> <li>• Is the Nintendo 3DS XL system open?                             <ul style="list-style-type: none"> <li>➤ Your steps will only be counted if the power to the system is on and it is closed.</li> </ul> </li> <li>• Is the system in a loosely-hanging bag, or is it hanging from a wrist strap?                             <ul style="list-style-type: none"> <li>➤ There may be cases where the system cannot correctly count your steps. If it is put in a loosely-hanging bag while walking, step data may not be counted accurately. If you want to put the system in a bag while carrying it around, use a tight-fitting bag such as a belt pouch.</li> </ul> </li> </ul> <p><b>Note:</b></p> <ul style="list-style-type: none"> <li>• Depending on the conditions, the step count might be higher or lower than the number of actual steps taken.</li> <li>• Do not put the system into your back pocket. Subjecting the system and LCD screens to excessive force, for example sitting on them, can damage them and lead to injury or malfunction.</li> </ul> <ul style="list-style-type: none"> <li>• Are you continuing to use the system while a Nintendo DS / Nintendo DSi software title is in use?                             <ul style="list-style-type: none"> <li>➤ If Nintendo DS / Nintendo DSi software titles aren't closed for a period of, or exceeding, seven consecutive days, only steps for the initial seven days will be recorded. After saving your game, turn the software off.</li> </ul> </li> </ul>

Problem	Solution
<b>My SD Card is not responding</b>	<ul style="list-style-type: none"> <li>• Has the SD Card been correctly inserted into the system?                             <ul style="list-style-type: none"> <li>➤ Insert the SD Card gently but firmly until it clicks into place in the SD Card slot on the side of the system (page 34).</li> </ul> </li> <li>• Is the SD Card broken?                             <ul style="list-style-type: none"> <li>➤ Use a computer or digital camera to confirm that you can correctly see files on the SD Card.</li> </ul> </li> </ul>
<b>I can't view the photos stored on the SD Card</b>	<ul style="list-style-type: none"> <li>• Are there photos on the SD Card that can be displayed using Nintendo 3DS Camera?                             <ul style="list-style-type: none"> <li>➤ Nintendo 3DS Camera can only display photos taken on the Nintendo 3DS XL system. Photos taken on a digital camera or mobile phone cannot be displayed.</li> </ul> </li> </ul>
<b>Even though a Game Card has been inserted, the icon for the software title does not appear and the HOME Menu displays: "There is nothing inserted into the Game Card slot."</b>	<ul style="list-style-type: none"> <li>• Is the Game Card inserted properly?                             <ul style="list-style-type: none"> <li>➤ Remove the Game Card and properly reinsert it until it clicks into place. If this doesn't work, try reinserting it a few more times (page 45).</li> </ul> </li> <li>• Are you using a software title from a different region?                             <ul style="list-style-type: none"> <li>➤ Only Nintendo 3DS and Nintendo DSi software titles matching the region of the system will work. Software titles from different regions may not function.</li> </ul> </li> </ul>
<b>I can't play my game</b>	<ul style="list-style-type: none"> <li>• Are Parental Controls set to restrict the use of software based software ratings?                             <ul style="list-style-type: none"> <li>➤ Enter the PIN and disable Parental Controls temporarily, or disable the Parental Controls option that restricts the use of software based on software ratings (page 80).</li> </ul> </li> </ul>
<b>This message appears while playing Nintendo DS / Nintendo DSi software: "An error has occurred. Press and hold the POWER Button to turn the system off. Please refer to the Operations Manual for details."</b>	<ul style="list-style-type: none"> <li>➤ Turn off the power, then turn it back on and try again, carrying out the same procedure as before. If the error message still appears, there may be a fault with your system. Please contact the Nintendo Customer Support for assistance (pages 109 – 111).</li> </ul>
<b>My system suddenly enters Sleep Mode</b>	<ul style="list-style-type: none"> <li>➤ It may have entered Sleep Mode as the result of an external magnetic field. Move your system away from magnetic objects, including other Nintendo 3DS / Nintendo 3DS XL systems.</li> </ul> <p><b>Note:</b> Stacking this system on top of other Nintendo DS systems may also result in the system entering Sleep Mode.</p> 
<b>I am having difficulty using wireless communications (communications are interrupted and the game cannot be played smoothly)</b>	<ul style="list-style-type: none"> <li>• Is one of the following signal strength icons  or  shown on screen?                             <ul style="list-style-type: none"> <li>➤ Signal strength appears to be poor. Move closer to the other player(s), and remove obstructions between the systems.</li> </ul> </li> </ul>

Problem	Solution
I can't disable Parental Controls	<ul style="list-style-type: none"> <li>• Did you enter the correct PIN? ➤ Enter the correct PIN (if you have forgotten your PIN, see page 81).</li> <li>• Did you enter the correct answer to your secret question? ➤ Enter the correct answer to your secret question (if you have also forgotten the answer to your secret question, see page 81).</li> </ul>
Photos taken by the camera have strange colours	<ul style="list-style-type: none"> <li>• Have you changed the colour settings in Nintendo 3DS Camera? ➤ Check the camera mode and / or Manual Settings in Nintendo 3DS Camera (page 58).</li> <li>• Photo results can differ depending on your surroundings, particularly if taking pictures in dimly-lit areas where the screen is filled with similarly-coloured objects. ➤ Try to take a picture of something else. If the colours are still strange, contact the Nintendo Customer Support (pages 109 – 111).</li> </ul>
Nintendo 3DS Camera repeatedly asks for a photo of my face, but does not respond	<p>➤ This occurs when your face cannot be recognised properly. Please take note of the following factors which may affect facial recognition.</p> <div style="border: 1px solid black; padding: 5px; margin: 10px 0;"> <p><b>Facial recognition hints</b> To improve the chances of your face being recognised, follow the advice below.</p> <div style="display: flex; justify-content: space-around;"> <div style="text-align: center;">  <p>Move to a well-lit area</p> </div> <div style="text-align: center;">  <p>Face the camera straight on</p> </div> </div> <div style="display: flex; justify-content: space-around;"> <div style="text-align: center;">  <p>Move hair to fully reveal your face</p> </div> <div style="text-align: center;">  <p>Remove your glasses</p> </div> </div> </div> <p>Other factors, such as hairstyle, the colour, shape and volume of facial hair, and jewellery, also affect successful facial recognition. <b>Note:</b> Even taking the aforementioned factors into account, individual features and certain environments can make accurate recognition difficult.</p>
3D images from the outer cameras aren't in 3D or are difficult to see	<ul style="list-style-type: none"> <li>• Are you using the inner camera? ➤ The inner camera cannot produce 3D images.</li> <li>• Are the outer cameras dirty? ➤ If the outer cameras are dirty, wipe them with a soft cloth.</li> <li>• Are the outer cameras in direct sunlight or in the direct path of other strong light sources? ➤ This can cause the 3D images to become distorted and difficult to see.</li> <li>• The outer cameras might not be calibrated properly. ➤ Subjecting the Nintendo 3DS XL system to excessive physical shock, or exposing it to high temperatures can cause the outer cameras to display unclear 3D images. If you notice such a problem, recalibrate the outer cameras in System Settings (page 84).</li> </ul>

Problem	Solution
Nintendo 3DS Sound does not display audio files and folders	<ul style="list-style-type: none"> <li>• Has the SD Card been correctly inserted into the system? ➤ Insert the SD Card gently but firmly until it clicks into place in the SD Card slot on the side of the system.</li> <li>• Does the SD Card contain saved audio files that can be played using Nintendo 3DS Sound? ➤ Nintendo 3DS Sound can play AAC files with a file extension of .m4a, .mp4 and .3gp, or MP3 files with a file extension of .mp3. Other audio files, such as copy-protected ones, cannot be played back.</li> <li>• Are the audio files saved to the "Private" folder found in the "Nintendo 3DS" folder on the SD Card? ➤ Audio files saved to the "Private" folder found in the "Nintendo 3DS" folder will not be displayed in Nintendo 3DS Sound. Files should be saved to a different folder.</li> <li>• Are there more than 3,000 audio files saved? ➤ No more than 3,000 audio files can be displayed.</li> <li>• Are there more than 1,000 folders with saved audio files? ➤ No more than 1,000 folders can be displayed.</li> <li>• Are there more than 100 audio files saved in a single folder? ➤ No more than 100 files can be displayed for a single folder. If there are folders with the same name on the SD Card, the audio files in those folders will be consolidated and displayed as a single folder. No more than 100 files can be displayed for this single consolidated folder.</li> <li>• Are audio files saved to a folder that is more than eight levels deep? ➤ Nintendo 3DS Sound will only check for files up to eight directories deep.</li> </ul>
I can't play back audio files using Nintendo 3DS Sound	<ul style="list-style-type: none"> <li>• Are the audio files in a format that can be played by Nintendo 3DS Sound? ➤ Nintendo 3DS Sound can play audio files which meet the following requirements: <ul style="list-style-type: none"> <li>• <b>File format:</b> AAC (.m4a, .mp4 or .3gp), MP3 (.mp3)</li> <li>• <b>Bit rate:</b> 16 – 320 kbps</li> <li>• <b>Sampling rate:</b> 32 kHz – 48 kHz</li> </ul> </li> <li>• Are the audio files protected by DRM (Digital Rights Management)? ➤ DRM-protected audio files cannot be played using Nintendo 3DS Sound.</li> </ul>

Problem	Solution
<p><b>The system doesn't recognise my AR Cards / I lost my AR Cards</b></p>	<p>➔ <b>If your AR Card cannot be recognised...</b> Check the following and try again.</p> <ul style="list-style-type: none"> <li>• AR Cards cannot be recognised if you hold the system too close to them or too far away.</li> <li>• Ensure that the whole AR Card is visible on the screen. If part of it is off the screen, it may not be recognised.</li> <li>• Ensure you are in a well-lit area.</li> <li>• Keep AR Cards out of direct sunlight, as this can interfere with the outer cameras' ability to recognise them properly.</li> <li>• If an outer camera is dirty, wipe it with a soft cloth before you begin.</li> <li>• If the AR Cards are bent or folded, they cannot be recognised by the system. Ensure that any AR Cards in use are flat on the surface.</li> </ul> <p>➔ <b>If your AR Card still cannot be recognised, or you have lost an AR Card...</b> You can download AR Card images from <a href="http://support.nintendo.com">support.nintendo.com</a>. Print out these images in colour and use them as replacements.</p>
<p><b>I can't use Download Play</b></p>	<ul style="list-style-type: none"> <li>• Have Parental Controls restricted the use of software based on software ratings, or restricted the use of DS Download Play?</li> <li>➔ If you are having issues with Nintendo 3DS software titles, disable the Parental Controls option which restricts the use of software by software rating (page 80).</li> <li>➔ If you are having issues with Nintendo DS / Nintendo DSi software titles, disable the Parental Controls option which restricts DS Download Play (page 80).</li> </ul>

### If you need further help...

If your Nintendo 3DS XL still does not operate correctly after trying these troubleshooting steps, we recommend to call Nintendo Customer Support for assistance and additional troubleshooting and repair options (pages 109 – 111).

- Please note that if you return the console to the retailer and the retailer offers to exchange your console, you may eventually lose save data and all Nintendo eShop downloads and account balance.

### Disposal of this product at the end of its life

At the end of this product's life, please do not dispose of this product in your general household waste. Instead, please dispose of this product separately in accordance with your local recycling laws and regulations. For more information on the separate collection systems for waste electrical and electronic equipment that are available for consumers, free of charge, near your home, please contact your local municipal authority.

As an alternative and if you plan to buy an equivalent new product, you may be able to bring this product to your local retailer who, in exchange for your buying an equivalent new product, may take back this product and arrange for its recycling. However, we would suggest that you first double-check with your local retailer whether they will offer you this service.

Either way, this product will then be treated in an environmentally sound manner at a licensed recycling plant and its components will be recovered, recycled or reused in the most efficient way possible, in compliance with the requirements of the Directive on Waste Electrical and Electronic Equipment (2002/96/EC) of 27 January 2003.

**Under applicable environmental laws, you should always use the available separate collection systems for waste electrical and electronic equipment. In some countries, failure to use these systems may even result in sanctions being taken against you.**

#### Note:

1. Waste electrical and electronic equipment may contain hazardous substances, which, if not treated properly, can be harmful to the environment and human health. Specific treatment of waste electrical and electronic equipment is therefore indispensable.
2. All Nintendo electrical and electronic equipment that is subject to the above Directive is designed in a way which takes full account of, and facilitates, its possible repair, upgrading, reuse, dismantling and recycling.
3. Nintendo and its official distributors support recycling schemes in each European country and are committed to using the best available treatment, recovery and recycling techniques in order to ensure both human health and high environmental protection.
4. The crossed-out wheeled bin symbol (see below) is affixed to all relevant Nintendo electrical and electronic equipment that has been put onto the market by Nintendo or its official distributors on or after 13 August 2005. The symbol means that these products must be collected separately from other waste at the end of their life, in order to ensure maximum recovery and environmentally sound disposal.



## Technical Specifications

Note: These specifications may be changed without prior notice in order to make improvements.

### Nintendo 3DS XL system

<b>Model Number</b>	SPR-001(EUR)
<b>LCD Screens</b>	<b>Upper Screen:</b> 3D-enabled widescreen LCD (can display 16.7 million colours) <b>Lower Screen:</b> Touch-screen LCD (can display 16.7 million colours)
<b>Screen Size / Resolution</b>	<b>Upper Screen:</b> 4.88 inches (106.2mm wide x 63.72mm high) 800 x 240 pixels (400 pixels per eye when using 3D feature) <b>Lower Screen:</b> 4.18 inches (84.96mm wide x 63.72mm high) 320 x 240 pixels
<b>AC Adapter / Battery</b>	Nintendo 3DS AC adapter (WAP-002(UKV)/WAP-002(EUR)) (sold separately) Nintendo 3DS XL Battery Pack (SPR-003)
<b>Wireless Frequency</b>	2.4GHz Band (11b: 1 – 13ch / 11g: 1 – 11ch)
<b>Communication Standard</b>	IEEE802.11b/g
<b>Output Power</b>	11b: 5.5dBm / 11g: 5.0dBm maximum
<b>Recommended Communication Distance</b>	Within 30m <b>Note:</b> The maximum distance at which communication is possible may be reduced depending on the surroundings. Only use these figures as a rough estimate.
<b>Camera Feature</b>	<b>Lens:</b> Fixed focal length <b>Image sensor:</b> CMOS <b>Effective pixels:</b> About 300,000
<b>Clock Feature</b>	Max. Daily Variation of $\pm 4$ seconds (when used within the "Usable Environment" below)
<b>Speakers</b>	Stereo (supports pseudo-surround)
<b>Input / Output Terminals</b>	Game Card slot, SD Card slot, AC adapter connector, audio jack (stereo output)
<b>Sensors</b>	Motion sensor, gyro sensor
<b>Maximum Power Consumption</b>	Approx. 4.1W (when charging)
<b>Usable Environment</b>	<b>Temperature:</b> 5 – 35 degrees Celsius <b>Humidity:</b> 20 – 80 %
<b>Dimensions</b>	93mm high x 156mm wide x 22mm thick (when closed)
<b>Mass</b>	Approx. 336g (including battery pack, stylus and SD Card)
<b>Charge Time</b>	Approx. 3.5 hours
<b>Battery Life</b>	Please see page 31.

### Nintendo 3DS XL Battery Pack

<b>Model Number</b>	SPR-003
<b>Battery Type</b>	Lithium Ion
<b>Battery Capacity</b>	6.5Wh

### Nintendo 3DS XL Stylus

<b>Model Number</b>	SPR-004
<b>Material</b>	Plastic (ABS / PE)
<b>Length</b>	Approx. 96mm
<b>Mass</b>	Approx. 1.8g

- ➔ Control Pad ..... 23
- 0 – 9**
- 2D display ..... 33
- 3D Calibration ..... 83
- 3D depth slider ..... 22, 33
- 3D Icon ..... 41
- 3D images ..... 32, 96
- 3D images (health and safety) ..... 13
- 3D photo(s) ..... 41, 58
- 3D Screen ..... 23
- A**
- AC adapter connector ..... 24, 27
- AC plug ..... 27
- access point ..... 71, 75
- Activity Log ..... 67
- age ratings ..... 44
- AOSS ..... 73
- AR Card(s) ..... 65, 102
- AR Games: Augmented Reality ..... 65
- audio jack ..... 23
- automatic system updates ..... 91
- B**
- balance (Nintendo eShop) ..... 64
- battery cover ..... 24, 92
- battery life ..... 31
- binocular disparity ..... 32
- blocked-user settings ..... 82
- bookmarks ..... 56
- brightness settings ..... 40
- built-in applications ..... 38
- C**
- camera LED ..... 24
- camera mode (HOME Menu) ..... 41
- camera mode (Nintendo 3DS Camera) ..... 59
- card-based software ..... 38, 44
- card software icon ..... 38
- charging cradle ..... 27
- charging / recharging ..... 26
- Circle Pad ..... 23
- calibration ..... 83
- collected Mii characters ..... 63
- colour (Nintendo DS Profile) ..... 83
- content descriptors (PEGI) ..... 44
- cradle connector ..... 24
- credit cards ..... 64
- D**
- Daily Records ..... 67
- Data Management ..... 82
- date ..... 28, 83
- date of birth ..... 29, 83
- DC plug ..... 27
- Download Play ..... 68
- downloadable software ..... 7, 47, 64, 82
- Dream (camera mode) ..... 59
- DS Download Play ..... 68
- E**
- error code ..... 77
- error message ..... 77
- F**
- Face Raiders ..... 66
- facial recognition ..... 100
- feedback (audio) ..... 98
- folders ..... 42
- creating ..... 42
- settings ..... 43
- Format System Memory ..... 91
- friend card ..... 51
- friend code ..... 50
- friend list ..... 49
- settings ..... 53
- friend ..... 49
- online status ..... 53
- registration ..... 50
- G**
- Game Boy ..... 64
- Game Card slot ..... 24, 45
- Game Card ..... 44, 45, 99
- Game Notes ..... 48
- gift icon ..... 38
- Graffiti ..... 60
- H**
- Health and Safety Information ..... 12, 38
- HOME Button ..... 23
- HOME Menu ..... 36
- I**
- infrared transceiver ..... 24
- initial configuration ..... 28
- inner camera ..... 23, 41
- input modes ..... 30
- instruction manual ..... 40
- internet browser ..... 56
- Entering URLs ..... 56
- Page Info ..... 56
- Settings ..... 56
- Internet Settings ..... 70
- K**
- keyboard ..... 30
- L**
- L Button ..... 24
- LCD screen ..... 95
- local wireless ..... 37
- lower screen ..... 23, 25
- Low-light (camera mode) ..... 59
- M**
- master key ..... 81
- Merge (camera mode) ..... 41, 59
- Message (Nintendo DS Profile) ..... 83
- Mic Test ..... 83
- microphone ..... 22
- microSD Card ..... 34
- Mii Maker ..... 62
- Mii characters ..... 62
- miniSD Card ..... 34
- motion sensor ..... 97
- Mystery (camera mode) ..... 59
- N**
- Nintendo 3DS AC Adapter ..... 4, 26, 27
- Nintendo 3DS Camera ..... 58
- Nintendo 3DS download software ..... 64
- Nintendo 3DS Game Card(s) ..... 38, 44
- Nintendo 3DS Service
- User Agreement and Privacy Policy ..... 29
- Nintendo 3DS software ..... 44, 47
- Nintendo 3DS Sound ..... 61
- Nintendo 3DS XL Battery Pack ..... 26, 92
- Nintendo 3DS XL stylus ..... 25
- Nintendo DS Connections ..... 77
- Nintendo DS Profile ..... 83
- Nintendo DS /
- Nintendo DSi Game Card(s) ..... 38, 44
- Nintendo DS /
- Nintendo DSi software ..... 41, 44, 77, 83
- Nintendo DSiWare ..... 47, 64, 82, 86
- Nintendo eShop ..... 64
- Nintendo eShop Card ..... 64
- Nintendo eShop Card activation number ..... 64
- Nintendo Letter Box ..... 7
- Nintendo Wi-Fi Connection Configuration ..... 87
- Nintendo Wi-Fi Connection ID ..... 87
- note (Game Notes) ..... 48
- notifications ..... 54
- stopping notifications ..... 55
- Notifications (application) ..... 54
- notification LED ..... 22, 53, 54
- O**
- Other Settings ..... 83
- outer cameras ..... 24, 41, 58
- calibration ..... 84
- P**
- Parental Controls ..... 78
- remove restrictions ..... 80
- restrictable items ..... 78
- settings ..... 79
- PEGI ratings ..... 44
- photo distance ..... 58
- photo(s) ..... 58
- taking ..... 59
- viewing ..... 60
- photo-taking ..... 41, 58
- PIN ..... 79, 81
- Pinhole (camera mode) ..... 59
- Play Coin ..... 36
- power (system) ..... 28
- POWER Button ..... 22, 28
- power LED ..... 22, 28, 31
- power-saving mode ..... 40
- profile (Nintendo DS) ..... 83
- protective sheet ..... 96, 97
- Q**
- quick camera ..... 36, 41
- R**
- R Button ..... 24
- recharge LED ..... 22, 27
- recordings ..... 61
- region ..... 29, 83
- remaining battery power ..... 31, 36
- remaining photos ..... 41
- router ..... 71
- S**
- screen brightness ..... 31, 40
- SD Card ..... 34, 47, 61, 82
- Copying Data ..... 35
- SD Card slot cover ..... 34
- SD Card slot ..... 24, 34
- SDHC Memory Card ..... 34
- search ..... 56
- security ..... 76
- security key ..... 75
- security type ..... 76
- SELECT (button) ..... 23
- set contents ..... 4
- signal strength icon ..... 36, 37, 76
- Sleep Mode ..... 28, 31, 99
- slide (Touch Screen) ..... 25
- slideshow ..... 60
- software ..... 38
- closing ..... 39, 45
- electronic manual ..... 40
- opening ..... 39, 45, 47
- suspending ..... 39
- software icons ..... 36, 38
- Software Library (Activity Log) ..... 67
- Software Management ..... 82
- Sound (System Settings) ..... 83
- Sparkle (camera mode) ..... 59
- speakers ..... 23, 83
- SpotPass ..... 8, 76
- START (button) ..... 23
- status message ..... 51
- steps ..... 36, 67, 98
- storage location ..... 41
- StreetPass ..... 9, 63, 82
- StreetPass Compatibility ..... 61
- StreetPass Hit Parade ..... 61
- StreetPass icon ..... 36
- stylus holder ..... 24, 25
- System Memory ..... 82
- System Settings ..... 69
- System Transfer ..... 86
- system update ..... 91
- T**
- taking photos and videos ..... 58
- technical specifications ..... 104
- thumbnails ..... 60
- time ..... 28, 83
- toolbar ..... 57
- touch (Touch Screen) ..... 25
- Touch Screen ..... 25
- calibration ..... 83, 96
- transfer ..... 86
- U**
- upper screen ..... 23, 32
- Usage Precautions ..... 20
- user name ..... 29
- V**
- viewing photos and videos ..... 60
- Virtual Console ..... 64
- volume control ..... 23
- W**
- WEP ..... 76
- Wi-Fi Protected Setup ..... 74
- wireless access point ..... 71
- wireless communication modes ..... 37
- wireless LED ..... 22
- wireless play ..... 52, 68, 70, 99
- wireless security ..... 75, 76
- wireless switch ..... 22
- WPA ..... 76
- wrist strap attachment ..... 24
- write-protection switch ..... 34

## 12-MONTH WARRANTY – NINTENDO HARDWARE

### CONSUMER WARRANTY

This warranty covers Nintendo consoles, including the original built-in software included with the respective Nintendo consoles at the time of purchase (the "Nintendo Operating Software"). In this warranty, the Nintendo console and the Nintendo Operating Software are referred to together as the "Product".

Subject to the terms and exclusions below, Nintendo warrants to the original consumer purchasing the Product ("you") that, for a period of 12 months from the date of the purchase of the Product by you, the Product will be free from defects in materials and workmanship. To make a valid claim under this warranty, you must notify Nintendo of the defect in the Product within 12 months of the date of the purchase of the Product by you, and you must return the Product to Nintendo within 30 days of notifying Nintendo of that defect. If, having inspected the Product, Nintendo accepts that the Product is defective, Nintendo will (at its sole discretion) either repair or replace the part causing the defect, or replace the Product without charge.

**This warranty does not affect any statutory rights which you may have as the purchaser of consumer goods.**

### EXCLUSIONS

**This warranty does not cover:**

- software (other than the Nintendo Operating Software) or games (whether included with the Product at the time of purchase or not);
- accessories, peripherals or other items that are intended for use with the Product but are not manufactured by or for Nintendo (whether included with the Product at the time of purchase or not);
- the Product if it was purchased outside the European Economic Area and Switzerland;
- the Product if it has been resold, or used for rental or commercial purposes;
- defects in the Product that are caused by accidental damage, your and/or any third party's negligence, unreasonable use, modification, use with products not supplied, licensed or authorised for use with the Product by Nintendo (including, but not limited to, non-licensed game enhancements, copier devices, adapters, power supplies or non-licensed accessories), computer viruses or connecting to the internet or other forms of electronic communication, use of the Product otherwise than in accordance with the instructions in the respective Nintendo Operations Manual or any other instructions provided with the Product, or any other cause unrelated to defects in material and workmanship;
- defects in the Product that are caused by the use of faulty, damaged or leaking batteries or battery packs, or any other use of batteries or battery packs not in accordance with the instructions in the respective Nintendo Operations Manual or Instruction Booklet;
- gradual decrease over time in the capacity and performance of batteries and battery packs for the Product (including NTR-003, USG-003, TWL-003, UTL-003, CTR-003, SPR-003) (which, for the avoidance of doubt, will not be deemed to be a defect in material or workmanship of the Product);
- the Product if it has been opened, modified or repaired by any person or company other than Nintendo or its authorised partners or it has its serial number altered, defaced or removed;
- loss of any data that has been loaded onto or stored on the Product by any person or company other than Nintendo or its authorised partners; or
- loss of data or software as a result of formatting the memory of the Product (or the SD Card being used with the Product).

### HOW TO MAKE A CLAIM

To notify Nintendo of a defect covered by this warranty, please contact:

**Nintendo Customer Support**  
**PO Box 952, Portsmouth, PO6 9DY**  
**Tel: +44 (0) 845 60 50 247**

Calls to this number are charged at national rates for customers in the UK, and at international rates for customers in the Republic of Ireland. Please obtain permission from the person responsible for the bill before calling.

Before sending the Product to Nintendo Customer Support, you should remove or delete any private or confidential files or data. You accept and agree that Nintendo will not be responsible for any loss, deletion or corruption of your files or data that has not been deleted or removed. Nintendo strongly recommends that you make a back up copy of any data that you do not remove or delete. Please note that, depending on the type of repair, data stored in the memory of the Product may be deleted, and you may not be able to read data saved to your SD Card or import it back onto the Product following such repair.

When sending the Product to Nintendo Customer Support, please:

1. use the original packaging where possible;
2. provide a description of the defect;
3. attach a copy of your proof of purchase, ensuring that it indicates the date of purchase of the Product; and
4. ensure that it is received by Nintendo within 30 days of the original notification of a qualifying defect.

If the above 12-month warranty period has expired at the time the defect is discovered or if the defect is not covered by this warranty, Nintendo may still be prepared to repair or replace the part causing the defect or replace the Product (at its sole discretion). For further information or, in particular, details of any charges for such services, please contact:

**Nintendo Customer Support**  
**Tel: +44 (0) 845 60 50 247**

Calls to this number are charged at national rates for customers in the UK, and at international rates for customers in the Republic of Ireland. Please obtain permission from the person responsible for the bill before calling.

### NINTENDO OPERATING SOFTWARE

The Nintendo Operating Software may only be used with Nintendo consoles, and may not be used for any other purpose. You must not copy, adapt, reverse-engineer, decompile, disassemble or modify the Nintendo Operating Software other than as expressly permitted by applicable law. Nintendo may use anti-copying or other measures to protect its rights relating to the Nintendo Operating Software.



Call UK Customer Support for assistance on all Nintendo published/distributed software, hardware and accessories. Our dedicated games counsellors can answer all your gameplay questions, offering hints, tips and strategies to ensure that you get the most from your Nintendo products.

**To call UK Customer Support, dial\***

**+44 (0) 845 60 50 247**

(\* Calls from a landline within the UK are charged at the standard national rate offered by the caller's network provider. Charges may vary for calls made using a mobile phone.)

Customers calling from outside the UK will be charged at the international rate offered by the provider of the network being used to make the international call.

Please obtain permission from the person responsible for paying the bill before calling.)

Lines are open Monday to Friday from 08:30 to 19:00, and Saturday from 08:30 to 15:30\*\*.

(\*\* Charges and opening hours are correct at time of printing but are subject to change without prior notice.)

## 12-MONTH WARRANTY – NINTENDO HARDWARE

### CONSUMER WARRANTY

This warranty covers Nintendo consoles, including the original built-in software included with the respective Nintendo consoles at the time of purchase (the "Nintendo Operating Software"). In this warranty, the Nintendo console and the Nintendo Operating Software are together referred to as the "Product".

Subject to the terms and exclusions below, Nintendo warrants to the original consumer purchasing the Product ("you") that, for a period of 12 months from the date of the purchase of the Product by you, the Product will be free from defects in materials and workmanship. To make a valid claim under this warranty, you must notify Nintendo of the defect in the Product within 12 months of the date of the purchase of the Product by you and you must return the Product to Nintendo within 30 days of notifying Nintendo of that defect. If, having inspected the Product, Nintendo accepts that the Product is defective, Nintendo will (at its sole discretion) without charge either repair or replace the part causing the defect or replace the Product or, provided that the Product is returned within 6 (six) months of purchase, at the discretion of the consumer, either repair or replace the part causing the defect, or replace the Product or refund the purchase price.

**This warranty does not affect your statutory rights which you may have as the purchaser of consumer goods.**

### EXCLUSIONS

**This warranty does not cover:**

- software (other than the Nintendo Operating Software) or games (whether or not included with the Product at the time of purchase);
- accessories, peripherals or other items that are intended for use with the Product but are not manufactured by or for Nintendo (whether or not included with the Product at the time of purchase);
- the Product if it was purchased outside South Africa;
- the Product if it has been resold, or used for rental or commercial purposes;
- defects in the Product that are caused by accidental damage, your and/or any third party's negligence, unreasonable use, modification, use with products not supplied, licensed or authorised for use with the Product by Nintendo (including, but not limited to, non-licensed game enhancements, copier devices, adapters, power supplies or non-licensed accessories), computer viruses or connecting to the internet or other forms of electronic communication, use of the Product otherwise than in accordance with the instructions in the respective Nintendo Operations Manual or any other instructions provided with the Product, or any other cause unrelated to defects in material and workmanship;
- defects in the Product that are caused by the use of faulty, damaged or leaking batteries or battery packs, or any other use of batteries or battery packs not in accordance with the instructions in the respective Nintendo Operations Manual or Instruction Booklet;
- gradual decrease over time in the capacity and performance of batteries and battery packs for the Product (including NTR-003, USG-003, TWL-003, UTL-003, CTR-003, SPR-003);
- the Product if it has been opened, modified or repaired by any person or company other than Nintendo or its authorised partners or it has its serial number altered, defaced or removed;
- loss of any data that has been loaded onto or stored on the Product by any person or company other than Nintendo or its authorised partners; or
- loss of data or software as a result of formatting the memory of Product (or the SD Card being used with the Product).

### HOW TO MAKE A CLAIM

To notify Nintendo of a defect covered by this warranty, please contact:

**Nintendo Service Centre, Core Warehouse, Block E, Wingfield Park  
Geertsema Street, Jet Park 1459  
Telephone: 08600 PLAY (7529)  
E-mail: support@nintendo.co.za**

Calls to this number are charged at national rates for customers in South Africa and international rates for international customers – please obtain permission from the person responsible for the bill before calling.

Before sending the Product to the Nintendo Service Centre, you should remove or delete any private or confidential files or data. You accept and agree that Nintendo will not be responsible for any loss, deletion or corruption of your files or data that have not been deleted or removed. Nintendo strongly recommends that you make a back up copy of any data that you do not remove or delete. Please note that, depending on the type of repair, data stored in the memory of the Product may be deleted, and you may not be able to read data saved to your SD Card or import it back onto the Product following such repair.

When sending the Product to the Nintendo Service Centre, please:

1. use the original packaging where possible;
2. provide a description of the defect;
3. attach a copy of your proof of purchase, ensuring that it contains the date of purchase of the Product; and
4. ensure that it is received by Nintendo within 30 days of the original notification of a qualifying defect.

If the above 12-month warranty period has expired at the time the defect is discovered or if the defect is not covered by this warranty, Nintendo may still be prepared to repair or replace the part causing the defect or replace the Product (at its sole discretion). For further information about this and, in particular, the details of any charges for such services, please contact:

**Nintendo Service Centre  
Telephone: 08600 PLAY (7529)**

Calls to this number are charged at national rates for customers in South Africa and international rates for international customers – please obtain permission from the person responsible for the bill before calling.

### NINTENDO OPERATING SOFTWARE

The Nintendo Operating Software may only be used with Nintendo consoles, and may not be used for any other purpose. You must not copy, adapt, reverse engineer, decompile, disassemble or modify the Nintendo Operating Software other than as expressly permitted by applicable law. Nintendo may use anti-copying or other measures to protect its rights in the Nintendo Operating Software.



Call our games hotline for assistance on all Nintendo published/distributed software, hardware and accessories. Our dedicated games counselors can answer all your gameplay questions, offering hints, tips and strategies to ensure that you get the most from your Nintendo products.

**To call the hotline, dial\*  
08600 PLAY (7529)**

(\* Calls from a landline within the South Africa are charged at the standard national rate offered by the caller's network provider. Charges may vary for calls made using a mobile phone.

Please obtain permission from the person responsible for paying the bill before calling.)

Lines are open Monday to Friday from 09:00 to 16:00 \*\*.

(\*\* Charges are correct at time of printing but are subject to change without prior notice.)



Trademarks are property of their respective owners.

Nintendo 3DS is a trademark of Nintendo.

© 2012 Nintendo.

This product includes RSA BSAFE® Cryptographic software of EMC Corporation.

RSA and BSAFE are registered trademarks or trademarks of EMC Corporation in the United States and other countries.

©2005 EMC Corporation. All rights reserved.

SDHC Logo is a trademark of SD-3C, LLC.

This product uses certain fonts provided by Fontworks Inc.

This product uses the LC Font by Sharp Corporation.

LCFONT, LC Font and the LC logo mark are trademarks of Sharp Corporation.

This product includes speech rate conversion software developed by Toshiba corporation.

Copyright © 2008 TOSHIBA CORPORATION

Ubiquitous TCP/IP+SSL

Copyright © 2001 – 2010 Ubiquitous Corp.

Powered by Devicescape Software. Portions of this products are © 2003 – 2010 Devicescape Software, Inc. All rights reserved.

Copyright © 2003 – 2010, Jouni Malinen <j@w1.fi> and contributors All Rights Reserved.

WPA Supplicant licensed pursuant to BSD License.

Redistribution and use in source and binary forms, with or without modification, are permitted provided that the following conditions are met:

1. Redistributions of source code must retain the above copyright notice, this list of conditions and the following disclaimer.
2. Redistributions in binary form must reproduce the above copyright notice, this list of conditions and the following disclaimer in the documentation and / or other materials provided with the distribution.
3. Neither the name(s) of the above-listed copyright holder(s) nor the names of its contributors may be used to endorse or promote products derived from this software without specific prior written permission.

THIS SOFTWARE IS PROVIDED BY THE COPYRIGHT HOLDERS AND CONTRIBUTORS "AS IS" AND ANY EXPRESS OR IMPLIED WARRANTIES, INCLUDING, BUT NOT LIMITED TO, THE IMPLIED WARRANTIES OF MERCHANTABILITY AND FITNESS FOR A PARTICULAR PURPOSE ARE DISCLAIMED. IN NO EVENT SHALL THE COPYRIGHT OWNER OR CONTRIBUTORS BE LIABLE FOR ANY DIRECT, INDIRECT, INCIDENTAL, SPECIAL, EXEMPLARY, OR CONSEQUENTIAL DAMAGES (INCLUDING, BUT NOT LIMITED TO, PROCUREMENT OF SUBSTITUTE GOODS OR SERVICES; LOSS OF USE, DATA, OR PROFITS; OR BUSINESS INTERRUPTION) HOWEVER CAUSED AND ON ANY THEORY OF LIABILITY, WHETHER IN CONTRACT, STRICT LIABILITY, OR TORT (INCLUDING NEGLIGENCE OR OTHERWISE) ARISING IN ANY WAY OUT OF THE USE OF THIS SOFTWARE, EVEN IF ADVISED OF THE POSSIBILITY OF SUCH DAMAGE.

This product includes software developed by the OpenSSL Project for use in the OpenSSL Toolkit. (<http://www.openssl.org/>).

Copyright © 1998 – 2007 The OpenSSL Project. All rights reserved.

Redistribution and use in source and binary forms, with or without modification, are permitted provided that the following conditions are met:

1. Redistributions of source code must retain the above copyright notice, this list of conditions and the following disclaimer.
2. Redistributions in binary form must reproduce the above copyright notice, this list of conditions and the following disclaimer in the documentation and / or other materials provided with the distribution.
3. All advertising materials mentioning features or use of this software must display the following acknowledgment:  
"This product includes software developed by the OpenSSL Project for use in the OpenSSL Toolkit. (<http://www.openssl.org/>)"
4. The names "OpenSSL Toolkit" and "OpenSSL Project" must not be used to endorse or promote products derived from this software without prior written permission. For written permission, please contact [openssl-core@openssl.org](mailto:openssl-core@openssl.org).
5. Products derived from this software may not be called "OpenSSL" nor may "OpenSSL" appear in their names without prior written permission of the OpenSSL Project.
6. Redistributions of any form whatsoever must retain the following acknowledgment:  
"This product includes software developed by the OpenSSL Project for use in the OpenSSL Toolkit (<http://www.openssl.org/>)"

THIS SOFTWARE IS PROVIDED BY THE OPENSSL PROJECT "AS IS" AND ANY EXPRESS OR IMPLIED WARRANTIES, INCLUDING, BUT NOT LIMITED TO, THE IMPLIED WARRANTIES OF MERCHANTABILITY AND FITNESS FOR A PARTICULAR PURPOSE ARE DISCLAIMED. IN NO EVENT SHALL THE OPENSSL PROJECT OR ITS CONTRIBUTORS BE LIABLE FOR ANY DIRECT, INDIRECT, INCIDENTAL, SPECIAL, EXEMPLARY, OR CONSEQUENTIAL DAMAGES (INCLUDING, BUT NOT LIMITED TO, PROCUREMENT OF SUBSTITUTE GOODS OR SERVICES; LOSS OF USE, DATA, OR PROFITS; OR BUSINESS INTERRUPTION) HOWEVER CAUSED AND ON ANY THEORY OF LIABILITY, WHETHER IN CONTRACT, STRICT LIABILITY, OR TORT (INCLUDING NEGLIGENCE OR OTHERWISE) ARISING IN ANY WAY OUT OF THE USE OF THIS SOFTWARE, EVEN IF ADVISED OF THE POSSIBILITY OF SUCH DAMAGE.

This product includes cryptographic software written by Eric Young. Copyright © 1995 – 1998 Eric Young ([ey@cryptsoft.com](mailto:ey@cryptsoft.com)).

All rights reserved.

This package is an SSL implementation written by Eric Young ([ey@cryptsoft.com](mailto:ey@cryptsoft.com)).

The implementation was written so as to conform with Netscapes SSL.

This library is free for commercial and non-commercial use as long as the following conditions are aheared to. The following conditions apply to all code found in this distribution, be it the RC4, RSA, lhash, DES, etc., code; not just the SSL code. The SSL documentation included with this distribution is covered by the same copyright terms except that the holder is Tim Hudson ([tjh@cryptsoft.com](mailto:tjh@cryptsoft.com)).

Copyright remains Eric Young's, and as such any Copyright notices in the code are not to be removed. If this package is used in a product, Eric Young should be given attribution as the author of the parts of the library used. This can be in the form of a textual message at program startup or in documentation (online or textual) provided with the package.

Redistribution and use in source and binary forms, with or without modification, are permitted provided that the following conditions are met:

1. Redistributions of source code must retain the copyright notice, this list of conditions and the following disclaimer.
2. Redistributions in binary form must reproduce the above copyright notice, this list of conditions and the following disclaimer in the documentation and / or other materials provided with the distribution.
3. All advertising materials mentioning features or use of this software must display the following acknowledgement:  
"This product includes cryptographic software written by Eric Young ([ey@cryptsoft.com](mailto:ey@cryptsoft.com))"  
The word "cryptographic" can be left out if the routines from the library being used are not cryptographic related :-).  
4. If you include any Windows specific code (or a derivative thereof) from the apps directory (application code) you must include an acknowledgement:  
"This product includes software written by Tim Hudson ([tjh@cryptsoft.com](mailto:tjh@cryptsoft.com))"

THIS SOFTWARE IS PROVIDED BY ERIC YOUNG "AS IS" AND ANY EXPRESS OR IMPLIED WARRANTIES, INCLUDING, BUT NOT LIMITED TO, THE IMPLIED WARRANTIES OF MERCHANTABILITY AND FITNESS FOR A PARTICULAR PURPOSE ARE DISCLAIMED. IN NO EVENT SHALL THE AUTHOR OR CONTRIBUTORS BE LIABLE FOR ANY DIRECT, INDIRECT, INCIDENTAL, SPECIAL, EXEMPLARY, OR CONSEQUENTIAL DAMAGES (INCLUDING, BUT NOT LIMITED TO, PROCUREMENT OF SUBSTITUTE GOODS OR SERVICES; LOSS OF USE, DATA, OR PROFITS; OR BUSINESS INTERRUPTION) HOWEVER CAUSED AND ON ANY THEORY OF LIABILITY, WHETHER IN CONTRACT, STRICT LIABILITY, OR TORT (INCLUDING NEGLIGENCE OR OTHERWISE) ARISING IN ANY WAY OUT OF THE USE OF THIS SOFTWARE, EVEN IF ADVISED OF THE POSSIBILITY OF SUCH DAMAGE.

The licence and distribution terms for any publicly available version or derivative of this code cannot be changed. i.e. this code cannot simply be copied and put under another distribution licence [including the GNU Public Licence.]

"QR code reader" includes software deliverables of Information System Products Co., Ltd. and Institute of Super Compression Technologies, Inc. QR Code is a registered trademark of DENSO WAVE INCORPORATED IN JAPAN and other countries.

A O S S™ and AOSS™ are the trademarks of BUFFALO INC.

"Yahoo!" and the Yahoo! logo are registered trademarks of Yahoo! Inc.

Google™ search is a trademark of Google Inc.

This product contains NetFront Browser NX of ACCESS CO., LTD.

ACCESS, ACCESS logo and NetFront are registered trademarks or trademarks of ACCESS CO., LTD. In the United States, Japan and / or other countries.

© 2011 ACCESS CO., LTD. All rights reserved.

THIS PRODUCT IS LICENSED UNDER THE MPEG-4 SYSTEMS PATENT PORTFOLIO LICENSE FOR ENCODING IN COMPLIANCE WITH THE MPEG-4 SYSTEMS STANDARD. EXCEPT THAT AN ADDITIONAL LICENSE AND PAYMENT OF ROYALTIES ARE NECESSARY FOR ENCODING IN CONNECTION WITH (i) DATA STORED OR REPLICATED IN PHYSICAL MEDIA WHICH IS PAID FOR ON A TITLE BY TITLE BASIS AND / OR (ii) DATA WHICH IS PAID FOR ON A TITLE BY TITLE BASIS AND IS TRANSMITTED TO AN END USER FOR PERMANENT STORAGE AND / OR USE. SUCH ADDITIONAL LICENSE MAY BE OBTAINED FROM MPEG LA, LLC. SEE <[HTTP://WWW.MPEGLA.COM](http://www.mpegla.com)> FOR ADDITIONAL DETAILS.

The Wi-Fi CERTIFIED logo, Wi-Fi Protected Access™ (WPA and WPA2), and the Wi-Fi Protected Setup icon are registered trademarks of the Wi-Fi Alliance.



The Nintendo 3DS Services are operated by Nintendo of Europe GmbH  
Nintendo Center, 63760 Grossostheim, Germany  
Email: [info@nintendo.de](mailto:info@nintendo.de), Telephone: +49 06026 950-0  
VAT number: DE 132095955  
Company registered at Local Court of Aschaffenburg HRB 4276  
Managing Director: Satoru Shibata

For support in your local language, please contact the Nintendo Customer Support. Telephone: +44 (0) 845 60 50 247  
(You must gain the permission of the person responsible for paying the telephone bill before phoning, please dial carefully)  
Alternatively, please visit [www.nintendo.co.uk](http://www.nintendo.co.uk) and click the support tab at the top of the page or email [customer-support@nintendo.co.uk](mailto:customer-support@nintendo.co.uk)



Nintendo of Europe ("Nintendo") and its products are in compliance with all applicable European Union Directives and Regulations, many of which are aimed at environmental protection as well as consumer health and safety with respect to the manufacture, supply and use of Nintendo products. A brief summary of the applicable EU Directives and Regulations, and Nintendo's compliance with them, can be found on the Nintendo of Europe website:

<http://www.nintendo-europe.com/>

#### DECLARATION OF CONFORMITY

Nintendo hereby declares that "Nintendo 3DS XL" is in compliance with the essential requirements and other relevant provisions of directive 1999/5/EC. This Declaration of Conformity is published on our website. Please visit <http://docs.nintendo-europe.com>

#### Patent Information

European Registered Design: 1249155; 1249163; 1249171; 1249684;  
1249700; 1249718; 1249726; 1249742; 1259212; 1268114.

Other Patents Pending.

## Free Manuals Download Website

<http://myh66.com>

<http://usermanuals.us>

<http://www.somanuals.com>

<http://www.4manuals.cc>

<http://www.manual-lib.com>

<http://www.404manual.com>

<http://www.luxmanual.com>

<http://aubethermostatmanual.com>

Golf course search by state

<http://golfingnear.com>

Email search by domain

<http://emailbydomain.com>

Auto manuals search

<http://auto.somanuals.com>

TV manuals search

<http://tv.somanuals.com>