

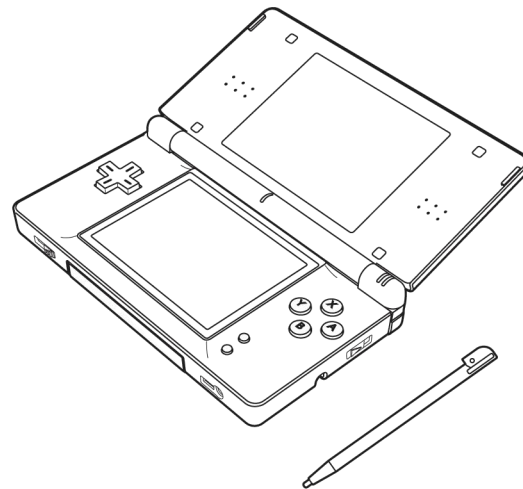

NINTENDO AUSTRALIA PTY. LTD.  
Scoresby Industrial Park, 804 Stud Road, Scoresby Victoria 3179 Australia  
<http://www.nintendo.com.au>

# NINTENDO DS<sup>®</sup> lite



INSTRUCTION BOOKLET

*This seal is your assurance that Nintendo has reviewed this product and that it has met our standards for excellence in workmanship, reliability and entertainment value. Always look for this seal when buying games and accessories to ensure complete compatibility with your Nintendo Product.*



Please carefully read the following instructions and the separate Health and Safety Precautions Booklet before setup or use of the Nintendo DS Lite. If, after reading all of the instructions, you still have questions, please contact Nintendo Customer Service on (03) 9730 9822.

### Compatibility with Game Boy® Games & Accessories

The Nintendo DS Lite will **NOT** work with the following games or accessories:

- Original Game Boy Game Paks
- Game Boy Color Game Paks
- Game Boy or Game Boy Advance™ Game Link™ cables
- Game Boy Advance Wireless Adapter
- Game Boy micro Wireless Adapter
- Game Boy micro Game Link cable
- Game Boy micro Converter Connector
- Game Boy Advance e-Reader
- Nintendo GameCube® Game Boy Advance cable
- Game Boy Printer
- Game Boy Camera

The Nintendo DS Lite is compatible with Game Boy Advance Game Paks in single player mode.



Nintendo DS Lite includes RSA BSAFE Cryptographic software from RSA Security Inc. RSA is a registered trademark of RSA Security Inc. BSAFE is a registered trademark of RSA Security Inc. in the United States and/or other countries.

©2005 RSA Security Inc. All Rights Reserved.

**WARNING: PLEASE CAREFULLY READ THE SEPARATE HEALTH AND SAFETY PRECAUTIONS BOOKLET INCLUDED WITH THIS PRODUCT BEFORE USING YOUR NINTENDO DS®, GAME CARD OR ACCESSORY. THIS BOOKLET CONTAINS IMPORTANT HEALTH AND SAFETY INFORMATION. PLEASE KEEP THIS BOOK FOR FUTURE REFERENCE.**

### Table of Contents

1	Health & Safety Information	2-3
2	Nintendo DS Lite Components	4-5
3	Charging the Nintendo DS Lite Rechargeable Battery Pack	6-7
4	Replacing the Nintendo DS Lite Rechargeable Battery Pack	8
5	Using the Nintendo DS Lite Stylus & Touch Screen	9
6	Children's Safety and Privacy	10
7	System Setup	11
8	Nintendo DS Menu Screen	12-13
9	Using Nintendo DS Game Cards	14
10	Using Game Boy Advance Game Paks	15
11	Wireless Communication & Game Play Modes	16-17
12	PictoChat™	18
13	Nintendo Wi-Fi Connection	19
14	Using the On-Screen Keyboard	20-21
15	Settings Menu – Changing System Settings	22-26
16	Troubleshooting	27-28
17	Warranty & Service Information	29

**LC FONT™** This product uses the LC Font by Sharp Corporation, except some characters. LCFONT, LC Font and the LC logo mark are trademarks of Sharp Corporation. Australian Registered Designs: 309,301; 310,194; 310,195; 310,196; 310,248; 310,252. Australian Patent Numbers: 643,693; 644,408; 645,462; 652,868; 660,156; 669,102. Other patents pending.

TM, ® and the Nintendo DS logo are trademarks of Nintendo. ©2007 Nintendo. All Rights Reserved.

# 1. Health and Safety Information

**IMPORTANT SAFETY INFORMATION – READ THE FOLLOWING WARNINGS BEFORE YOU OR YOUR CHILD PLAY VIDEO GAMES. IF THIS PRODUCT WILL BE USED BY YOUNG CHILDREN, THIS MANUAL SHOULD BE READ AND EXPLAINED TO THEM BY AN ADULT. FAILING TO DO SO MAY CAUSE INJURY.**

## **WARNING - Seizures**

- Some people (about 1 in 4000) may have seizures or blackouts triggered by light flashes or patterns, such as while watching TV or playing video games, even if they have never had a seizure before.
- Anyone who has had a seizure, loss of awareness, or other symptom linked to an epileptic condition should consult a doctor before playing a video game.
- Parents should watch when their children play video games. Stop playing and consult a doctor if you or your child have any of the following symptoms:

<b>Convulsions</b>	<b>Eye or muscle twitching</b>	<b>Loss of awareness</b>
<b>Altered vision</b>	<b>Involuntary movements</b>	<b>Disorientation</b>

- To reduce the likelihood of a seizure when playing video games:

1. Sit or stand as far from the screen as possible.
2. Play video games on the smallest available television screen.
3. Do not play if you are tired or need sleep.
4. Play in a well-lit room.
5. Take a 10 to 15 minute break every hour.

## **WARNING - Repetitive Motion Injuries and Eyestrain**

Playing video games can make your muscles, joints, skin or eyes hurt after a few hours. Follow these instructions to avoid problems such as tendonitis, carpal tunnel syndrome, skin irritation or eyestrain:

- Avoid excessive play. It is recommended that parents monitor their children for appropriate play.
- Take a 10 to 15 minute break every hour, even if you don't think you need it.
- When using the stylus, you do not need to grip it tightly or press it hard against the screen. Doing so may cause fatigue or discomfort.
- If your hands, wrists, arms or eyes become tired or sore while playing, stop and rest them for several hours before playing again.
- If you continue to have sore hands, wrists, arms or eyes during or after play, stop playing and see a doctor.

## **WARNING - Battery Leakage**

The Nintendo DS contains a rechargeable lithium ion battery pack. Leakage of ingredients contained within the battery pack or the combustion products of the ingredients, can cause personal injury as well as damage to your Nintendo DS. If battery leakage occurs, avoid contact with skin. If contact occurs, immediately wash thoroughly with soap and water. If liquid leaking from a battery comes into contact with your eyes, immediately flush thoroughly with water and see a doctor. To avoid battery leakage, combustion and explosion:

1. Do not expose battery to excessive physical shock, vibration or liquids.
2. Do not disassemble, attempt to repair or deform the battery.
3. The lithium ion battery must not be short circuited. Do not touch the terminals of the battery with any foreign materials or a metal object.
4. Do not expose the battery to heat or dispose of in a fire.
5. Do not peel or damage the battery label.
6. Do not use a battery if the plastic cover has been torn or compromised in anyway.
7. Do not insert or remove battery while the power is on.
8. The Nintendo DS Lite rechargeable battery pack is only to be recharged under adult supervision.
9. When recharging the Nintendo DS Lite rechargeable battery pack, only use the Nintendo DS Lite AC Adapter included with this system.
10. Use the Nintendo DS Lite rechargeable battery pack only for the Nintendo DS Lite system.
11. The battery is to be removed from the Nintendo DS before disposing of the unit.
12. Do not submerge the battery, wet it with water or any other liquid.
13. Do not remove the rechargeable battery pack from the Nintendo DS unless it needs to be replaced.
14. Do not use any battery other than the Nintendo DS Lite rechargeable battery pack (USG-003). A replacement battery may only be ordered from Nintendo Australia (refer to instruction booklet for contact details).
15. When disposing of the battery, follow appropriate local guidelines and regulations. For information on battery disposal contact your local solid waste authority.
16. If liquid comes into contact with the battery pack, do not reuse it.

## **WARNING - Radio Frequency Interference**

The Nintendo DS can emit radio waves that can affect the operation of nearby electronics, including cardiac pacemakers.

- Do not operate the Nintendo DS within 25 centimetres (10 inches) of a pacemaker while using the wireless feature.
- If you have a pacemaker or other implanted medical device, do not use the wireless feature of the Nintendo DS without first consulting your doctor or the manufacturer of your medical device.
- Observe and follow all regulations and rules regarding use of wireless devices in locations such as hospitals, airports, and on board aircraft. Operation in those locations may interfere with or cause malfunctions of equipment, with resulting injuries to persons or damage to property.

**Refer to the separate Nintendo DS Health and Safety Precautions booklet for additional information on hardware and software precautions and maintenance.**

**NOTE: This product does not contain latex, lead, mercury, cadmium, hexavalent chromium, PBB or PBDE.**

## 2. Nintendo DS Lite Components

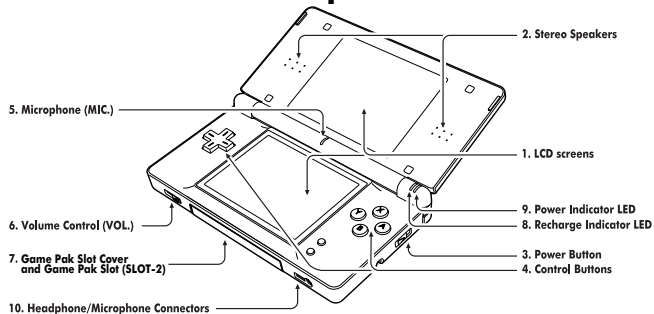

1. **LCD screens** – Twin backlit colour liquid crystal displays. The lower display (the Touch Screen) is touch sensitive and should only be operated with a Nintendo-licensed stylus.

**CAUTION: When opening the DS Lite, keep your fingers away from the hinge to avoid pinching them.**

2. **Stereo Speakers**
3. **Power Button** – Turns system on or off. To prevent turning the system off accidentally during game play, you must hold the Power Button in the UP position for a moment before it will turn off.
4. **Control Buttons** – The  $\oplus$  Control Pad, A, B, X, and Y Buttons, L and R Buttons, and START and SELECT. Used for game play control. See the instruction booklet for the game you are playing for specific game control information.
5. **Microphone (MIC.)** – Can only be used with specially designed games that incorporate the microphone feature.
6. **Volume Control (VOL.)** – Slide to the right to increase volume and left to decrease.
7. **Game Pak Slot Cover and Game Pak Slot (SLOT-2)** – Remove cover when using Game Boy Advance Game Paks or Nintendo DS accessories (sold separately). Keep cover in place when not using Slot-2 to prevent contamination from dust or other foreign material.  
**Not compatible with Game Boy or Game Boy Color Game Paks.**
8. **Recharge Indicator LED** – Lights orange while the battery is being recharged and turns off when charging is complete.

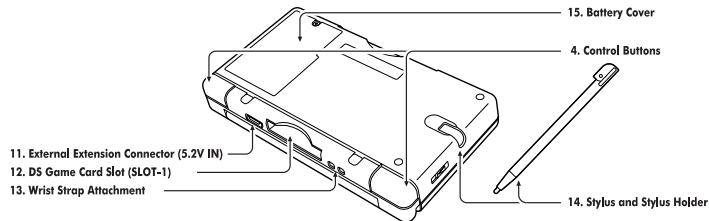

9. **Power Indicator LED** – Indicates power is on or off and battery life. The green colour will change to red when battery charge becomes low. When the LED turns red, save your game and recharge the battery to prevent loss of game data.

- Rapid blinking of the LED shows that wireless communication is in progress.

- Slow blinking shows that the Nintendo DS is in **Sleep Mode**.

**NOTE:** If you close the DS while the power is on, it will automatically switch to power-saving **Sleep Mode**. It will resume normal mode when opened again.

10. **Headphone/Microphone Connectors** – For connection of stereo headphones, external microphone or headset (each sold separately).
11. **External Extension Connector (5.2V IN)** – Allows connection of Nintendo DS Lite AC Adapter (included) for recharging the battery or operation of the DS using household mains power.
12. **DS Game Card Slot (SLOT-1)** – For loading a Nintendo DS Game Card (sold separately).
13. **Wrist Strap Attachment** – For attachment of wrist strap (sold separately).
14. **Stylus and Stylus Holder** – Always replace the stylus into the stylus holder after use.
15. **Battery Cover** – Can be removed to replace the rechargeable battery pack. See page 8 for more information on battery replacement.
16. **DC Connector Plug** – Connects to External Extension Connector (5.2V IN) for recharging the Battery Pack or when using household current.
17. **AC Connector Pins** – Pins for use in a standard 230-240 volt household electrical outlet.

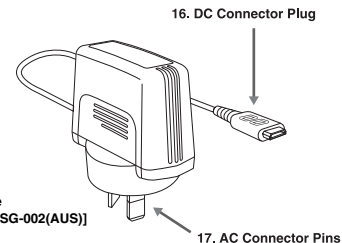

Nintendo DS Lite  
AC ADAPTER [USG-002(AUS)]

### 3. Charging the Nintendo DS Lite Rechargeable Battery Pack (USG-003)

**Caution: Do not use the Nintendo DS Lite AC Adapter during a lightning storm, as there may be a risk of electric shock from lightning.**

Before you use the DS for the first time, or after you have not used it for a long time, you must charge the battery. (If the DS is not used for long periods of time, the battery should still be recharged at least once every six months.)

When fully charged, the battery will last from 15-19 hours **on the lowest screen brightness setting**, depending on the type of game activity. (See page 13, #7, for information on adjusting the screen brightness.) On the brightest setting, the battery life is 5-8 hours.

The battery can be recharged approximately 500 times, but performance may decrease after repeated recharges, depending on usage conditions such as temperature. (Optimal charging temperature is between 10 and 40 degrees Celsius.) Battery life may also decrease over time. After 500 recharges, battery life may be only 70 % of the battery life at the time of purchase.

It takes approximately three hours to recharge the battery. (The actual time varies depending on how much battery life you have left.) When the Power Indicator LED turns red, save your game and recharge the battery to prevent loss of game data. You can play games while recharging the battery, but the recharge time will be longer.

**IMPORTANT: The Nintendo DS Lite AC Adapter [USG-002(AUS)] is only for use with the Nintendo DS Lite portable video game system. It is not compatible with any other Nintendo system.**

1. Insert the DC Connector Plug from the AC Adapter into the External Extension Connector (5.2V IN) on the back of the DS. (Illustration 1)

**IMPORTANT: Be sure the DC Connector Plug is facing in the correct direction before inserting into the External Extension Connector to avoid damaging either the DC Connector Plug or External Extension Connector.**

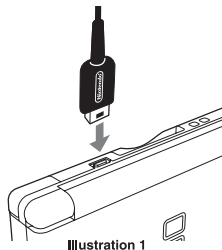

Illustration 1

2. Insert the pins of the AC Adapter into a standard 230-240 volt household electrical outlet. Be sure that the pins are fully inserted into the outlet. The Recharge indicator LED will light orange until the battery is fully charged. You can use the DS while recharging; however, it will take longer to recharge the battery. (Illustration 2)

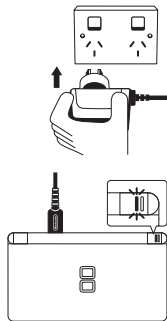

Illustration 3

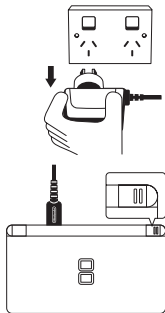

Illustration 2

3. When fully charged, the Recharge indicator LED will turn off. Remove the AC Adapter from the electrical outlet. Then remove the DC Connector Plug from the External Extension Connector. (Illustration 3)

**IMPORTANT: When disconnecting any plugs from the DS or wall socket, carefully pull by the plug itself rather than by the cord. Do not wrap the AC Adapter cord around the DS.**

- The Nintendo DS Lite must only be used with the Nintendo DS Lite AC Adapter.
- AC Adapter used with the Nintendo DS Lite should be regularly examined for damage to the cord, plug enclosure and other parts.
- In the event of damage the AC Adapter must not be used until the damage has been repaired.
- The AC Adapter is not a toy.
- The Nintendo DS Lite AC Adapter is for indoor use only.
- If the external flexible cable or cord of the AC Adapter becomes damaged, it should be replaced by Nintendo Customer Service in order to avoid any potential hazards.
- The Nintendo DS Lite should be disconnected from the AC Adapter before cleaning.
- Do not use the AC adapter in places where it may be splashed with water or any other liquid, or in extremely humid places.
- Do not place anything in front of the AC Adapter that would prevent it from being unplugged from the electrical outlet immediately.
- When not in use, always unplug the AC Adapter from the electrical outlet.

## 4. Replacing the Nintendo DS Lite Rechargeable Battery Pack

If it becomes necessary to replace the rechargeable battery pack, use the following procedure. This procedure should be performed by an adult. A replacement battery pack may only be ordered from Nintendo Australia (refer to page 29 for contact details).

1. Always turn the power off and disconnect the AC Adapter before replacing the battery pack.
2. Using a precision screwdriver, loosen the screw on the Battery Cover (Illustration 4). Remove the Battery Cover and retain. Always use an appropriate screwdriver for the screw. Using the wrong screwdriver may damage the head of the screw and you will not be able to remove the Battery Cover.
3. Use the protrusion on the edge of the battery pack to remove it from the DS (Illustration 5).
4. Insert a new rechargeable battery pack into the DS. Make sure to orient the battery correctly, as shown in illustration 6.
5. Replace the Battery Cover in its original position and carefully tighten the screw.

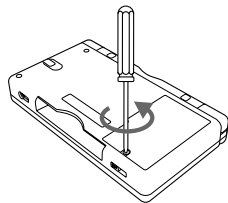

Illustration 4

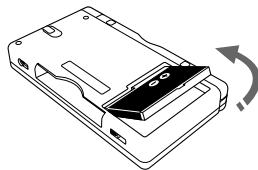

Illustration 5

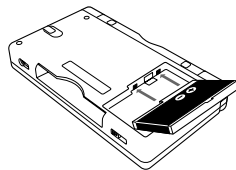

Illustration 6

## 5. Using the Nintendo DS Lite Stylus (USG-004) and Touch Screen

The lower LCD screen, or Touch Screen, is touch sensitive. For Nintendo DS games that include this game control feature, operate the screen by using the included stylus.

Lightly touch or slide the stylus across the Touch Screen. (Illustrations 7 and 8)

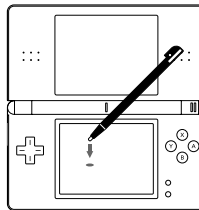

Illustration 7

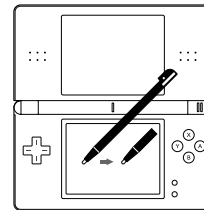

Illustration 8

### IMPORTANT STYLUS AND SCREEN GUIDELINES:

- ONLY use the stylus on the LOWER Touch Screen.
- Use only enough pressure to operate the game. Excessive pressure may damage the Touch Screen.
- Do not use the stylus if it is broken.
- Use only a Nintendo-licensed stylus on the Touch Screen.
- Replace the stylus in the stylus holder when not in use.
- If you use a screen protector on your Nintendo DS, use only a Nintendo-licensed screen protector, and use it only on the Touch Screen.

### SCREEN CLEANING PROCEDURE

If the screens on your Nintendo DS Lite have visible smudges, fingerprints on them or are contaminated with foreign material, they may not work properly and can become more damaged. You can clean them by using a soft clean cloth such as a lens or eyeglass cleaning cloth.

1. Slightly dampen the cloth with water ONLY and wipe off the screens to loosen any dirt or foreign material.
2. Using a dry cloth, wipe the screens to dry them and finish the cleaning process.

If the Touch Screen still does not work after cleaning, please contact Nintendo Customer Service on (03) 9730 9822 or visit [www.nintendo.com.au/ds/clean/index.php](http://www.nintendo.com.au/ds/clean/index.php).

## 6. Children's Safety and Privacy

Nintendo DS wireless communication (including PictoChat™) is not monitored.

PictoChat allows users to communicate wirelessly with other Nintendo DS Lite and Nintendo DS users within a range of approximately 20 metres (65 feet). PictoChat is not an Internet application. Up to 16 users can chat at one time in a PictoChat "chat room". In addition, some games may also have similar chat features programmed into the game.

**THIS COMMUNICATION IS NOT MONITORED OR CONTROLLED. MESSAGES MAY BE RECEIVED BY STRANGERS AND COMMUNICATED FROM STRANGERS.**

To ensure your privacy, do not give out personal information such as last name, phone number, age, e-mail or home address when communicating with others.

Children who use Nintendo DS should be warned against communicating with or meeting strangers or communicating personal information which strangers may receive and read.

Whatever date you choose to enter as your month/day of birth (year is not asked for), an "it's your birthday" message will be communicated in the chat room on that date. Whatever name the user enters as their nickname during the system setup (see "System Setup" on page 11) can be viewed by other Nintendo DS users while using PictoChat. An adult should assist children with the system setup.

For more information, visit <http://www.nintendo.com.au/ds/privacy>

## 7. System Setup

Please Note: An adult should assist children with the system setup.

The first time the Nintendo DS is turned on, you will be asked to select the screen language. Use the **+** Control Pad or stylus to select a language, then touch Yes or press the A Button.

Follow the on-screen instructions to input your nickname, screen colour, date, time, and month and day of birth (not the year). Press the B Button to step backward through this process if you would like to change the settings. You will be able to change these settings later from the **Settings Menu**, see pages 22 – 26. For help using the on-screen keyboard, see page 20.

Once you have finished with the system settings, touch QUIT. A confirmation message will then appear. If you touch YES, the Nintendo DS will be turned off automatically. Turn the power on to go to the **Nintendo DS Menu Screen** shown on the following page.

## 8. Nintendo DS Menu Screen

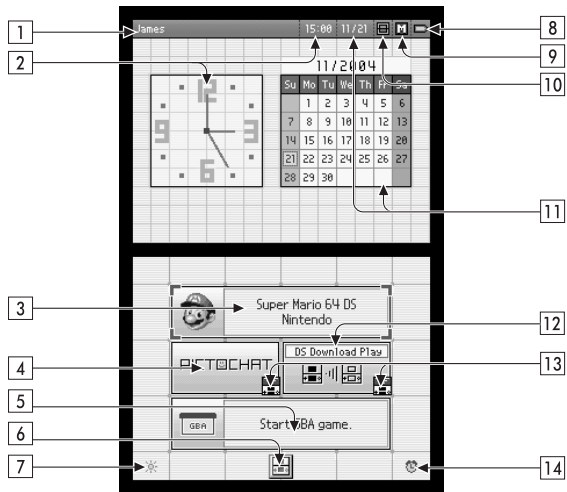

- User Name** – Can be adjusted from the **Settings Menu**. (Page 25)
- Clock/Alarm and Current Time** – Can be adjusted from the **Settings Menu**. (Page 24)
- DS Game Selection Panel** – Select to play a DS Game Card inserted into SLOT-1. (See “Using Nintendo DS Game Cards (NTR-005)” on the following page.)
- PictoChat Selection Panel** – Select to begin a PictoChat session. (See “PictoChat” on page 18.)
- Game Boy Advance Game Pak Selection Panel** – Select to play a Game Boy Advance Game Pak inserted into SLOT-2. (See “Using Game Boy Advance Game Paks (AGB-002)” on page 15.)
- Settings Menu Panel** – Select this panel to go to the **Settings Menu** to change initial setup information and other settings. (Pages 22 – 26)
- Display Brightness** – Touch to select from four levels of screen brightness. (Note: Battery will discharge faster on brighter settings.)
- Power Indicator Icon** – Shows battery charge. This is green while the battery has a normal charge and will change to red when the battery charge gets low.
- Screen Startup Mode Icon** – This icon shows which **Startup Mode** the DS will use when turned on.
  - In **Auto Mode**, the DS will automatically load a game if there is one in SLOT-1 or SLOT-2. The DS will load a DS Game Card automatically if both slots have games loaded.
  - In **Manual Mode**, the **Nintendo DS Menu Screen** will appear. You can switch mode from the **Settings Menu**. (Page 23)
- Game Boy Advance Display Screen Icon** – This icon indicates which screen will display Game Boy Advance games. Can be adjusted from the **Settings Menu**. (Page 23)
- Calendar and Current Date** – Can be adjusted from the **Settings Menu**. (Page 24)
- DS Download Play Selection Panel** – Select to use **Single-Card Download Play Mode**. (See “Wireless Communication and Game Play Modes” on pages 16 – 17.)
- Wireless Communication Icon** – Indicates that wireless communication will begin if this panel is selected. (Page 17) **NOTE: Use of wireless devices are prohibited in some locations.** (See “Radio Frequency Interference” on page 3.)
- Alarm ON/OFF Panel** – Touch to turn the alarm on. Can be adjusted from the **Settings Menu**. (Page 24)



## 9. Using Nintendo DS Game Cards (NTR-005)

1. Make sure that the Nintendo DS is turned off.
2. Insert the Nintendo DS Game Card into the DS Game Card Slot (SLOT-1) on the back of the system and push it gently but firmly until it clicks into place. The label should face towards the bottom of the DS. (Illustration 9)
3. Turn the power on. After the **Safety Information Screen**, the game title will appear. Touch the game title with the stylus to start the game (in **Auto Mode** the game will start automatically). Refer to the instruction booklet for the game you are playing for game instructions.
4. To remove a Game Card, first turn the power off. Push the Nintendo DS Game Card into the DS Game Card Slot until it clicks. It will then automatically eject part of the way out of the slot.

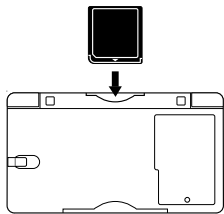

Illustration 9

## 10. Using Game Boy Advance Game Paks (AGB-002)

**IMPORTANT: The Nintendo DS will only work with Game Boy Advance Game Paks. The Nintendo DS is NOT compatible with original Game Boy or Game Boy Color Game Paks.**

1. Make sure that the Nintendo DS is turned off.
2. Insert the Game Boy Advance Game Pak into the Game Pak Slot (SLOT-2) on the front of the DS. Make sure it is fully inserted into the Game Pak Slot. The label should face towards the bottom of the DS. (Illustration 10)
3. Turn the power on. The game title will appear. Touch the game title with the stylus to start the game (in **Auto Mode** the game will start automatically). Refer to the instruction booklet for the game you are playing for game instructions.
4. To remove a Game Pak, first turn the power off. Gently slide the Game Pak out of the Game Pak Slot with your thumb.

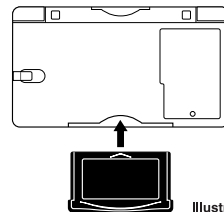

Illustration 10

When you are finished playing, always turn your system off and unplug the AC Adapter (if you are using it) from both the electrical outlet and the DS.

Do not wrap the AC Adapter cord around the DS.

When not in use, close the DS to protect the screens from dust or damage.

**NOTE: The power will NOT automatically turn off when the system is closed.** If you close the DS while the power is on, it will automatically switch to power-saving **Sleep Mode**, which still consumes power but at a slower rate. It will resume normal mode when opened again.

### IMPORTANT GAME CARD/GAME PAK GUIDELINES:

- Always check the Game Card or Game Pak edge connector for foreign material before inserting it into the DS.
- Be sure to orient the Game Card or Game Pak correctly before inserting into the DS.
- Do not turn the power off or remove the Game Card or Game Pak while saving game data, as your saved data may be destroyed.

# 11. Wireless Communication and Game Play Modes

**NOTE: Use of wireless devices are prohibited in some locations. Please see page 3 for further information. When your DS is in wireless mode the Power Indicator LED (green or red) will blink rapidly to indicate that wireless communication is in progress.**

The Nintendo DS wireless feature allows you to communicate or play games with other people without the use of cables. There are two types of wireless compatible Nintendo DS games.



**Wireless DS Multi-Card Play** requires one Game Card for each DS system used. The number of players that can participate will be indicated under the icon.



**Wireless DS Single-Card Download Play** requires only one Game Card for one system (Host System). The other players download the game information into their systems (Client Systems) using the wireless feature. The number of players that can participate will be indicated under the icon.

**Look for these icons on Nintendo DS game packaging for the type of wireless game play used on specific games and how many players can play simultaneously.**

## DS Multi-Card Play

1. Make sure that all DS systems are turned off, then insert a Game Card into each system. Turn all DS systems on.
2. Use the stylus to touch the game title on the display to start the game. Refer to the instruction booklet for the game you are playing for game play information.

## DS Single-Card Download Play

1. Make sure that all DS systems are turned off, then insert a Game Card into the system that will be the Host System. Turn all DS systems on.
2. Use the stylus to touch the game title on the display of the Host System to start the game.
3. On the Client Systems, touch the DS Download Play panel on the Nintendo DS Menu Screen.
4. On the Game Selection Screen, touch the game title you wish to download (Illustration 11). You will be asked to confirm your choice (Illustration 12). Touch YES to download game information from the Host System. Refer to the instruction booklet for the game you are playing for game play information.

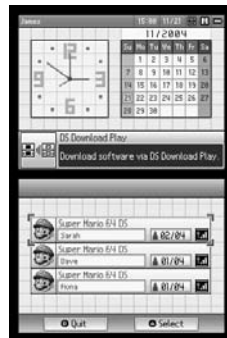

Illustration 11

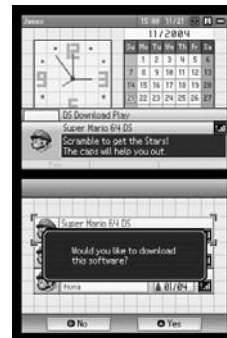
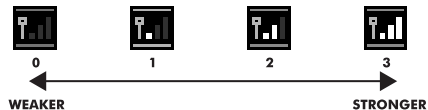

Illustration 12

## Wireless Signal Strength

During wireless game play, an icon will appear on either the upper or lower display showing the signal strength of the wireless signal. The icon has four modes depending on the signal strength, as shown below.



## IMPORTANT WIRELESS COMMUNICATION GUIDELINES:

- Begin with the distance between systems at about 10 metres (30 feet) or less and move closer or farther apart as desired, keeping the signal strength at two or more bars for best results.
- Keep the maximum distance between systems at 20 metres (65 feet) or less.
- The systems should face each other as directly as possible.
- Avoid having people or other obstructions between the DS systems.
- Avoid interference from other devices. If communication seems to be affected by other devices (wireless LAN, microwave ovens, cordless devices, computers), move to another location or turn off the interfering device.

Nintendo DS Lite is equipped with an RF module (802.11) which has a radiated power of less than 10mW EIRP. It complies with the requirements of AS/NZS 4268:2003 as designated in the Radiocommunications (Short Range Devices) Standard 2004 for Australia and as required by the Radiocommunications Regulations (General Users Radio Licence for Short Range Devices) Notice 2004 for New Zealand.

## 12. PictoChat™

PictoChat allows you to use the Nintendo DS to send and receive wireless messages and pictures from other DS users. PictoChat is not an internet application. You can communicate with up to 15 other DS users within range of your DS. Please see page 10 for “Children’s Safety and Privacy”.

1. Turn the power on. Select the PictoChat panel from the **Nintendo DS Menu Screen**. (Illustration 13)
2. The **Chat Room Selection Screen** will appear. Select one of the chat rooms to join. (Illustration 14)

The number in each panel indicates how many people are currently in that chat room. If the total number of participants is already at maximum (16/16), you cannot join that chat room.

The icon on the right side of the box indicates the signal strength for communicating with that chat room. See page 17 for information about this icon.

**NOTE: If you have problems communicating with other members of a chat room, have everyone switch to a different chat room. Also, review the communication guidelines on the previous page and check for interference.**

3. The **PictoChat Screen** will appear for the chat room you have selected.

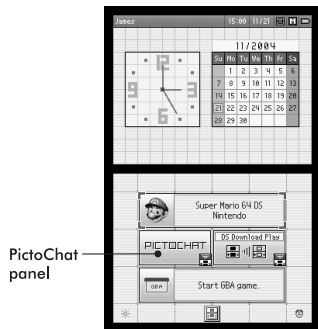

Illustration 13

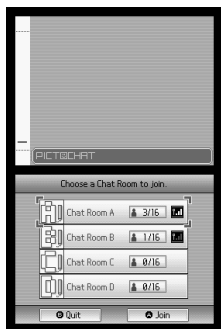

Illustration 14

For a complete description of how to use PictoChat, see the separate PictoChat instruction booklet included with your Nintendo DS hardware system.

## 13. Nintendo Wi-Fi Connection

**Nintendo Wi-Fi Connection (Nintendo WFC) allows you to play games over the internet, either at home or at select internet hotspots, using a Nintendo DS system and a Nintendo WFC compatible Nintendo DS game.**

**Look for this icon on Nintendo DS game packaging for games that include the Nintendo WFC feature.**



In addition, to play games over the internet at home, you will need:

- An active broadband internet account.
- A wireless access point, such as a wireless router or the Nintendo Wi-Fi USB Connector.

Please see the separate Nintendo Wi-Fi Connection instruction booklet included with all Nintendo Wi-Fi Connection compatible games for more information on playing Nintendo DS games over the internet, and visit [www.nintendowifi.com.au](http://www.nintendowifi.com.au).

## 14. Using the On-Screen Keyboard

The on-screen keyboard functions like a simple computer keyboard. The keyboard style can be selected from the menu on the left side of the keyboard. There are five styles of keyboards, as shown below. (Illustration 15)

Two styles are shown; however, they all work the same way.

Select letters by using either the stylus or the **+** Control Pad, A Button and B Button.

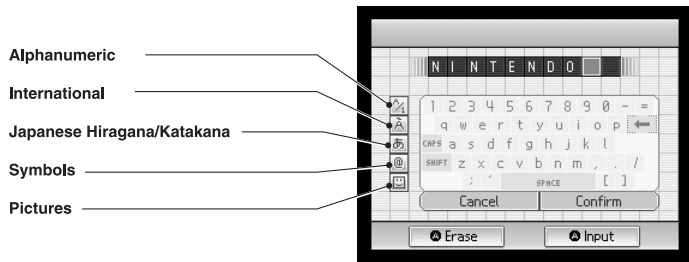

Illustration 15

### Alphanumeric

Shift between capital and lowercase letters.

Backspace or erase character.



Skip to next line.

Shift between capitals/symbols and lowercase letters/numbers.

Add a space.

### International

Backspace or erase character.

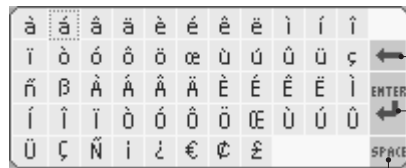

Skip to next line.

Add a space.

# 15. Settings Menu – Changing System Settings

Various items can be adjusted from the **Settings Menu**. To access the **Settings Menu**, touch the Settings Panel on the **Nintendo DS Menu Screen**. (Illustration 16)

The **Settings Menu** will appear. Each of the four menu panels will open a different set of options you can adjust. (Illustration 17)

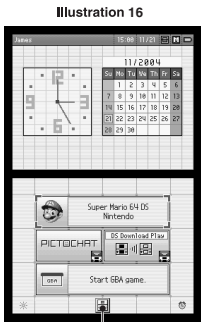

Settings Panel

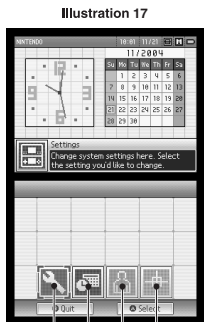

1 2 3 4  
Menu Panels

Select the menu panel for the options you would like to adjust.

- (1) **Options:** Start-up Mode, Screen Language, Game Boy Advance Screen
- (2) **Clock:** Date, Alarm, Time
- (3) **User:** Colour, Birthday, User Name, Message
- (4) **Touch Screen**

See the following pages for a description and instructions for each option.

**NOTE:** Once you have finished with the system settings, touch QUIT. A confirmation message will then appear. If you touch YES, the DS will be turned off automatically. Turn the power on to see the new settings take effect and resume using the DS.

## (1) OPTIONS

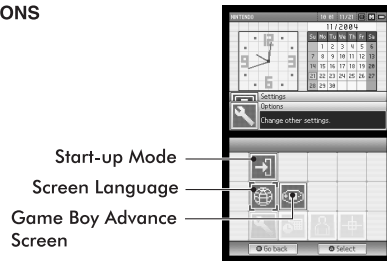

- Start-up Mode
- Screen Language
- Game Boy Advance Screen

Illustration 18

### • Start-up Mode (START-UP)

This option sets the mode the DS will start in when the power is turned on. Select from A AUTO Mode or M MANUAL Mode. In **Auto Mode**, the DS will load a game if there is a Game Card or Game Pak in either slot. The DS will load the Game Card first if both slots have games in them. If no game is loaded, the **Nintendo DS Menu Screen** will appear. In **Manual Mode**, the **DS Menu Screen** will appear. (Illustration 19)

### • Screen Language (LANGUAGE)

This option sets the language used for non-game functions like menus. (Illustration 20)

### • Game Boy Advance Screen (GBA MODE)

This option allows you to set which screen (upper or lower) you would like to use as the game screen when a Game Boy Advance game is played on the DS. (Illustration 21)

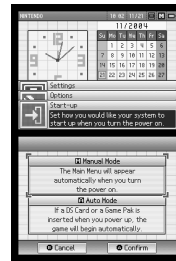

Illustration 19



Illustration 20

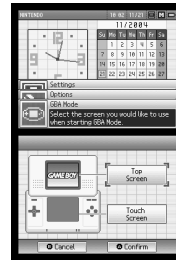

Illustration 21

## (2) CLOCK

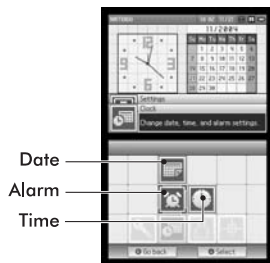

Illustration 22

### • Date

This option sets the month, day, and year for the system calendar. Touch the up/down arrows to adjust the numbers. Select Confirm when you are finished setting the date. (Illustration 23)

### • Alarm

This option allows you to use the DS as an alarm. When the alarm is turned on, you will not be able to use the DS in any other mode until the alarm is turned off. The alarm can be turned off by pressing any button (except the L and R Buttons) or by touching the Touch Screen. Touch the up/down arrows to adjust the numerals. Select Confirm when you are finished setting the time. (Illustration 24)

### • Time

This option sets the time for the system clock. Touch the up/down arrows to adjust the numbers. Select Confirm when you are finished setting the time. (Illustration 25)



Illustration 23

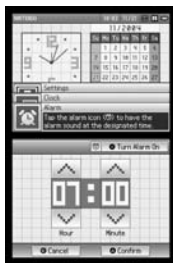

Illustration 24

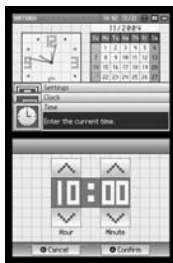

Illustration 25

## (3) USER

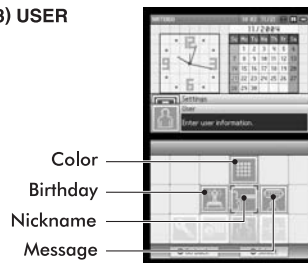

Illustration 26

### • Color

Touch the colour sample to set the background screen colour. Select Confirm when you are finished selecting your colour. (Illustration 27)

### • Birthday

Touch the up/down arrows to adjust the numbers. Select Confirm when you are finished setting the date. (Illustration 28)

### • User Name

This option allows you to enter your nickname. Your nickname may appear during PictoChat on other participants screens. We recommend selecting a gender neutral nickname. (See page 10 for "Privacy and Security" information.) Use the on-screen keyboard to enter up to ten characters. (Illustration 29)

### • Message

This options allows you to enter a message. Your message may appear during PictoChat on other participants screens. (See page 10 for "Privacy and Security" information.) Use the on-screen keyboard to enter up to 18 characters. (Illustration 30) See page 20 for information on how to use the on-screen keyboard.

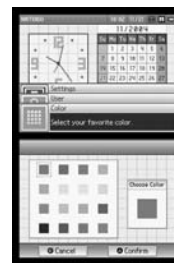

Illustration 27

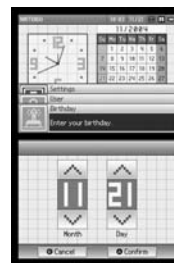

Illustration 28



Illustration 29



Illustration 30

#### (4) TOUCH SCREEN

Select this option to realign the stylus with the Touch Screen. Follow the on-screen instructions and carefully touch the indicated marks on the Touch Screen. (Illustration 31)

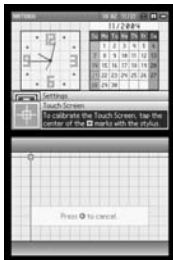

Illustration 31

## 16. Troubleshooting

Before seeking assistance, check the following information.

Problem	Solution
The screen stays blank even though the power is on.	<ul style="list-style-type: none"><li>• Make sure the Battery Pack is charged. The Power Indicator LED should light red or green depending on how much charge is in the battery.</li><li>• Turn the power off. Wait a few moments, then turn the power on.</li><li>• Turn the power off. Remove game and reinsert it, then turn the power on.</li><li>• If you are using the AC Adapter, make sure it is securely connected to both the Nintendo DS and the electrical outlet.</li></ul>
Image appears but there is no sound.	<ul style="list-style-type: none"><li>• Try adjusting the volume control.</li><li>• If headphones are attached to the Nintendo DS, sound will not come through the speakers.</li><li>• If you are using headphones, make sure they are securely plugged into the audio jack.</li><li>• Some games may have no sound during parts of the game.</li></ul>
Image appears but system is locked up.	<ul style="list-style-type: none"><li>• Make sure the game is inserted completely into the appropriate slot.</li><li>• Turn the power off. Remove game and reinsert it, then turn the power on.</li><li>• Make sure the game connector and game slots are clean and free of foreign material.</li></ul>
Battery life seems short and charging takes a long time.	<ul style="list-style-type: none"><li>• Make sure the surrounding temperature is above 10 degrees Celsius. Low temperatures will adversely affect battery performance.</li><li>• Battery life may also decrease over time. After 500 recharges, battery life may be only 70 % of the battery life at the time of purchase.</li></ul>
Game Boy Game Pak does not fit into the Nintendo DS.	<ul style="list-style-type: none"><li>• Make sure you are using a Game Boy Advance Game Pak (AGB-002). SLOT-2 on the Nintendo DS will only work with Nintendo DS accessories and Game Boy Advance Game Paks.</li></ul>
Wireless game play or communication does not work.	<ul style="list-style-type: none"><li>• Make sure the game supports wireless game play.</li><li>• For Multi-Card Play, each Nintendo DS system must have a Game Card inserted.</li><li>• Make sure all Nintendo DS systems are within 10 metres (30 feet) or less of each other to begin with. The signal strength should be at least two bars.</li><li>• Review the instruction booklet for the game you are playing for correct setup instructions.</li></ul>

Problem	Solution
Wireless game play or communication seems interrupted or unstable.	<ul style="list-style-type: none"> <li>• Make sure all Nintendo DS systems are within 10 metres (30 feet) or less of each other to begin with. The signal strength should be at least two bars.</li> <li>• Make sure there are no obstructions between the systems.</li> <li>• Make sure the systems are facing each other.</li> <li>• Make sure the batteries are charged.</li> <li>• Check for interference from other devices (wireless LAN, microwave ovens, cordless devices, computers), and move to another location or turn off the interfering device if necessary.</li> </ul>
PictoChat doesn't work.	<ul style="list-style-type: none"> <li>• Make sure there are no more than 16 participants in one chat room.</li> <li>• Try switching all participants to a different chat room.</li> <li>• Review the PictoChat instructions on page 18.</li> </ul>
The Touch Screen doesn't work.	<ul style="list-style-type: none"> <li>• Make sure you are using the stylus on the correct area of the Touch Screen.</li> <li>• Check the alignment of the stylus contact point using the Touch Screen adjustment (see page 26).</li> <li>• Review the instruction booklet for the game you are playing for correct operation of the stylus.</li> <li>• If your touch screen is scratched, dirty or contaminated with foreign material, follow the cleaning procedures on page 9.</li> </ul>
The microphone doesn't work.	<ul style="list-style-type: none"> <li>• Only games designed to use the microphone feature will work with the microphone. Make sure the game you are playing includes this feature.</li> <li>• If using an external microphone, make sure it is plugged securely into the appropriate audio jack.</li> </ul>
When the power is turned off there is an after-image left on the screen.	<ul style="list-style-type: none"> <li>• An after-image may appear on the screen after turning the power off. This after-image will not damage the Nintendo DS and will disappear after a short time.</li> </ul>
When playing Game Boy Advance games, the Multi-player features don't work.	<ul style="list-style-type: none"> <li>• Multi-player features on Game Boy Advance games don't work on the Nintendo DS.</li> </ul>

**If your Nintendo DS still does not operate correctly after trying the above remedies, please call Nintendo Customer Service (refer to page 29 for contact details).**

### 12 MONTH WARRANTY FOR NINTENDO DS® LITE

The benefits conferred by this Warranty are in addition to all other conditions, warranties and statutory remedies in respect of this NINTENDO DS™ which the consumer may have under the Trade Practices Act 1974 (Commonwealth) and/or similar State, Territory or Country Laws.

Nintendo Australia Pty Limited (**Nintendo**) warrants this NINTENDO DS® to be free of defects in materials, workmanship and manufacturing to the original purchaser for a period of **twelve months** from the date of purchase and upon presentation of purchase receipt.

1. Nintendo will, at its option and subject to the terms and conditions stated below, repair or replace free of charge this NINTENDO DS® or any component part, which upon examination by Nintendo is found to be defective in materials, workmanship or manufacturing.
2. This Warranty shall not apply:
  - (a) If the compliance label has been removed from the NINTENDO DS® or the serial number or other details have been removed or rendered illegible.
  - (b) If the NINTENDO DS® is connected to any voltage other than shown on the compliance label or unapproved and unlicensed products are used with the NINTENDO DS®.
  - (c) If the NINTENDO DS® has been subjected to misuse, abuse, accident or want of care.
  - (d) If the NINTENDO DS® has been modified and/or tampered with.
  - (e) If a repair has been made or attempted to the NINTENDO DS® by the purchaser or their agent.
  - (f) If the NINTENDO DS® fails due to causes unrelated to defective materials, workmanship or manufacturing.
3. The following are not covered by this Warranty:
  - (a) Broken/Damaged/Marked LCD display or Touch Screen;
  - (b) Liquid/Moisture damage;
  - (c) Wear and tear.
4. Nintendo does not accept any liability pursuant to this Warranty for any consequential damage or economic loss whether direct or indirect, to any person or property, arising from breakdown or failure of the NINTENDO DS®.
5. Nintendo's liability under the Warranty is limited to the lesser of the replacement cost or repair cost of the NINTENDO DS®.

This Warranty is given by Nintendo and no other person or organisation is authorised to vary its provisions and conditions.

Before returning a NINTENDO DS® for service:  
 Visit our web site [www.nintendo.com.au](http://www.nintendo.com.au) OR  
 Contact **Nintendo Customer Service** on **(03) 9730 9822**  
 for Warranty and Repair information and all other general enquiries.  
 Hours of operation: 9:00am to 5:00pm Monday to Friday (EST)

### **NINTENDO AUSTRALIA HEAD OFFICE**

Scoresby Industrial Park, 804 Stud Road, Scoresby Victoria 3179 Australia



## Free Manuals Download Website

<http://myh66.com>

<http://usermanuals.us>

<http://www.somanuals.com>

<http://www.4manuals.cc>

<http://www.manual-lib.com>

<http://www.404manual.com>

<http://www.luxmanual.com>

<http://aubethermostatmanual.com>

Golf course search by state

<http://golfingnear.com>

Email search by domain

<http://emailbydomain.com>

Auto manuals search

<http://auto.somanuals.com>

TV manuals search

<http://tv.somanuals.com>