



NINTENDO OF AMERICA INC.
P.O. BOX 957, REDMOND, WA
98073-0957 U.S.A.

**NEED HELP WITH INSTALLATION,
MAINTENANCE OR SERVICE?**

Nintendo Customer Service
WWW.NINTENDO.COM
or call **1-800-255-3700**

TTY Hearing Impaired: 1-800-422-4281

**BESOIN D'AIDE POUR L'INSTALLATION,
L'ENTRETIEN OU LA RÉPARATION?**

Service à la Clientèle de Nintendo
WWW.NINTENDO.COM
ou appelez le **1-800-255-3700**

Service à la clientèle ATS : 1-800-422-4281

**¿NECESITAS AYUDA DE INSTALACION,
MANTENIMIENTO O SERVICIO?**

Servicio al Cliente de Nintendo
WWW.NINTENDO.COM
o llame al **1-800-255-3700**

Número de TTY de Servicio al Cliente para individuos
con impedimento auditivo: 1-800-422-4281

61914C PRINTED IN CHINA



Wii Operations Manual

System Setup

To protect your health and safety, and for correct use of the Wii system, please read and follow the instructions in this operations manual before setup or use.

Throughout this manual, you will see this symbol  followed by WARNING or CAUTION. These terms have different levels of meaning:

WARNING - Warns you about incorrect use of the Wii system that could result in serious personal injury.

CAUTION - Cautions you about incorrect use of the Wii system that could result in personal injury or damage to the Wii system, components, game discs or accessories.

IMPORTANT NOTE FOR PARENTS:

Before allowing any child to use the Wii system, a parent or other responsible adult should determine whether the Wii system is appropriate for the child. Only children who are old enough and capable of wearing the wrist strap and properly gripping the Wii Remote should use the system. You should also consider whether children should be supervised while playing games, connecting to the internet, and/or downloading games. Be sure to explain all safety and health information and instructions to any children who are going to use the system. Failure to do so may result in injuries or damage to the system or other property.

NOTE: This product only plays Wii Game Discs and Nintendo GameCube™ Game Discs labeled with "For use only in USA, Canada, Mexico and Latin America". This product does not play CD or DVD discs. This Wii console is for use only in the United States, Canada, Mexico or Latin America.

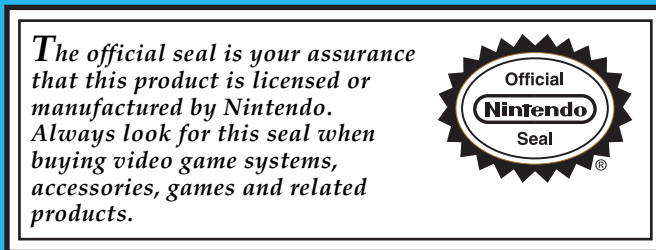

Dolby, Pro Logic and the double-D symbol are trademarks of Dolby Laboratories. This product contains PrFILE®2 FAT file system, PrMAIL mail client library, and PrUSB/Host USB host stack of eSOL Co.,Ltd. Copyright © 2006 eSOL Co., Ltd. PrFILE®2 is a registered trademark of eSOL Co., Ltd. in Japan. PrMAIL and PrUSB/Host are trademarks of eSOL Co., Ltd. in Japan. The Wii console includes RSA BSAFE Cryptographic software from RSA Security Inc. RSA is a registered trademark of RSA Security Inc. BSAFE is a registered trademark of RSA Security Inc. in the United States and/or other countries. © 2005 RSA Security Inc. All Rights Reserved. SD Logo is a trademark. The Wii console uses certain fonts provided by Fontworks Japan, Inc. Although an IBM logo appears on the Wii packaging, IBM is not responsible for warranty support of the Wii system. TM, ® and the Wii logo are trademarks of Nintendo. © 2006 Nintendo. All Rights Reserved. Nintendo of Canada Ltd., Authorized User in Canada. Elements of the Wii console and the Wii Network Services are patent pending, both in the United States and internationally.

Health and Safety Information	2-3
System Components	
Wii Console	4-5
Wii Remote	6
Nunchuk	7
Sensor Bar	7
AC Adapter	8
Wii AV Cable	8
Wii Stand & Stand Plate	9
System Setup	
Wii Console	10-11
Wii AV Cable	12
Sensor Bar	13-16
AC Adapter	17
TV and Audio/Video Settings	18
Setup of Wii Remote	18-19
Synchronizing Your Wii Remote and Wii Console	20-21
Using Game Discs	22
Wii System Play Guidelines	23
Using the Wii Remote	24-25
Using the Nunchuk	26-27
Using Nintendo GameCube Controllers	28-29
Using Memory Cards	30
Troubleshooting	31-32
FCC Information	33
Warranty and Service Information	34

Français – Page 35
Español – Página 71

Health and Safety Information

IMPORTANT SAFETY INFORMATION - READ THE FOLLOWING WARNINGS BEFORE SETUP OR USE OF THE Wii. IF THIS PRODUCT WILL BE USED BY YOUNG CHILDREN, THIS MANUAL SHOULD BE READ AND EXPLAINED TO THEM BY AN ADULT. FAILING TO DO SO MAY CAUSE INJURY.

⚠ WARNING - Seizures

Some people (about 1 in 4000) may have seizures or blackouts triggered by light flashes or patterns, and this may occur while they are watching TV or playing video games, even if they have never had a seizure before.

Anyone who has had a seizure, loss of awareness, or other symptom linked to an epileptic condition should consult a doctor before playing a video game.

Parents should watch their children play video games. Stop playing and consult a doctor if you or your child has any of the following symptoms:

Convulsions	Eye or muscle twitching	Loss of awareness
Altered vision	Involuntary movements	Disorientation

To reduce the likelihood of a seizure when playing video games:

- Sit or stand as far from the screen as possible.
- Play video games on the smallest available television screen.
- Do not play if you are tired or need sleep.
- Play in a well-lit room.
- Take a 10 to 15 minute break every hour.

⚠ WARNING - Repetitive Motion Injuries and Eyestrain

Playing video games can make your muscles, joints, skin or eyes hurt. Follow these instructions to avoid problems such as tendinitis, carpal tunnel syndrome, skin irritation or eyestrain:

- Avoid excessive play. Parents should monitor their children for appropriate play.
- Take a 10 to 15 minute break every hour, even if you don't think you need it.
- If your hands, wrists, arms or eyes become tired or sore while playing, or if you feel symptoms such as tingling, numbness, burning or stiffness, stop and rest for several hours before playing again.
- If you continue to have any of the above symptoms or other discomfort during or after play, stop playing and see a doctor.

⚠ WARNING - Electric Shock

To avoid electric shock when you use this system:

- Do not use the Wii during a lightning storm. There may be a risk of electric shock from lightning.
- Use only the AC Adapter that comes with your system.
- Do not use the AC Adapter if it has damaged, split or broken cords or wires.
- Make sure that the AC Adapter cord is fully inserted into the wall outlet or extension cord.
- Always carefully disconnect all plugs by pulling on the plug and not on the cord. Make sure the Wii power button is turned OFF before removing the AC Adapter cord from an outlet.

⚠ CAUTION - Motion Sickness

Playing video games can cause motion sickness in some players. If you or your child feel dizzy or nauseous when playing video games, stop playing and rest. Do not drive or engage in other demanding activity until you feel better.

⚠ WARNING - Radio Frequency Interference

The Wii console and Wii Remote can emit radio waves that can affect the operation of nearby electronics, including cardiac pacemakers.

- Do not operate the Wii console or remote within 9 inches of a pacemaker.
- If you have a pacemaker or other implanted medical device, do not use the Wii console or remote without first consulting your doctor or the manufacturer of your medical device.

⚠ CAUTION - Laser Device

The Wii console is a Class I laser product. Do not attempt to disassemble the Wii console. Refer servicing to qualified personnel only.

Caution: Use of controls or adjustments or procedures other than those specified herein may result in hazardous radiation exposure.

Specifications:

Laser Type: Semiconductor laser
Laser power: Max. 0.9mW

Laser wave length: 662nm (typ.)/647nm~687nm
Numeric aperture: 0.6

NOTE: This product does not contain latex, lead, mercury, cadmium, hexavalent chromium, PBB or PBDE.

Components

Wii Console

POWER Button

Press to turn the console ON or OFF.
NOTE: The Power LED does not go out when the power is turned off.

Power LED

Shows the status of the Wii console.

- Green - Console power is ON.
- Orange - Standby mode, WiiConnect24 is ON.
- Red - Standby mode, WiiConnect24 is Off.

RESET

Press to restart a game.

SYNCHRO Button (SYNC.)

Used when synchronizing a Wii Remote with the console. See pages 20-21.

SD Card slot

For inserting an SD memory cards.
See page 30.

Game Disc slot

For inserting a Wii or Nintendo GameCube Disc.
Slot lights blue and blinks when a disc is inserted.
When WiiConnect24 is set to ON, the slot will blink when messages or data are received.

EJECT Button

Press to eject a Wii or Nintendo GameCube Disc.

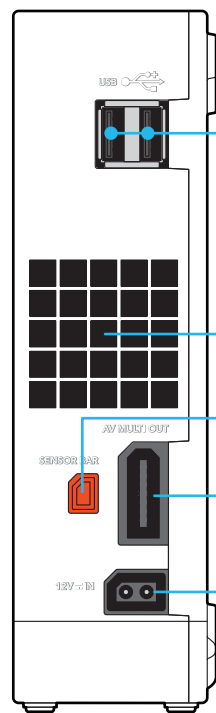
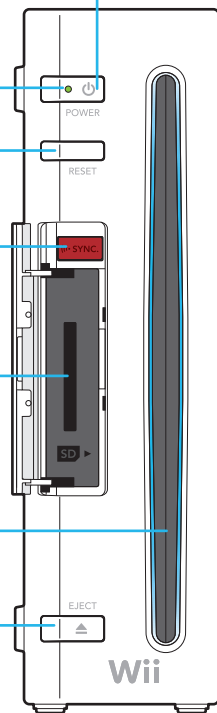

USB Connectors

Connects to USB devices, such as the Wii LAN Adapter. (Sold separately.)
Do not connect any device that is not specifically designed for use with the Wii System.

Air Vent

Do not block.

Sensor Bar Connector

Connects to the Sensor Bar.

AV Multi Out Connector

Connects to the AV cable for your television.

DC Input Connector

Connects to the Wii AC Adapter.

Wii Console

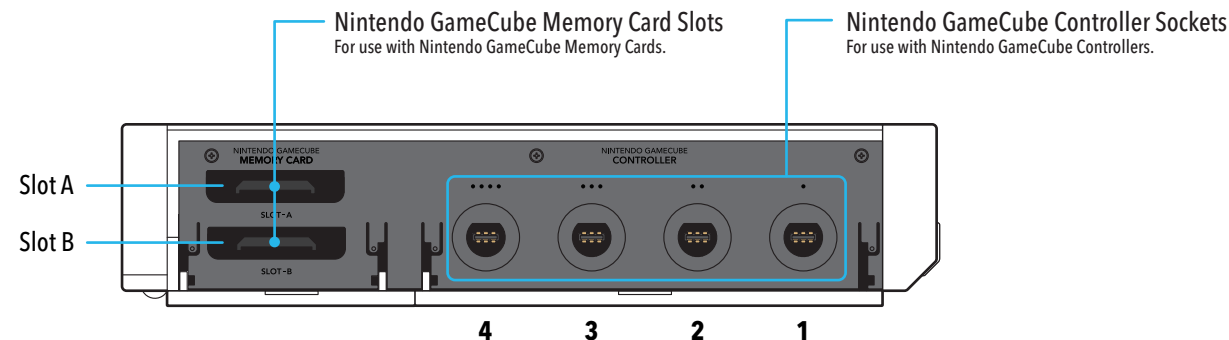

Nintendo GameCube Memory Card Slots
For use with Nintendo GameCube Memory Cards.

Nintendo GameCube Controller Sockets
For use with Nintendo GameCube Controllers.

Slot A

Slot B

4

3

2

1

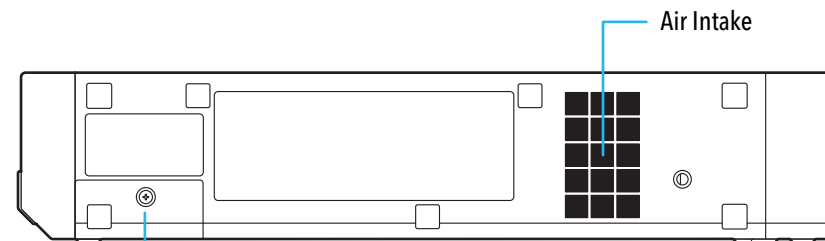

Air Intake

Battery Cover

For access to CR Coin Lithium battery (CR2032). **Perchlorate Material - special handling may apply.**
More information can be found at <http://www.dtsc.ca.gov/HazardousWaste/Perchlorate/index.cfm>.
Do not remove battery cover unless instructed to do so by a Nintendo Customer Service representative.

Components

Wii Remote™

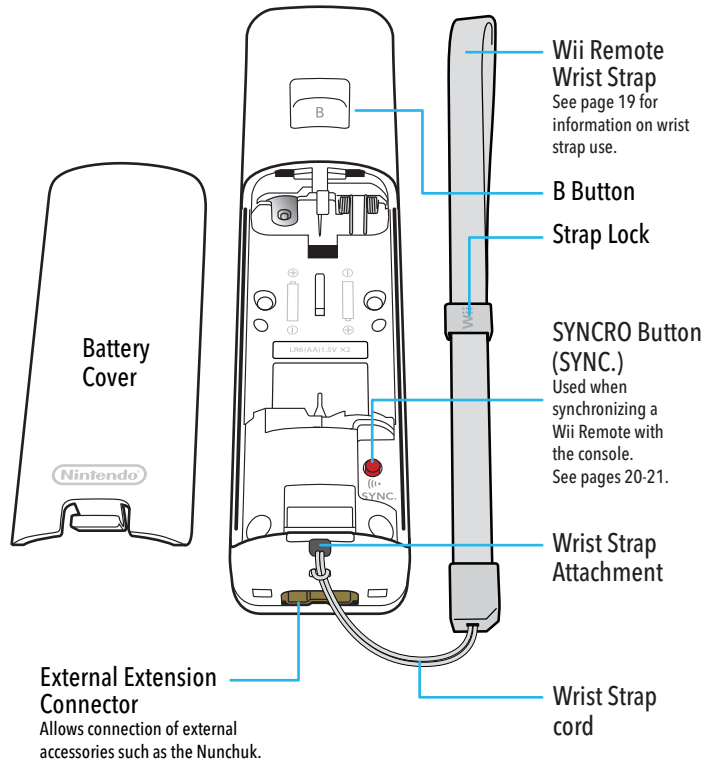
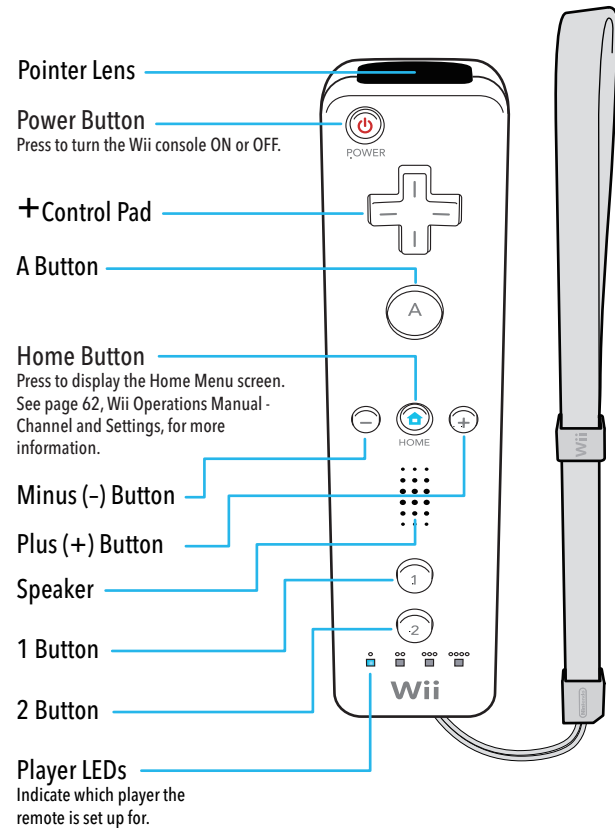

NOTE: Battery life can be checked by pressing the Home Button. See page 62, Wii Operations Manual - Channels and Settings, for more information.

Nunchuk™

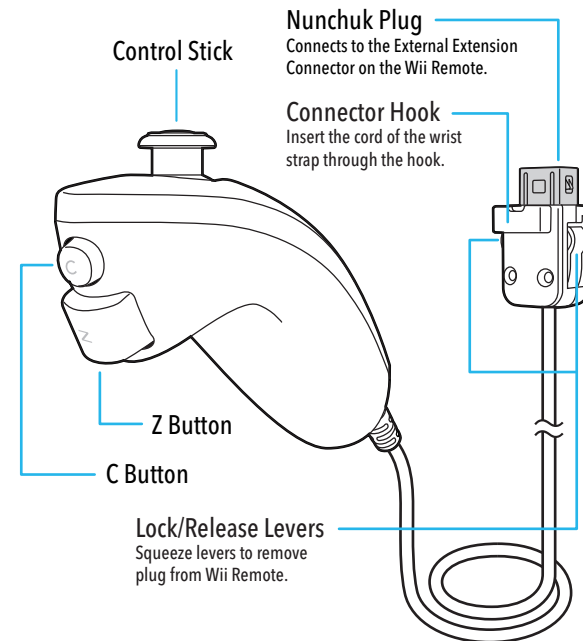

NOTE: If the Control Stick is moved out of neutral position when the Wii power is turned ON, or when connecting to the remote, that position will be set as neutral position, causing incorrect game control during game play. To reset the Control Stick, allow it to return to the normal neutral position, then simultaneously hold down the A, B, Plus (+) and Minus (-) buttons on the remote for three seconds.

Sensor Bar

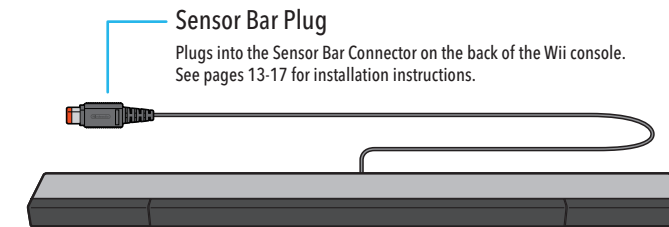

Sensor Bar Stand

See page 16 for installation instructions.

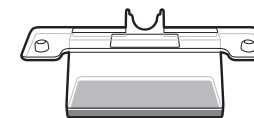

To avoid this from occurring, do not move the Control Stick when:

- Turning the Wii console on
- Plugging the Nunchuk into the Wii Remote
- Starting Channels from the Channel Menu
- Returning to the Wii Menu from games or Channels.

Components

Wii AC Adapter

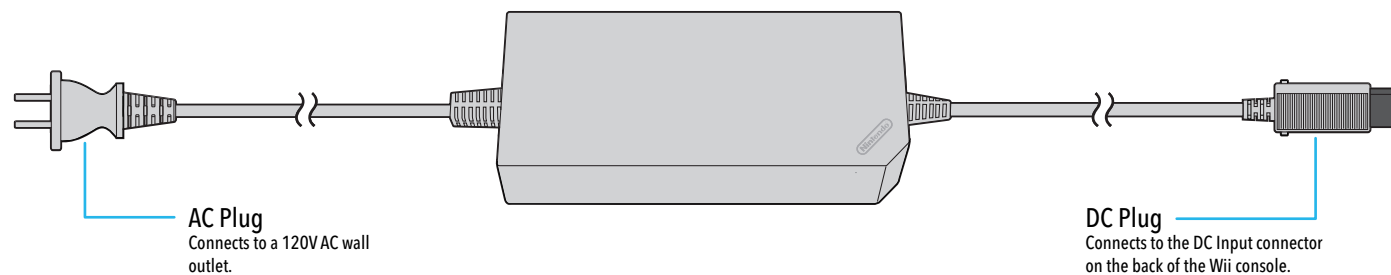

Wii AV Cable

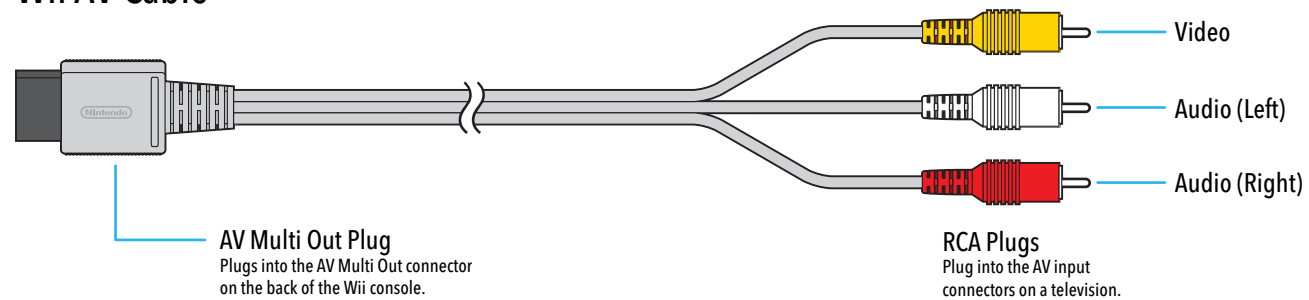

Wii Console Stand

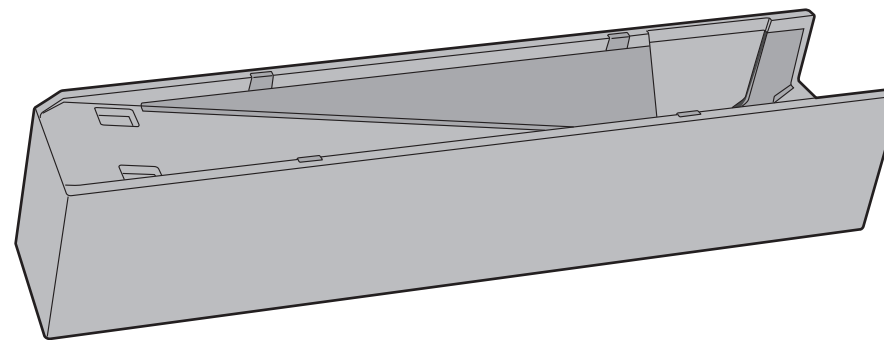

Wii Stand Plate

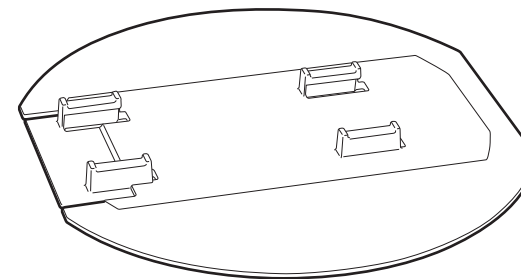

Wii Console Usage Precautions

Please read and follow the precautions listed below when setting up and using the Wii console. Failure to do so may result in damage to your Wii system or accessories.

- Do not use any AC Adapter other than the one provided with your system.
- The console has intake and exhaust vents designed to maintain adequate ventilation. Do not operate the console in any location where these vents may become covered or obstructed, for example, on carpet or in a tightly enclosed space. Keep vents clear of any dust or other foreign material.
- Do not disassemble or try to repair the Wii console, accessories or components. Doing so voids your warranty.
- After you have finished playing, be sure to remove the Game Disc from the console.
- Do not store the Wii console in a humid place, on the floor, or in any location where it may collect dirt, dust, lint, etc.
- Do not drop, hit or otherwise abuse the Wii console, components or accessories.
- When disconnecting any plugs from the console or wall outlet, first turn the Wii console off. Then carefully pull by the plug itself rather than by the cord.
- Do not step on, sharply pull or bend any wire or cables.
- Do not expose the Wii console, components or accessories to extreme heat or cold.
- Do not spill any liquids on the Wii console, components or accessories. To clean, use a soft slightly damp cloth. Use water only. Allow to dry completely before using.

Wii Console Placement

NOTE: Choose a location to set up the console that has enough room to allow for free flow of ventilation around the console.

The Wii console can be placed in a vertical or horizontal position. If located in a vertical position, it should be placed in the Wii console stand.

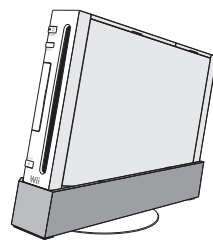

Vertical

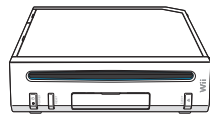

Horizontal

CAUTION - Console Damage

The console can be damaged if knocked over, especially if this occurs during operation of the disk drive. **The Wii stand plate has been included to increase stability of the Wii console, and should be used if the console is placed in a vertical position.**

Vertical Placement

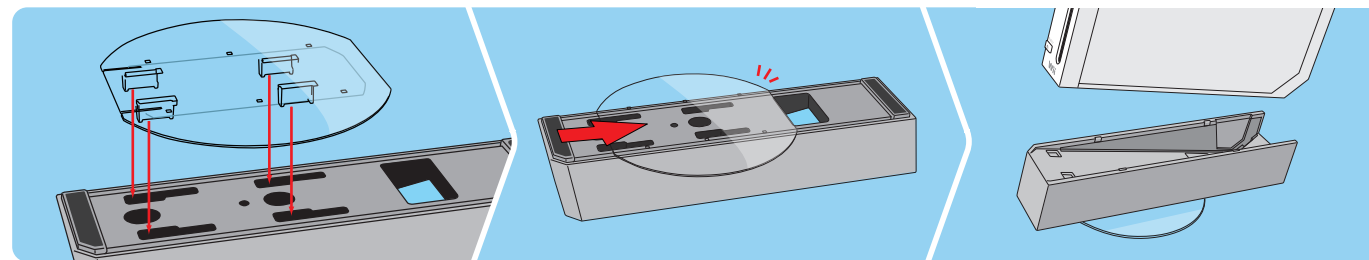

1. Attach the Wii stand plate to the bottom of the console stand by inserting the prongs into the slots as shown above.

2. Firmly slide the stand plate into slots in the direction shown.

3. Place the console stand on a flat surface and place the console into the stand. **Lower the console straight down into the console stand rather than sliding it in from the front.**

Horizontal Placement

Place the Wii console on a flat horizontal surface. Retain the Wii console stand and stand plate for future use in case you want to switch the orientation of the console.

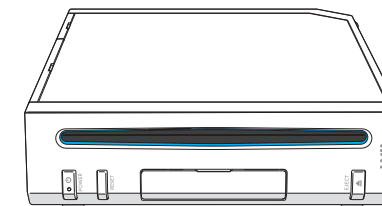

System Setup

Connecting the AV Cable

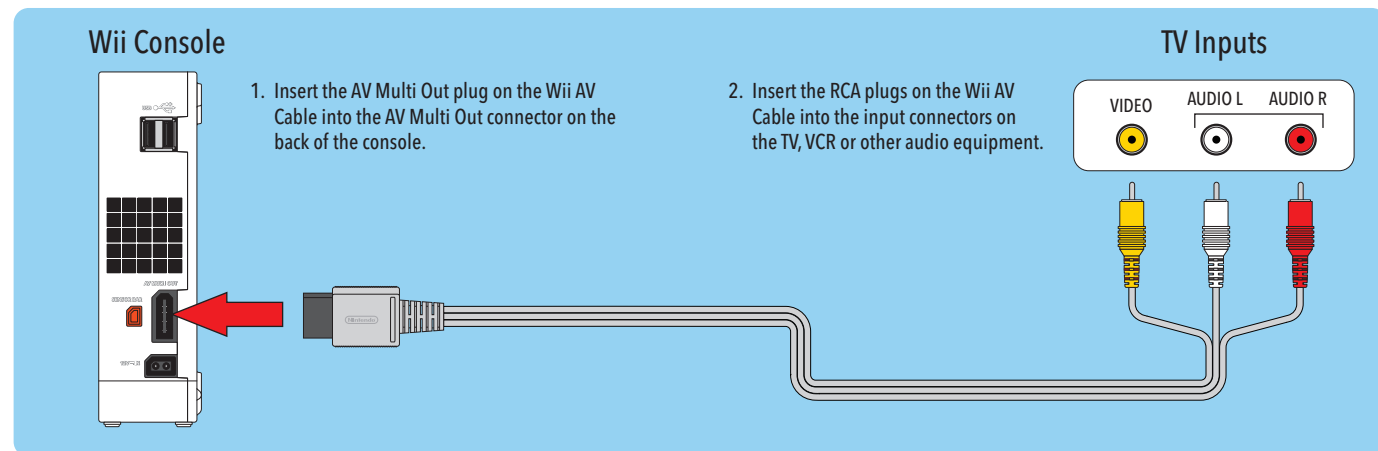

IMPORTANT: The Wii console will not work with any AV cable other than the model supplied with your Wii system or the component video cable listed below.

NOTE: For higher quality video, the Wii component video cable (Model No. RVL-011) can be ordered through Nintendo's web site at www.nintendo.com (USA/Canada only) or by calling Customer Service at 1-800-255-3700. Before ordering, check to make sure your TV has component video inputs.

CAUTION - TV Screen Damage

Some televisions can be damaged by the display of a stationary image, because the image may be permanently "burned" into the screen. Playing video games with stationary images or patterns, or leaving video games on hold or pause, may lead to this type of damage. When taking a break, place the game on pause and turn the TV off until you are ready to play again.

Before using your Wii system with any TV, especially front and rear projection models, be sure to review all documentation included with your TV to find out whether video games can be played on the TV without damaging it.

If in doubt, contact the manufacturer of the TV. Neither Nintendo nor any of Nintendo's licensees will be liable for any damage to your TV.

Sensor Bar Setup

■ Connecting the Sensor Bar

Insert the Sensor Bar plug into the Sensor Bar connector on the back of the console.

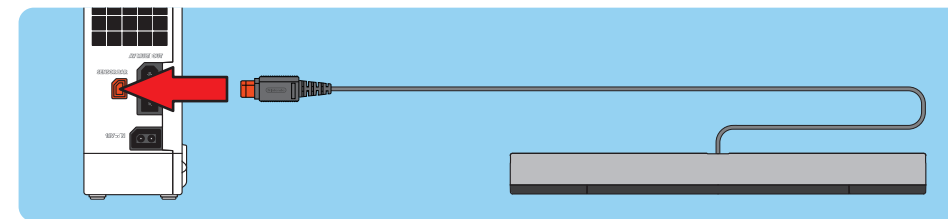

■ Placing the Sensor Bar

The Sensor Bar can be placed either above or below the TV screen.

- See page 14 for instructions on mounting the Sensor Bar to the top of the TV.
- See page 15 for instructions on mounting the Sensor Bar below the TV screen.

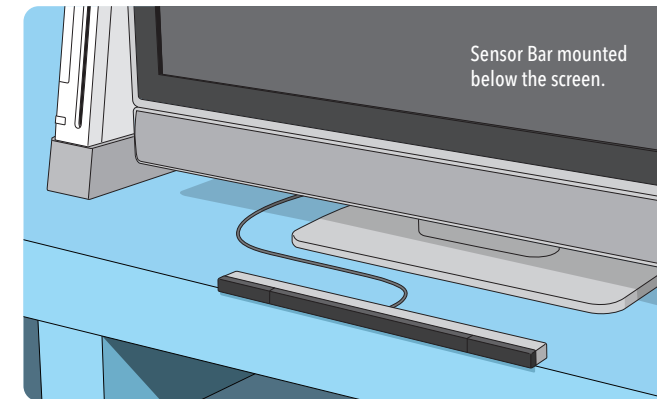
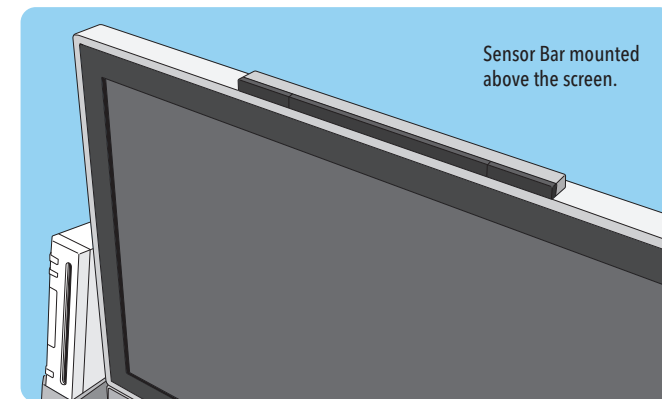

System Setup

■ Mounting the Sensor Bar Above the Screen

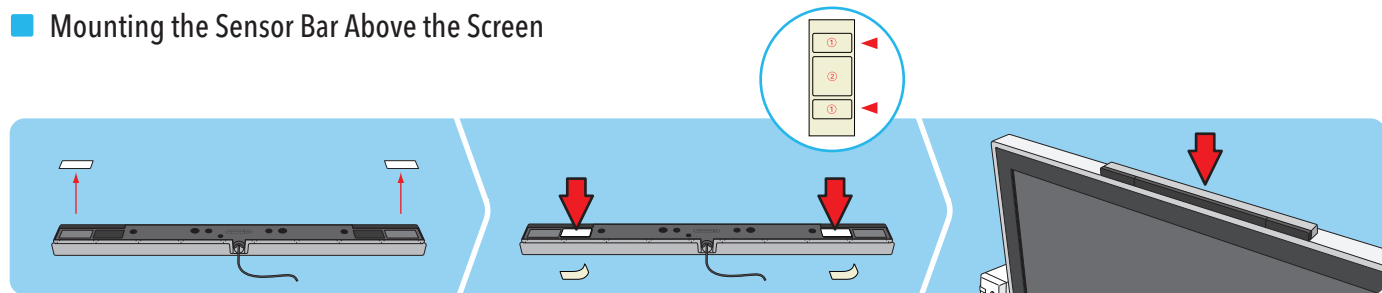

1. Remove the protective film from the foam pads on the bottom of the Sensor Bar.

2. For additional stability, you can add adhesive backed foam tape from the supplied sheet.

3. Mount the Sensor Bar to the top of the TV.

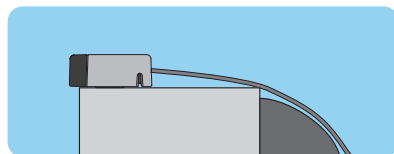

- The front of the Sensor Bar should be aligned close to the front of the TV.

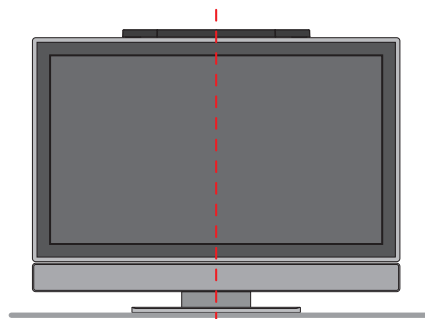

- The center of the Sensor Bar should be aligned with the center of the TV.

■ Mounting the Sensor Bar Below the Screen

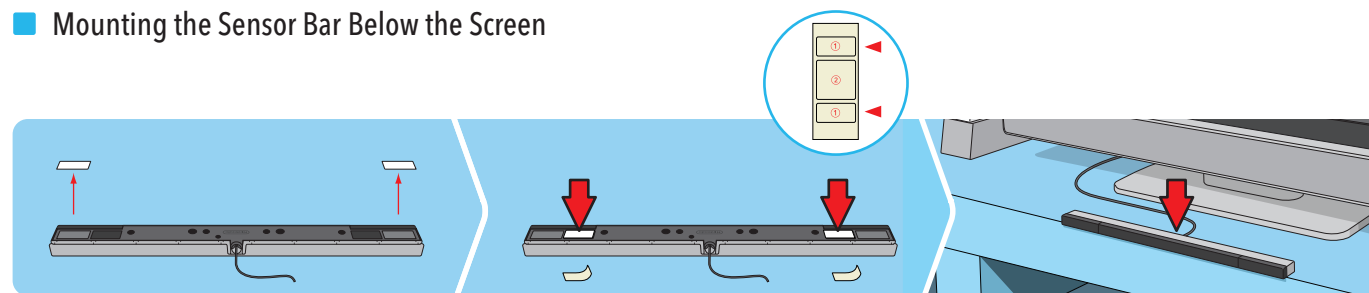

1. Remove the protective film from the foam pads on the bottom of the Sensor Bar.

2. For additional stability, you can add adhesive backed foam tape from the supplied sheet.

3. Mount the Sensor Bar to the front edge of the surface the TV is sitting on. **Do not place the Sensor Bar below the surface that the TV is sitting on; for example, on shelves below the TV.**

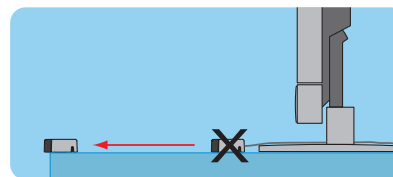

- The front of the Sensor Bar should be aligned with the front of the surface the TV is sitting on.

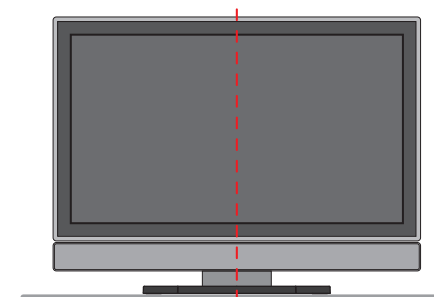

- The center of the Sensor Bar should be aligned with the center of the TV.

System Setup

Using the Sensor Bar Stand

Communication between the Wii Remote and the Sensor Bar may be improved in some situations by mounting the Sensor Bar on the Sensor Bar stand; for example, if the TV is sitting on the floor.

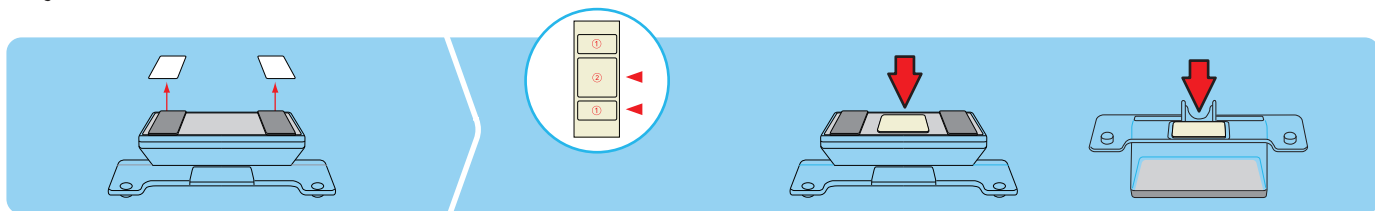

1. Remove the protective film from the foam pads on the bottom of the Sensor Bar stand.

2. For additional stability, you can add adhesive backed foam tape from the supplied sheet. These can be applied to both the top and bottom of the stand.

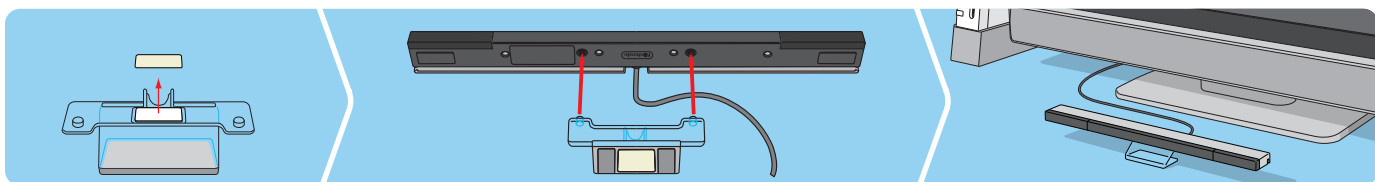

3. If you are using the extra foam tape, remove the protective film from the piece on the top of the Sensor Bar stand.

2. Attach the Sensor Bar stand to the Sensor Bar, aligning the pegs on the stand with the holes in the bottom of the Sensor Bar.

3. Mount the Sensor Bar stand to:
• the front edge of the surface the TV is sitting on, or
• to the top of the TV.
Do not place the Sensor Bar stand below the surface that the TV is sitting on; for example, on shelves below the TV.

Be sure to:

- Align the center of the Sensor Bar with the center of the TV.
- Align the front of the Sensor Bar with the front edge of the TV, or with the front edge of the surface that the TV is sitting on.

The Sensor Bar Stand can also be used on top of the TV if part of the TV blocks, or prevents proper installation of, the Sensor Bar.

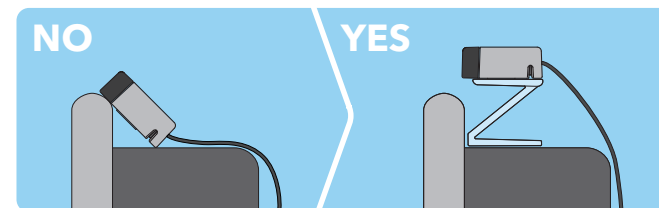

Make sure the Sensor Bar is horizontal and it is not blocked by the TV.

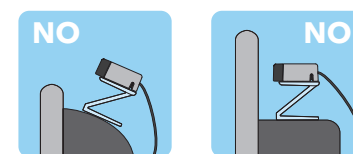

Sensor Bar cable position

If desired, the Sensor Bar cable can be fed through a channel on the bottom of the Sensor Bar to orient the cable to the left or right.

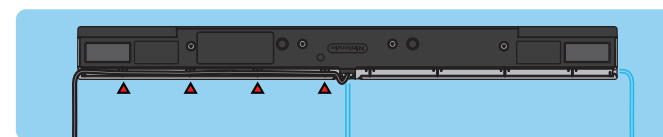

Wii AC Adapter

1. Insert the DC plug on the Wii AC Adapter cord into the DC input connector on the back of the console.
2. Insert the AC plug into a 120V AC wall outlet. **Make sure the power is off (the Power LED is red) when unplugging the AC Adapter.**

CAUTION: To prevent electric shock, match the wide blade of the plug to the wide slot and insert fully into outlet.

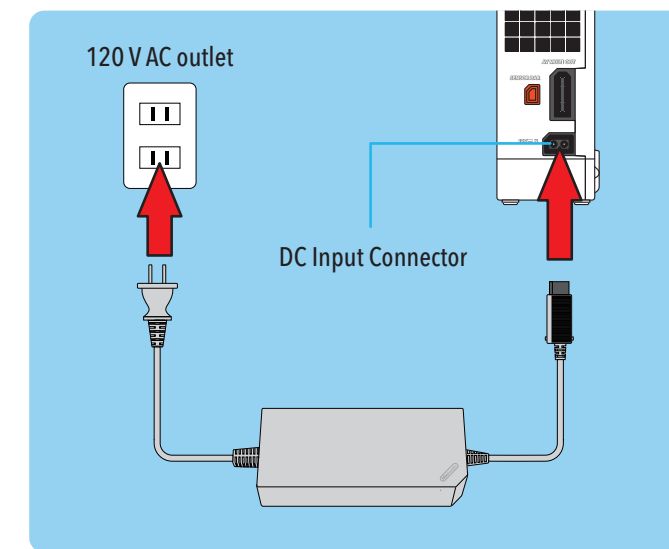

TV and Audio/Video Settings

After you have completed all steps of the setup procedure and are ready to use the Wii system, you will need to set the appropriate "input select" setting for your TV, VCR or other audio equipment.

1. Turn ON the power for your TV and any audio equipment connected to your gameplay setup and the power on the Wii console.
2. Select the correct input setting for your TV (see Input Select Information below).
3. The Wii Menu should appear on the TV screen. See the Channel section of the Operations Manual for more information on this feature.

If the Wii Menu screen does not appear, check to make sure your input setting is correct and review the Troubleshooting section on pages 31-32.

Input Select Information

The input select allows you to switch between the different inputs on your TV or VCR.

Manufacturers of TVs and VCRs use different names and locations for "input select". The common names for the input select are: input, select, input select, line, line in, source, in, EXT, and AUX. Consult your TV or VCR instruction manual for details.

NOTE: More information on "Input Select" is available on our web site at www.nintendo.com/consumer/inputselects.html

Locate the input select for the component that the Wii AV Cable is connected to (either the TV or VCR). The most common locations for input select are:

- A button on the front of the TV or VCR.
- A button on the remote control.
- A high-numbered or low numbered channel (92, 99, 00, or 02) on the TV or VCR.
- An on-screen menu selection.

Setup of the Wii Remote

The remote uses AA batteries. Nintendo recommends high quality alkaline batteries for best performance and longevity of battery life.

WARNING - Battery Leakage

Leakage of battery acid can cause personal injury as well as damage to your remote. If battery leakage occurs, thoroughly wash the affected skin and clothes. Keep battery acid away from your eyes and mouth. Leaking batteries may make popping sounds. To avoid battery leakage:

- Do not mix used and new batteries (replace all batteries at the same time).
- Do not mix different brands of batteries.
- Nintendo recommends alkaline batteries. Do not use lithium ion, nickel cadmium (nicad), or carbon zinc batteries.
- Do not leave batteries in the remote for long periods of non-use.
- Do not recharge the batteries.
- Do not put the batteries in backwards. Make sure that the positive (+) and negative (-) ends are facing in the correct directions. Insert the negative end first. When removing batteries, remove the positive end first.
- Do not dispose of batteries in a fire.

Installing Batteries

1. Remove the battery cover on the back of the Wii Remote and insert two AA batteries.
2. Be sure to insert the minus (-) end first when inserting new batteries, and remove the plus (+) end first when replacing the batteries.
3. Replace the battery cover.

CAUTION - Use the Wrist Strap

Wii gameplay with the Wii Remote can involve rapid or vigorous motion. Please use the wrist strap to prevent losing your grip on the remote and causing damage to the remote or surrounding objects, or injury to other people.

WEAR THE WRIST STRAP WHEN USING THE WII REMOTE.

- Make sure all players use the wrist strap and that the strap lock is correctly tightened.
- When sharing the Wii Remote between multiple players, make sure each person uses the wrist strap properly.
- Wearing the wrist strap will prevent you from accidentally dropping or throwing the remote during gameplay, which could damage the remote or surrounding objects, or cause injury to other people.

DO NOT LET GO OF THE REMOTE DURING GAME PLAY.

- Read the Instruction booklet for the game you are playing and follow all game control instructions for correct use of the Wii Remote or accessory controllers.
- Hold the remote securely and avoid excessive motion, as it may cause you to let go of the remote and may break the wrist strap.
- If your hands become moist, stop and dry your hands.

ALLOW ADEQUATE ROOM AROUND YOU DURING GAME PLAY.

- Stay at least three (3) feet away from the television.
- As you may move around during gameplay, make sure objects and other people are out of your range of movement or arm motion to prevent damage or injury.

Wearing the Wii Remote Wrist Strap

1. Place your hand through the wrist strap and hold the remote firmly in your hand.

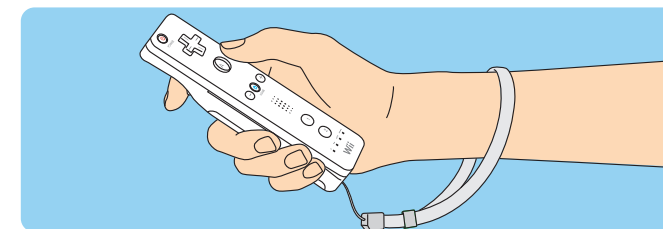

2. Slide the strap lock up so that the strap will not fall off your wrist. Do not over tighten the strap lock so that it's uncomfortable. It should just be tight enough to hold the wrist strap in place.

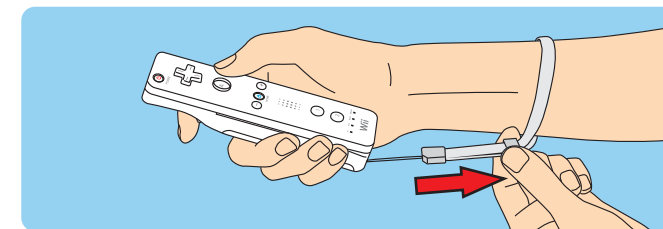

Synchronizing Your Wii Remote with the Wii Console

This procedure allows the remote to communicate with the console.

The Wii Remote included with your Wii system has been synchronized with the console at the factory.

There are two different modes of synchronizing (syncing).

STANDARD MODE - The Standard Mode procedure is used when adding additional Wii Remotes to your system or if you want to re-synchronize your original remote. Once synchronized, the remote will stay synced to the console unless you overwrite this setting by syncing the remote to a different console.

ONE TIME MODE - This mode allows you to temporarily use your remote on a console other than your own or to use a friend's remote on your console. **It does not delete the Standard Mode setting stored in the remote.** In this mode, the remote will only communicate with the console while the power is on. When the power is turned off the remote will lose its sync with the console.

- Only a Wii Remote in Standard Mode can turn the console power ON or OFF.

Standard Mode Synchronization

NOTE: Make sure you have placed batteries in the Wii Remote.

1. Press the Power button on the Wii console to turn it on.
2. Remove the battery cover on the back of the remote and press the SYNC. button inside the cover. The Player LEDs will blink.
3. Open the SD Card Slot cover on the front of the Wii console and press the SYNC. button on the inside of the compartment.
4. When the Player LED blinking stops, connection is complete. The LED that is illuminated indicates the player number.

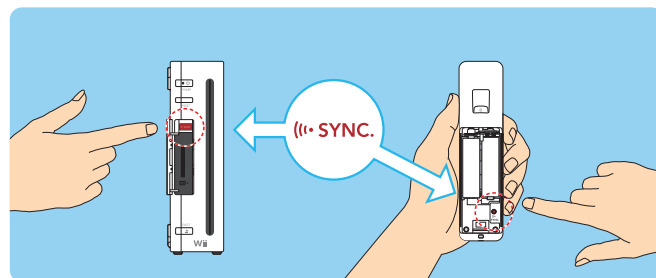

This procedure must be followed for each additional Wii Remote added to your system.

One Time Mode Synchronization

NOTE: This mode temporarily removes the Standard Mode synchronization setup for all remotes until the power of the Wii console is turned off. When the power is turned back on again, the Standard Mode settings will return.

1. Press the HOME Button on a remote that is synchronized with the console.
2. Select the Wii Remote Settings option from the Home Button menu, then select the Reconnect option.



3. Press the 1 and 2 Buttons simultaneously on the remote that you want to synchronize with the console.

The order in which you synchronize remotes will set the player order for multiplayer games.

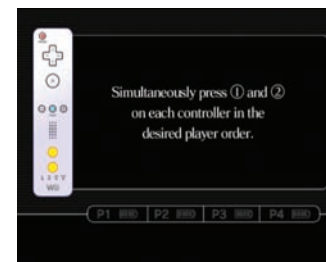

4. The Player LEDs will blink during the syncing process. When the blinking stops, the connection is complete. See diagram at right for a description of what the blinking indicates.

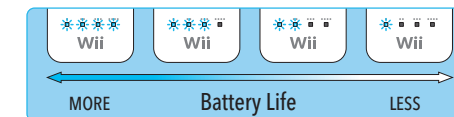

During the syncing process, the number of LEDs that blink will show the battery life of the remote that is being synchronized.

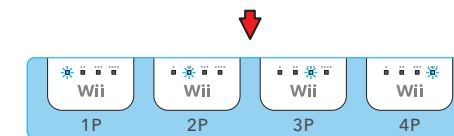

After the syncing process, LED that is lit shows the player number for that remote.

NOTE: One Time Mode synchronization is temporary. The Wii Remote will lose this synchronization under the following conditions:

- When you turn off the console by pressing the Power Button on either the remote or the console.
- When starting up a game or Channel from the Wii Menu.
- When returning to the Wii Menu after exiting from a game or Channel.
- When you select Reset on the HOME Menu screen.
- When you press the Reset Button on the front of the console.

Playing a Wii or Nintendo GameCube Game Disc

■ Before Inserting a Disc

- Turn ON the power for your TV and any audio equipment connected to your gameplay setup.
- Select the correct input setting for your TV. (See page 18, TV and Audio/Video Settings.)

■ Insert a Game Disc

Insert your Game Disc into the Game Disc slot on the front of the console. The Wii console will turn ON automatically.

- If your console is placed vertically, the disc label will face to the right.
- If your console is placed horizontally, the disc label will face upwards.

■ Starting the Game

1. Using the Wii Remote, move the cursor over the Disc Channel option on the Wii Menu screen and press the A Button to make a selection.

NOTE: Please read the Disc Channel section in the Operations manual included with your Wii system for complete information on using Game Discs in the Wii console.

2. Select "PLAY" on the game title screen to begin the game. **Review the instruction booklet for the game you are playing for specific game information.**

Game Disc Usage Precautions

Please read and follow the precautions listed below when using Wii or GameCube Game Discs in the Wii Console. Failure to do so may result in damage to your Wii system or game discs.

- To avoid pinching your finger, do not load the disc with your finger in the hole. Always handle the disc by the edges.
- Do not touch the bottom unprinted surface of the Game Disc. Always handle the disc by the edges.
- Do not use cracked, deformed or repaired discs.
- Do not bend or put excessive pressure on discs when loading into console.
- Do not leave discs in direct sunlight or expose them to high temperatures, high humidity or dust, dirt or other contaminants.
- When not using discs, store them in their cases to prevent them from getting scratched, dirty or damaged.
- Do not write on, or place stickers on any part of the disc.
- If a disc becomes dirty or contaminated with fingerprints, the system may not be able to read the game data correctly. If necessary, clean the disc with a soft, slightly damp cotton cloth (**use water only**). Clean the disc from center towards the edges; do not use a circular motion.

Wii discs

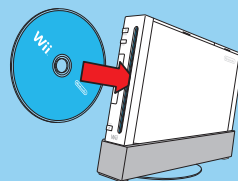

Nintendo GameCube discs

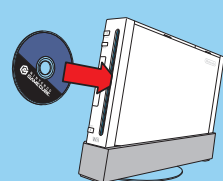

- For best results when using the Wii system, follow these recommendations.

Recommended distance: 3'-10' (from Sensor Bar to Wii Remote)

CAUTION - Adequate Space Required
Be sure you have enough space around you during game play. To avoid injury or damage, make sure other people or objects are not within your range of motion.

For best operation, play directly in front of the TV.

- For best use of the Wii Remote, follow these guidelines:

- Avoid blocking the signal between the remote, the Sensor Bar and the Wii console with objects.
- Use the remote the correct distance from the Sensor Bar. The optimal distance is between 3 and 10 feet.
- Avoid bright light sources, including sunlight, behind or near the TV, shining towards the remote or reflecting off of the screen.

- Avoid highly reflective surfaces near the Sensor Bar.
- Avoid sources of infrared light in the gameplay area such as electric, propane or kerosene heaters, flames from fireplaces or candles, and stoves or other sources of heat.
- If the remote seems to operate erratically, check and adjust the Sensor Bar sensitivity if necessary. (See page 50 in the Wii Operations Manual - Channels and Settings.)

Be sure to read the following pages on using the Wii Remote, Nunchuk and Nintendo GameCube Controllers before using the Wii system.

Using the Wii Remote

Wii Remote Configurations

Depending on the game, the way you hold and operate the remote will vary. You may need to hold the remote in either one or two hands. Read the instruction booklet for the game you are playing for information about what kind of gameplay control is required for that game.

The remote can be used by itself, or in different configurations when connected up to other Wii accessories. These configurations can be used right or left handed.

Wii Remote - Vertical Position

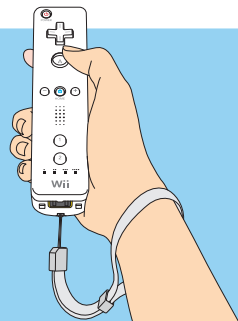

Wii Remote - Horizontal Position

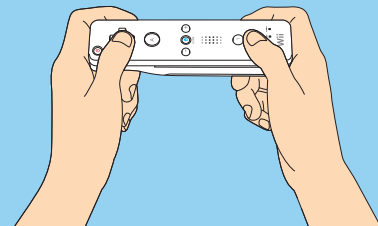

Wii Remote and Nunchuk

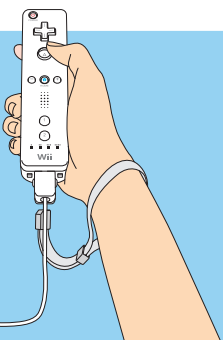

Wii Remote and Classic Controller (sold separately)



Basic Operations

Point

Point the remote at a specific place on the TV screen.

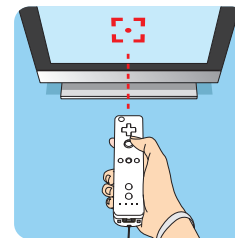

Waving

Wave the remote back and forth from side to side.

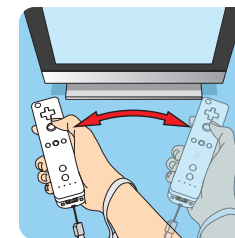

Holding or Grabbing

Point the remote at a specific place on the TV screen and move the remote while holding down a button.

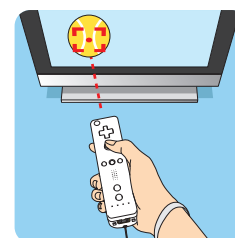

Pushing or Pulling

Move the remote forward and backward.

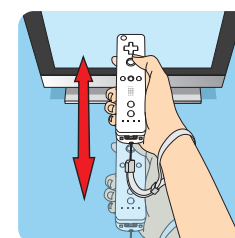

Twisting

Move the remote in a twisting motion by rotating your arm.

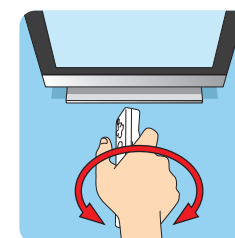

Using the Nunchuk

Setup and Use of the Nunchuk

CAUTION - Use the Wrist Strap

Wii gameplay with the Wii Remote and Nunchuk can involve rapid or vigorous motion. Please use the wrist strap to prevent losing your grip on the remote and causing damage to the remote and surrounding objects, or injury to other people.

Be sure to install the Nunchuk as described. Use the connector hook on the Nunchuk plug with the wrist strap cord to prevent the Nunchuk plug from becoming separated from the External Extension connector on the remote and striking objects or people.

■ Connecting the Nunchuk

1. Feed the cord on the wrist strap through the connector hook.

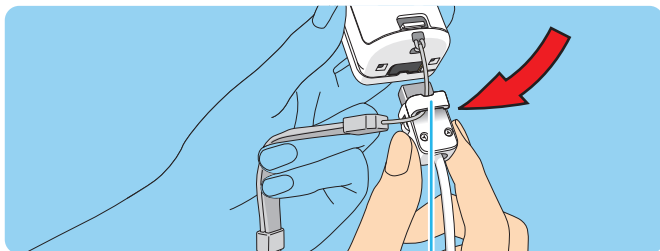

Connector Hook

2. Insert the Nunchuk plug into the External Extension Connector on the bottom of the remote until it "clicks" into place.

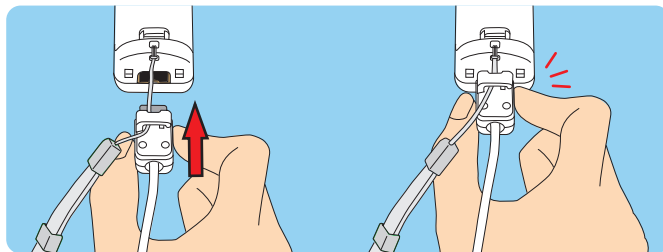

3. Place your hand through the wrist strap and hold the remote firmly in your hand. Slide the strap lock up so that the strap will not fall off your wrist. Do not over tighten the strap lock so that it's uncomfortable. It should just be tight enough to hold the wrist strap in place.

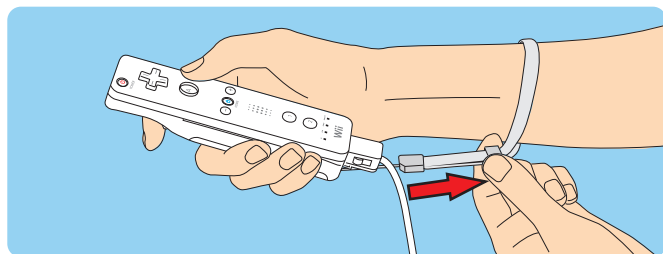

■ Holding the Nunchuk and Wii Remote (Nunchuk Style)

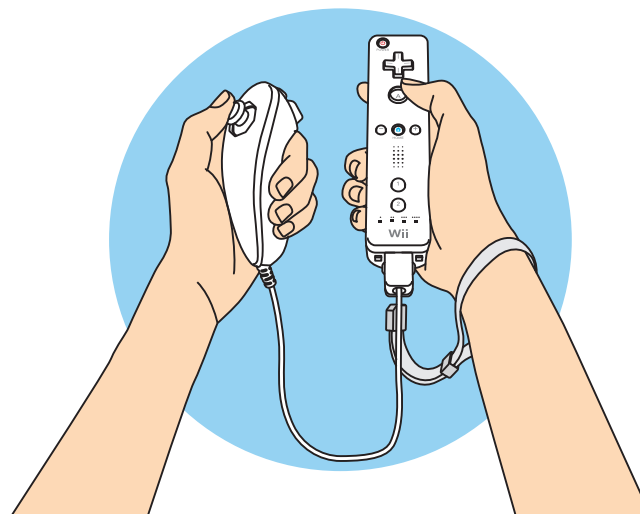

IMPORTANT: Make sure the wrist strap cord runs through the connector hook.

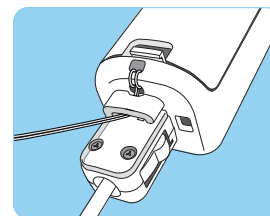

■ Disconnecting the Nunchuk

Press the Lock/Release Levers on the sides of the Nunchuk plug and pull the plug straight out of the External Extension Connector on the bottom of the Wii Remote.

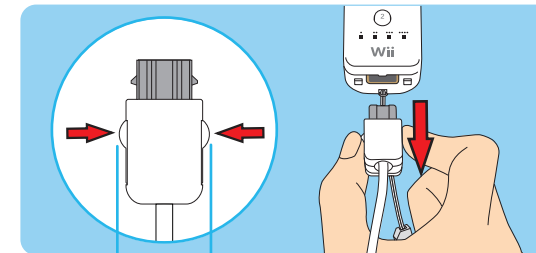

Lock/Release Levers
Squeeze levers to remove plug from Wii Remote.

Using Nintendo GameCube™ Controllers

Setup of Nintendo GameCube Controllers

NOTE: When using GameCube Controllers with the Wii console, be sure and use the stand plate to help prevent the console from being tipped over by pulling on the controller cable. (See page 11, Vertical Placement.)

Optionally, the console can be placed horizontally. When using GameCube Controllers in the horizontal position, the controller socket cover can be removed to allow the console to lay flat. See page 29 for instructions on removing the cover.

■ Connecting GameCube Controllers

NOTE: GameCube controllers only work when playing GameCube games on the Wii console.

- Plug the controllers into the GameCube Controller sockets on the side of the console.
- Review the instruction booklet for the game you are playing for the number and position of controllers required for that specific game.

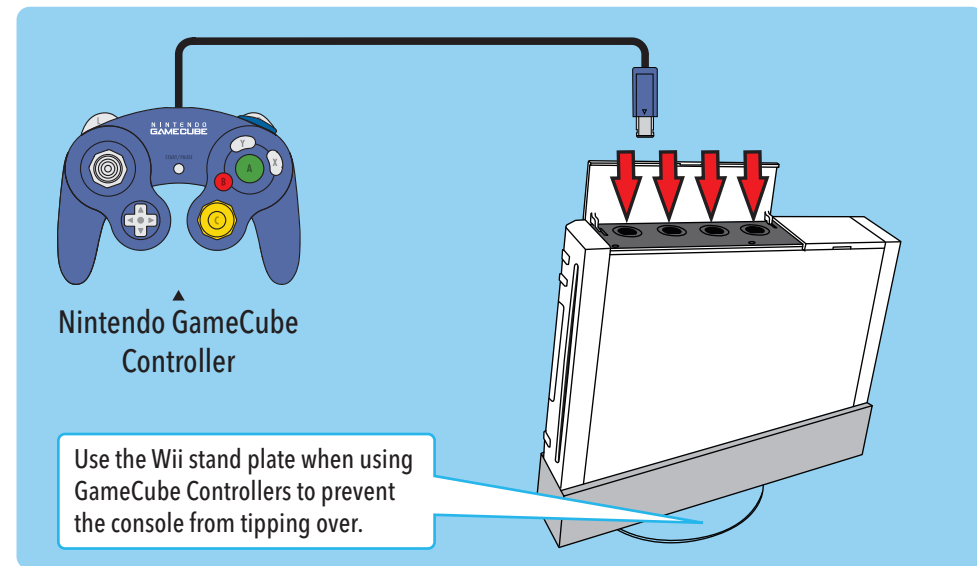

■ Removing the Controller Socket Cover

If you are using the Wii console in a horizontal position, you must remove the controller socket cover when using GameCube Controllers to allow the console to lay completely flat.

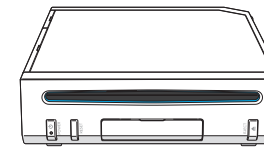

Horizontal Position

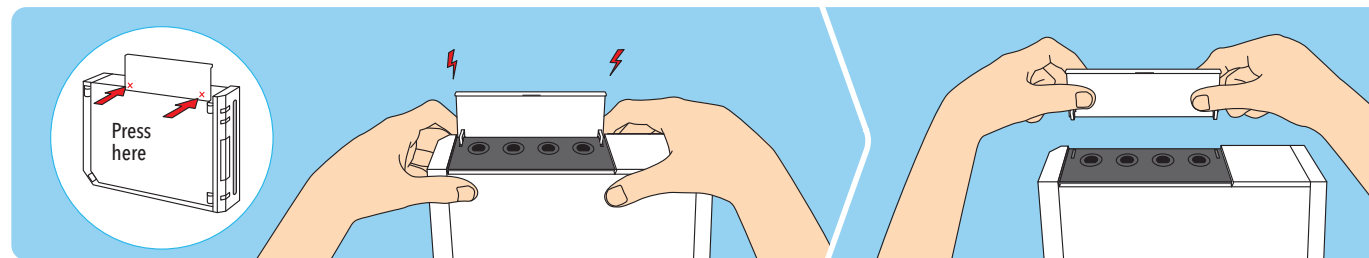

1. Stand the Wii console upright as shown and squeeze gently until you feel a slight click.

2. Remove the cover by pulling straight up out of the console.

3. The cover can be replaced by reinserting the cover straight down into the console until it clicks into place.

NOTE: The GameCube Memory Slot Cover can be removed with the same procedure, and should be removed if you are using GameCube Memory Cards when the Wii console is placed horizontally.

Using Memory Cards

Using SD Memory Cards

SD Cards are used in many digital cameras and cell phones, and for data storage on PCs. The Wii console only accepts SD memory cards, including miniSD and microSD when used with their respective adapters.

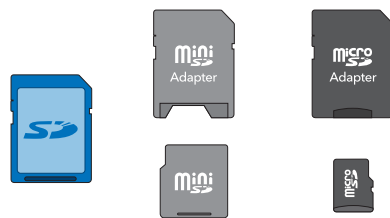

An SD memory card can be used to store Wii related data such as game save information, certain data from the Wii Channel applications, and games downloaded through the Wii Shop Channel.

- To use an SD Card, open the SD Card slot cover on the front of the console and insert the SD Card.



If purchasing a new SD Card, a list of cards that have been tested to work with the Wii console can be found at the following URL: <http://support.nintendo.com>

Using Nintendo GameCube Memory Cards

NOTE: Nintendo GameCube Memory Cards can only be used to save game information for Nintendo GameCube Game Discs.

- To use a Nintendo GameCube Memory Card, open the slot cover and insert the memory card as shown below.

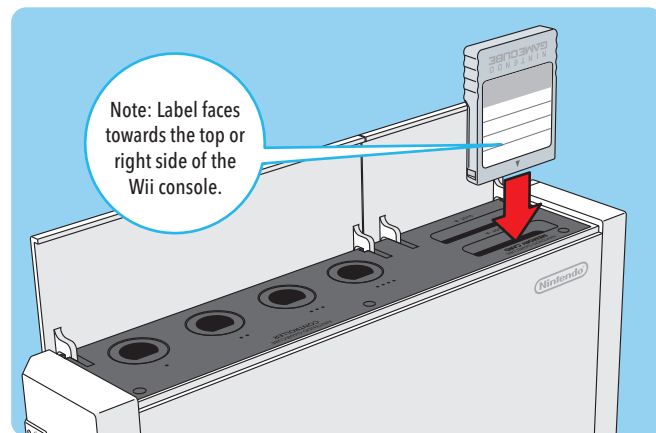

CAUTION: Do not insert or remove memory cards when reading or writing information to or from the card or initializing the card. Doing so may damage the Wii console or memory card, or permanently destroy data.

Troubleshooting (Before seeking assistance, review the following problems and solutions.)

No picture on TV screen

- Make sure you have completed all steps, in the order that they appear, on the Quick Setup sheet included with your system.
- Make sure that all components of your setup are plugged into power outlets and that all components are turned ON.
- Make sure that cable connections are correctly installed and that all plugs are securely plugged into the appropriate connectors.
- Make sure that the INPUT settings are correct for your particular setup. (Review page 18 on Input Select information.)

No sound is heard or sound quality is poor

- Make sure the TV volume is not turned off or muted.
- Make sure that all audio connections are correctly installed and that all plugs are securely plugged into the appropriate connectors.
- Make sure the Wii AV Cable is plugged into the "input" connectors on the TV or VCR, not the "output" connectors.
- Make sure that the INPUT settings are correct for your particular setup. (Review page 18 on Input Select information.)
- The sound in some games doesn't begin until the game begins.
- If you have a mono TV or VCR and have left one of the audio cables unconnected you may not get all game sounds. Use a "Y" Adapter to get both left and right sound channels.
- If your TV or VCR has both mono and stereo options, make sure it is set to match your setup.
- Check the instruction booklet for the game you are playing to see if there are volume controls or mono/stereo options that can be set from within the game.

The console Power LED does not come on, or goes off during game play

- Make sure the AC Adapter is plugged into both the wall outlet and the back of the console.
- If the light is still off, disconnect the AC Adapter plug from the wall outlet, wait 2 minutes and plug it back into the outlet. Turn the console power ON.

Wii Remote does not work or works erratically

- Review the Sensor Bar setup instructions in this manual to insure proper placement.
- Make sure the batteries are not depleted.
- Re-synchronize the remote. (See pages 20-21.)
- Check the instruction booklet for the game you are playing to make sure you are using the correct controller or accessory.
- Make sure no objects are blocking the signals between the Sensor Bar, the Wii console and the Wii Remote.
- Use the Sensor Bar Stand if the Sensor Bar is located under the TV.
- Check and adjust the Sensor Bar sensitivity if necessary. (See page 50 in the Wii Operations Manual - Channels and Settings.)
- The following conditions can interfere with the operation of the remote:

Using the remote too close or too far from the Sensor Bar. The optimal distance is between 3 and 8 feet.

Bright light sources, including sunlight, behind or near the TV, shining towards the remote or reflecting off of the TV screen.

Highly reflective surfaces near the Sensor Bar.

Sources of infrared light in the gameplay area such as electric, propane or kerosene heaters, flames from fireplaces or candles, and stoves or other sources of heat.

If you think any of these conditions are affecting the operation of the remote, try removing or reducing the source of interference.

■ Wii Remote stopped working, re-syncing does not fix the problem, player LEDs flash and then go off.

- Try a fresh set of batteries.
- Try resetting the Wii Remote – remove the batteries, wait one minute, then replace the batteries. Wait a few seconds and then try using the remote again.
- The Wii Remote sync information may need to be cleared and the remotes re-synchronized:
 1. Turn off the console, wait a moment, then turn the console on again.
 2. When you see the Health and Safety screen, press and hold the SYNCHRO Button on the console down for 15 seconds.
 3. Synchronize your Wii remotes using the procedure on page 20.
- Radio frequency interference may cause the Wii Remote to work erratically. Check for and move or turn off wireless devices such as cordless phones, wireless computer keyboards or mice or other similar devices.

■ System unable to read disc or game disc will not operate in console

NOTE: Game Discs will not start automatically. You must start disc games from the Disc Channel on the Channel Menu screen.

- Make sure the disc is inserted correctly. The label side of the disc must face to the right if the Wii console is set up vertically, or must face up if the Wii console is set up horizontally.
- Check to be sure that the Game Disc is clean and in good condition. If dirty, wipe with a soft cloth, from the center to the outside. Do not wipe with a circular motion.
- Eject the Game Disc, and turn the power OFF and then ON. Reinsert the disc and try playing the game again.
- Check that the Game Disc will work on your version of the Wii. This system will only work with Game Discs made for use in the USA, Canada, Mexico and Latin America.

■ Wii Remote or controller accessory buttons stick

Clean sticking buttons using the following procedure:

1. For the Wii Remote, remove batteries and disconnect any accessories before cleaning.
2. Use an unused toothbrush and hot tap water. **Do not use boiling water, soap or detergent.**
3. Dip the toothbrush in hot water and shake off excess amount. Lightly scrub sticking buttons, working the bristles around sides of buttons and into cracks.
4. Dry controller with soft cloth or towel and let air dry for at least 2 hours.
5. Test buttons and repeat procedure if necessary. **Do not submerge in, or pour any type of liquid onto a controller or accessory.**

■ Game Disc slot does not light blue or lights briefly.

This is the normal operation of the Game Disc slot. The slot only lights temporarily **when the system is turned on** by **a)** inserting a Game Disc, **b)** using the Power Button on the Wii Remote or **c)** using the Power Button on the Wii console. The Game Disc slot will also light temporarily if you receive a message via WiiConnect24 (this feature must be turned on to receive messages, see page 59 in the Wii Operations Manual - Channels and Settings for more information).

■ Unable to proceed passed the Language Select screen during initial setup.

- Make sure you have correctly installed the Sensor Bar. Review pages 13-16 for installation procedure.

Regulations for Equipment Use in U.S.A. and Canada

FCC and Industry Canada Information

In order to comply with FCC radio-frequency radiation exposure guidelines for an uncontrolled exposure, this device and its antenna must not be co-located or operating in conjunction with any other antenna or transmitter. This device complies with Part 15 of the FCC Rules and RSS-210 of Industry Canada. Operation is subject to the following two conditions: (1) this device may not cause harmful interference, and (2) this device must accept any interference received, including interference that may cause undesired operation. Changes or modifications not expressly approved by the manufacturer could void the user's authority to operate this device.

NOTE: This equipment has been tested and found to comply with the limits for a Class B digital device, pursuant to part 15 of the FCC Rules. These limits are designed to provide reasonable protection against harmful interference in a residential installation. This equipment generates, uses and can radiate radio frequency energy and, if not installed and used in accordance with the instructions, may cause harmful interference to radio communications. However, there is no guarantee that interference will not occur in a particular installation. If this equipment does cause harmful interference to radio or television reception, which can be determined by turning the equipment off and on, the user is encouraged to try to correct the interference by one or more of the following measures:

- Reorient or relocate the receiving antenna.
- Increase the separation between the equipment and receiver.
- Connect the equipment into an outlet on a circuit different from that to which the receiver is connected.
- Consult the dealer or an experienced radio/TV technician or call Nintendo Consumer Service at 1-800-255-3700 for assistance.

The user may find the following booklet prepared by the Federal Communications Commission helpful: How to Identify and Resolve Radio-TV Interference Problems. This booklet is available from the U.S. Government Printing Office, Washington, D.C., 20402, Stock No. 004-000-00345-4.

The term IC before the certification/registration number only signifies that the Industry Canada technical specifications were met.

If your Wii system still does not operate correctly after trying the troubleshooting steps, DO NOT return the console to the store. You will lose saved game data and all Wii Shop Channel downloads and Wii Points. Visit support.nintendo.com for assistance and additional troubleshooting and repair options or call 1-800-255-3700.

Warranty and Service information

You may need only simple instructions to correct a problem with your product. Try our website at www.nintendo.com or call our Consumer Assistance Hotline at 1-800-255-3700, rather than going to your retailer. Hours of operation are 6 a.m. to 7 p.m., Pacific Time, Monday - Sunday (times subject to change). If the problem cannot be solved with the troubleshooting information available online or over the telephone, you will be offered express factory service through Nintendo. Please do not send any products to Nintendo without contacting us first.

HARDWARE WARRANTY

Nintendo of America Inc. ("Nintendo") warrants to the original purchaser that the hardware product shall be free from defects in material and workmanship for twelve (12) months from the date of purchase. If a defect covered by this warranty occurs during this warranty period, Nintendo will repair or replace the defective hardware product or component, free of charge. The original purchaser is entitled to this warranty only if the date of purchase is registered at point of sale or the consumer can demonstrate, to Nintendo's satisfaction, that the product was purchased within the last 12 months.

GAME & ACCESSORY WARRANTY

Nintendo warrants to the original purchaser that the product (games and accessories) shall be free from defects in material and workmanship for a period of three (3) months from the date of purchase. If a defect covered by this warranty occurs during this three (3) month warranty period, Nintendo will repair or replace the defective product, free of charge.

SERVICE AFTER EXPIRATION OF WARRANTY

Please try our website at www.nintendo.com or call the Consumer Assistance Hotline at 1-800-255-3700 for troubleshooting information and repair or replacement options and pricing. In some instances, it may be necessary for you to ship the complete product, FREIGHT PREPAID AND INSURED FOR LOSS OR DAMAGE, to Nintendo. Please do not send any products to Nintendo without contacting us first.

WARRANTY LIMITATIONS

THIS WARRANTY SHALL NOT APPLY IF THIS PRODUCT: (a) IS USED WITH PRODUCTS NOT SOLD OR LICENSED BY NINTENDO (INCLUDING, BUT NOT LIMITED TO, NON-LICENSED GAME ENHANCEMENT AND COPIER DEVICES, ADAPTERS, AND POWER SUPPLIES); (b) IS USED FOR COMMERCIAL PURPOSES (INCLUDING RENTAL); (c) IS MODIFIED OR TAMPERED WITH; (d) IS DAMAGED BY NEGLIGENCE, ACCIDENT, UNREASONABLE USE, OR BY OTHER CAUSES UNRELATED TO DEFECTIVE MATERIALS OR WORKMANSHIP; OR (e) HAS HAD THE SERIAL NUMBER ALTERED, DEFACED OR REMOVED.

ANY APPLICABLE IMPLIED WARRANTIES, INCLUDING **WARRANTIES OF MERCHANTABILITY** AND FITNESS FOR A PARTICULAR PURPOSE, ARE HEREBY LIMITED IN DURATION TO THE WARRANTY PERIODS DESCRIBED ABOVE (12 MONTHS OR 3 MONTHS, AS APPLICABLE). IN NO EVENT SHALL NINTENDO BE LIABLE FOR CONSEQUENTIAL OR INCIDENTAL DAMAGES RESULTING FROM THE BREACH OF ANY IMPLIED OR EXPRESS WARRANTIES. SOME STATES DO NOT ALLOW LIMITATIONS ON HOW LONG AN IMPLIED WARRANTY LASTS OR EXCLUSION OF CONSEQUENTIAL OR INCIDENTAL DAMAGES, SO THE ABOVE LIMITATIONS MAY NOT APPLY TO YOU.

This warranty gives you specific legal rights. You may also have other rights which vary from state to state or province to province.

Nintendo's address is: Nintendo of America Inc., P.O. Box 957, Redmond, WA 98073-0957 U.S.A.

This warranty is only valid in the United States and Canada.

Rev. P

Unlicensed Accessories

Do not attach unlicensed accessories to the Wii Remote, as the use of unlicensed accessories may lead to injury to yourself or others and may cause performance issues and/or damage to the system. Use of any such unlicensed accessories will invalidate your Nintendo product warranty.

Free Manuals Download Website

<http://myh66.com>

<http://usermanuals.us>

<http://www.somanuals.com>

<http://www.4manuals.cc>

<http://www.manual-lib.com>

<http://www.404manual.com>

<http://www.luxmanual.com>

<http://aubethermostatmanual.com>

Golf course search by state

<http://golfingnear.com>

Email search by domain

<http://emailbydomain.com>

Auto manuals search

<http://auto.somanuals.com>

TV manuals search

<http://tv.somanuals.com>