

User Guide for Nokia 2260 Phone

What information is needed?	Numbers	Where is the number?
My number		Wireless service provider
Voice mail number		Wireless service provider
Wireless provider's number		Wireless service provider
Provider's customer care		Wireless service provider
Model number	2260	Label on back of phone (under battery).
Phone type	RH-39	Back of title page.
Electronic serial number (ESN)		Label on back of phone (under battery). See "Find your phone's label" on page 20.



The wireless phone described in this guide is approved for use in the TDMA and AMPS networks.

LEGAL INFORMATION

Part No. 9355957, Issue No. 1

Copyright © 2003 Nokia. All rights reserved.

Nokia, Nokia Connecting People, the Nokia Original Accessories logos, Nokia 2260, Space Impact and Snake II are trademarks or registered trademarks of Nokia. All other product and company names mentioned herein may be trademarks or tradenames of their respective owners

Printed in Canada 03/2003

US Patent No 5818437 and other pending patents.

T9 text input software Copyright ©1999-2003. Tegic Communications, Inc. All rights reserved.



Includes RSA BSAFE cryptographic or security protocol software from RSA Security.

The information contained in this user guide was written for the Nokia RH-39 phone. Nokia operates a policy of continuous development. Nokia reserves the right to make changes and improvements to any of the products described in this document without prior notice.

UNDER NO CIRCUMSTANCES SHALL NOKIA BE RESPONSIBLE FOR ANY LOSS OF DATA OR INCOME OR ANY SPECIAL, INCIDENTAL, AND CONSEQUENTIAL OR INDIRECT DAMAGES HOWSOEVER CAUSED.

THE CONTENTS OF THIS DOCUMENT ARE PROVIDED "AS IS." EXCEPT AS REQUIRED BY APPLICABLE LAW, NO WARRANTIES OF ANY KIND, EITHER EXPRESS OR IMPLIED, INCLUDING, BUT NOT LIMITED TO, THE IMPLIED WARRANTIES OF MERCHANTABILITY AND FITNESS FOR A PARTICULAR PURPOSE, ARE MADE IN RELATION TO THE ACCURACY AND RELIABILITY OR CONTENTS OF THIS DOCUMENT. NOKIA RESERVES THE RIGHT TO REVISE THIS DOCUMENT OR WITHDRAW IT AT ANY TIME WITHOUT PRIOR NOTICE.

EXPORT CONTROLS

This product contains commodities, technology or software exported from the United States in accordance with the Export Administration regulations. Diversion contrary to U.S. or Canadian law is prohibited.

FCC/INDUSTRY CANADA NOTICE

Your phone may cause TV or radio interference (for example, when using a telephone in close proximity to receiving equipment). The FCC or Industry Canada can require you to stop using your telephone if such interference cannot be eliminated. If you require assistance, contact your local service facility. This device complies with part 15 of the FCC rules. Operation is subject to the condition that this device does not cause harmful interference.

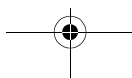
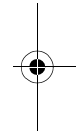
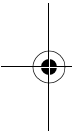



Contents

- 1 For your safety 7**
- 2 Welcome and quick guide11**
 - Get the most out of this guide 11
 - Get started with the quick guide 13
 - Understand wireless network services 15
 - Register your phone 15
 - E-newsletters 15
 - The antenna 16
 - The battery 16
 - Set up your headset 19
 - Get help 20
- 3 Basic operations 23**
 - Switch your phone on or off23
 - Make and answer calls 23
 - Check the start screen 25
 - Check in-phone help 26
 - Browse phone menus 27
 - Contact list menu 31
- 4 Text entry 32**
 - Standard text entry 32
 - Spaces, punctuation, and special characters entry 33
 - Predictive text 35
- 5 Contact list 37**
 - Use contact list menus 37
 - Save names, numbers, and e-mail addresses 37
 - Recall names and numbers 38
 - Edit a name or number 39
 - Delete names and numbers 39

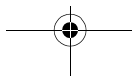
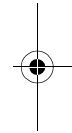
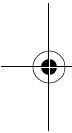

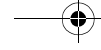

Customize your contacts view	40
Check memory status	40
6 Call log	41
Call log options	41
Check missed calls	42
Check received calls	42
Check dialed calls	42
Use call timers	43
7 Messages	44
Voice mail	44
Text, e-mail, and picture messages	45
Text messages	48
Picture messages	50
E-mail messages	51
8 Personalization	53
Profiles	53
9 Advanced calling features	60
Understand active-call options	60
Use voice privacy	62
Use call forwarding	63
Use call waiting	64
Use send own caller ID	65
Select a phone number	66
Use automatic redial	66
Use 1-touch dialing	67
Set touch tone strings	67
Link contact list entries	69
Select a system	70

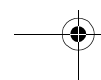
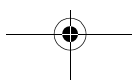
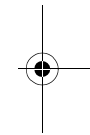
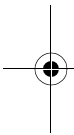



10 Security	72
Use Keyguard	72
Understand the security code	73
Restrict calls	73
11 Special features	75
Use the alarm clock	75
Use the calculator	76
Business cards	77
Download a ringing tone	78
12 Prepaid services	79
Manage prepaid service	79
Check your prepaid balance	79
Add money to your account	80
Call customer service	80
Save your access numbers	80
Expiration date	81
13 Games	82
Start a new game	82
Snake II	83
Space impact	83
Pairs II	83
14 Minute Manager	84
Check your call information	84
Check your account information	85
Customer care	86
15 Reference information	87
Battery statements	87
Proper care and maintenance	88
Important safety information	89
Make emergency calls	91

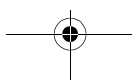
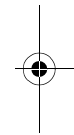
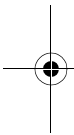



Accessory safety94

Accessories96

Technical information104

Troubleshooting105

Nokia One-Year Limited Warranty 106

Appendix A Message from the CTIA

to all users of mobile phones 111

Appendix B Message from the FDA

to all users of mobile phones 115

Index 121

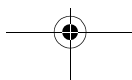
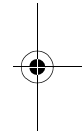
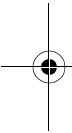

1 For your safety

Read these simple guidelines. Breaking the rules may be dangerous or illegal. Further detailed information is given in this manual.



Do not switch on the phone when wireless phone use is prohibited or when it may cause interference or danger.



ROAD SAFETY COMES FIRST

Don't use a hand-held phone while driving.



INTERFERENCE

All wireless phones may get interference, which could affect performance.



SWITCH OFF IN HOSPITALS

Follow any regulations or rules. Switch the phone off near medical equipment.



SWITCH OFF IN AIRCRAFT

Wireless devices can cause interference in aircraft.



SWITCH OFF WHEN REFUELING

Don't use the phone at a refueling point. Don't use near fuel or chemicals.



SWITCH OFF NEAR BLASTING

Don't use the phone where blasting is in progress. Observe restrictions, and follow any regulations or rules.



USE SENSIBLY

Use only in the normal position. Don't touch the antenna unnecessarily.



QUALIFIED SERVICE

Only qualified personnel may install or repair phone equipment.

For your safety



ACCESSORIES AND BATTERIES

Use only approved accessories and batteries. Do not connect incompatible products.



WATER-RESISTANCE

Your wireless phone is not water-resistant. Keep it dry.



CALLING

Ensure the phone is switched on and in service. Enter the phone number, including the area code, then press the **Talk** key. To end a call, press the **End** key. To answer a call, press the **Talk** key.



EMERGENCY CALLS

Ensure the phone is switched on and in service. Press the **End** key as many times as needed (for example, to exit a call, to exit a menu) to clear the display. Enter the emergency number, then press the **Talk** key. Give your location. Do not end the call until told to do so.

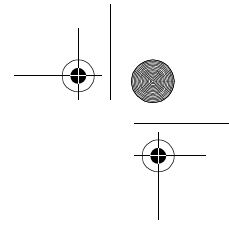
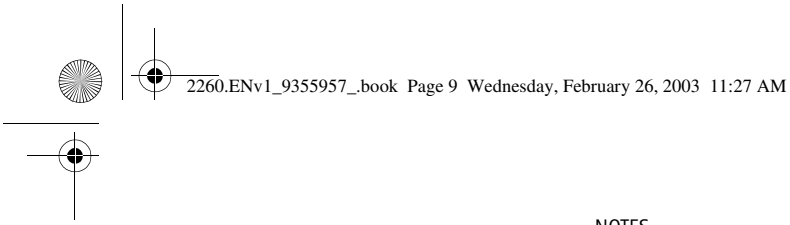

NOTES

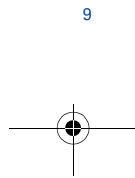
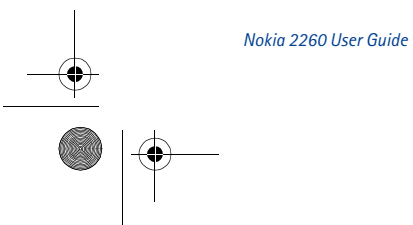
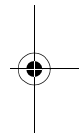
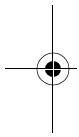

9 Copyright © 2003 Nokia

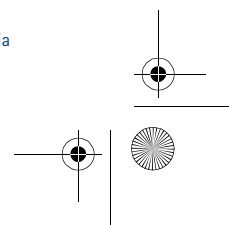

For your safety

Nokia 2260 phone at a glance

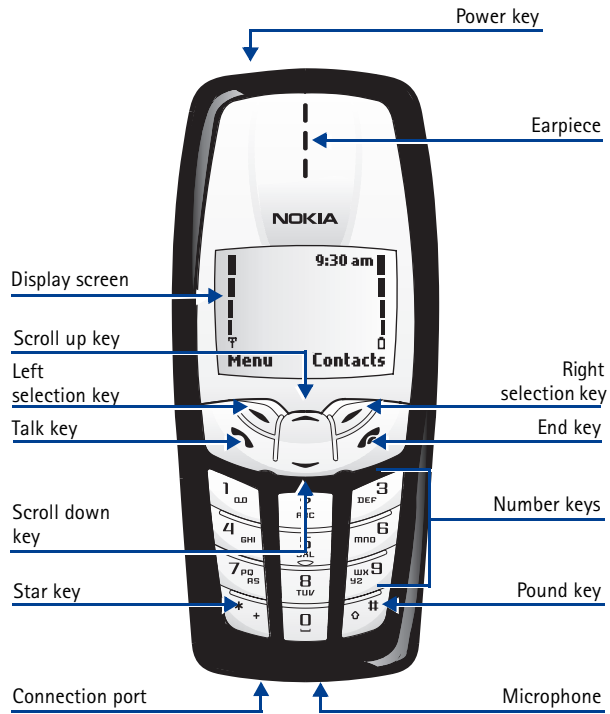

2 Welcome and quick guide

Congratulations on your purchase of a Nokia mobile phone, a new tool for the mobile information society.

• GET THE MOST OUT OF THIS GUIDE

The diagram to the left illustrates the various components of your phone. Familiarize yourself with the diagram to help you better understand the instructions that follow.

Understand the terms

This guide uses certain terms for the steps that you are asked to perform.

- **Press** means to briefly press, then release a key. For example, **press 7** means press the key on the keypad that is labeled with the number 7 and the letters, "p,q,r,s."
- **Press and hold** means to press and hold a key for two to three seconds (depending on the feature being used), then release the key.
- **Highlighted** options on the screen are enclosed within a dark bar. The selection keys are used to act on the highlighted option.
- **Selection keys** are used to select a menu option, press the selection key below the menu item on the phone's screen. In the example to the right, to select **Menu**, you would press the left selection key. To access the contact list, press **Contacts** (the right selection key).
- **Scroll keys** are used to move up and down in the menus. For example, if instructed to scroll to another contact list entry, this means to press **Scroll up** or **Scroll down** key.
- The **Talk** key is used to place a call or to answer an incoming call.
- The **End** key is used to end a call or press and hold to return to the idle screen.

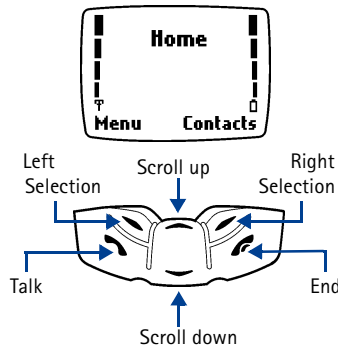

*Welcome and quick guide***Notice text clues**

This user guide provides text clues to make instructions clear and easy to follow.

Clue	What it means
bold	Indicates one of the following items: <ul style="list-style-type: none"> • The word or phrase appears on the phone's screen. • Special text, such as Notes and Warnings. • The name of one of the phone keys.
bold and blue	Indicates the text is an address on the World Wide Web.
<i>italic</i>	Italics indicate emphasis. Pay close attention to any information in italics.

Follow graphic clues

This guide uses icons (graphic clues) to alert you to important information.



Tip: Information about a shortcut or an alternate method of doing something.



Note: Explanation about a feature or an important concept.



Important: Critical information about a feature.



Caution: Help to avoid information loss.



Warning: Help to avoid personal injury, damage to the phone, or property damage.

Look for updates

From time to time, Nokia updates this user guide to reflect changes or corrections. The latest version may be available at www.nokia.com/us.

Also, an interactive tutorial may be available at www.nokiahowto.com.

• GET STARTED WITH THE QUICK GUIDE

Make a call	Enter phone number, press the Talk key.
Answer a call	Press the Talk key or Answer .
Answer with call waiting	Press the Talk key.
End a call	Press the End key.
Silence a call	Press the End key.
Redial	Press the Talk key twice.
Adjust call volume	During a call, press the Scroll up key to increase the volume or the Scroll down key to decrease the volume.
Use the in-call menu	In a call, press Options .
Use 1-touch dialing	Press and hold one of keys 2-9.
 Save a name and number	Enter a number, press Save , enter a name, and press OK .
Retrieve a name/number	Press Contacts , select Find .
Retrieve a name/number during a call	Press Options , scroll New call , press Select , press Find , enter first letter of the name.
Check voice mail	Press and hold 1 or call your voice mailbox number.
Send a text message	Press Menu 1-1 . Write the message. Press Options (Send will be the first option), press Select , enter the recipient's number, then press Send .
Send a business card	Retrieve a name from the contact list, press Options , select Send bus. card , enter the recipient's number, then press Send .

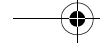

Welcome and quick guide



Send an e-mail message

Press **Menu 1-2**. Enter the recipient's address, press **OK**, enter the subject, press **OK**, write the message, press **Options**, scroll to **Send**, then press **Select**. (You may need to enter the gateway number your service provider gave you.)

Read new message

Press **Read**. If you have more than one message, scroll to the one you want, then press **Read** again.

Reply to a message

Press **Options**, scroll to **Reply**, then press **Select**.

Reply to an E-mail message

When reading the message, press **Options**, scroll to **Reply**, then press **Select**.

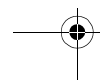
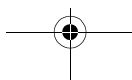
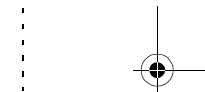
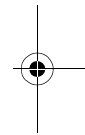
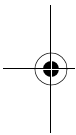

• UNDERSTAND WIRELESS NETWORK SERVICES

The wireless phone described in this guide is approved for use on the TDMA and AMPS networks. A number of features included in this guide are called Network Services. These are special services you arrange through your wireless service provider. Before you can take advantage of any of these Network Services, you must subscribe to them through your service provider and obtain instructions for their use from your service provider.



Note: Some networks may not support all language-dependent characters and/or services.

Network services for your Nokia phone include:

- Voice mail and voice privacy
- Call waiting, call forwarding, and caller ID
- Text, e-mail, and picture messages
- Ability to send your own number

Sign up with a service provider

Before you can use any network services, you must sign up with a wireless service provider. Your service provider will supply descriptions of special features and instructions for using their services.

• REGISTER YOUR PHONE

Make sure to register your phone at www.warranty.nokiausa.com or 1-888-NOKIA-2U (1-888-665-4228) so that we can better serve you, if you should need to call the center or have your phone repaired.

• E-NEWSLETTERS

When you register your phone, you can sign up for Nokia's e-newsletter *Nokia Connections* if you would like. You will receive tips and tricks on using your phone, accessory information, and special offers.

Welcome and quick guide

• THE ANTENNA



Tip: Your phone has a built-in antenna. As with any other radio transmitting device, do **not** touch the antenna unnecessarily when the phone is switched on.

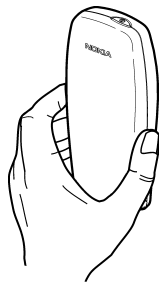

Contact with the antenna affects call quality and may cause the phone to operate at a higher power level than otherwise needed.

Not touching the antenna area during a phone call optimizes the antenna performance and the talk-time of your phone. Normal position: Hold the phone as you would any other telephone with the antenna pointed up and over your shoulder.

• THE BATTERY

This section tells you how to install and remove the battery. You will need to remove the battery when replacing it, or to view the phone's label (located under the battery). For important safety information on using batteries and chargers, see "Accessory safety" on page 94.

Install the battery

- 1 Place the battery in the compartment with the label side facing up and the golden contact area of the battery aligned with the contact prongs inside the phone.
- 2 Press down on the battery until it snaps into place.

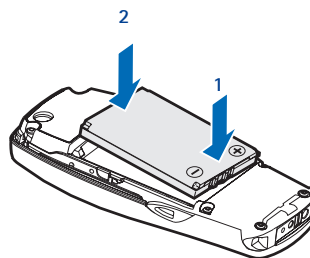

- 3 Align the cover over the back of the phone, placing the end of the cover approximately 1/4 inch past the end of the phone. Lower the back cover onto the phone.

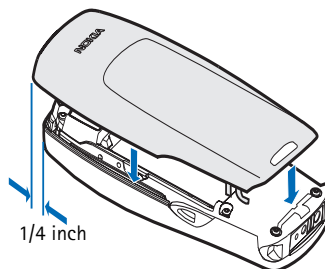

- 4 Press down slightly and slide the cover until it locks into place.

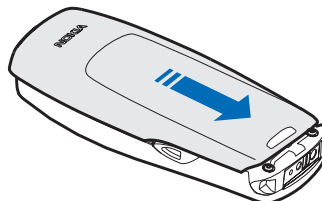

Remove the battery

If you purchase a new battery or need to access information on the phone's label, you may need to remove the battery. Make sure the phone has been turned off for at least 10 seconds.

 **Important:** Dispose of batteries according to applicable local regulations (for example, recycling). Do not dispose as household waste.

- 1 Hold the phone with the back facing you. At the bottom corners of the phone, press the battery cover with your thumb and forefinger.
- 2 Place the thumb of your other hand in the groove, approximately 1 inch from the top of the phone. Apply pressure with the thumb, slide the back cover toward you to release it, then remove it.

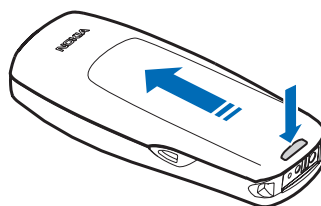

Welcome and quick guide

- 3 Look for the battery latch that runs along the end of the battery nearest the top of the phone.
- 4 Place your thumbs on the corners of the latch and press away from the battery.
- 5 Once the battery is released from the latch, it will lift slightly so that it can be removed from the phone.

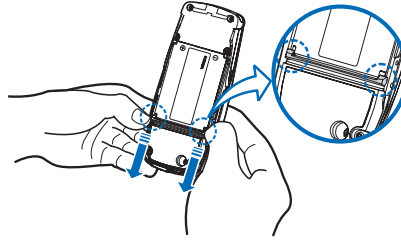

Warning: Use only your hands to remove the battery. Do not use any objects that may damage the phone or the battery.

Charge the battery

Before you begin using your phone, you need to prepare your phone by charging the battery.

- 1 Plug the charger into a standard wall outlet, then connect the lead from the charger to the bottom of the phone.
- 2 The battery power indicator (or battery bar) appears on the screen and starts scrolling. **Charging** appears if the phone is on.
- 3 When the battery bar stops scrolling, the battery charge is complete. **Battery full** appears if the phone is on.
- 4 Disconnect the charger from the phone.

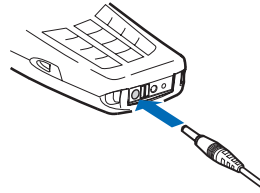
**IMPORTANT BATTERY INFORMATION**

Use the following guidelines to obtain the best performance from your battery:

- With your phone turned off, charge your new battery for three hours before its first use. Use the battery until it is fully discharged. Repeat this procedure twice for a total of three charging cycles.
- Battery operation time may be less than the estimated times during the first charges. This condition is normal.
- If the battery is fully discharged, the scrolling bars may not appear immediately when charging.
- After the first charge, you can make and receive calls during the charging cycle, but the calls interrupt the charge. When the phone call ends, the charge will resume.

- The bars on the screen stop scrolling and remain constant when the phone is charged. If you leave the phone connected to the charger, the battery receives an additional charge.



Note: The battery will accept a "trickle charge" for an additional two hours. See "Reference information" on page 87 for more information on batteries.

- Charging time depends on the charger and battery used. See "Batteries" on page 95 for charging, talk, and standby times.

PROLONG BATTERY LIFE

For good operation times with NiMH batteries, discharge the battery from time to time by leaving your phone switched on until it turns itself off. Ignore any messages to recharge your battery and let the battery completely discharge.



Important: Do not attempt to discharge the battery by any other means.

• SET UP YOUR HEADSET

Your phone is compatible with the HDC-5, HDC-10, HDE-2, and HDB-5 headsets. The headset provides convenient, hands-free use of the phone.

Connect the headset

- 1 Plug the headset plug into the bottom of your phone.
- 2 Put the round ear plug into one ear.

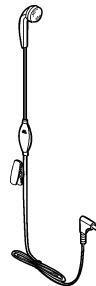

Use the headset

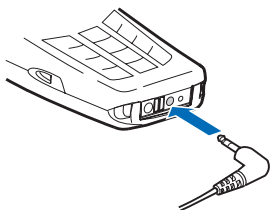

With the headset connected, you can make and answer calls as usual.

The microphone for the headset hangs at the side of your head. Although the microphone may seem far from your mouth, you can speak at a normal volume.



Note: You can set your phone to answer automatically when the headset is connected. See "Automatic answer" on page 57 for more information.

Welcome and quick guide

• **GET HELP**

Find your phone's label

When you call the Nokia Customer Care Center or your service provider, you will need to provide specific information about your phone. This information is recorded on the phone's type label. The type label is located under the battery inside the phone's back cover. It contains the model and serial numbers as well as other important information about your phone. Please do not remove or deface the label.

Contact Nokia

If you have a question and have already checked the Troubleshooting section (see page 105), we recommend that you have the following information available before contacting the Nokia Customer Care Center or your service provider:

- Your phone's model number
- **ESN** (Electronic serial number – located on the label under the battery)
- Your billing address ZIP code
- The phone or accessory in question

Nokia Customer Care Center, USA	Customer Care Centre, Canada
Nokia Mobile Phones 7725 Woodland Center Blvd. Suite #150 Tampa, Florida 33614 Tel: 1-888-NOKIA-2U (1-888-665-4228) Fax: 1-813-249-9619 For TTY/TDD users: 1-800-24-NOKIA (1-800-246-6542)	Nokia Products Ltd. 601 Westney Road South Ajax, Ontario L1S 4N7 Tel: 1-888-22-NOKIA (1-888-226-6542) Fax: 1-905-427-1070 Web site: www.nokia.ca

Contact your service provider

You may want to save your service provider's customer support telephone number into your phone. This will let you easily contact your provider if you have questions or issues with your phone service.

Receive accessibility information

Nokia is committed to making mobile phones easy to use for all individuals, including those with disabilities. Nokia maintains an internet site that is dedicated to accessibility solutions. For more information about phone features, accessories and other Nokia products designed with your needs in mind, visit the web site at:

www.nokiaaccessibility.com

LPS-3 MOBILE INDUCTIVE LOOPSET

The LPS-3 Loopset is a Nokia accessory designed to make the phone more accessible to hearing-aid users. The loopset gives hearing-aid users clear access to digital telephony for the first time. It allows people with T-coil equipped hearing aids to make and receive calls without noise interference.

To activate the Loopset, see "Accessory settings" on page 56.



Note: The loopset is sold separately as an accessory to the phone.

HOW THE LOOPSET WORKS

The LPS-3 Loopset uses inductive technology to transmit sound to a hearing aid equipped with a T-coil. The sound from the phone is amplified more efficiently and background noise is eliminated.

The loopset is easy to use. Wear the loopset around your neck, connect it to your phone, and speak directly toward the microphone. For detailed instructions on using the loopset, refer to the booklet that comes with the LPS-3.

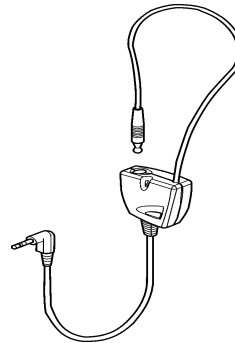

Set up the TTY/TDD profile

You can connect your phone to a TTY/TDD using the Nokia TTY/TDD Adapter (HDA-9). In order for your phone to recognize the TTY/TDD, you will need to connect the adapter to your phone.



Important: Some manufacturers of TTY/TDD devices suggest that the phone be least 18 inches from the TTY/TDD device. When connecting to any other device, read its user guide or contact its manufacturer for detailed instructions and safety information.

- 1 Connect the TTY/TDD with a cable to the HDA-9 adapter.

Welcome and quick guide

- 2 Plug the HDA-9 adapter into the connector on the bottom of your phone, as shown in the illustration.

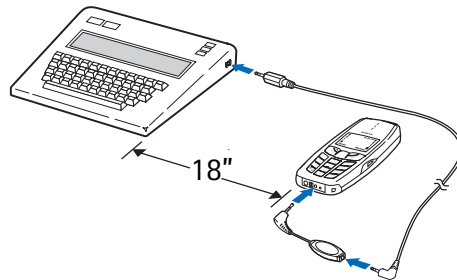

- 3 Press **Menu 4-4-4-1** (**Settings > Accessory settings > TTY/TDD > Use TTY**).
- 4 Scroll to **Yes**, then press **Select**.

NOTES ABOUT TTY/TDD CALLS

- The Nokia TTY/TDD Adapter (HDA-9) is for use with compatible TTY/TDD devices only. Check with the manufacturer of the TTY/TDD device to ensure that the connection is compatible.
- Check with the manufacturer of the TTY/TDD device for the appropriate connecting cable.
- TTY/TDD communications depend on network availability. Check with your service provider for availability and description of services.

MAKE A TTY/TDD CALL



Tip: Before making a TTY/TDD call with your phone, check the signal strength. See "Understand indicators and icons" on page 25 for details.

- 1 From the start screen, enter the number, and press the **Talk** key.
- 2 When the receiving party answers, begin typing your conversation on the TTY/TDD.

RECEIVE A TTY/TDD CALL

- 1 Make sure the TTY/TDD device is connected to your phone.
- 2 Press the **Talk** key to answer the call, then type your responses on the TTY/TDD.

END A TTY/TDD CALL

Press the **End** key.

3 Basic operations

This section gives a brief introduction to the phone and shows quick steps for:

- Making and answering calls
- Adjusting the earpiece volume
- Navigating through menus
- Using menu shortcuts

You will also find information about the phone's icons and how to use in-phone help. The rest of this guide provides complete details on phone use.

• SWITCH YOUR PHONE ON OR OFF



Warning: Do not switch on the phone when wireless phone use is prohibited or when it may cause interference or danger.

To switch on your phone, press and hold the power key for 2 seconds.

To switch off your phone.

- Press and hold the power key.
- OR
- Press the power key quickly. When **Switch off!** is highlighted on the screen, press **Select**.

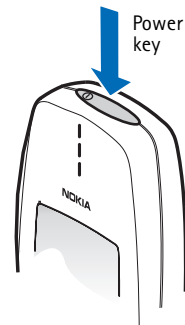

• MAKE AND ANSWER CALLS

There are several ways to make and answer calls on your phone. Once learning about the basic methods, you will discover other tips throughout this guide when reading about the phone's features.

Use the keypad

- 1 Enter the phone number, including the area code if needed.
- 2 Press the Talk key.



Important: Do not touch the antenna when the phone is switched on. Contact with the antenna affects call quality and may cause the phone to operate at a higher power level than otherwise needed.

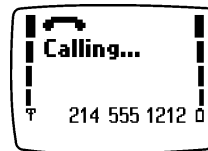

Basic operations

Use the contact list

- 1 From the start screen, press the **Scroll up** or **Scroll down** key and scroll to the number you want.
- 2 Press the **Talk** key to make the call.



Tip: To skip ahead quickly in the list, press the number key that has the first letter of the name. You may have to press the key more than once to get to the correct letter.

Make a 1-touch dial call

Press and hold the key assigned to the number you wish to call.

To learn how to store a number for use with 1-touch dialing see "Assign a key to 1-touch dialing" on page 67.

End a call

Press the **End** key to end the call or to cancel the call attempt.

Answer a call

When your phone rings, press the **Talk** key. You can press any key to answer a call except the power key, end key, or the scroll keys.



Note: If Keyguard is active, the keypad will unlock when you have an incoming call.

Silence an incoming call

Press the **End** key or **Silent** to mute the ringing of an incoming call.

Redial the last-dialed number

Press the **Talk** key twice.

Adjust the earpiece volume

Adjust the earpiece volume during a call by pressing the scroll keys located just below the screen.

- Press the **Scroll up** key to increase the volume.
- Press the **Scroll down** key to decrease the volume.

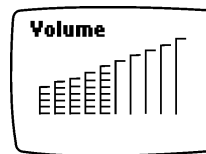

• CHECK THE START SCREEN

When you switch on your phone, a welcome appears, then you see the start screen.

The start screen appears when the phone is idling or standing by.

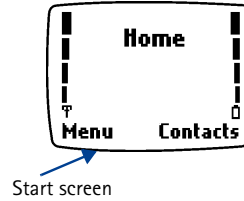

Understand the Scroll Bar

When you press **Menu**, a vertical scroll bar appears on the right side of the screen. This scroll bar has a tab which moves up or down to indicate your location in the menu.

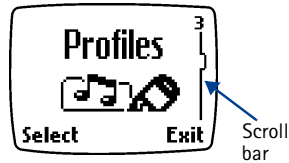

Understand indicators and icons

You have two types of identifiers on your phone:

Indicators show the status of something. The phone uses three types of indicators: signal strength, battery power and handset volume.

Icons are graphical representations of a specific item or situation. For example, an icon appears when you have a voice message in your mailbox.



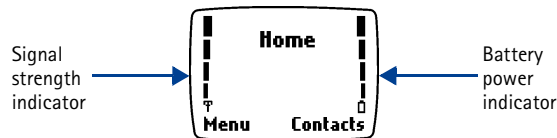







Indicators



- Signal strength – shows the signal strength of the wireless network at your current location. The higher the bar, the stronger the signal.
- Battery power – shows the battery charge level. The higher the bar, the more power in the battery.

Basic operations

Icons

Screen Icon	What it means
	Active call in progress.
	Silent has been selected as the current profile.
	The phone's keypad is locked to prevent any accidental key presses.
	One (or more) new voice messages waiting.
	One or more new text messages waiting. (If blinking, the text message memory is full.)
	Digital service is available.
	Standard text input mode for entering alpha characters. Press to switch between uppercase and lowercase input.
	Predictive text mode for quickly entering text messages. Press # to switch between uppercase and lowercase input.
	123 mode. This icon appears when you press and hold # while entering text. You can now enter only numbers (not alpha characters). Press and hold # again to return to text entry mode.
	Special character mode. This appears when you press * while entering text. Once the characters appear, you can select a special character by selecting Insert .
	Alarm clock is set.

- **CHECK IN-PHONE HELP**

Many menu items have brief help text. To view the help text, scroll to the menu item and wait for about 15 seconds. Press **More** or the **Scroll down** key to continue reading the text. Press **Back** to exit or wait a few seconds to return to the current menu.



• BROWSE PHONE MENUS

A menu is a list of choices you can make to change settings on your phone or use various phone features. Each menu can contain several levels of submenus. You can use menus and submenus two ways: by scrolling or by using a shortcut. This guide uses the shortcut method when describing how to use the phone's features.

Scroll through menus

- 1 At the start screen, press **Menu**, then scroll through the menus using the **Scroll up** and **Scroll down** keys.
- 2 Use the scroll and selection keys to navigate the submenu; press the **End** key to return to the start screen.

For example, when you see (**Menu > Profiles > Silent**) the scrolling method is: press **Menu**, scroll to **Profiles** and press **Select**, scroll to **Silent** and press **Options**.

Return to the previous menu level

You can return to the previous menu level by pressing the selection key labeled **Exit** or **Back**. Return to the start screen from any menu level by pressing the **End** key.

Use shortcuts

Menus and options are numbered so that you can quickly find your way to an option. The numbers appear in the top right corner of the screen and show your location in the menu.

- 1 Press **Menu**.
- 2 Within 3 seconds, enter the first number of the menu function you want to access.
- 3 Repeat until you have entered all the numbers.

For example, to select the **Silent profile**, press **Menu 3-2-1**.



MENU TIPS

- You can scroll upward to quickly access the last option in a menu list.
- You can return to the previous menu level by pressing **Back**.
- To exit a menu and return to the start screen, press the **End** key. If you leave a menu by pressing the **End** key, you cancel any changes you made.
- Some menus may not appear. Ask your service provider for details.

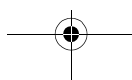
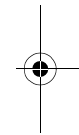
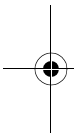

Basic operations

Menu shortcuts

1 MESSAGES

- 1 Write message 1-1
- 2 Write e-mail 1-2
- 3 Inbox 1-3
- 4 Outbox 1-4
- 5 Archive 1-5
- 6 Delete all 1-6
- 7 Picture messages 1-7
- 8 Voice messages 1-8
 - 1 Listen to voice messages 1-8-1
 - 2 Voice mailbox number .. 1-8-2

2 CALL LOG

- 1 Missed calls 2-1
- 2 Received calls 2-2
- 3 Dialed calls 2-3
- 4 Clear call lists 2-4
 - 1 All 2-4-1
 - 2 Missed 2-4-2
 - 3 Received 2-4-3
 - 4 Dialed 2-4-4
- 5 Call timers 2-5
 - 1 Duration of last call. . . 2-5-1
 - 2 Duration of all calls. . . 2-5-2
 - 3 Clear timers 2-5-3

3 PROFILES

- 1 Normal 3-1
 - 1 Select 3-1-1
 - 2 Customize 3-1-2
 - 1 Ringing options . . . 3-1-2-1
 - 2 Ringing tone. 3-1-2-2
 - 3 Ringing volume . . . 3-1-2-3
 - 4 Vibrating alert . . . 3-1-2-4
 - 5 Message alert tone. 3-1-2-5
 - 6 Keypad tones 3-1-2-6
 - 7 Warning tones 3-1-2-7
 - 8 Profile name¹
- 2 Silent 3-2
 - 1 Select 3-2-1
 - 2 Customize 3-2-2
- 3 Meeting 3-3
 - 1 Select 3-3-1
 - 2 Customize 3-3-2
- 4 Outdoor 3-4
 - 1 Select 3-4-1
 - 2 Customize 3-4-2
- 5 Pager 3-5
 - 1 Select 3-5-1
 - 2 Customize 3-5-2

¹ The Profile name option is available for Silent, Meeting, Outdoor and Pager. The Normal profile cannot be renamed.

4 SETTINGS

- 1 Time settings 4-1
 - 1 Alarm clock 4-1-1
 - 1 On 4-1-1-1
 - 2 Off 4-1-1-2
 - 2 Clock 4-1-2
 - 1 Show/Hide clock.. 4-1-2-1
 - 2 Set the time 4-1-2-2
 - 3 Time format 4-1-2-3
 - 3 Auto-update of time... 4-1-3
- 2 Call settings 4-2
 - 1 Automatic redial..... 4-2-1
 - 2 Current call timer 4-2-2
- 3 Phone settings 4-3
 - 1 Language 4-3-1
 - 2 Touch tones 4-3-2
 - 1 Manual touch tones 4-3-2-1
 - 2 Touch tone length 4-3-2-2
 - 3 Welcome note 4-3-3
 - 4 Restore factory settings 4-3-4
- 4 Accessory settings¹ 4-4
 - 1 Headset 4-4-1
 - 2 Handsfree 4-4-2
 - 3 Loopset 4-4-3
 - 4 TTY/TDD 4-4-4
- 5 Security settings 4-5
 - 1 Call restrictions..... 4-5-1
 - 2 Change security code.. 4-5-2

¹ The Accessory settings menu will not appear until after an accessory has been connected to the phone.

- 6 Network services 4-6
 - 1 Voice privacy 4-6-1
 - 2 Call forwarding² 4-6-2
 - 3 Call waiting² 4-6-3
 - 4 Send own caller ID²... 4-6-4
 - 5 Network feature setting 4-6-5
 - 6 Own number selection 4-6-6

² Call forwarding, call waiting and send own caller ID are network-dependent features. In some networks, the codes for these features must be activated and these sub menus will not appear until they are activated.

5 SYSTEM

- 1 Automatic 5-1
- 2 Manual 5-2
- 3 New search 5-3

6 GAMES

- 1 Snake II..... 6-1
- 2 Space Impact..... 6-2
- 3 Pairs II..... 6-3
- 4 Settings 6-4

7 CALCULATOR

Basic operations

8 PREPAID¹



- 1 Check account balance8-1
- 2 Add money to account.....8-2
- 3 Call customer service.....8-3
- 4 Save access phone numbers8-4
 - 1 Balance phone number8-4-1
 - 2 Replenish phone number8-4-2
 - 3 Customer service phone number8-4-3
- 5 Expiration date.....8-5

¹ The Prepaid menu is visible only when prepaid service is available in your network and/or activated on your account. Please contact your service provider for more information on Prepaid services.

9 MINUTE MGR.²

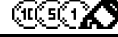

- 1 My calls.....9-1
- 2 My account.....9-2
- 3 Customer care.....9-3

² The Minute Manager menu is visible only when Minute Manager service is activated on your account. Please contact your service provider for more information.

• CONTACT LIST MENU

For access to the contact list and its menus:

- 1 Switch back to the start screen.
- 2 Press **Contacts**.

These options are available:

- 1 **Find**
- 2 **Add new**
- 3 **Delete all**
- 4 **Options**
 - 1 **Contacts view**
 - 2 **Memory status**
- 5 **1-touch dialing**

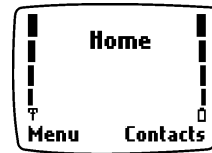

Text entry

4 Text entry

There are two ways to enter letters and numbers into your phone:

- Standard text input - for making entries in the contact list.
- Predictive text input - for writing text messages, picture messages, and e-mails. For more detail, see "Predictive text" on page 35.

Current entry method

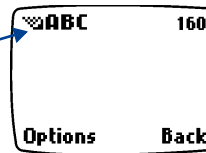

• STANDARD TEXT ENTRY

Standard text input is used when entering text into information prompts. You can use this method for all text entry, but predictive text input is the faster method for writing messages.

Enter letters (ABC mode)

When you add new names to the contact list, your phone automatically switches to the ABC mode and displays the  icon.

- 1 Find the key that has the letter you want to enter.
- 2 Press the key as many times as needed for the letter to appear on the screen.

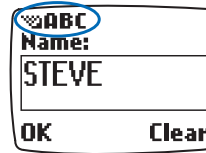

Enter numbers (123 mode)

To enter numbers:



- 1 Press and hold # to switch to 123 mode. Press the appropriate number key to enter a number.
OR
While in ABC mode, press and hold the corresponding number key until the number appears. If you make a mistake, press **Clear** to delete that character.
- 2 To return to the ABC mode, press and hold # again for two seconds.

DELETE MISTAKES

If you make a mistake, press **Clear** as needed to delete one or more characters. Press and hold **Clear** to delete the entire field of characters.

CHANGE FROM CAPITAL (UPPERCASE) LETTERS

To switch between capital (uppercase) and lowercase letters, press #.

The  icon in the upper left corner of the screen switches to , indicating that you can now enter lowercase letters. To switch back to uppercase letters again, press #.

• SPACES, PUNCTUATION, AND SPECIAL CHARACTERS ENTRY

Depending on the selected display language, the following characters may be available when entering characters from the keypad:

Key	Characters	Key	Characters
1	. , ' ? ! @ ~ / " - 1	8	T U V 8
2	A B C 2	9	W X Y Z 9
3	D E F 3	0	Enters an empty space or 0.
4	G H I 4	*	Special characters
5	J K L 5	#	Changes letter case; long press toggles between text input mode and number input mode.
6	M N O 6	Scroll up key	Moves cursor to the left of character.
7	P Q R S 7	Scroll down key	Moves cursor to the right of character.

 **Note:** Some networks may not support all language-dependent characters and/or services.

- To enter a space, press 0 once.
- To enter punctuation, press 1 repeatedly until the character you want appears.

Text entry

Use special characters

While entering text, press * (or press and hold *, if predictive text is on) to display special characters. Press * again to cycle through all characters:

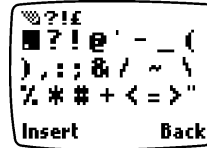

.	?	!	@	'	-	_	()
,	:	;	&	/	~	\	%	*
#	+	<	=	>	"	£	\$	¥
☐	ı	¿	⌂	⌂	§			

Use scroll keys to select the character you want, then press **Insert**.

 **Note:** The order and availability of special characters may vary depending on your service provider.

Use four-way scrolling

Navigate special characters, using the 2, 4, 6, and 8 keys much as you would a joystick. Once a character is highlighted press 5 to insert the character into your message.

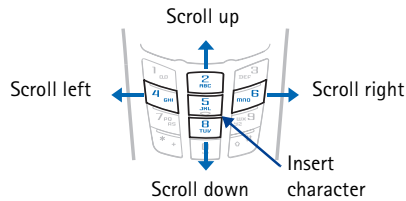

Use symbols in names and numbers

- To enter a symbol while adding a name to the contact list, press *.
- To add a special character for creating a number string in the number box, press *. See "Set touch tone strings" on page 67.

• PREDICTIVE TEXT

Predictive text input allows you to write messages much faster than the standard text method. With predictive text input, you only need to press each number key once for each letter. Your phone uses a built-in dictionary to predict or guess what you are writing. You can also add new words to the dictionary.

Turn on predictive text

- 1 Press **Menu**, then press **Select**.
- 2 Scroll to **Write message**, then press **Select**.
- 3 Press **Options**, scroll to **Predictive text**, then press **Select**.
- 4 Scroll to the language you want, then press **Select**.
T9 prediction on appears.

Enter predictive text

To write "Steve" with the English dictionary selected, press:

7 (for S) 8 (for t) 3 (for e) 8 (for v) 3 (for e)

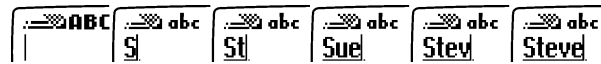

The display shows the above words for each key pressed.

Since the displayed word changes after each key stroke, disregard the word until you have keyed in all the characters. If the finished word is not the one you wanted, press ***** until your word appears. If it does not appear you will have an option to spell your word using standard text input.



Note: Predictive text input may not be available for all languages.

Turn off predictive text

- 1 While writing a text message, press **Options**.
- 2 Scroll to **Predictive text**, then press **Select**.
- 3 Scroll to **Prediction off**, then press **Select**.
T9 prediction off appears.

Save a word in the dictionary

If the word **Options** changes to **Spell**, the word you intended to write is not in the dictionary. You can add the word to predictive text.

Press **Spell**, enter the word using standard text entry and press **OK** to save the word. See "Standard text entry" on page 32 for more information.

*Text entry***Enter numbers**

- 1 To add a number to the message, press and hold # until **123** appears on the screen.
- 2 Enter the numbers you want, then press and hold # to return to the **ABC mode**.



Note: You can also enter numbers from the **Options** menu (**Insert number**), or by a long press of the number key.

Enter punctuation and special characters

There are two ways to enter punctuation when using predictive text.

Press and hold * to access the special characters list. See "Use special characters" on page 34 for more information.

You can also enter symbols from the **Options** menu:

- 1 From the **Messages** screen, press **Options**.
- 2 Scroll to **Insert symbol** and press **Select**.
- 3 Scroll to the symbol you want and press **Insert**.

Change the case

Predictive text uses sentence case, but you can manually change between upper and lower case by pressing #.



Tip: You can switch between uppercase and lowercase standard text input and uppercase and lowercase predictive text input by repeatedly pressing #.

Write compound words

- 1 Write the first part of the word and press the **Scroll down** key to accept it.
- 2 Write the last part of the compound word and press **0** to enter the word and a space.

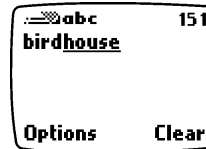
**Clear the screen**

To clear the text screen, press and hold **Clear**. You can also use the **Options** menu by selecting the **Clear text** option.

Delete information

To delete information when using predictive text, press **Clear**. Press and hold the clear key to delete text more quickly.

5 Contact list

Your phone includes a contact list that can store up to 200 entries (names and associated phone numbers). In addition, the contact list can store an e-mail address for a name.

- An entry in the contact list can consist of a number only or a name and a number.
- You cannot enter the same name twice. If you try to save a name that is already in the contact list, the phone asks if you want to replace the existing name.

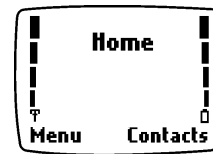

Contact list

• USE CONTACT LIST MENUS

The contact list has several menus from which you can choose. These menus appear when you press **Contacts**. Use the scroll keys to move to the menu you want to use.

Menu	Function
Find	Allows you to search for a specific entry.
Add new	Allows you to add a new contact to your contact list.
Delete all	Allows you to delete names and numbers one by one or all at once.
Options	Takes you to a new menu list which includes the contact list's memory status and scrolling view.
1-touch dialing	Allows you to assign up to eight keys for speed dialing.

• SAVE NAMES, NUMBERS, AND E-MAIL ADDRESSES

For information on entering text, see "Standard text entry" on page 32.

Quickly save a name and number

This method is called quick save.

- 1 Enter the phone number using the keypad, then press **Save**.
- 2 Enter a name and press **OK**.

Contact list

Save an entry using the contact list menu

- 1 Press **Contacts** to enter the contact list.
- 2 Scroll to **Add new**, then press **Select**.
- 3 Enter a name, then press **OK**.
- 4 Enter a number, then press **OK**.

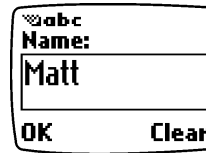

Save an e-mail address

Once you have added a contact to your contact list, you can add an e-mail address to that contact.

 **Note:** E-mail addresses can only be added to existing contacts. For example, you cannot enter an e-mail address until you have selected a name or number.

- 1 Find the name to which you want to add an e-mail address.
- 2 Press **Details**, then press **Options**.
- 3 Scroll to **E-mail address**, then press **Select**.
- 4 Enter the e-mail address, and press **OK**.

 **Important:** If you have selected the **Name+number** contacts view, you will not need to press **Details**.

• RECALL NAMES AND NUMBERS

- 1 At the start screen, press **Contacts**.
- 2 Select **Find**, then enter one or two letters of the name you want to recall.
- 3 Press **Find**, then press the **Talk** key to dial the number.

You may have to scroll to the appropriate entry in a list if you have stored names that are similar to each other.

Recall information with shortcuts

You may want to use some of these shortcuts or alternate methods for recalling a number.

- Press **Contacts**, enter the first letter of the name, scroll to the name, and press the **Talk** key to dial the number.
- At the start screen, press the scroll keys to enter your list of names, scroll to the name you want to dial, and press the **Talk** key.
- Press the **Talk** key to access a list of your last ten dialed calls, scroll to the one you want to dial, then press the **Talk** key again.

• EDIT A NAME OR NUMBER

You can edit a name, a number, or both.

- 1 Recall the name or number you want to edit.
- 2 Press **Details**, then press **Options**.
- 3 **Edit appears**, then press **Select**.
- 4 Edit the name or number and press **OK**.



Important: If you have selected the **Name+number** contacts view, you do not need to press **Details**.

• DELETE NAMES AND NUMBERS

Erasing stored names and numbers removes them from your phone. Once you delete an item, you can restore it only by re-entering it.

Individual entries

- 1 Recall the contact list entry you want to delete.
- 2 Press **Details**, then press **Options**.
- 3 Scroll to **Delete**, and press **Select**.
The message **Delete?** appears.
- 4 Press **OK**.



Important: If you have selected the **Name+number** contacts view, you do not need to press **Details**.

Entire contents

- 1 Press **Names**, scroll to **Delete all**, and press **Select**.
- 2 Scroll to **Delete all** and press **Select**.
- 3 When you see the message **Are you sure?**, press **OK**.
- 4 Enter your security code and press **OK**.



Note: For information on your security code, see "Understand the security code" on page 73.

Contact list

- **CUSTOMIZE YOUR CONTACTS VIEW**

You can change how the information in your contact list looks on your screen. There are three different ways to view your contact list. In all views, you can use the scroll keys to move up and down through the list of names.

Choice	What it does
Name list	Displays three names on the screen at a time.
Name+number	Only one name and its corresponding number appears on the screen at a time.
Name only	Displays individual names only. You can view the corresponding phone number by pressing Details and then scrolling up or down.

Select your scrolling view

To change the way you view names and numbers in your contact list.

- 1 Press **Contacts**, scroll to **Options**, and press **Select**.
- 2 At **Contacts view**, press **Select**.
- 3 Scroll to the view you want and press **Select**.



Important: If you have selected the **Name+number** contacts view, you will not need to press **Details** when working with contact list options.

- **CHECK MEMORY STATUS**

You can check how much contact list memory is free and how much has been used.

- 1 Press **Contacts** and scroll to **Options**.
- 2 Press **Select**, scroll to **Memory status**, and press **Select**.

6 Call log

Your phone provides a call log that registers information about calls you make and receive. The call log keeps track of the following:

- Missed calls
- Received calls
- Dialed calls

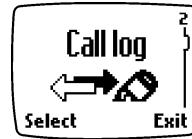

 **Note:** This function only works in digital networks and only when caller ID is enabled.

• CALL LOG OPTIONS

When you view the missed calls, received calls, or dialed calls list, and press **Options**, the following choices may appear.

 **Note:** Not all options will appear each time. Also, the order of options may vary.

Choice	What it does
Call time	Shows the time when the call was connected. (You must first set the phone's clock)
Send message	Allows you to write a short text message to the person who called you or to whom you called.
Edit number	Allows you to edit the displayed number and save it with a name to your contact list.
Save	Allows you to enter a name for the number and save both to your contact list.
Delete	Allows you to delete the number from the call list.
View number	Allows you to view the caller's phone number. In order to see this option, the caller's name and number must be stored in the contact list.
Call	Dials the number from the call log.

Call log

• CHECK MISSED CALLS

If you do not answer a call, the message **Missed calls** appears on your phone's screen, along with the number of calls missed. Your phone stores the last ten numbers associated with calls you have missed.

Check missed calls

- 1 Press **Menu 2-1** (**Call log > Missed calls**).
The phone displays a list of the numbers of the calls you missed.
- 2 Press the **Scroll up** or **Scroll down** key to scroll through the list.
- 3 Press the **Talk** key if you want to dial the number.

• CHECK RECEIVED CALLS

Your phone stores the last ten numbers associated with calls that you have answered. To check this list of numbers:

- 1 Press **Menu 2-2** (**Call log > Received calls**).
- 2 Scroll through the list of received numbers and highlight your selection.
- 3 Press the **Talk** key if you want to dial the number.

• CHECK DIALED CALLS

Your phone stores the last ten numbers associated with calls that you have dialed. To check this list of numbers:

- 1 Press **Menu 2-3** (**Call log > Dialed calls**).
- 2 Scroll through the list of dialed numbers and highlight your selection.
- 3 Press the **Talk** key if you want to dial the number.

Clear call lists

Your phone uses call lists to track numbers for incoming, outgoing, and missed calls. You can delete some or all of the numbers that appear in the call log.



Caution: You cannot undo this operation.

- 1 Press **Menu 2-4** (**Call log > Clear call lists**).
- 2 Use the **Scroll up** or **Scroll down** key to scroll through the options list.
The list includes **All**, **Missed**, **Received**, and **Dialed**.
- 3 Stop at the appropriate option and press **Select**.

The **All** option clears every number in every list, whereas the other options clear only the numbers associated with that option. For example, the **Dialed** option clears only the numbers associated with calls you previously dialed.

• USE CALL TIMERS

Your phone tracks the amount of time you spend on each call. To obtain information about time spent on phone calls:

- 1 Press **Menu 2-5** (**Call log > Call timers**).
- 2 Scroll through the following options:

Option	What it does
Duration of last call	Shows the call duration of the last call.
Duration of all calls	Shows the call duration of all calls that have been made and received since you reset the timers.
Clear timers	Clears all call timers for the currently selected phone number. Your phone includes separate timers for each number used.

 **Note:** The actual time invoiced for calls by your service provider may vary, depending upon network features, rounding-off for billing, and so forth.

 **Caution:** If you select the **Clear timers** option, the action cannot be undone. If you use the call timers to log the amount of time spent on calls, you may want to record the call timer information before you clear it.

Clear call timers

- 1 Press **Menu 2-5-3** (**Call log > Call timers > Clear timers**).
- 2 Enter your security code and press **OK**.

 **Note:** For information on your security code, see "Understand the security code" on page 73.

Turn on a current call timer

You can set your phone to show the running elapsed time while a call is active.

- 1 Press **Menu 4-2-2** (**Settings > Call settings > Current call timer**).
- 2 Scroll to **On** and press **Select**.
From this point on, the timer is active during each call you make or receive. The time appears on the phone's screen.
- 3 After a call has ended, press any key on the phone's keypad to clear the current call time from the screen.

Messages

7 Messages

Use mobile messages to keep in touch with friends, family and business associates. Your phone allows you to do the following:

- Voice mail
- Send and receive text messages
- Send and receive picture messages
- Communicate with e-mail



Not all messaging features are available in all wireless networks. Contact your service provider for availability and subscription information.

• VOICE MAIL

Voice mail provides a way for callers who miss you to leave a message that you can retrieve later.

Check for messages

Your phone beeps when you receive a voice message. Also, the message **New voice message** appears on your phone's screen, along with the  icon.

If you receive more than one voice mail message, your phone may show the number of messages that you have received. The wireless network provider determines the type of indication you will receive.



Note: To use voice mail, you need to learn the voice mail system's various greetings, passwords, and prompts. Your service provider can provide instructions.

Save the voice mailbox number

As part of your network's voice mail feature, your service provider gives you a voice mailbox phone number.

- 1 Press **Menu 1-8-2 (Messages > Voice messages > Voice mailbox number)**.
- 2 Enter your voice mailbox phone number, then press **OK**.

Your voice mailbox number can be up to 32 digits long and is used until you change it. Therefore, if your phone number changes, the voice mail number will probably change also. For further information, contact your service provider.



Listen to your voice messages

The way you listen to your voice messages depends on your service provider. Call your service provider if you have any questions.

- 1 When your phone alerts you to new voice messages, press **Listen** and follow the instructions given on the phone.
- 2 If you want to listen to your messages later, press **Exit**.
- 3 To listen to your voice messages:

Press and hold 1.

OR

Press **Menu 1-8-1 (Messages > Voice messages > Listen to voice messages)**. Follow the prompts to review your messages.

• TEXT, E-MAIL, AND PICTURE MESSAGES

Your phone is capable of a variety of messaging services including text messages (SMS or Short Message Service), picture messages, and e-mail messages. Messaging services are Network Services. Consult your service provider for information on availability, subscribing to and using messaging services.

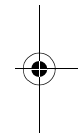
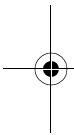

Understand messaging

Message recipients: The phone to which you send a message must support messages. The recipient may not receive the SMS message you send if the recipient's account is with a different service provider or uses a different protocol.

Message length: The maximum length of a sent or received message is 160 characters. Your phone has space for several messages, depending on the length of each message. The maximum length of a message also may depend on the capabilities of the network from which the message originated.

Options when working with messages

There are several options available when working with text, picture, and e-mail messages. The order and availability of options may vary depending on the messaging function and your service provider.

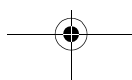

Messages

Option	Description
Send	Attempts to send the text message to the recipient.
Settings	Allows you to set Urgent , Read receipt , Reply req. , and Callback no. options for the message.
Save	Saves the message in the archive folder.
Clear text	Clears the text in the message editor.
Exit editor	Takes you back to the Write message menu.
Predictive text	Allows you to turn predictive text on and off.
Insert word	If predictive text (T9) is activated, you can manually spell a word and insert it into your message.
Insert number	Allows you to insert numbers into the message.
Insert symbol	Allows you to access the list of special characters.
Save picture	Allows you to save a picture to the template folder.
Matches	Lists alternative word choices while using predictive text.
Details	Available when viewing a picture message. This option allows you to view the name and number of the sender.
Preview	Previews your picture message before sending.
Edit text	Allows you to add text to a picture message.
Delete	Allows you to delete a message.
Forward	Allows you to forward a message.
Use number	Allows you to use the number associated with a message.
Replay	Allows you to replay messages you receive.
Edit recipient	Allows you to edit the e-mail address.
Edit subject	Allows you to edit the subject of an e-mail message.



Tip: When writing messages, you can switch between uppercase and lowercase standard text input and uppercase and lowercase predictive text input by repeatedly pressing #.



Organize messages using folders

Your phone has folders for managing text messages. Text message folders are located under the **Messages** menu.

THE INBOX FOLDER

The inbox stores messages you receive. Messages remain in the inbox until you delete them or save them in the archive folder. You can forward or reply to messages in your inbox.

THE OUTBOX FOLDER

The outbox stores messages you have written, sent, edited, and forwarded. Messages in the outbox are not saved messages. As you send new messages, old messages will automatically be removed from the outbox. When message memory is full, one or more messages of the lowest priority are automatically deleted from the outbox. If you want to save a message you have sent, read the message while it is in the outbox and use the options menu to save it to the archive folder.

THE ARCHIVE FOLDER

The archive folder stores messages you have saved. You can save messages to the archive folder from the inbox and the outbox. You can reply to or forward saved messages.

DELETE MESSAGES FROM FOLDERS

You can delete all messages located within a specific folder.

- 1 Press **Menu 1-6 (Messages > Delete all)**.
- 2 Scroll to one of the following options, then press **Select**.

All read

Inbox

Archive

Outbox

- 3 Enter your security code, then press **OK**.



Note: For information on your security code, see "Understand the security code" on page 73.

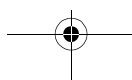
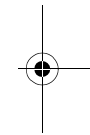
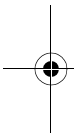

Messages

- **TEXT MESSAGES**

Use your phone to send and receive short text messages.

Write and send a text message

When writing text messages, use the predictive text method for faster text entry. For details, see "Predictive text" on page 35.

- 1 Press **Menu**, select **Messages**, then select **Write message**.
The message screen appears.
- 2 Enter a message of up to 160 characters.
A counter in the upper right corner of the screen shows the number of characters remaining.
- 3 When you have finished writing the message, press **Options**, scroll to **Send**, then press **Select**.
- 4 Enter or recall the recipient's phone number, then press **Send**.

Sending message appears.



Note: When sending messages via the SMS network service, your phone may display the words, **Message Sent**. This is an indication that the message has been sent by your phone to the message center number programmed into your phone. This is not an indication that the message has been received at the intended destination. For more details about SMS services, check with your service provider.

Read a text message

When you receive a text message, the phone beeps and displays **Message received** and the  indicator in the upper left corner of the screen.

- 1 Press **Read** to view the message.
- 2 Use the scroll keys to view the whole message, if necessary.
- 3 Once you've finished, press the **End** key to return to the start screen, or press **Options** for other choices, such as **Reply** or **Forward**.

When the phone displays **Message received**, pressing **Exit** moves the new message to the inbox and returns you to the start screen. To read the message later, press **Menu 1-3 (Messages > Inbox)**. If you have more than one new message, scroll to the message you want to view. Messages in the inbox are listed in the order they are received, with the most recent message listed first. Unread messages are indicated by .



Respond to a text message

There are many options available for working with text messages. For a list of options and their descriptions, see "Options when working with messages" on page 45.

REPLY TO THE MESSAGE

- 1 When reading the message, press **Options**.
- 2 Scroll to **Reply**, then press **Select**.
- 3 Choose to reply **As message** or **As e-mail**, then press **Select**.

When replying as e-mail, see "Send an e-mail message" on page 51. When replying as message, see "Write and send a text message" on page 48.

FORWARD THE MESSAGE

- 1 When reading the message, press **Options**.
- 2 Scroll to **Forward**, then press **Select**.
- 3 Choose to forward **As message** or **As e-mail**, then press **Select**.

When forwarding as e-mail, see "Send an e-mail message" on page 51. When forwarding as message, see "Write and send a text message" on page 48.

SAVE A MESSAGE

- 1 When reading the message, press **Options**.
- 2 Scroll to **Save**, then press **Select**.
The message will be moved to the archive folder.

DELETE A MESSAGE

- 1 When reading the message, press **Options**.
- 2 Scroll to **Delete**, then press **Select**.
Delete message? appears.
- 3 Press **OK**.

WHEN MEMORY IS FULL

When message memory is full, one or more messages of the lowest priority are automatically deleted. When you receive an emergency message, messages may be deleted from any of your message folders.

If you have more messages waiting at the network,  blinks on the start screen. You can delete old messages to create space for new messages.

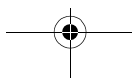
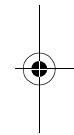
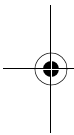



Messages

• PICTURE MESSAGES

Your phone offers five picture messages that you can use to send pictures and text to your friends and family. You can also save a new picture by replacing an existing picture. For possible message options, see "Options when working with messages" on page 45.

Each picture message is made up of several text messages. Therefore, sending one picture message may cost more than sending one text message. Contact your service provider for pricing information.



Note: This function can be used only if it is supported by your network operator or service provider. Only phones that offer picture message features can receive and display picture messages.

Send a picture message

- 1 Press **Menu 1-7 (Messages > Picture Messages)**.
- 2 Scroll to the picture you want to send, then press **Show**.
The picture appears. To choose a different picture, press **Back** and scroll to another picture.
- 3 Press **Options**.
Edit text appears.
- 4 Press **Select**, then add a text message to send with the picture.
After you enter the text, you have several options. To view a list of possible options, see "Options when working with messages" on page 45.
- 5 To send the picture and message, press **Options**.
- 6 Scroll to **Send**, then press **Select**.
- 7 Enter or recall the recipient's phone number, then press **Send**.
Sending message appears.

PREVIEW A PICTURE MESSAGE BEFORE SENDING

After writing text for your picture message, you can preview the message before sending it.

- 1 Press **Options**.
- 2 Scroll to **Preview**, then press **Select**.
- 3 After viewing the message, press **Back**.

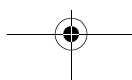
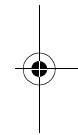
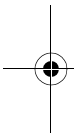

Receive a picture message

- 1 When your phone displays **Picture message received**, press **Show** and the message appears.
- 2 If the picture has a text message with it, scroll up or down to see the entire message.

Save a picture message

- 1 Press **Show** to view the message, then press **Save**.
You have the option to replace a current message.
- 2 Scroll to the picture you want to delete, then press **Replace**.

• E-MAIL MESSAGES

You can send e-mail up to 160 characters in length to anyone with an e-mail address. This is a Network Service.

- Messages sent to you by e-mail arrive as regular text messages. You can use all the options described earlier to save, reply to, or forward a message.
- Contact your service provider to get the e-mail address and gateway number for your phone, and for more information on using e-mail.

Send an e-mail message

- 1 Press **Menu 1-2 (Messages > Write e-mail)**.

 **Note:** If you get a prompt asking you to enter your e-mail gateway number, you must obtain this number from your service provider.

- 2 At the prompt, enter your recipient's e-mail address or press **Find** to look through and select a saved e-mail address from your phone list.
- 3 Press **OK**.
- 4 At the prompt, enter a subject for your e-mail message. (You are not required to enter a subject.)
- 5 Press **OK** when you are finished.

 **Note:** Predictive text is not available when entering an e-mail address or a subject line for your e-mail.

A screen will appear allowing you to enter the text of your message. Your total message, including the address and subject line, can be up to 160 characters. There is a running total of remaining characters in the top right corner of the screen.

- 6 After you finish entering the text of your e-mail, press **Options**, scroll to **Send**, then press **Select**.



Messages

Receive an e-mail message

When you receive an e-mail message, the phone makes a sound and displays **Message received** and the  indicator in the upper left corner of the screen.

To read the message, press **Read**.

When reading a received e-mail message, you can choose other options, such as **Reply** and **Forward**. See "Options when working with messages" on page 45.

Edit an existing e-mail message

Edit an e-mail message by replying to the message or forwarding it. You can edit messages from any folder.

Reply to an e-mail message

- 1 When reading the message, press **Options**.
- 2 Scroll to **Reply**, then press **Select**.
- 3 Choose to reply **As message** or **As e-mail**, then press **Select**.

When replying as e-mail, see "Send an e-mail message" on page 51. When replying as message, see "Write and send a text message" on page 48.

Forward an e-mail message

- 1 When reading the message, press **Options**.
- 2 Scroll to **Forward**, then press **Select**.
- 3 Choose to forward **As message** or **As e-mail**, then press **Select**.

When forwarding as e-mail, see "Send an e-mail message" on page 51. When forwarding as a message, see "Write and send a text message" on page 48.

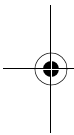

8 Personalization

The Nokia 2200 series can be easily customized to fit your lifestyle. The display language, ringing tones, audio, and accessory settings (among others) can all be modified to suit your needs.

Your phone has various profiles which allow you to customize ringing and alert tones for different environments. Once you modify the profiles, you can activate the profile that is appropriate for your surroundings. For example, you can select the **Silent** profile while at the movies or the **Outdoor** profile when at a sporting event.

• PROFILES

Profiles let you set sound settings to match your environment, whether it is a meeting or a soccer game. Just pick the profile that suits your current environment: **Normal**, **Silent**, **Meeting**, **Outdoor** or **Pager**.

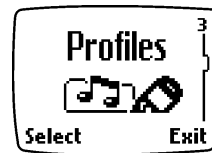

You can customize any of the profiles and set your own preferences for the following settings:

- Ringing options
- Ringing tone
- Ringing volume
- Message alert tone
- Vibrating alert
- Keypad tones
- Warning tones
- Profile name (except for the **Normal** profile)

 **Important:** You can select a default profile for each of these accessories: **Headset**, **Handsfree**, and **Loopset**. To learn more about accessories, see "Accessory settings" on page 56.

Select a profile

- 1 Quickly press and release the **Power** key.
- 2 Use the **Scroll up** or **Scroll down** key to move to the profile you want to use. Profile names are highlighted as you scroll through them.
- 3 Press **Select** to activate a profile.



Personalization

Customize a profile

- 1 Press **Menu 3 (Profiles)**.
- 2 Scroll to the profile you want to customize, then press **Options**.
- 3 Scroll to **Customize**, then press **Select**.
- 4 Use the scroll keys to display each of the profile options. Once you find the option you'd like to customize, press **Select**.

SET THE RINGING OPTIONS

You can choose the type of ring your phone uses to notify you of an incoming call. This setting does not affect any incoming text message alert tones.

- 1 Press **Menu 3 (Profiles)**.
Your phone lists each profile.
- 2 Scroll to the desired profile in the list for which you want to set the ringing options, and press **Options**.
- 3 Scroll to **Customize**, then press **Select**.
- 4 Scroll to **Ring** and press **Select**.
- 5 Scroll to one of the ringing options, as described below, and press **Select**.
Ring: The phone rings normally.
Ascending: Ringing volume increases (gets louder) if the phone is not answered.
Ring once: The phone rings once to indicate an incoming call.
Beep once: The phone beeps once to indicate an incoming call.
Silent: The phone makes no sound.

SET THE RINGING TONE

The ringing tone is the sound your phone makes when you receive a call. Your phone contains preprogrammed ringing tones. You can set the ringing tone to a specific sound or tune to personalize how the phone rings. You can also add custom ringing tones to your phone. See "Download a ringing tone" on page 78 for more information.

- 1 Press **Menu 3 (Profiles)**.
Your phone lists each profile.
- 2 Scroll to the profile for which you want to set the ringing tone, then press **Options**.
- 3 Scroll to **Customize**, then press **Select**.
- 4 Scroll to **Ring** and press **Select**.

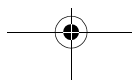



- 5 Scroll through the options when you hear the tone you want, press **Select**.



Note: If you have already chosen a ringing option of either **Silent** or **Beep once**, the ringing tones are already turned off. See "Set the ringing options" on page 54 for details. As you scroll through the ringing tones, you can listen to a sample of each if your current ringing option is not set to **Silent**.

SET THE RINGING VOLUME

Set the default ringing volume for incoming voice calls and message alert tones.

- 1 Press **Menu 3 (Profiles)**.
- 2 Scroll to the profile you will set and press **Options**.
- 3 Scroll to **Customize**, then press **Select**.
- 4 Scroll to **Ringing volume** and press **Select**.
- 5 Scroll through the options. When you hear the right volume level, press **Select**.

SET THE MESSAGE ALERT TONE

Set your phone to use a certain tone to indicate an incoming text message.

- 1 Press **Menu 3 (Profiles)**.
- 2 Scroll to the profile for which you want to set the message alert tone and press **Options**.
- 3 Scroll to **Customize**, then press **Select**.
- 4 Scroll to **Message alert tone**, then press **Select**.
- 5 Scroll through the tone selections.

The phone plays samples of each selection as you scroll to it.

- 6 When you find the tone you want, press **Select**.

SET A VIBRATING ALERT

Set your phone to vibrate to indicate an incoming call.

- 1 Press **Menu 3 (Profiles)**.
- 2 Scroll to the profile for which you want to set the vibrating alert and press **Options**.
- 3 Scroll to **Customize**, then press **Select**.
- 4 Scroll to **Vibrating alert** and press **Select**.
- 5 Scroll to **On** and press **OK**.

The phone does not vibrate when it is connected to or placed in any charging device.

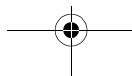
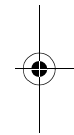
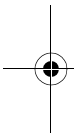

Personalization

SET KEYPAD TONES

Keypad tones set the volume of the tone you hear when you press phone keys.

- 1 Press **Menu 3 (Profiles)**.
- 2 Scroll to the profile for which you want to set the keypad tones and press **Options**.
- 3 Scroll to **Customize**, then press **Select**.
- 4 Scroll to **Keypad tones** and press **Select**.
- 5 Scroll to one of the levels and press **Select**.
 - If you choose **Off**, no keypad tones are heard.
 - If you chose the **Silent profile** in step 2, the keypad tones are turned off.

SET THE WARNING TONES

Warning tones include the sounds your phone makes during error conditions, during confirmations, when the battery is low, and when you need to recharge the battery.

- 1 Press **Menu 3 (Profiles)**.
- 2 Scroll to the profile for which you want to set the warning tones, then press **Options**.
- 3 Scroll to **Customize**, then press **Select**.
- 4 Scroll to **Warning tones**, then press **Select**.
- 5 Scroll to **On** or **Off** and press **Select**.

Rename a profile

- 1 Press **Menu 3 (Profiles)**.
- 2 Scroll to the desired profile, then press **Options**.
- 3 Scroll to **Customize**, then press **Select**.
- 4 Scroll to **Profile name**, then press **Select**.
- 5 Enter the new name and press **OK**.



Note: You cannot rename the **Normal** profile.

Accessory settings

Use your phone with these Nokia accessories:

- Headset (HDC-5, HDE-2, HDB-5, and HDC-10)
- Handsfree Car Kit (CARK-125, CARK-134 and PPH-1)
- Loopset (LPS-3)
- TTY/TDD Adapter (HDA-9)



Note: You can select a default profile that will be associated with each accessory, such as **Normal**. However, the **Accessory settings** menu will not appear until after an accessory has been connected to the phone at least once.

SET UP THE LOOPSET

When you want to use the loopset, you will have to activate the accessory setting.

- 1 Attach the loopset to the phone.
- 2 Press **Menu 4-4-3 (Settings > Accessory settings > Loopset)**.
- 3 Scroll to **Use loopset**, then press **Select**.
- 4 Scroll to **Yes**, then press **Select**.

AUTOMATIC ANSWER

This feature lets your phone answer incoming calls after just one ring when an accessory is connected to the phone.

- 1 Press **Menu 4-4 (Settings > Accessory settings)**.
- 2 Scroll to **Headset, Handsfree, or Loopset**, then press **Select**.
- 3 Scroll to **Automatic answer**, then press **Select**.
- 4 Scroll to **On** and press **Select**.

SET THE LIGHTS (CAR KIT ONLY)

When your phone is connected to a car kit, you have a choice of having the phone lights on (a) continuously or (b) only when you use it.

- 1 Press **Menu 4-4-2-3 (Settings > Accessory settings > Handsfree > Lights)**.
- 2 Choose one of the following options, then press **OK**:
 - On:** The lights will remain on while the phone is connected to the car kit.
 - Automatic:** The lights will be turned on only when the phone is being used.

SET THE DEFAULT PROFILE

When you use the headset, car kit or loopset, you have the option of selecting a default profile. You can use the currently selected profile (for example, **Normal**) or you can choose from the list.

- 1 Press **Menu 4-4 (Settings > Accessory settings)**.
- 2 Scroll to **Headset, Handsfree or Loopset**, then press **Select**.
- 3 Scroll to **Default profile**, then press **Select**.
- 4 Scroll to the profile you want, then press **Select**.



Note: The **Active profile** uses the current profile setting you have selected for your phone.

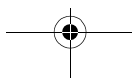
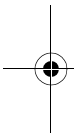

Personalization

Set the display language

You can choose your phone's display language.

- 1 Press **Menu 4-3-1** (**Settings > Phone settings > Language**).
- 2 Scroll to the language you want, then press **Select**.

Set the clock

Your phone contains a real-time clock that can be set two different ways: the clock can use the time information provided by the wireless system or it can be set manually. Once the time is set, you can display the clock on the start screen.

For added convenience, the clock is connected to an alarm clock. See "Use the alarm clock" on page 75 for additional information.

SELECT THE TIME FORMAT

You can choose whether your clock shows time in an *am/pm* format or a 24-hour format.

- 1 Press **Menu 4-1-2-3** (**Settings > Time settings > Clock > Time format**).
- 2 Scroll to **24-hour** or **am/pm** and press **Select**.

SET THE CLOCK USING AM/PM FORMAT

- 1 Press **Menu 4-1-2-2** (**Settings > Time settings > Clock > Set the time**).
- 2 Enter the time using an *hh:mm* format and press **OK**.
For example, to set your clock to 8:40, enter **08:40**.
- 3 Scroll to **am** or **pm** and press **Select**.



Note: Even if you have selected the **am/pm format**, you can still set the clock in the **24-hour** format.

SET THE CLOCK USING 24-HOUR FORMAT

- 1 Press **Menu 4-1-2-2** (**Settings > Time settings > Clock > Set the time**).
- 2 Enter the time using an *hh:mm* format and press **OK**.
For example, to set your clock to 8:40, enter **08:40** (for am) or **20:40** (for pm).
- 3 Press **OK**.

Automatic update of time

Set your phone to update the time from the network when you turn the phone on. If the clock in your phone is 30 seconds or more off the network time, the phone will automatically update to reflect the network time.



Note: Auto update time is a network dependent feature. Contact your service provider for details and availability.

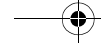

- 1 Press **Menu 4-1-3 (Settings > Time settings > Auto update of time)**.
- 2 Scroll to one of the following options, then press **Select**.
 - On:** Updates the time automatically.
 - Confirm first:** Requires you to confirm that you want the update. You can accept or decline the update.
 - Off:** Prevents the time from being automatically updated.

Display the clock

- 1 Press **Menu 4-1-2 (Settings > Time settings > Clock)**.
- 2 Scroll to **Hide clock** or **Show clock** (only one choice appears, depending on the current setting).
- 3 Press **Select**.

Add a welcome note

You can add a welcome note that your phone displays briefly each time you turn it on.

- 1 Press **Menu 4-3-3 (Settings > Phone settings > Welcome note)**.
- 2 Enter a note, then press **Options**.
- 3 Scroll to **Save**, then press **Select**.
 - To delete the welcome note, follow steps 1-2, scroll to **Delete**, then press **Select**.

Restore factory settings

If you have made changes to your phone's profiles (settings), you can restore them to their original or factory settings. The memory, timers, language selection, and security code are not reset. However, profile and accessory settings are reset.

- 1 Press **Menu 4-3-4 (Settings > Phone settings > Restore factory settings)**.
- 2 At the prompt, enter your five-digit security code and press **OK**.
 - See "Understand the security code" on page 73. for more information.

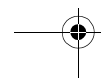
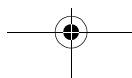
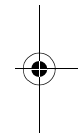
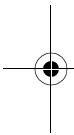

Advanced calling features

9 Advanced calling features

This chapter covers advanced calling features, including:

- Options available while in a call
- Managing two calls at the same time
- Network services, such as call forwarding

Not all features that are described are available in all wireless networks. Contact your service provider for availability of network services.

• UNDERSTAND ACTIVE-CALL OPTIONS

Your phone allows you to use a number of features during a call; however, you may not be able to use all options at all times. Also, the order of in-call options may vary.



Note: Many in-call options are network dependent features. To use these options, you may need to contact your service provider.

During a call, press **Options** to see the in-call menu choices:

Menu Options	What it does
Lock keys	Allows you to lock the phone's keypad during a call.
Mute	Mutes the phone's microphone. This option can affect the microphones of accessories connected to the phone.
End all calls	Ends all active calls.
Touch tones	Sends touch tones.
New call	Allows you to make a call while you have a call in progress.
Menu	Allows you to access the menus.
Contacts	Allows you to access the contact list.

Access menus

You can access your phone's menus while in a call.

- 1 Press **Options**.
- 2 Scroll to **Menu**, then press **Select**. To exit the menus, press **Exit**.



Note: Do not press the End key to exit the menus or you will end your call.

Make a new call

To make a new call while already in a call, dial the number, then press the **Talk** key.

End all calls

Press the **End** key.

Access the contact list

You can access information in the contact list during a call.

- 1 Press **Options**.
- 2 Scroll to **Contacts**, then press **Select**.

Save a name and/or number

You can save a name and number during a call.

- 1 Enter the number you want to save.
- 2 Press **Options**, scroll to **Contacts**, then press **Select**.
- 3 Scroll to **Add new**, then press **Select**.

Add the name and number as you normally would.

Mute the phone's microphone

While in a call, you can mute the phone's microphone.

Press **Options**, scroll to **Mute**, press **Select**.

Use conference call

While in a call, you can call another number to add a third party to the call.



Note: Conference calling is a provider dependent feature. Contact your service provider for availability and details.

CONFERENCE A CALL

- 1 While in a call, you can either dial the number you want to add and press the **Talk** key.
OR
Press **Options**, scroll to **New call**, press **Select**, enter the phone number, and press **OK**.
- 2 When the third party answers, press the **Talk** key to connect all three parties.

Advanced calling features

DISCONNECT THIRD PARTY

While all three parties are connected, pressing the **Talk** key disconnects the third caller, keeping the second party's call active.

DISCONNECT SECOND PARTY

If you wish to disconnect with the second party and remain connected to the third party, have the second party terminate the call on his/her end.

RECALL A NUMBER FROM THE CONTACT LIST DURING A CALL

If you don't remember the number of the second party you want to include in the conference and the number is in your contact list, you can recall the number.

- 1 To access the contact list, press **Options**, scroll to **Contacts**, and press **Select**.
- 2 Follow the prompts to find the number as you normally would.
- 3 Locate the number in your contact list, then press **Select**.
The number appears in the number prompt.
- 4 Press **OK** to call the number.

END A CONFERENCE CALL

To end all calls, press the **End** key.

• **USE VOICE PRIVACY**

The voice privacy feature encrypts the voice channel so that people cannot eavesdrop on your phone conversations.



Note: Voice privacy is a network dependent feature. Contact your service provider for more information on this feature.

TURN VOICE PRIVACY ON/OFF

- 1 Press **Menu 4-6-1 (Settings > Network services > Voice privacy)**.
- 2 Scroll to **On** or **Off** and press **Select**.

During a call, voice privacy becomes active and notifies you with a beep. A notification message also appears on the screen.

If you turn this feature on and voice privacy becomes inactive, your phone beeps and displays **Voice privacy not active**.



Note: Use caution when sending confidential information, if voice privacy is not active.

• USE CALL FORWARDING

With call forwarding, you can forward incoming calls to another phone number. Before you can use call forwarding, you must first store the feature codes. Once call forwarding has been activated, **Call forwarding** appears as a menu option.



Note: Call forwarding is a network-dependent feature. Some networks require that call forwarding be activated manually. Contact your service provider for availability and full details.

Learn about call forwarding feature codes

Your network requires separate codes for activating and cancelling the various types of call forwarding. Your carrier can provide you with the necessary feature codes for these network services.

Once you store these feature codes in your phone, they are sent automatically to the network when you select one of the call forwarding options from your phone's menu. Your phone can store the following types of feature codes:

Option	What it does
Forward all calls	Forwards incoming calls to the number you specify.
Forward if busy	Forwards incoming calls when you are in a call.
Forward if not answered	Forwards incoming calls to another number when you are unable to answer.
Forward if out of reach	Forwards incoming calls to another number when the phone is out of the network or switched off.
Cancel all call forwarding	Cancels all active call forwarding options.

Store the call forwarding feature code

Before you can activate call forwarding, you must contact your service provider to obtain the feature codes.

- 1 Press **Menu 4-6-5** (**Settings > Network services**).
- 2 Enter the feature code your service provider gave you, then press **OK**.
- 3 Scroll to **Call forwarding** and press **Select**.

Advanced calling features

- 4 Scroll to the call forwarding option you want and press **Select**.
- 5 Scroll to **Activate** and press **Select**.

Activate/cancel call forwarding

After you store the correct feature codes, you can activate (or cancel) call forwarding as follows:

- 1 Press **Menu 4-6-2 (Settings > Network services > Call forwarding)**.
- 2 Scroll to the desired call forwarding option, then press **Select**.
- 3 Highlight **Activate** and press **Select**.
- 4 Enter the number to which you want your calls forwarded or press **Find** to recall a number from the contact list.
- 5 Press **OK**.



Note: When canceling call forwarding, follow steps 1 and 2.

- **USE CALL WAITING**

During a call, call waiting beeps to let you know that someone else is calling you. Depending on your caller ID setup, the phone might also display the number of the incoming call. Once call waiting has been activated, **Call waiting** appears as a menu option.



Note: Call waiting is a network-dependent feature. In some networks the call waiting code must be activated manually. Contact your service provider for availability and full details.

Store the call waiting feature code

- 1 Press **Menu 4-6-5 (Settings > Network services > Network feature setting)**.
The **Feature code prompt** appears.
- 2 Enter the feature code issued by your service provider and press **OK**.
- 3 Scroll to **Call waiting** and press **Select**.
- 4 Scroll to **Activate** and press **Select**.

Activate call waiting

- 1 Press **Menu 4-6-3 (Settings > Network services > Call waiting)**.
- 2 Scroll to **Activate** and press **Select**.



Manage calls

Call waiting works with both local and long distance calls.

- To answer an incoming call, press the **Talk** key.
- To switch from one call to another, press the **Talk** key.
- To end both calls, press the **End** key.

• USE SEND OWN CALLER ID

This feature allows you to block caller ID when you call someone (your number will not be displayed on their caller ID). This feature is only effective when calling a number equipped with caller ID.



Note: This feature is available only when supported by the wireless network and may not function if you are roaming.



Important: This feature works on a call-by-call basis. You must enable this feature each time you want to block the sending of your own number to the recipient's caller ID.

STORE THE FEATURE CODE

Before you can use the **Send own caller ID call** feature, you must store the feature codes for activating this feature. Once the code is stored in your phone, it is sent automatically to the network when you select this option from your phone's menu.

- 1 Press **Menu 4-6-5 (Settings > Network services > Network feature setting)**.
The **Feature code** prompt appears.
- 2 Enter the feature code issued by your service provider and press **OK**.
- 3 Scroll to **Send own caller ID**, press **Select**, then select **Yes**.

PLACE A CALL WITHOUT SENDING YOUR NUMBER

- 1 Press **Menu 4-6-4 (Settings > Network services > Send own caller ID)**.
- 2 Scroll to **No**, then press **Select**.
- 3 Enter the desired phone number, then press **OK** or press **Find** to recall a phone number from the contact list.

The phone automatically inserts the feature code into the dialing string and dials the phone number. The phone you are calling will not display your phone number through caller ID.

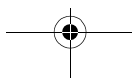
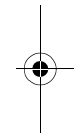
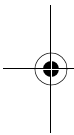

Advanced calling features

• SELECT A PHONE NUMBER

Your service provider programs your phone number and system information into your phone's memory when your phone is first activated. Your phone can hold up to three numbers. This means that your phone can be activated in three different service areas. For example, your phone could be activated in Dallas, Chicago, and New York. Each service area would assign a different phone number or account to your phone.

You must select a phone number for your home system. Only one phone number can be active at a time. If you travel outside your home system, you can choose another number. One phone number is usually enough if your service provider has service or roaming agreements for each area in which you wish to use your phone. Contact your service provider for details.

 **Note:** Phone number selection is a network dependent feature. Some networks may not support more than one number. Contact your service provider for availability and full details.

Select the phone number

- 1 Press **Menu 4-6-6** (**Settings > Network services > Own number selection**).
- 2 Scroll to the phone number you want and press **Select**.

 **Note:** The first phone number on this list is selected. You need at least one active number to make calls. You cannot change from one phone number to another during a call.

• USE AUTOMATIC REDIAL

There are times when you may not be able to place a call (for example, due to the high volume of traffic on the wireless network). When the wireless network is busy or unavailable, **Automatic redial** instructs your phone to retry the call.

ACTIVATE AUTOMATIC REDIAL

- 1 Press **Menu 4-2-1** (**Settings > Call settings > Automatic redial**).
- 2 Scroll to **On** and press **Select**.

If the system is busy, your phone makes three additional call attempts. If you want to stop the automatic redial process before the last attempt, press the **End** key or **Quit**.

 **Important:** This feature does not automatically retry a number when the number you are calling is busy.

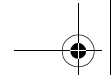

• USE 1-TOUCH DIALING

You can assign a name from your contact list to a 1-touch dial location, using your phone's keys 2-9. (The 1 key is used exclusively to dial your voice mailbox.) Once assigned, the phone number you associate with that key is dialed automatically when you press and hold the key.

Assign a key to 1-touch dialing

- 1 Press **Contacts**, scroll to **1-touch dialing** and press **Select**.
- 2 Scroll to a number that has the message **(empty)** and press **Assign**.
- 3 Scroll to the name and number to which you want to assign this key and press **Select**.
Repeat steps 1-3 times as many times as necessary.
- 4 To call a number using 1-touch dialing, press and hold the appropriate key for a few seconds.

Change 1-touch dialing numbers

You can change the 1-touch dialing key assignments at any time.

- 1 Press **Contacts**, scroll to **1-touch dialing**, and press **Select**.
- 2 Scroll to the key you want to change and press **Options**.
- 3 Scroll to **Change** and press **Select**.
- 4 Scroll through the contact list until you reach the new number you want to select and press **Select**.

Delete 1-touch dialing numbers

You can delete 1-touch dialing key assignments at any time.

- 1 Press **Contacts**, scroll to **1-touch dialing** and press **Select**.
- 2 Scroll to the key you want to delete and press **Options**.
- 3 Scroll to **Delete**, press **Select**, then press **OK**.

• SET TOUCH TONE STRINGS

Your phone allows you to create special sets of numbers known as touch tone strings which will dial a series of digits after a "wait" or a "pause." For example, you can program your phone to send your account number while you are banking by phone.

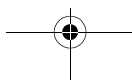
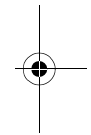
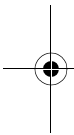

Advanced calling features

You must be in the **123** mode to enter these characters. Enter the numbers as usual. When you want to insert the special characters, press ***** repeatedly to switch among *****, **+**, **p**, **w** characters.

 **Note:** Use caution when sending confidential information, if voice privacy is not active.

Character	Action
p	Creates a <i>pause</i> when a number is dialed. The numbers you enter after this special character are automatically sent as touch tones after a 2.5-second pause.
w	Creates a <i>wait</i> when a number is dialed. This means that your phone waits for you to press the left selection key before it sends the number as touch tones.
*	Sends command strings to the network. Contact your service provider for details.
+	Use this character to link a 1-touch dialing number to a number in the contact list.

Set manual touch tones

- 1 Press **Menu 4-3-2-1** (**Settings > Phone settings > Touch tones > Manual touch tones**).
- 2 Select one of the following options, then press **Select**:
 - Continuous:** Sounds tone for as long as you press and hold a key.
 - Fixed:** Sets the tone length to 0.1 second, regardless of how long you press a key.
 - Off:** Turns off the tones. No tones are sent.

Set touch tone length

You can also set the length of each touch tone.

- 1 Press **Menu 4-3-2-2** (**Settings > Phone settings > Touch tones > Touch tone length**).
- 2 Use the **Scroll up** or **Scroll down** key to scroll to **Short** or **Long**. Short sets the tone length to 0.1 second. Long sets the tone length to 0.5 second.
- 3 Press **Select**.



Store touch tone strings

You can store touch tone strings the same way that you store names and numbers in your contact list. You can store an entire sequence of digits and send it as touch tones for frequently used strings of numbers.

STORE TOUCH TONE STRINGS WITH PHONE NUMBERS

- 1 Enter the phone number that you want associated with a touch tone.
- 2 Enter the touch tone character where needed (p, w, or *).
- 3 Enter the touch tone string.
- 4 Store the number as you normally would.

SEND A TOUCH TONE STRING

- 1 Press **Menu 4-3-2-1** (**Settings > Phone settings > Touch tones > Manual touch tones**).
- 2 Make sure that the setting is not set to **Off**.
If not set to **Off**, scroll to one of the other options and press **Select**.
- 3 During your call, press **Options**, scroll to **Touch tones**, and press **Select**.
- 4 Enter the touch tone string or recall the string from the contact list, then press **OK**.

If you send touch tones while in the analog mode, be careful not to send confidential information.

• LINK CONTACT LIST ENTRIES

This feature allows you to store a phone number in one contact list location and link it to another contact list entry.

For example, linking the phone number of an automated service (for example, automated banking service) with a touch tone string entry in your contact list (example: account and PIN numbers) automatically recalls and sends the touch tone string when you call the service.

USE LINKING OPTIONS

- 1 Store the touch tone string into your contact list.
- 2 Assign the contact list entry with the touch tones to a one-touch dialing location (example: location 3).
For more information on 1-touch dialing, see "Use 1-touch dialing" on page 67.
- 3 Edit the automated service's phone number by adding +n to the end of the phone number (where n is the 1-touch dialing location).

Example: 214-555-1234+3

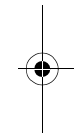
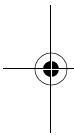

Advanced calling features

- 4 Press **OK** to save your changes.
- 5 Dial the automated service number from your contact list.

Your phone automatically sends the touch tones when the call connects.



Note: You may need to enter a pause (p) or a wait (w) before the + in order to account for delays in the automated system answering your call (for example, 214-555-1234p+3).

• SELECT A SYSTEM

Your phone can operate in residential, private, and public systems (such as your home system). You can choose how your phone selects a network to use. Your phone may not show the options described here. For information, contact your service provider.

Search for a network

Press **Menu 5 (System)**.

You have the following three options:

- **Automatic:** Your phone automatically searches for available networks and chooses the appropriate one. Every time you turn on your phone, it resets to **Automatic**.
- **Manual:** The phone searches for networks and then shows a list of the ones that are available. If an available network is found, **Available:** appears on the screen, followed by the name of the network. To choose the network listed, press **OK**.
- **New search:** Your phone begins a new search for both private and residential systems. When it finds the best system available, the phone shows the system name. If the phone doesn't find another system, the question **Perform an extended search?** will appear. Press **OK** if you wish to continue searching.

Select a public system

When you take your phone outside its home system, the phone is said to be *roaming*. The phone can search for home-type systems (that is, systems of the same type as your home system). Or, the phone can search for non-home-type systems.

Your service provider programs a list of preferred systems into your phone. These are systems with which your service provider has roaming agreements. Your phone looks for these systems when you're roaming.



Note: The options described here may not be available for your phone. Contact your service provider for information.

- 1 Press **Menu 4-6-7 (Settings > Network services > Public system selection)** to tell your phone how to choose a public system (network).

Your selection remains active until you change it.



- 2 Scroll to one of the following options, then press **Select**.

Any system: When service is not available in your home system, the phone searches for a preferred system of either type and then searches for a home-type system. Then it searches for a nonhome-type system. The search continues until your phone finds a system that can be used.

Home type: When service is not available in your home system, the phone searches for a home-type system first. However, if a nonhome-type system is found, your phone will use that system.

Nonhome type: The phone searches for a nonhome-type system only. The home-type system is not used.

Home only: The phone uses only its home system. It will not roam.

Select digital or analog

Your phone can work in both digital and analog modes. The default mode is both digital and analog, which appears on your phone as **Digital & analog** when you press **Menu 4-6-8 (Settings > Network services > Digital/analog selection)**.

The menu options for choosing the mode you prefer are:

- **Digit. & analog**
- **Analog**
- **Digital**

Your phone uses both digital and analog voice channels. The phone always tries to find a digital voice channel first, but if a digital voice channel is not available, the phone looks for an analog voice channel.

 **Note:** This feature is available only for certain phones. Contact your service provider for more information.

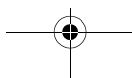
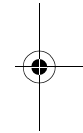
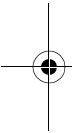

Security

10 Security

Your phone is equipped with different security features that allow you to do the following:

- Avoid making accidental calls
- Prevent unauthorized users from changing certain feature settings on your phone
- Restrict outgoing or incoming calls

• USE KEYGUARD

Keyguard disables your keypad to prevent accidental key presses.

LOCK THE KEYPAD

To lock the keys, press **Menu** then *****.

UNLOCK THE KEYPAD

To unlock the keys, press **Unlock** then *****.

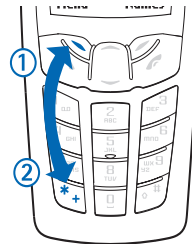

Note: When Keyguard is on, calls may be possible to emergency numbers (for example, 911 or other official emergency number). Key in the emergency number and press the **Talk** key. The number is displayed only after you have keyed in its last digit.

Answer a call while Keyguard is active

You can answer calls when Keyguard is activated by pressing **Answer** or the **Talk** key. If you are connected to a headset or loopset, press and hold the **End** key to end the call.

NOTES ABOUT KEYGUARD

- After you end the call, Keyguard automatically becomes active again.
- If you need the phone's lights while Keyguard is on, press the **Power** key to quickly switch the lights on for 15 seconds.
- Connecting your phone to a car kit automatically disables Keyguard.

• UNDERSTAND THE SECURITY CODE

The Security code prevents unauthorized users from changing certain important feature settings on your phone. When the phone requires this code, it displays a prompt asking you to enter a Security code. The five-digit default Security code that comes with your phone is 12345. Nokia recommends that you change the default code immediately.

 **Note:** If you enter an incorrect security code five times in a row, the phone will not accept the correct code for 5 minutes.

Change your security code

- 1 Press **Menu 4-5-2 (Settings > Security settings > Change security code)**.
- 2 At the **Security code** prompt, enter your five-digit default security code (12345) or your current security code and press **OK**.
- 3 At the **Enter new security code** prompt, enter your new five-digit security code and press **OK**.
- 4 At the **Verify new security code** prompt, enter your new security code again and press **OK**.

The confirmation **Security code changed** appears.

Keep your security code secret and stored in a safe place away from your phone. If you have changed your security code and don't remember the new code, contact your service provider.

• RESTRICT CALLS

You can create your own list of restrictions to restrict incoming and outgoing calls. To restrict the calls, you apply the appropriate restriction as desired. The maximum number of call restrictions you can define is ten.

Before you define restrictions for outgoing calls, **Add restriction** is the only available option. After you use the **Add restriction** option to add at least one restriction, the following options become available:

- **Select:** Allows you to select call restrictions from the outgoing calls list.
- **Add restriction:** Allows you to add a new restriction.
- **Edit:** Allows you to edit an existing call restriction.
- **Delete:** Allows you to delete an existing call restriction.

 **Note:** When calls are restricted, calls may be possible to the emergency number programmed into your phone (for example, 911 or other official emergency number). For example, you could dial 911 and press the **Talk** key.



Security

Add a number to the call restriction list

- 1 Press **Menu 4-5-1-1** (**Settings > Security settings > Call restrictions > Restrict outgoing calls**).
- 2 Enter your security code, then press **OK**.
- 3 Scroll to **Restrict outgoing calls**, then press **Select**.
- 4 Scroll to **Add restriction** and press **Select**.
- 5 At the number prompt, enter the number you want to restrict, and press **OK**.
For example, if you want to restrict all long distance calls that begin with 1, enter 1. If you want to restrict all calls that begin with 972, enter 972.
- 6 Enter a name for the restriction, then press **OK**.
If you press **OK** without entering a name, the number will be used.

Restrict outgoing calls

- 1 Press **Menu 4-5-1-1** (**Settings > Security settings > Call restrictions > Restrict outgoing calls**).
- 2 Enter your security code, then press **OK**.
- 3 Scroll to **Restrict outgoing calls**, then press **Select**.
- 4 Scroll to **Select** to choose from your list of call restrictions.
To deactivate a call restriction, highlight the restriction and press **Unmark**.
- 5 Scroll to the restriction you want to activate and press **Mark**.
- 6 Press **Back**.
- 7 At **Save changes?**, press **Yes**.
To return to the start screen, press the **End** key.

Restrict all incoming calls

- 1 Press **Menu 4-5-1-2** (**Settings > Security settings > Call restrictions > Restrict incoming calls**).
- 2 Enter your security code, then press **OK**.
- 3 Scroll to **Restrict incoming calls**, then press **Select**.
- 4 Press **Mark** to restrict all incoming calls.

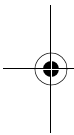



11 Special features

This section describes several special features, including transmission of business cards, downloading ringing tones, using the calculator and setting the alarm clock.

• USE THE ALARM CLOCK

The alarm clock feature is based on your phone's internal clock and sounds an alert at a time you specify. The alarm clock works even if you turn your phone off.

Set the alarm clock

- 1 Press **Menu 4-1-1** (**Settings > Time settings > Alarm clock**).
- 2 Enter the alarm time in **hh:mm** format, then press **OK**.
Step 3 is necessary only if you have selected **am/pm** format.
- 3 Select either **am** or **pm**, then press **Select**.

Respond to the alarm

At the time of the alarm, the phone sounds an alert tone. Pressing **Stop** or the **End** key stops the alarm from sounding, and returns you to the start screen.

SNOOZING

There are several ways you can enable the **Snooze** feature:

- 1 Press the **Snooze** selection key.
- 2 Press any key except the **End** key.
- 3 Allow the alarm to sound for one minute.

Once snooze is enabled, the alarm will sound again in ten minutes. If you press **Stop** or the **End** key while snoozing, the alarm will be turned off.

Alarm when phone power is off

If the alarm time is reached while the phone is off, the phone switches itself on and starts sounding the alarm tone. If you press **Stop**, the phone asks whether you want to activate the phone for calls. Press **No** to switch off the phone or **Yes** to make and receive calls.



Note: Do not press **Yes** when wireless phone use is prohibited or when it may cause interference or danger.

Turn off the alarm clock

- 1 Press **Menu 4-1-1** (**Settings > Time settings > Alarm clock**).
- 2 Scroll to **Off** and press **Select**.

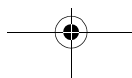
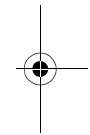
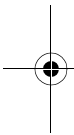

Special features

• USE THE CALCULATOR

The calculator adds, subtracts, multiplies, divides and converts currencies.

- 1 Press **Menu 7 (Calculator)**
- 2 Enter the first number in the calculation. To enter a decimal point, press **#**. Press **Clear** to delete any mistakes.
- 3 Press **Options** and scroll to **Add, Subtract, Multiply, or Divide**. Press **OK**.
Based upon the type of calculation, you also can use the following shortcut keys:

If you want to...	Press...
add	* (for + symbol)
subtract	** twice (for – symbol)
multiply	*** (for * symbol)
divide	**** (for / symbol)

- 4 Enter the second number in the calculation and press **Options**.
Equals appears.
- 5 Press **OK**.
- 6 Repeat steps 2-6 as many times as necessary.

Your phone must be switched on to use this function. Do not switch the phone on when wireless phone use is prohibited or when it may cause interference or danger.



Note: This calculator has a limited accuracy and rounding errors may occur, especially in long divisions.

Convert currency

You can use the calculator function to set an exchange rate and then calculate prices based on that exchange rate.

SET THE EXCHANGE RATE

- 1 Press **Menu 7 (Calculator)**, then press **Options**.
- 2 Scroll to **Exchange rate**, press **OK** and select one of the following options:
 - **Foreign units converted to home units** – allows you to enter the number of foreign units to a domestic unit.
 - **Home units converted to foreign units** – allows you to enter the number of domestic units to a foreign unit.

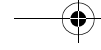

- 3 Press **OK**, enter the appropriate exchange rate (press **#** to enter a decimal point) and press **OK**.
The initial default of 1 is overwritten by any number you enter and the **Rate saved** confirmation appears.

CONVERT A CURRENCY AMOUNT

- 1 Press **Menu 7 (Calculator)**.
- 2 Enter the amount which you wish to convert.
- 3 Press **Options** and scroll to one of the following options:
 - **To home** – converts visited units of currency to *home* units using the exchange rate.
 - **To foreign** – converts home units of currency to *visited* units using the exchange rate.
- 4 Press **OK**.

• BUSINESS CARDS

Your phone can send or receive electronic business cards consisting of a name, phone number and e-mail. You can save received business cards in your contact list. This is a network dependent feature.

Send a business card

- 1 Find the name in your contact list.
- 2 Press **Options** and scroll to **Send bus. card**.
- 3 Press **Select**.
- 4 Enter or recall the phone number to which you want to send the business card and press **Send**.

View a received business card

When you receive a business card, the phone displays **Business card received**.

- 1 When your phone displays **Business card received**, press **Options**.
- 2 **Show** is selected. Press **Select**.
- 3 Scroll through the available information.

Save a viewed business card

- 1 After viewing the business card, press **Back**, scroll to **Save** and press **Select**.
- 2 At the **Name:** prompt, edit the name if desired, then press **OK**.

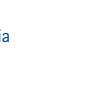
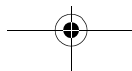
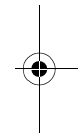
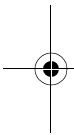



Special features

- 3 At the **Number:** prompt, edit the number if desired, then press **OK**.
- 4 At the **E-mail** address prompt, edit the e-mail address if desired, then press **OK**.

Delete a viewed business card

After viewing the business card:

- 1 Press **Back**.
- 2 Scroll to **Discard**, then press **Select**.
- 3 **Discard business card?** appears, press **OK**.

• DOWNLOAD A RINGING TONE

You can download up to ten ringing tones to replace the personal entries in your list of ringing tones. Since this is a network dependent feature, methods for downloading ringing tones vary. Some wireless providers allow you to send ringing tones to your phone via the Internet, but may charge for this service. Please contact your wireless service provider for details.

Notification of a received ringing tone

If you have this service and your phone receives a downloaded ringing tone, your phone displays **Ringling tone received**.

Listen to received ringing tones

- 1 When your phone shows **Ringling tone received**, press **Options**.
- 2 **Playback** is selected. Press **OK**.
The phone plays the ringing tone.
- 3 To stop playing the ringing tone, press **Quit**.



Note: An incoming call or pressing any key stops the ringing tone from playing.

Save a received ringing tone

- 1 After listening to the ringing tone, press **Quit**.
- 2 Scroll to **Save tone**. Press **OK**.
- 3 Choose which ringing tone you want to replace – either an empty **Personal** location, if any are remaining, or a previously downloaded tone.

Discard a received ringing tone

- 1 After listening to the ringing tone, press **Quit**.
- 2 Scroll to **Discard tone**, then press **OK**.

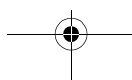
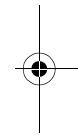
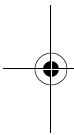

12 Prepaid services

With prepaid service, you buy wireless network services in advance. Your phone works the same way it did before, with some additional features.

Since prepaid service may not be available from your wireless service provider, the **Prepaid** screen may not appear. Contact your service provider for details.

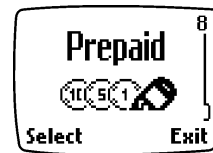

• MANAGE PREPAID SERVICE

After you sign up with your service provider for prepaid service, you can activate the **Prepaid** menu in your phone. This menu appears on your screen only if you've activated the service.

ACTIVATE PREPAID

To activate prepaid services, enter the following sequence: *#7766#

DEACTIVATE PREPAID

To deactivate prepaid services, enter the following sequence: *#77633#

USE THE MENU

- To use the prepaid menu, press **Menu** and then press the **Scroll up** key to go immediately to **Prepaid**.
- Once you select the prepaid menu, press the **Scroll up** or **Scroll down** key to scroll through prepaid options.

• CHECK YOUR PREPAID BALANCE

You can check the balance remaining in your prepaid account. Contact your service provider for the access number used to check the balance.



Note: When no more charging units or currency units are left, calls may only be possible to the emergency number programmed into your phone (for example, 911 or other official emergency number).

- 1 Press **Menu 8-1 (Prepaid > Check account balance)**.
- 2 At **Balance number**, enter the balance number and press **OK**.
If you have already saved the balance number under **Save access phone numbers**, the phone will initiate a call to the saved number.
- 3 Follow the operator prompts.



Prepaid services

• **ADD MONEY TO YOUR ACCOUNT**

Call the access number your service provider gave you to add money to your account. For convenience, see "Save your access numbers" on page 80.

- 1 Press **Menu 8-2 (Prepaid > Add money to account)**.
- 2 At **Replenish no.**, enter the replenish number and press **OK**.
If you have already saved the replenish number under **Save access phone numbers**, the phone will initiate a call to the saved number.
- 3 Follow the operator prompts.

• **CALL CUSTOMER SERVICE**

You can call the customer service number for your prepaid account. Contact your service provider for the access numbers.

- 1 Press **Menu 8-3 (Prepaid > Call customer service)**.
- 2 Enter the customer service number your service provider gave you, then press **OK**.
If you have already saved the customer service number under **Save access phone numbers**, the phone will initiate a call to the saved number.
- 3 Follow the operator prompts.

• **SAVE YOUR ACCESS NUMBERS**

You can check your prepaid balance, add money to your account, and call customer service. To do that, you first need to save the correct access numbers in your phone. Contact your service provider for the access numbers.

- 1 Press **Menu 8-4 (Prepaid > Save access phone numbers)**.
- 2 At **Save access phone numbers**, press **Select**.
- 3 Scroll to **Replenish phone number**, press **Select**, enter the replenish number from your service provider, then press **OK**.
- 4 Scroll to **Balance phone number**, press **Select**.
- 5 Enter the balance number from your service provider, then press **OK**.
- 6 Scroll to **Customer service phone number**, then press **Select**.
- 7 Enter the customer service number from your service provider, then press **OK**.

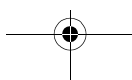
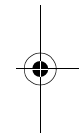
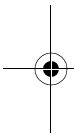



• EXPIRATION DATE

You can store and edit the expiration date of your prepaid credit each time you add money to your account. Enter and change this date manually.

- 1 Press **Menu 8 (Prepaid)**.
- 2 Scroll to **Expiration date**, then press **Select**.
- 3 Enter the expiration date, then press **OK**.

To simply view the current expiration date that you have entered, press **Menu 8-5 (Prepaid > Expiration date)**.

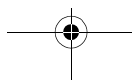
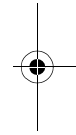
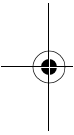

Games

13 Games

You can use your phone for communication *and* some serious fun. Your phone offers three games:

- Snake II
- Space impact
- Pairs II



 **Note:** Your phone must be switched on to use this function. Do not switch on the phone when wireless phone use is prohibited or when it may cause interference or danger.

• START A NEW GAME

- 1 Press **Menu 6 (Games)**
- 2 Scroll to the desired game and press **Select**.
- 3 Select **New game**, then press **Select**.

Additional options under each game include:

Option	What it does
Continue	Continue a game that was stopped.
New Game	Start a new game.
Level (Snake II and Pairs II only)	Choose the game's difficulty level.
Mazes (Snake II only)	Choose among different maze designs.
Top score	Display the top score.
Instructions	Learn how to play the game.
Time trial (Pairs II only)	To advance to the next level, you must pair up all tiles before the dynamite fuse runs out.
Puzzle (Pairs II only)	Reveal pictures to find pairs with as few tries as possible.

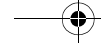

Please visit Nokia games services on the Internet for more hints and tips at:
www.nokia.com/us.

GAME SETTINGS

Game sounds and lights can be turned on or off. To access the **Settings** menu, press **Menu 6-4 (Games > Settings)**.

• SNAKE II

Feed the snake with as many goodies as possible and watch it grow. Press **Menu 6-1**.

To turn the snake toward the food, press **2, 4, 6, and 8**. The longer the snake's tail grows, the higher your score. You can choose to have a clear field, or select from five different mazes. If the snake runs into its own tail or the surrounding wall, found in one of the maze levels, the game is over.

• SPACE IMPACT

Use your weapons to survive alien attacks. When you defeat all the enemies, you progress to the next level. Press **Menu 6-2**.

- To move up and down, press **8** and **0**.
- To move to the left and right, press ***** and **#**.
- To fire the main weapons, press **1** or **3**.
- To fire the bonus weapons, press **4** or **6**.

• PAIRS II

The object of the game is to uncover the pictures to find pairs in as few tries as possible. Press **Menu 6-3** and choose between **Time Trial** and **Puzzle**.

Move the cursor with keys **2, 4, 5, and 8**.

To reveal the pictures, press **5**.

When playing in **Time trial** mode, you must match all the pairs before the dynamite fuse runs out in order to advance to the next level.

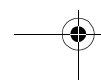
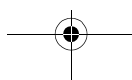
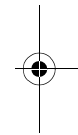
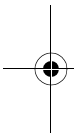

Minute Manager

14 Minute Manager

With **Minute Manager** service, you cap monthly spending of cellular service. This section describes how you can use your Minute Manager menu to manage your cellular account. Since this service may not be available from your wireless service provider, the **Minute Mgr.** screen may not appear. Contact your service provider for details.



 **Note:** The actual invoice for calls and services from your service provider may vary, depending upon network features, rounding-off for billing, taxes, and so forth.

• CHECK YOUR CALL INFORMATION

You can check information on charges, minutes and messages. To access this information press **Menu 9-1 (Minute Mgr. > My calls)**.

My charges

My charges allows you to view your current call charges. You can view the current charges for all calls made this billing cycle, or you can view the charge for the last call you made. My charges information is approximate. The actual charges and minutes will be listed on your monthly bill. To view your charges:

- 1 Press **Menu 9-1-1 (Minute Mgr. > My calls > My charges)**.
- 2 Scroll to **Current** or **My last call**.
- 3 Press **Select** to view the charges. Press **Back** to return to the previous screen.

 **Note:** If you exceed your Minute Manager limit, calls may only be possible to the emergency number programmed into your phone (for example, 911 or other official emergency number).

You can also call 611 and the customer service number for your Minute Manager account.

My minutes

You can check the minutes you've used in the current billing cycle, as well as the number of anytime minutes remaining in your plan's package. This information is for regular plan minutes. It does not include information on long distance calls or SMS messages. To view your minutes:

- 1 Press **Menu 9-1-2 (Minute Mgr. > My calls > My minutes)**.



- 2 Scroll to **Minutes used** or **Package mins**.
- 3 Press **Select** to view the number of minutes.

My data

You can check the total number of SMS messages you have sent and received. This number includes any free messages provided by your plan.

- 1 Press **Menu 9-1-3 (Minute Mgr. > My calls > My data)**.
- 2 Scroll to **Messages sent** or **Msgs received**.
- 3 Press **Select** to view the number of messages.

• CHECK YOUR ACCOUNT INFORMATION

You can check information on your current bill, limit and rate plan.

To access this information press **Menu 9-2 (Minute Mgr. > My account)**.

My bill

Bill information is updated by your service provider and reflects the current amount owed.

To view your current bill, press **Menu 9-2-1 (Minute Mgr. > My account > My bill)**.

My bill date

The bill date is the date when the next bill cycle starts.

To view your bill date, press **Menu 9-2-2 (Minute Mgr. > My account > My bill date)**.

My limit

You can view the spending limit of your account. This amount is set by your service provider during account activation and is independent of any balance information. Contact your service provider for more information.

To view your limit, press **Menu 9-2-3 (Minute Mgr. > My account > My limit)**.

My rate plan

This menu provides information about your current rate plan.

Press **Menu 9-2-4 (Minute Mgr. > My account > My rate plan)**.

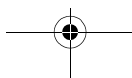
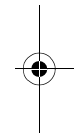
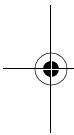



Minute Manager

My number

To view your mobile number, press **Menu 9-2-5 (Minute Mgr. > My account > My number)**.

• **CUSTOMER CARE**

You can call the customer care number for your Minute Manager account. This is the same number you will call to make a payment. The customer care number may be pre-programmed in your phone. If not, contact your service provider for the number.

Make a payment

You can follow these steps to contact customer service and to make a payment.

- 1 Press **Menu 9-3 (Minute Mgr. > Customer care)**.
- 2 When **Make payment** is highlighted, press **Select**. The customer care number will appear on the screen.
- 3 Press **Call** to dial the number.

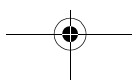
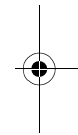
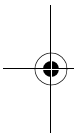



15 Reference information

This section provides information about your phone's batteries, accessories, chargers, safety guidelines and technical information. Be aware that the information in this section is subject to change as batteries, chargers, and accessories change.

• BATTERY STATEMENTS

Charging and discharging

Your phone is powered by a rechargeable battery.

Note that a new battery's full performance may be achieved only after two or three complete charge and discharge cycles!

The battery can be charged and discharged hundreds of times but it will eventually wear out. When the operating time (talk time and standby time) is noticeably shorter than normal, it is time to buy a new battery.

Use only batteries approved by the phone manufacturer and recharge your battery only with the chargers approved by the manufacturer. Unplug the charger when not in use. Do not leave the battery connected to a charger for longer than a week, since overcharging may shorten its lifetime. If left unused, a fully charged battery will discharge itself over time.

Temperature extremes can affect the ability of your battery to charge; allow it to cool down or warm up first.

For good operation times with NiMH batteries, discharge the battery from time to time by leaving your phone switched on until it turns itself off (or by using the battery discharge facility of any approved accessory available for your phone).

Do not attempt to discharge the battery by any other means.

Use the battery only for its intended purpose.

Never use any charger or battery which is damaged or worn out.

Do not short-circuit the battery. Accidental short-circuiting can occur when a metallic object (coin, clip, or pen) causes direct connection of the + and - terminals of the battery (metal strips on the battery), for example, when you carry a spare battery in your pocket or purse. Short-circuiting the terminals may damage the battery or the connecting object.

Leaving the battery in hot or cold places, such as in a closed car in summer or winter conditions, will reduce the capacity and lifetime of the battery. Always try to keep the battery between 59°F and 77°F (15°C and 25°C). A phone with a hot or cold battery may temporarily not work, even when the battery is fully charged.

Batteries' performance is particularly limited in temperatures well below freezing.

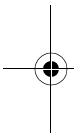

Reference information

Do not dispose of batteries in a fire!

Dispose of batteries according to applicable local regulations (for example, recycling). Do not dispose of as household waste.



Note: For information on how to charge and recharge your battery, refer to "Important battery information" on page 18.

• PROPER CARE AND MAINTENANCE

Your phone is a product of superior design and craftsmanship and should be treated with care. The suggestions below will help you to fulfill any warranty obligations and to enjoy this product for many years:

- Keep the phone and all its parts and accessories out of the reach of small children.
- Keep the phone dry. Precipitation, humidity and all types of liquids or moisture can contain minerals that will corrode electronic circuits.
- Do not use or store the phone in dusty, dirty areas. Its moving parts can be damaged.
- Do not store the phone in hot areas. High temperatures can shorten the life of electronic devices, damage batteries, and warp or melt certain plastics.
- Do not store the phone in cold areas. When it warms up (to its normal temperature), moisture can form inside and may damage electronic circuit boards.
- Do not attempt to open the phone. Nonexpert handling may damage it.
- Do not drop, knock, or shake the phone. Rough handling can break internal circuit boards.
- Do not use harsh chemicals, cleaning solvents, or strong detergents to clean the phone.
- Do not paint the phone. Paint can clog the moving parts and prevent proper operation.
- Use only the supplied or an approved replacement antenna. Unauthorized antennas, modifications, or attachments could damage the phone and may violate regulations governing radio devices.

All of the above suggestions apply equally to your phone, battery, charger or any accessory. If any of them are not working properly, take them to your nearest qualified service facility. The personnel there will assist you, and if necessary, arrange for service.



• IMPORTANT SAFETY INFORMATION

This section provides additional safety information. A brief overview of safety can be found in "For your safety" on page 7.

Traffic safety

Do not use a hand-held telephone while driving a vehicle. Always secure the phone in its holder; do not place the phone on the passenger seat or where it can break loose in a collision or sudden stop.

Remember road safety always comes first!

Operating environment

Remember to follow any special regulations in force in any area and always switch off your phone whenever it is forbidden to use it, or when it may cause interference or danger.

Use the phone only in its normal operating positions.

Parts of the phone are magnetic. Metallic materials may be attracted to the phone, and persons with a hearing aid should not hold the phone to the ear with the hearing aid. Always secure the phone in its holder, because metallic materials may be attracted by the earpiece. Do not place credit cards or other magnetic storage media near the phone, because information stored on them may be erased.

Electronic devices

Most modern electronic equipment is shielded from radio frequency (RF) signals. However, certain electronic equipment may not be shielded against the RF signals from your wireless phone.

PACEMAKERS

Pacemaker manufacturers recommend that a minimum separation of 6-8 inches (20 cm) be maintained between a hand-held wireless phone and a pacemaker to avoid potential interference with the pacemaker. These recommendations are consistent with the independent research by and recommendations of Wireless Technology Research. Persons with pacemakers:

- Should always keep the phone more than 6 inches (20 cm) from their pacemaker when the phone is switched on
- Should not carry the phone in a breast pocket
- Should use the ear opposite the pacemaker to minimize the potential for interference.
- If you have any reason to suspect that interference is taking place, switch off your phone immediately.

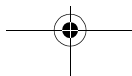
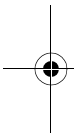



Reference information

HEARING AIDS

Some digital wireless phones may interfere with some hearing aids. In the event of such interference, you may want to consult your service provider.

Other medical devices

Operation of any radio transmitting equipment, including cellular phones, may interfere with the functionality of inadequately protected medical devices. Consult a physician or the manufacturer of the medical device to determine if they are adequately shielded from external RF energy or if you have any questions. Switch off your phone in health care facilities when any regulations posted in these areas instruct you to do so. Hospitals or health care facilities may be using equipment that could be sensitive to external RF energy.

Vehicles

RF signals may affect improperly installed or inadequately shielded electronic systems in motor vehicles (for example, electronic fuel injection systems, electronic antiskid/antilock braking systems, electronic speed control systems, air bag systems). Check with the manufacturer or its representative regarding your vehicle. You should also consult the manufacturer of any equipment that has been added to your vehicle.

POSTED FACILITIES

Switch your phone off in any facility where posted notices so require.

Potentially explosive atmospheres

Switch off your phone when in any area with a potentially explosive atmosphere and obey all signs and instructions. Sparks in such areas could cause an explosion or fire resulting in bodily injury or even death.

Users are advised to switch off the phone when at a refuelling point (service station). Users are reminded of the need to observe restrictions on the use of radio equipment in fuel depots (fuel storage and distribution areas), chemical plants, or where blasting operations are in progress.

Areas with a potentially explosive atmosphere are often but not always clearly marked. They include below deck on boats; chemical transfer or storage facilities; vehicles using liquefied petroleum gas (such as propane or butane); areas where the air contains chemicals or particles, such as grain, dust, or metal powders; and any other area where you would normally be advised to turn off your vehicle engine.

Vehicles

Only qualified personnel should service the phone or install the phone in a vehicle. Faulty installation or service may be dangerous and may invalidate any warranty which may apply to the unit.

Check regularly that all wireless phone equipment in your vehicle is mounted and operating properly.

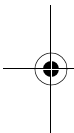



Do not store or carry flammable liquids, gases or explosive materials in the same compartment as the phone, its parts or accessories.

For vehicles equipped with an air bag, remember that an air bag inflates with great force. Do not place objects, including both installed or portable wireless equipment in the area over the air bag or in the air bag deployment area. If in-vehicle wireless equipment is improperly installed and the air bag inflates, serious injury could result.

FCC regulations prohibit using your phone while in the air. Switch off your phone before boarding an aircraft. The use of wireless telephones in an aircraft may be dangerous to the operation of the aircraft, disrupt the wireless telephone network, and may be illegal.

Failure to observe these instructions may lead to suspension or denial of telephone services to the offender, legal action or both.

• MAKE EMERGENCY CALLS



Important: This phone, like any wireless phone, operates using radio signals, wireless, and landline networks as well as user-programmed functions. Because of this, connections in all conditions cannot be guaranteed. Therefore you should never rely solely upon any wireless phone for essential communications (for example, medical emergencies).

Emergency calls may not be possible on all wireless phone networks or when certain network services and/or phone features are in use. Check with local service providers.

To make an emergency call

- 1 If the phone is not on, switch it on, then check for adequate signal strength.
- 2 Press the **End** key as many times as needed (for example, to exit a call, to exit a menu, etc.) to clear the display and ready the phone for calls.
- 3 Key in the emergency number for your present location (for example, 911 or other official emergency number). Emergency numbers vary by location.
- 4 Press the **Talk** key.

If certain features are in use, (keyguard, etc.) you may first need to turn those features off before you can make an emergency call. Consult this user guide and your local wireless service provider.

When making an emergency call, remember to give all the necessary information as accurately as possible. Remember that your wireless phone may be the only means of communication at the scene of an accident - do not end the call until given permission to do so.

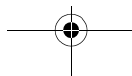
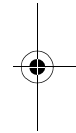
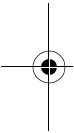



Reference information

Certification Information (SAR)

THIS MODEL PHONE MEETS THE GOVERNMENT'S REQUIREMENTS FOR EXPOSURE TO RADIO WAVES.

Your wireless phone is a radio transmitter and receiver. It is designed and manufactured not to exceed the emission limits for exposure to radio frequency (RF) energy set by the Federal Communications Commission of the U.S. Government. These limits are part of comprehensive guidelines and establish permitted levels of RF energy for the general population. The guidelines are based on standards that were developed by independent scientific organizations through periodic and thorough evaluation of scientific studies. The standards include a substantial safety margin designed to assure the safety of all persons, regardless of age and health.

The exposure standard for wireless mobile phones employs a unit of measurement known as the Specific Absorption Rate, or SAR. The SAR limit set by the FCC is 1.6W/kg.* Tests for SAR are conducted using standard operating positions accepted by the FCC with the phone transmitting at its highest certified power level in all tested frequency bands. Although the SAR is determined at the highest certified power level, the actual SAR level of the phone while operating can be well below the maximum value. This is because the phone is designed to operate at multiple power levels so as to use only the power required to reach the network. In general, the closer you are to a wireless base station antenna, the lower the power output. Before a phone model is available for sale to the public, it must be tested and certified to the FCC that it does not exceed the limit established by the government-adopted requirement for safe exposure. The tests are performed in positions and locations (for example, at the ear and worn on the body) as required by the FCC for each model. The highest SAR value for this model phone as reported to the FCC when tested for use at the ear is 1.08 W/kg, and when worn on the body, as described in this user guide, is 0.96 W/kg.

(Body-worn measurements differ among phone models, depending upon available accessories and FCC requirements).

While there may be differences between the SAR levels of various phones and at various positions, they all meet the government requirement.

The FCC has granted an Equipment Authorization for this model phone with all reported SAR levels evaluated as in compliance with the FCC RF exposure guidelines. SAR information on this model phone is on file with the FCC and can be found under the Display Grant section of <http://www.fcc.gov/oet/fccid> after searching on FCC ID GMLRH-39.

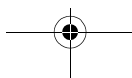
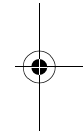
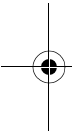

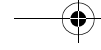

For body worn operation, this phone has been tested and meets the FCC RF exposure guidelines for use with an accessory that contains no metal and that positions the handset a minimum of 5/8 inch (1.5 cm) from the body. Use of other accessories may not ensure compliance with FCC RF exposure guidelines. If you do not use a body-worn accessory and are not holding the phone at the ear, position the handset a minimum of 5/8 inch (1.5 cm) from your body when the phone is switched on.

*In the United States and Canada, the SAR limit for mobile phones used by the public is 1.6 watts/kilogram (W/kg) averaged over one gram of tissue. The standard incorporates a substantial margin of safety to give additional protection for the public and to account for any variations in measurements. SAR values may vary depending on national reporting requirements and the network band. For SAR information in other regions please look under product information at www.nokia.com/us.

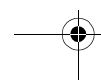
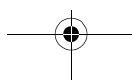
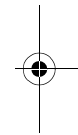
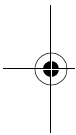

Reference information

• ACCESSORY SAFETY

This section provides information about the phone's batteries, chargers, and accessories. Be aware that the information in this section is subject to change as the batteries, chargers, and accessories change.

Check the model number of any charger before use with this phone. This device is intended for use when supplied with power from an ACP-7, ACP-8, ACP-12 or LCH-9 charger.



Warning: Use only Nokia original accessories or batteries, chargers, and accessories approved by Nokia, for use with this Nokia phone model. The use of any other types may invalidate any approval or warranty applying to the phone, and may be dangerous.

For availability of approved accessories, please check with your dealer.

When you disconnect the power cord of any accessory, grasp and pull the plug, not the cord.

When you are not using a charger, disconnect it from the power source.

When the battery is running out of power and your phone only has a few minutes of talk time remaining, a warning tone sounds and the **Battery low** message appears briefly. When no more talk time is left, a warning tone is sounded and the phone switches itself off.

Practical rules for accessory operation

- Keep all accessories out of reach of small children.
- When you disconnect the power cord of any accessory, grasp and pull the plug, not the cord.
- Check regularly that any vehicle-installed accessories are mounted and are operating properly.
- Installation of any complex car accessories must be made by qualified personnel only.
- Use only batteries, chargers, and accessories that have been approved by the phone manufacturer. The use of any other types could invalidate any approval or warranty applying to the phone and could be dangerous. Refer to "Accessory safety" on page 94 for important battery usage information.

Batteries

This section provides information about the phone's battery. Be aware that the information in this section is subject to change.



Note: Dispose of used batteries in accordance with any local regulations.

The tables shown in this section provide information about the batteries that are available for your phone, charging times with the Rapid Travel Charger (ACP-8 and ACP-12), the Standard Travel Charger (ACP-7), talk times, and standby times. Consult your service provider for more information.

Charging times

The charging times listed below are approximate.

Battery option	ACP-7 Charger	ACP-8 Charger	ACP-12 Charger
BMC-3 NiMH Battery 900 mAh	up to 4 hours	up to 2 hours	up to 1 hour, 40 minutes

Standby and talk times

Battery talk and standby times are estimates only and depend on signal strength, network conditions, features used, battery age and condition (including the effect of charging habits), temperatures to which the battery is exposed, use in digital mode, and many other factors. Please note that the amount of time a phone is used for calls will affect its standby time. Likewise, the amount of time that the phone is turned on and in standby mode will affect its talk time.

Battery option	Talk time		Standby Time	
	Digital	Analog	Digital	Analog
BMC-3 NiMH Battery 900 mAh	up to 5 hours	up to 2 hours	up to 15 days	up to 2 days
BLC-2 Li-Ion Battery 950 mAh	up to 5 hours	up to 2 hours	up to 16 days	up to 2 days

Reference information

• **ACCESSORIES**

If you want to enhance the functionality of your phone, a range of accessories is available for you. You can select any of these items to help accommodate your specific communication needs. For availability of these and other accessories, contact your service provider.



Warning: Use only Nokia original accessories, or batteries, chargers and accessories approved by Nokia, for use with this Nokia phone model. The use of any other types may invalidate any approval or warranty applying to the phone, and may be dangerous.

900 mAh NiMH Battery (BMC-3)

Provides up to 5 hours of digital talk time and up to 15 days of digital standby time. Provides up to 2 hours of analog talk time and up to 2 days of analog standby time.



Note: Operation times are estimates and may vary depending on network conditions, charging and phone use.

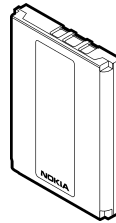

950 mAh Li-Ion Battery (BLC-2)

Provides up to 5 hours of digital talk time and up to 16 days of digital standby time. Provides up to 2 hours of analog talk time and up to 2 days of analog standby time.



Note: Operation times are estimates and may vary depending on network conditions, charging and phone use.

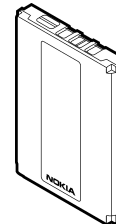

Standard Travel Charger (ACP-7)

The Standard Travel Charger is a lightweight (187 g) and durable AC charger.

To use the Standard Travel Charger, plug it into a standard 120 V AC wall outlet and connect the lead from the charger to the base of your phone.



Note: If the battery is completely empty, you cannot use the phone until it has enough charge to operate.

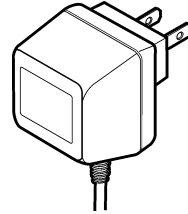

Rapid Travel Charger (ACP-8)

The Rapid Travel Charger is a lightweight (100 g) and durable AC charger. Calls can be made during charging, even with a fully discharged battery.

To use the Rapid Travel Charger (ACP-8), plug it into a standard 120- or 220-Vac wall outlet, and connect the lead from the charger to the base of your phone.

Approximate charging times for discharged batteries are shown in "Charging times" on page 95.

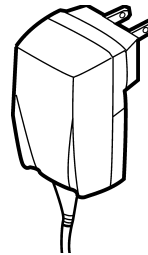

Rapid Travel Charger (ACP-12)

The Rapid Travel Charger is a lightweight and durable AC charger. Calls can be made during charging, even with a fully discharged battery.

To use the Rapid Travel Charger (ACP-12), plug it into a standard 120- or 220-Vac wall outlet, and connect the lead from the charger to the base of your phone.

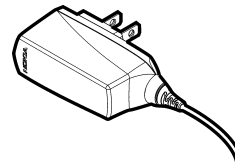

Reference information

Rapid Cigarette Lighter Charger (LCH-9)

You can charge your phone's battery from your vehicle battery by using the Rapid Cigarette Lighter Charger (LCH-9).

Calls are possible during charging. A green light indicates that the charger is ready for charging. The battery charging times are the same as those for the Rapid Travel Charger (ACP-8).

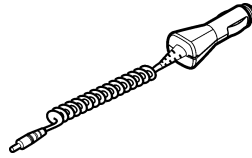

The input voltage range is from 11-24 Vdc, negative grounding. Avoid prolonged charging with the Rapid Cigarette Lighter Charger (LCH-9) when the car engine is not running; this could cause your car battery to drain. Note also, that in some cars, the cigarette lighter plug is not provided with electricity if the ignition is not switched on.

Spare Battery Charger (DDC-1)

Lightweight and stylish, this charger provides a convenient way to charge your spare battery.

This charger is compatible with the Standard Travel Charger (ACP-7) and the Rapid Travel Charger (ACP-8).

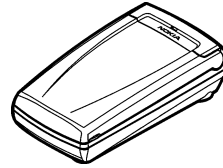

Headset (HDC-5)

Small and lightweight, the headset allows easy and convenient hands-free operation. The headset has a foam earpiece cover for a comfortable fit and has a clip to hold it firmly in place. This headset's 4-wire 2.5 mm plug fits directly into the bottom of the phone. A remote control button located in the microphone makes the headset convenient to use while answering or receiving calls.

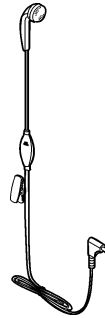

Headset (HDE-2)

Small and lightweight, the headset allows easy and convenient hands-free operation. This headset comes with a clip for a comfortable fit. This headset's 4-wire 2.5 mm plug fits directly into the bottom of your phone.

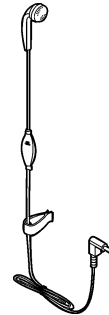

Boom Headset (HDB-5)

Compact and functional, the Boom Headset provides you with convenient, portable hands-free facility. A new and modern "over the ear" concept with a stylish design and basic hands-free functionality, including the answer/end button.

This headset's 4-wire 2.5 mm plug fits directly into the bottom of your phone.



Retractable Headset Kit (HDC-10)

Compact and functional, this headset provides you with convenient, portable, hands-free operation. The retractable mechanism and remote control provide easy operation.

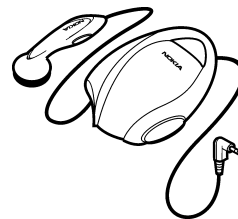

Reference information

Loopset (LPS-3)

With the Nokia Loopset, people who use a T-coil equipped hearing aid have the freedom to talk on a digital mobile phone. The loopset goes around your neck - so it can be worn comfortably and discreetly.

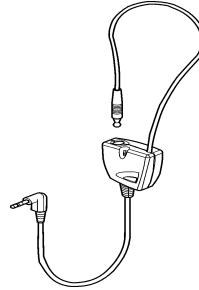

TTY/TDD Adapter (HDA-9)

The TTY/TDD Adapter is a Nokia accessory that allows you to connect your mobile phone to a Telecommunications Device for the Deaf (TTY/TDD) to make a call in digital mode.

WHAT YOU'LL NEED

Here is what you'll need for TTY/TDD communication.

- A TTY/TDD device that is "cellular ready" or "cellular compatible"
- A cable for connecting the TTY/TDD to your phone, usually supplied by the manufacturer of the TTY/TDD device.
- The TTY/TDD Adapter (HDA-9), which can be purchased separately as an accessory at www.nokia.com/us.

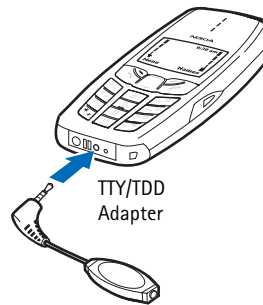

Mobile Holder (MBC-6)

Small and easy to use, the Mobile Holder provides an ideal place to hold the phone in a vehicle. The Mobile Holder is easy to attach to the dashboard via a mounting plate or swivel. The Mobile Holder is compatible with the Rapid Cigarette Lighter Charger (LCH-9) and the Express Car Kit (PPH-1).

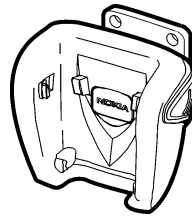

Express Car Kit (CARK-125)

This car kit provides charging and hands-free functionality. With excellent audio quality, the car kit is easy to use and is compatible with 12 V systems.

The Express Car Kit includes a holder and plug-in, hands-free, external microphone.

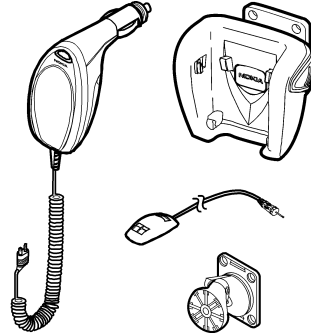

Express Car Kit (PPH-1)

The Express Car Kit provides charging and hands-free functionality. Compatible with 12 V systems, the Express Car Kit plugs into the cigarette lighter socket for charging. A green light indicates readiness for charging. The Express Car Kit has a built in speaker and uses the phone's microphone. The Express Car Kit also has a connector for an optional external microphone (HFM-8). The microphone should be installed 20 inches apart from the external speaker.

The Express Car Kit requires no screws for installation and thus can be moved easily from car to car.

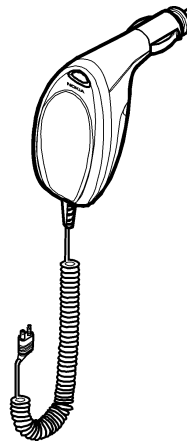

Reference information

Full Car Kit (CARK-134)

The Full Car Kit (CARK-134) offers a convenient hands-free option, automatic charging facility, transmission capacity with external antenna connection and car radio mute.

The Full Car Kit contains the following:

- HHS-9 Swivel Mount
- HFU-5 Junction Box
- MKU-1 Mounting Plate
- HFM-8 Handsfree Microphone
- HFS-12 External Handsfree Speaker
- PCH-4J Power Cable

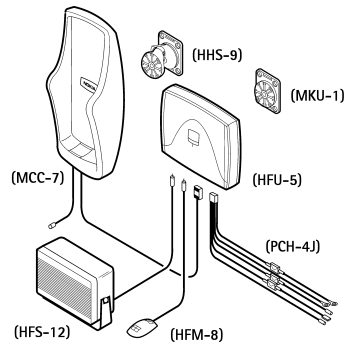

Carry case (CSM-6)

Handsome leather case helps protect your phone and allows for easy keypad access. The clip attaches to your belt for convenience. (shown at right)





Nokia Xpress-on™ color covers

The Xpress-on™ cover is available in several fashion colors. Extra covers may be purchased from your authorized Nokia dealer.



Note: Before changing the cover, always switch off the power and disconnect the phone from the charger or any other device. Always store the phone with covers attached.

REMOVE THE BACK COVER

- 1 Switch off the power and disconnect the phone from the charger or any other device.
- 2 Push in the release button on the back of the phone, slide the cover toward the top of the phone, and remove it.

REMOVE THE FRONT COVER

- 1 Use the finger rests on each side of the phone and hold the phone face down.
- 2 While holding the phone, place your finger on the groove between the phone and the cover.
- 3 Gently pry the front cover away from the phone and lift the phone out of the cover.

REMOVE THE KEYPAD

- 1 Lift the keypad from the inside of the front cover.
- 2 Place the keypad into the new front cover.

REPLACE THE FRONT COVER

- 1 Slide the top of the phone into the top of the front cover.
Be careful to align the power key/IR port with its place in the top of the front cover.
- 2 Gently push the bottom of the phone into the bottom of the front cover until it snaps into place.

REPLACE THE BACK COVER

- 1 Insert the two catches of the back cover in the corresponding slots in the phone.
- 2 Slide the cover towards the bottom of the phone until it locks into place.

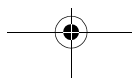
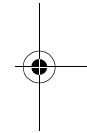
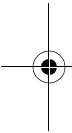

*Reference information***• TECHNICAL INFORMATION**

Feature	Specification
Weight	4.23 oz with BLC-2 battery 5.17 oz with BMC-3 battery
Volume	108 cc
Frequency Range	Lowband 824.04 - 848.97 MHz (TX) 869.04 - 893.97 MHz (RX) Highband 1850.04 - 1909.92 MHz (TX) 1930.08 - 1989.96 MHz (RX)
Transmitter Output Power	Up to 600 mW
Battery Voltage	3.6 V nominal
Operating Temperature	-4°F to + 104°F (-20°C to + 40°C)
Number of Channels	832 lowband 1997 highband
Phone Numbers	Up to 3
Contact List Locations	Up to 200

• TROUBLESHOOTING

This section lists some of the most commonly encountered problems and provides possible solutions.

Problem	Possible cause	Possible solution
My phone is not charging.	The charger and the phone are not properly connected.	Securely connect the charger to the phone.
	The charger is not properly plugged in.	Ensure that the charger is plugged in correctly.
My phone is not making or answering calls.	The battery is not charged.	Charge the battery.
	The signal strength is too low.	If you are indoors, move toward a window.
I cannot listen to my voice messages.	You do not have voice mail service.	This is a service provider dependent feature. Please call your wireless service provider.
	The voice mail number you have saved is incorrect.	
	You have forgotten your password or are entering in incorrectly.	
	Your voice mail number is not saved in the phone.	Refer to "Save the voice mailbox number" on page 44.

Reference information

Nokia One-Year Limited Warranty

Nokia Inc. ("Nokia") warrants that this cellular phone ("Product") is free from defects in material and workmanship that result in Product failure during normal usage, according to the following terms and conditions:

- 1 The limited warranty for the Product extends for ONE (1) year beginning on the date of the purchase of the Product. This one year period is extended by each whole day that the Product is out of your possession for repair under this warranty.
- 2 The limited warranty extends only to the original purchaser ("Consumer") of the Product and is not assignable or transferable to any subsequent purchaser/end-user.
- 3 The limited warranty extends only to Consumers who purchase the Product in the United States of America.
- 4 During the limited warranty period, Nokia will repair, or replace, at Nokia's sole option, any defective parts, or any parts that will not properly operate for their intended use with new or refurbished replacement items if such repair or replacement is needed because of product malfunction or failure during normal usage. No charge will be made to the Consumer for any such parts. Nokia will also pay for the labor charges incurred by Nokia in repairing or replacing the defective parts. The limited warranty does not cover defects in appearance, cosmetic, decorative or structural items, including framing, and any non-operative parts. Nokia's limit of liability under the limited warranty shall be the actual cash value of the Product at the time the Consumer returns the Product for repair, determined by the price paid by the Consumer for the Product less a reasonable amount for usage. Nokia shall not be liable for any other losses or damages. These remedies are the Consumer's exclusive remedies for breach of warranty.
- 5 Upon request from Nokia, the Consumer must prove the date of the original purchase of the Product by a dated bill of sale or dated itemized receipt.
- 6 The Consumer shall bear the cost of shipping the Product to Nokia in Melbourne, Florida. Nokia shall bear the cost of shipping the Product back to the Consumer after the completion of service under this limited warranty.
- 7 The Consumer shall have no coverage or benefits under this limited warranty if any of the following conditions are applicable:
 - a) The Product has been subjected to abnormal use, abnormal conditions, improper storage, exposure to moisture or dampness, unauthorized modifications, unauthorized connections, unauthorized repair, misuse, neglect, abuse, accident, alteration, improper installation, or other acts which are not the fault of Nokia, including damage caused by shipping.



- b) The Product has been damaged from external causes such as collision with an object, or from fire, flooding, sand, dirt, windstorm, lightning, earthquake or damage from exposure to weather conditions, an Act of God, or battery leakage, theft, blown fuse, or improper use of any electrical source, damage caused by computer or internet viruses, bugs, worms, Trojan Horses, cancelbots or damage caused by the connection to other products not recommended for interconnection by Nokia.
 - c) Nokia was not advised in writing by the Consumer of the alleged defect or malfunction of the Product within fourteen (14) days after the expiration of the applicable limited warranty period.
 - d) The Product serial number plate or the accessory data code has been removed, defaced or altered.
 - e) The defect or damage was caused by the defective function of the cellular system or by inadequate signal reception by the external antenna, or viruses or other software problems introduced into the Product.
- 8** Nokia does not warrant uninterrupted or error-free operation of the Product. If a problem develops during the limited warranty period, the Consumer shall take the following step-by-step procedure:
- a) The Consumer shall return the Product to the place of purchase for repair or replacement processing.
 - b) If "a" is not convenient because of distance (more than 50 miles) or for other good cause, the Consumer shall ship the Product prepaid and insured to:
Nokia Inc., Attn: Repair Department
795 West Nasa Blvd.
Melbourne, FL 32901
 - c) The Consumer shall include a return address, daytime phone number and/ or fax number, complete description of the problem, proof of purchase and service agreement (if applicable). Expenses related to removing the Product from an installation are not covered under this limited warranty.
 - d) The Consumer will be billed for any parts or labor charges not covered by this limited warranty. The Consumer will be responsible for any expenses related to reinstallation of the Product.
 - e) Nokia will repair the Product under the limited warranty within 30 days after receipt of the Product. If Nokia cannot perform repairs covered under this limited warranty within 30 days, or after a reasonable number of attempts to repair the same defect, Nokia at its option, will provide a replacement Product or refund the purchase price of the Product less a reasonable amount for usage. In some states the Consumer may have the right to a loaner if the repair of the Product takes more than ten (10) days.

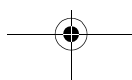
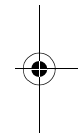
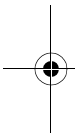



Reference information

Please contact the Customer Service Center at Nokia at the telephone number listed at the end of this warranty if you need a loaner and the repair of the Product has taken or is estimated to take more than ten (10) days.

- f) If the Product is returned during the limited warranty period, but the problem with the Product is not covered under the terms and conditions of this limited warranty, the Consumer will be notified and given an estimate of the charges the Consumer must pay to have the Product repaired, with all shipping charges billed to the Consumer. If the estimate is refused, the Product will be returned freight collect. If the Product is returned after the expiration of the limited warranty period, Nokia's normal service policies shall apply and the Consumer will be responsible for all shipping charges.
- 9 You (the Consumer) understand that the product may consist of refurbished equipment that contains used components, some of which have been reprocessed. The used components comply with Product performance and reliability specifications.
- 10 ANY IMPLIED WARRANTY OF MERCHANTABILITY, OR FITNESS FOR A PARTICULAR PURPOSE OR USE, SHALL BE LIMITED TO THE DURATION OF THE FOREGOING LIMITED WRITTEN WARRANTY. OTHERWISE, THE FOREGOING LIMITED WARRANTY IS THE CONSUMER'S SOLE AND EXCLUSIVE REMEDY AND IS IN LIEU OF ALL OTHER WARRANTIES, EXPRESS OR IMPLIED. NOKIA SHALL NOT BE LIABLE FOR SPECIAL, INCIDENTAL, PUNITIVE OR CONSEQUENTIAL DAMAGES, INCLUDING BUT NOT LIMITED TO LOSS OF ANTICIPATED BENEFITS OR PROFITS, LOSS OF SAVINGS OR REVENUE, LOSS OF DATA, PUNITIVE DAMAGES, LOSS OF USE OF THE PRODUCT OR ANY ASSOCIATED EQUIPMENT, COST OF CAPITAL, COST OF ANY SUBSTITUTE EQUIPMENT OR FACILITIES, DOWNTIME, THE CLAIMS OF ANY THIRD PARTIES, INCLUDING CUSTOMERS, AND INJURY TO PROPERTY, RESULTING FROM THE PURCHASE OR USE OF THE PRODUCT OR ARISING FROM BREACH OF THE WARRANTY, BREACH OF CONTRACT, NEGLIGENCE, STRICT TORT, OR ANY OTHER LEGAL OR EQUITABLE THEORY, EVEN IF NOKIA KNEW OF THE LIKELIHOOD OF SUCH DAMAGES. NOKIA SHALL NOT BE LIABLE FOR DELAY IN RENDERING SERVICE UNDER THE LIMITED WARRANTY, OR LOSS OF USE DURING THE PERIOD THAT THE PRODUCT IS BEING REPAIRED.
- 11 Some states do not allow limitation of how long an implied warranty lasts, so the one year warranty limitation may not apply to you (the Consumer). Some states do not allow the exclusion or limitation of incidental and consequential damages, so certain of the above limitations or exclusions may not apply to you (the Consumer). This limited warranty gives the Consumer specific legal rights and the Consumer may also have other rights which vary from state to state.

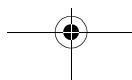
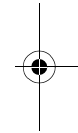
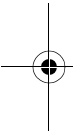

- 12** Nokia neither assumes nor authorizes any authorized service center or any other person or entity to assume for it any other obligation or liability beyond that which is expressly provided for in this limited warranty including the provider or seller of any extended warranty or service agreement.
- 13** This is the entire warranty between the Nokia and the Consumer, and supersedes all prior and contemporaneous agreements or understandings, oral or written, relating to the Product, and no representation, promise or condition not contained herein shall modify these terms.
- 14** This limited warranty allocates the risk of failure of the Product between the Consumer and Nokia. The allocation is recognized by the Consumer and is reflected in the purchase price.
- 15** Any action or lawsuit for breach of warranty must be commenced within eighteen (18) months following purchase of the Product.
- 16** Questions concerning this limited warranty may be directed to:
Nokia Inc.
Attn: Customer Service
7725 Woodland Center Blvd., Ste. 150
Tampa, FL 33614
Telephone: 1-888-NOKIA-2U (1-888-665-4228)
Facsimile: (813) 287-6612
TTY/TDD Users Only: 1-800-24-NOKIA (1-800-246-6542)
- 17** The limited warranty period for Nokia supplied attachments and accessories is specifically defined within their own warranty cards and packaging.

Manufactured or sold under one or more of the following US patents:

5001372	5371481	5553125	5805084	5893060	6006114	6119002	6229996
5045973	5390223	5594797	5819165	5903839	6026161	6119003	6269331
5101175	5400949	5604921	5822366	5907823	6035194	6128509	6282373
5124672	5416435	5606548	5835858	5914796	6043760	6144243	6285888
5212834	5430740	5613235	5839101	5920826	6049796	6151485	6286122
5230091	5442521	5625274	5842141	5924026	6055439	6151507	6292668
5233634	5446364	5677620	5844884	5924038	6060193	6154457	6308084
5241284	5471655	5692032	5845219	5953665	6084962	6163609	6310609
5241583	5479476	5697074	5857151	5956625	6094587	6164547	6311054
5266782	5487084	5734683	5870683	5987406	6097961	6185295	6314166
5317283	5493255	5760568	5887262	5987639	6097964	6188909	6324412
5335362	5551067	5794142	5892475	5999523	6115617	6219560	
Pending:	29158527	29158526	29158528	29158485	29158529	29158524	

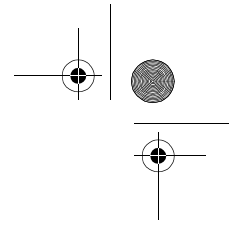
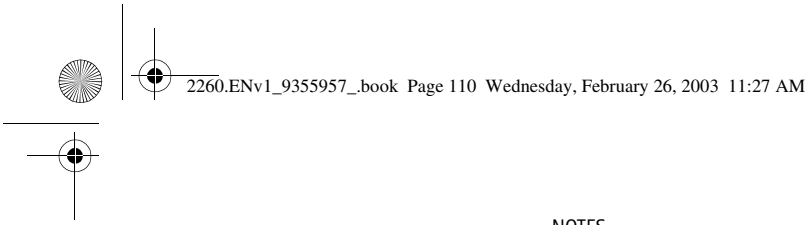

NOTES

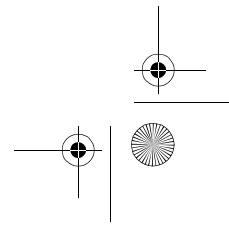
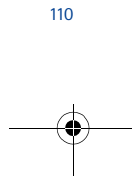
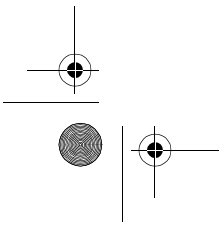
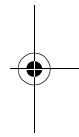
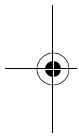



Appendix A

Message from the CTIA (Cellular Telecommunications & Internet Association) to all users of mobile phones.

© 2001 Cellular Telecommunications & Internet Association. All Rights Reserved.
1250 Connecticut Avenue, NW Suite 800, Washington, DC 20036.
Phone: (202) 785-0081

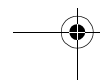
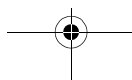
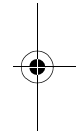
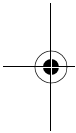



Safety is the most important call you will ever make.

A Guide to Safe and Responsible Wireless Phone Use

Tens of millions of people in the U.S. today take advantage of the unique combination of convenience, safety and value delivered by the wireless telephone. Quite simply, the wireless phone gives people the powerful ability to communicate by voice--almost anywhere, anytime--with the boss, with a client, with the kids, with emergency personnel or even with the police. Each year, Americans make billions of calls from their wireless phones, and the numbers are rapidly growing.

But an important responsibility accompanies those benefits, one that every wireless phone user must uphold. When driving a car, driving is your first responsibility. A wireless phone can be an invaluable tool, but good judgment must be exercised at all times while driving a motor vehicle--whether on the phone or not.

The basic lessons are ones we all learned as teenagers. Driving requires alertness, caution and courtesy. It requires a heavy dose of basic common sense---keep your head up, keep your eyes on the road, check your mirrors frequently and watch out for other drivers. It requires obeying all traffic signs and signals and staying within the speed limit. It means using seatbelts and requiring other passengers to do the same.

But with wireless phone use, driving safely means a little more. This brochure is a call to wireless phone users everywhere to make safety their first priority when behind the wheel of a car. Wireless telecommunications is keeping us in touch, simplifying our lives, protecting us in emergencies and providing opportunities to help others in need.

When it comes to the use of wireless phones, *safety is your most important call.*

Wireless Phone "Safety Tips"

Below are safety tips to follow while driving and using a wireless phone which should be easy to remember.

- 1 Get to know your wireless phone and its features such as speed dial and redial. Carefully read your instruction manual and learn to take advantage of valuable features most phones offer, including automatic redial and memory. Also, work to memorize the phone keypad so you can use the speed dial function without taking your attention off the road.
- 2 When available, use a hands free device. A number of hands free wireless phone accessories are readily available today. Whether you choose an installed mounted device for your wireless phone or a speaker phone accessory, take advantage of these devices if available to you.
- 3 Position your wireless phone within easy reach. Make sure you place your wireless phone within easy reach and where you can grab it without removing your eyes from the road. If you get an incoming call at an inconvenient time, if possible, let your voice mail answer it for you.

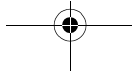
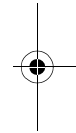
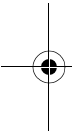



- 4 Suspend conversations during hazardous driving conditions or situations. Let the person you are speaking with know you are driving; if necessary, suspend the call in heavy traffic or hazardous weather conditions. Rain, sleet, snow and ice can be hazardous, but so is heavy traffic. As a driver, your first responsibility is to pay attention to the road.
- 5 Do not take notes or look up phone numbers while driving. If you are reading an address book or business card, or writing a "to do" list while driving a car, you are not watching where you are going. It's common sense. Don't get caught in a dangerous situation because you are reading or writing and not paying attention to the road or nearby vehicles.
- 6 Dial sensibly and assess the traffic; if possible, place calls when you are not moving or before pulling into traffic. Try to plan your calls before you begin your trip or attempt to coincide your calls with times you may be stopped at a stop sign, red light or otherwise stationary. But if you need to dial while driving, follow this simple tip--dial only a few numbers, check the road and your mirrors, then continue.
- 7 Do not engage in stressful or emotional conversations that may be distracting. Stressful or emotional conversations and driving do not mix--they are distracting and even dangerous when you are behind the wheel of a car. Make people you are talking with aware you are driving and if necessary, suspend conversations which have the potential to divert your attention from the road.
- 8 Use your wireless phone to call for help. Your wireless phone is one of the greatest tools you can own to protect yourself and your family in dangerous situations--with your phone at your side, help is only three numbers away. Dial 9-1-1 or other local emergency number in the case of fire, traffic accident, road hazard or medical emergency. Remember, it is a free call on your wireless phone!
- 9 Use your wireless phone to help others in emergencies. Your wireless phone provides you a perfect opportunity to be a "Good Samaritan" in your community. If you see an auto accident, crime in progress or other serious emergency where lives are in danger, call 9-1-1 or other local emergency number, as you would want others to do for you.
- 10 Call roadside assistance or a special wireless non-emergency assistance number when necessary. Certain situations you encounter while driving may require attention, but are not urgent enough to merit a call for emergency services. But you still can use your wireless phone to lend a hand. If you see a broken-down vehicle posing no serious hazard, a broken traffic signal, a minor traffic accident where no one appears injured or a vehicle you know to be stolen, call roadside assistance or other special non-emergency wireless number.

Careless, distracted individuals and people driving irresponsibly represent a hazard to everyone on the road. Since 1984, the Cellular Telecommunications Industry Association and the wireless industry have conducted educational outreach to inform wireless phone users of their responsibilities as safe drivers and good citizens. As we approach a new century, more and more of us will take advantage of the benefits of wireless telephones. And, as we take to the roads, we all have a responsibility to drive safely.

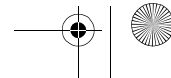
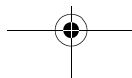
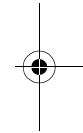
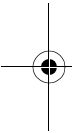



The wireless industry reminds you to use your phone safely when driving.

For more information, please call 1-888-901-SAFE.

For updates: <http://www.wow-com.com/consumer/issues/driving/articles.cfm?ID=85>

© 2001 Cellular Telecommunications & Internet Association. All Rights Reserved.
1250 Connecticut Avenue, NW Suite 800, Washington, DC 20036.
Phone: (202) 785-0081

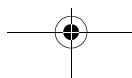
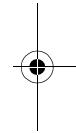
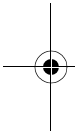



Appendix B

Message from the FDA (U.S. Food and Drug Administration) to all users of mobile phones.

July 18, 2001 For updates: <http://www.fda.gov/cdrh/phones>

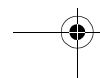
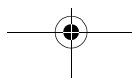
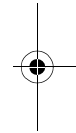
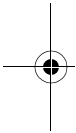



Consumer Update on Wireless Phones

U.S. Food and Drug Administration

1. Do wireless phones pose a health hazard?

The available scientific evidence does not show that any health problems are associated with using wireless phones. There is no proof, however, that wireless phones are absolutely safe. Wireless phones emit low levels of radiofrequency energy (RF) in the microwave range while being used. They also emit very low levels of RF when in the stand-by mode. Whereas high levels of RF can produce health effects (by heating tissue), exposure to low level RF that does not produce heating effects causes no known adverse health effects. Many studies of low level RF exposures have not found any biological effects. Some studies have suggested that some biological effects may occur, but such findings have not been confirmed by additional research. In some cases, other researchers have had difficulty in reproducing those studies, or in determining the reasons for inconsistent results.

2. What is FDA's role concerning the safety of wireless phones?

Under the law, FDA does not review the safety of radiation-emitting consumer products such as wireless phones before they can be sold, as it does with new drugs or medical devices. However, the agency has authority to take action if wireless phones are shown to emit radiofrequency energy (RF) at a level that is hazardous to the user. In such a case, FDA could require the manufacturers of wireless phones to notify users of the health hazard and to repair, replace or recall the phones so that the hazard no longer exists.

Although the existing scientific data do not justify FDA regulatory actions, FDA has urged the wireless phone industry to take a number of steps, including the following:

- Support needed research into possible biological effects of RF of the type emitted by wireless phones;
- Design wireless phones in a way that minimizes any RF exposure to the user that is not necessary for device function; and
- Cooperate in providing users of wireless phones with the best possible information on possible effects of wireless phone use on human health.

FDA belongs to an interagency working group of the federal agencies that have responsibility for different aspects of RF safety to ensure coordinated efforts at the federal level. The following agencies belong to this working group:

- National Institute for Occupational Safety and Health
- Environmental Protection Agency
- Federal Communications Commission
- Occupational Safety and Health Administration
- National Telecommunications and Information Administration

The National Institutes of Health participates in some interagency working group activities, as well.

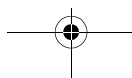
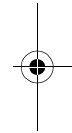
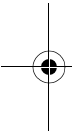



FDA shares regulatory responsibilities for wireless phones with the Federal Communications Commission (FCC). All phones that are sold in the United States must comply with FCC safety guidelines that limit RF exposure. FCC relies on FDA and other health agencies for safety questions about wireless phones. FCC also regulates the base stations that the wireless phone networks rely upon. While these base stations operate at higher power than do the wireless phones themselves, the RF exposures that people get from these base stations are typically thousands of times lower than those they can get from wireless phones. Base stations are thus not the subject of the safety questions discussed in this document.

3. What kinds of phones are the subject of this update?

The term wireless phone refers here to hand-held wireless phones with built-in antennas, often called cell mobile or PCS phones. These types of wireless phones can expose the user to measurable radiofrequency energy (RF) because of the short distance between the phone and the user's head. These RF exposures are limited by Federal Communications Commission safety guidelines that were developed with the advice of FDA and other federal health and safety agencies. When the phone is located at greater distances from the user, the exposure to RF is drastically lower because a person's RF exposure decreases rapidly with increasing distance from the source. The so-called cordless phones, which have a base unit connected to the telephone wiring in a house, typically operate at far lower power levels, and thus produce RF exposures far below the FCC safety limits.

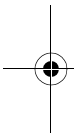

4. What are the results of the research done already?

The research done thus far has produced conflicting results, and many studies have suffered from flaws in their research methods. Animal experiments investigating the effects of radiofrequency energy (RF) exposures characteristic of wireless phones have yielded conflicting results that often cannot be repeated in other laboratories. A few animal studies, however, have suggested that low levels of RF could accelerate the development of cancer in laboratory animals. However, many of the studies that showed increased tumor development used animals that had been genetically engineered or treated with cancer-causing chemicals so as to be pre-disposed to develop cancer in the absence of RF exposure. Other studies exposed the animals to RF for up to 22 hours per day. These conditions are not similar to the conditions under which people use wireless phones, so we don't know with certainty what the results of such studies mean for human health.

Three large epidemiology studies have been published since December 2000. Between them, the studies investigated any possible association between the use of wireless phones and primary brain cancer, glioma, meningioma, or acoustic neuroma, tumors of the brain or salivary gland, leukemia, or other cancers. None of the studies demonstrated the existence of any harmful health effects from wireless phone RF exposures. However, none of the studies can answer questions about long-term exposures, since the average period of phone use in these studies was around three years.

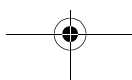



5. What research is needed to decide whether RF exposure from wireless phones poses a health risk?

A combination of laboratory studies and epidemiological studies of people actually using wireless phones would provide some of the data that are needed. Lifetime animal exposure studies could be completed in a few years. However, very large numbers of animals would be needed to provide reliable proof of a cancer promoting effect if one exists. Epidemiological studies can provide data that is directly applicable to human populations, but 10 or more years follow-up may be needed to provide answers about some health effects, such as cancer. This is because the interval between the time of exposure to a cancer-causing agent and the time tumors develop - if they do - may be many, many years. The interpretation of epidemiological studies is hampered by difficulties in measuring actual RF exposure during day-to-day use of wireless phones. Many factors affect this measurement, such as the angle at which the phone is held, or which model of phone is used.

6. What is FDA doing to find out more about the possible health effects of wireless phone RF?

FDA is working with the U.S. National Toxicology Program and with groups of investigators around the world to ensure that high priority animal studies are conducted to address important questions about the effects of exposure to radiofrequency energy (RF).

FDA has been a leading participant in the World Health Organization International Electromagnetic Fields (EMF) Project since its inception in 1996. An influential result of this work has been the development of a detailed agenda of research needs that has driven the establishment of new research programs around the world. The Project has also helped develop a series of public information documents on EMF issues.

FDA and the Cellular Telecommunications & Internet Association (CTIA) have a formal Cooperative Research and Development Agreement (CRADA) to do research on wireless phone safety. FDA provides the scientific oversight, obtaining input from experts in government, industry, and academic organizations. CTIA-funded research is conducted through contracts to independent investigators. The initial research will include both laboratory studies and studies of wireless phone users. The CRADA will also include a broad assessment of additional research needs in the context of the latest research developments around the world.

7. How can I find out how much radiofrequency energy exposure I can get by using my wireless phone?

All phones sold in the United States must comply with Federal Communications Commission (FCC) guidelines that limit radiofrequency energy (RF) exposures. FCC established these guidelines in consultation with FDA and the other federal health and safety agencies. The FCC limit for RF exposure from wireless telephones is set at a Specific Absorption Rate (SAR) of 1.6 watts per kilogram (1.6 W/kg). The FCC limit is consistent with the safety standards developed by the Institute of Electrical and Electronic Engineering (IEEE) and the National Council on Radiation Protection and Measurement. The exposure limit takes into consideration the body's ability to remove heat from the tissues that absorb energy from the wireless phone and is set well below levels known to have effects.

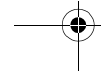
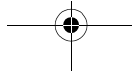
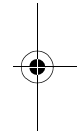
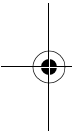



Manufacturers of wireless phones must report the RF exposure level for each model of phone to the FCC. The FCC website (<http://www.fcc.gov/oet/rfsafety>) gives directions for locating the FCC identification number on your phone so you can find your phone's RF exposure level in the online listing.

8. What has FDA done to measure the radiofrequency energy coming from wireless phones?

The Institute of Electrical and Electronic Engineers (IEEE) is developing a technical standard for measuring the radiofrequency energy (RF) exposure from wireless phones and other wireless handsets with the participation and leadership of FDA scientists and engineers. The standard, Recommended Practice for Determining the Spatial-Peak Specific Absorption Rate (SAR) in the Human Body Due to Wireless Communications Devices: Experimental Techniques, sets forth the first consistent test methodology for measuring the rate at which RF is deposited in the heads of wireless phone users. The test method uses a tissue-simulating model of the human head. Standardized SAR test methodology is expected to greatly improve the consistency of measurements made at different laboratories on the same phone. SAR is the measurement of the amount of energy absorbed in tissue, either by the whole body or a small part of the body. It is measured in watts/kg (or milliwatts/g) of matter. This measurement is used to determine whether a wireless phone complies with safety guidelines.

9. What steps can I take to reduce my exposure to radiofrequency energy from my wireless phone?

If there is a risk from these products--and at this point we do not know that there is--it is probably very small. But if you are concerned about avoiding even potential risks, you can take a few simple steps to minimize your exposure to radiofrequency energy (RF). Since time is a key factor in how much exposure a person receives, reducing the amount of time spent using a wireless phone will reduce RF exposure.

If you must conduct extended conversations by wireless phone every day, you could place more distance between your body and the source of the RF, since the exposure level drops off dramatically with distance. For example, you could use a headset and carry the wireless phone away from your body or use a wireless phone connected to a remote antenna.

Again, the scientific data do not demonstrate that wireless phones are harmful. But if you are concerned about the RF exposure from these products, you can use measures like those described above to reduce your RF exposure from wireless phone use.

10. What about children using wireless phones?

The scientific evidence does not show a danger to users of wireless phones, including children and teenagers. If you want to take steps to lower exposure to radiofrequency energy (RF), the measures described above would apply to children and teenagers using wireless phones. Reducing the time of wireless phone use and increasing the distance between the user and the RF source will reduce RF exposure. Some groups sponsored by other national governments have advised that children be discouraged

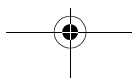
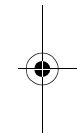
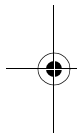



from using wireless phones at all. For example, the government in the United Kingdom distributed leaflets containing such a recommendation in December 2000. They noted that no evidence exists that using a wireless phone causes brain tumors or other ill effects. Their recommendation to limit wireless phone use by children was strictly precautionary; it was not based on scientific evidence that any health hazard exists.

11. What about wireless phone interference with medical equipment?

Radiofrequency energy (RF) from wireless phones can interact with some electronic devices. For this reason, FDA helped develop a detailed test method to measure electromagnetic interference (EMI) of implanted cardiac pacemakers and defibrillators from wireless telephones. This test method is now part of a standard sponsored by the Association for the Advancement of Medical Instrumentation (AAMI). The final draft, a joint effort by FDA, medical device manufacturers, and many other groups, was completed in late 2000. This standard will allow manufacturers to ensure that cardiac pacemakers and defibrillators are safe from wireless phone EMI. FDA has tested hearing aids for interference from handheld wireless phones and helped develop a voluntary standard sponsored by the Institute of Electrical and Electronic Engineers (IEEE). This standard specifies test methods and performance requirements for hearing aids and wireless phones so that no interference occurs when a person uses a compatible phone and a accompanied hearing aid at the same time. This standard was approved by the IEEE in 2000.

FDA continues to monitor the use of wireless phones for possible interactions with other medical devices. Should harmful interference be found to occur, FDA will conduct testing to assess the interference and work to resolve the problem.

12. Where can I find additional information?

For additional information, please refer to the following resources:

- FDA web page on wireless phones
<http://www.fda.gov/cdrh/phones/index.html>
- Federal Communications Commission (FCC) RF Safety Program
<http://www.fcc.gov/oet/rfsafety>
- International Commission on Non-Ionizing Radiation Protection
<http://www.icnirp.de>
- World Health Organization (WHO) International EMF Project
<http://www.who.int/emf>
- National Radiological Protection Board (UK)
<http://www.nrp.org.uk/>

July 18, 2001 For updates: <http://www.fda.gov/cdrh/phones>

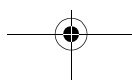

Index

A

accessibility

- loopset 21
- web site 21

accessories

- boom headset (HDB-5) 99
- car kit (PPH-1) 101
- carry case (CSM-6) 102
- charger (ACP-12) 97
- charger (ACP-7) 97
- charger (ACP-8) 97
- charger (LCH-9) 98
- headset (HDC-5) 98
- headset (HDE-2) 99
- mobile holder (MBC-6) 100
- reference information 96
- safety information 94
- settings 56
- spare battery charger (DDC-1) 98

accessory

- TTY adapter 100

active call options 60

alarm clock 75

- phone off 75
- set 75
- snooze 75
- turn off 75

analog selection 71

antenna

- contact 16
- location 16
- performance 16
- proper position 16

automatic redial 66

B

back cover

- attaching 17
- removing 17

battery

- charging 18
- charging time 95
- important information 18
- initial charging 18
- install 16
- prolong life 19
- reference information 94
- remove 17
- standby time 95
- talk time 95

business cards 77

- delete 78
- receive 77
- save 77
- send 77

C

calculator 76

call duration

- viewing 43

call forwarding 63

- activate 64
- feature codes 63

call log

- about 41
- clear lists 42
- dialed calls 42
- missed calls 42
- options 41
- received calls 42

call timers 43
clear timers 43
current call timer 43

call waiting 64
activate 64
answer 65
feature code 64
manage calls 65
storing the feature code 64

calls
answer 24
automatic redial 66
conference 61
duration of 43
end 24
forward 63
make 23
redial last 24
silence 24
speed dialing 67
touch tones 67

car charger 98

car kit 101
automatic answer 57
default profile 57
set the lights 57

carry case 102

change
1-touch dialing numbers 67
contact list view 40
earpiece volume 24
letter case 33
message alert tone 55
profile name 56
ringing tone 54
ringing volume 55
security code 73
time format 58

charge the battery 18

charger
ACP-12 97
ACP-7U 97
ACP-8U 97
connecting 18
information 94

clear call lists 42

clock 58
alarm 75
automatic update 58
set the time 58
show/hide 59
time format 58

color covers 103

conference calls 61

contact list
delete entries 39
enter e-mail addresses 38
memory status 40
menu 31
menu options 31
new entry 38
quick access 24
scrolling view 40

contact Nokia 20

cover
attaching 17
removing 17

currency conversion 76

customer care 20

D

delete
call lists 42
contact list entries 39
messages from folders 47
text messages 49

dialed calls

- deleting 42
- viewing 42

digital selection 71

display language 58

download

- ringing tones 78

E

e-mail messages 51

emergency calls

- making 91
- things to remember 91
- with keypad locked 72

entering

- e-mail addresses 38
- names and numbers 37
- text 32

F

folders

- about 47
- archive 47
- delete messages from 47
- inbox 47
- outbox 47

four-way scrolling 34

G

games 82

- Pairs II 83
- Snake II 83
- Space Impact 83

H

headset

- connect 19
- HDB-5 99
- HDC-5 98

HDE-2 99

- make and answer calls 19

hearing impaired solutions 21

help text 26

I

icons 26

illustrated view

- antenna 16
- battery install 16
- battery removal 17
- connect the charger 18
- headset connection 19
- phone 16
- power key 23

in-call options 60

in-phone help 26

K

Keypad 72

keypad

- illustrated view 16

L

label 20

language setting 58

letters

- uppercase and lowercase 33

lithium ion battery 96

lock/unlock the keypad 72

loopset 21

- how it works 21
- set for use 57

M

memory

- contact list 40
- text message 49

menu shortcuts

- about 27
- list of 28

menu tips 27

menus 27

messages

- alert tone 55
- check voice mail 44
- e-mail 51
- picture 50
- read 48
- text 48
- text entry 32
- write and send 48

Minute Manager 84

missed calls

- deleting 42
- viewing 42

mobile holder 100

N

network search 70

network services 15

Nokia

- accessories 96
- customer care center 20
- warranty 106

O

one-touch dialing 67

P

personalization 53

phone

- illustrated 10
- menus 27
- register 15
- switch on/off 23
- warranty 106

picture messages 50

power 23

predictive text 35

- turn off 35
- turn on 35

prepaid 79

- add money to account 80
- check balance 79
- saving access numbers 80

profiles

- accessory settings 56
- customize 54
- selecting 53

punctuation 34

R

received calls

- deleting 42
- viewing 42

reference information 87

ringing

- options 54
- tone 54
- volume 55

ringing tones

- change 54
- download 78
- receiving 78
- save 78

S

save

- e-mail addresses 38
- names and numbers 37
- ringing tones 78
- text messages 47
- voice mailbox number 44



search for network 70
security code 73
service provider
 signing up 15
special characters
 available 34
 four-way scrolling 34
standby time 95
start screen 25
strings, touch tone 69
symbols 34

T
talk time 95
text clues 12
text messages 48
 length 45
 recipients 45
time 58
 automatic update 58
 select the format 58
 set the clock 58
timers
 check 43
 clear 43
 current call 43
touch tones
 length 68
 manual 68
 sending 69
 setting 67
 storing 69
 storing with numbers 69
troubleshooting 105
TTY 21
TTY adapter 100
TTY communication 100

turn the phone on/off 23

U
unlock the keypad 72
user guide
 updates 12
user guide conventions 12

V
vibrating alert 55
view
 call duration 43
 clock on start screen 59
 dialed calls 42
 missed calls 42
 picture messages 51
 received calls 42
 received messages 48
 special characters 34
voice mail 44
 listen to messages 45
 messages 44
 save number 44
volume
 earpiece 24
 keypad tones 56
 ringing 55

W
warning tones 56
warranty 106
web sites
 accessibility information 21
 register your phone 15
write and send a message 48

X
Xpress-on color covers 103

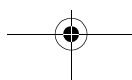

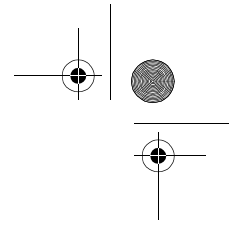
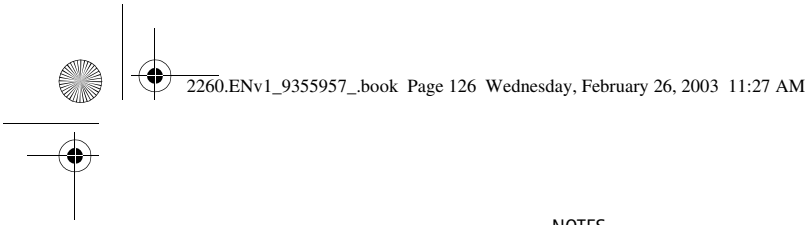

NOTES

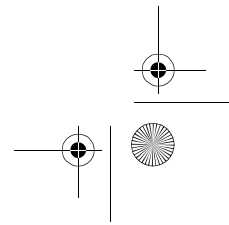
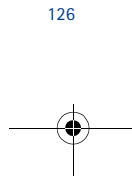
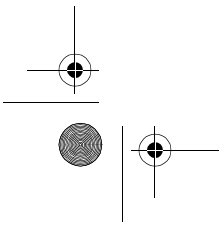
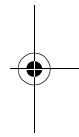
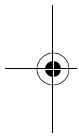

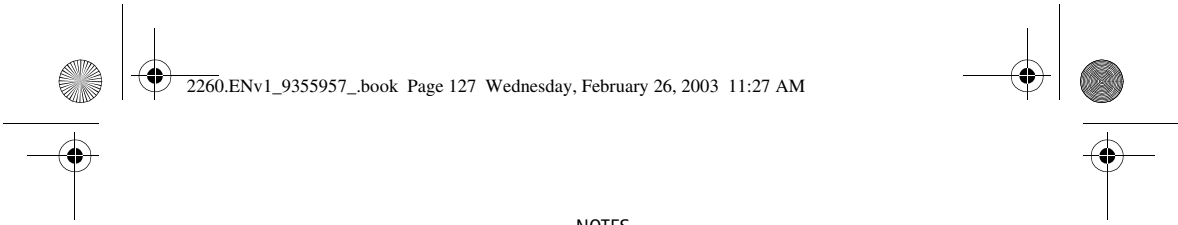

NOTES

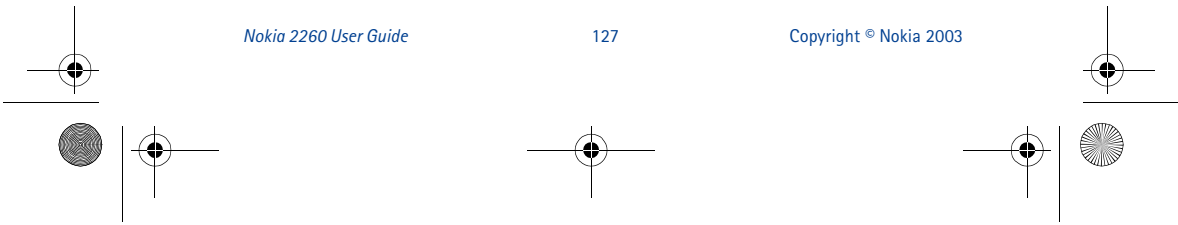
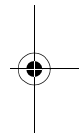
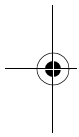



NOTES

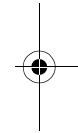
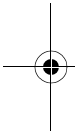

Para obtener un manual del usuario en español favor de
llamar o enviar un fax al teléfono 1-888-NOKIA-2U,
fax 813-249-9619.

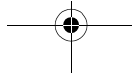

Free Manuals Download Website

<http://myh66.com>

<http://usermanuals.us>

<http://www.somanuals.com>

<http://www.4manuals.cc>

<http://www.manual-lib.com>

<http://www.404manual.com>

<http://www.luxmanual.com>

<http://aubethermostatmanual.com>

Golf course search by state

<http://golfingnear.com>

Email search by domain

<http://emailbydomain.com>

Auto manuals search

<http://auto.somanuals.com>

TV manuals search

<http://tv.somanuals.com>