

Digital Palmcorder®
PalmSight™

Panasonic®

Digital Video Camcorder
Operating Instructions
Model No. **PV-DV600**

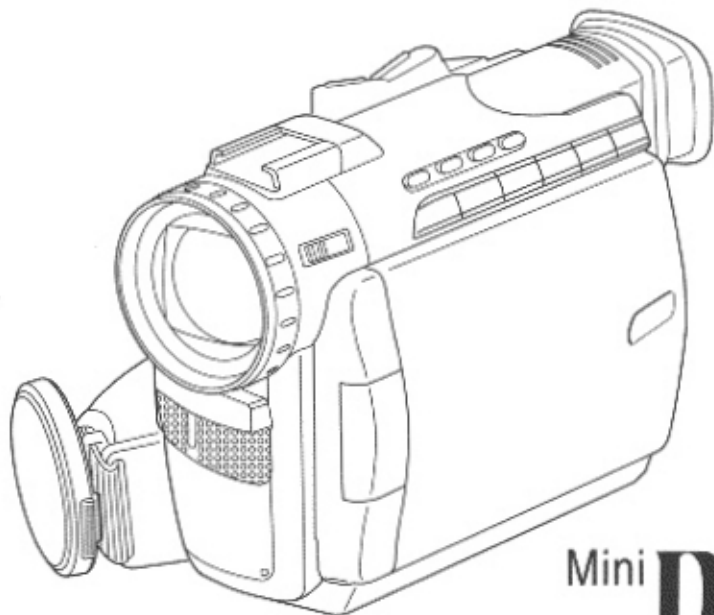

Mini **DV**



Before attempting to connect, operate or adjust this product, please read these instructions thoroughly.

Spanish Quick Use Guide is included.

Guía para rápida consulta en español está incluida.

For assistance, call 1-800-211-PANA(7262)

Things You Should Know

Thank you for choosing Panasonic!

You have purchased one of the most sophisticated and reliable products on the market today. Used properly, we're sure it will bring you and your family years of enjoyment. Please take time to fill in the information below. The serial number is on the tag located on the underside of your Palmcorder. Be sure to **retain this manual** as your convenient Palmcorder information source.

Date of Purchase

Dealer Purchased From

Dealer Address

Dealer Phone No.

Model No.

Serial No.

Unpack your Camcorder

1 pc. AC Adaptor (PV-DAC10)
with AC Cable and DC Cable

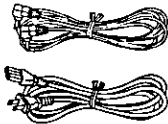
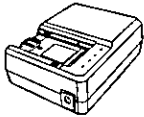

1 pc. Battery Pack
(PV-DBP8 or PV-DBP8A)



1 pc. A/V Cable
(LSJA0280)

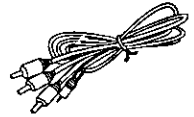

1 pc. Lens Cap
(LSYF0395)



1 pc. Color
Enhancement Light
(VYKW3130) with
Light Holder



1 pc. PC
Connection Cable
for Windows
(LSJA0276)

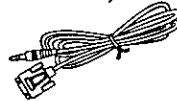

1 pc. CD-ROM of
Driver for Adobe
PhotoDeluxe
(VFTW0014)



1 pc. PHOTOVU
LINK DRIVER &
CARD LINK DRIVER
(LSFT0196)

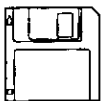

1 pc. MultiMediaCard
(LSFT0198)



1 pc. Shoulder
Strap (LSFC0013)



Microsoft and Windows are registered trademarks of Microsoft in the United States and other countries.

Adobe, the Adobe logo & PhotoDeluxe are trademarks of Adobe Systems Inc.





Things You Should Know

Safety Precautions

**WARNING: TO PREVENT FIRE OR SHOCK HAZARD,
DO NOT EXPOSE THIS EQUIPMENT TO RAIN OR MOISTURE.**

Your ^{Mini} **DX** Palmcorder is designed to record and play back in Standard Play (SP) mode and Long (LP) mode.

It is recommended that only cassette tapes that have been tested and inspected for use in VCR machines with the ^{Mini} **DX** mark be used.

	CAUTION RISK OF ELECTRIC SHOCK DO NOT OPEN			This symbol warns the user that uninsulated voltage within the unit may have sufficient magnitude to cause electric shock. Therefore, it is dangerous to make any kind of contact with any inside part of this unit.
CAUTION: TO REDUCE THE RISK OF ELECTRIC SHOCK, DO NOT REMOVE COVER (OR BACK) NO USER-SERVICEABLE PARTS INSIDE REFER SERVICING TO QUALIFIED SERVICE PERSONNEL				This symbol alerts the user that important literature concerning the operation and maintenance of this unit has been included. Therefore, it should be read carefully in order to avoid any problems.

The above markings are located on the appliance bottom cover.

This device complies with Part 15 of the FCC Rules. Operation is subject to the following two conditions: (1) This device may not cause harmful interference, and (2) this device must accept any interference received, including interference that may cause undesired operation.

Note: This equipment has been tested and found to comply with Part 15 of the FCC Rules. These limits are designed to provide reasonable protection against harmful interference when operated in a residential environment.

If this equipment does cause interference to radio or television reception, which can be determined by turning the equipment off and on, use the equipment in another location and/or utilize an electrical outlet different from that used by the receiver.

If necessary, consult the dealer or an experienced radio/TV technician for help. You may find the booklet, 'Something About Interference' available from FCC local regional offices helpful.

FCC Warning: To assure continued FCC compliance, use only the provided shielded interface cable when connecting digital video camera to computer in accordance with instruction herein. Also, any unauthorized changes or modifications to this equipment could void the user's authority to operate.

Important Safeguards

1. **Read Instructions** — All the safety and operating instructions should be read before the unit is operated.
2. **Retain Instructions** — The safety and operating instructions should be retained for future reference.
3. **Heed Warnings** — All warnings on the unit and in the operating instructions should be adhered to.
4. **Follow Instructions** — All operating and maintenance instructions should be followed.
5. **Cleaning** — Unplug this video unit from the wall outlet before cleaning. Do not use liquid or aerosol cleaners. Use a dry cloth for cleaning.
6. **Attachments** — Do not use attachments not recommended by the video product manufacturer as they may be hazardous.
7. **Water and Moisture** — Do not use this video unit near water — for example near a bath tub, wash bowl, kitchen sink, or laundry tub, in a wet basement, or near a swimming pool, and the like.
8. **Accessories** — Do not place this video unit on an unstable cart, stand, tripod, bracket, or table. The video unit may fall, causing serious injury to a child or adult, and serious damage to the unit. Use only with a cart, stand, tripod, bracket, or table recommended by the manufacturer, or sold with the video unit. Any mounting of the unit should follow the manufacturer's instructions and should use a mounting accessory recommended by the manufacturer. An appliance and cart combination should be moved with care. Quick stops, excessive force, and uneven surfaces may cause the appliance and cart combination to overturn.
9. **Ventilation** — Slots and openings in the cabinet are provided for ventilation and to ensure reliable operation of the video unit and to protect it from overheating. These openings must not be blocked or covered. Never place the video unit on a bed, sofa, rug, or other similar surface, or near or over a radiator or heat register. This video unit should not be placed in a built-in installation such as a bookcase or rack unless proper ventilation is provided or the manufacturer's instructions have been adhered to.



10. **Power Sources** — This video unit should be operated only from the type of power source indicated on the marking label. If you are not sure of the type of power supply to your home, consult your appliance dealer or local power company. For video units intended to be operated from battery power, or other sources, refer to the operating instructions.

11. **Grounding or Polarization** — This video unit may be equipped with either a polarized 2-wire AC (Alternating Current) line plug (a plug having one blade wider than the other) or 3-wire grounding type plug, a plug having a third (grounding) pin.
The 2-wire polarized plug will fit into the power outlet only one way. This is a safety feature. If you are unable to insert the plug fully into the outlet, try reversing the plug. If the plug still fails to fit, contact your electrician to replace your obsolete outlet. Do not defeat the safety purpose of the polarized plug.
The 3-wire grounding type plug will fit into a grounding type power outlet. This is a safety feature. If you are unable to insert the plug into the outlet, contact your electrician to replace your obsolete outlet. Do not defeat the safety purpose of the grounding type plug.
12. **Power-Cord Protection** — Power-supply cords should be routed so that they are not likely to be walked on or pinched by items placed upon or against them, paying particular attention to cords of plugs, convenience receptacles, and the point where they exit from the unit.
13. **Outdoor Antenna Grounding** — If an outside antenna or cable system is connected to the video unit, be sure the antenna or cable system is grounded so as to provide some protection against voltage surges and built-up static charges. Part 1 of the Canadian Electrical Code, in USA Section 810 of the National Electrical Code, provides information with respect to proper grounding of the mast and supporting structure, grounding of the lead-in wire to an antenna discharge unit, size of grounding conductors, location of antenna discharge unit, connection to grounding electrodes, and requirements for the grounding electrode.

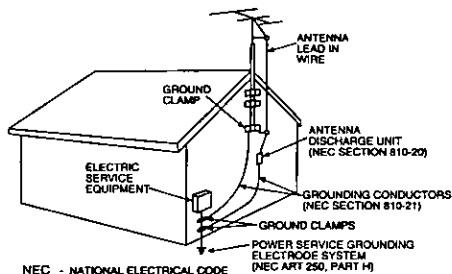

14. **Lightning** — For added protection of this video unit receiver during a lightning storm, or when it is left unattended and unused for long periods of time, unplug it from the wall outlet and disconnect the antenna or cable system. This will prevent damage to the video unit due to lightning and power-line surges.

Important Safeguards

15. **Power Lines** — An outside antenna system should not be located in the vicinity of overhead power lines or other electric light or power circuits, or where it can fall into such power lines or circuits. When installing an outside antenna system, extreme care should be taken to keep from touching such power lines or circuits as contact with them might be fatal.
16. **Overloading** — Do not overload wall outlets and extension cords as this can result in a risk of fire or electric shock.
17. **Objects and Liquids** — Never push objects of any kind into this video unit through openings as they may touch dangerous voltage points or short out parts that could result in a fire or electric shock. Never spill liquid of any kind onto the video unit.
18. **Servicing** — Do not attempt to service this video unit yourself as opening or removing covers may expose you to dangerous voltage or other hazards. Refer all servicing to qualified service personnel.
19. **Damage Requiring Service** — Unplug this video unit from the wall outlet and refer servicing to qualified service personnel under the following conditions:
 - a. When the power-supply cord or plug is damaged.
 - b. If any liquid has been spilled onto, or objects have fallen into the video unit.
 - c. If the video unit has been exposed to rain or water.
 - d. If the video unit does not operate normally by following the operating instructions. Adjust only those controls that are covered by the operating instructions, as an improper adjustment of other controls may result in damage and will often require extensive work by a qualified technician to restore the video unit to its normal operation.
 - e. If the video unit has been dropped or the cabinet has been damaged.
 - f. When the video unit exhibits a distinct change in performance — this indicates a need for service.
20. **Replacement Parts** — When replacement parts are required, be sure the service technician has used replacement parts specified by the manufacturer or have the same characteristics as the original part. Unauthorized substitutions may result in fire, electric shock or other hazards.
21. **Safety Check**— Upon completion of any service or repairs to this video unit, ask the service technician to perform safety checks to determine that the video unit is in safe operating order.

Precautions

USE & LOCATION

- **TO AVOID SHOCK HAZARD ...** Your Camcorder and power supply should not be exposed to rain or moisture. Do not connect the power supply or operate your Camcorder if it gets wet. Your Camcorder has been designed for outdoor use, however it is not designed to sustain direct exposure to water, rain, sleet, snow, sand, dust, or a direct splashing from a pool or even a cup of coffee. This action could permanently damage the internal parts of your Camcorder. Do not attempt to disassemble this unit. There are no user serviceable parts inside. Unplug your Camcorder from the power supply before cleaning.
- **DO NOT AIM YOUR CAMCORDER AT THE SUN OR OTHER BRIGHT OBJECTS**
- **DO NOT LEAVE THE PALMCORDER WITH THE EVF AIMED DIRECTLY AT THE SUN AS THIS MAY CAUSE DAMAGE TO THE INTERNAL PARTS OF THE EVF**
- **DO NOT EXPOSE YOUR CAMCORDER TO EXTENDED HIGH TEMPERATURE ...** Such as, in direct sunlight, inside a closed car, next to a heater, etc... This action could permanently damage the internal parts of your Camcorder.
- **AVOID SUDDEN CHANGES IN TEMPERATURE ...** If the unit is suddenly moved from a cold place to a warm place, moisture may form on the tape and inside the unit.
- **DO NOT LEAVE YOUR CAMCORDER OR THE POWER SUPPLY TURNED ON WHEN NOT IN USE.**
- **STORAGE OF YOUR CAMCORDER ...** Store and handle your Camcorder in a manner that will not subject it to unnecessary movement (avoid shaking and striking). Your Camcorder contains a sensitive pick-up device which could be damaged by improper handling or storage.

CARE

- **TO CLEAN YOUR CAMCORDER ...** Do not use strong or abrasive detergents when cleaning your Camcorder body.
- **TO PROTECT THE LENS ...** Do not touch the surface of the lens with your hand. Use a commercial camcorder lens solution and lens paper when cleaning the lens. Improper cleaning can scratch the lens coating.
- **TO PROTECT THE FINISH OF YOUR CAMCORDER ...** Before handling your Camcorder, make sure your hands and face are free from any chemical products, such as suntan lotion, as it may damage the finish.

Table of Contents

Getting Started

Things You Should Know	2
Important Safeguards	4
Precautions	5
Quick Guide	8
Supplying Power	11
Cassette Information	14
Color Enhancement Light	16
Attaching the Shoulder Strap	17
Setting the Clock	19
Using the Palmcorder Menu	20
MENU OSD	21
Electronic Viewfinder/LCD Monitor Indications	26

Basic Operation

Camera Recording	30
Remote Control (Optional)	34
Playback Your Recordings	35

Special Features

Card PhotoShot	41
Recording images From a Tape	42
Playback Still Images	43
Delete Specific Image Pages	45
Delete All Image Pages	46
Format the MultiMediaCard	47
Photo Title	48
Dual Digital Electronic Image Stabilization System (D.E.I.S.)	50
Zoom	51
Digital PhotoShot	52
Index Search	52
White Balance	53
Recording Still Pictures	53
IR FILTER	53
Program AE	54
Digital Functions	55
Focus	56
Audio/Video Fade In/Out	57
Backlight	57
High Speed Shutter	58
Audio Dubbing using the External or Built-in Microphone	59
Memory-Stop Editing	60
Copying your Tapes to S-VHS or VHS Cassette	61
Copying S-VHS or VHS Cassette to your Tapes	62
Copying from Digital Equipment (dubbing)	63
PC Connection with DV Interface Cable (IEEE 1394)	64
PC Connection	65
Software Installation (Windows 95/98)	66
CARD LINK	67
PHOTOVU LINK	70
Adobe® PhotoDeluxe™ HE 3.0	72
Printer Connection	73

Table of Contents

For Your Information

Palmcorder Accessory System	74
Palmcorder Accessory Order Form	75
Notes On Operations	76
Specifications	78
Before Requesting Service	79
Request for Service Notice	80
Index of Controls	81
Warranty	86
Spanish Quick Use Guide/Guía Para Uso Rápido	88
Index	91

Quick Guide

Insert the Battery

Before you begin...

- Charge the Battery (page 11).

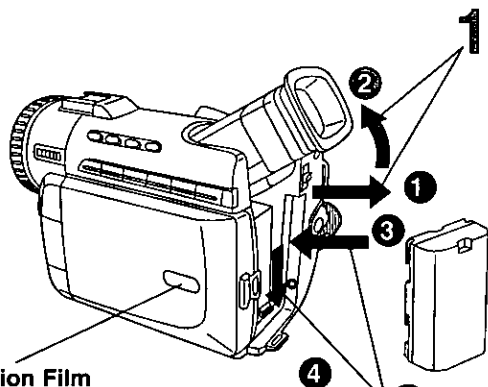

1 Slide the Viewfinder backward to its fully expanded position and then tilt it upward.

Protection Film Note

- Remove the Protection Film before use.

2 Insert the Battery and slide it down until it locks with a click.

Insert Cassette

1 Set **POWER Switch** to **VCR** or **CAMERA**.

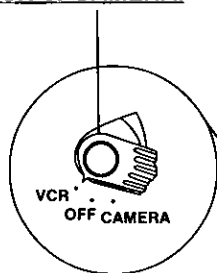

2 Slide **TAPE EJECT Switch** to open the Cassette Compartment Cover.

3 Insert a cassette with its window side facing up.
• Make sure the record tab is closed (page 15).

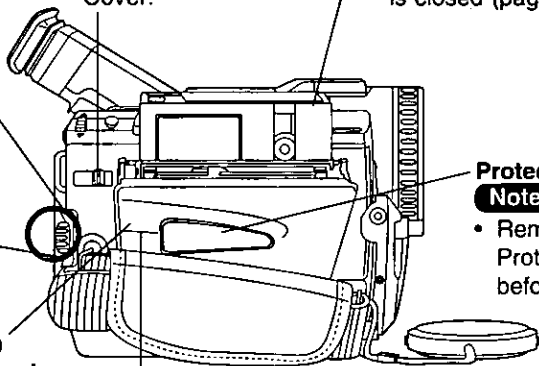

Protection Film Note

- Remove the Protection Film before use.

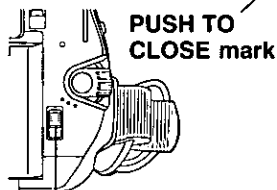

4 Press **PUSH TO CLOSE** mark to close the Cassette Compartment Cover.

TAPE
M-CARD
↑ When using a Tape, you must set **TAPE/M-CARD Switch** to TAPE.

Camera Recording

When the LCD monitor is fully open, the Viewfinder automatically turns OFF.

Protection Film

Note

- Remove the Protection Film before use.

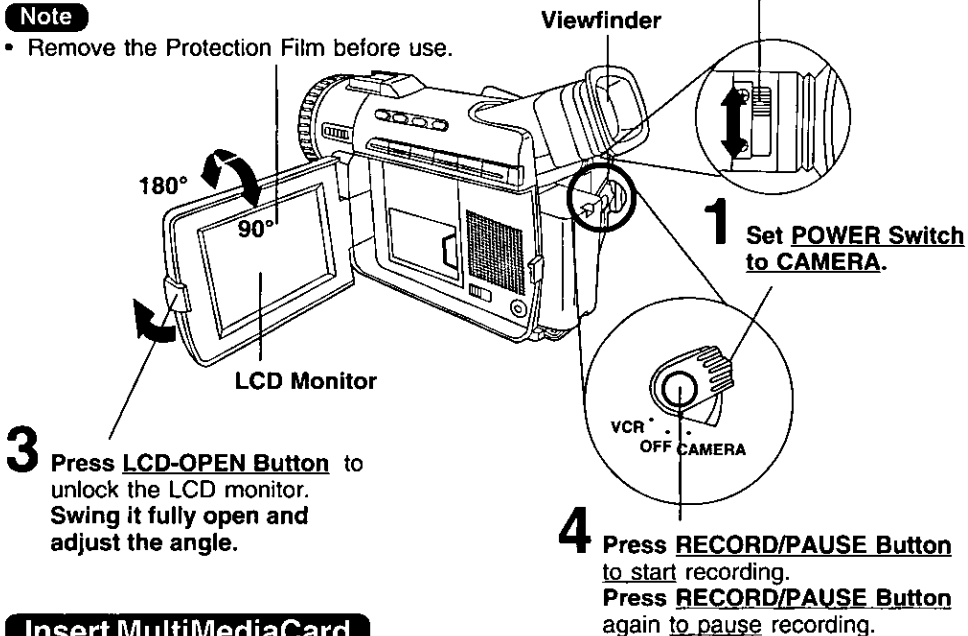

Insert MultiMediaCard

Be sure to insert the MultiMediaCard before using the Card PhotoShot (page 41).

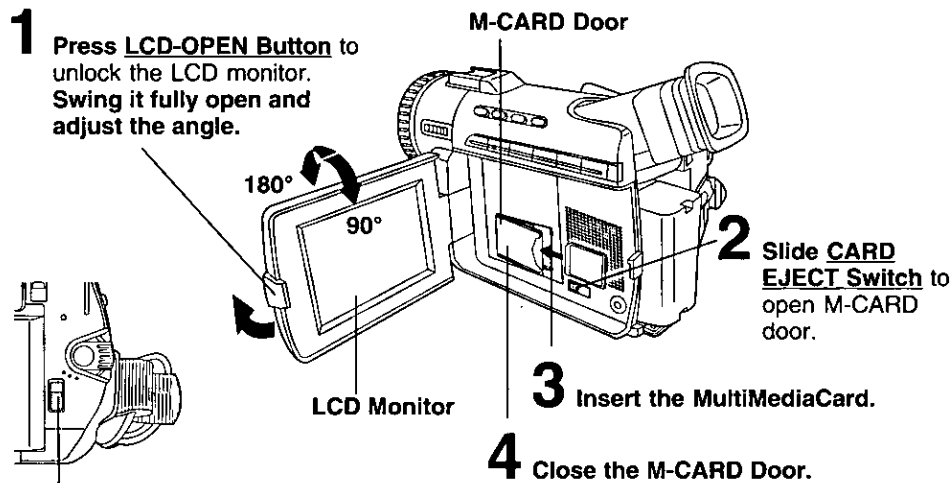

When using a MultiMediaCard, you must set **TAPE/M-CARD Switch** to **M-CARD**.

Quick Guide

To Watch Playback in the LCD (Liquid Crystal Display)

Before you begin...

- Charge the Battery (page 11).

When the LCD monitor is fully open, the Viewfinder automatically turns OFF.

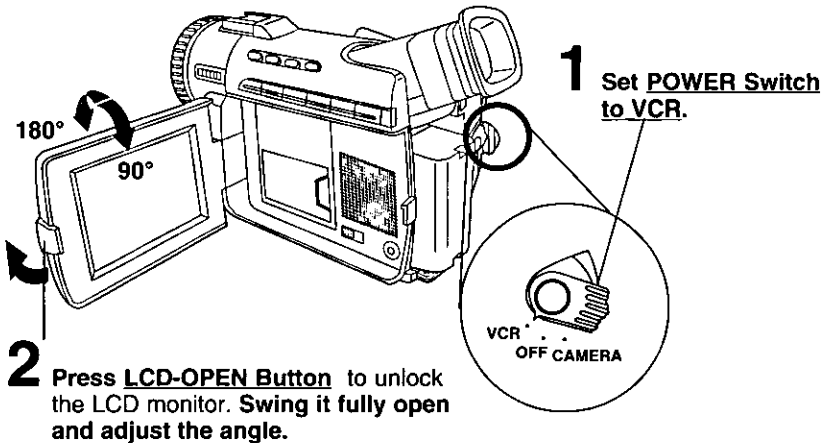

3 Press **REW Button** to rewind the tape.

4 Press **PLAY Button** to start playback.

5 Press **STOP Button** to stop playback.

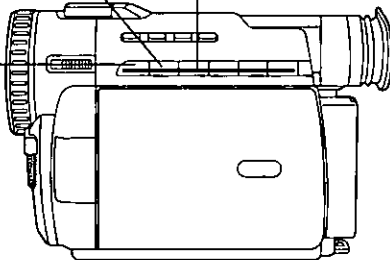

Charge the Battery Pack on the AC Adaptor

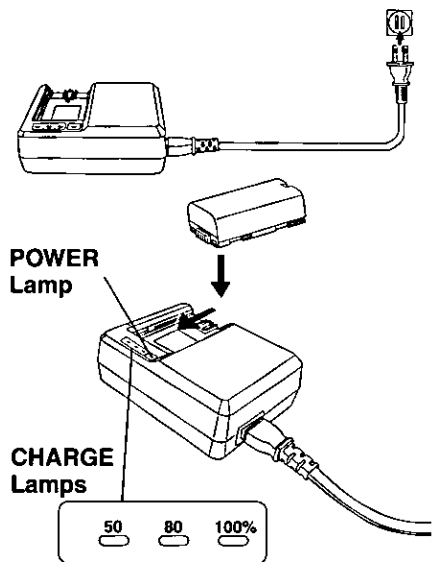

1 Connect and plug in the Cable as shown.
• POWER Lamp will light.

2 Attach the battery as shown to charge.
• Charge lamps on the AC Adaptor will flash and then turn solid red to indicate current charge level. When all 3 lamps are constantly on, the battery is fully charged. (approx. 1 hour) Expect approx. 1 hour 15 minutes of operation when fully charged (EVF usage).

3 Remove the Battery.
Slide the Battery out and then lift up.

Charge Lamps

- The three Charge Lamps "50%", "80%" and "100%" flash and then remain lit one after another to indicate how much the Battery has been charged. When all three lamps are lit, charging is finished.
- The Charge Lamps give a good approximate indication of the charging condition under normal ambient temperature. However, when charging at high or low temperature, the charge lamps may differ considerably from the actual charging condition.

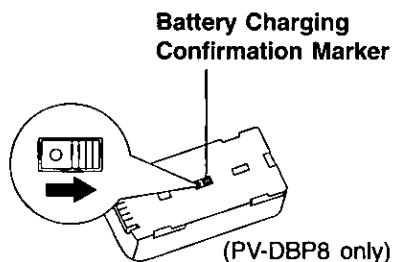

Battery Charging Confirmation Marker

Use this marker as a reminder to yourself when the battery is fully charged or in need of a charge. This marker performs no function and is for your reference only.

- The Battery is no longer serviceable if the operation time is very short, even after a sufficient charge.

Note

- PV-DBP8A has no marker.

Supplying Power

Insert/Remove the Battery Pack

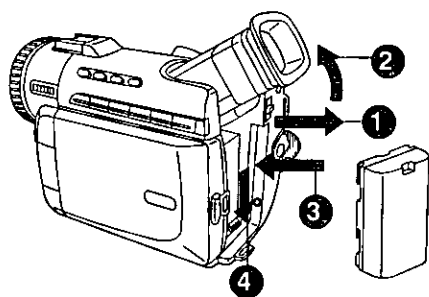

- 1** Slide the Viewfinder backward to its fully extended position and then tilt it upward.
- 2** Insert the Battery and slide it down until it locks with a click.

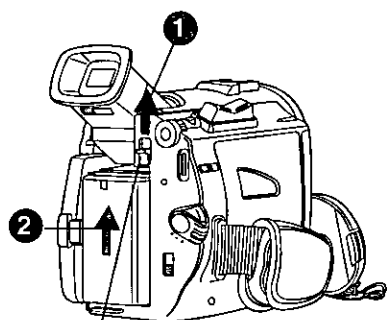

BATTERY RELEASE Switch

To remove the Battery:

Slide the Battery upward while sliding the **BATTERY RELEASE**.

Battery Care

Caution:

- Charge only with specified charger.
- The Battery can be charged within a temperature range of 32° F (0° C) and 104° F (40° C).
- The Battery may be warm after charging or just after use. This is normal.
- Do not use an insufficiently charged or worn out Battery.
- In extreme cold surroundings, Battery charging time will increase.

Safety precautions:

- Do not get the Battery near, or dispose of in fire.
- Do not directly connect (short circuit) the positive (+) and negative (-) terminals.
- Never attempt to disassemble or reassemble the Battery.

To avoid damage to the Battery:

- Do not drop or jar the Battery.
- Use the Battery with specified models only.
- If the Battery is used in extremely high temperatures, a safety device will automatically prevent operation.

To insure longer battery life:

- While not in use, remove Battery from the Palmcorder and AC Adaptor and store in a cool, dark, dry place. If you leave the Battery in the Palmcorder or on AC Adaptor, the Battery will no longer be rechargeable.
- Keep the Battery terminals clean.

AC Adaptor

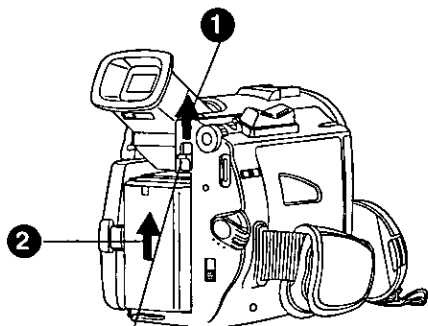

BATTERY RELEASE Switch

- 1 Slide the Battery upward while sliding the **BATTERY RELEASE** to remove the Battery (page 12).

- 2 Insert the DC Cable into the DC IN Terminal.

- 3 Connect the other end of the DC Cable to the AC Adaptor as shown.

- 4 Plug in the AC Adaptor.
 - The POWER Lamp of the AC Adaptor lights up.

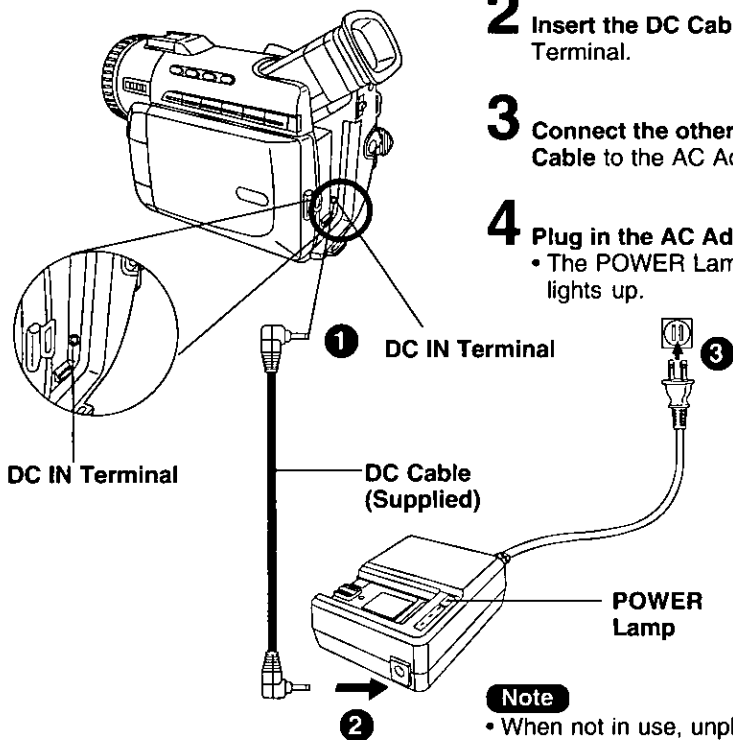

Note

- When not in use, unplug the AC Adaptor from the AC outlet. (AC Adaptor consumes 1W of electric power when plugged into an AC outlet even when not in use.)

Cassette Information

Cassette Insertion

Before you begin...

- Connect the Palmcorder to a power source (pages 12, 13).

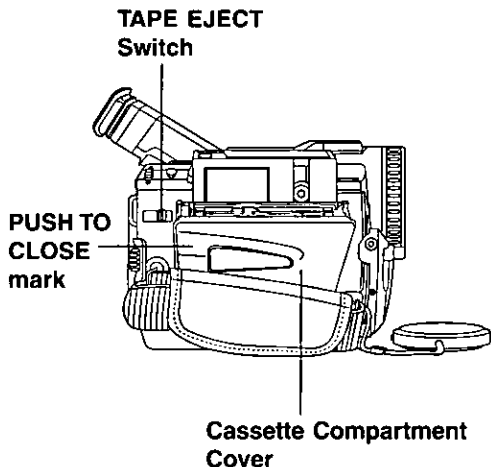

- 1** Slide **TAPE EJECT** to open the Cassette Compartment Cover.
- 2** Insert a cassette with its window side facing up.
- 3** Press **PUSH TO CLOSE** mark to close the Cassette Compartment Cover.

Cassette Ejection

- If the Palmcorder is connected to a power source, the cassette can be inserted and ejected without turning the Palmcorder on.

- 1** Slide **TAPE EJECT** to open the Cassette Compartment Cover.
- 2** Pull the cassette tape straight out.

Hint for recording position when inserting Cassette

- When you insert a cassette that is partially recorded, use the Edit Search Function to search for the position from which you want to record again. Especially when you want to record again on a cassette that is already fully recorded, be sure to first locate the position where you want to add the new recording, before starting to record.

Note:

- If hand strap is tight it may prevent Cassette Compartment Cover from fully opening for tape insert or eject. Loosen hand strap if necessary.
- When inserting the cassette, make sure it faces in the right direction and then push in completely.

Record Speed/Playback Time

Use only those tapes having the ^{Mini} DV logo indicating the 6.35mm digital standard.

Cassette type	Record Speed/Playback time	
	SP	LP
AY-DVM30EA	30 minutes	45 minutes
AY-DVM60EA	60 minutes	90 minutes
AY-DVM80EA	80 minutes	120 minutes

Erase Protection

Cassettes have a sliding record tab to ensure recordings are not accidentally erased.

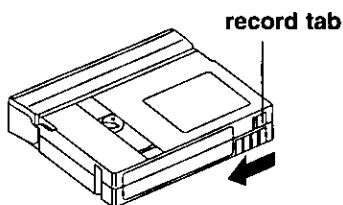

- 1 To prevent accidental erasure**
Slide the tab to the left (open).

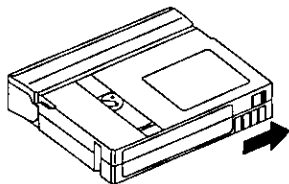

- 2 To record again**
Slide the tab to the right (close).

Color Enhancement Light

Using the Light

To brighten the natural colors in a scene.

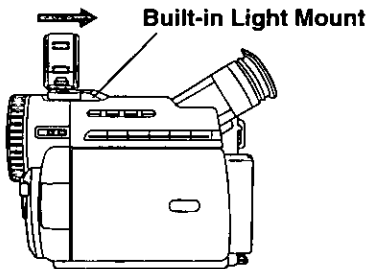

Before you begin...

- Connect the Palmcorder to a power source (pages 12, 13).
- Set **POWER** to **CAMERA**.

1 Slide Light into the Built-in Light Mount.

Be sure it locks into place.

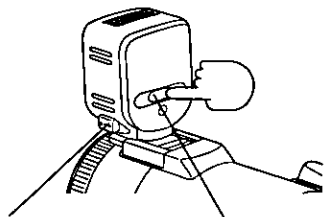

LIGHT RELEASE Button **LIGHT Button**

2 Press **LIGHT ON**.

3 Press **LIGHT** again to **OFF**.

To remove the Light:

Press **LIGHT RELEASE** and slide the Light out of the mount.

Caution:

This light becomes hot during operation. Make sure nothing covers the Light during operation.

Note

- Using the light will reduce battery operating time.
- If using the enhancement Light for an extended period of time, be sure to provide ventilation when using it in a hot environment.
- Be sure **LIGHT** is set to **OFF** when not in use.
- Do not attempt to lift or carry the Palmcorder by holding the Enhancement Light.
- If light bulb needs to be replaced, take Light to your nearest authorized service center.

Attaching the Shoulder Strap

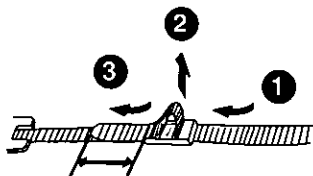
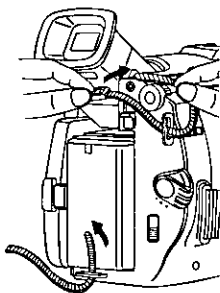
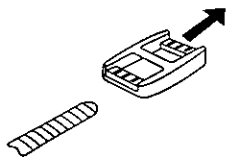
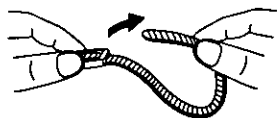

1 Undo the two strap ends from their buckles.

2 Remove the buckles from one end of the strap.

3 Thread the strap (with no buckle) through the Light Holder so that it faces outward. Then reinsert the buckle.

4 Thread the strap ends through the Strap Attachment Rings.

5 Reinsert the strap ends through their buckles.
• Make sure the straps are not twisted.

Adjust the Length

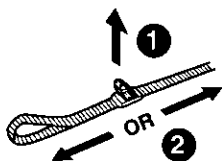

1 Loosen the strap from the Buckle and create a loop.

2 Pull the strap firmly through the Buckle to shorten or lengthen the strap.

Attaching the Shoulder Strap

Attach the Light

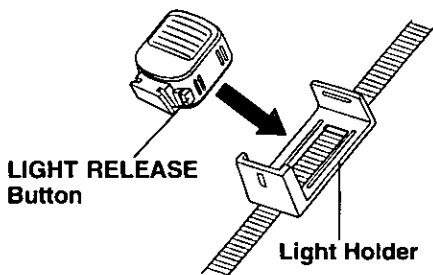

- 1** Insert the Light into the Light Holder for Storage.
- 2** To remove the Light, press **LIGHT RELEASE** and slide Light out from the holder.

Hand Strap

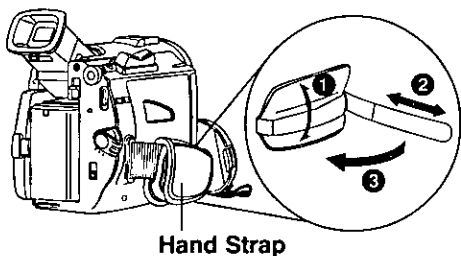

Adjust the length of the Hand Strap to the size of your hand as illustrated.

Lens Cap

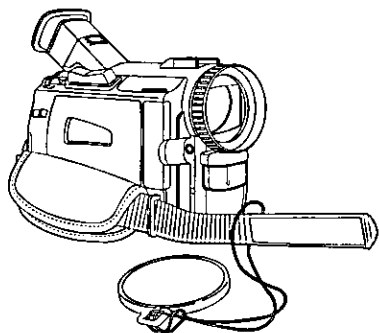

Attaching the Lens Cap Cord to the Hand Strap

Remove the Hand Strap from the front clasp and run the Strap through the Lens Cap Loop. Reattach the Hand Strap.

Set the Date and Time

The date and time is calculated, including leap year, up to DEC 31 2089.

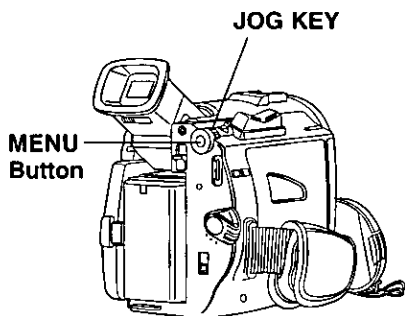

Before you begin...

- Connect the Palmcorder to a power source (pages 12, 13).
- Set POWER to CAMERA or VCR.

- 1 Press **MENU** to display the Camera or VCR mode menu screen (page 21).

CAMERA MENU VCR MENU

CAMERA MENU	VCR MENU
1:SUBFUNCTION	1:PLAY FUNCTION
2:ADJUST	2:REC MODE
3:REC MODE	4:PLAY MODE
4:SET-UP	5:DISPLAY SETTING
5:DISPLAY SETTING	6:LCD/EVF SETTING
6:LCD/EVF SETTING	
7:PHOTO TITLE	
*SELECT: ROTATE JOG KEY	*SELECT: ROTATE JOG KEY
*SET : PUSH JOG KEY	*SET : PUSH JOG KEY
*EXIT : PUSH MENU KEY	*EXIT : PUSH MENU KEY

- 2 Rotate **JOG KEY** to select **DISPLAY SETTING**, and then press **JOG KEY** to display the DISPLAY SETTING menu screen.

- DISPLAY SETTING menu is displayed.

- 3 Rotate **JOG KEY** to select **CLOCK SET**, and then press **JOG KEY** to set to ON (pages 22, 24).

- The DATE/TIME SETTING menu appears.

- 4 Rotate **JOG KEY** to select the desired numbers, then, press **JOG KEY** down to fix that portion and move to the next. Adjust the shaded items for the year, month, day, hour, and minute.

EXAMPLE:

YEAR	: 2000	
↓	(PUSH)	Push
MONTH	: JAN	
↓	(PUSH)	Rotate
MONTH	: FEB	

Note

- If you should pass the current year, continue pressing down on the **JOG KEY** until the year appears again.
- A built-in battery maintains clock operation. If the Palmcorder is not connected to a power source for a few months, the built-in battery may discharge and "CLOCK BATTERY" indication appears (page 29).

DATE/TIME SETTING	
YEAR	: 2000
MONTH	: OCT
DAY	: 18
HOUR	: 8PM
MINUTE	: 10
*SELECT:	PUSH JOG KEY
*SET :	ROTATE JOG KEY
*EXIT :	PUSH MENU KEY

When time setting is completed, press the **MENU** to start the clock.

Using the Palmcorder Menu

The Palmcorder features two menu displays: one for CAMERA mode (recording) and the other for VCR mode (Playback) (pages 21-25).

- While the Menu screen is displayed, you cannot record or play the tape.
- While recording, the Menu screen will not be displayed.
- While in playback, the Menu screen can be displayed.

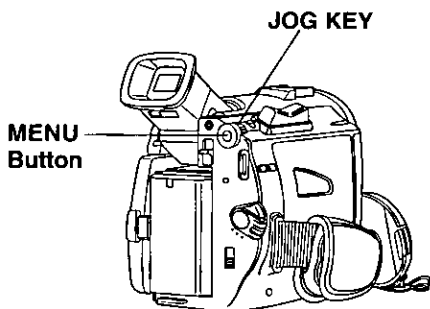

Displaying the MENU

Before you begin...

- Connect the Palmcorder to a power source (pages 12, 13).
- Set POWER to CAMERA or VCR.

1 Press **MENU** to display the CAMERA or VCR menu.

(CAMERA MENU)

```
CAMERASMENU
1:FUNCTION
2:ADJUST
3:REC MODE
4:SET UP
5:DISPLAY SETTING
6:LCD/EVF SETTING
7:PHOTO TITLE
-SELECT: ROTATE JOG KEY
-SET : PUSH JOG KEY
-EXIT : PUSH MENU KEY
```

(VCR MENU)

```
VCR MENU
1:PLAY FUNCTION
2:REC MODE
4:PLAY MODE
5:DISPLAY SETTING
6:LCD/EVF SETTING
-SELECT: ROTATE JOG KEY
-SET : PUSH JOG KEY
-EXIT : PUSH MENU KEY
```

2 Rotate **JOG KEY** select a menu item.

Setting the MENU Items (EX. VCR Mode menu)

1 Press down on the **JOG KEY** to set your selection.

2 Rotate **JOG KEY** to select a menu item.

- The characters of your selection will be inversely displayed.

```
VCR PLAY FUNCTION
D.FUNCTION OFF MIRROR
STROBE MOSAIC
SLIM TRAIL
STRETCH
D.EFFECT OFF SEPIA
MONO
-SELECT: ROTATE JOG KEY
-SET : PUSH JOG KEY
-EXIT : PUSH MENU KEY
```

```
VCR PLAY FUNCTION
D.FUNCTION OFF MIRROR
STROBE MOSAIC
SLIM TRAIL
STRETCH
D.EFFECT OFF SEPIA
MONO
-SELECT: ROTATE JOG KEY
-SET : PUSH JOG KEY
-EXIT : PUSH MENU KEY
```

3 Press down on the **JOG KEY** to set your selection.

- The "●" mark will indicate your selection.

4 Press **MENU** twice to exit the menu.

Camera and VCR main menu

CAMERA MENU

- 1 : D. FUNCTION
- 2 : ADJUST
- 3 : REC MODE
- 4 : SET-UP
- 5 : DISPLAY SETTING
- 6 : LCD/EVF SETTING
- 7 : PHOTO TITLE

VCR MENU

- 1 : PLAY FUNCTION
- 2 : REC MODE
- 3 : PLAY MODE
- 4 : DISPLAY SETTING
- 5 : LCD/EVF SETTING

CAMERA MENU

1 : D. FUNCTION

CAMERA FUNCTION menu is displayed. To select one of the 9 digital functions (MIRROR, STROBE, MOSAIC, SLIM, TRAIL, STRETCH, GAIN-UP, WIPE, or MIX).

2 : ADJUST

CAMERA ADJUST menu is displayed. To select PROG. AE, W. BALANCE, or H.S.S (High Speed Shutter).

3 : REC MODE

CAMERA REC-MODE menu is displayed. To select REC-SPEED, AUDIO-REC, INDEX, SHUTTER, SELF-REC, or WIND-CUT.

4 : SET-UP

CAMERA SET-UP menu is displayed. To select REMOTE, TALLY LED, BEEP, or IR-COLOR.

5 : DISPLAY SETTING

DISPLAY SETTING menu is displayed. To select DISPLAY, C.RESET, DATE/TIME, or CLOCK-SET.

6 : LCD/EVF SETTING

LCD/EVF SETTING menu is displayed. To select LCD BRIGHTNESS, LCD COLOR, or EVF BRIGHTNESS.

7 : PHOTO TITLE

PHOTO TITLE menu is displayed. To select TITLE or MODE.

VCR MENU

1 : PLAY FUNCTION

VCR PLAY FUNCTION menu is displayed. To select D. FUNCTION or D.EFFECT.

2 : REC MODE

VCR REC MODE menu is displayed. To select REC-SPEED, AUDIO-REC.

3 : PLAY MODE

VCR PLAY MODE menu is displayed. To select INDEX, AUDIO, REMOTE, or B.SEARCH.

4 : DISPLAY SETTING

DISPLAY SETTING menu is displayed. To select DISPLAY, C.RESET, DATE/TIME, or CLOCK-SET.

5 : LCD/EVF SETTING

LCD/EVF SETTING menu is displayed. To select LCD BRIGHTNESS, LCD COLOR, or EVF BRIGHTNESS.







MENU OSD

Camera Mode Menu Screen

CAMERA FUNCTION

D. FUNCTION ●OFF MIRROR
 STROBE MOSAIC
 SLIM TRAIL
 STRETCH
 GAIN - UP
 WIPE MIX

CAMERA ADJUST

PROG. AE ●OFF 
  
 (6) 
  
 ●AUTO
 SET ●(AUTO)

CAMERA REC - MODE

REC - SPEED ●SP LP
 ●12 bit 16 bit
 ●DAY 2HOUR
 ●OFF ON
 SELF - REC NORMAL ●MIRROR
 WIND - CUT ●OFF ON

CAMERA SET-UP

REMOTE OFF
 ●VCR1 VCR2
 OFF ●ON
 ●OFF ON
 ●B/W BLUE
 GREEN

DISPLAY SETTING

DISPLAY OFF ●LINEAR
 MEMORY T.CODE
 ●OFF ON
 DATE/TIME OFF
 ●D/T DATE
 ●OFF ON

LCD/EVF SETTING

LCD BRIGHTNESS
 LOW| | | |----- HIGH
 LCD COLOR
 LOW| | | |----- HIGH
 EVF BRIGHTNESS
 LOW| | | |----- HIGH

Camera Mode Menu Screen

CAMERA FUNCTION

- **DIGITAL FUNCTION** (page 55)
 To select one of the 9 digital functions. Setting to OFF cancels the previously selected digital function.

CAMERA ADJUST

- **PROG. AE** (page 54)
 To select one of the 5 Program AE modes. Setting to OFF cancels the previously selected Program AE mode.
- **W.BALANCE** (page 53)
 To select one of the 3 White Balance modes.
- **H. S. S (High Speed Shutter)** (page 58)
 To select a desired shutter speed.

CAMERA REC MODE

- **REC-SPEED** (page 15)
SP: Normal recording speed mode.
LP: Recording time is 1.5 times as long as in the SP mode. For example, 120 minutes of recording is possible on a 80 minutes tape.
- **AUDIO-REC** (page 59)
12 bit: The sound is recorded in the 12 bit/32 kHz mode.
16 bit: The sound is recorded in the 16 bit/48 kHz high-quality mode.
- **INDEX** (page 39)
DAY: An index signal is recorded when recording is restarted after the date has changed since the last recording.
2 HOUR: An index signal is recorded when recording is restarted after a lapse of more than 2 hours.

- **SHUTTER** (page 52)
When set to ON, still pictures taken in the PhotoShot mode are recorded with a visual shutter effect and click sound.
- **SELF-REC** (page 31)
NORMAL: During self-recording, the picture on the LCD Monitor is the same as it will be recorded.
MIRROR: During self-recording, the picture on the LCD Monitor is horizontally reversed.
- **WIND-CUT** (page 30)
To reduce sound distortion caused by wind hitting the microphone. However, this slightly deteriorates the sound reproduction in the bass range.

CAMERA SET-UP

- **REMOTE** (page 34)
VCR1: To receive signals from the Remote Control set to VCR1.
VCR2: To receive signals from the Remote Control set to VCR2.
OFF: To prevent reception of signals from the Remote Control.
- **TALLY-LED** (page 30)
Tally LED lights during recording when set to ON.
- **BEEP**
Set to ON to beep when starting and stopping camera recording or when unusual conditions occur. To cancel the beep, set to OFF.
Palmcorder will beep:
 - Once when you start recording
 - Twice when you stop recording
 - Repeatedly when warning of unusual conditions (pages 28, 29).
- **IR-COLOR** (page 53)
To select one of the 3 IR-COLOR modes after slide IR FILTER Switch to ON.

DISPLAY SETTING

- **DISPLAY** (page 26)
To select the desired type of display and counter indication displayed on the LCD Monitor or in the viewfinder.
- **C.RESET** (page 26)
Setting to ON, resets the counter to zero.
- **DATE/TIME** (page 27)
To display the date and time on the screen.
- **CLOCK-SET** (page 19)
When set to ON, the date and time can be set on the screen.

LCD/EVF SETTING

- **LCD/EVF SETTING** (page 31)
Setting to ON displays the menu for adjusting the LCD brightness and color level and the viewfinder brightness.

Photo Rec Mode Menu Screen

CARD SETTING

REC MODE NORMAL FINE

CARD SETTING

- **REC MODE** (page 41)
To select Photo Rec Mode.

PHOTO TITLE

TITLE MODE ●OFF WIPE ●SET MIX

VCR Mode Menu Screen

VCR PLAY FUNCTION

D. FUNCTION ●OFF MIRROR STROBE MOSAIC SLIM TRAIL STRETCH SEPIA
D. EFFECT ●OFF MONO

VCR REC MODE

REC - SPEED ●SP LP
AUDIO-REC ●12 bit 16 bit

VCR PLAY MODE

INDEX ●PHOTO SCENE AUDIO ●ST1 ST2 MIX OFF
REMOTE ●VCR1 VCR2 ●OFF ON
B.SEARCH ●OFF

DISPLAY SETTING

DISPLAY OFF ●LINEAR MEMORY T.CODE ON
C.RESET ●OFF DATE/TIME OFF
CLOCK - SET ●OFF DATE ON

LCD/EVF SETTING

LCD BRIGHTNESS LOW ||||| ----- HIGH
LCD COLOR LOW ||||| ----- HIGH
EVF BRIGHTNESS LOW ||||| ----- HIGH

PHOTO TITLE

- TITLE (page 48)
Photo Title is recorded.
- MODE (page 48)
To select one of the 2 Photo Title modes.

VCR Mode Menu Screen

VCR PLAY FUNCTION

- DIGITAL FUNCTION (page 55)
To select one of the 6 digital functions. Setting to OFF cancels the previously selected digital function.
- D. EFFECT (page 55)
To select one of the 2 digital picture effects for playing back. Setting to OFF cancels the previously select digital effect.

VCR REC MODE

- REC-SPEED (page 15)
SP: Normal recording speed mode.
LP: Recording time is 1.5 times as long as in the SP mode. For example, 120 minutes of recording is possible on a 80 minutes tape.
- AUDIO-REC (page 59)
12 bit: The sound is recorded in the 12 bit/32 kHz mode.
16 bit: The sound is recorded in the 16 bit/48 kHz high-quality mode.

VCR PLAY MODE

- INDEX (page 39)
To select the desired Index Search function.
PHOTO: To search for Photo shot pictures.
SCENE: To search for scenes marked with Index signal.

- **AUDIO** (page 59)
To select the desired audio playback mode after performing audio dubbing in the 12 bit mode.
ST1: The original sound alone is played back.
ST2: The dubbed sound alone is played back.
MIX: The original sound and the dubbed sound are played back together.
- **REMOTE** (page 34)
VCR1: To receive signals from the Remote Control set to VCR1.
VCR2: To receive signals from the Remote Control set to VCR2.
OFF: To prevent reception of signals from the Remote Control.
- **B.SEARCH (Blank Search)** (page 33)
Select ON to go directly to a blank portion of the tape.

DISPLAY SETTING

- **DISPLAY** (page 26)
To select the desired type of display and counter indication displayed on the LCD Monitor or in the viewfinder.
- **C.RESET** (page 26)
Setting to ON, resets the counter to zero.
- **DATE/TIME** (page 27)
To display the date and time on the screen.
- **CLOCK-SET** (page 19)
When set to ON, the date and time can be set on the screen.

LCD/EVF SETTING

- **LCD/EVF SETTING** (page 31)
Setting to ON displays the menu for adjusting the LCD brightness and color level and the viewfinder brightness.

Photo Play Mode Menu Screen

CARDSETTING

DISPLAY	●OFF	ON
DCF	●OFF	ON

CARD SETTING

- **DISPLAY** (page 43)
Select to OFF to cancel all Display on the screen.
- **DCF** (page 43)
Select to OFF to cancel DCF No. on the screen.

Electronic Viewfinder/LCD Monitor Indications

Here are some of the basic indications which will appear on the Palmcorder EVF and LCD Monitor. All indications, except the Date and Time, will NOT be recorded onto the tape.

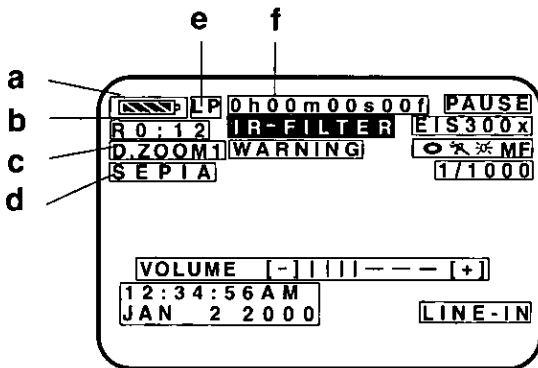

a. Battery Remaining

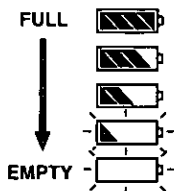

b. Tape Remaining

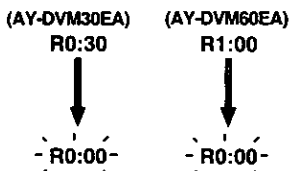

• It will take several seconds for the tape remaining indicator to operate after the tape starts moving.

c. Digital Zoom and other Digital Function (page 51)

This display appears when the digital zoom function has been activated.

d. Playback Effect (page 55)

This display appears when SEPIA or MONO is selected in VCR menu.

e. Tape Speed Indication (page 22)

Indicates the tape speed (SP or LP).

f. Display On/Off and Counter/Time Code

The indication switches as shown below when the desired "DISPLAY" mode is selected from the menu (pages 23, 25).

• When selecting OFF, all displays turn off.

Linear Time Counter Memory Counter

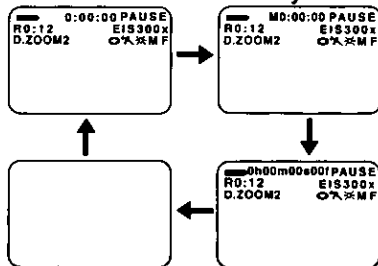

Time Code

Memory Counter M 0:00:00

The Palmcorder will stop whenever it reaches the point where the counter was previously set to M 0:00:00 during audio dub, fast forward or rewind.

Time Code 0h00m00s00f

The Palmcorder calculates and displays exactly where you are on any tape in terms of hours, minutes, seconds, and frames (30 frames = 1 second).

• This display can not be reset.

IMPORTANT NOTE:

Display must be set to ON for MF, AE, W.BALANCE or BACK LIGHT indications to be displayed on the EVF or LCD Panel when selected.

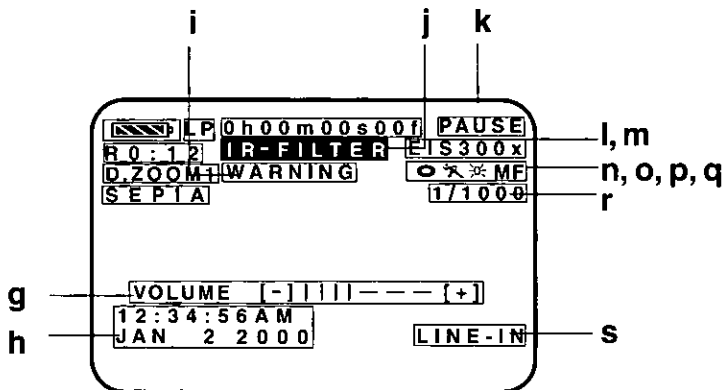

g. Volume Display (page 35)
The volume bar appears when the volume of the built-in speaker is being adjusted.

h. Date and Time Indication
(pages 23, 25)

As shown below, the date and time indication changes each time the DATE/TIME is selected from the Palmcorder's MENU (pages 23, 25) or the DATE/TIME Button is pressed on the remote (optional).

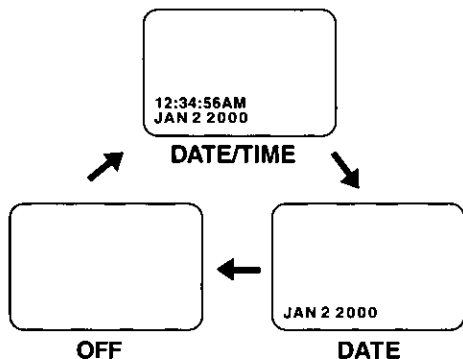

i. WARNING indication (pages 28, 29)
The warning displays appear in the EVF and the LCD monitor.

j. IR FILTER (page 53)
This display appears when IR FILTER is set ON.

k. Tape Mode Indications

- REC** Recording.
- PHOTO** PhotoShot Recording.
- PAUSE** Paused during recording.
- PLAY** Playback.
- R ▷** Repeat Playback.
- CHK** Recording Check.
- FF** Fast forward.
- REW** Rewind.
- ▷▷** FF Search.
- ◁◁** REW Search.
- BLANK** Blank Search.
- SEARCH** Index Search.
- Mirror feature recording.
- ||** Paused during Mirror feature recording.

l. Digital EIS Indications (page 50)

m. Zoom Magnification Level (page 51)

n. Manual Focus Indication (page 56)

o. White Balance Indication (page 53)

p. PROGRAM-AE Indication (page 54)

q. Backlight Indication (page 57)

r. Shutter Mode indication (page 58)

s. LINE-IN Mode indication (page 62)

Electronic Viewfinder/LCD Monitor Indications

The following warning displays appear in the EVF and the LCD monitor.

Warning Indications



If the Palmcorder is in CAMERA mode without a cassette inserted, "□□" will flash and "TAPE NOT INSERTED" will appear for 5 seconds. Recording will not start.

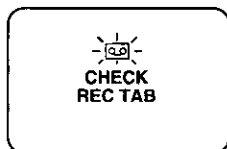

If the Palmcorder is in CAMERA mode with the cassette sliding record tab opened, "□□" will flash and "CHECK REC TAB" will appear for 5 seconds. Recording will not start.



When Audio dub is performed and the sliding record tab is open, or a blank portion of tape is detected, "□□" will flash and "CANNOT REC" will appear for 5 seconds.



When the tape is about to end in REC mode, "□□ END" will flash and "TAPE END" will appear for 5 seconds.



When an incompatible tape is detected, "INCOMPATIBLE TAPE" will appear for 5 seconds.



If the video heads require cleaning, "NEED HEAD CLEANING" will appear for 5 seconds.



When the Palmcorder and remote are not set to the same mode (VCR1 or VCR2), "CHECK REMOTE MODE" will also appear for 5 seconds when the Palmcorder is first turned on.

Electronic Viewfinder/LCD Monitor Indications

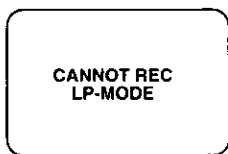

When an AUDIO DUB is attempted on a pre-recorded LP tape, "CANNOT REC LP-MODE" will appear for 5 seconds.



If excessive moisture condenses in the unit, "WARNING" will flash, "DEW DETECTED" will appear, and the Palmcorder will automatically turn OFF in 15 seconds. In this case, wait until the indicator no longer flashes when your Palmcorder is turned on again.

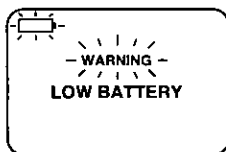

When a battery recharge is necessary, "WARNING" will flash, "LOW BATTERY" will appear, and the Palmcorder will automatically turn OFF in 15 seconds. (page 26).



When the built-in lithium clock battery is discharged, "CLOCK BATTERY" will appear. To re-charge the lithium clock battery, connect the AC Adaptor to the Palmcorder. Recharging takes approx. 4 hours. Reset the clock after charging.



If you play a tape recorded in a format other than NTSC or you try to copy a copy-protected tape, "INCOMPATIBLE DATA" will continuously appear. This message also appears if REC is pressed when DV/Analog is input and the copy of copyrighted information is prohibited.

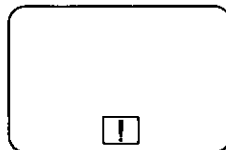

When the LCD monitor is rotated 180° so that it faces the same direction as the lens, the "!" mark indicates that a warning message exists. To view the warning, return the LCD monitor to the original position.

Camera Recording

Simple Recording

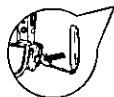
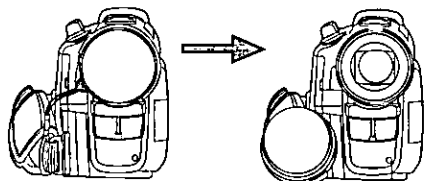

TALLY LED
Lights during recording.

Before you begin...

- Connect the Palmcorder to a power source (pages 12, 13).
- Insert a cassette with record tab closed (page 15).

Remove the lens cap and clip it to the hook.

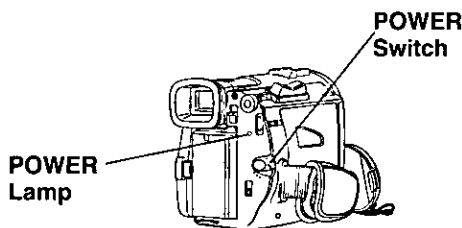

1 Set **POWER to CAMERA**.

- The POWER lamp lights red.
- Be sure **POWER** is fully turned to **CAMERA** position.

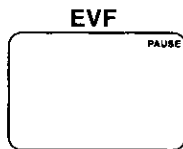

Record/Pause mode.

2 With the Viewfinder Eye Cup up to your eye, adjust the Vision Adjustment Control to your eyesight (page 9).

3 Press **RECORD/PAUSE** to start recording.

The Tally LED will be on.
To turn the Tally LED off, see **TALLY LED** on page 23.

Press **RECORD/PAUSE** again to pause recording.

- To reduce microphone wind noise, set the **WIND-CUT** to **ON** (see **WIND-CUT** on page 23).

- When the Palmcorder is aimed at excessively bright objects, or bright lights, a vertical bar may appear in the picture. This is a normal characteristic of the CCD pick-up device. Try to avoid this whenever possible.

To conserve power

After 5 minutes, the Record/Pause mode will automatically change to Standby mode. To resume recording, set **POWER** to **OFF** and then **ON** again.

WARNING:

- Do not leave the Palmcorder with the EVF aimed directly at the sun as this may cause damage to the internal parts of the EVF.
- Do not lift or carry the Palmcorder by the EVF or the LCD Monitor.

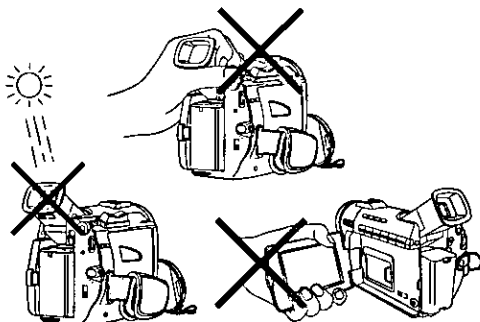

Using the LCD Monitor

The LCD (Liquid Crystal Display) monitor can be used while recording.

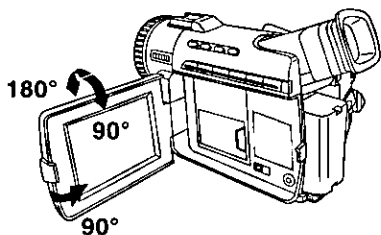
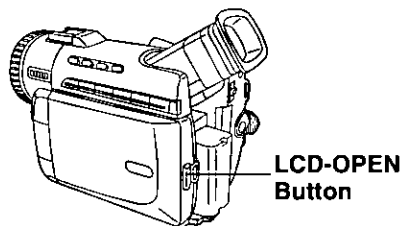

If you adjust the LCD Brightness or color.

- 1 Press **MENU** to display the main menu screen.
- 2 Rotate **JOG KEY** to select **LCD/EVF SETTING** from the main menu screen (pages 22, 24).
- 3 Press **JOG KEY** to display the LCD/EVF SETTING screen.
- 4 Press **JOG KEY** to select BRIGHTNESS or COLOR, then rotate **JOG KEY** to adjust them.
- 5 Press **MENU** twice to exit this mode.

Before you begin...

- Connect the Palmcorder to a power source (pages 12, 13).
- Insert a cassette with record tab closed (page 15).

- 1 Press **LCD_OPEN** to unlock the LCD monitor.
- 2 Swing the LCD monitor fully open and adjust the angle.
 - The LCD monitor will automatically turn on.
 - When the LCD monitor is completely closed, it will shut off automatically to save power.
 - Adjust the LCD Brightness and/or color of the LCD monitor if necessary.
- 3 Start recording (page 30).

Note

- Using the LCD monitor will reduce battery operating time.
- Close the LCD monitor completely when not in use.

LCD/EVF SETTING	
LCD BRIGHTNESS	LOW HIGH
LCD COLOR	LOW HIGH
EVF BRIGHTNESS	LOW HIGH
*SELECT: PUSH JOG KEY	
*SET : ROTATE JOG KEY	
*EXIT : PUSH MENU KEY	

Self Recording

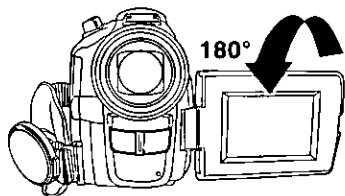

Rotate the LCD monitor 180 degrees so that it faces in the same direction as the lens while in the CAMERA mode to record yourself.

The picture in the LCD monitor will appear reversed.

Set **SELF-REC** to MIRROR (page 23) on the Camera mode menu screen to see the picture as it is actually being recorded.

Camera Recording

Recording Check

To playback the final few seconds of the last recorded scene in the Recording Pause Mode.

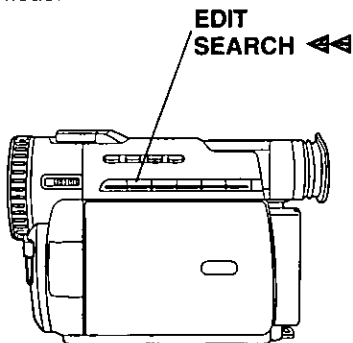

Edit Search

You can visually search for scenes in CAMERA mode to maintain proper continuity when taping.

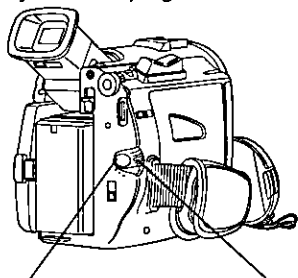

EDIT SEARCH ◀◀

EDIT SEARCH ▶▶

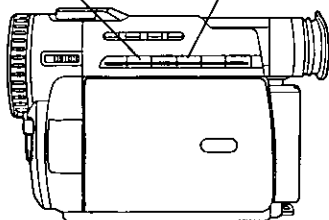

Press **EDIT SEARCH** ◀◀ briefly in the recording Pause Mode.

The [CHK] indication appears. After checking, the Movie Camera returns to the Recording Pause Mode.

- For Recording Check, the Movie Camera must be in the same mode (SP or LP) as used for recording, otherwise the playback picture is distorted.

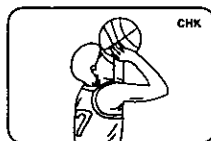

1

Set **POWER** to **CAMERA**.

- The POWER lamp lights red.
- Be sure POWER is fully turned to CAMERA position.

2

In **RECORD/PAUSE** mode, hold down **EDIT SEARCH** ▶▶ to perform a forward visual search or **EDIT SEARCH** ◀◀ to perform a reverse visual search. Releasing the button stops the search.

3

Press **RECORD/PAUSE** to continue recording.

Note

- During Edit Search, the picture will have a mosaic pattern. The sound will be muted when using reverse visual search.
- Make sure the SP/LP tape speed setting is the same as the recording to eliminate distortion during edit search.



Camera Recording / Remote Control

Blank Search

You can go directly to a blank portion of tape and start recording exactly where you left off.

MENU Button

JOG KEY

POWER Switch

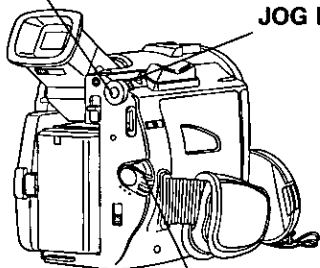

- 1 Set the **POWER** to **VCR**.
 - The POWER lamp lights red.
 - Be sure POWER is fully turned to VCR position.
- 2 Press **MENU** to display the VCR mode menu screen.
- 3 Rotate **JOG KEY** to select **PLAY MODE**, then press **JOG KEY** to display the VCR PLAY MODE menu screen.
- 4 Rotate **JOG KEY** to select **BLANK** in the VCR PLAY MODE menu (page 25).
- 5 Press **JOG KEY** to select ON.
 - "BLANK" will appear on the screen.

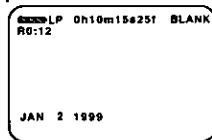

Remote Control (Optional, page 74)

You can operate the major functions of your Palmcorder from up to approximately 16 feet (5 m) away (indoors). Aim the IR Remote Control toward the front of the Palmcorder and press the desired buttons (Remote Sensor is located under the lens).

To operate Camera functions:

Set **POWER** to **CAMERA**.

To operate VCR functions:

Set **POWER** to **VCR**.

Controlled Functions

- Rec/Pause (page 30)
- Tele (Zoom) (page 51)
- Wide (Zoom) (page 51)
- Date/Time (page 27)
- Reset (page 60)
- PhotoShot (page 52)
- Display On TV (page 40)
- Counter/Time Code (page 26)
- Audio Dubbing (page 59)
- Record (page 63)
- Menu (page 20)
- Play (page 35)
- FF/Search (page 36)
- REW/Search (page 36)
- Pause/Select (pages 20, 36)
- Stop/Set (pages 20, 35)
- Slow/Frame Advance (Forward) (pages 36, 38)
- Slow/Frame Advance (Backward) (pages 36, 38)
- Index Search (Forward) (page 39)
- Index Search (Backward) (page 39)
- Speaker Volume (page 35)

Remote Sensor

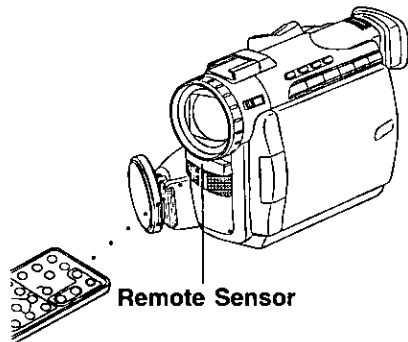

Remote Control (Optional)

Remote Controlling Two Palmcorders

You can control any two Panasonic Digital Video Camcorder with one Remote control (Optional, page 74). In order for the remote to distinguish between the two units, it is necessary to set one of the Palmcorders to VCR 2. On the remote, press VCR 1 or VCR 2 to control the desired Palmcorder.

Optional

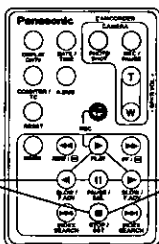

For VCR 2 :
Press these buttons at same time.

For VCR 1 :
Press these buttons at same time.

Note

- When the Palmcorder and remote are not set to the same mode (VCR1 or VCR2), "CHECK REMOTE MODE (REMOTE)" will appear.

REMOTE

- 1** Set the **POWER** to **VCR** or **CAMERA**.
 - The POWER lamp lights red.
 - Be sure POWER is fully turned to VCR or CAMERA position.
- 2** Press **MENU** to display the VCR or CAMERA mode menu screen.
- 3** Rotate **JOG KEY** to select **CAMERA SET-UP** in the CAMERA mode menu screen or **VCRPLAYMODE** in the VCR mode menu screen, then press **JOG KEY** to display the CAMERA SET-UP or VCR PLAY MODE menu screen.
- 4** Rotate **JOG KEY** to select **REMOTE**, and then press JOG KEY to select VCR 2 on one Palmcorder (pages 23, 25). Leave the other Palmcorder set to VCR1.
- 5** Set the Remote Control (Optional, page 74) to **VCR 1** or **VCR 2** to correspond with the Palmcorder you wish to control. (See illustration at left.)

- After replacing the Remote Control Battery, the remote will default to VCR 1.

Replace the Battery

Optional

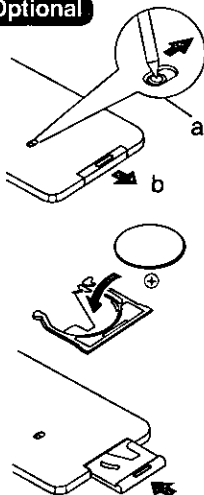

- 1** Insert a slender pointed object, such as the tip of a ball-point pen into the slot so that it fits into the hole (as shown a). Then, while sliding to the right, pull the Battery Tray out with your fingernail.
- 2** Insert the battery into the Battery Tray with the ⊕ mark facing down.
Do not reverse the polarity.
- 3** Insert the Battery Tray.

Replace battery with Panasonic PART NO. VSBW0004 (CR2025) only. Use of another battery may present a risk of fire or explosion.

Caution-battery may explode if mistreated. Dispose of used battery promptly. Keep away from children. Do not recharge, disassemble or dispose of in fire.

Playback your Recordings

Playback using the LCD Monitor

You can also use the LCD monitor to playback your recording.

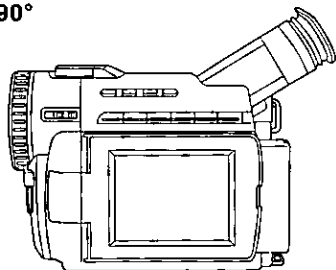
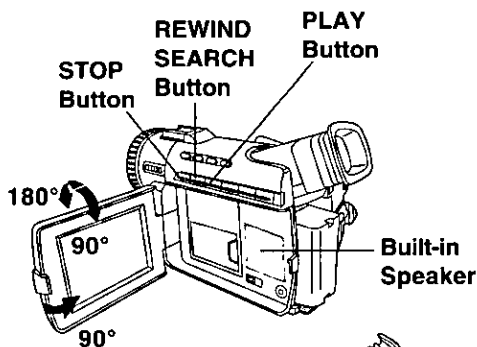
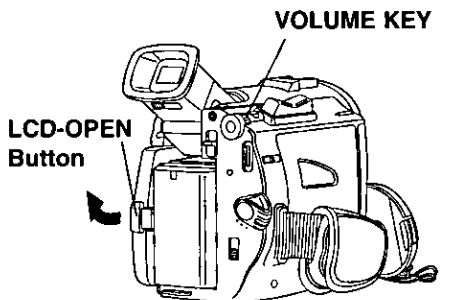

You can place the Palmcorder on a table, etc. for viewing. Rotate the LCD Monitor 180° and swing it up against the Palmcorder body as shown.

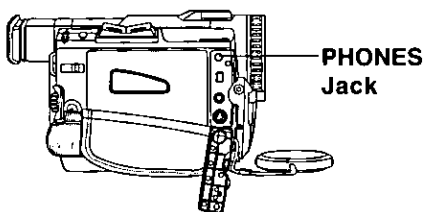

Before you begin...

- Connect the Palmcorder to a power source (pages 12, 13).
- Insert a recorded cassette.
- Set Power to VCR.

1 Press **LCD-OPEN** to unlock the LCD monitor and swing open.

2 Press **REWIND/SEARCH** to rewind the tape.

3 Press **PLAY** to start playback.

To adjust the volume:

Hold down **VOLUME KEY** until the volume setting screen appears (page 27). Then rotate **VOLUME KEY** to adjust the volume of the built-in speaker. To disappear the volume setting screen, hold down **VOLUME KEY** again.

• Adjust the picture on the LCD monitor if needed (page 31).

4 Press **STOP** to stop playback.

- When the tape reaches its beginning during rewind or rewind search, it will stop automatically.
- If you press **PLAY** for more than 5 seconds, the Palmcorder will start the Repeat Playback mode when the tape reaches its end. The letter "R ▷" will appear in the EVF and LCD monitor.

To exit the Repeat Playback mode, turn the Palmcorder OFF.

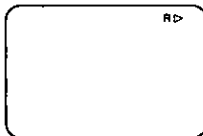

Note

- When a tape recorded in LP mode on another digital video camera is played back on this unit, the picture may appear mosaic.
- Using the LCD monitor reduces battery operating time.
- Connect earphones (not supplied) to the PHONES Jack.

Playback Your Recordings

Special Effect Features During Playback Continued

(Sound is Muted during all special effects)

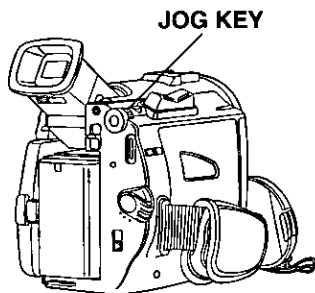
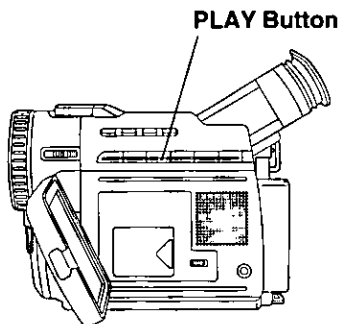

REWIND/SEARCH Button **FAST FORWARD/SEARCH** Button

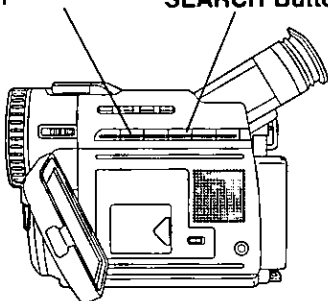

Variable Speed Search

- 1 Press **PLAY** to start playback.
- 2 Press **PLAY** again.
- 3 Rotate the **JOG KEY** to adjust the playback speed.
 - Rotate **JOG KEY** downward for forward playback.
 - Rotate **JOG KEY** upward for reverse playback.

To return to normal playback:
Press **PLAY**. Playback will continue at normal speed.

Note

- The Variable Speed Search function offers a choice of six playback speeds (1/5x, 1x, 2x, 5x, 10x, 20x) both in forward and reverse directions.
- The review playback at the 1x speed is playback in reverse direction.
- During the Variable Speed Search (at a speed other than 1x), mosaic-like patterns will appear in the picture.
- During the Variable Speed Search, sound is muted.

Fast Forward/Rewind Check

Monitor normal picture playback during fast forward or rewind.

- **Hold down FAST FORWARD/SEARCH** during fast forward.
- **Hold down REWIND/SEARCH** during rewind.
- The picture will appear for as long as the button is held down.

Playback Your Recordings

Special Effect Features During Playback Continued

(Sound is Muted during all special effects)

**PLAY PAUSE
Button Button**

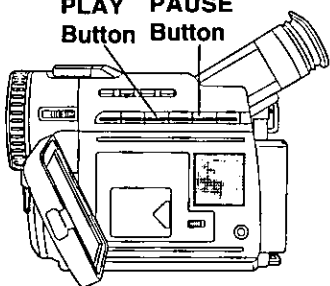

JOG KEY

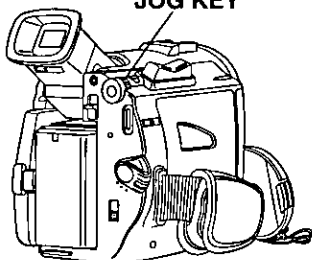

Optional

**◀| SLOW/
F.ADV
Button**

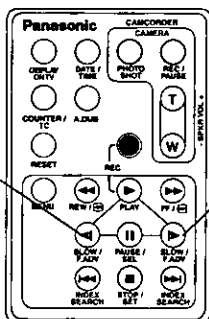

**▶| SLOW/
F.ADV
Button**

Frame by Frame Advance

Optional Remote Control Only (page 74)

Press **PAUSE** during playback.

Press **▶| SLOW/F.ADV** to do a frame by frame advance.

Press **◀| SLOW/F.ADV** to do a frame by frame reverse.

Press **PLAY** to release.

Note

- If you hold down SLOW/F.ADV, you can see a continuous series of still images at a slower speed than normal slow mode.
- During frame by frame advance, a few frames may move automatically, and the picture may become bluish for an instant.

Jog Frame by Frame Search

(Palmcorder only)

During Still mode, rotate **JOG KEY** to advance or reverse the picture one frame at a time.

Playback Your Recordings

Connections

TV with AUDIO/VIDEO IN Jacks.

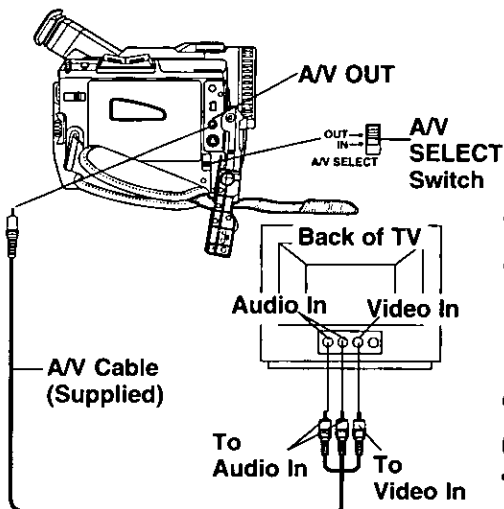

TV with S-VIDEO IN Jacks.

For best Chrominance and Luminance, it is suggested to use the S-Video connection if available on your TV.

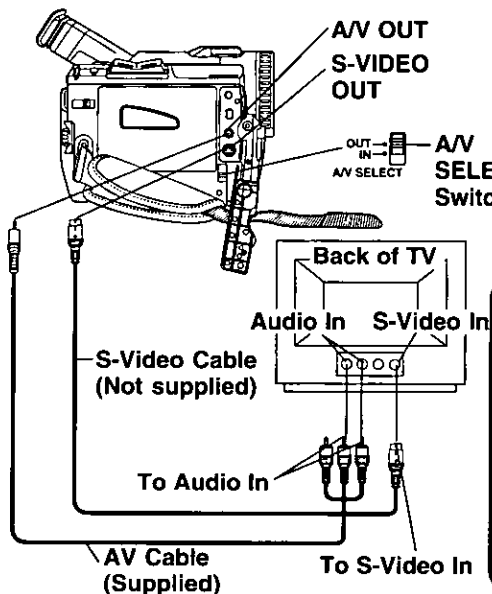

- 1** Set **POWER** to **CAMERA**.
You can now view what the Palmcorder is recording on your TV.
Or, to playback a tape, set **POWER** to **VCR**.
You can now playback a recorded tape on your TV.
- 2** Set **AV SELECT** to **OUT**.
- 3** Turn your TV ON and set it to **LINE INPUT** or **S-VIDEO**.
Check your TV operating instructions for further information.
- 4** Start playback or begin a recording.

Note

- Please fully connect the A/V cable to both the camcorder and the TV.
- Make sure the Palmcorder and TV are turned off while connecting.

Optional Remote Control Only (page 74)

You can display the various EVF and LCD indications on your TV by pressing **DISPLAY ON TV** on remote control. Press again to remove the indications.

DISPLAY ON TV Button

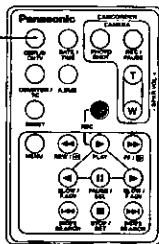

CATV System Installer

This reminder is provided to call the CATV system installer's attention to Article 820-40 of the NEC in USA (and to the Canadian Electrical code in Canada) that provides guidelines for proper grounding and, in particular, specifies that the cable ground shall be connected to the grounding system of the building, as close to the point of cable entry as practical.

You can record still images to a MultiMediaCard.

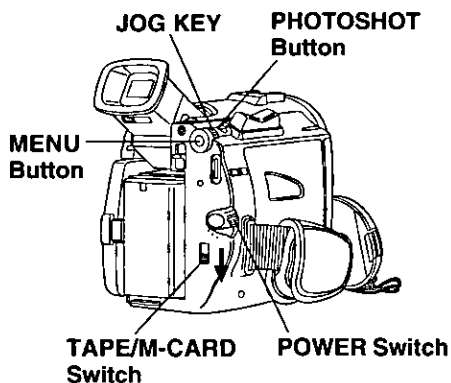

Image Resolution and Capacity (8MB MultiMediaCard)

REC Mode	Image Resolution	Capacity
FINE	640 x 480	Approx. 60 images
NORMAL	320 x 240	Approx. 240 images

- The number of images given for each mode applies when all images are taken in same mode.
- You can change recording modes at any time before capturing an image.
- The number of images that can be captured may differ depending on the subject. After capturing an image, the number may not decrease, or it may decrease by two. This is normal.

Note

- While "PROCESSING" is displayed, do not turn off the Digital Video Camera or unplug the AC Adaptor (supplied) because this will cause irreversible damage to the memory.

Before you begin...

- Connect the Palmcorder to a power source (pages 12, 13).
- Set POWER to OFF before inserting a MultiMediaCard (page 9).

1 Set POWER to CAMERA.

- The POWER lamp lights red.
- Be sure POWER is fully turned to CAMERA position.

2 Set TAPE/M-CARD to M-CARD.

- (page 9).
- "PLAY: PUSH PLAY KEY" is displayed for 10 seconds (page 43).

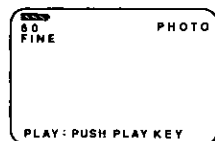

3 Press MENU to display CARD SETTING menu, then press JOG KEY to select NORMAL or FINE.

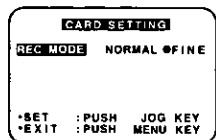

- Press MENU to exit this menu.

4 Press PHOTOSHOT to record an image.



- The PhotoShot image is recorded to the MultiMediaCard.
- When SHUTTER is set to ON (page 23), still pictures are recorded with a visual shutter effect and click sound. If set to OFF, only the visual shutter effect will occur.

Recording images From a Tape

You can record still images from a cassette tape to a MultiMediaCard.

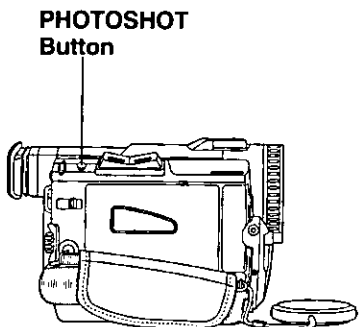
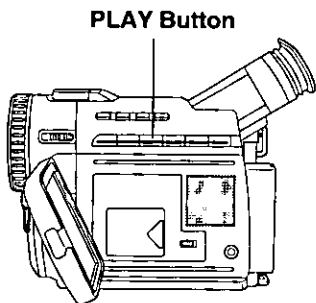
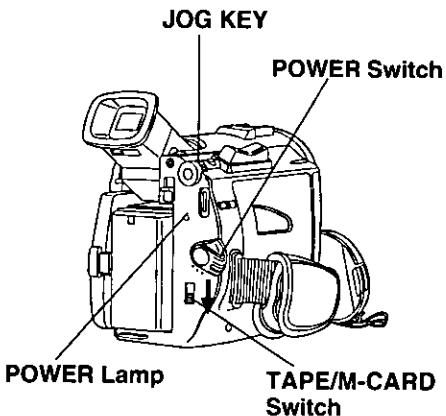

Before you begin...

- Connect the Palmcorder to a power source (pages 12, 13).
- Insert a MultiMediaCard (page 9).

1 Set **POWER** to **VCR**.

- The POWER lamp lights red.
- Be sure POWER is fully turned to VCR position.

2 Set **TAPE/M-CARD** to **M-CARD**. (page 9).

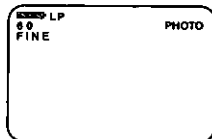

3 Press **MENU** to display the **CARD SETTING** menu screen, then press **JOG KEY** to select **NORMAL** or **FINE**.

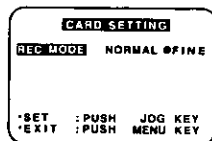

- Press **MENU** to exit this menu.

4 Press **PLAY** to start playback of the cassette tape. And then, press **PAUSE** to select an image.

5 Press **PHOTOSHOT** to record a desired image to the MultiMediaCard.

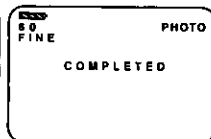
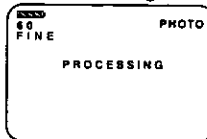

- When PHOTOSHOT is pressed in PLAY or SLOW mode, the screen goes to STILL mode.
- To playback the images of the MultiMediaCard, see page 43.
- When Variable Speed Search is done (page 37), this feature can not be used.

6 Repeat steps 4~5 to record another image to the MultiMediaCard.

Playback Still Images

You can display the images of the MultiMediaCard.

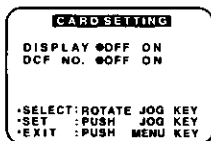
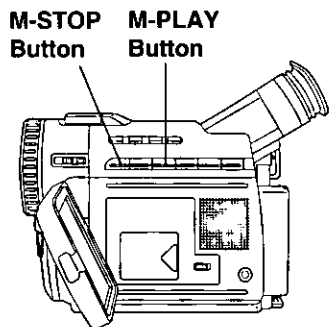
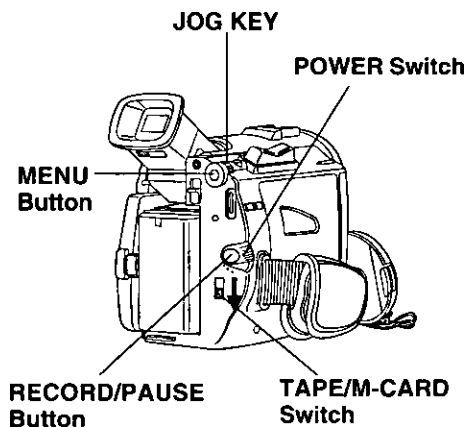

- DISPLAY** : Select OFF to cancel all Display on the screen.
- DCF** : Select OFF to cancel DCF No. on the screen.

Note

- If the file number is changed, the Palmcorder cannot read the file.

Before you begin...

- Connect the Palmcorder to a power source (pages 12, 13).
- Insert a recorded MultiMediaCard (page 41).

- 1 Set POWER to CAMERA.**
 - The POWER lamp lights red.
 - Be sure POWER is fully turned to CAMERA position.
- 2 Set TAPE/M-CARD to M-CARD.** (page 9).
 - "PLAY: PUSH PLAY KEY" is displayed for 10 seconds.

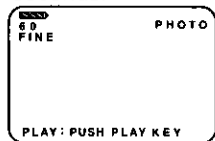

- 3 Press M-PLAY** to display the Multi playback screen.
 - "PLEASE WAIT" is displayed on the screen.
 Then **rotate JOG KEY** to select image.
 - Rotate JOG KEY to scroll through Multi image screen pages (each page contains 6 images).
 - The selected image is underlined in green. The color of image numbers is white for FINE mode and green for NORMAL mode.

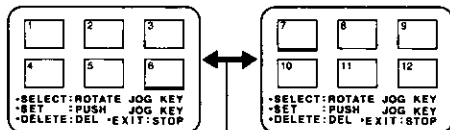

"PLEASE WAIT" is displayed.

- Press **MENU** for the display CARD SETTING menu screen.
- Press **M-STOP** to return to the Card PhotoShot REC Mode (page 41).

Note

- While "PLEASE WAIT" is displayed, do not turn off the Digital Video Camera or unplug the AC Adaptor (supplied) because this will cause irreversible damage to the memory.

Special Features

JOG KEY

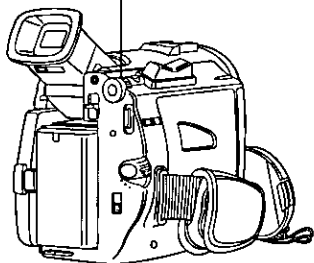

- 4** Press **JOG KEY** to display the selected image as a full-size screen.
- "PLEASE WAIT" is displayed on the screen.
 - Rotate and press **JOG KEY** to return to the previous image, next image, or Multi playback image screen.

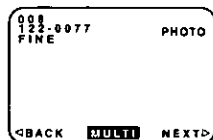

M-STOP Button

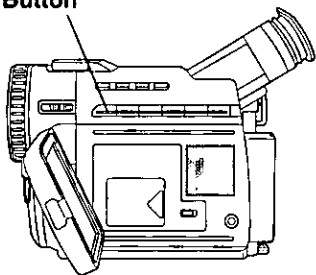

- 5** Rotate **JOG KEY** to select **BACK**, **MULTI**, or **NEXT**, and then press **JOG KEY** to set.
- Select **BACK** to go to the previous image.
Select **MULTI** to go to the multi image screen.
 - Select **NEXT** to go to the next image.
 - Press **M-STOP** to return to the Multi Playback screen (page 41).

Precautions for the MultiMediaCard

- While the MultiMediaCard is being read, do not remove it, turn off the power, or subject it to vibrations and shocks.
- Do not leave the MultiMediaCard in a place with high temperature, exposed to direct sunlight, or where electromagnetic waves and static electricity can be generated.
- Electromagnetic waves, static electricity, malfunction of the Digital Video Palmcorder or of the MultiMediaCard itself could erase the data recorded on it. To prevent the loss of picture data, we recommend that you make a backup copy on a cassette or on the computer.
- Do not bend or drop the MultiMediaCard as this could damage the MultiMediaCard or the captured contents.
- Do not touch the connector on the rear edge of the MultiMediaCard with your fingers and take care that no dirt, dust or water enters it.
- Do not affix other labels to the MultiMediaCard face or back as Card insertion/removal may become impossible.

Delete Specific Image Pages

You can delete unwanted images and increase the remaining image memory.

Warning:

Once deleted, images cannot be restored.

DELETE PAGE

You can delete unwanted images.

DELETE ALL

You can delete all images.

FORMAT

You can delete all data.

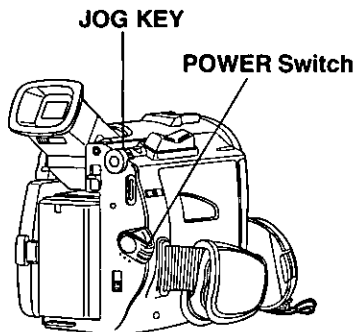

M-STOP Button M-PLAY Button M-DEL Button

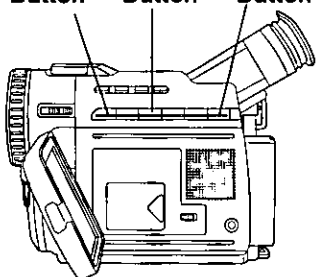

Before you begin...

- Connect the Palmcorder to a power source (pages 12, 13).
- Insert a recorded MultiMediaCard (page 41).

1 Do steps 1 and 3 on page 43.

2 Press **M-DEL** to display the DELETE menu, then rotate and press **JOG KEY** to select **PAGE**.

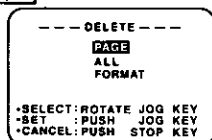

- Multi playback image screen will be displayed.

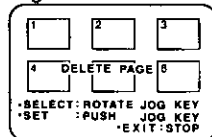

3 Rotate and press **JOG KEY** to select and set the image to be deleted.

- You can select as many images as you like for deletion.
- Press **JOG KEY** to cancel the selected image.
- Press **M-DEL** to delete the selected image.
- To cancel delete, press **M-STOP**.

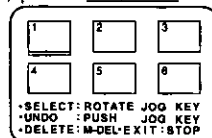

4 Press **M-DEL** to delete selected page.

- The screen below is displayed.
- "PLEASE WAIT" is displayed on the screen.
- Press **M-DEL** to set. Images set for deletion are underlined in red.

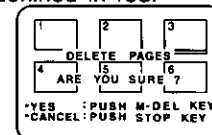

- To delete, press **M-DEL**.
- To cancel delete, press **M-STOP**.
- To delete other image pages, repeat step 4.
- To exit, press **M-STOP**.

Note

- While deleting image, do not turn off the Digital Video Camcorder or unplug the AC Adaptor (supplied) because this will cause irreversible damage to the memory, resulting in reduced image storage capacity.

Delete All Image Pages

You can delete all images from a MultiMediaCard easily with this operation.

Warning:

Once deleted, images cannot be restored.

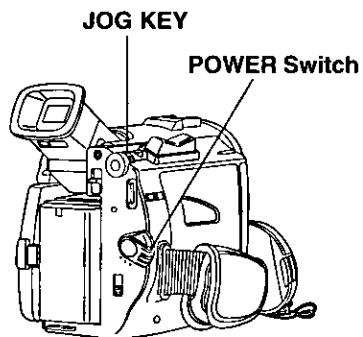

M-STOP Button M-PLAY Button M-DEL Button

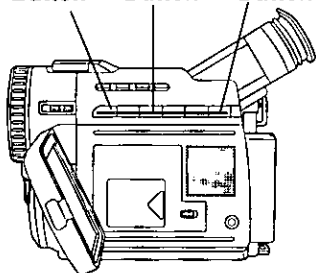

Before you begin...

- Connect the Palmcorder to a power source (pages 12, 13).
- Insert a recorded MultiMediaCard (page 41).

1 Do steps 1 and 3 on page 43.

2 Press **M-DEL** to display the DELETE menu. Then, rotate and press **JOG KEY** to select **ALL**.

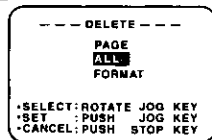

- The screen below is displayed.
- To cancel delete, press **M-STOP**. The Multi playback image screen is displayed.

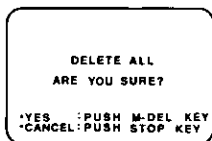

3 Press **M-DEL** to delete all images.

- "PLEASE WAIT" is displayed on the screen.

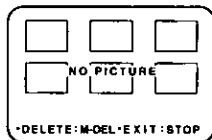

- Press **M-STOP** to return to the Card PhotoShot REC Mode screen (page 41).

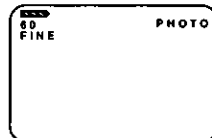

Note

- While deleting image, do not turn off the Digital Video Camcorder or unplug the AC Adaptor (supplied) because this will cause irreversible damage to the memory, resulting in reduced image storage capacity.

Format the MultiMediaCard

You can easily format your MultiMediaCard using this operation.

Warning:

Formatting permanently removes all image data.

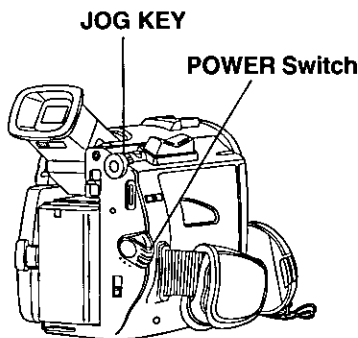

M-STOP Button M-PLAY Button M-DEL Button

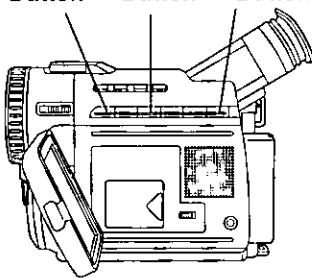

Before you begin...

- Connect the Palmcorder to a power source (pages 12, 13).
- Insert a recorded MultiMediaCard (page 41).

1 Do steps 1 and 3 on page 43.

2 Press **M-DEL** to display the DELETE menu, then **rotate and press JOG KEY** to select **FORMAT**.

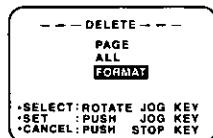

- The screen below is displayed.
- To cancel format, press **STOP**.

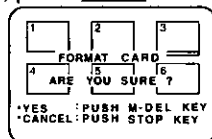

3 Press **M-DEL** to format the MultiMediaCard.

- "PLEASE WAIT" is displayed on the screen as all images are deleted from memory. Deletion is complete when "NO PICTURE" is displayed.

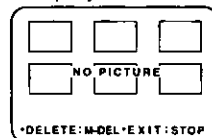

- Press **M-STOP** to return to the Card PhotoShot REC Mode screen.

Note

- While deleting image, do not turn off the Digital Video Camcorder or unplug the AC Adaptor (supplied) because this will cause irreversible damage to the memory, resulting in reduced image storage capacity.

Photo Title

You can record PhotoShot images from a MultiMediaCard to a cassette to be used as a WIPE or MIX effect.

Note

When Photo Title is set to ON, the selected image and Title will appear before each recording is made.

WIPE : Successive scenes are separated in a way which simulates the drawing of a curtain.



MIX : The current scene is mixed with the title image when the scene changes.

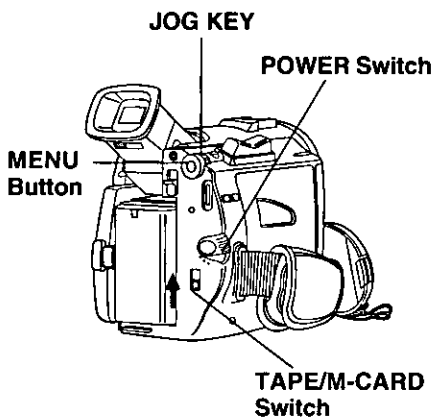

Before you begin...

- Connect the Palmcorder to a power source (pages 12, 13).
- Insert a recorded MultiMediaCard (page 41).

1

Set **POWER to CAMERA**.

- The POWER lamp lights red.
- Be sure POWER is fully turned to CAMERA position.

2

3

Set **TAPE/M-CARD to TAPE** (page 8).

Press **MENU** to display the CAMERA menu screen. Then **rotate and press JOG KEY** to select **PHOTO TITLE**.

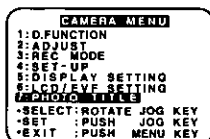

4

Rotate and press **JOG KEY** to select **MODE** and **TITLE**.

1st : Select and set MODE.

2nd: Select and set TITLE to "SET".

- "PLEASE WAIT" is displayed on the screen.
- The Multi image screen is displayed.

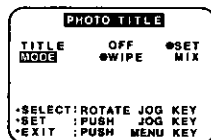

5

Rotate and press **JOG KEY** to select and set an image.

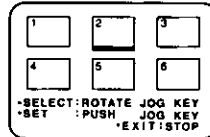

- "PLEASE WAIT" is displayed while image is processed.
- After Photo Title is preformed, Digital Function turns off.
- There are 12 pre-installed files.

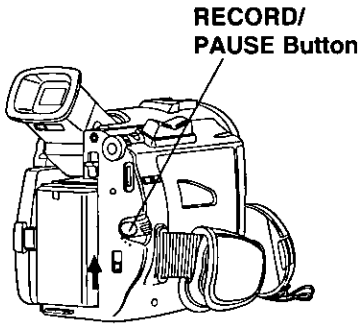

- 6** PHOTO TITLE SET screen is displayed.

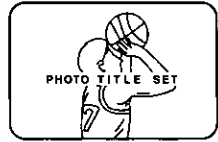

- After 3 seconds, the screen goes back to the Camera mode screen.

WIPE or MIX



- 7** Press **REC/PAUSE** to start recording with Photo Title.
- **WIPE** or **MIX** screen is displayed at beginning of next recording. Then the Photo Title setting will be cleared automatically.

Special Features

Dual Digital Electronic Image Stabilization System (D.E.I.S.)

The feature helps to compensate for any unintentional hand or body movement. It can be used in both the Recording and Playback (VCR) modes.

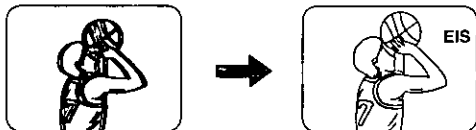

NORMAL

EIS ON

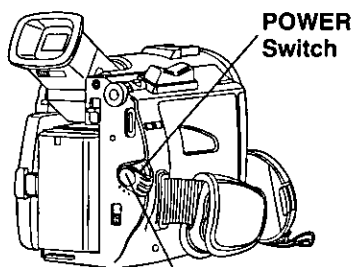

**REC/PAUSE
Button**

EIS Button

PLAY Button

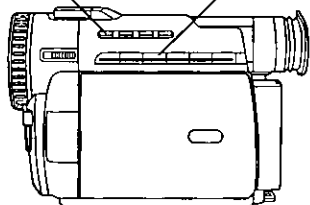

Note

- Digital Functions are turned off automatically when the EIS and Digital Zoom are selected.

Camera mode

- 1 Set POWER to CAMERA.**
 - The POWER lamp lights red.
 - Be sure POWER is fully turned to CAMERA position.
- 2 Press EIS to stabilize the picture.**
 - Picture flicker may be observed when taping under fluorescent lighting conditions.
 - The EIS indicator flashes when the light level is inadequate.
 - Turn D.E.I.S. OFF during recording when using a tripod.
- 3 Press REC/PAUSE to start recording.**
- 4 Press EIS again to cancel.**
 - Be sure that D.E.I.S. is turned off when not needed.

D.E.I.S. may not function when...

- Palmcorder movement is too extreme.
- Recording a subject with distinct horizontal or vertical stripes.
- Recording in low light situations.
- Recording a subject under a great amount of fluorescent light.
- Recording a scene with very fast motions.

VCR mode

- 1 Set POWER Switch to VCR.**
 - The POWER lamp lights red.
 - Be sure POWER is fully turned to VCR position.
- 2 Press PLAY to start playback.**
- 3 Press EIS to stabilize the picture.**
- 4 Press EIS Button again to cancel.**
 - Be sure that D.E.I.S. is turned off when not needed.

Note

- When using D.E.I.S. in VCR mode, the size of the scene may appear slightly larger.

Zoom

You can gradually zoom in for close ups or zoom out for wide angle shots.

Zoom slowly : By lightly pressing the "T" (Telephoto) or the "W" (Wide Angle) side of the POWER ZOOM Switch.

Zoom quickly : By applying more pressure.

Note

The zooming speed ranges from a slow 22 seconds to a fast 2 seconds according to the amount of pressure applied to the POWER ZOOM Switch.

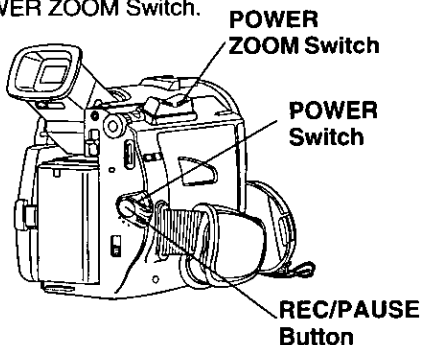

Zoom In ("T")

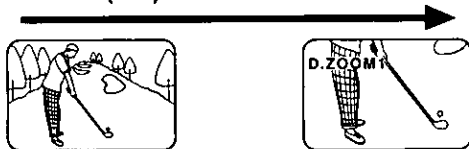

Zoom Out ("W")

D. ZOOM Button PLAY Button

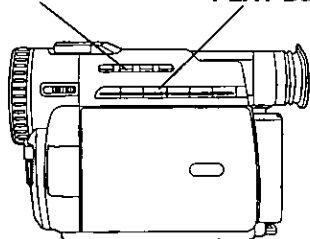

Note

- Digital Functions are turned off automatically when the EIS and Digital Zoom are selected.

Digital Zoom

Camera mode

- 1 Set **POWER** to **CAMERA**.
 - The POWER lamp lights red.
 - Be sure POWER is fully turned to CAMERA position.
- 2 Press **D. ZOOM** to select D.ZOOM1 or D.ZOOM2.
 - once** : D.ZOOM1 (from 18x to 36x)
 - twice** : D.ZOOM2 (from 18x to 300x)
 - three times** : Turn off D.ZOOM
- 3 Press **REC/PAUSE** to start recording and press **POWER ZOOM** to zoom in or zoom out.
 - The magnification level is always displayed in the EVF or the LCD monitor when DISPLAY is set to ON (pages 23, 25)
- 4 Press **D.ZOOM** to turn off Digital Zoom so that no indication appears.

Note

- The normal optical zoom functions from 1x to 18x.
- Because the image is enlarged digitally, the picture may become distorted when higher magnification levels are used.
- When the level falls below 18x, the normal zooming function will resume.
- Focus distance becomes 4 feet (1.2m) if the lens is in full telephoto.

VCR mode

- 1 Set **POWER** to **VCR**.
 - The POWER lamp lights red.
 - Be sure POWER is fully turned to VCR position.
- 2 Press **PLAY** to start playback.
- 3 Press **D.ZOOM**.
 - The center portion of the image doubles in size.
- 4 Press **D.ZOOM** again for normal image size.

White Balance

Auto White Balance automatically maintains optimum color balance in most lighting conditions. However, when using Digital Functions, etc., you may get better results using the manual adjustment.

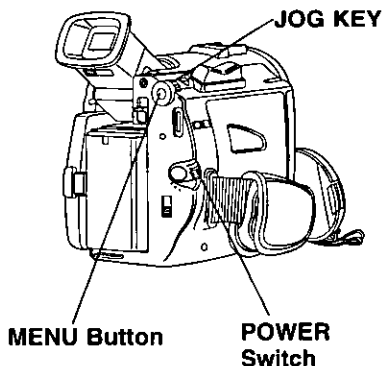

- 1 Set **POWER** to **CAMERA**.
 - The **POWER** lamp lights red.
 - Be sure **POWER** is fully turned to **CAMERA** position.
- 2 Press **MENU** to display the menu screen.
- 3 Press **JOG KEY** to select **ADJUST**, and then press **JOG KEY** to display the **CAMERA ADJUST** menu screen.
- 4 Rotate **JOG KEY** to select **W.BALANCE**, and then press down on **JOG KEY** repeatedly to select either **AUTO**, Indoor halogen lamp "☀", or Outdoors "☀☀".

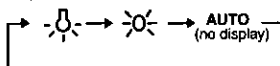

☀ : When the source illumination is a halogen lamp.

☀☀ : When shooting outdoors on a sunny day.

AUTO : Automatically maintains optimum color balance in most lighting conditions.

Recording Still Pictures

You can record still pictures of any desired duration together with sound.

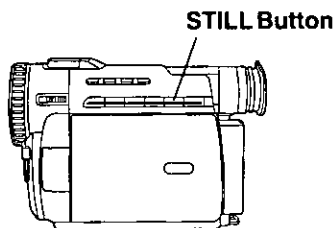

- 1 While in **RECORD** mode, press **STILL** and hold for 2 seconds to capture still picture. The captured still picture will be recorded together with the sound.
- 2 Press **STILL** once again to release the still picture. The camera will resume recording real-time pictures.

IR FILTER

The **IR FILTER** allows you to record subjects in a comparatively dark place.

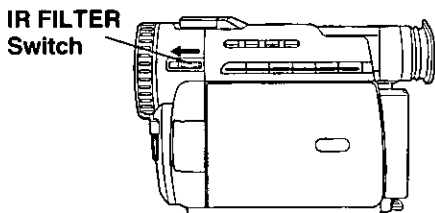

- 1 Set **POWER** to **CAMERA**.
- 2 Slide **IR FILTER** to **ON**.
 - Black and white image appears.
 - You can select color of image B/W, green, or blue (page 23).
 - To cancel this feature, slide **IR FILTER** to **OFF**.

Note

- The subject can be up to 3 m (9 feet) away.

Special Features

Program AE

The Auto Exposure feature can be used to make quality recordings in a variety of scene situations.

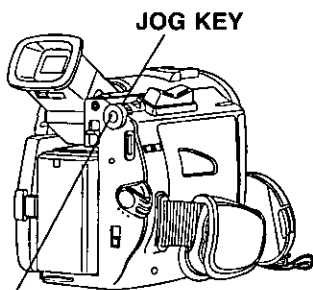

MENU Button

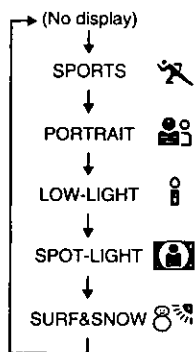

Note

SPORTS mode

- The recorded images will not be so blurred when they are viewed later using slow or still picture playback.
- When playing back a sports mode recording, the movement may appear slightly jerky.
- Do not use this mode when recording under fluorescent, mercury or sodium lighting. These types of lights will affect the color and brightness of the images.
- A vertical band of light might appear when recording objects that are brightly illuminated or which are highly reflective.
- If the amount of light is insufficient, the SPORTS "X" indicator will flash in the EVF or the LCD monitor.
- The image may flicker if this mode is used indoors.

- 1 Set **POWER** to **CAMERA**.
 - The **POWER** lamp lights red.
 - Be sure **POWER** is fully turned to **CAMERA** position.
 - 2 Press **MENU** to display the menu screen.
 - 3 Press **JOG KEY** to select **ADJUST**, and then press **JOG KEY** to display the **CAMERA ADJUST** menu screen.
 - 4 Rotate **JOG KEY** to select **PROG/AE**, and then press **JOG KEY** to select one of the five modes shown below.
 - 5 Repeat steps 4-5 to select OFF to cancel this feature.
- **Sports mode** For recording fast action scenes.
 - **Portrait mode** For recording only subjects in the foreground, while ignoring subjects in the background.
 - **Low-light mode** For recording in extreme low light conditions.
 - **Spot-light mode** Recording in situations where subjects are under a spotlight(s).
 - **Surf & Snow mode** For recording in locations with a high degree of "Dazzle", such as snow slopes and the seashore.

PORTRAIT mode

- The image may flicker if this mode is used indoors.

LOW-LIGHT mode

- Scenes recorded in extremely low light levels may not come out properly.

SPOT-LIGHT mode

- If the recorded subject is extremely bright, the picture may appear whitish.

SURF&SNOW mode

- If the recorded subject is extremely bright, the picture may appear whitish.
- It is not possible to select the SPORTS mode and PORTRAIT mode together with the GAIN UP in the Digital function camera menu.

Other Digital Functions

Use the following features to add interest and professionalism to your recordings or playback. Select from eleven special effects.

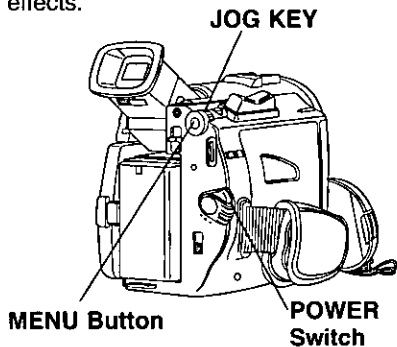

Types of Digital Function

MIRROR

Symmetrical image from the current camera picture.

STROBE

The recording appears as a sequence of still frames.

MOSAIC

The picture appears in a mosaic pattern.

SLIM

The picture is expanded vertically.

TRAIL

The subject being recorded creates a trail when in motion.

STRETCH

The picture is expanded horizontally.

GAIN UP (Not available during playback)

Picture sensitivity is increased.

- Only Manual Focus is available.

WIPE

Successive scenes are separated in a way which simulates the drawing of a curtain.

MIX

The current scene is mixed in with the following scene during scene changes.

SEPIA (Only available during playback)

The picture is played back in sepia, brownish color, giving it an antique look.

MONO (Monotone) (Only available during playback)

The picture is played back in black-and-white.

- 1 Set **POWER** to **CAMERA** or **VCR**.
 - The **POWER** lamp lights red.
 - Be sure **POWER** is fully turned to **CAMERA** or **VCR** position.
- 2 Press **MENU** to display the menu screen.
- 3 Press **JOG KEY** to select **DIFUNCTION** in the **CAMERA** mode menu screen or **PLAY FUNCTION** in the **VCR** mode menu screen, then press **JOG KEY** to display the **CAMERA FUNCTION** or **VCR PLAY FUNCTION** menu screen.
- 3 Rotate **JOG KEY** to select **DIFUNCTION**, and then press **JOG KEY** repeatedly to select one of the Digital Function listed at the left.
- 4 To cancel the Digital Function, press down on **JOG KEY** to select OFF.

Note

- The **EIS** and **Digital Zoom** features are turned off automatically when one of the Digital Functions listed at left is selected.
- Refer to the Types of Digital Effects at the left.

To use the WIPE function:

- a. In Camera mode, set the "D.FUNCTION" item in the main menu screen to "WIPE" (page 24).
- b. Press **RECORD/PAUSE** to start recording.
- c. Press **RECORD/PAUSE** to pause the recording. The last scene will be memorized.
- d. Press **RECORD/PAUSE** to start recording again. The new scene will take the place of the memorized scene.

To use the MIX function:

- a. In Camera mode, set the "D.FUNCTION" item in the main menu screen to "MIX" (page 24). Then, perform steps b-d above.

The memorized scene and the new scene will appear mixed as the scene changes from one to the other.

Note

- When Photo Title is set, **WIPE/MIX** mode becomes Photo Title. Photo Title is finished, Digital Function become OFF.

Special Features

Auto Focus

The Palmcorder automatically adjusts the focus over the entire zoom range.

Manual Focus

Use Manual Focus (MF) when recording ...

- a subject through glass.
- a scene where the subject is far from the Palmcorder and there are objects in the foreground.
- a subject with distinct horizontal stripes.
- a subject not centered in the Viewfinder.
- subjects with shiny surfaces.
- an obliquely angled subject.
- a bright, flat subject such as a white wall.
- in low light situations.
- a scene with fast motions, like a golf swing.

• **Re-focusing may be required** when your Palmcorder is aimed at a new scene.

POWER ZOOM
Button

MANUAL
FOCUS control
wheel

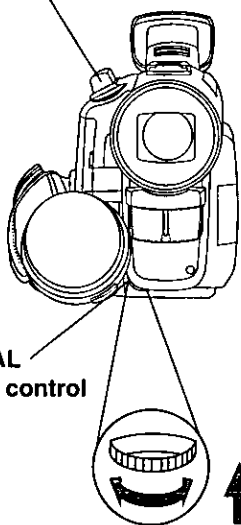

Rotate ②

① Press

1 Press **MANUAL FOCUS control wheel** so that "MF" (Manual Focus) appears in the EVF or the LCD monitor.

EVF/LCD Monitor

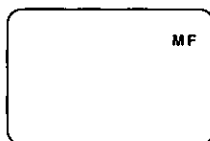

2 Press and hold **POWER ZOOM** to the "T" side (**Full Telephoto**) until the lens is zoomed in all the way (subject at maximum size).

3 Turn **MANUAL FOCUS control wheel** until the picture is in focus.

- It may be necessary to back away from the subject to focus the image properly.

4 Press **POWER ZOOM** to "W" or "T" as desired.

- The subject will remain in focus over the entire zooming range.
- It may be necessary to back away from the subject to focus the image properly.

Macro Focus (for close-ups)

Press the "W" side of **POWER ZOOM** to the wide angle position.

Auto Focus will function with the subject as close as 1 inch (25mm) in front of the lens.

Audio/Video Fade In/Out

This feature allows you to make smoother scene transitions for a more professional look.

FADE Button

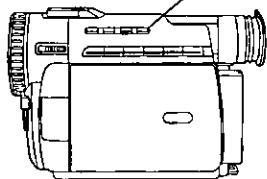

REC/PAUSE Button

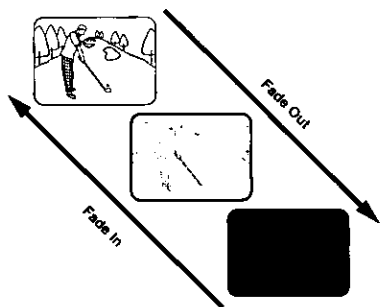
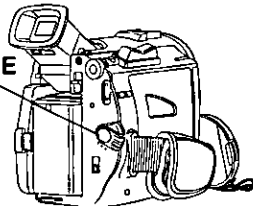

Fade In:

Starting the first scene with "fade in" is very effective.

In Record/Pause mode, hold down **FADE** until the picture fade out.

Then, press **RECORD/PAUSE** to start recording.

Release **FADE** and the picture will gradually fade in.

Fade Out:

Use to create a soft ending or (together with fade in) for a soft transition from one scene to the next.

During recording, hold down **FADE** until the picture and sound fade out.

Then, press **RECORD/PAUSE** to pause the recording.

Backlight

Use when recording a subject that is darker than the surrounding scene, in a shadowed area, or when the light source is in the back of your subject.

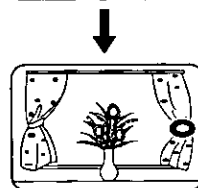
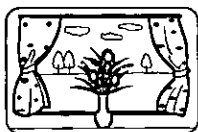

EVF or LCD monitor indication.

Press **BACK LIGHT** to activate the Backlight feature.

The Indicator "●" will appear in the EVF or LCD monitor.

Press **BACK LIGHT** again to cancel the Backlight feature.

BACK LIGHT Button

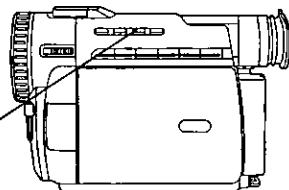

Note

- The Indicator "●" will not appear in the EVF or LCD monitor when OFF is selected in the DISPLAY menu.

Special Features

High Speed Shutter

To record high speed motion (e.g. tennis stroke) for improved STILL or SLOW MOTION playback, when watching the tape on this Camcorder.

Auto Shutter

In the AUTO mode (no indication in the EVF) and LCD monitor, the Camcorder will automatically adjust the shutter speed (up to 1/350).

- AUTO mode is automatically selected whenever the POWER Switch is set to CAMERA.

Manual Selection

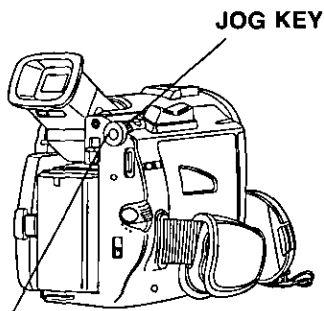

- 1 Press **MENU** to display the camera mode menu in the EVF or the LCD monitor.

- 2 Rotate and press **JOG KEY** to select **ADJUST**, and then rotate and press **JOG KEY** to select **[SHS]**.

- SHUTTER SPEED menu is displayed.

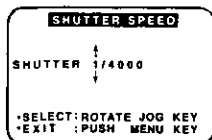

- 3 Rotate **JOG KEY** to obtain one of the following shutter speeds.

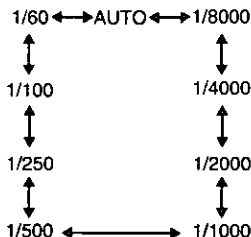

Note

- For proper color reproduction, it is recommended that you use this feature outdoors. For indoor High Speed Shutter recording, additional halogen or tungsten light should be provided. Fluorescent light will degrade the picture quality.
- This feature requires ample light. More light is required for the fastest shutter speeds.
- The Auto Focus system may not operate properly in insufficient light when using the High Speed Shutter.
- When PROG.AE is ON, you cannot manually select the shutter speed.

Audio Dubbing using the External or Built-in Microphone

The original sound can be replaced with new sound using the built-in Palmcorder microphone or an external microphone.

External Microphone with M3 connector (not supplied)

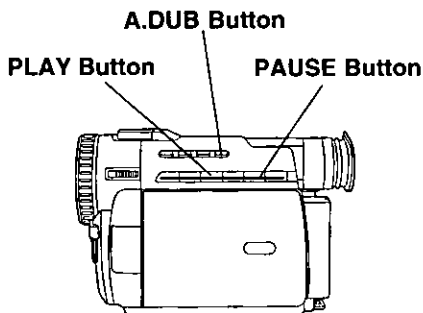
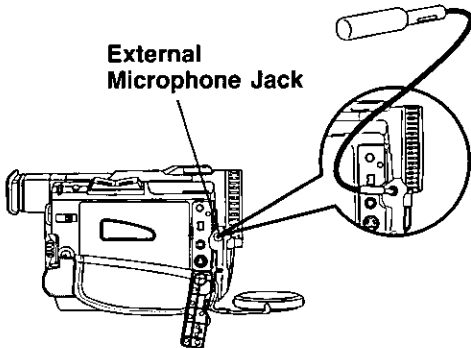

Optional

A.DUB Button

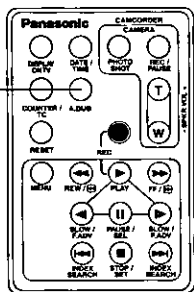

Before you begin...

- Connect the external Microphone (if used).
- Turn On the Palmcorder.
- Insert a pre-recorded tape to be dubbed.

The AUDIO-REC setting in CAMERA MENU mode should be as follows:

12 bit The original sound is recorded on ST (Stereo) 1, and the new sound will be recorded on ST (Stereo) 2.

16bit The original sound is replaced with the new sound.

- Select 12 bit if you do not want the original sound to be completely replaced during an audio dub.
- If you dub over a tape which has both 12 bit and 16bit audio recordings on it, keep in mind that the original 16bit audio portion will be completely replaced.

1

Set **POWER** to **VCR**.

- The POWER lamp lights red.
- Be sure POWER is fully turned to VCR position.

2

Press **PLAY**.

Then press **PAUSE** where you want dubbing to begin.

3

Press **A.DUB** on this unit (for three seconds) or the remote control (optional, page 74) to put the Palmcorder in the Audio Dub mode.

- "A.DUB" flashes in the EVF or the LCD monitor.

EVF/LCD Indication

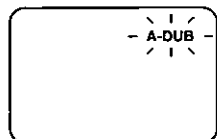

(Continued on next page.)

Copying your Tapes to S-VHS or VHS Cassette

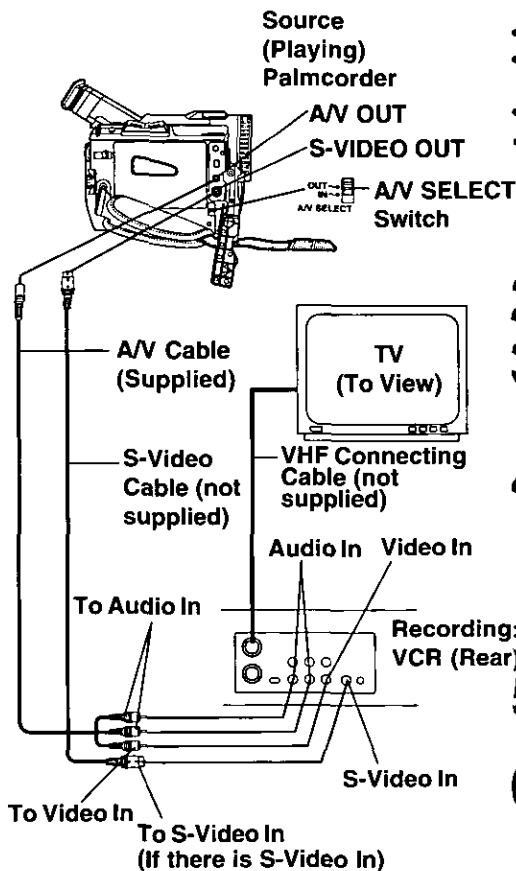

Before you begin...

- Connect both Palmcorder and VCR to their power sources.
- Connect the Palmcorder to a VCR as illustrated below.
- Turn ON both units.
- Set the recording VCR's Input Signal Selector to LINE.
- Set the Palmcorder POWER Switch to VCR.

1 Insert a pre-recorded tape into the source (playing) Palmcorder and a blank tape with record tab in place into the target VCR (Recorder).

2 Set AV SELECT to OUT.

3 Press PLAY on the Palmcorder. When the tape reaches the point you want to start dubbing, press PAUSE.

4 Press REC or simultaneously REC and PLAY (depends on VCR) and then pause the recorder.



VCR Buttons

5 Simultaneously, press PAUSE on both units to begin the copying.

6 Press STOP on both units when copying is completed.

Note

- For technical reasons, dubbing a tape may reduce its quality.
- Press DISPLAY on the Palmcorder remote control (optional, page 74) to eliminate EVF/LCD Monitor indications to be recorded on the tape.
- If the Time Code is displayed in the EVF or LCD monitor, this display cannot be reset.

CAUTION:

Unauthorized exchanging and/or copying of copyrighted recordings may be copyright infringement.

Monitor with your TV

- Turn the TV ON and select its VCR channel (either CH3 or CH4).
- Set the VCR/TV Selector on the recording VCR to VCR.

Special Features

Copying S-VHS or VHS Cassette to your Tapes

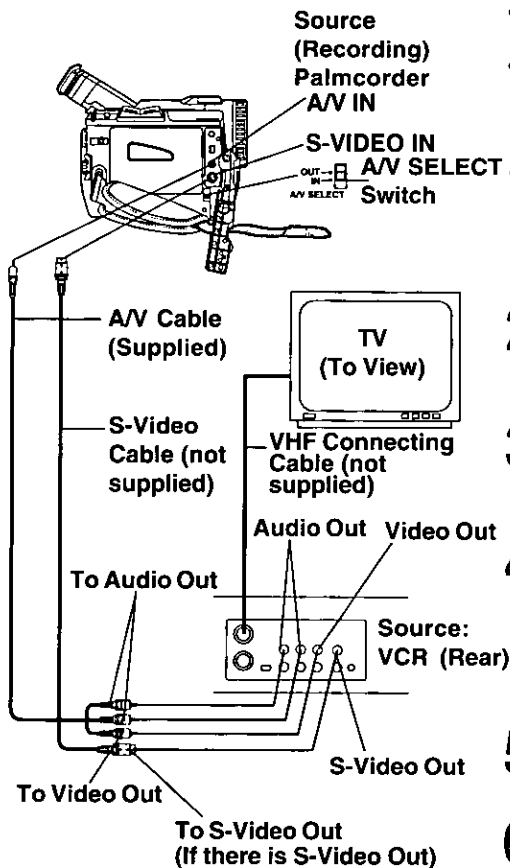

Note

- OSD functions are not displayed on the TV monitor.
- Do not connect A/V with S-Video on a different unit. The picture and sound may be abnormal.
- If both S-Video Cable and A/V Cable are used, the picture will come from the S-Video Cable.
- If only the audio, not the video, is input from the A/V Cable, the audio will not be output from the speaker.
- Do not connect the A/V Cable and S-Video Cable to other devices.
- If a recording is made at the VCR while the counter is displayed, it cannot be reset.
- Depending on the input signal, the closed caption signal may not be able to be recorded normally.

Before you begin...

- Connect both Palmcorder and VCR to their power sources.
- Connect the Palmcorder to a VCR as illustrated below.
- Turn ON both units.

- 1 Insert a pre-recorded tape into the source (playing) VCR and a blank tape with record tab closed in place into Palmcorder.
 - 2 Set **AV SELECT** to **IN**.
 - "LINE-IN" is displayed on the EVF and LCD monitor (page 27).
 - 3 Press **PLAY** on the VCR. When the tape reaches the point you want to start dubbing, press **PAUSE**.
 - 4 Press **REC** and **PLAY** and then pause the Palmcorder.
-
- | | | | | | |
|------|-----|------|----|-------|-----|
| STOP | REW | PLAY | FF | PAUSE | REC |
|------|-----|------|----|-------|-----|
- 5 Simultaneously, press **PAUSE** on both units to begin the copying.
 - 6 Press **STOP** on both units when copying is complete.

CAUTION:

Unauthorized exchanging and/or copying of copyrighted recordings may be copyright infringement.

Copying from Digital Equipment (dubbing)

High quality digital-to-digital copying can be accomplished if both Palmcorders incorporate the digital in/out IEEE 1394 interface (DV interface cable is not supplied).

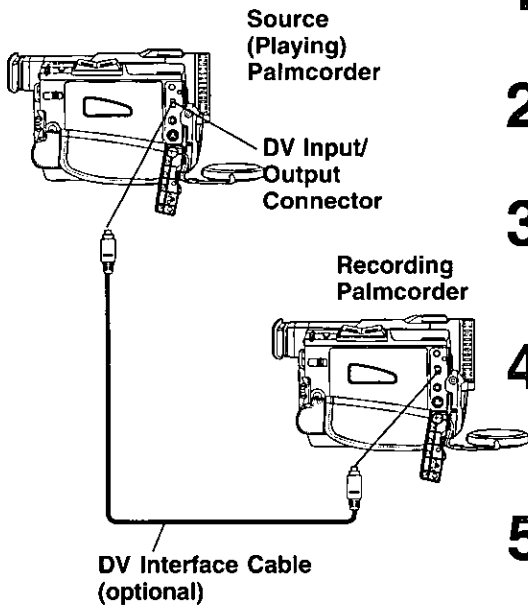

STOP Button PLAY Button PAUSE Button REC Button

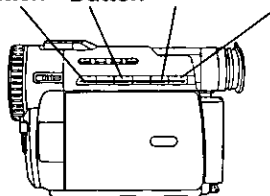

Optional

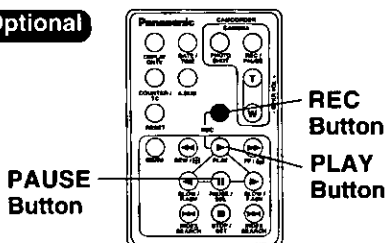

Before you begin...

- Connect both Palmcorders to their power sources.
- Connect the two Palmcorders using the DV interface cable (4-pin to 4-pin).
- Turn both Palmcorders ON.

- 1** Insert a pre-recorded tape into the source (playing) Palmcorder, and set **POWER to VCR**.
- 2** Insert a blank tape with the record tab in place into the target (recording) Palmcorder and set **POWER to VCR**.
- 3** Press **PLAY** on the source Palmcorder. When the tape reaches the point you want to start dubbing, press **PAUSE**.
- 4** Hold down **REC** and press **PLAY** the target (recording) Palmcorder or remote control (optional, page 74). Press **PAUSE** to pause the tape at the starting point of the dub.
- 5** Simultaneously, press **PAUSE Buttons** on both units to begin the dubbing.
- 6** Press **STOP** on recording unit, and then press **STOP** on playing unit to end dubbing.

Note

- When two Palmcorders are used for dubbing, it is recommended that the remote control VCR1 or VCR2 setting should be used to avoid mis-operation.
- When two Palmcorders are connected using the DV interface cable (not supplied), a Video Editing Controller cannot be used.
- Do not connect both an S-Video Cable or A/V Cable and a DV Interface Cable.

CAUTION:

Unauthorized exchanging and/or copying of copyrighted recordings may be copyright infringement.

Special Features

PC Connection with DV Interface Cable (IEEE 1394)

A live image can be transferred directly to your PC (Personal Computer) via a DV Interface Cable (not supplied) using products and software from Digital Origin (formerly Radius) or Canopus.

Using these products allows you to capture live images onto your PC, edit the captured image, etc.

Note:

- For more detailed information, please their web site at:
<http://www.digitalorigin.com/DVP>
<http://www.justedit.com>
- For assistance on Digital Origin products, call **1-800-572-3487**
For assistance on Canopus products, call **1-888-868-2533**

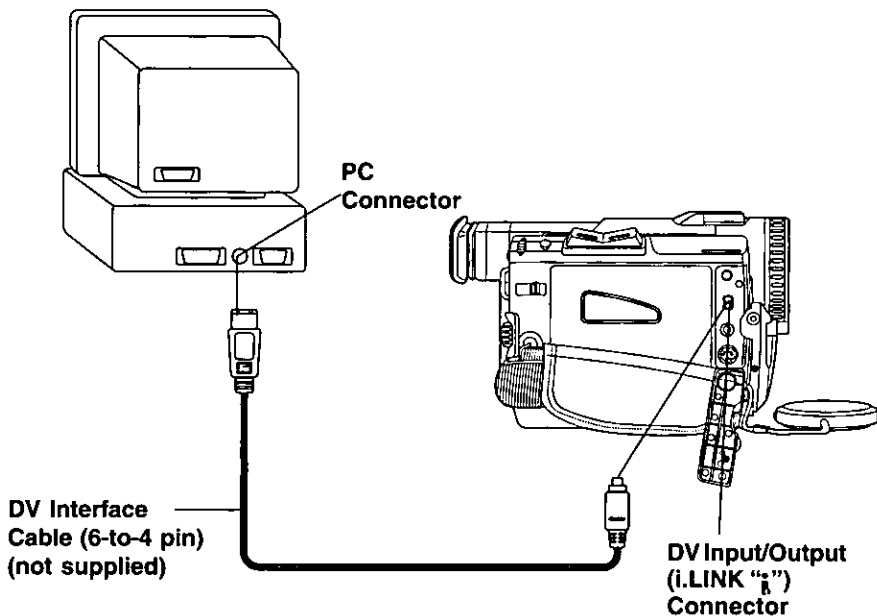

PHOTOVU Link & CARD LINK Driver

An image stored in the DV Tape can be transferred to your PC (Personal Computer).

System Requirements for PHOTOVU LINK & CARD LINK Driver

- IBM PC/AT or compatible.
- Intel® Pentium® Processor
- Microsoft Windows® 95 or Windows® 98
- RAM: 16 MB or more
- 2 MB minimum available hard disk space.
- 256 color monitor (full color recommended).
- 3.5 inch 1.44 MB floppy disk drive (for installation).
- RS-232C serial port (D-Sub 9-pin). An adaptor (D-Sub 9-pin male to a D-Sub female) is required for a D-Sub 25-pin.
- Mouse or other pointing device.

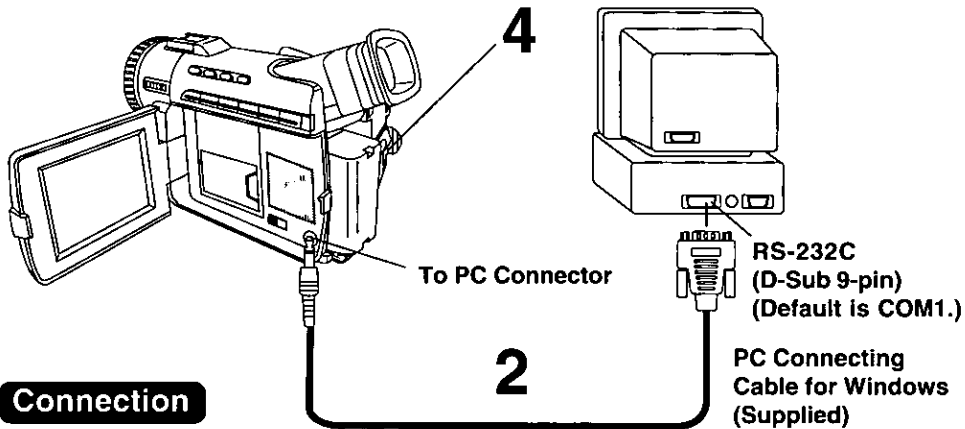

Connection

- 1** Turn off your PC.
- 2** Connect the Digital Video Camcorder to your PC (Windows) using the RS-232C PC connecting cable (supplied).
 - Before connecting the Palmcorder to the PC, make sure the PC power is off to insure that images are transferred properly.
- 3** Turn on your PC.
- 4** Set the Palmcorder POWER to VCR.

Note

- For extended periods of use, it is recommended to use the AC Adaptor as a power source.
- Refer to PC or Windows manual to identify which COM port to be used for connection.

Software Installation (Windows 95/98)

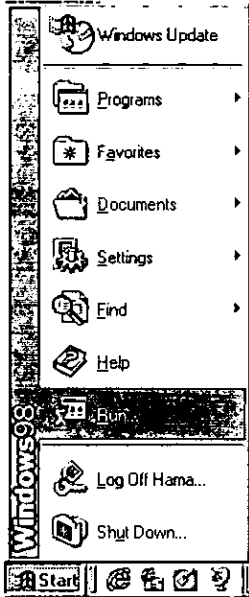

Before you begin...

- Your PC is in the power on mode.

- 1 Turn on PC (Personal computer) and start up Windows.
- 2 Insert **PHOTOVU LINK & CARD LINK DRIVER Disk (Windows 95/98)** into a floppy disk drive.

- 3 Click on Start, then "Run..."

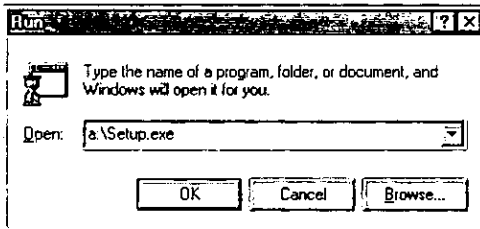

- 4 Type in "a:\setup.exe" and click OK.
 - If your 3.5 inch floppy disk drive is not "A", use appropriate letter.
- 5 Follow instructions as they appear on PC screen until the installation is complete.
 - Setup window will disappear when the installation is complete.

CARD LINK: You can transfer images between the MultiMediaCard and a PC.

Running the Software (Windows 95/98)

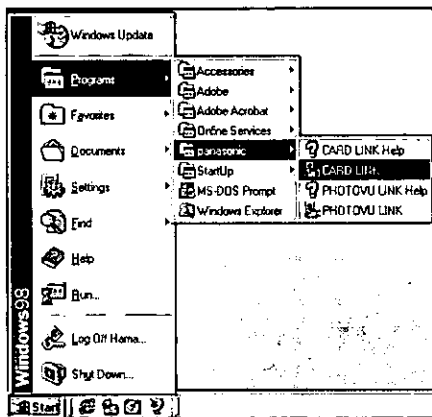

Before you begin...

- Insert the MultiMediaCard (page 9).
- Make Camcorder-PC connections (page 65).
- Turn your PC on.
- Set Camcorder POWER to CAMERA.
- Set TAPE/M-CARD Switch to M-CARD (page 9).

1 Click on Start, "Programs", "panasonic", then "CARD LINK".

2 "CARD LINK" is opened.

Note

- COM Port and Baudrate are automatically selected.

Refer to Help for information about application operations and other Error messages.

CARD LINK

Using MultiMediaCard Image Data

Pictures captured with Camcorder can be transferred to your PC.

Before you begin...

- Insert the MultiMediaCard (page 9).
- Make Camcorder-PC connections (page 65).
- Turn your PC on.
- Set Camcorder POWER to CAMERA.
- Set TAPE/M-CARD Switch to M-CARD (page 9).

1 Repeat step 1 and 2 on page 67 to run the Software.

2 "Preview Window" screen appears automatically.

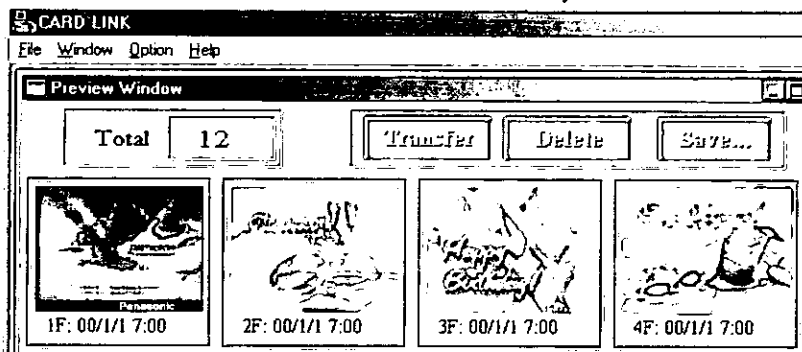

3 Select the image data you want to transfer to your PC.

- The selected image will be underlined in green.

4 Click on:
Transfer

- The picture image is transferred to your PC and displayed. Transfer Dialog will appear on the PC. The image is captured when the full screen image appears on the PC.

Delete

- Confirmation Dialog will appear on the PC. Click "OK". A image of the MultiMediaCard is deleted.

Save

- The picture image is transferred to your PC and displayed. Save window appears. [File Save] dialog box appears.

Note

- If, while transferring the image to your PC, the displayed picture appears abnormal, restart the PC application and turn Camcorder POWER off, and then back on.

Using PC Image Data

You can use JPEG or Bitmap files for Photo Title (page 48) from your computer by transferring them to the Camcorder via PC connection.

Before you begin...

- Insert the MultiMediaCard (page 9).
- Make Camcorder-PC connections (page 65).
- Turn your PC on.
- Set Camcorder POWER to CAMERA.
- Set TAPE/M-CARD Switch to M-CARD (page 9).

1 Repeat step 1 and 2 on page 67 to run the Software.

2 "Preview window" screen appears automatically.

3 Click on "File", then Click on "Open".
 • At your computer, please select and open the data (.jpg or .bmp) you want to transfer to the Camcorder.

4 Click on "File", then select "Data out to camera", then select Fine or Normal mode.

- DATA TRANSFER screen appears.
- Your computer image data is transferred to the Camcorder.

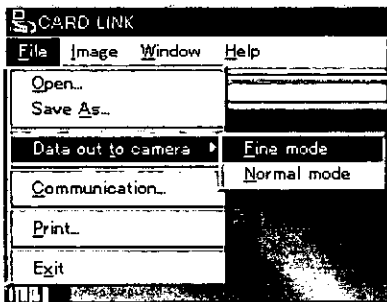
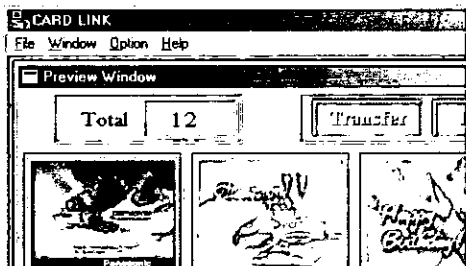

PHOTOVU LINK

PHOTOVU LINK: You can transfer images from your Camcorder tape to a PC.

Running the Software (Windows 95/98)

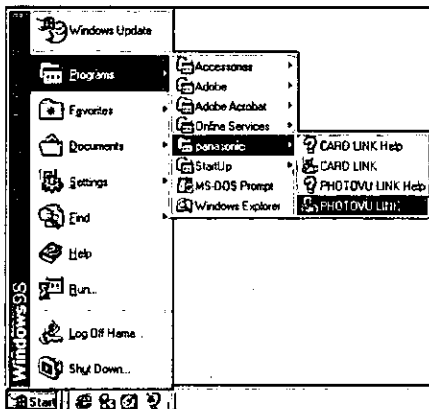

Before you begin...

- Insert the Tape (page 8).
- Make Camcorder-PC connections (page 65).
- Turn your PC on (page 65).
- Set Camcorder POWER to VCR.
- Set TAPE/M-CARD Switch to Tape (page 8).

1 Click on Start, "Programs", "panasonic", then "PHOTOVU LINK".

2 "PHOTOVU LINK" is opened.

Note

- COM Port and Baudrate are automatically selected.

Refer to Help for information about application operations and other Error messages.

Using Tape Image Data

An image stored in the DV Tape can be transferred directly to your PC via an RS-232C connection.

Before you begin...

- Insert the Tape (page 8).
- Make Camcorder-PC connections (page 65).
- Turn your PC on (page 65).
- Set Camcorder POWER to VCR.
- Set TAPE/M-CARD Switch to Tape (page 8).

1 Repeat step 1 and 2 on page 70 to run the Software.

2 “Preview Window” screen appears.

3 Search and Select a video footage or a scene you want to transfer to your PC using VCR Operation Buttons on the “Preview window” screen. Then click on “Transfer” to transfer selected image from camcorder to “Preview Window” in PLAY or STILL mode.

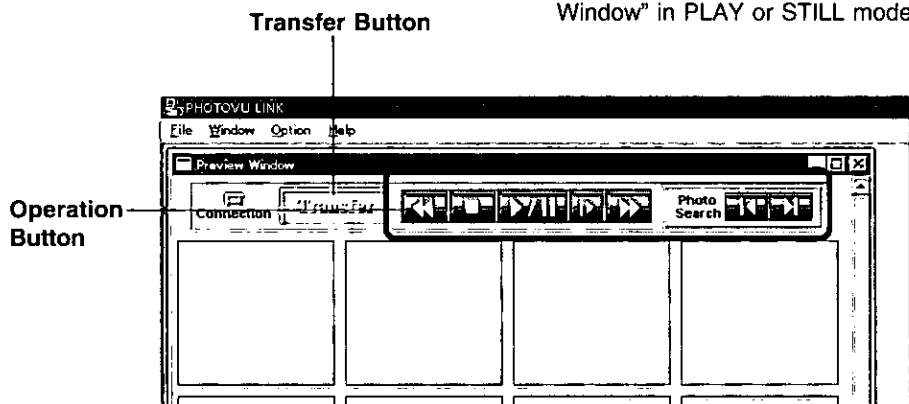

4 Save Transferred image to PC. Click on “File” then “Save As”.

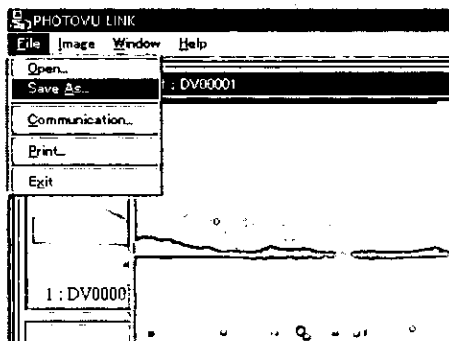

Note

- If, while transferring the image to your PC, the displayed picture appears abnormal, close PHOTOVU LINK and turn Camcorder POWER off, and reset PHOTOVU LINK, and turn Camcorder Power ON.
- Photo Search may fail to detect a recorded PhotoShot image if the image is 3 seconds or less.

Adobe® PhotoDeluxe™ HE 3.0

Plug-in Driver for Adobe® PhotoDeluxe™ HE 3.0

The Plug-in Driver allows interface between Camcorder and PhotoDeluxe HE 3.0 application.

Note

Install Adobe PhotoDeluxe HE 3.0 before proceeding.

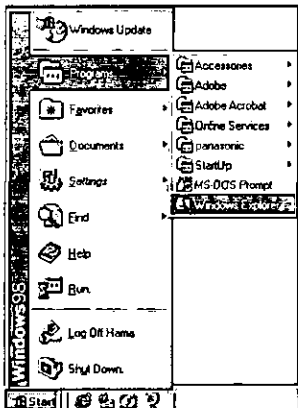

1 Turn on PC (Personal computer) and start up Windows.

2 Insert Plug-in Driver disk into Drive A.

3 Select "Start", "Program", then "Windows Explorer".

4 Copy "\Plug-in\DVPalmcorder.8ba" file to "PhotoDeluxe 3.0\PlugIns" folder.

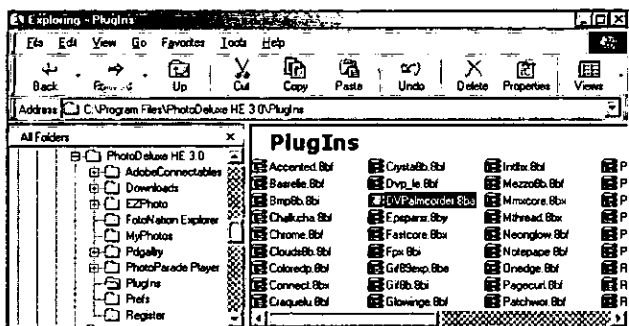
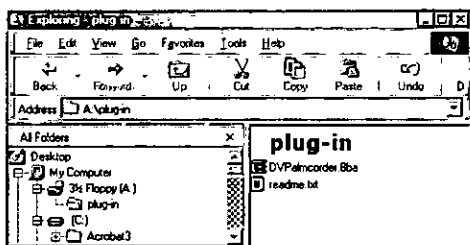

Printer Connection

Using the Digital Photo Printer

You can print out images by using a digital Photo Printer (Optional).

Before you begin...

- Connect both Palmcorder and Digital Photo Printer to their power sources.
- Connect the Palmcorder and Digital Photo Printer using a A/V cable (supplied) or S-Video Cable (not supplied).
- Connect the Digital Photo Printer and your TV using a Video cable (not supplied) and turn the TV on.
- If different video sources are connected simultaneously to the S-VIDEO IN Socket and the VIDEO IN Socket, the video for S-VIDEO IN Socket takes precedence.
- To listen to sound from the Palmcorder, connect the audio output from the Palmcorder directly to the television AUDIO IN socket.
- Please refer to the printer's operating instructions for detail on printing.

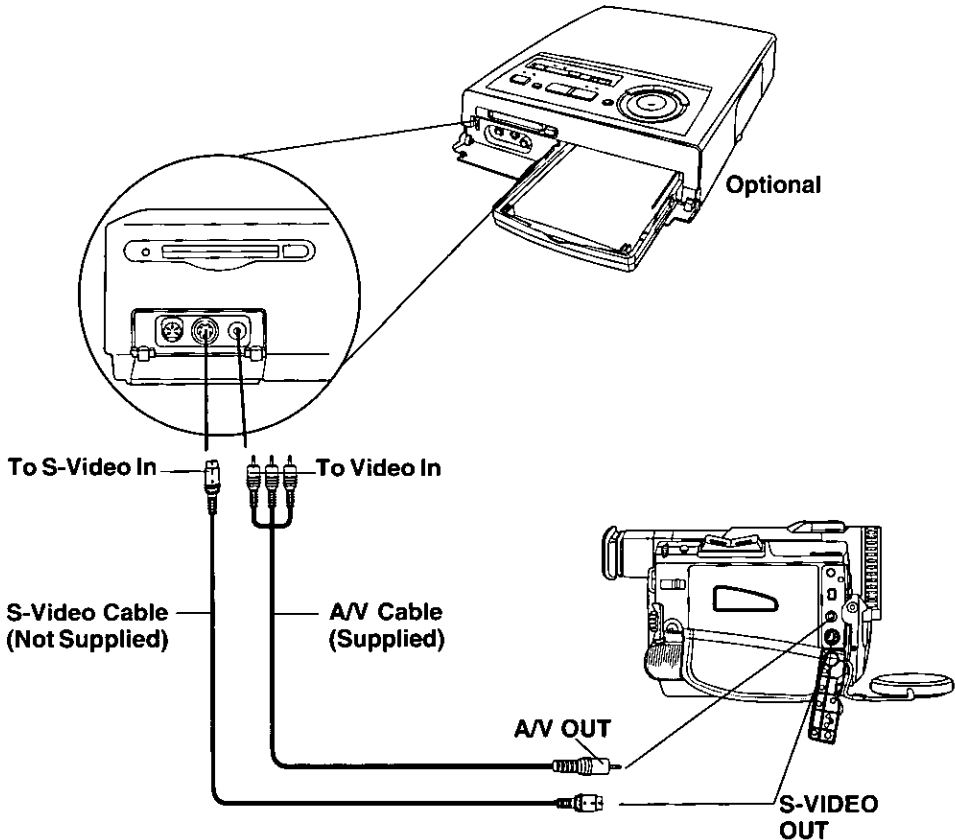

Palmcorder Accessory System

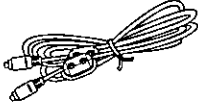
Accessory #	Figure	Description	Price
PV-DAC10		AC Adaptor with AC Cable and DC Cable	\$140.00
CGR-D120A/1B (Same as PV-DBP8/DBP8A)		800mAh / 1 h 15 min Battery Pack	\$60.00
CGR-D220A/1B (Same as PV-DBP9/DBP9A)		1600mAh / 2 h 50 min Battery Pack	\$100.00
CGR-D815A/1B		5300mAh / 9 h Battery Pack	\$200.00
PV-DDC9		DV Interface Cable (4-pin to 4-pin)	\$45.00
PV-DLT9		Color Enhancement Light	\$ 39.95
PV-DRC9		IR Remote Control	\$ 29.95
PV-PD2100		Digital Video Printer	\$599.95

Palmcorder Accessory Order Form

Please photocopy this form when placing an order.

1. Palmcorder Model # _____

2. Items Ordered

Accessory #	Description	Price Each	Quantity	Total Price
Subtotal				
Your State & Local Sales Tax				
Shipping & Handling				5.00
Total Enclosed				

3. Method of payment (check one)

- Check of Money Order enclosed (NO C.O.D.SHIPMENTS)
- VISA Credit Card # _____
- MasterCard Expiration Date _____
- Discover Customer Signature _____

Make Check or Money Order to: MATSUSHITA ACCESSORIES

(Please do not send cash)

4. Shipping information (UPS delivery requires complete street address)

Ship To:

Mr.

Mrs.

Ms.

First _____ Last _____

Phone #:

Day () _____

Street Address _____

Night () _____

City _____ State _____ Zip _____

TO OBTAIN ANY OF OUR OMNIMOVIE/PALMCORDER ACCESSORIES YOU CAN DO ANY OF THE FOLLOWING:

VISIT YOUR LOCAL PANASONIC DEALER

OR

CALL PANASONIC'S ACCESSORY ORDER LINE AT 1-800-332-5368

[6 AM-5 PM M-F, 6 AM-10:30 AM SAT, PACIFIC TIME]

OR

MAIL THIS ORDER TO: PANASONIC SERVICES COMPANY ACCESSORY ORDER OFFICE
20421 84th Avenue South Kent, WA. 98032

For Your Information

Notes On Operations

Cleaning EVF (Electronic Viewfinder)

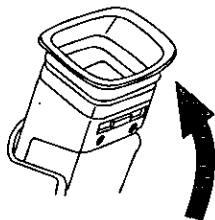

1 Slide the Viewfinder backward to its fully expanded position and then tilt it upward.

2 Remove the EVF Eyepiece 2 screws with a screwdriver (+).

3 Turn the Eyepiece counterclockwise 1/8 of a turn.

4 Pull the Eyepiece free.
Remove any lint or dust particles with a soft clean cloth being careful not to scratch the glass surfaces.

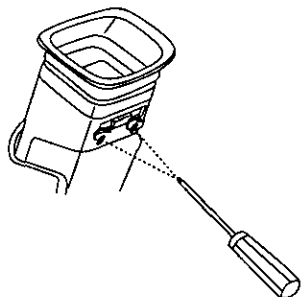

5 To re-install the Eyepiece

Line up the marks on the Eyepiece with the grooves inside the EVF shaft and attach. Turn it clockwise 1/8 of a turn to lock in place.

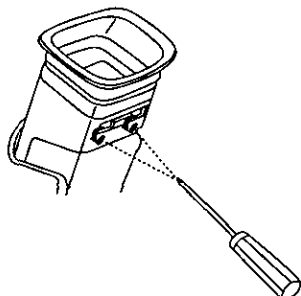

6 Replace the EVF Eyepiece screws and tighten with a screwdriver.

- If you lose EVF Eyepiece screw, order Part No.XQN2+BV4FXK for replacement.

Notes On Operations

Rough Values of Brightness

Your Palmcorder has been designed for normal scene illumination of 150 footcandles (1500 lx). However, the Palmcorder may be used at F1:1.6, if illumination is more than 0.5 footcandles (5 lx).

The table below shows the color temperature for reference.

PALMCORDER SETTINGS	NATURAL LIGHT CONDITIONS	KELVIN COLOR TEMPERATURE	ARTIFICIAL LIGHT SOURCE	COLOR/TINT MIXTURE
	• Fair weather, blue sky	— 10,000	• Color television	Bluish
	• Slightly cloudy sky	— 8,000	• Fluorescent lamp (Daylight) • Camera flash bulb	
	• Cloudy or rainy sky	— 7,000		
	• Sunlight in clear weather at midday	— 6,000	• Blue lamp for photography	Whitish
	• Average sunlight in clear weather	— 5,500		
	• Sunlight 2 hours after sunrise and before sunset	— 5,000	• Fluorescent lamp (White)	
		— 4,500	• Normal flash bulb	
		— 4,000	• Fluorescent lamp (Off-white)	
	• Sunlight 40 min. after sunrise and before sunset	— 3,200	• Tungsten lamp for photography	Yellowish
	• Sunlight 30 min. after sunrise and before sunset	— 2,800	• Halogen lamp	
	• Sunlight 20 min. after sunrise and before sunset	— 2,800	• Iodine lamp	
	— 2,000	• Tungsten lamp		
	— 2,000	• Acetylene lamp	Reddish	
	— 2,000	• Kerosene lamp		
	— 2,000	• Candlelight		

Specifications

Power Source:	Digital Video Camera: 7.2V DC (Battery) 7.8V DC (AC Adaptor) AC Adaptor: 110/120/220/240V AC, 50/60 Hz Battery: Lithium-Ion Type DC 7.2V
Power Consumption:	Digital Video Camera: 7.2V DC 6.5W (Max. 9.5W) AC Adaptor: 18W 1W (when not in use.)
Video Signal:	EIA Standard (525 lines, 60 fields) NTSC color signal
Video Recording System:	2 rotary heads. helical scanning system
Audio:	12bit (32kHz) 4 tracks 16bit (48kHz) 2 tracks
Pick-Up System and Device:	One integral color filter Charge Coupled Device (CCD)
Lens:	18:1 zoom lens, F1:1.6 with auto iris control Focal length: 3.9mm - 70.2mm Power zoom function Lens filter diameter: 49mm
Viewfinder:	0.44 inch (12.7mm) Electronic Viewfinder
LCD Monitor:	3.0 inch (76.2mm) Liquid Crystal Display
Minimum Illumination Required:	5 lx (F1:1.6) 0.5 footcandles 0 lx (IR Filter ON)
Operating Temperature:	32°F~104°F (0°C~40°C)
Operating Humidity:	10%~75%
Weight:	Digital Video Camera: 1.52 lbs. 0.69 kg AC Adaptor: 0.4 lbs. 0.18 kg
Dimensions:	Digital Video Camera: 3-3/8 (W) x 4-1/4 (H) x 6-3/8 (D) inch 85 (W) x 107.5 (H) x 163 (D) mm AC Adaptor: 4 (W) x 1-5/8 (H) x 3-1/8 (D) inch 103 (W) x 40 (H) x 79 (D) mm

Weight and dimensions shown are approximate.
Designs and specifications are subject to change without notice.

Before Requesting Service

Cleaning Care for Video Heads

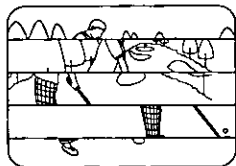

Clogged Video

Head

(a) Video Head Cleaning: Normally, your Palmcorder will not require head cleaning. However, it is possible that the heads may become clogged due to dust in the air, damaged tape, long term use, etc. If "NEED HEAD CLEANING" appears for 5 seconds in the EVF or LCD monitor, the heads may require cleaning.

(b) Cleaning the Heads: It is recommended that head cleaning be performed by a qualified service technician. Please contact your nearest Panasonic Service Center. An alternate solution is to obtain a head cleaning cassette. Please use Panasonic cleaning cassette (AY-DVMCL). Be sure to follow the cleaning instructions carefully. Excessive use of the cleaning cassette could shorten head life.

Use this cassette only when a head clogging symptom occurs.

Refer servicing to qualified service personnel.

Caution for Tape Operations

- When you go from function to function (PLAY, FF, REW etc.), please note that the unit will not accept a new function operation until the previous operation is complete.
- The POWER Button, and all function buttons, (PLAY, FF, REW, etc.) are only operational after the tape has been completely loaded.

Lens Hood Area Operation Caution

- With a Wide or Telephoto Conversion Lens (optional) attached, the four corners of the screen may darken when zoom is set to maximum wide angle.
- Attaching the lens hood, a Wide or Telephoto conversion lens (optional), etc. after a filter (optional) has been attached, the four corners of the screen may darken when zoom is set to maximum wide angle.
- With two filters (optional) attached, the four corners of the screen may darken when zoom is set to maximum wide angle.

Self Diagnostic System

If any of the following numbers appear on-screen, the camcorder may have a problem. Do not remove the battery (if attached) and write down the displayed number on page 80. Then, take the camcorder to a service center for repair.

Error No.	Description
U11	Card Error
U12	Card Error
U13	Card Error
U14	Card/Camcorder Dialogue Error
U15	No Card Memory
U16	Captured image limit exceeded
U17	Captured image limit exceeded
U30	Error other than above

Before Requesting Service

If you have a problem with your Palmcorder, it may be something you can correct yourself. Check the list below for symptoms and corrections.

Symptom	Correction
No picture in the EVF or LCD Monitor ...	<ul style="list-style-type: none">• Make sure the Power Source is connected. (pp. 12, 13)• Make sure the POWER switch is set to ON. (pp. 30, 35)• Check the Dew Indicator. (p. 29)• Make sure the battery is fully charged. (p. 11)• Make sure all necessary cables are connected correctly and firmly. (p. 13)
Video cassette can't be inserted ...	<ul style="list-style-type: none">• Make sure the Lens Cap is removed. (p. 30)• Make sure the Power Source is connected. (pp. 12, 13)
Video cassette can't be removed ...	<ul style="list-style-type: none">• Insert the cassette with the window side facing up. (p. 8)
No operation starts when operation buttons are pressed ...	<ul style="list-style-type: none">• Make sure the Power Source is connected. (pp. 12, 13)
Recording cannot be done ...	<ul style="list-style-type: none">• Check the Dew Indicator. (p. 29)• Make sure the record tab is closed. (p. 15)• Check the Battery Indicator. (p. 26)
Auto Focus does not operate ...	<ul style="list-style-type: none">• Make sure the FOCUS is set to AUTO. (p. 56)• Make sure the unit is ON with CAMERA mode. (p. 30)
Sound from microphone can't be monitored ...	<ul style="list-style-type: none">• Make sure the unit is set to REC or Record/Pause mode.
Sound can't be heard ...	<ul style="list-style-type: none">• Make sure the Audio on the VCR MENU is set to ST1. (pp. 25, 60)

Request for Service Notice

Please photocopy this form when making a request for service notice.

Request for Service Notice:

In the unlikely event this product needs service.

- Please include your **proof of purchase**. (Failure to do so will delay your repair.)
- To further speed your repair please provide an explanation of what is wrong with the unit and any symptom it is exhibiting.

Mail this completed form and your Proof of Purchase along with your unit to:
Panasonic Services Company
1705 N. Randall Road
Elgin, IL. 60123-7847
Attn: Camcorder Repair

Please write the displayed Self Diagnostic number here.
(page 79)

Index of Controls

Front View

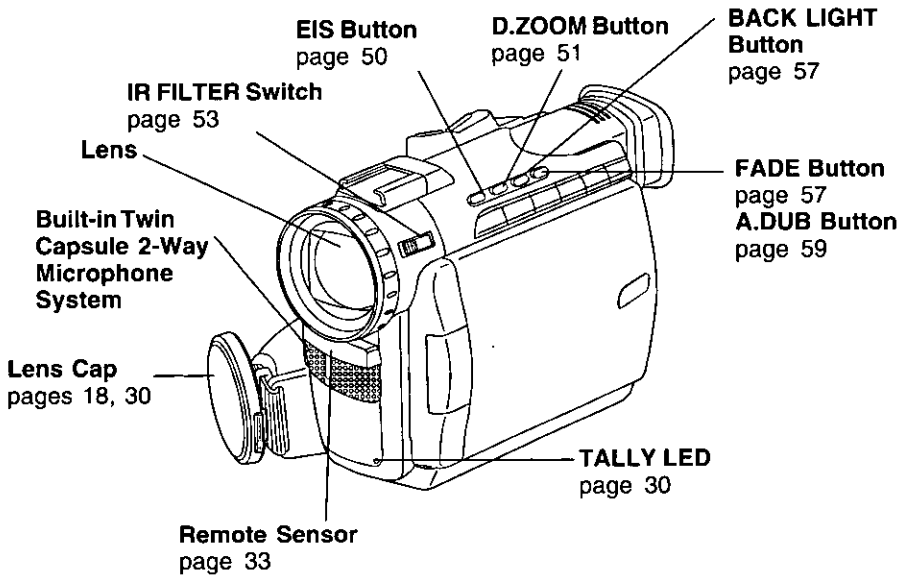

Side View

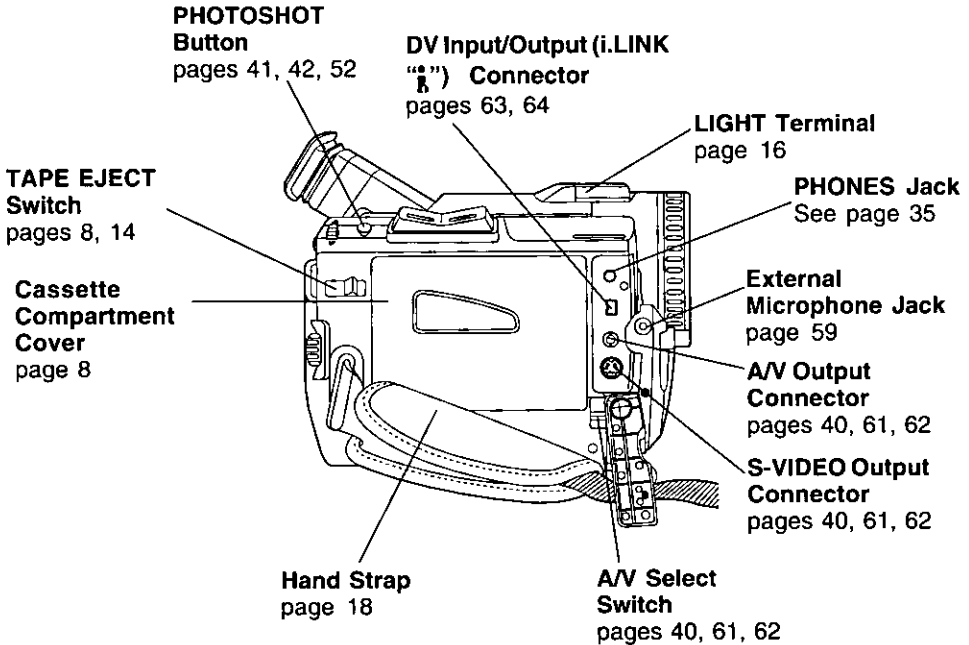

Index of Controls

Rear View

Electronic Viewfinder (EVF)
pages 8, 9, 26, 27, 28, 29

Menu Button
pages 19, 20

**POWER ZOOM
Button**
pages 51, 56

**Vision Adjustment
Control**
pages 9, 30

**Battery Release
Button**
pages 12, 13

**Shoulder Strap
Attachment Ring**
page 17

JOG KEY
pages 19, 20
VOLUME KEY
page 35

POWER Switch
pages 8, 9, 10

**TAPE/M-CARD
Switch**
pages 8, 9, 41,
42, 43, 48

POWER Lamp
page 30

**REC/PAUSE
Button**
pages 9, 30

Rear View

**LCD (Liquid Crystal
Display) Monitor**
pages 9, 10, 26, 27,
28, 29

Built-in Speaker
page 35

LCD-OPEN Button
pages 9, 10, 35

M-CARD Door
page 9

**CARD EJECT
Switch**
page 9

To PC Connector
page 65

DC IN Terminal
page 13

Index of Controls

Side View

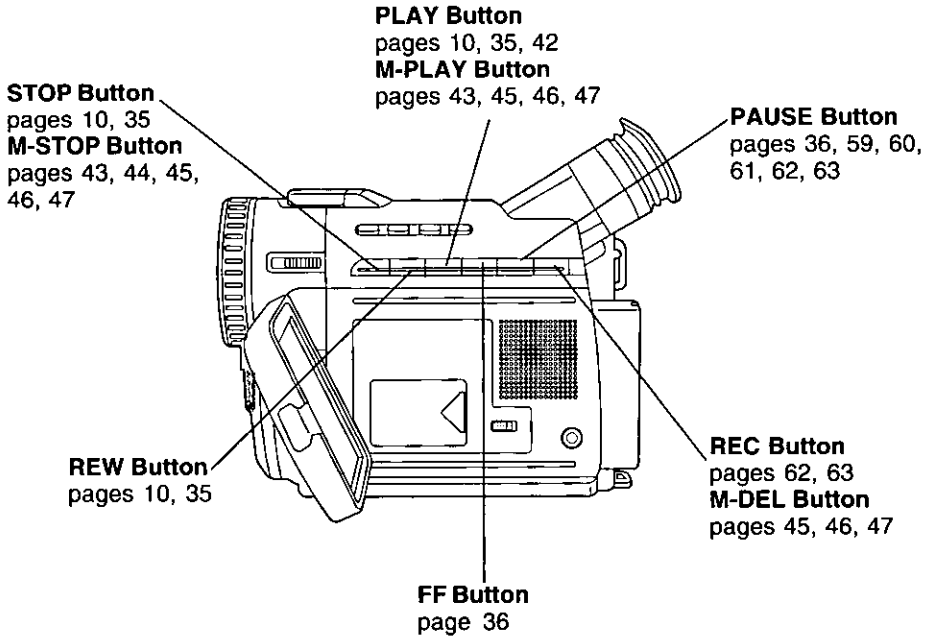

Underside View

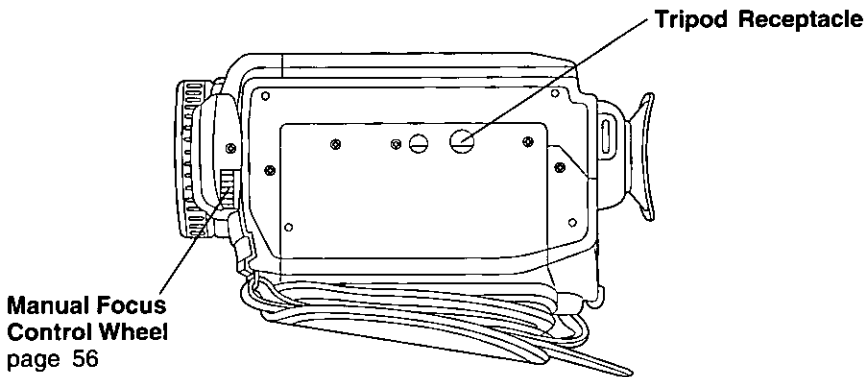

Index of Controls

Color Enhancement Light



**LIGHT RELEASE
Button**
page 16

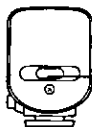

LIGHT Button
page 16

AC Adaptor

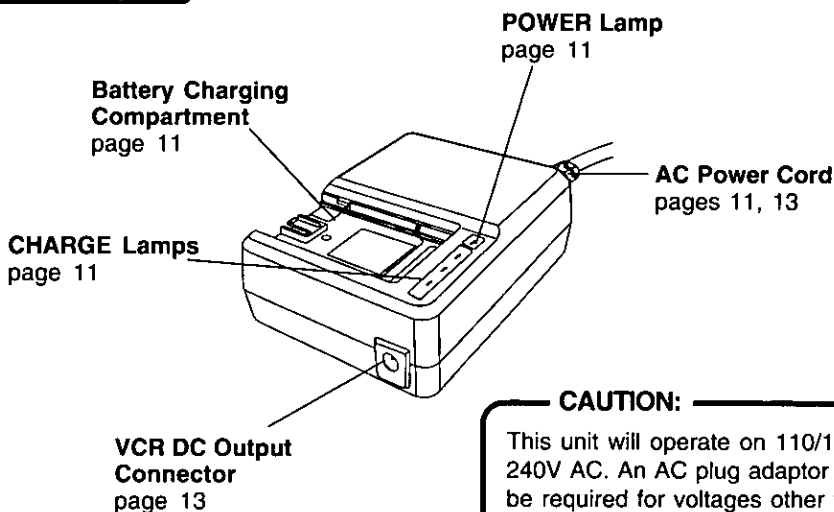

CAUTION:

This unit will operate on 110/120/220/240V AC. An AC plug adaptor may be required for voltages other than 120V AC. Please contact either a local or foreign electrical parts distributor for assistance in selecting an alternate AC plug. We recommend using the accessory power plug adaptor (VJSS0070) in an area which has special AC outlets.

Remote Control (Optional)

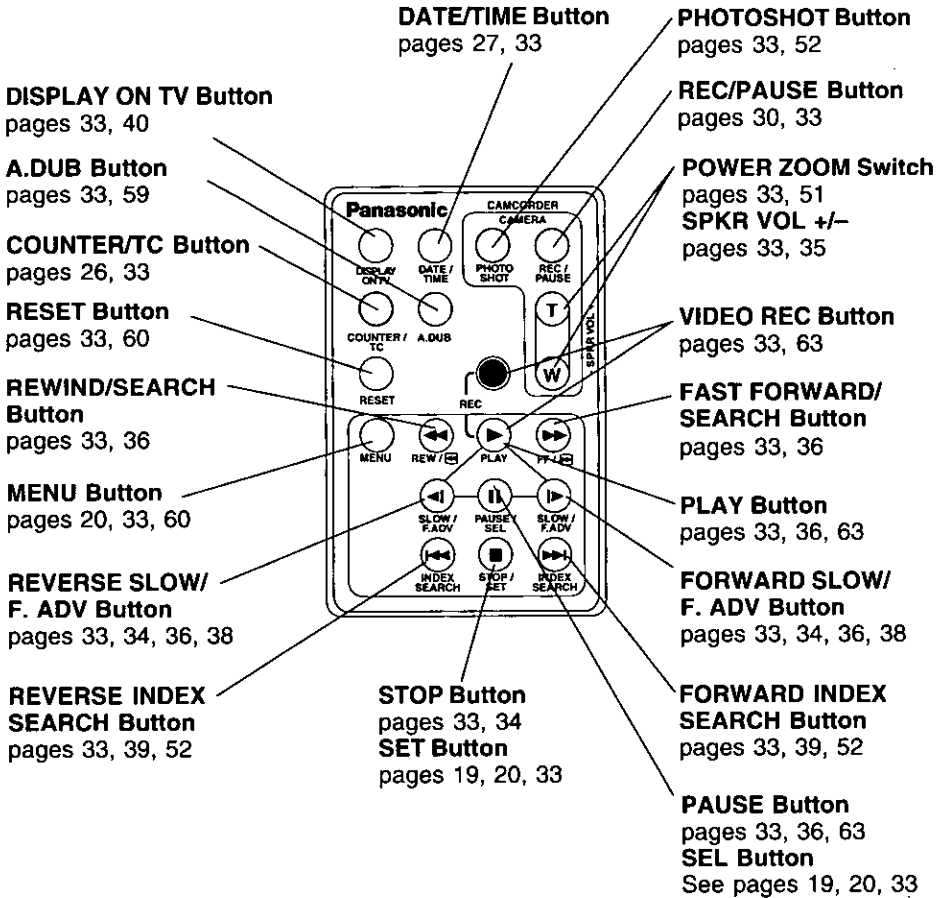

Warranty

Panasonic Consumer Electronics Company, Division of Matsushita Electric Corporation of America
One Panasonic Way Secaucus, New Jersey 07094

Panasonic Sales Company, Division of Matsushita Electric of Puerto Rico, Inc.
Ave. 65 de Infantería. Km. 9.5
San Gabriel Industrial Park, Carolina, Puerto Rico 00985

PANASONIC/QUASAR Video Products Limited Warranty

Panasonic Consumer Electronics Company or Panasonic Sales Company (collectively referred to as "the Warrantor") will repair this product with new or refurbished parts, free of charge, in the USA or Puerto Rico, in the event of a defect in materials or workmanship as follows (all time periods commence from the date of the original purchase):

PRODUCT	PARTS	LABOR
CAMCORDER	ONE (1) YEAR, EXCEPT CCD IMAGE SENSOR CCD IMAGE SENSOR - SIX (6) MONTHS	NINETY (90) DAYS NINETY (90) DAYS
VCR	ONE (1) YEAR	NINETY (90) DAYS
AV MIXER	ONE (1) YEAR	NINETY (90) DAYS
MONITOR-VCR	ONE (1) YEAR, EXCEPT CRT CRT - TWO (2) YEARS	NINETY (90) DAYS CRT- NINETY (90) DAYS CUSTOMER PAYS ALL LABOR CHARGES AFTER 90 DAYS

**Monitor-VCR In-home or carry-in Service: 22" (diagonal) CRT / LCD and Larger
Monitor-VCR Carry-in Service: 21" (diagonal) CRT / LCD and smaller**

Batteries (if included) - New rechargeable batteries in exchange for defective rechargeable batteries for ten (10) days. Non-rechargeable batteries are not warranted.

Tape (if included) - New video cassette tape in exchange for a defective video cassette tape for five (5) days.

In-home, carry-in or mail-in service, as applicable, in the USA can be obtained during the warranty period by contacting a Panasonic Services Company (PASC) Factory Service Center listed in the Service Directory. Or call toll free 1-800-211-PANA(7262), to locate an authorized PASC Service Center. Carry-in or mail-in service in Puerto Rico can be obtained during the warranty period by calling the Panasonic Sales Company telephone number listed in the Service Center Directory.

This warranty is extended only to the original purchaser. A purchase receipt or other proof of the date of the original purchase is required before warranty service is rendered.

This warranty only covers failures due to defects in materials and workmanship which occur during normal use and does not cover normal maintenance, including, but not limited to, video and audio head cleaning. The warranty does not cover damage which occurs in shipment, or failures which are caused by products not supplied by the warrantor, or failures which result from accident, misuse, abuse, neglect, mishandling, misapplication, alteration, modification, faulty installation, set-up adjustments, improper antenna, inadequate signal pickup, maladjustment of consumer controls, improper operation, power line surge, improper voltage supply, lightning damage, commercial use such as hotel, office, restaurant, or other business or rental use of the product, or service by anyone other than a PASC Factory Service Center or a PASC authorized Service Center, or damage that is attributable to acts of God.

LIMITS AND EXCLUSIONS

There are no express warranties except as listed above. THE WARRANTOR SHALL NOT BE LIABLE FOR INCIDENTAL OR CONSEQUENTIAL DAMAGES (INCLUDING, WITHOUT LIMITATION, DAMAGE TO TAPES) RESULTING FROM THE USE OF THIS PRODUCTS, OR ARISING OUT OF ANY BREACH OF THE WARRANTY. ALL EXPRESS AND IMPLIED WARRANTIES, INCLUDING THE WARRANTIES OF MERCHANTABILITY AND FITNESS FOR PARTICULAR PURPOSE, ARE LIMITED TO THE APPLICABLE WARRANTY PERIOD SET FORTH ABOVE. Some states do not allow the exclusion or limitation of incidental or consequential damages, or limitations on how long an implied warranty lasts, so the above exclusions or limitations may not apply to you.

This warranty gives you specific legal rights and you may also have other rights which vary from state to state.

If a problem with this product develops during or after the warranty period, you may contact your dealer or Service Center. If the problem is not handled to your satisfaction, then write to the Customer Satisfaction Center at the Panasonic Consumer Electronics Company address above.

SERVICE CALLS WHICH DO NOT INVOLVE DEFECTIVE MATERIALS OR WORKMANSHIP AS DETERMINED BY THE WARRANTOR, IN ITS SOLE DISCRETION, ARE NOT COVERED. COSTS OF SUCH SERVICE CALLS ARE THE RESPONSIBILITY OF THE PURCHASER.

warvid 10/20/97

Warranty

For Product Information, operating Assistance, Literature Request, Dealer Locations, and all Customer Service inquiries please contact:
1-800-211-PANA(7262), Monday-Friday 9am-9pm Saturday-Sunday 9am-7am, EST.

Web Site: <http://www.panasonic.com>

You can purchase parts, accessories or locate your nearest service center by visiting our Web Site.

Accessory Purchases:

1-800-332-5368 (Customer Orders Only)

Panasonic Service Company 20421 84th Avenue South, Kent, WA 98032
(6 am to 5 pm Monday - Friday; 6 am to 10:30 am Saturday; PST)
(Visa, Master Card, Discover Card, American Express, Check)

Product Repairs

Centralized Factory Service Center

MAIL TO : Panasonic Services Company
1705 N. Randall Road,
Elgin, IL 60123-7847

Attention: Digital Camera Repair

Please carefully pack and ship, prepaid and insured, to the Elgin centralized repair Factory Service Center. While there will be added handling delays, you may bring your unit to one of the following locations who will then forward the unit to Elgin for repair.
Customer's in Puerto Rico, please ship or carry in to location below ("Service in Puerto Rico").

Factory Service Center Locations

CALIFORNIA

550 Katella Avenue
Cypress, CA 90630

800 Dubuque Avenue
S. San Francisco,
CA 94080

20201 Sherman Way
Suite 102
Canoga Park, CA 91306
3878 Ruffin Road
Suite A
San Diego, CA 92123

COLORADO

1640 South Abilene
Street Suite D
Aurora, CO 80012

FLORIDA

3700 North 29th Avenue
Suite 102
Hollywood, FL 33020

GEORGIA

8655 Roswell Road
Suite 100
Atlanta, GA 30350

ILLINOIS

9060 Golf Road
Niles, IL 60714
1703 North Randall Road
Elgin, IL 60123
(Pick-up / Drop-off only)

MARYLAND

62 Mountain Road
Glen Burnie MD 21061

MASSACHUSETTS

60 Glacier Drive,
Suite G
Westwood, MA 02090

MICHIGAN

37048 Van Dyke Avenue
Sterling Heights, MI
48312

MINNESOTA

7850-12th Avenue South
Airport Business Center
Bloomington, MN 55425

OHIO

2236 Waycross Road
Civic Center Plaza
Forest Park, OH 45240

PENNSYLVANIA

2221 Cabot Blvd. West
Suite B
Langhorne, PA 19047
Chartiers Valley
Shopping Center
1025 Washington Pike
Bridgeville, PA 15017

TENNESSEE

3800 Ezel Road
Suite 806
Nashville, TN 37211

TEXAS

7482 Harwin Drive
Houston, TX 77036
13615 Welch Road
Suite 101
Farmers Branch,
TX 75244

WASHINGTON

20425-84th Avenue
South
Kent, WA 98032

HAWAII

99-859 Iwaiwa Street
Aiea, Hawaii 96701
Phone (808) 488-1996
Fax (808) 486-4369

Service in Puerto Rico

Matsushita Electric of Puerto Rico, Inc. Panasonic Sales Company/ Factory ServiceCenter:
Ave. 65 de Infantería. Km. 9.5 San Gabriel Industrial Park Carolina, Puerto Rico 00985
Phone (787) 750-4300 Fax (787) 768-2910

As of December '99

Spanish Quick Use Guide/Guía Para Uso Rápido

Inserte de la batería

Antes de comenzar...

- Cargue la batería (página 11).

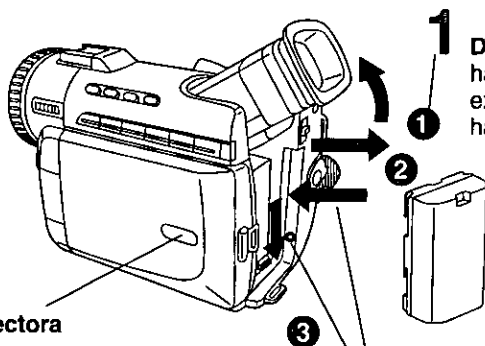

1 Deslice el visor hacia atrás, hasta la posición de totalmente extendido, y luego inclínelo hacia arriba.



2 Inserte la batería y deslícela hacia abajo hasta que quede trabada en posición (se escuchará un "clic").

Película protectora

Nota

- Retire la película protectora antes de utilizar.

Inserte el Cassette

1 Ajuste el interruptor de alimentación (POWER) a la posición VCR.

2 Deslice el interruptor de expulsión de cinta (TAPE EJECT) para abrir el compartimiento del cassette.

3 Inserte un cassette con el lado de la ventanilla de cara hacia arriba.

- Asegúrese de que la lengüeta de grabación esté cerrada (página 15).

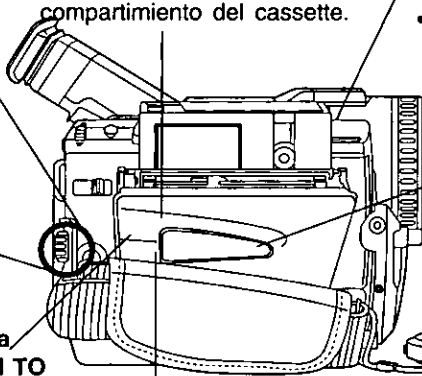
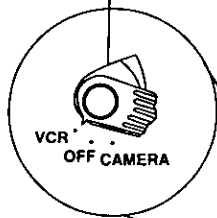

Película protectora

Nota

- Retire la película protectora antes de utilizar.

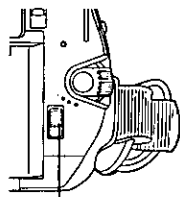

Marca PUSH TO CLOSE (EMPUJAR PARA CERRAR)

4 Presione la marca PUSH TO CLOSE (EMPUJAR PARA CERRAR) para cerrar la tapa del compartimiento del cassette.



Al utilizar una Cinta, debe usted ajustar el TAPE/M-CARD Switch (interruptor TAPE/M-CARD) a TAPE.

Spanish Quick Use Guide/Guía Para Uso Rápido

Grabación con la cámara

Cuando el monitor LCD se encuentra completamente abierto, el visor se apaga automáticamente.

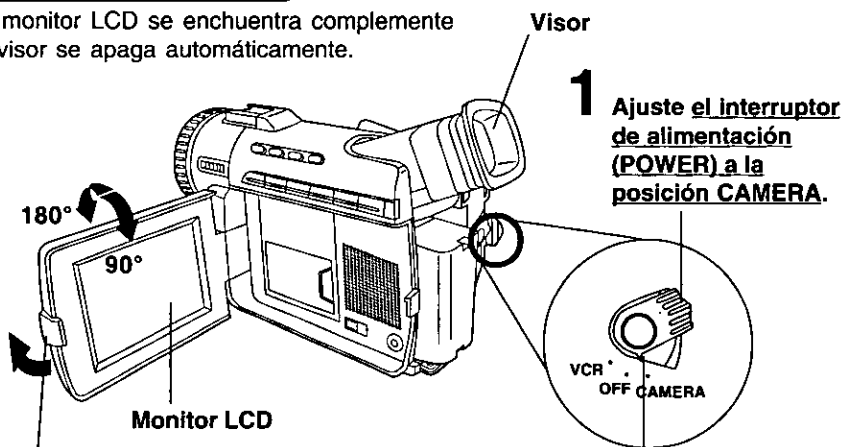

2 Presione el botón de apertura del LCD (LCD-OPEN) para destrabar el monitor LCD. Gírela hasta abrir completamente y ajusta el ángulo.

3 Presione el botón de grabación/pausa (RECORD/PAUSE) para iniciar la grabación. Vuelva a pulsar el botón de grabación/pausa (RECORD/PAUSE) para hacer una pausa en la grabación.

Introducir la MultiMediaCard (Tarjeta MultiMedia)

Asegúrese de introducir la MultiMediaCard (Tarjeta MultiMedia) antes de utilizar la Card PhotoShot (Tarjeta Foto Dispara) (página 41).

1 Presione el botón de apertura del LCD (LCD-OPEN) para destrabar el monitor LCD. Gírela hasta abrir completamente y ajusta el ángulo.

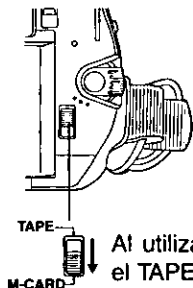
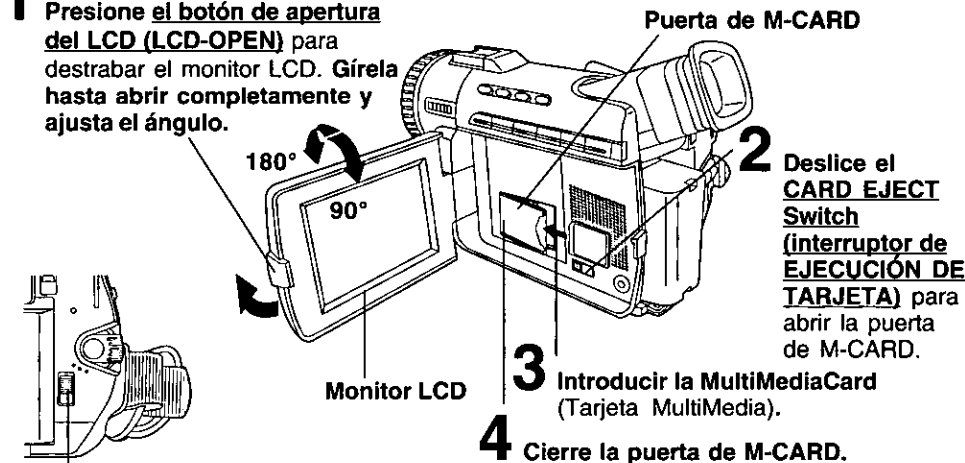

Al utilizar una MultiMediaCard (Tarjeta MultiMedia), debe usted ajustar el TAPE/M-CARD Switch (interruptor TAPE/M-CARD) a M-CARD.

Spanish Quick Use Guide/Guía Para Uso Rápido

Para ver la reproducción en el LCD (pantalla de visualización de cristal líquido)

Antes de comenzar...

- Cargue la batería (página 11).

Cuando el monitor LCD se encuentra completamente abierto, el visor se apaga automáticamente.

1 Ajuste el interruptor de alimentación (POWER) a la posición **VCR**.

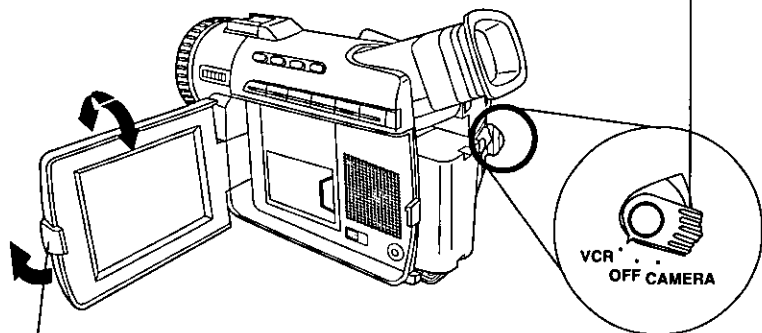

2 Presione el botón de apertura del LCD (**LCD-OPEN**) para destrabar el monitor LCD. Gírela hasta abrir completamente y ajusta el ángulo.

3 Presione el botón de **rebobinado (REW)** para rebobinar la cinta.

4 Presione el botón de **rebobinado (REW)** para rebobinar la cinta.

5 Presione el botón de **parada (STOP)** para detener la reproducción.

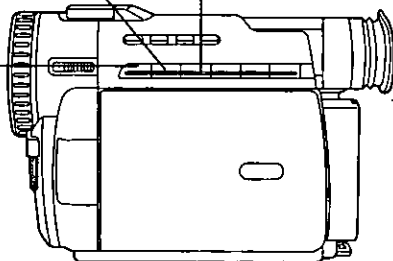

- A**
- AC Adaptor 2, 11, 13, 74, 84
 - Accessories (Optional) 74
 - Accessories (Supplied) 2
 - Audio/Video Cable 2, 40, 61, 62
 - Audio/Video Fade In/Out 57
 - Auto Focus 56
- B**
- Backlight 57
 - Battery Charging Confirmation Marker 11
 - Battery Pack 2, 8, 11, 12, 74
 - Battery Remaining Indication 26
 - Battery Warning 29
 - Before Requesting Service 79
 - Blank Search 33
- C**
- CARD EJECT Switch 9
 - Camera Recording 30, 31, 32, 33
 - Cleaning Care for Video Heads 79
 - Clock Battery 29
 - Clock Set 19
 - Color Enhancement Light 2, 16
 - Copying from Digital Equipment 63
 - Copying your Tapes 61, 62
- D**
- Date and Time Indication 27
 - DC Power Cable 2, 13, 74
 - DEW Indication 29
 - Digital E.I.S. 50
 - Digital Functions 55
 - Digital Photo Shot 52
 - Digital Video Cassette Tape 15
 - Digital Zoom 51
 - Dubbing over Audio(Microphone) 59, 60
 - DV Interface Cable 63, 64, 74
- E**
- Edit Search 32
 - Erase Protection Tab 15
 - EVF/LCD Monitor Indications 26, 27, 28, 29
- H**
- Hand Strap 18
 - High Speed Shutter 58
- J**
- Jog Search 38
- L**
- Lens Cap 2, 18, 30
- M**
- Macro Focus 56
 - Manual Focus 56
 - Memory Counter 26
 - MENU OSD 21, 22, 23, 24, 25
 - MultiMediaCard 2, 9
 - M-CARD Door 9
- P**
- PC Connection 64, 65
 - PC Connection Cable 2, 65
 - PLAY Indicator 27
 - Playback 35, 36, 37, 38, 39, 40
 - Power Supply 11, 12, 13
 - Program AE 54
- R**
- REC Indicator 27
 - Recording Still Pictures 53
 - Remote Control 33, 34, 72, 85
 - Request for Service Notice 80
- S**
- Safety Precautions 3
 - Set the Date and Time 19
 - Shoulder Strap 2, 17
 - Special Effects Playback 36, 37, 38, 39
 - Specifications 78
 - STILL Picture 36
- T**
- Tally LED 23, 30
 - Tape Remaining Indications 26
 - Tape Speed 15
 - Tape Warning 28
- V**
- VHF Connecting Cable 61, 62
 - Volume Display 28, 29
- W**
- Warranty 86, 87
 - White Balance 53
- Z**
- Zoom In/Out 51

**Panasonic Consumer Electronics
Company, Division of Matsushita
Electric Corporation of America**

One Panasonic Way Secaucus,
New Jersey 07094

Printed in Japan
LSQT0213A
S0100A0

**Panasonic Sales Company,
Division of Matsushita Electric of
Puerto Rico, Inc. ("PSC")**

Ave. 65 de Infantería, Km. 9.5
San Gabriel Industrial Park
Carolina, Puerto Rico 00985



Free Manuals Download Website

<http://myh66.com>

<http://usermanuals.us>

<http://www.somanuals.com>

<http://www.4manuals.cc>

<http://www.manual-lib.com>

<http://www.404manual.com>

<http://www.luxmanual.com>

<http://aubethermostatmanual.com>

Golf course search by state

<http://golfingnear.com>

Email search by domain

<http://emailbydomain.com>

Auto manuals search

<http://auto.somanuals.com>

TV manuals search

<http://tv.somanuals.com>