

Operation Manual

Multi-CD control DSP High power DVD-A/DVD-V/
VCD/CD/MP3/WMA/AAC/DivX/JPEG player with FM/
AM tuner

AVH-P7850DVD

SUPER TUNER III D+

English

Thank you for buying this Pioneer product.

Please read through these operating instructions so you will know how to operate your model properly. *After you have finished reading the instructions, keep this manual in a safe place for future reference.*



Be sure to read this

- Playable discs **8**
- DVD video disc region numbers **8**
- When an operation is prohibited **12**

01 Precautions

IMPORTANT SAFEGUARDS **6**

To ensure safe driving **6**

To avoid battery exhaustion **7**

02 Before You Start

About this unit **8**

About this manual **9**

Features **9**

About WMA **10**

About AAC **11**

About DivX **11**

To protect the LCD screen **11**

For viewing LCD comfortably **12**

What the marks on DVDs indicate **12**

Resetting the microprocessor **12**

Feature demo mode **13**

Use and care of the remote control **13**

03 What's What

Head unit **15**

Sub-display **16**

Remote control **17**

04 Basic Operations

Turning the unit on and selecting a source **21**

Adjusting the volume **22**

Turning the unit off **22**

Using the rear display **22**

Touch panel key basic operation **23**

Opening and closing the LCD panel **24**

Protecting your unit from theft **25**

Built-in DVD player basic operations **26**

05 Tuner

Listening to the radio **28**

Storing and recalling broadcast frequencies **28**

Introduction of advanced tuner operation **29**

Tuning in strong signals **29**

Storing the strongest broadcast frequencies **29**

06 Playing DVD discs

Watching a DVD video **30**

Listening to a DVD audio **31**

Operating the DVD menu **32**

Browsing still pictures **32**

Skipping back or forward to another title/group **32**

Resume playback (Bookmark) **33**

Frame-by-frame playback **33**

Slow motion playback **33**

Searching for the part you want to play **33**

Changing audio language during playback (Multi-audio) **34**

Changing the subtitle language during playback (Multi-subtitle) **34**

Changing the viewing angle during playback (Multi-angle) **34**

Automatic playback of DVDs **35**

Introduction of advanced DVD operation **35**

Repeating play **35**

Playing tracks in random order **36**

Scanning tracks **36**

Selecting audio output **36**

07 Playing Video CDs

Watching a Video CD **37**

- PBC playback **37**
- Frame-by-frame playback **38**
- Slow motion playback **38**
- Searching for a desired scene, starting playback from a specified time **38**
- Introduction of advanced Video CD operation **39**
- Repeating play **39**
- Selecting audio output **39**

08 Playing CDs

- Listening to a CD **40**
- Selecting tracks from the track title list **40**
- Displaying text information on CD TEXT discs **40**
- Introduction of advanced CD operation **41**
- Repeating play **41**
- Playing tracks in random order **41**
- Scanning tracks of a CD **41**

09 Playing MP3/WMA/AAC files

- Listening to MP3/WMA/AAC **42**
- Selecting tracks from the file name list **43**
- Displaying information on MP3/WMA/AAC file **43**
- Introduction of advanced built-in DVD player (MP3/WMA/AAC) operation **44**
- Repeating play **44**
- Playing tracks in random order **44**
- Scanning folders and tracks **44**

10 Playing DivX/JPEG files

- Watching a DivX/JPEG **45**
- Viewing a JPEG slideshow **46**
- Playing DivX® VOD content **46**
- Selecting files from the file name list **47**
- Displaying text information on DivX/JPEG disc **47**
- Frame-by-frame playback **47**

- Slow motion playback **47**
- Searching for the part you want to play **47**
- Changing audio language during playback (Multi-audio) **48**
- Changing the subtitle language during playback (Multi-subtitle) **48**
- Introduction of advanced built-in DVD player (DivX/JPEG) operation **49**
- Repeating play **49**
- Playing files in random order **49**

11 Multi-CD Player

- Listening to a CD **50**
- Pausing CD playback **51**
- Selecting tracks from the track title list **51**
- Displaying text information on CD TEXT discs **51**
- Introduction of advanced multi-CD player operation **52**
- Repeating play **52**
- Playing tracks in random order **52**
- Scanning CDs and tracks **52**
- Using compression and bass emphasis **53**
- Using ITS playlists **53**

12 Playing songs on iPod

- Listening to songs on your iPod **55**
- Browsing for a song **55**
- Pausing a song **56**
- Displaying text information on iPod **56**
- Displaying information on song **56**
- Repeating play **56**
- Playing songs in a random order (shuffle) **56**

13 Bluetooth Audio

- Listening to songs on BT Audio (Bluetooth audio player) **57**
- Function operation **58**

- Connecting a Bluetooth audio player **58**
- Disconnecting a Bluetooth audio player **59**
- Displaying BD (Bluetooth Device) address **59**

14 Bluetooth Telephone

- Hands-free phoning with cellular phones featuring Bluetooth wireless technology **60**
- Setting up for hands-free phoning **61**
- Basic operation of hands-free phoning **61**
- Introduction of advanced hands-free phoning operation **62**
- Connecting a cellular phone **62**
- Disconnecting a cellular phone **63**
- Registering connected cellular phone **63**
- Deleting a registered phone **63**
- Connecting to a registered cellular phone **64**
- Using the Phone Book **64**
- Using the Call History **66**
- Using preset numbers **67**
- Making a call by entering phone number **67**
- Clearing memory **67**
- Setting the automatic answering **68**
- Setting the automatic rejecting **68**
- Switching the ring tone **68**
- Echo canceling and noise reduction **68**
- Displaying BD (Bluetooth Device) address **68**

15 TV tuner

- Watching the television **69**
- Storing and recalling broadcast stations **69**
- Introduction of advanced TV tuner operation **70**
- Storing the strongest broadcast stations sequentially **70**
- Selecting the area group **71**

16 DVD Player

- Playing a disc **72**
- Turning the DVD player on or off **73**
- Selecting a disc **73**
- Introduction of advanced DVD player operation **74**
- Repeating play **74**
- Playing tracks in random order **74**
- Scanning tracks of a CD/MP3/WMA **74**
- Selecting audio output **75**

17 Audio Adjustments

- Introduction to built-in DSP features **76**
- Introduction of audio adjustments **78**
- Using balance adjustment **78**
- Adjusting source levels **79**
- Using the direct control **79**
- Listening in surround sound **79**
- Using the dynamic range control **81**
- Using the down-mix function **81**
- Switching the sound settings **82**
- Switching between the multi-channel output and 2-channel output **82**
- Introduction of sound settings **83**
- Using the position selector **83**
- Recalling equalizer curves **84**
- Adjusting 3-band parametric equalizer **84**
- Adjusting 13-band graphic equalizer **86**
- Setting the speaker setting **87**
- Using the cut-off frequency **87**
- Using the time alignment **89**
- Adjusting the speaker output levels **90**
- Using the auto-equalizer **91**
- Storing the adjusted audio settings in memory **91**
- Editing the name of sound settings **92**
- Auto TA and EQ (auto-time alignment and auto-equalizing) **92**

18 Setup

- Introduction of setup adjustments 95
- Setting the AV input 95
- Setting the automatic open function 96
- Adjusting the LCD panel slide position 96
- Setting the clock 96
- Setting the video of rear display 97
- Switching the dimmer setting for sub-display 97
- Adjusting the contrast for the sub-display 97
- Changing languages for CAUTION 97

19 Setting up the DVD player

- Introduction of DVD setup adjustments 98
- Setting the subtitle language 98
- Setting the audio language 98
- Setting the menu language 99
- Switching the assist subtitle on or off 99
- Setting the angle icon display 99
- Setting the aspect ratio 99
- Setting the parental lock 100
- Setting the still picture 101
- To play back bonus groups 101
- Displaying your DivX® VOD registration code 101
- Setting remote control code type 101

20 Initial Settings

- Adjusting initial settings 102
- Setting the FM tuning step 102
- Setting the AM tuning step 102
- Switching the warning tone 102
- Switching the auxiliary setting 103
- Correcting distorted sound 103
- Switching the sound muting/attenuation 103
- Switching the automatic disc playback 103
- Resetting the audio functions 104

- Switching the DSP setting mode 104
- Setting the optical input 104
- Setting the TV signal 104
- Entering PIN code for Bluetooth wireless connection 105
- Setting the security indicator 105

21 Other Functions

- Switching the display on the sub-display 106
- Adjusting the screen 106
- Selecting the background display 108
- Adjusting the response positions of the touch panels (Touch Panel Calibration) 108
- Using the AUX source 109
- Using the PGM button 109

Additional Information

- Troubleshooting 110
- Error messages 112
- Understanding auto TA and EQ error messages 113
- DVD player and care 114
- DVD discs 114
- CD-R/CD-RW discs 114
- Dual Discs 115
- MP3, WMA and AAC files 115
- About folders and MP3/WMA/AAC files 117
- JPEG picture files 117
- DivX video files 118
- Using the display correctly 118
- Language code chart for DVD 120
- DSP adjustment value record sheet 121
- Terms 123
- Specifications 127

Index 129

IMPORTANT SAFEGUARDS

Please read all of these instructions regarding your display and retain them for future reference.

- 1 **Read this manual fully and carefully before operating your display.**
- 2 **Keep this manual handy as a reference for operating procedures and safety information.**
- 3 **Pay close attention to all warnings in this manual and follow the instructions carefully.**
- 4 **Do not allow other persons to use this system until they have read and understood the operating instructions.**
- 5 **Do not install the display where it may (i) obstruct the driver's vision, (ii) impair the performance of any of the vehicle's operating systems or safety features, including air bags, hazard lamp buttons or (iii) impair the driver's ability to safely operate the vehicle.**
- 6 **Do not operate this display if doing so in any way will divert your attention from the safe operation of your vehicle. Always observe safe driving rules and follow all existing traffic regulations. If you experience difficulty in operating the system or reading the display, park your vehicle in a safe location and make necessary adjustments.**
- 7 **Please remember to wear your seat belt at all times while operating your vehicle. If you are ever in an accident, your injuries can be considerably more severe if your seat belt is not properly buckled.**
- 8 **Never use headphones while driving.**
- 9 **To promote safety, certain functions are disabled unless the parking brake is on, and the vehicle is not in motion.**
- 10 **Never set the volume of your display so high that you cannot hear outside traffic and emergency vehicles.**

WARNING

- **Do not attempt to install or service your display by yourself. Installation or servicing of the display by persons without training and experience in electronic equipment and automotive accessories may be dangerous and could expose you to the risk of electric shock or other hazards.** 

To ensure safe driving

WARNING

- **LIGHT GREEN LEAD AT POWER CONNECTOR IS DESIGNED TO DETECT PARKED STATUS AND MUST BE CONNECTED TO THE POWER SUPPLY SIDE OF THE PARKING BRAKE SWITCH. IMPROPER CONNECTION OR USE OF THIS LEAD MAY VIOLATE APPLICABLE LAW AND MAY RESULT IN SERIOUS INJURY OR DAMAGE.**
- To avoid the risk of damage and injury and the potential violation of applicable laws, this unit is not for use with a video screen that is visible to the driver.
- To avoid the risk of accident and the potential violation of applicable laws, the front DVD or TV (sold separately) feature should never be used while the vehicle is being driven. Also, rear displays should not be in a location where it is a visible distraction to the driver.
- In some countries or states the viewing of images on a display inside a vehicle even by persons other than the driver may be illegal. Where such regulations apply, they must be obeyed and this unit's DVD features should not be used.

Precautions

When you attempt to watch a DVD, Video CD or TV while driving, the warning **Viewing of front seat video source while driving is strictly prohibited.** will appear on the front display.

To watch a DVD, Video CD or TV on the front display, park your vehicle in a safe place and apply the parking brake.

When using a display connected to REAR DISPLAY OUT

This unit's **REAR DISPLAY OUT** is for connection of a display to enable passengers in the rear seats to watch the DVD or TV.

WARNING

NEVER install the rear display in a location that enables the driver to watch the DVD or TV while driving. 

To avoid battery exhaustion

Be sure to run the vehicle engine while using this unit. Using this unit without running the engine can result in battery drainage.

- When no power is supplied to this unit because of a replacement of the vehicle battery or for some similar reason, the microcomputer of this unit is returned to its initial condition except audio settings. Although audio adjustment information is stored in this unit for several hours, we recommend that you transcribe the data. You can fill the data in the sheet on 121.

WARNING

Do not use with vehicles that do not feature an ACC position. 

About this unit

⚠ CAUTION

- Do not allow this unit to come into contact with liquids. Electrical shock could result. Also, this unit damage, smoke, and overheat could result from contact with liquids.
- "CLASS 1 LASER PRODUCT"
This product contains a laser diode of higher class than 1. To ensure continued safety, do not remove any covers or attempt to gain access to the inside of the product. Refer all servicing to qualified personnel.
- Keep this manual handy as a reference for operating procedures and precautions.
- Always keep the volume low enough so that you can hear sounds from outside the vehicle.
- Protect this unit from moisture.
- If the battery is disconnected or discharged, the preset memory will be erased and must be reprogrammed.
- If this unit does not operate properly, contact your dealer or nearest authorized Pioneer Service Station.

Playable discs

DVD, Video CD and CD discs that display the logos shown below can be played back on this player.

DVD audio



DVD video



Video CD



CD



✎ Notes

- DVD** is a trademark of DVD Format/Logo Licensing Corporation.
- This player can only play back discs bearing the marks shown above.

DVD video disc region numbers

DVD video discs that have incompatible region numbers cannot be played on this player. The region number of the player can be found on the bottom of this unit.

Before You Start

The illustration below shows the regions and corresponding region numbers.



About this manual

This unit features a number of sophisticated functions ensuring superior reception and operation. All the functions have been designed for the easiest possible use, but many are not self-explanatory. This operation manual will help you benefit fully from this unit's potential and to maximize your listening enjoyment. We recommend that you familiarize yourself with the functions and their operation by reading through the manual before you begin using this unit. It is especially important that you read and observe **WARNINGs** and **CAUTIONs** in this manual. 

Features

Touch panel key operation

It is possible to operate this unit by using touch panel key.

DVD audio playback

It is possible to play back DVD audio.

DVD video playback

It is possible to play back DVD video and DVD-R/RW (video mode).

Video CDs featuring PBC compatibility

It is possible to play back Video CDs featuring PBC (playback control).

CD playback

Music CD/CD-R/RW playback is possible.

MP3 file playback

You can play back MP3 files recorded on CD-R/RW/ROM and DVD-R/RW/ROM (ISO9660 Level 1/Level 2 standard recordings).

- Supply of this product only conveys a license for private, non-commercial use and does not convey a license nor imply any right to use this product in any commercial (i.e. revenue-generating) real time broadcasting (terrestrial, satellite, cable and/or any other media), broadcasting/streaming via internet, intranets and/or other networks or in other electronic content distribution systems, such as pay-audio or audio-on-demand applications. An independent license for such use is required. For details, please visit <http://www.mp3licensing.com>.

WMA file playback

You can play back WMA files recorded on CD-R/RW/ROM and DVD-R/RW/ROM (ISO9660 Level 1/Level 2 standard recordings).

AAC file playback

You can play back AAC files recorded on CD-R/RW/ROM and DVD-R/RW/ROM (ISO9660 Level 1/Level 2 standard recordings).

DivX® video file playback

You can play back DivX video files recorded on CD-R/RW/ROM and DVD-R/RW/ROM.

JPEG picture file playback

You can play back JPEG picture files recorded on CD-R/RW/ROM.

NTSC/PAL compatibility

This unit is NTSC/PAL system compatible. When connecting other components to this unit, be sure components are compatible with the same video system otherwise images will not be correctly reproduced.

Dolby Digital EX/DTS-ES compatibility

You can enjoy the atmosphere and excitement provided by DVD movie and music software featuring 5.1 channel recordings.

- Manufactured under license from Dolby Laboratories. “Dolby”, “Pro Logic”, and the double-D symbol are trademarks of Dolby Laboratories.



- “DTS”, “DTS-ES”, “Neo:6”, and “DTS 96/24” are trademarks of Digital Theater Systems, Inc.

**Multi-aspect**

Switching between wide screen, letterbox and panscan display is possible.

Multi-audio

You can switch between multiple audio systems recorded on a DVD as desired.

Multi-subtitle

You can switch between multiple subtitle languages recorded on a DVD as desired.

Multi-angle

You can switch between multiple viewing angles of a scene recorded on a DVD as desired.

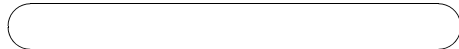
**Hands-free phoning**

Using Bluetooth adapter (e.g. CD-BTB100), this unit realizes effortless hands-free phoning with Bluetooth wireless technology.

- In some countries, CD-BTB100 is not sold on the market.

Bluetooth audio player compatibility

Using Bluetooth adapter (e.g. CD-BTB100), you can control Bluetooth audio player featuring Bluetooth wireless technology.

- In some countries, CD-BTB100 is not sold on the market.

iPod® compatibility

When you use this unit with a Pioneer iPod adapter (CD-IB100II) (sold separately), you can control an iPod with Dock Connector.

- iPod is a trademark of Apple Computer, Inc., registered in the U.S. and other countries.

**Note**

This product incorporates copyright protection technology that is protected by method claims of certain U.S. patents and other intellectual property rights owned by Macrovision Corporation and other rights owners. Use of this copyright protection technology must be authorized by Macrovision Corporation, and is intended for home and other limited viewing uses only unless otherwise authorized by Macrovision Corporation. Reverse engineering or disassembly is prohibited. []

About WMA

Before You Start

The Windows Media™ logo printed on the box indicates that this unit can play back WMA data.

WMA is short for Windows Media Audio and refers to an audio compression technology that is developed by Microsoft Corporation. WMA data can be encoded by using Windows Media Player version 7 or later.

- Windows Media and the Windows logo are trademarks or registered trademarks of Microsoft Corporation in the United States and/or other countries.



Notes

- This unit may not operate correctly depending on the application used to encode WMA files.
- Depending on the version of Windows Media Player used to encode WMA files, album names and other text information may not be correctly displayed.
- There may be a slight delay when starting playback of WMA files encoded with image data. ■

About AAC

AAC is short for Advanced Audio Coding and refers to an audio compression technology standard used with MPEG 2 and MPEG 4. Several applications can be used to encode AAC files, but file formats and extensions differ depending on the application which is used to encode.

This unit plays back AAC files encoded by iTunes® version 4.6.

- iTunes is a trademark of Apple Computer, Inc., registered in the U.S. and other countries. ■

About DivX



DivX is a compressed digital video format created by the DivX® video codec from DivX, Inc. This unit can play DivX video files recorded on CD-R/RW/ROM and DVD-R/RW/ROM discs. Keeping the same terminology as DVD video, individual DivX video files are called "Titles". When naming files/titles on a CD-R/RW or a DVD-R/RW disc prior to burning, keep in mind that by default they will be played in alphabetical order.

Official DivX® Certified product

Plays all versions of DivX® video (including DivX® 6) with standard playback of DivX® media files

- DivX, DivX Certified, and associated logos are trademarks of DivX, Inc. and are used under license. ■

To protect the LCD screen

- Do not allow direct sunlight to fall on the display when this unit is not being used. Extended exposure to direct sunlight can result in LCD screen malfunction due to the resulting high temperatures.
- When using a cellular phone, keep the antenna of the cellular phone away from the display to prevent disruption of the video by the appearance of spots, colored stripes, etc.
- Never touch the screen with anything besides your finger when operating the touch panel function. The screen can scratch easily. ■

For viewing LCD comfortably

Due to its construction, the viewing angle of the LCD screen is limited. You can adjust it by changing either screen size or picture adjustment.

Changing the wide screen size



By changing the screen size from 4:3 to 16:9, you can adjust the screen so that the screen can fit to the video image you are playing. For details concerning operation, refer to *Changing the wide screen mode* on page 106.



Changing the picture adjustment

You can make the best adjustment to the picture display by changing **BRIGHT**, **CONTRAST**, **COLOR** and **HUE**. You can also dim or enlight the overall picture image using **DIMMER**. For details concerning operation, refer to *Changing the picture adjustment* on page 106. 

What the marks on DVDs indicate



The marks below may be found on DVD disc labels and packages. They indicate the type of images and audio recorded on the disc, and the functions you can use.

Mark	Meaning
	Indicates the number of audio systems.
	Indicates the number of subtitle languages.
	Indicates the number of viewing angles.

Mark	Meaning
	Indicates the picture size (aspect ratio: screen width-to-height ratio) type.
	Indicates the number of the region where playback is possible.

When an operation is prohibited

When you are watching a DVD and attempt to perform an operation, it may not be performed because of the programming on the disc. When this happens, the icon  appears on the screen.

- The icon  may not appear with certain discs. 

Resetting the microprocessor

Pressing **RESET** lets you reset the microprocessor to its initial settings without changing the bookmark information.

The microprocessor must be reset under the following conditions:

- Prior to using this unit for the first time after installation
- If the unit fails to operate properly
- When strange or incorrect messages appear on the display

Important

If you press **RESET**, all memorized settings are erased. For this reason, we recommend that you record the settings in the sheet on page 121 after you have completed audio adjustments.

1 Turn the ignition switch OFF.

Before You Start

2 Press **RESET** with a pen tip or other pointed instrument.

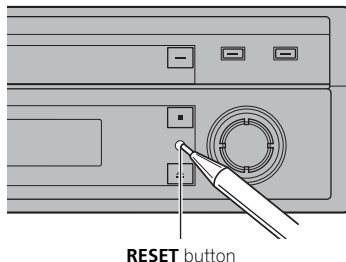

Note

After completing connections or when you want to erase all memorized settings or return the unit to its initial (factory) settings, switch your engine ON or set the ignition switch to ACC ON before pressing **RESET**.

Feature demo mode

The feature demo automatically starts when you select the source **OFF**. The demo continues while the ignition switch is set to ACC or ON. To cancel the feature demo, press and hold **SOUND SETTING**. To restart the feature demo, press and hold **SOUND SETTING** again. Remember that if the feature demo continues operating when the car engine is turned off, it may drain battery power.

Important

The red lead (ACC) of this unit should be connected to a terminal coupled with ignition switch on/off operations. If this is not done, the vehicle battery may be drained.

Use and care of the remote control

Installing the battery

Slide the tray out on the back of the remote control and insert the battery with the plus (+) and minus (-) poles pointing in the proper direction.

- When using for the first time, pull out the film protruding from the tray.

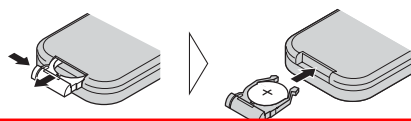

WARNING

Keep the battery out of the reach of children. Should the battery be swallowed, immediately consult a doctor.

CAUTION

- Use only one **CR2025 (3 V)** lithium battery.
- Remove the battery if the remote control is not used for a month or longer.
- Do not recharge, disassemble, heat or dispose of the battery in fire.
- Do not handle the battery with metallic tools.
- Do not store the battery with metallic materials.
- In the event of battery leakage, wipe the remote control completely clean and install a new battery.
- When disposing of used batteries, please comply with governmental regulations or environmental public institutions' rules that apply in your country/area.

Using the remote control

Point the remote control in the direction of the front panel to operate.

- The remote control may not function properly in direct sunlight.

**Important**

- Do not store the remote control in high temperatures or direct sunlight.
- Do not let the remote control fall onto the floor, where it may become jammed under the brake or accelerator pedal.

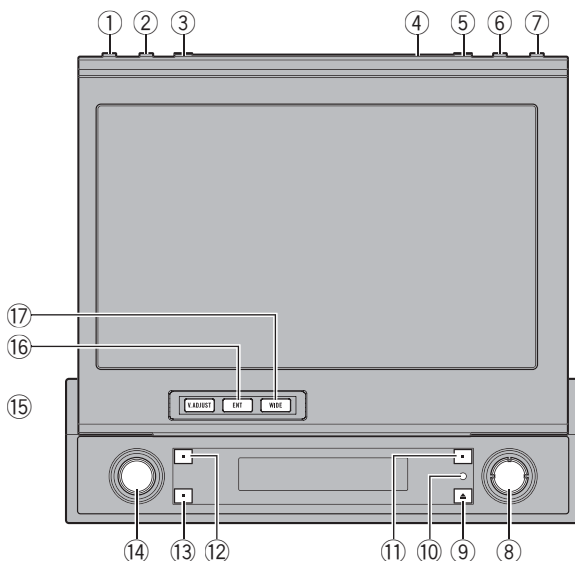

Head unit

① DISPLAY button

Press to turn the information display on or off when the video is displayed.

② PGM button

Press to operate the preprogrammed functions for each source. (Refer to *Using the PGM button* on page 109.)

③ FLIP DOWN button

Press to turn the LCD panel horizontal temporarily from upright position.

④ Ambient light sensor

Senses ambient light. This system automatically adjusts the brightness of the display to compensate for ambient light.

⑤ OPEN/CLOSE button

Press to open or close the LCD panel.

⑥ BAND/ESC button

Press to select among three FM bands and to cancel the control mode of functions.

⑦ ATT button

Press to quickly lower the volume level, by about 90%. Press once more to return to the original volume level.

⑧ Joystick

Move to perform manual seek tuning, fast forward, reverse and track search controls. Also used for controlling functions.

⑨ EJECT button

Press to eject a disc from this unit. Press and hold to open or close the front panel.

⑩ RESET button

Press to return to the factory settings (initial settings).

11 SOUND SETTING button

Press to select the sound setting.

12 REAR ON button

Press to switch between the video sources (such as **DVD** or **AV**) on rear display.

13 2ch/MULTI-CH button

Press to switch between the multi-channel output and 2-channel output.
Press and hold to switch between the displays on the sub-display.

14 SOURCE button, VOLUME

This unit is turned on by selecting a source.
Press to cycle through all the available sources.
Rotate it to increase or decrease the volume.

15 V.AJUST button

Press to display the picture adjustment menu.

16 ENTERTAINMENT button

Press to display the entertainment menu.

17 WIDE button

Press to select a desired mode for enlarging a 4:3 picture to a 16:9 one.

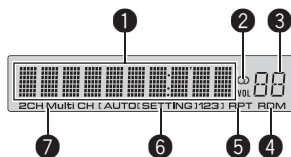
Sub-display**1 Source display**

Shows the status of selected source.

2 Stereo (◐) indicator

Shows when the selected frequency is being broadcast in stereo.

3 Volume level indicator

Shows the value of current volume level.

4 RDM indicator

Shows when random play is turned on.

5 RPT indicator

Shows when repeat play is turned on.

6 Sound setting indicator

Shows what the sound setting has been selected.

7 Output setting indicator

Shows what the output setting has been selected.

What's What

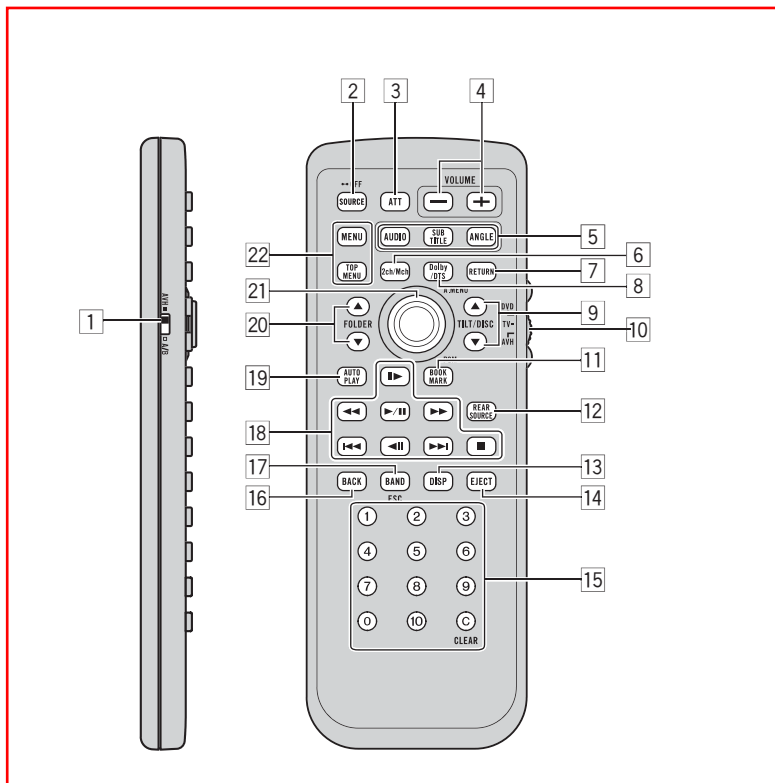

Remote control

	Button names	AVH mode	DVD mode with remote control code AVH
1	Remote control selection switch	Switch to change the setting of the remote control. For details, refer to <i>Setting remote control code type</i> on page 101.	
2	SOURCE button	Press to cycle through all the available sources. Press and hold to turn the source off.	
3	ATT button	Press to quickly lower the volume level, by about 90%. Press once more to return to the original volume level.	
4	VOLUME buttons	Press to increase or decrease the volume.	
5	AUDIO button	Press to change the audio language during DVD playback.	
	SUBTITLE button	Press to change the subtitle language during DVD playback.	
	ANGLE button	Press to change the viewing angle during DVD playback.	

	Button names	AVH mode	DVD mode with remote control code AVH
6	2ch/MULTI-CH button	Press to switch between the multi-channel output and 2-channel output.	
7	RETURN button	Press to display the PBC (playback control) menu during PBC playback.	
8	Dolby/DTS	Press to switch between surround sound setting (Dolby Pro Logic II or DTS Neo:6).	
9	▲/▼ button (TILT/DISC)	Press to adjust the LCD panel angle.	Not used.
10	Remote control operation mode switch	Switch the operation mode between AVH , DVD and TV modes. Normally, set to AVH . For details, refer to <i>Using the remote control operation mode switch</i> on the next page.	
11	BOOKMARK button	Press to operate the preprogrammed functions for each source. (Refer to <i>Using the PGM button</i> on page 109.)	Press to turn the bookmark function on or off. For details, refer to <i>Resume playback (Bookmark)</i> on page 33.
12	REAR SOURCE button	Press to switch between the video sources (such as DVD or AV) on rear display.	
13	DISPLAY button	Press to turn the information display on or off when the video is displayed.	
14	EJECT button	Press to eject a disc from this unit. Press and hold to bookmark a disc at the point you want to bookmark.	Not used.
15	0-10 buttons, CLEAR button	Press 0-10 to input numbers. Buttons 1-6 can operate the preset tuning for the tuner or disc changing for DVD player or multi-CD player. Press CLEAR to clear the input numbers.	Press to select a menu item on the Video CDs featuring PBC (playback control).
16	BACK button	Press to return to the previous display.	Not used.
17	BAND/ESC button	Press to select among three FM bands and to cancel the control mode of functions. Press to switch between media file types. (Refer to <i>Switching the media file type</i> on page 27.)	Press to switch between media file types. (Refer to <i>Switching the media file type</i> on page 27.)

What's What

	Button names	AVH mode	DVD mode with remote control code AVH
18	PLAY/PAUSE (▶/⏸) button	Press to switch sequentially between playback and pause.	
	REVERSE (◀◀) button	Press to perform fast reverse.	
	FORWARD (▶▶) button	Press to perform fast forward.	
	PREVIOUS (◀◀) button	Press to return to the previous track (chapter).	
	NEXT (▶▶) button	Press to go to the next track (chapter).	
	STEP (⏮/⏭) button	Press to move ahead one frame at a time during DVD/VideoCD playback. Press and hold for one second to activate slow playback.	
	STOP (■) button	Press to stop playback.	
19	AUTO PLAY button	Press to turn the DVD auto-playback function on or off.	
20	▲/▼ button (FOLDER)	Press to select the next/previous folder.	
21	Joystick	Move to do fast forward, reverse and track search controls. Click to recall AUDIO MENU .	Move to select a menu on the DVD menu.
22	MENU button	Press to display the DVD menu during DVD playback.	
	TOP MENU button	Press to return to the top menu during DVD playback.	

Using the remote control operation mode switch

There are three remote control operation modes on the remote control.

AVH mode operation

When operating this unit by remote control, the mode is normally switched to **AVH**.

- The joystick on the remote control can perform the same operations as the one on the head unit. Furthermore, the joystick can perform the same operations as the touch panel keys ↑, ↓, ← and →.

- **1–6** can perform the same operations as the preset tuning keys **P1—P6** and the disc selection keys **01—06**.
 - If you want to select a disc located at 7 to 12 by using buttons **1–6**, press and hold the corresponding numbers, such as **1** for disc 7, until the disc number appears in the display.

DVD mode operation

If you switch the mode to **DVD**, the joystick and **0–10** operations are changed for DVD player.

● When you want to operate the following functions, switch the mode to DVD:

- When operating the DVD menu by using the joystick. (Refer to *Operating the DVD menu* on page 32.)
- When browsing still pictures by using the joystick. (Refer to *Browsing still pictures* on page 32.)
- When operating the PBC menu by using **0–10**. (Refer to *Watching a Video CD* on page 37.)

TV mode operation

TV operations available with a Pioneer TV tuner (e.g. **GEX-P5750TV**) can be controlled with **AVH** mode. **TV** mode is not used with this unit.

- For details concerning operation, refer to the TV tuner's operation manuals.

● When you want to operate the following functions only on the rear display, switch the mode to TV:

- When performing manual or seek tuning by moving the joystick left or right.
- When recalling preset stations by moving the joystick up or down.



Basic Operations

Turning the unit on and selecting a source

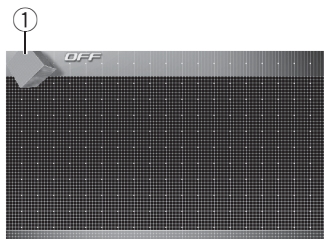

① Source icon

Shows which source has been selected.

You can select a source you want to listen to. If **DVD DISC AUTO** is turned on, load a disc in the unit to switch to **DVD** (refer to *Switching the automatic disc playback* on page 103).

● When using the touch panel keys, touch the source icon and then touch the desired source name.

The source names are displayed and selectable ones are highlighted.

- **DVD** – Built-in DVD player
 - **S-DVD** – DVD player/multi-DVD player
 - **M-CD** – Multi-CD player
 - **FM** – FM tuner
 - **AM** – AM tuner
 - **TV** – Television
 - **AV1** – AV 1 input
 - **AV2** – AV 2 input
 - **EXT1** – External unit 1
 - **EXT2** – External unit 2
 - **AUX1** – AUX 1
 - **AUX2** – AUX 2
 - **iPod** – iPod
 - **Telephone** – BT telephone
 - **BT AUDIO** – Bluetooth audio player
 - **OFF** – Turn the unit off
- When the source icon is not displayed, you can display it by touching the screen.

- While operating the menu, you cannot select a source by touching the source icon.
- To close source select menu, touch **ESC**.

● When using the button, press **SOURCE** to select a source.

Press **SOURCE** repeatedly to switch between the following sources:

FM (FM tuner)—**AM** (AM tuner)—**TV** (television)—**AV1** (AV 1 input)—**AV2** (AV 2 input)—**DVD** (built-in DVD player)—**S-DVD** (DVD player/multi-DVD player)—**M-CD** (multi-CD player)—**iPod** (iPod)—**EXT1** (external unit 1)—**EXT2** (external unit 2)—**AUX1** (AUX 1)—**AUX2** (AUX 2)—**Telephone** (bluetooth telephone)—**BT AUDIO** (bluetooth audio player)



Notes

- In the following cases, the sound source will not change:
 - When there is no unit corresponding to the selected source connected to this unit.
 - When there is no disc in the unit.
 - When there is no disc in the DVD player.
 - When there is no magazine in the multi-CD player.
 - When the AUX (auxiliary input) is set to off (refer to page 103).
 - When the AV (AV input) is not set to **VIDEO** (refer to page 95).
- External unit refers to a Pioneer product (such as one available in the future) that, although incompatible as a source, enables control of basic functions by this unit. Two external units can be controlled by this unit. When two external units are connected, the allocation of them to external unit 1 or external unit 2 is automatically set by this unit.
- When this unit's blue/white lead is connected to the vehicle's auto-antenna relay control terminal, the vehicle's antenna extends when this unit's source is turned on. To retract the antenna, turn the source off. ■

Adjusting the volume

- Use **VOLUME** to adjust the sound level.

With the head unit, rotate **VOLUME** to increase or decrease the volume.

With the remote control, press **VOLUME** to increase or decrease the volume. 

Turning the unit off

- When using the touch panel keys, touch the source icon and then touch **OFF**.

- When the source icon is not displayed, you can display it by touching the screen.

- When using the button, press **SOURCE** and hold until the unit turns off. 

Using the rear display

You can watch the video sources (such as **DVD** or **AV**) on rear display independently of front display.

- To watch a DVD/Video CD on the rear display only, switch the operation mode on the remote control to **DVD**. And you can operate the DVD/Video CD playback on the rear display independently by the remote control. (Refer to page 19.)



CAUTION

When you have turned the rear display output on by pressing **REAR ON**, you cannot turn it off even if you press **SOURCE** and hold. In this case, press **REAR ON** and hold to turn the rear display output off.

- Press **REAR ON** to select the video source on the rear display.

Press **REAR ON** repeatedly to switch between the following video sources:

F. SOURCE (same source as the front display)—**DVD** (built-in DVD player)—**AV1** (AV 1 input)—**AV2** (AV 2 input)

Rear display output is turned on and the illumination color of **REAR ON** changes to a different color from the other buttons.

- You can also perform this operation by pressing **REAR SOURCE** on the remote control.

- To turn the rear display output off, press **REAR ON** and hold.

- When selecting **F. SOURCE**, when the selected source is an audio source, nothing is displayed on rear display.

- When you watch **DVD** (built-in DVD player) on both the front and the rear display, audio is not outputted from **REAR DISPLAY OUT**.

- When selecting **FRONT** in **REAR MODE**, you can select **F. SOURCE** only. And audio is not outputted from **REAR DISPLAY OUT**. (Refer to *Setting the video of rear display* on page 97.)



Note

In the following cases, the sound source will not change:

- When there is no disc in the unit.
- When the AV (AV input) is not set to **VIDEO** (refer to page 95). 

Basic Operations

Touch panel key basic operation

Activating the touch panel keys



① TILT (v/v) keys

Touch to adjust the LCD panel angle.

② Touch panel keys

Touch to do various operations.

1 Touch the screen to activate the touch panel keys corresponding to each source.

The touch panel keys appear on the display.

- To go to the next group of touch panel keys, touch **NEXT**.
- To return to the previous group of touch panel keys, touch **PREV**.

2 Touch ESC to hide the touch panel keys.



Note

If you do not use the touch panel keys within 30 seconds, they will be hidden automatically when selecting video sources.

Operating the menu

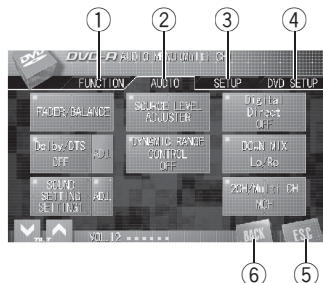

① FUNCTION key

Touch to select functions for each source.

② AUDIO key

Touch to select various sound quality controls.

③ SETUP key

Touch to select various setup functions.

④ DVD SETUP key

Touch to select various DVD setup functions.

- **DVD SETUP** appears on the display only when DVD is played back on this unit.

⑤ ESC key

Touch to cancel the control mode of functions.

⑥ BACK key

Touch to return to the previous display.

1 Touch AV MENU to display AUDIO MENU.

AUDIO MENU appears on the display.

- When **AV MENU** is not displayed, you can display it by touching the screen.

2 Touch the desired key to display the function names you want to operate.

3 Touch ESC to return to the display of each source.

Operating the menu by using the joystick

You can also perform most of the menu items by using the joystick.

- Switch the remote control operation mode to **AVH** to operate the menu by using the joystick on the remote control. (Refer to page 19.)

1 Click the joystick during display of each source to display AUDIO MENU.

AUDIO MENU appears on the display.

2 Move the joystick left or right to display the function names you want to operate.

3 Move the joystick to select the desired function.

4 Press BAND/ESC to return to the display of each source.

- You can return to the previous display by pressing **BACK**. 

Opening and closing the LCD panel

The LCD panel will be opened or closed automatically with the turning of the ignition switch on or off. You can turn off the automatic close/open function. (Refer to page 96.)

- The automatic close/open function will operate the display as follows.
 - When the ignition switch is turned OFF while the LCD panel is opened, the LCD panel will close after six seconds.

- When the ignition switch is turned ON again (or turned to ACC), the LCD panel will be opened automatically.

- Removing or attaching the front panel will automatically close or open the LCD panel. (Refer to the next page.)

- When the ignition switch is turned OFF after the LCD panel has been closed, turning the ignition switch ON again (or turning it to ACC) will not open the LCD panel. In this case, press **OPEN/CLOSE** to open the LCD panel.
- When closing the LCD panel, check to make sure that it has closed completely. If the LCD panel has stopped halfway, leaving it like this could result in damage.



CAUTION

Keep hands and fingers clear of the unit when opening, closing, or adjusting the LCD panel. Be especially cautious of children's hands and fingers.



● Press **OPEN/CLOSE** to open the LCD panel.

- To close the LCD panel, press **OPEN/CLOSE** again.

Adjusting the LCD panel angle



Important

- If you can hear the LCD panel knocking against your vehicle's console or dashboard, touch **TILT** () to move the LCD panel a little forward.
- When adjusting the LCD panel angle, be sure to touch **TILT** ()**TILT** (). Forcibly adjusting the LCD panel by hand may damage it.

● Touch **TILT** ()**TILT** () to adjust the LCD panel to an easily viewable angle.

The LCD panel angle continues changing as long as you touch **TILT** ()**TILT** () and hold.

Basic Operations

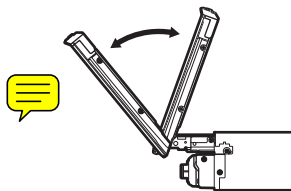

- The adjusted LCD panel angle will be memorized and automatically returned to the next time the LCD panel is opened.

Turning the LCD panel horizontal

When the LCD panel is upright and it hinders the operation of the air conditioner, the panel can be turned horizontal temporarily.

- **Press FLIP DOWN to turn the LCD panel horizontal.**

- To return to original position, press **FLIP DOWN** again.
- The LCD panel returns to the original position automatically with beeping sound 10 seconds after operation. 

Protecting your unit from theft

The front panel can be detached from the head unit and stored in the provided protective case to prevent theft.

- If the front panel is not detached from the head unit within five seconds of turning off the ignition, a warning tone will sound.
- You can turn off the warning tone. See *Switching the warning tone* on page 102.
- You can turn off the security indicator. See *Setting the security indicator* on page 105.

Important

- Never use force or grip the display and the buttons too tightly when removing or attaching.
- Avoid subjecting the front panel to excessive shocks.
- Keep the front panel out of direct sunlight and high temperatures.
- If removed, replace the front panel on the unit before starting up your vehicle.

Removing the front panel

1 Press and hold EJECT to open the front panel.

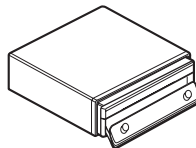

2 Gently grip the right side of the front panel and slowly pull it outward.

Take care not to grip it too tightly or to drop the front panel and protect it from contact with water or other fluids to prevent permanent damage.

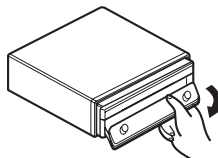

3 Put the front panel into provided protective case for safe keeping.

Attaching the front panel

1 Make sure the inner cover is closed.

2 Align the top of the front panel to the unit.

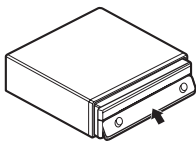

3 Press the bottom of the front panel until it is clicked.

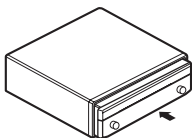

Note

In the following cases, remove the front panel and then attach it again:

- When nothing appears in the sub-display.
- When beep sounds. 

Built-in DVD player basic operations

Playing a disc

1 Press EJECT to open the front panel.

Disc loading slot appears.

- When a disc is loaded in this unit, touch the source icon and then touch **DVD** to select **DVD**.

2 Insert a disc into the disc loading slot.

Front panel is closed automatically, and playback will start.

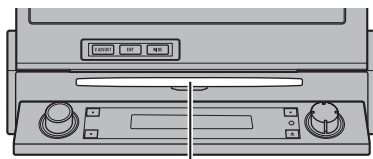

Disc loading slot

- When **DVD DISC AUTO** is off, touch the source icon and then touch **DVD** to select the built-in DVD player (refer to page 21).
- If you are playing a DVD or Video CD, a menu may appear. Refer to *Operating the DVD menu* on page 32 and *PBC playback* on page 37.
- When the automatic playback function is on, this unit will cancel the DVD menu and automatically start playback from the first chapter of the first title. Refer to *Automatic playback of DVDs* on page 35.
- You can eject a disc by pressing **EJECT**.



Notes







- The DVD player plays one, standard, 12-cm or 8-cm (single) disc at a time. Do not use an adapter when playing 8-cm discs.
- Do not insert anything other than a disc into the disc loading slot. Discs which can be played back are listed on *Playable discs* on page 8.
- If bookmark function is on, DVD playback resumes from the selected point. For more details, refer to *Resume playback (Bookmark)* on page 33.
- If a disc contains a mixture of various media file types such as DivX and MP3, you can switch between media file types to play. Refer to *Switching the media file type* on the next page.
- If you cannot insert a disc completely or if after you insert a disc the disc does not play, check that the label side of the disc is up. Press **EJECT** to eject the disc, and check the disc for damage before inserting it again.

Basic Operations



- There is sometimes a delay between starting up disc playback and the sound being issued. When being read, **FORMAT READ** is displayed.
- When the disc loading or ejecting function does not operate properly, you can eject the disc by pressing and holding **EJECT** while opening the front panel.
- If an error message such as **ERROR-02** is displayed, refer to *Error messages* on page 112.

Basic playback controls

The table below shows the basic controls for playing discs. The following chapters cover other playback features in more details.

Key	What it does
	Starts playback, pauses a disc that's playing or restarts a paused disc.
	Stops playback.
	Skips to the start of the current track, chapter or file, then to previous tracks/chapters/files. • Performs fast reverse by touching and holding  .
	Skips to the next track, chapter or file. • Performs fast forward by touching and holding  .

Notes

- You can also perform fast forward or reverse by pressing and holding  or  on the remote control.
- You may find with some DVD or video CD discs that some playback controls do not work in certain parts of the disc. This is not a malfunction.

Switching the media file type

When playing a disc containing a mixture of various media file types such as DivX and

MP3, you can switch between media file types to play.

- This unit allows playback of the following media file type recorded on CD-R/RW/ROM discs.
 - Audio data (CD-DA)
 - Compressed audio (MP3/WMA/AAC) files
 - DivX video files
 - JPEG picture files
- In case of DVD-R/RW/ROM, this unit does not allow playback of audio data (CD-DA) or JPEG picture files.

● Touch **MEDIA** to switch between media file types.

Touch **MEDIA** repeatedly to switch between the following media file types:

CD (audio data (CD-DA))—**ROM-Audio** (MP3/WMA/AAC files)—**DivX** (DivX video files)—**JPEG** (JPEG picture files) 

Listening to the radio

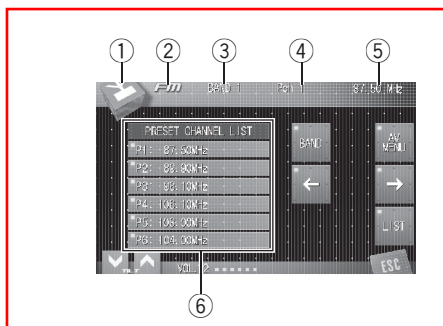

These are the basic steps necessary to operate the radio. More advanced tuner operation is explained starting on the next page.

- ① **Source icon**
Shows which source has been selected.
- ② **Source name**
Shows the selected source name.
- ③ **Band indicator**
Shows to which band the radio is tuned when FM is selected as the source.
- ④ **Preset number indicator**
Shows which preset has been selected.
- ⑤ **Frequency indicator**
Shows the frequency to which the tuner is tuned.
- ⑥ **Preset list display**
Shows the preset list.

1 Touch the source icon and then touch FM or AM to select the tuner.

2 Touch BAND to select a band when FM is selected as the source.

Touch **BAND** repeatedly until the desired band is displayed, **BAND 1**, **BAND 2** or **BAND 3**.

3 To perform manual tuning, briefly touch ← or →.

The frequencies move up or down step by step.

▪ You can also perform manual tuning by moving the joystick left or right.

4 To perform seek tuning, keep touching ← or → for about one second and release.

The tuner will scan the frequencies until a broadcast strong enough for good reception is found.

- You can cancel seek tuning by briefly touching either ← or →.
- If you keep touching ← or → you can skip stations. Seek tuning starts as soon as you release the key.
- You can also perform seek tuning by holding the joystick left or right. 

Storing and recalling broadcast frequencies

If you touch any of the preset tuning keys **P1—P6** you can easily store up to six broadcast frequencies for later recall with the touch of a key.

● **When you find a frequency that you want to store in memory keep touching one of preset tuning keys P1—P6 until the beep sounds.**

The selected radio station frequency has been stored in memory.

The next time you touch the same preset tuning key the radio station frequency is recalled from memory.

- When **P1—P6** are not displayed, you can display them by touching **LIST**.



Notes

- Up to 18 FM stations, six for each of the three FM bands, and six AM stations can be stored in memory.
- You can also use ↑ and ↓ to recall radio station frequencies assigned to preset tuning keys **P1—P6** when **P1—P6** are not displayed. 

Introduction of advanced tuner operation

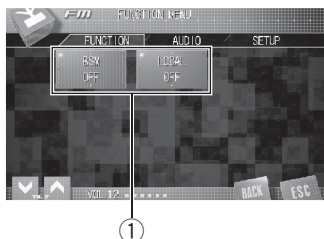

① Function display

Shows the function names.

1 Touch AV MENU and then touch FUNCTION to display the function names.

The function names are displayed and operable ones are highlighted.

2 Touch ESC to return to the frequency display.

- To return to the previous display, touch **BACK**. 

Tuning in strong signals

Local seek tuning lets you tune in only those radio stations with sufficiently strong signals for good reception.

● Touch LOCAL on the function menu to set the sensitivity.

Touch **LOCAL** repeatedly until the desired level of sensitivity appears in the display.

There are four levels of sensitivity for FM and two levels for AM:

FM: **OFF—LEVEL1—LEVEL2—LEVEL3—LEVEL4**

AM: **OFF—LEVEL1—LEVEL2**

The **LEVEL4** setting allows reception of only the strongest stations, while lower settings let you receive progressively weaker stations. 

Storing the strongest broadcast frequencies

BSM (best stations memory) lets you automatically store the six strongest broadcast frequencies under preset tuning keys **P1—P6** and once stored there you can tune in to those frequencies with the touch of a key.

● Touch BSM on the function menu to turn BSM on.

BSM begins to flash. While **BSM** is flashing the six strongest broadcast frequencies will be stored under preset tuning keys **P1—P6** in order of their signal strength. When finished, **BSM** stops flashing.

- To cancel the storage process, touch **BSM** again.

Note

Storing broadcast frequencies with BSM may replace broadcast frequencies you have saved using **P1—P6**. 

Watching a DVD video

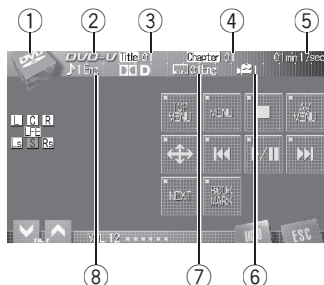

These are the basic steps necessary to play a DVD video with your DVD player. More advanced DVD video operation is explained starting on page 35.

① Source icon

Shows which source has been selected.

② DVD-V indicator

Shows when a DVD video is playing.

③ Title number indicator

Shows the title currently playing.

④ Chapter number indicator

Shows the chapter currently playing.

⑤ Play time indicator

Shows the elapsed playing time of the current chapter.

⑥ Viewing angle indicator

Shows which viewing angle has been selected.

⑦ Subtitle language indicator

Shows which subtitle language has been selected.

⑧ Audio language indicator

Shows which audio language has been selected.

1 Touch the source icon and then touch DVD to select the DVD player.

- If no disc is loaded in the unit, you cannot select **DVD** (DVD player). Insert a disc in the unit. (Refer to page 26.)
- With some discs, a menu may be displayed. (Refer to *Operating the DVD menu* on page 32.)

2 Touch the screen to display the touch panel keys.

3 To skip back or forward to another chapter, touch ◀◀ or ▶▶.

Touching ▶▶ skips to the start of the next chapter. Touching ◀◀ once skips to the start of the current chapter. Touching it again will skip to the previous chapter.

- You can also skip back or forward to another chapter by moving the joystick left or right.

4 To perform fast forward or reverse, keep touching ◀◀ or ▶▶.

If you keep touching ◀◀ or ▶▶ for five seconds, the icon ◀◀ or ▶▶ changes into reversal indication. When this happens, fast reverse/fast forward continues even if you release ◀◀ or ▶▶. To resume playback at a desired point, touch ▶/II.

- You can also perform fast reverse/fast forward by holding the joystick left or right.
- Fast forward/fast reverse may not be possible at certain locations on some discs. If this happens, normal playback automatically resumes.



Notes

- You can display the repeat range selected currently by touching **INFO**.
- If you do not use the touch panel keys within 30 seconds, they will be hidden automatically. ◻

Playing DVD discs

Listening to a DVD audio

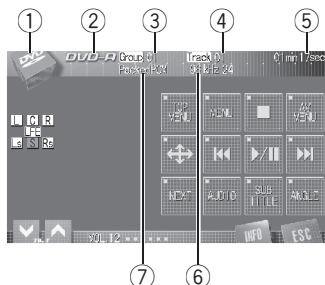

These are the basic steps necessary to play a DVD audio with your DVD player. More advanced DVD audio operation is explained starting on page 35.

① Source icon

Shows which source has been selected.

② DVD-A indicator

Shows when a DVD audio is playing.

③ Group number indicator

Shows the group currently playing.

④ Track number indicator

Shows the track number currently playing.

⑤ Play time indicator

Shows the elapsed playing time of the current track.

⑥ Sampling frequency and number of quantization bits indicator

Shows the sampling frequency and number of quantization bits of the current track.

⑦ Audio system indicator

Shows which audio system has been selected.

1 Touch the source icon and then touch DVD to select the DVD player.

- If no disc is loaded in the unit, you cannot select **DVD** (DVD player). Insert a disc in the unit. (Refer to page 26.)
- With some discs, a menu may be displayed. (Refer to *Operating the DVD menu* on the next page.)

2 Touch KEY to display the touch panel keys.

- When **KEY** is not displayed, you can display the touch panel keys by touching the screen.

3 To skip back or forward to another track, touch ◀◀ or ▶▶.

Touching ▶▶ skips to the start of the next track. Touching ◀◀ once skips to the start of the current track. Touching it again will skip to the previous track.

- You can also skip back or forward to another track by moving the joystick left or right.

4 To perform fast forward or reverse, keep touching ◀◀ or ▶▶.

If you keep touching ◀◀ or ▶▶ for five seconds, the icon ◀◀ or ▶▶ changes into reversal indication. When this happens, fast reverse/fast forward continues even if you release ◀◀ or ▶▶. To resume playback at a desired point, touch ▶/||.

- You can also perform fast reverse/fast forward by holding the joystick left or right.
- Fast forward/fast reverse may not be possible at certain locations on some discs. If this happens, normal playback automatically resumes.

Notes

- You can display the repeat range selected currently by touching **INFO**.
- If you do not use the touch panel keys within 30 seconds, they will be hidden automatically. 

Operating the DVD menu

Some DVDs allow you to select from the disc contents using a menu.

- You can display the menu by touching **MENU** or **TOP MENU** while a disc is playing. Touching either of these keys again lets you start playback from the location selected from the menu. For details, refer to the instructions provided with the disc.

Using DVD menu direct touch control

This function allows you to operate the DVD menu by touching the menu item directly.

- **Touch the desired menu item on the DVD menu directly.**
 - Depending on the contents of DVD discs, this function may not work properly. In this case, using touch panel keys operate the DVD menu.

Using the touch panel keys

1 Touch \leftrightarrow to display touch panel keys to operate the DVD menu.

- When the touch panel keys are not displayed, you can display them by touching the screen.

2 Touch $\wedge, \vee, < \text{ or } >$ to select the desired menu item.

3 Touch ENT.

Playback starts from the selected menu item.

- If you switch the remote control operation mode to **DVD**, the joystick on the remote control can also operate the DVD menu. (Refer to page 19.)
- You cannot operate the DVD menu from the joystick on the head unit.
- The way to display the menu differs depending on the disc.

Browsing still pictures

You can browse still pictures recorded on the disc during DVD audio playback.

- You cannot operate Slideshow. (Refer to *Slideshow* on page 126.)

1 Touch BROWSE to browse still pictures during playback.

2 Touch PAGE – or PAGE + to switch still pictures.

Touching **PAGE +** goes to the next still picture. Touching **PAGE –** returns to the previous still picture.

- To return to the initial still picture, touch **HOME**.
- If you switch the remote control operation mode to **DVD**, the joystick on the remote control can also browse still pictures. (Refer to page 19.)
- You cannot browse still pictures from the joystick on the head unit.

Skipping back or forward to another title/group

● **To skip back or forward to another title/group, touch \uparrow or \downarrow .**

Touching \uparrow skips to the start of the next title/group. Touching \downarrow skips to the start of the previous title/group.

Title/group numbers are displayed for eight seconds.

- You can also skip back or forward to another title/group by moving the joystick up or down.
- To switch between groups of touch panel keys, touch **NEXT** or **PREV**.

Playing DVD discs

Resume playback (Bookmark)

When playing DVD video discs, you can use this function.

The Bookmark function lets you resume playback from a selected scene the next time the disc is loaded.

- One bookmark point can be stored for each disc holder independently.

● During playback, touch **BOOKMARK** at the point you want to resume playback next time.

The selected scene will be bookmarked so that playback resumes from that point next time.

You can bookmark up to six discs. After that, the oldest bookmark is replaced by the new one.



- To clear the bookmark on a disc, keep touching **BOOKMARK** during playback.
- If you switch the remote control operation mode to **DVD**, you can also bookmark a disc using **BOOKMARK** on the remote control. (Refer to page 19.) 

Frame-by-frame playback

This lets you move ahead one frame at a time during playback.

● Touch during playback.

Each time you touch , you move ahead one frame.



- To return to normal playback, touch /II.
- To switch between groups of touch panel keys, touch **NEXT** or **PREV**.
- With some discs, images may be unclear during frame-by-frame playback. 

Slow motion playback

This lets you slow down playback speed.

● Keep touching until is displayed during playback.

The icon  is displayed, forward slow motion playback begins.

- You can adjust playback speed by pressing /II or II/ on the remote control during slow motion playback.
- To switch between groups of touch panel keys, touch **NEXT** or **PREV**.
- To return to normal playback, touch /II.

Notes

- There is no sound during slow motion playback.
- With some discs, images may be unclear during slow motion playback.
- Reverse slow motion playback is not possible. 

Searching for the part you want to play

You can use the search function to find the part you want to play.

For DVD video, you can select **TITLE** (title), **CHAPT** (chapter), **TIME** (time) or **10KEY** (numeric keypad).

For DVD audio, you can select **GROUP** (group), **TRACK** (track) or **10KEY** (numeric keypad).

- Chapter search, track search and time search are not possible when disc playback has been stopped.

1 Touch **SEARCH/10key**.

2 Touch the desired search option (e.g., **CHAPT**).

3 Touch 0—9 to input the desired number.

- To cancel the inputted numbers, touch **C**.

- You can also input the desired number by using the joystick and **0-9**.
- In the time search function, to select 1 hour 11 minutes, convert the time into 71 minutes 00 seconds and touch **7**, **1**, **0** and **0** in that order.

4 Touch ENTER.

This starts playback from the selected part.

Note

With discs featuring a menu, you can also touch **MENU** or **TOP MENU** and then make selections from the displayed menu. 

Changing audio language during playback (Multi-audio)

DVDs can provide audio playback with different languages and different systems (Dolby Digital, DTS etc.). With DVDs featuring multi-audio recordings, you can switch between languages/audio systems during playback.

● Touch **AUDIO** during playback.

Each time you touch **AUDIO** it switches between audio systems.

Notes

- With some DVDs, switching between languages/audio systems may only be possible using a menu display.
- You can also switch between languages/audio systems using **DVD SETUP MENU**. For details, refer to *Setting the audio language* on page 98.
- Display indications such as **Dolby D** and **Mch** indicate the audio system recorded on the DVD. Depending on the setting, playback may not be with the same audio system as that indicated.

- Touching **AUDIO** during fast forward/fast reverse, pause or slow motion playback returns you to normal playback. 

Changing the subtitle language during playback (Multi-subtitle)

With DVDs featuring multi-subtitle recordings, you can switch between subtitle languages during playback.

● Touch **SUBTITLE** during playback.

Each time you touch **SUBTITLE** it switches between subtitle languages.

Notes

- With some DVDs, switching between subtitle languages may only be possible using a menu display.
- You can also switch between subtitle languages using **DVD SETUP MENU**. For details, refer to *Setting the subtitle language* on page 98.
- Touching **SUBTITLE** during fast forward/fast reverse, pause or slow motion playback returns you to normal playback. 

Changing the viewing angle during playback (Multi-angle)

With DVDs featuring multi-angle (scenes shot from multiple angles) recordings, you can switch among viewing angles during playback.

- During playback of a scene shot from multiple angles, the angle icon  is displayed. Turn angle icon display on or off using **DVD SETUP MENU**. For details, refer to *Setting the angle icon display* on page 99.

Playing DVD discs

- **Touch ANGLE during playback of a scene shot from multiple angles.**

Each time you touch **ANGLE** it switches between angles.



Note

Touching **ANGLE** during fast forward/fast reverse, pause or slow motion playback returns you to normal playback.

Automatic playback of DVDs

When a DVD disc with DVD menu is inserted, this unit will cancel the DVD menu automatically and start playback from the first chapter of the first title.

- Some DVDs may not operate properly. If this function is not fully operated, turn this function off and start playback.

- **Touch AUTO PLAY to turn automatic playback on.**

- To turn automatic playback off, touch **AUTO PLAY** again.
- You can also turn automatic playback on or off by pressing **AUTO PLAY** button on the remote control.
- When the automatic playback is on, you cannot operate repeating play of DVD disc (refer to *Repeating play* on this page).

Introduction of advanced DVD operation

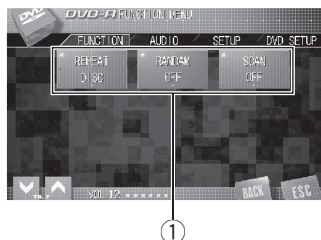

- ① **Function display**
Shows the function names.

- 1 **Touch AV MENU and then touch FUNCTION to display the function names.**

The function names are displayed and operable ones are highlighted.

- 2 **Touch ESC to return to the playback display.**

- To return to the previous display, touch **BACK**.

Repeating play

There are three repeat play ranges for DVD playback.

- **Touch REPEAT on the function menu to select the repeat range.**

Touch **REPEAT** repeatedly until the desired repeat range appears in the display.

During DVD video playback

- **DISC** – Play through the current disc
- **TITLE** – Repeat just the current title
- **CHAPTER** – Repeat just the current chapter

During DVD audio playback

- **DISC** – Play through the current disc
- **GROUP** – Repeat just the current group

- **TRACK** – Repeat just the current track

**Note**

If you perform chapter/track search or fast forward/reverse, the repeat play range changes to **DISC**.

Playing tracks in random order

Random play lets you play back tracks in a random order within the current group during DVD audio playback.

- **Touch RANDOM on the function menu to turn random play on.**

Tracks will play in a random order within the current group.

- To turn random play off, touch **RANDOM** again.

Scanning tracks

Scan play lets you hear the first 10 seconds of each track in the current group during DVD audio playback.

- 1 Touch SCAN on the function menu to turn scan play on.**

The first 10 seconds of each track of the current group is played.

- 2 When you find the desired track touch SCAN again.**

- After scanning is finished, normal playback of the tracks will begin again.

Selecting audio output

When playing DVD video discs recorded with LPCM audio, you can switch the audio output.

- This function is not possible when disc playback has been stopped.
- **Touch L/R SELECT on the function menu to select the audio output.**
Touch **L/R SELECT** repeatedly until the desired audio output appears in the display.
 - **L+R** – left and right
 - **LEFT** – left
 - **RIGHT** – right
 - **MIX** – mixing left and right

**Note**

Depending on the disc and the playback location on the disc, the function may not be selectable, indicating that operating this function is not possible.

Playing Video CDs

Watching a Video CD

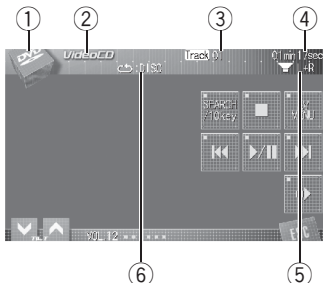

These are the basic steps necessary to play a Video CD with your DVD player. More advanced Video CD operation is explained starting on page 39.

- ① **Source icon**
Shows which source has been selected.
- ② **VideoCD indicator**
Shows when a Video CD is playing.
- ③ **Track number indicator**
Shows the track number currently playing.
- ④ **Play time indicator**
Shows the elapsed playing time of the current track.
- ⑤ **Audio output indicator**
Shows the output channel selected currently.
- ⑥ **Repeat indicator**
Shows the selected repeat range.

1 Touch the source icon and then touch DVD to select the DVD player.

- If no disc is loaded in the unit, you cannot select **DVD** (DVD player). Insert a disc in the unit. (Refer to page 26.)
- With a Video CD featuring the PBC (playback control) function, a menu is displayed. (Refer to *PBC playback* on this page.)

2 Touch the screen to display the touch panel keys.

3 To skip back or forward to another track, touch ◀◀ or ▶▶.

Touching ▶▶ skips to the start of the next track. Touching ◀◀ once skips to the start of the current track. Touching it again will skip to the previous track.

- You can also skip back or forward to another track by moving the joystick left or right.
- During PBC playback, a menu may be displayed if you perform these operations.

4 To perform fast forward or reverse, keep touching ◀◀ or ▶▶.

If you keep touching ◀◀ or ▶▶ for five seconds, the icon ◀◀ or ▶▶ changes into reversal indication. When this happens, fast reverse/fast forward continues even if you release ◀◀ or ▶▶. To resume playback at a desired point, touch ▶/||.

- You can also perform fast reverse/fast forward by holding the joystick left or right.
- Fast forward/fast reverse may not be possible at certain locations on some discs. If this happens, normal playback automatically resumes.



Note

If you do not use the touch panel keys within 30 seconds, they will be hidden automatically. ■

PBC playback

During playback of Video CDs featuring PBC (Playback Control), **PBC:ON** is displayed. You can operate PBC menu with **10KEY**.

1 When PBC menu is displayed, touch SEARCH/10key and then touch 10KEY.

- Depending on the discs, the menu may be two or more pages long. In such case, touch ◀◀ or ▶▶ to display the next or previous menu.

Playing Video CDs

2 Touch 0—9 corresponding to a menu number and then touch ENTER to start playback.

Playback starts from the selected menu item.

3 Touch ESC to hide the touch panel keys.



Notes

- You can display the menu by touching **↓** during PBC playback. For details, refer to the instructions provided with the disc.
- PBC playback of Video-CD cannot be cancelled.
- During playback of Video CDs featuring PBC (Playback Control), **PBC:ON**, search and time search functions cannot be used nor can you select the range for repeat play. 

Frame-by-frame playback

This lets you move ahead one frame at a time during playback.

● Touch **⏮** during playback.

Each time you touch **⏮**, you move ahead one frame.

- To return to normal playback, touch **▶/II**.
- With some discs, images may be unclear during frame-by-frame playback. 

Slow motion playback

This lets you slow down playback speed.

● Keep touching **⏮** until **⏮** is displayed during playback.

The icon **⏮** is displayed, forward slow motion playback begins.

- You can adjust playback speed by pressing **◀II** or **II▶** on the remote control during slow motion playback.
- To return to normal playback, touch **▶/II**.



Notes

- There is no sound during slow motion playback.
- With some discs, images may be unclear during slow motion playback.
- Reverse slow motion playback is not possible. 

Searching for a desired scene, starting playback from a specified time

You can use the search function to search for a desired scene by specifying a track, and the time search function to specify the time on a disc at which play starts.

- During playback of Video CDs featuring PBC (playback control), this function cannot be operated.
- Time search is not possible when disc playback has been stopped.

1 Touch **SEARCH/10key**.

2 Touch **TRACK (track), TIME (time) or 10KEY (numeric keypad)**.

3 Touch **0—9** to input the desired number.

- To cancel the inputted numbers, touch **C**.
- You can also input the desired number by using the joystick and **0-9**.
- In the time search function, to select 1 hour 11 minutes, convert the time into 71 minutes 00 seconds and touch **7, 1, 0** and **0** in that order.

4 Touch **ENTER**.

This starts playback from the selected scene. 

Playing Video CDs

Introduction of advanced Video CD operation

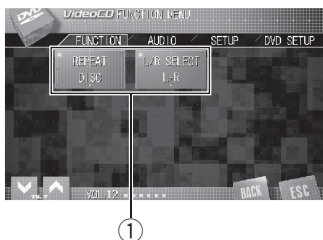

① Function display

Shows the function names.

1 Touch AV MENU and then touch FUNCTION to display the function names.

The function names are displayed and operable ones are highlighted.

2 Touch ESC to return to the playback display.

- To return to the previous display, touch **BACK**.

Repeating play

There are two repeat play ranges for the Video CD playback: **TRACK** (track repeat) and **DISC** (disc repeat).

- During playback of Video CDs featuring PBC (playback control), this function cannot be operated.
- **Touch REPEAT on the function menu to select the repeat range.**
Touch **REPEAT** repeatedly until the desired repeat range appears in the display.
 - **DISC** – Repeat the current disc
 - **TRACK** – Repeat just the current track

Note

If you perform track search or fast forward/reverse, the repeat play range changes to **DISC**.

Selecting audio output

You can switch between stereo and monaural audio output.

- This function is not possible when disc playback has been stopped.
- **Touch L/R SELECT on the function menu to select the audio output.**
Touch **L/R SELECT** repeatedly until the desired audio output appears in the display.
 - **L+R** – left and right
 - **LEFT** – left
 - **RIGHT** – right
 - **MIX** – mixing left and right

Listening to a CD

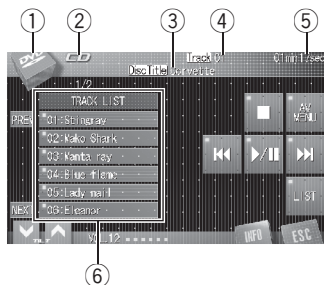

These are the basic steps necessary to play a CD with your DVD player. More advanced CD operation is explained starting on the next page.

- ① **Source icon**
Shows which source has been selected.
- ② **CD indicator**
Shows when a CD is playing.
- ③ **Disc title indicator**
Shows the title of the currently playing disc only when playing CD TEXT discs.
- ④ **Track number indicator**
Shows the track number currently playing.
- ⑤ **Play time indicator**
Shows the elapsed playing time of the current track.
- ⑥ **Track list display**
Shows the track title list.

1 Touch the source icon and then touch DVD to select the DVD player.

- If no disc is loaded in the unit, you cannot select **DVD** (DVD player). Insert a disc in the unit. (Refer to page 26.)

2 To skip back or forward to another track, touch ◀◀ or ▶▶.

Touching ▶▶ skips to the start of the next track. Touching ◀◀ once skips to the start of

the current track. Touching it again will skip to the previous track.

- You can also skip back or forward to another track by moving the joystick left or right.

3 To perform fast forward or reverse, keep touching ◀◀ or ▶▶.

- You can also perform fast reverse/fast forward by holding the joystick left or right. ◻

Selecting tracks from the track title list

Track title list lets you see the list of tracks on a disc and select one of them to play back. When playing a CD TEXT disc, track titles are displayed.

1 Touch PREV or NEXT to switch between the lists of titles.

- When the list of tracks is not displayed, touch **LIST**.

2 Touch your favorite track title.

That selection will begin to play. ◻

Displaying text information on CD TEXT discs

Some discs have certain information encoded on the disc during manufacture. These discs may contain such information as the CD title, track title, artist's name and playback time and are called CD TEXT discs. Text information recorded on a CD TEXT disc can be displayed.

● Touch INFO.

Touch **INFO** repeatedly to switch between the following settings:

Disc Title (disc title)—**DiscArtist** (disc artist name)—**Track Title** (track title)—**TrackArtist** (track artist name)

- If specific information has not been recorded on a CD TEXT disc, **No XXXX** will be displayed (e.g., **No Name**). ◻

Playing CDs

Introduction of advanced CD operation

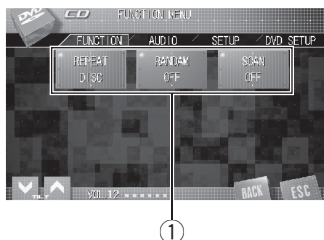

① Function display

Shows the function names.

1 Touch AV MENU and then touch FUNCTION to display the function names.

The function names are displayed and operable ones are highlighted.

2 Touch ESC to return to the playback display.

- To return to the previous display, touch **BACK**.

Repeating play

There are two repeat play ranges for the CD playback: **TRACK** (track repeat) and **DISC** (disc repeat).

● Touch REPEAT on the function menu to select the repeat range.

Touch **REPEAT** repeatedly until the desired repeat range appears in the display.

- **DISC** – Repeat the current disc
- **TRACK** – Repeat just the current track

Note

If you perform track search or fast forward/reverse, the repeat play range changes to **DISC**.

Playing tracks in random order

Random play lets you play back tracks on the CD in a random order.

● Touch RANDOM on the function menu to turn random play on.

Tracks will play in a random order.

- To turn random play off, touch **RANDOM** again.

Scanning tracks of a CD

Scan play lets you hear the first 10 seconds of each track on the CD.

1 Touch SCAN on the function menu to turn scan play on.

The first 10 seconds of each track is played.

2 When you find the desired track touch SCAN again.

- After scanning of a CD is finished, normal playback of the tracks will begin again.

Playing MP3/WMA/AAC files

Listening to MP3/WMA/AAC

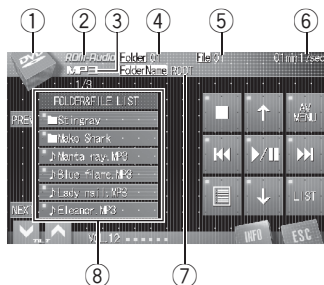

These are the basic steps necessary to play an MP3/WMA/AAC with your DVD player. More advanced MP3/WMA/AAC operation is explained starting on page 44.

- ① **Source icon**
Shows which source has been selected.
- ② **ROM-Audio indicator**
Shows when a compressed audio (MP3/WMA/AAC) file is playing.
- ③ **MP3/WMA/AAC indicator**
Shows the type of file currently playing.
- ④ **Folder number indicator**
Shows the folder number currently playing.
- ⑤ **File number indicator**
Shows the file number currently playing.
- ⑥ **Play time indicator**
Shows the elapsed playing time of the current file.
- ⑦ **Folder name indicator**
Shows the name of the currently playing folder.
- ⑧ **Folder and file name list**
Shows the list of folder and file name.

1 Touch the source icon and then touch DVD to select the DVD player.

- If no disc is loaded in the unit, you cannot select **DVD** (DVD player). Insert a disc in the unit. (Refer to page 26.)

2 Touch ↑ or ↓ to select a folder.

- You can also select a folder by moving the joystick up or down.
 - To return to folder **01** (ROOT), press and hold **BAND/ESC**. However, if folder **01** (ROOT) contains no files, playback commences with folder **02**.
 - You cannot select a folder that does not have an MP3/WMA/AAC file recorded in it.

3 To skip back or forward to another track, touch ◀◀ or ▶▶.

- Touching ▶▶ skips to the start of the next track. Touching ◀◀ once skips to the start of the current track. Touching it again will skip to the previous track.
- You can also skip back or forward to another track by moving the joystick left or right.

4 To perform fast forward or reverse, keep touching ◀◀ or ▶▶.

- You can also perform fast reverse/fast forward by holding the joystick left or right.



Notes

- This DVD player can play back an MP3/WMA/AAC file recorded on CD-R/RW/ROM and DVD-R/RW/ROM. (Refer to page 115 for files that can be played back.)
- Playback is carried out in order of file number. Folders are skipped if they contain no files. (If folder **01** (ROOT) contains no files, playback commences with folder **02**.)
- When playing back files recorded as VBR (variable bit rate) files, the play time will not be correctly displayed if fast forward or reverse operations are used.
- There is no sound on fast forward or reverse. ■

Playing MP3/WMA/AAC files

Selecting tracks from the file name list

File name list lets you see the list of file names (or folder names) and select one of them to playback.

1 Touch **PREV** or **NEXT** to switch between the lists of names.

- When the list of file names is not displayed, touch **LIST**.

2 Touch your favorite file name (or folder name).

That selection will begin to play.

- When you have selected a folder, a list of the names of the files (or the folders) in it can be viewed. Repeat steps 1 and 2 to select the desired file name.
- To return to the previous list (the folder one level higher), touch **J**.

Displaying information on MP3/WMA/AAC file

Information recorded on an MP3/WMA/AAC disc can be displayed.

● Touch **■** to display information on the MP3/WMA/AAC file you are currently playing.

- **ALBUM** (album title)
- **TRACK** (track title)
- **FOLDER** (folder name)
- **FILE** (file name)
- **ARTIST** (artist name)
- **GENRE** (genre)
- **YEAR** (year)
- When playing back WMA files, lists of album title, genre and year appear in blank.
- If specific information has not been recorded on an MP3/WMA/AAC file, **no xxxx** will be displayed in the list (e.g., **No Data**).

- Depending on the version of ID3 tag or Windows Media Player, the information may not be displayed correctly.

Displaying text information on MP3/WMA/AAC disc

Text information recorded on an MP3/WMA/AAC disc can be displayed.

● Touch **INFO**.

Touch **INFO** repeatedly to switch between the following settings:

Folder Name (folder name)—**File Name** (file name)—**Album** (album title)—**Track** (track title)—**Artist** (artist name)

- If specific information has not been recorded on an MP3/WMA/AAC disc, **no xxxx** will be displayed (e.g., **no artist**).
- Depending on the version of Windows Media Player used to encode WMA files, album names and other text information may not be correctly displayed. **■**

Playing MP3/WMA/AAC files

Introduction of advanced built-in DVD player (MP3/WMA/AAC) operation

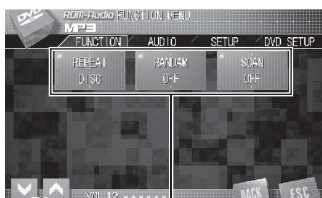

① Function display

Shows the function names.

1 Touch AV MENU and then touch FUNCTION to display the function names.

The function names are displayed and operable ones are highlighted.

2 Touch ESC to return to the playback display.

- To return to the previous display, touch **BACK**.

Repeating play

For MP3/WMA/AAC playback, there are three repeat play ranges: **FOLDER** (folder repeat), **FILE** (one-track repeat) and **DISC** (repeat all tracks).

● Touch REPEAT on the function menu to select the repeat range.

Touch **REPEAT** repeatedly until the desired repeat range appears in the display.

- **DISC** – Repeat all tracks
- **FOLDER** – Repeat the current folder
- **FILE** – Repeat just the current track

Notes

- If you select another folder during repeat play, the repeat play range changes to **DISC**.

- If you perform track search or fast forward/reverse during **FILE**, the repeat play range changes to **FOLDER**.
- When **FOLDER** is selected, it is not possible to play back a subfolder of that folder.

Playing tracks in random order

Random play lets you play back tracks in a random order within the repeat range, **FOLDER** and **DISC**.

1 Select the repeat range.

Refer to *Repeating play* on this page.

2 Touch RANDOM on the function menu to turn random play on.

Tracks will play in a random order within the previously selected **FOLDER** or **DISC** ranges.

- To turn random play off, touch **RANDOM** again.

Scanning folders and tracks

While you are using **FOLDER**, the beginning of each track in the selected folder plays for about 10 seconds. When you are using **DISC**, the beginning of the first track of each folder is played for about 10 seconds.

1 Select the repeat range.

Refer to *Repeating play* on this page.

2 Touch SCAN on the function menu to turn scan play on.

The first 10 seconds of each track of the current folder (or the first track of each folder) is played.

3 When you find the desired track (or folder) touch SCAN again.

- After track or folder scanning is finished, normal playback of the tracks will begin again.

Playing DivX/JPEG files

Watching a DivX/JPEG

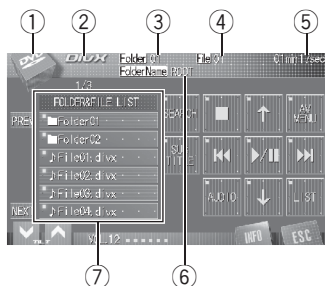

These are the basic steps necessary to play a DivX/JPEG with your DVD player. More advanced DivX/JPEG operation is explained starting on page 49.

- ① **Source icon**
Shows which source has been selected.
- ② **DivX/JPEG indicator**
Shows the type of file currently playing.
- ③ **Folder number indicator**
Shows the folder number currently playing.
- ④ **File number indicator**
Shows the file number currently playing.
- ⑤ **Play time indicator**
Shows the elapsed playing time of the current file.
 - When playing a JPEG disc, play time indicator does not appear.
- ⑥ **Folder name indicator**
Shows the name of the currently playing folder.
- ⑦ **Folder and file name list**
Shows the list of folder and file name.

1 Touch the source icon and then touch DVD to select the DVD player.

- If no disc is loaded in the unit, you cannot select **DVD** (DVD player). Insert a disc in the unit. (Refer to page 26.)

2 Touch the screen to display the touch panel keys.

3 Touch ↑ or ↓ to select a folder.

- You can also select a folder by moving the joystick up or down.
- To return to folder **01** (ROOT), press and hold **BAND/ESC**. However, if folder **01** (ROOT) contains no files, playback commences with folder **02**.
- You cannot select a folder that does not have a DivX/JPEG file recorded in it.

4 To skip back or forward to another file, touch ◀◀ or ▶▶.

Touching ▶▶ skips to the start of the next file. Touching ◀◀ once skips to the start of the current file. Touching it again will skip to the previous file.

- You can also skip back or forward to another file by moving the joystick left or right.

5 To perform fast forward or reverse, keep touching ◀◀ or ▶▶.

If you keep touching ◀◀ or ▶▶ for five seconds, the icon ◀◀ or ▶▶ changes into reversal indication. When this happens, fast reverse/fast forward continues even if you release ◀◀ or ▶▶. To resume playback at a desired point, touch ▶/II.

- You can also perform fast reverse/fast forward by holding the joystick left or right.
- This is fast forward and reverse operation only for the file being played. This operation is canceled when the previous or next file is reached.
- When playing a JPEG disc, this operation cannot be performed.

**Notes**

- This DVD player can play back a DivX file recorded on CD-R/RW/ROM and DVD-R/RW/ROM. (Refer to page 118 for files that can be played back.)
- This DVD player can play back a JPEG file recorded on CD-R/RW/ROM. (Refer to page 117 for files that can be played back.)
- Playback is carried out in order of file number. Folders are skipped if they contain no files. (If folder **01** (ROOT) contains no files, playback commences with folder **02**.)
- There is no sound on fast forward or reverse.
- If you do not use the touch panel keys within 30 seconds, they will be hidden automatically.

Viewing a JPEG slideshow

When loading a CD/CD-R/RW containing JPEG picture files, this unit automatically starts a slideshow from the first folder/picture on the disc. The player displays the pictures in each folder in alphabetical order.

The table below shows the controls for viewing a slideshow.

Key	What it does
	Starts the slideshow, pauses the slideshow or restarts a paused disc.
	Displays the previous picture.
	Displays the next picture.
	Rotates the displayed picture 90° clockwise.



When you load a disc containing this type of DivX VOD content, the remaining number of plays is shown on-screen and you then have the option of playing the disc (thereby using up one of the remaining plays), or stopping. If you load a disc that contains expired DivX VOD content (for example, content that has zero remaining plays), **Rental expired** is displayed.

- If your DivX VOD content allows an unlimited number of plays, then you may load the disc into your player and play the content as often as you like, and no message will be displayed.

**Important**

- In order to play DivX VOD content on this unit, you first need to register the unit with your DivX VOD content provider. About your registration code, refer to *Displaying your DivX® VOD registration code* on page 101.
- DivX VOD content is protected by a DRM (Digital Rights Management) system. This restricts playback of content to specific, registered devices.

● **If the message is displayed after loading a disc containing DivX VOD content, touch PLAY.**

Playback of the DivX VOD content will start.

- To skip to the next file, touch **NEXT PLAY**.
- If you do not want to play the DivX VOD content, touch **STOP**.

Playing DivX® VOD content

Some DivX VOD (video on demand) content may only be playable a fixed number of times.

Playing DivX/JPEG files

Selecting files from the file name list

File name list lets you see the list of file names (or folder names) and select one of them to playback.

1 Touch PREV or NEXT to switch between the lists of names.

- When the list of file names is not displayed, touch **LIST**.

2 Touch your favorite file name (or folder name).

That selection will begin to play.

- When you have selected a folder, a list of the names of the files (or the folders) in it can be viewed. Repeat steps 1 and 2 to select the desired file name.
- To return to the previous list (the folder one level higher), touch **J**.

Displaying text information on DivX/JPEG disc

Text information recorded on a DivX/JPEG disc can be displayed.

● Touch INFO.

Touch **INFO** repeatedly to switch between the following settings:

Folder Name (folder name)—**File Name** (file name) 

Frame-by-frame playback

This lets you move ahead one frame at a time during DivX playback.

● Press **II▶** on the remote control during playback.

Each time you press **II▶**, you move ahead one frame.

- To return to normal playback, touch **▶/II**.
- With some discs, images may be unclear during frame-by-frame playback. 

Slow motion playback

When playing DivX video file, this lets you slow down playback speed.

● Press **II▶** on the remote control until **▶** is displayed during playback.

The icon **▶** is displayed, forward slow motion playback begins.

- To return to normal playback, touch **▶/II**.

Notes

- There is no sound during slow motion playback.
- With some discs, images may be unclear during slow motion playback.
- Reverse slow motion playback is not possible. 

Searching for the part you want to play

When playing DivX video file, you can use the time search function to find the part you want to play.

- Time search is not possible when disc playback has been stopped.

1 Touch **SEARCH**.

2 Touch 0—9 to input the desired number.

- To cancel the inputted numbers, touch **C**.
- To select 1 hour 11 minutes, convert the time into 71 minutes 00 seconds and touch **7**, **1**, **0** and **0** in that order.
- You can also input the desired number by using the joystick and **0-9**.

3 Touch ENTER.

This starts playback from the selected part. 

Changing audio language during playback (Multi-audio)

When playing a DivX video disc recorded with dialog in two or more languages, you can switch audio language during playback.

● Touch **AUDIO** during playback.

Each time you touch **AUDIO** it switches between audio systems.



Note

Touching **AUDIO** during fast forward/fast reverse, pause or slow motion playback returns you to normal playback. 

Changing the subtitle language during playback (Multi-subtitle)

When playing a DivX video disc recorded with subtitles in one or more languages, you can switch subtitle language during playback.

● Touch **SUBTITLE** during playback.

Each time you touch **SUBTITLE** it switches between subtitle languages.



Note

Touching **SUBTITLE** during fast forward/fast reverse, pause or slow motion playback returns you to normal playback. 

Playing DivX/JPEG files

Introduction of advanced built-in DVD player (DivX/JPEG) operation

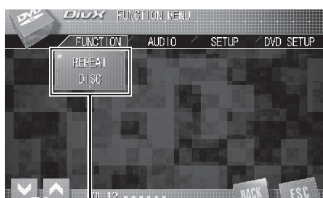

①

① Function display

Shows the function names.

1 Touch AV MENU and then touch FUNCTION to display the function names.

The function names are displayed and operable ones are highlighted.

2 Touch ESC to return to the playback display.

- To return to the previous display, touch **BACK**.

Repeating play

For DivX video file playback, there are three repeat play ranges: **FOLDER** (folder repeat), **FILE** (file repeat) and **DISC** (repeat all files).

For JPEG picture file playback, there are two repeat play ranges: **FOLDER** (folder repeat) and **DISC** (repeat all files).

● Touch REPEAT on the function menu to select the repeat range.

Touch **REPEAT** repeatedly until the desired repeat range appears in the display.

- **DISC** – Repeat all files
- **FOLDER** – Repeat the current folder

- **FILE** – Repeat just the current file

Notes

- If you select another folder during repeat play, the repeat play range changes to **DISC**.
- If you perform track search or fast forward/reverse during **FILE**, the repeat play range changes to **FOLDER**.
- When **FOLDER** is selected, it is not possible to play back a subfolder of that folder.

Playing files in random order

When playing a JPEG disc, random play lets you play back files in a random order within the repeat range, **FOLDER** and **DISC**.

1 Select the repeat range.

Refer to *Repeating play* on this page.

2 Touch RANDOM on the function menu to turn random play on.

Files will play in a random order within the previously selected **FOLDER** or **DISC** ranges.

- To turn random play off, touch **RANDOM** again.

Listening to a CD

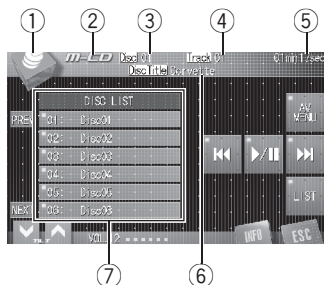

You can use this unit to control a multi-CD player, which is sold separately.

These are the basic steps necessary to play a CD with your multi-CD player. More advanced CD operation is explained starting on page 52.

- This unit does not have a disc title input function.
- Only those functions described in this manual are supported by 50-disc multi-CD players.

① Source icon

Shows which source has been selected.

② Source name

Shows the selected source name.

③ Disc number indicator

Shows the disc number currently playing.

④ Track number indicator

Shows the track number currently playing.

⑤ Play time indicator

Shows the elapsed playing time of the current track.

⑥ Disc title indicator

Shows the title of the currently playing disc only when playing CD TEXT discs.

⑦ Disc list display

Shows the disc title list.

1 Touch the source icon and then touch M-CD to select the multi-CD player.

2 Touch any of 01—06 to select a disc you want to listen to.

If you want to select a disc located at 7 to 12, touch **PREV** or **NEXT** to display **07—12**.

- When **01—06** and **07—12** are not displayed, you can display them by touching **LIST**.
- You can also sequentially select a disc by using **↑/↓** when **DISC LIST** is not displayed.

3 To skip back or forward to another track, touch **⏮ or **⏭**.**

Touching **⏭** skips to the start of the next track. Touching **⏮** once skips to the start of the current track. Touching it again will skip to the previous track.

- You can also skip back or forward to another track by moving the joystick left or right.

4 To perform fast forward or reverse, keep touching **⏮ or **⏭**.**

- You can also perform fast reverse/fast forward by holding the joystick left or right.



Notes

- When the multi-CD player performs the preparatory operations, **READY** is displayed.
- If an error message such as **ERROR-02** is displayed, refer to the multi-CD player owner's manual.
- If there are no discs in the multi-CD player magazine, **NO DISC** is displayed.
- If you do not use the touch panel keys within 30 seconds, they will be hidden automatically.

Multi-CD Player

Pausing CD playback

Pause lets you temporarily stop disc playback.

- **Touch ►/|| to turn pause on.**

Playback of the current track pauses.

- To turn pause off, touch ►/|| again. 

Selecting tracks from the track title list

Track title list lets you see the list of tracks on a disc and select one of them to play back.

When playing a CD TEXT disc, track titles are displayed.

- 1 Touch LIST to display track list.**

Each time you touch **LIST** it selects lists in the following order:

DISC LIST (disc list)—**TRACK LIST** (track list)
—no list displays

- 2 Touch PREV or NEXT to switch between the lists of titles.**

- 3 Touch your favorite track title.**

That selection will begin to play. 

Displaying text information on CD TEXT discs

You can use these functions only with a CD TEXT compatible multi-CD player.

Some discs have certain information encoded on the disc during manufacture. These discs may contain such information as the CD title, track title, artist's name and playback time and are called CD TEXT discs. Text information recorded on a CD TEXT disc can be displayed.

- **Touch INFO.**

Touch **INFO** repeatedly to switch between the following settings:

Disc Title (disc title)—**DiscArtist** (disc artist name)—**Track Title** (track title)—**TrackArtist** (track artist name)

- If specific information has not been recorded on a CD TEXT disc, **No XXXX** will be displayed (e.g., **No Name**). 

Introduction of advanced multi-CD player operation

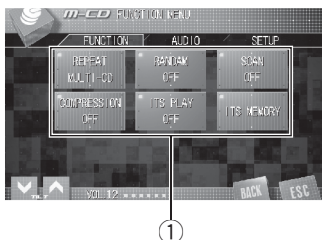

① Function display

Shows the function names.

1 Touch AV MENU and then touch FUNCTION to display the function names.

The function names are displayed and operable ones are highlighted.

2 Touch ESC to return to the playback display.

- To return to the previous display, touch **BACK**

Repeating play

There are three repeat play ranges for the multi-CD player: **MULTI-CD** (multi-CD player repeat), **TRACK** (one-track repeat) and **DISC** (disc repeat).

● Touch REPEAT on the function menu to select the repeat range.

Touch **REPEAT** repeatedly until the desired repeat range appears in the display.

- **MULTI-CD** – Repeat all discs in the multi-CD player
- **TRACK** – Repeat just the current track
- **DISC** – Repeat the current disc

Notes

- If you select other discs during repeat play, the repeat play range changes to **MULTI-CD**.
- If you perform track search or fast forward/reverse during **TRACK**, the repeat play range changes to **DISC**.

Playing tracks in random order

Random play lets you play back tracks in random order within the repeat range, **MULTI-CD** and **DISC**.

1 Select the repeat range.

Refer to *Repeating play* on this page.

2 Touch RANDOM on the function menu to turn random play on.

Tracks will play in a random order within the previously selected **MULTI-CD** or **DISC** ranges.

- To turn random play off, touch **RANDOM** again.

Scanning CDs and tracks

While you are using **DISC**, the beginning of each track on the selected disc plays for about 10 seconds. When you are using **MULTI-CD**, the beginning of the first track of each disc is played for about 10 seconds.

1 Select the repeat range.

Refer to *Repeating play* on this page.

2 Touch SCAN on the function menu to turn scan play on.

The first 10 seconds of each track of the current disc (or the first track of each disc) is played.

Multi-CD Player

3 When you find the desired track (or disc) touch SCAN again.

- After track or disc scanning is finished, normal playback of the tracks will begin again. 

Using compression and bass emphasis

You can use these functions only with a multi-CD player that supports them.

Using COMP (compression) and DBE (dynamic bass emphasis) functions lets you adjust the sound playback quality of the multi-CD player. Each of the functions has a two-step adjustment. The COMP function balances the output of louder and softer sounds at higher volumes. DBE boosts bass levels to give playback a fuller sound. Listen to each of the effects as you select them and use the one that best enhances the playback of the track or CD that you are listening to.

● Touch COMPRESSION on the function menu to select your favorite setting.

Touch **COMPRESSION** repeatedly to switch between the following settings:

OFF—COMP1—COMP2—OFF—DBE1—DBE2

- If the multi-CD player does not support COMP/DBE, **NO COMP** is displayed and **COMPRESSION** cannot be operated. 

Using ITS playlists

ITS (instant track selection) lets you make a playlist of favorite tracks from those in the multi-CD player magazine. After you have added your favorite tracks to the playlist you can turn on ITS play and play just those selections.

Creating a playlist with ITS programming

You can use ITS to enter and play back up to 99 tracks per disc from up to 100 discs (with the disc titles). (With multi-CD players sold before the CDX-P1250 and CDX-P650, up to 24 tracks can be stored in the playlist.)

- 1 Play a CD that you want to program.
- 2 Touch **ITS MEMORY** on the function menu.
- 3 Touch **< or >** to select the desired track.
- 4 Touch **MEMORY** to store the currently playing track in the playlist.

MEMORY is displayed briefly and the currently playing selection is added to your playlist. The display then shows track number again.

- After data for 100 discs has been stored in memory, data for a new disc will overwrite the oldest one.

Playback from your ITS playlist

ITS play lets you listen to the tracks that you have entered into your ITS playlist. When you turn on ITS play, tracks from your ITS playlist in the multi-CD player will begin to play.

- 1 Select the repeat range.
Refer to *Repeating play* on the previous page.
- 2 Touch **ITS PLAY** on the function menu to turn ITS play on.
Playback begins of those tracks from your playlist within the previously selected **MULTI-CD** or **DISC** ranges.
 - If no tracks in the current range are programmed for ITS play, then **ITS EMPTY** is displayed.
 - To turn ITS play off, touch **ITS PLAY** again.

Erasing a track from your ITS playlist

You can delete a track from your ITS playlist if ITS play is on.

If ITS play is already on, skip to step 2.

1 Play the CD with the track you want to delete from your ITS playlist, and turn ITS play on.

Refer to *Playback from your ITS playlist* on the previous page.

2 Touch ITS MEMORY on the function menu.

3 Touch < or > to select the desired track.

4 Touch CLEAR to erase the track from your ITS playlist.

The currently playing selection is erased from your ITS playlist and playback of the next track from your ITS playlist begins.

- If there are no tracks from your playlist in the current range, **ITS EMPTY** is displayed and normal play resumes.

Erasing a CD from your ITS playlist

You can delete all tracks of a CD from your ITS playlist if ITS play is off.

1 Play the CD that you want to delete.

2 Touch ITS MEMORY on the function menu.

3 Touch CLEAR to erase all tracks on the currently playing CD from your ITS playlist.

All tracks on the currently playing CD are erased from your playlist and **CLEAR** is displayed.

Playing songs on iPod

Listening to songs on your iPod

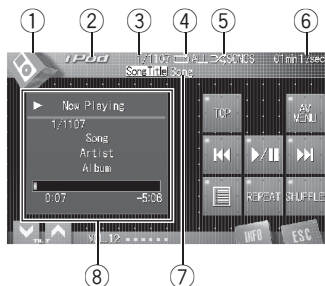

You can use this unit to control an iPod adapter, which is sold separately.

- ① **Source icon**
Shows which source has been selected.
- ② **Source name**
Shows the selected source name.
- ③ **Song number indicator**
Shows the number of song played in the selected list.
- ④ **Repeat indicator**
Shows when repeat range is selected to current track.
- ⑤ **Shuffle indicator**
Shows when random play is set to **SONGS** or **ALBUMS**.
- ⑥ **Play time indicator**
Shows the elapsed playing time of the current song.
- ⑦ **Song title indicator**
Shows the title of the currently playing song.

⑧ Song information

Shows detailed information of currently playing song.

1 Touch the source icon and then touch iPod to select the iPod.

When the iPod is not connected to this unit, you cannot select the iPod as a source.

2 To skip back or forward to another song, touch ◀◀ or ▶▶.

Touching ▶▶ skips to the start of the next song. Touching ◀◀ once skips to the start of the current song. Touching it again will skip to the previous song.

3 To perform fast forward or reverse, keep touching ◀◀ or ▶▶.

Browsing for a song

The operation of this unit to control an iPod is designed to be as close to the operation of the iPod as possible for easy operation and song search.

1 Touch TOP to display the top menu.

2 Touch one of the categories in which you want to search for a song.

- **Playlists** (playlists)
- **Artists** (artists)
- **Albums** (albums)
- **Songs** (songs)
- **Genres** (genres)

3 Touch a list title that you want to play.

Repeat this operation until you find the desired song.

- You can start playback throughout the selected list by touching and holding desired list title.
- You can start a playback of all the songs in the selected list (**Genres**, **Artists** or **Albums**). To do this, touch **ALL**.

Playing songs on iPod

- To go to the next group of list titles, touch **NEXT**.
- To return to the previous group of list titles, touch **PREV**.
- To return to the previous menu, touch **⬅**.
- To go to the top menu of the list search, touch **TOP**.
- If the playback stops for any reason, touch **TOP** and refine your search for a song. 

Pausing a song

Pause lets you temporarily stop playback of a song.

- Touch **▶/||** during playback. **PAUSE** appears in the display.
 - To resume playback at the same point that you turned pause on, touch **▶/||** again. 

Displaying text information on iPod

Text information recorded on the iPod can be displayed on the information bar.

- Touch **INFO**. Touch **INFO** repeatedly to switch between the following settings:
 - Song Title** (song title)—**Artist** (artist name)—**Album** (album title)
 - If the characters recorded on the iPod are not compatible with this unit, those characters will not be displayed. 

Displaying information on song

Song title, artist name, album title of the currently playing song can be displayed (if they have been entered in iPod) together with the index and the remaining playback time in the form of the status bar.

- Touch  to display information on the song you are currently playing.

Song information is displayed.

- Status bar shows the remaining playback time. The bar is filled up from the left to the right as the playback time is consumed. 

Repeating play

For playback of the songs on the iPod, there are two repeat play ranges: **ONE** (repeat one song) and **ALL** (repeat all songs in the list).

- While this unit is set to repeat one song, you cannot select the other songs.

- Touch **REPEAT** to select the repeat range.

Touch **REPEAT** repeatedly until the desired repeat range appears in the display.

- **ONE** – Repeat just the current song
- **ALL** – Repeat all songs in the selected list 

Playing songs in a random order (shuffle)

For playback of the songs on the iPod, there are two random play methods: **SONGS** (play back songs in a random order) and **ALBUMS** (play back albums in a random order).

- Touch **SHUFFLE** to select the random play method.

Touch **SHUFFLE** repeatedly until the desired random play method appears in the display.

- **SONGS** – Play back songs in a random order within the selected list
- **ALBUMS** – Select an album randomly, and then play back all the songs in it in order
 - To cancel the random play, touch **SHUFFLE** repeatedly until the shuffle icon is turned off. 

Listening to songs on BT Audio (Bluetooth audio player)

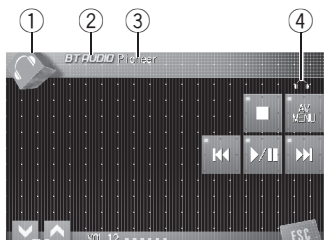

If you connect Bluetooth adapter (e.g. **CD-BTB100**) to this unit, you can control Bluetooth audio player via Bluetooth wireless technology.

- In some countries, **CD-BTB100** is not sold on the market.

For details concerning operation, refer to the Bluetooth adapter's operation manual. This section provides brief information on Bluetooth audio player operations with this unit which slightly differs or is cut short from that described in the Bluetooth adapter's operation manual.

- Even though your audio player does not contain a Bluetooth module, you can still control it from this unit via Bluetooth wireless technology. To control your audio player by using this unit, connect a product featuring Bluetooth wireless technology (available on the market) to your audio player and connect Bluetooth adapter (e.g. **CD-BTB100**) to this unit.



Important

- Depending on the Bluetooth audio player connected to this unit, the available operations with this unit are limited to the following two levels:
 - Lower level: Only playing back songs on your audio player is possible.

— Higher level: Playing back, pausing, selecting songs, etc., are possible (all the operations illustrated in this manual).

- Since there are a number of Bluetooth audio players available on the market, operations with your Bluetooth audio player using this unit vary in great range. Please refer to the instruction manual that came with your Bluetooth audio player as well as this manual while operating your player on this unit.
- Information about songs (e.g. the elapsed playing time, song title, song index, etc.) cannot be displayed on this unit.
- While you are listening to songs on your Bluetooth audio player, please refrain from operating on your cellular phone as much as possible. If you try operating on your cellular phone, the signal from your cellular phone may cause a noise on the song playback.
- When you are talking on the cellular phone connected to this unit via Bluetooth wireless technology, the song playback from your Bluetooth audio player connected to this unit is muted.
- Even if while you are listening to song on your Bluetooth audio player you switch to another source, the playback of song continues to elapse.

① Source icon

Shows which source has been selected.

② Source name

Shows the selected source name.

③ Device name

Shows the device name of the connected Bluetooth audio player (or Bluetooth adapter).

④ Bluetooth audio indicator

Shows when a Bluetooth audio player connection is established (for more details, refer to *Connecting a Bluetooth audio player* on the next page).

1 Touch the source icon and then touch BT AUDIO to select the Bluetooth audio source.

- For this unit to control your Bluetooth audio player it needs to establish a Bluetooth wireless connection. (Refer to *Connecting a Bluetooth audio player* on this page.)

2 Touch ►/||.

Playback starts.

- When you want to pause a song, touch ►/|| again.

3 To skip back or forward to another track, touch ◀◀ or ▶▶.

Touching ▶▶ skips to the start of the next track. Touching ◀◀ once skips to the start of the current track. Touching it again will skip to the previous track.

- You can also skip back or forward to another track by moving the joystick left or right.

4 To perform fast forward or reverse, keep touching ◀◀ or ▶▶.

- You can also perform fast reverse/fast forward by holding the joystick left or right.

5 To stop playback, touch ■.



Note

Depending on the Bluetooth audio player you connected to this unit, operations on this unit to control the player may differ from those explained in this manual. ■

Function operation

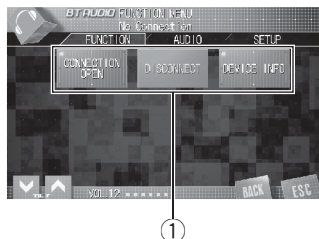

① Function display

Shows the function names.

1 Touch AV MENU and then touch FUNCTION to display the function names.

The function names are displayed and operable ones are highlighted.

2 Touch ESC to return to the playback display.

- To return to the previous display, touch **BACK**. ■

Connecting a Bluetooth audio player

● Touch CONNECTION OPEN on the function menu to turn the connection open on.

CONNECTION WAITING is displayed. This unit is now on standby for connection from Bluetooth audio player.

If your Bluetooth audio player is set ready for Bluetooth wireless connection, the connection to this unit will be automatically established.

Bluetooth Audio



Note

Before you can use audio players you may need to enter the PIN code into this unit. If your player requires a PIN code to establish a connection, look for the code on the player or in its accompanying documentation. Enter the PIN code referring to *Entering PIN code for Bluetooth wireless connection* on page 105. 

Disconnecting a Bluetooth audio player

- Touch **DISCONNECT** on the function menu.

After the disconnection is completed, **No Connection** is displayed.

Disconnecting a Bluetooth audio player

When you are done using your Bluetooth audio player with this unit, you can close the Bluetooth wireless connection.

- 1 Touch **AV MENU** to display **AUDIO MENU**.

AUDIO MENU appears on the display.

- 2 Touch **FUNCTION** to display the function names.

The function names are displayed and operable ones are highlighted.

- To return to the previous display, touch **BACK**.
- To return to the playback display, touch **ESC**.

- 3 Touch **DISCONNECT**.

After the disconnection is completed, **No Connection** is displayed. 

Displaying BD (Bluetooth Device) address

- Touch **DEVICE INFO** on the function menu to display the **BD address**.

Various information regarding the bluetooth wireless technology are displayed.

- **BD ADDRESS** (system address)
- **SYSTEM NAME** (system name)
- **SYSTEM VER.** (version)
- **BT MODULE VER.** (Bluetooth module version) 

Hands-free phoning with cellular phones featuring Bluetooth wireless technology

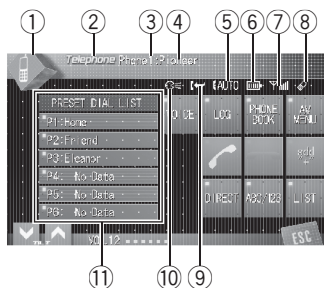

If you use Bluetooth adapter (e.g. **CD-BTB100**), you can connect a cellular phone featuring Bluetooth wireless technology to this unit for hands-free, wireless calls, even while driving.

- In some countries, **CD-BTB100** is not sold on the market.

For details concerning operation, refer to the Bluetooth adapter's operation manual. This section provides brief information on the hands-free phoning operations with this unit which slightly differs or is cut short from that described in the Bluetooth adapter's operation manual.



Important

Since this unit is on standby to connect with your cellular phones via Bluetooth wireless technology, using this unit without running the engine can result in battery drainage.

① Source icon

Shows which source has been selected.

② Source name

Shows the selected source name.

③ User number indicator

Shows the registration number of the cellular phone.

④ Device name

Shows the device name of the cellular phone.

⑤ Automatic answering/Automatic rejecting indicator

Shows when the automatic answering function is on (for more details, refer to *Setting the automatic answering* on page 68).

Shows when the automatic rejecting function is on (for more details, refer to *Setting the automatic rejecting* on page 68).

⑥ Battery strength indicator

Shows the battery strength of cellular phone.

- Battery strength indicator may differ from the actual battery strength.
- If the battery strength is not available, nothing is displayed in the battery strength indicator area.

⑦ Signal level indicator

Shows the signal strength of cellular phone.

- Signal level indicator may differ from the actual signal level.
- Depending on the cellular phones featuring Bluetooth wireless technology, radio field intensity is not available.

⑧ Telephone indicator

Shows when a phone connection using Bluetooth wireless technology is established (for more details, refer to *Connecting a cellular phone* on page 62).

⑨ Incoming call notice indication

Shows when an incoming call has been received and not checked yet.

Bluetooth Telephone

- Incoming call notice is not displayed for calls made when your cellular phone is disconnected from this unit.

⑩ Voice recognition indicator

Shows when the voice recognition function is on (for more details, refer to *Voice recognition* on this page).

⑪ Preset dial list display

Shows the Preset dial list.

● Touch the source icon and then touch Telephone to select the telephone.



Note

Equalizer curve for the phone source is fixed. When selecting the phone source, you cannot operate the equalizer function. Refer to *Recalling equalizer curves* on page 84. 

Setting up for hands-free phoning

Before you can use the hands-free phoning function you will need to set up the unit for use with your cellular phone. This entails establishing a Bluetooth wireless connection between this unit and your phone, registering your phone with this unit, and adjusting the volume level.

1 Connection

For detailed instructions on connecting your phone to this unit via Bluetooth wireless technology, refer to *Connecting a cellular phone* on the next page.

- Your phone should now be temporarily connected; however, to make best use of the technology, we recommend you register the phone to this unit.

2 Registration

Refer to *Registering connected cellular phone* on page 63 for instructions on how to register your temporarily connected phone.

3 Volume adjustment

Adjust the earpiece volume on your cellular phone for comfort. When adjusted, the volume level is memorized in this unit as the default setting.

- Caller's voice volume and ring volume may vary depending on the type of cellular phones.
- If the difference between the ring volume and caller's voice volume is big, overall volume level may become unstable.
- Before disconnecting cellular phone from this unit, make sure to adjust the volume to proper level. If the volume has been muted (zero level) on your cellular phone, the volume level of your cellular phone remains muted even after the cellular phone is disconnected from this unit. 

Basic operation of hands-free phoning



Important

Advanced operations that require your attention such as dialing numbers on the monitor, using phone book, etc., are prohibited while you are driving. When you need to use these advanced operations, stop your vehicle in a safe place and operate.

Making a phone call

Voice recognition

1 Touch VOICE to turn the voice recognition function on.

Voice dial icon appears on the information bar. Voice recognition function is now ready.

- To cancel the voice recognition function, touch **VOICE** again.

2 Pronounce the name of your contact.

Taking a phone call

Answering an incoming call

1 When a call comes in, touch .

Touching  switches between callers on hold.

2 To end the call, touch .

The estimated call time appears in the display (this may differ slightly from the actual call time).

Rejecting an incoming call

● When a call comes in, touch .

The call is rejected.

Answering a call waiting

1 Touch to answer a call waiting.

2 Touch to end the call.

- The caller you have been talking to is now on hold. To end the call, both you and your caller need to hang up the phone.

- While your callers hold the line, touching  switches between callers.

Rejecting a call waiting

● Touch to reject a call waiting. .

Introduction of advanced hands-free phoning operation

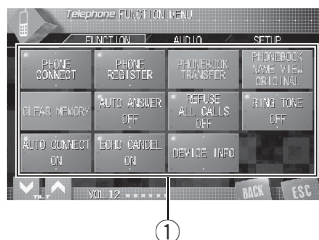

① Function display

Shows the function names.

1 Touch AV MENU and then touch FUNCTION to display the function names.

The function names are displayed and operable ones are highlighted.

2 Touch ESC to return to the playback display.

- To return to the previous display, touch **BACK**. .

Connecting a cellular phone

Searching for available cellular phones

1 Touch PHONE CONNECT on the function menu.

2 Touch Search to search for available cellular phones.

While searching, **SEARCHING** flashes. When available cellular phones featuring Bluetooth wireless technology are found, device names or **Name Not Found** (if names cannot be obtained) are displayed.

Bluetooth Telephone

- If this unit fails to find any available cellular phones, **Not Found** is displayed.

3 Touch the device name you want to connect.

While connecting, **CONNECTING** flashes. To complete the connection, please check the device name (**Pioneer BT unit**) and enter the link code on your cellular phone. If the connection is established, **CONNECTED** is displayed.

- The link code is set to **0000** as default. You can change this code in the initial setting. Refer to *Entering PIN code for Bluetooth wireless connection* on page 105.

Using a cellular phone to initiate a connection

1 Touch PHONE CONNECT on the function menu.

2 Touch CONNECTION OPEN.

The unit is now on standby for connection from cellular phone.

3 Use cellular phone to connect to this unit.

- To cancel this function, touch **CONNECTION OPEN** again.
- The link code is set to **0000** as default. You can change this code in the initial setting. Refer to *Entering PIN code for Bluetooth wireless connection* on page 105. 

Disconnecting a cellular phone

1 Touch PHONE CONNECT on the function menu.

2 Touch DISCONNECT to disconnect the currently connected cellular phone from this unit.

After the disconnection is completed, **No Connection** is displayed. 

Registering connected cellular phone

1 Touch PHONE REGISTER on the function menu.

Registration assignments appear on the display. From the top to the third assignment are for User phone 1, 2 and 3. The rest two assignments are for Guest phone 1 and 2.

2 Touch and hold one of the registration assignments to register the currently connected phone.

If the registration is succeeded, the device name of the connected phone is displayed in the selected assignment.

- If the assignment is empty, the device name is not displayed. If the assignment is already taken, the device name appears. To replace an assignment with a new phone, first delete the current assignment. For more detailed instructions, see *Deleting a registered phone* on this page.
- If the registration failed, device name of the connected phone is not displayed in the selected assignment. In this case, return to step 1 and try again. 

Deleting a registered phone

1 Touch PHONE REGISTER on the function menu.

2 Touch **DELETE** next to the device name you want to delete.

A confirmation display appears. Touch **YES** to delete the phone.

- To cancel deleting a registered phone, touch **NO**. 

Connecting to a registered cellular phone

Connecting to a registered phone manually

1 Touch **PHONE CONNECT** on the function menu.

2 Touch **DIRECT CONNECT**.

3 Touch the device name you want to connect.

While connecting, **CONNECTING** is flashing. If the connection is established, **CONNECTED** is displayed.

Connecting to a registered phone automatically

● Touch **AUTO CONNECT** on the function menu to turn the Automatic Connection function on.

If your cellular phone is set ready for Bluetooth wireless connection, the connection to this unit will be automatically established.

- To turn automatic connection off, touch **AUTO CONNECT** again. 

Using the Phone Book

Transferring entries to the Phone Book

The Phone Book can hold a total of 500 entries; 300 from User 1, 150 from User 2, and 50 from User 3.

1 Touch **PHONEBOOK TRANSFER** on the function menu.

2 Touch **START** to turn the Phone Book Transfer function on.

The Phone Book Transfer is now on standby.

3 Use cellular phone to perform phone book transfer.

Perform phone book transfer using the cellular phone. For detailed instruction on this, refer to the instruction manual that came with your cellular phone.

- The display indicates how many entries have been transferred and the total number to be transferred.
- To cancel the transferring process, touch **STOP**.

4 **Completed** is displayed and phone book transfer is completed.

Changing the Phone Book display order

● Touch **PHONEBOOK NAME VIEW** on the function menu to turn Phone Book Name View function on.

Display order for the Phone Book is changed.

- To change to the other display order, touch **PHONEBOOK NAME VIEW** again.

Bluetooth Telephone

Calling a number in the Phone Book

Important

You are required to park your vehicle and set the parking brake in order to perform this operation.

After finding the number in the Phone Book you want to call, you can select the entry and make the call.

1 Touch **PHONEBOOK** to display the Phone Book.

2 Touch **SEARCH** to display the Phone Book search display.

3 Touch an alphabet letter to select the first letter of the name you are looking for.

4 Touch **ENTER** to show entries starting with the letter you chose.

The display shows the first six Phone Book entries starting with that letter (e.g. "Ben", "Brian" and "Burt" when "B" is selected).

5 Touch a Phone Book entry you want to call.

The display is switched to the Phone Book edit display.

- Touch **PREV** or **NEXT** to display other phone book entries.
- To refine the search with a different letter, touch .

6 Touch phone number of the Phone Book entry you want to call.

If several phone numbers are entered to an entry, touch one you want to call.

The display returns to the normal display and the Phone Book entry you selected is displayed on the information bar.

7 Touch to make a call.

- For an international call, touch **add "+"** to add + to the phone number.

8 To end the call, touch .

The estimated call time appears in the display (this may differ slightly from the actual call time).

Editing the name of a Phone Book entry

Important

You are required to park your vehicle and set the parking brake in order to perform this operation.

1 Touch **PHONEBOOK** to display the Phone Book.

2 Select a Phone Book entry you want to edit.

Refer to *Calling a number in the Phone Book* on this page for detailed instructions.

3 Touch **EDIT** next to the Phone Book entry name.

The display is changed to the Phone Book edit display.

4 Touch the letter you wish to input.

Key	What it does
<	Moves the cursor to the previous character position.
>	Moves the cursor to the next character position.
↵	Inputs the space.
ABC/123	Switches keypad between alphabet and numeric.
ⓧ	Deletes letter by letter from the end of the text.

5 Touch **MEMORY** to store the new name.

Editing phone numbers

Important

You are required to park your vehicle and set the parking brake in order to perform this operation.

1 Touch **PHONEBOOK** to display the Phone Book.

2 Select a Phone Book entry you want to edit.

See step two to three on *Calling a number in the Phone Book* on the previous page for how to do this.

3 Touch **EDIT** next to the phone number you want to edit.

The display is changed to the Phone Book dial edit display.

4 Touch **0—9** to input numbers.

- For an international call, touch **add “+”** to add + to the phone number.
- Touch **CLEAR** to delete the number. Touch and hold **CLEAR** to delete all the input numbers.

5 Touch **MEMORY** to store the new number.

Clearing a Phone Book entry

Important

You are required to park your vehicle and set the parking brake in order to perform this operation.

1 Touch **PHONEBOOK** to display the Phone Book.

2 Select a Phone Book entry you want to delete.

See step two to three on *Calling a number in the Phone Book* on the previous page for how to do this.

3 Touch **DELETE** to delete the Phone Book entry.

A confirmation display appears. Touch **YES** to delete the entry.

- If you do not want to clear a Phone Book entry that you have selected, touch **NO**. 

Using the Call History

Important

You are required to park your vehicle and set the parking brake in order to perform this operation.

The 12 most recent calls made (dialed), received and missed are stored in the Call History. You can browse the Call History and call numbers from it.

1 Touch **LOG** to display the Call History.

Touching **LOG** repeatedly switches between the following call histories:

MISSED CALL LIST (missed call)—

DIALED CALL LIST (dialed call)—

RECEIVED CALL LIST (received call)

- If no phone numbers have been stored in the selected list, nothing is displayed.
- You can switch between phone number and name (if entered) by touching **ABC/123**.

2 Touch a phone number or name (if entered) you want to call.

The display returns to the normal display and the phone number you selected is displayed on the information bar.

- Touch **PREV** or **NEXT** to display other phone number or name (if entered).

3 Touch to make a call.

- For an international call, touch **add “+”** to add + to the phone number.

4 To end the call, touch .

Bluetooth Telephone

Using preset numbers



Important

You are required to park your vehicle and set the parking brake in order to perform this operation.

Assigning preset numbers

Numbers that you dial frequently can be assigned to presets for quick recall. You can assign up to 6 frequently called phone numbers to number presets.

1 Select a desired phone number from the Phone Book or the Call History. Or directly enter a desired phone number.

To select a desired phone number from the Phone Book or the Call History, see the instructions explained in previous pages. To directly enter a desired phone number, see *Making a call by entering phone number* on this page.

The display should now be the normal display and the selected phone number is displayed on the information bar.

2 Keep touching one of preset assignments to store the phone number.

The phone number you selected is stored in presets.

- When **P1—P6** are not displayed, you can display them by touching **LIST**.
- **No Data** is displayed for empty assignment. Even if the assignment is taken, you can replace it to the new one by keeping touching the assignment.

Recalling preset numbers

1 Touch one of preset assignments.

The selected phone number should now be displayed on the information bar.

- When **P1—P6** are not displayed, you can display them by touching **LIST**.

2 Touch to make a call.

3 To end the call, touch .

The estimated call time appears in the display (this may differ slightly from the actual call time). .

Making a call by entering phone number



Important

You are required to park your vehicle and set the parking brake in order to perform this operation.

1 Touch **DIRECT** to display the direct dial display.

2 Touch **0—9** to input numbers.

- For an international call, touch **add “+”** to add + to the phone number.
- If you want to store the entered phone number to preset assignment, touch **SET** here. The display returns to the normal display and the phone number you entered is selected.
- Touch **CLEAR** to delete the number. Touch and hold **CLEAR** to delete all the input numbers.
- Up to 24 digits can be entered.

3 When you completed entering the number, touch to make a call.

4 To end the call, touch .

The estimated call time appears in the display (this may differ slightly from the actual call time). .

Clearing memory

1 Touch **CLEAR MEMORY** on the function menu.

2 Touch CLEAR next to the item you want to delete from the memory.

Select from the following:

- **PHONEBOOK** (phone book)
- **Dialed Calls** (dialed call history)
- **Received Calls** (received call history)
- **Missed Calls** (missed call history)
- **Preset Dials** (preset phone numbers)

After selecting a desired item, a confirmation display appears. Touch **YES** to delete the memory.

- If you do not want to clear memory that you have selected, touch **CANCEL**.
- If you want to clear all the Phone Book, dialed/received/missed call history list and preset phone number, touch **CLEAR ALL**.

Setting the automatic answering

- Touch **AUTO ANSWER** on the function menu to turn the automatic answer on.
 - To turn the automatic answer off, touch **AUTO ANSWER** again.

Setting the automatic rejecting

- Touch **REFUSE ALL CALLS** on the function menu to turn the automatic call rejection on.
 - To turn the automatic call rejection off, touch **REFUSE ALL CALLS** again.

Switching the ring tone

- Touch **RING TONE** on the function menu to turn the ring tone on.
 - To turn the ring tone off, touch **RING TONE** again.

Echo canceling and noise reduction

- Touch **ECHO CANCEL** on the function menu to turn Echo Cancel function on.
 - To turn echo canceling off, touch **ECHO CANCEL** again.

Displaying BD (Bluetooth Device) address

- Touch **DEVICE INFO** on the function menu to display the BD address. Various information regarding the bluetooth wireless technology are displayed.

- **BD ADDRESS** (system address)
- **SYSTEM NAME** (system name)
- **SYSTEM VER.** (version)
- **BT MODULE VER.** (Bluetooth module version)

TV tuner

Watching the television

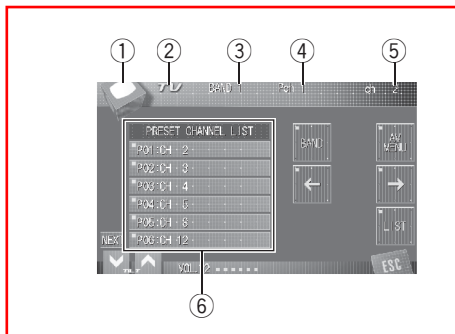

You can use this unit to control a TV tuner (e.g. **GEX-P5750TV**), which is sold separately.

For details concerning operation, refer to the TV tuner's operation manual. This section provides information on TV operations with this unit which differs from that described in the TV tuner's operation manual.

**Important**

Depending on the TV tuner connected to this unit, some functions may not be operable. For details, refer to the TV tuner's operation manual.

① Source icon

Shows which source has been selected.

② Source name

Shows the selected source name.

③ Band indicator

Shows which band the TV tuner is tuned to.

④ Preset number indicator

Shows which preset has been selected.

⑤ Channel indicator

Shows which channel the TV tuner is tuned.

⑥ Preset list display

Shows the preset list.

1 Touch the source icon and then touch **TV** to select the TV.

2 Touch the screen to display the touch panel keys.

3 Touch **BAND** to select a band.

Touch **BAND** repeatedly until the desired band is displayed, **BAND 1** or **BAND 2**.

4 To perform manual tuning, briefly touch **←** or **→**.

The channels move up or down step by step.

- You can also perform manual tuning by moving the joystick left or right.

5 To perform seek tuning, keep touching **←** or **→** for about one second and release.

The tuner will scan the channels until a broadcast strong enough for good reception is found.

- You can cancel seek tuning by briefly touching either **←** or **→**.
- If you keep touching **←** or **→** you can skip broadcasting channels. Seek tuning starts as soon as you release the keys.
- You can also perform seek tuning by holding the joystick left or right.

**Note**

If you do not use the touch panel keys within 30 seconds, they will be hidden automatically.

Storing and recalling broadcast stations

If you touch any of the preset tuning keys **P01—P12** you can easily store up to 12 broadcast stations for later recall with the touch of a key.

- When you find a station that you want to store in memory, keep touching one of preset tuning keys P01—P12 until the beep sounds.

The next time you touch the same preset tuning key the station is recalled from memory.

- To switch between P01—P06 and P07—P12, touch **PREV** or **NEXT**.
- When P01—P06 and P07—P12 are not displayed, you can display them by touching **LIST**.



Notes

- Up to 24 stations, 12 for each of two TV bands, can be stored in memory.
- You can also use ↑ and ↓ to recall stations assigned to preset tuning keys P01—P12 when P01—P12 are not displayed.

Introduction of advanced TV tuner operation

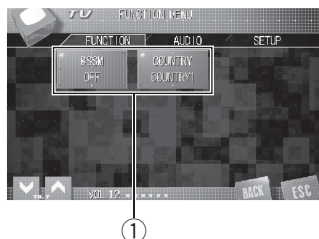

① Function display

Shows the function names.

1 Touch AV MENU and then touch FUNCTION to display the function names.

The function names are displayed and operable ones are highlighted.

2 Touch ESC to return to the TV picture.

- To return to the previous display, touch **BACK**.

Storing the strongest broadcast stations sequentially

- Touch **BSSM** on the function menu to turn **BSSM** on.

BSSM begins to flash. While **BSSM** is flashing the 12 strongest broadcast stations will be stored in order from the lowest channel up. When finished, **BSSM** stops flashing.

- To cancel the storage process, touch **BSSM** again.

**Note**

Storing broadcast stations with BSSM may replace broadcast stations you have saved using **P01—P12**. 

Selecting the area group

- **Touch COUNTRY on the function menu to select the area group.**

Touch **COUNTRY** repeatedly until the desired area group appears in the display.

COUNTRY 1 (CCIR channel)—**COUNTRY 2** (IN channel)—**COUNTRY 3** (CHN channel)—**COUNTRY 4** (U.K. channel)—**COUNTRY 5** (OIRT channel)—**COUNTRY 6** (AUSTRALIA channel)—**COUNTRY 7** (SAF channel) 

Playing a disc

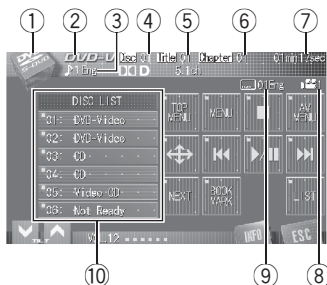

You can use this unit to control a DVD player or multi-DVD player, which is sold separately.

For details concerning operation, refer to the DVD player's or multi-DVD player's operation manual. This section provides information on DVD operations with this unit which differs from that described in the DVD player's or multi-DVD player's operation manual.

- When operating DVD player/multi-DVD player by using the touch panel keys, refer to built-in DVD player operation.
 - When using a DVD player or multi-DVD player, you cannot operate the DVD menu by touching the menu item directly.
- This unit does not have ITS playlist and disc title functions.
- Switch the remote control selection to suitable setting to operate DVD players. (Refer to page 101.)
- Switch the remote control operation mode to **DVD** to operate the DVD player by using remote control. (Refer to page 19.)

① Source icon

Shows which source has been selected.

② Disc type indicator

Shows the type of the currently playing disc.

③ Audio language indicator

Shows which audio language has been selected when playing DVD video.

④ Disc number indicator

Shows the disc number currently playing when using a multi-DVD player.

⑤ Title/Folder number indicator

Shows the title (when playing DVD video) or folder (when playing MP3 or WMA) of the selection currently playing.

⑥ Chapter/track number indicator

Shows the chapter (when playing DVD video) or track (when playing video CD, CD, MP3 or WMA) currently playing.

⑦ Play time indicator

Shows the elapsed playing time of the current chapter/track.

⑧ Viewing angle indicator

Shows which viewing angle has been selected when playing DVD video.

⑨ Subtitle language indicator

Shows which subtitle language has been selected when playing DVD video.

⑩ Disc list display

Shows the list of the disc type when using a multi-DVD player.

1 Touch the source icon and then touch S-DVD to select the DVD player.

2 Touch the screen to display the touch panel keys.

3 To skip back or forward to another chapter/track, briefly touch ◀◀ or ▶▶.

- You can also skip back or forward to another chapter/track by moving the joystick left or right.

DVD Player

When using the joystick on the remote control, switch the remote control operation mode to **AVH**. (Refer to page 19.)

4 To perform fast forward or reverse, keep touching **◀◀** or **▶▶**.

■ You can also perform fast reverse/fast forward by holding the joystick left or right.

When using the joystick on the remote control, switch the remote control operation mode to **AVH**. (Refer to page 19.)



Note

If you do not use the touch panel keys within 30 seconds, they will be hidden automatically when playing DVD video or video CD. 

Turning the DVD player on or off

• Only the remote control can operate this function. To perform this function, switch the remote control operation mode to **DVD**. (Refer to page 19.)

● Press **REAR SOURCE** to turn the DVD player on.

■ To turn the DVD player off, press **REAR SOURCE** again. 

Selecting a disc

• You can operate this function only when a multi-DVD player is connected to this unit.

● Touch any of **01—06** to select the desired disc.

■ When **01—06** are not displayed, you can display them by touching **LIST**.

■ You can also select a disc by pressing **▲/▼** (**TILT/DISC**) on the remote control when the remote control operation mode is switched to **DVD**. 

Introduction of advanced DVD player operation

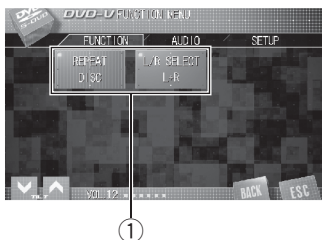

① Function display

Shows the function names.

1 Touch AV MENU and then touch FUNCTION to display the function names.

The function names are displayed and operable ones are highlighted.

2 Touch ESC to return to the playback display.

- To return to the previous display, touch **BACK**.

Repeating play

- During playback of Video CDs featuring PBC (playback control), this function cannot be operated.

● Touch REPEAT on the function menu to select the repeat range.

During DVD video playback

- **DISC** – Repeat the current disc
- **CHAPTER** – Repeat just the current chapter
- **TITLE** – Repeat just the current title

During Video CD or CD playback

- **DISC** – Repeat the current disc
- **TRACK** – Repeat just the current track

During MP3/WMA playback

- **DISC** – Repeat the current disc

- **FOLDER** – Repeat the current folder
- **TRACK** – Repeat just the current track

Notes

- If you select other discs during repeat play, the repeat play range changes to **DISC**.
- During video CD or CD playback, if you perform track search or fast forward/reverse during **TRACK**, the repeat play range changes to **DISC**.
- During MP3/WMA playback, if you select another folder during repeat play, the repeat play range changes to **DISC**.
- During MP3/WMA playback, if you perform track search or fast forward/reverse during **TRACK**, the repeat play range changes to **FOLDER**.

Playing tracks in random order

- You can operate this function during CD/MP3/WMA playback.
- **Touch RANDOM on the function menu to turn random play on.**
Tracks will play in a random order.
 - To turn random play off, touch **RANDOM** again.

Scanning tracks of a CD/MP3/WMA

- You can operate this function during CD/MP3/WMA playback.

1 Touch SCAN on the function menu to turn scan play on.

The first 10 seconds of each track is played.

2 When you find the desired track touch SCAN again.

DVD Player

Selecting audio output

When playing DVD video discs recorded with LPCM audio, or video CD discs, you can switch the audio output.

- This function is not possible when disc playback has been stopped.
- **Touch L/R SELECT on the function menu to select the audio output.**

Touch **L/R SELECT** repeatedly until the desired audio output appears in the display.

- **L+R** – left and right
- **LEFT** – left
- **RIGHT** – right

Introduction to built-in DSP features



Important

We recommend that you record the settings in the sheet on page 121 after you have completed audio adjustments.

DSP modes

This unit features two DSP modes: the network mode and the standard mode. You can switch between DSP modes as desired. Initially, the DSP mode is set to the standard mode. (Refer to *Switching the DSP setting mode* on page 104.)

- Auto TA and EQ can be used for the standard mode only. (Refer to *Auto TA and EQ (auto-time alignment and auto-equalizing)* on page 92 and *Using the auto-equalizer* on page 91.)
- A 2-way front speaker output can be used for the network mode only.



Note

Switching the DSP mode erases the current adjusting audio settings (**LAST MEMORY**). If needed, memorize it into custom settings (**CUSTOM1**, **CUSTOM2** or **CUSTOM3**).

Output channel modes (2CH/Multi CH)

This unit has two output channel modes for each DSP mode: the 2-channel mode and the multi-channel mode. You can switch between output channel modes depending on the source that you have selected.

- Dolby Pro Logic II/EX and DTS Neo:6 (**Dolby/DTS**) can be used for multi-channel mode only.

- Graphic equalizer (**GRAPHIC EQ**) can be used for 2-channel mode only.
- Parametric equalizer (**PARAMETRIC EQ**) can be used for multi-channel mode only.



Note

When selecting 2-channel mode, audio does not be output from front center and rear center speakers.

Sound settings (SETTING1, SETTING2 or SETTING3)

Created acoustic sound field can be stored in this unit and called up easily. Additionally, this unit stores the sound setting and output channel information for each source group. Changing the source switches sound setting and output channel information for each source group at the same time.

Three types of sound settings can be set and stored for both 2-channel mode and multi-channel mode independently. Moreover, sound settings can be stored for both the network mode and the standard mode. Therefore, a total of 12 types of sound settings can be set and stored.

- Auto TA and EQ can be performed only when the standard mode is selected. Performing Auto TA and EQ creates auto settings (**AUTO**) which are adjusted finely for both 2-channel mode and multi-channel mode. However, **AUTO** cannot be customized.

Source groups

Each source stores both sound settings and output channels information. When a DVD player (built-in or optional) is selected as a source, the each medium stores these settings independently.

Media of DVD player are listed as follows:

- DVD audio (AOB: audio object)

Audio Adjustments

- DVD audio (VOB: video object)
- DVD video
- Video CD
- CD (CD-DA)
- DTS-CD
- Compressed audio (MP3/WMA/AAC) files
- DivX video files

Note

External unit 1 and external unit 2 are set to the same value automatically.

Custom settings (CUSTOM1, CUSTOM2 and CUSTOM3)

Following functions can store the settings in the custom settings (**CUSTOM1**, **CUSTOM2** and **CUSTOM3**). Custom settings are common to Sound settings (**SETTING1**, **SETTING2** and **SETTING3**).

- Speaker setting (**SPEAKER SETTING**)
- Cut-off frequency setting (**CUT OFF**)
- Time alignment setting (**TIME ALIGNMENT**)
- Speaker level setting (**SPEAKER LEVEL**)
- Parametric equalizer setting (**PARAMETRIC EQ**) (when selecting multi-channel mode only)
- Graphic equalizer setting (**GRAPHIC EQ**) (when selecting 2-channel mode only)

Audio setup procedure

Standard mode

First, perform Auto TA and EQ. Auto TA and EQ creates finely-tuned sound field for both 2-channel mode and multi-channel mode according to your vehicle interior acoustic characteristics. (Refer to *Auto TA and EQ (auto-time alignment and auto-equalizing)* on page 92.) Basically, that's all you need to do to adjust the audio setting and no other fine tuning is necessary.

However, according to your wishes, it is possible to customize audio settings based on Auto TA and EQ settings. By carrying out the following settings/adjustments in the order shown, you can customize sound field effortlessly.

- *Switching the sound settings* (**SOUND SETTING**)
- *Customizing the speaker setting* (**SPEAKER SETTING**)
- *Using the cut-off frequency* (**CUT OFF**)
- *Adjusting the time alignment* (**TIME ALIGNMENT**)
- *Adjusting the speaker output levels* (**SPEAKER LEVEL**)
- *Adjusting 3-band parametric equalizer* (**PARAMETRIC EQ**) (when selecting multi-channel mode only)
- *Adjusting 13-band graphic equalizer* (**GRAPHIC EQ**) (when selecting 2-channel mode only)

Network mode

Make sure of the following settings before performing finely audio adjustments.

Function	Setting	Page
Digital Direct	OFF	79
PARAMETRIC EQ/ GRAPHIC EQ	FLAT	84, 86
FADER/BALANCE	FRONT 0/REAR 0/ LEFT 0/RIGHT 0	78
Dolby/DTS	OFF	79

By carrying out the following settings/adjustments in the order shown, you can create a finely-tuned sound field effortlessly.

- *Switching the sound settings* (**SOUND SETTING**)
- *Using the position selector* (**POSITION**)
- *Customizing the speaker setting* (**SPEAKER SETTING**)
- *Using the cut-off frequency* (**CUT OFF**)

- *Adjusting the time alignment* (**TIME ALIGNMENT**)
- *Adjusting the speaker output levels* (**SPEAKER LEVEL**)
- *Adjusting 3-band parametric equalizer* (**PARAMETRIC EQ**) (when selecting multi-channel mode only)
- *Adjusting 13-band graphic equalizer* (**GRAPHIC EQ**) (when selecting 2-channel mode only)

Extra functions

These functions are helpful in adjusting the sound to suit your system or your personal preferences.

- *Using balance adjustment* (**FADER/BALANCE**)
- *Adjusting source levels* (**SOURCE LEVEL ADJUSTER**)
- *Using the direct control* (**Digital Direct**)
- *Listening in surround sound* (**Dolby/DTS**) (when selecting multi-channel mode only)
- *Using the dynamic range control* (**DYNAMIC RANGE CONTROL**)
- *Using the down-mix function* (**DOWN MIX**)

Introduction of audio adjustments

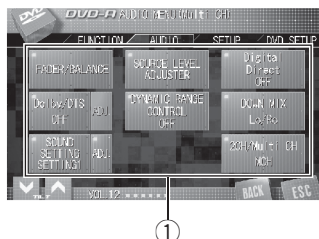

① Audio display

Shows the audio function names.

1 Touch AV MENU to display the audio function names.

The audio function names are displayed and operable ones are highlighted.

- When selecting the FM tuner as the source, you cannot switch to **SOURCE LEVEL ADJUSTER**.
- When selecting 2-channel mode, you cannot switch to **Dolby/DTS**.

2 Touch ESC to return to the display of each source.

- To return to the previous display, touch **BACK**.

Using balance adjustment

You can change the fader/balance setting so that it can provide you an ideal listening environment in all occupied seats.

1 Touch FADER/BALANCE on the audio function menu.

Audio Adjustments

2 Touch ▲ or ▼ to adjust front/rear speaker balance.

Each time you touch ▲ or ▼ it moves the front/rear speaker balance towards the front or the rear.

FRONT 25 to REAR 25 is displayed as the front/rear speaker balance moves from front to rear.

3 Touch < or > to adjust left/right speaker balance.

Each time you touch < or > it moves the left/right speaker balance towards the left or the right.

LEFT 25 to RIGHT 25 is displayed as the left/right speaker balance moves from left to right. □

Adjusting source levels

SLA (source level adjustment) lets you adjust the volume level of each source to prevent radical changes in volume when switching between sources.

- Settings are based on the FM tuner volume level, which remains unchanged.

1 Compare the FM tuner volume level with the level of the source you wish to adjust.

2 Touch SOURCE LEVEL ADJUSTER on the audio function menu.

3 Touch ▲ or ▼ to adjust the source volume.

Each time you touch ▲ or ▼ it increases or decreases the source volume.

+14dB to -14dB is displayed as the source volume is increased or decreased.

Notes

- Video CD, CD, compressed audio (MP3/WMA/AAC) and DivX are set to the same source level adjustment volume automatically.
- DVD and the optional DVD player are set to the same source level adjustment volume automatically.
- External unit 1 and external unit 2 are set to the same source level adjustment volume automatically. □

Using the direct control

You can override audio settings to check for effectiveness of your audio settings.

- All audio functions are locked out when the direct control is on except **VOLUME**, **Dolby PL II/EX** and **DTS Neo:6**.
- **Touch Digital Direct on the audio function menu to turn the direct control on.**
 - To turn direct control off, touch **Digital Direct** again.

Note

When selecting 2-channel mode, the following occurs:

- If **Digital Direct** is turned on, output setting is switched to **MCH** automatically.
- If **Digital Direct** is turned off, output setting is returned to **2CH** automatically. □

Listening in surround sound

Using this unit, you can listen to any source in surround sound. However, the options available will depend on your speaker setup and the type of source you are listening to.

You can select **Dolby PL II/EX** or **DTS Neo:6**.

- When selecting **2CH** (2-channel mode), you cannot use this function. (Refer to *Switching between the multi-channel output and 2-channel output* on page 82.)
- If both the front center and the rear speakers are set to **OFF**, you cannot use this function.

Recalling surround sound settings

● Touch Dolby/DTS on the audio function menu to select your favorite setting.

Touch **Dolby/DTS** repeatedly to switch between the following settings.

OFF (off)—**Dolby PL II/EX** (Dolby Pro Logic II/EX)—**DTS Neo:6** (DTS Neo:6)

Using the Dolby Pro Logic II/EX

Dolby Pro Logic II creates five full-bandwidth output channels from two-channel sources to achieve high-purity matrix surround.

- If both the center and the rear speakers are set to **OFF**, you cannot use this function.
- Dolby Pro Logic II supports up to 48kHz sampling rate stereo source and has no effect on other types of source.

1 Touch Dolby/DTS on the audio function menu to select Dolby PL II/EX.

Refer to *Recalling surround sound settings* on this page.

2 Touch **ADJ.** next to **Dolby/DTS**.

3 Touch any of the following touch panel keys to select the desired mode.

- **MOVIE** – The Movie mode suitable for movie playback
- **MUSIC** – The Music mode suitable for music playback
- **MATRIX** – The Matrix mode for when FM radio reception is weak

- You can operate **MUSIC ADJUSTMENT** only when **MUSIC** has been selected.

Adjusting the Music mode

You can adjust the Music mode with the following three controls.

- **Panorama (PANORAMA)** extends the front stereo image to include the surround speakers for an exciting “wraparound” effect.
- **Dimension (DIMENSION)** allows you to gradually adjust the sound field either towards the front or the rear.
- **Center Width Control (CENTER WIDTH)** allows center-channel sounds to be positioned between the center speaker and the left/right speakers. It improves the left-center-right stage presentation for both the driver and the front passenger.

1 Touch **MUSIC** to adjust music mode.

Refer to *Using the Dolby Pro Logic II/EX* on this page.

2 Touch **PANORAMA** to turn the Panorama control on.

- To turn the Panorama control off, touch **PANORAMA** again.

3 Touch **<** or **>** to adjust **DIMENSION (dimension)**.

Each time you touch **<** or **>** it moves the sound towards the front or the surrounds. **+3** to **-3** is displayed as the front/surround speaker balance moves from front to surrounds.

4 Touch **<** or **>** to adjust **CENTER WIDTH (center width control)**.

Each time you touch **<** or **>** it gradually spreads the center channel sound into the front left and right speakers over a range **0** to **7**.

Audio Adjustments

3 is the default and it's recommended for most recordings. **0** places all center sound in the center speaker. **7** places all center sound equally in the left/right speakers.

Using the DTS Neo:6

DTS Neo:6 can generate 6.1 channel surround sound from any matrixed stereo source (such as video or TV) and from 5.1 channel sources.

1 Touch Dolby/DTS on the audio function menu to select DTS Neo:6.

Refer to *Recalling surround sound settings* on the previous page.

2 Touch ADJ. next to Dolby/DTS.

3 Touch either of the following touch panel keys to select the desired mode.

- **CINEMA** – The Cinema mode suitable for movie playback
- **MUSIC** – The Music mode suitable for music playback
- You can operate **MUSIC ADJUSTMENT** only when **MUSIC** has been selected.
- With the DTS Neo:6, audio and voice from TV or radio may be breaking up. In such case, we recommend you to turn the DTS Neo:6 off.

Adjusting the Music mode

In music mode, you can adjust the center image to create a wider stereo effect with vocals. Adjust the effect from **0** (all center channel sent to front right and left speakers) to **10** (center channel sent to the center speaker only).

1 Touch MUSIC to adjust music mode.

Refer to *Using the DTS Neo:6* on this page.

2 Touch < or > to adjust CENTER IMAGE (center image).

Each time you touch < or > it gradually spreads the center channel sound into the front left and right speakers over a range **10** to **0**.

Using the dynamic range control

The dynamic range refers to the difference between the largest and softest sounds. The dynamic range control compresses this difference so that you can clearly hear sounds even at low volume levels.

- The dynamic range control is effective only on Dolby Digital sounds.
- The dynamic range control may produce little effect on certain discs.
- Touch **DYNAMIC RANGE CONTROL** on the audio function menu to turn the dynamic range control on.
 - To turn dynamic range control off, touch **DYNAMIC RANGE CONTROL** again.

Using the down-mix function

The down-mix function allows you to play back multi-channel audio in 2 channels.

- Touch **DOWN MIX** on the audio function menu to switch the setting.
 - **Lt/Rt** – Down mix so that the surround components can be restored (decoded).
 - **Lo/Ro** – Stereo mix the original audio that do not contain channel modes such as surround components.

Switching the sound settings

You can switch the acoustic sound field stored in this unit according to the source you are listening to. For detailed instructions on creating the acoustic sound field, refer to *Introduction of sound settings* on the next page.

- **Touch SOUND SETTING on the audio function menu to switch the sound setting.**

Touch **SOUND SETTING** repeatedly to switch between the following settings:

SETTING1 (user setting 1)—**SETTING2** (user setting 2)—**SETTING3** (user setting 3)—**AUTO** (setting created by auto TA & EQ)

- You can also switch the sound setting by pressing **SOUND SETTING**.
- You cannot select **AUTO** when **NETWORK** has been selected. (Refer to *Switching the DSP setting mode* on page 104.)
- When **STANDARD** has been selected, you cannot select **AUTO** if Auto TA and EQ has not been carried out. 

Switching between the multi-channel output and 2-channel output

You can switch the output channel between the multi-channel output and 2-channel output according to the source you are listening to.

- Selecting **2CH** changes the audio settings as below:
 - Both the front center and rear center speakers are turned off automatically in the speaker setting. (Refer to page 87.)
 - Both Dolby Pro Logic II/EX and DTS Neo:6 switch to **OFF**. (Refer to page 79.)

- **Touch 2CH/Multi CH on the audio function menu to switch the mode.**

Touch **2CH/Multi CH** repeatedly until the desired mode appears in the display.

- **MCH** – Multi-channel audio output
- **2CH** – 2-channel audio output (stereo)
- You can also switch the output setting by pressing **2ch/MULTI-CH**. 

Audio Adjustments

Introduction of sound settings

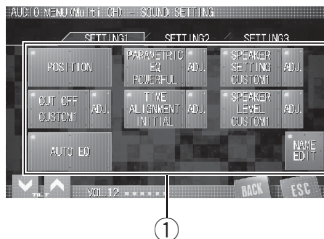

① Sound setting display

Shows the sound setting function names.

1 Touch AV MENU to display the audio function names.

The audio function names are displayed and operable ones are highlighted.

2 Touch ADJ. next to SOUND SETTING to display the sound setting function names.

The sound setting function names are displayed.

- **AUTO** cannot be customized. When **AUTO** is selected, select the other sound settings by touching **SOUND SETTING**.

3 Touch any of SETTING1, SETTING2 or SETTING3 to select the sound setting to be adjusted.

4 Touch ESC to return to the display of each source.

- To return to the previous display, touch **BACK**.

Sound setting function display

Touching the sound setting selection keys enables you to cross-refer the other adjustments. Even in the adjustment screen, it is possible to refer and set another setting menus.

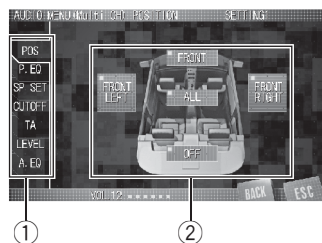

① Sound setting selection keys

Touch to recall the desired sound setting function.

② Sound setting function display

Shows the adjustment screen of the selected sound setting function.

Using the position selector

One way to assure a more natural sound is to accurately position the stereo image, putting you right in the center of the sound field. The position selector function lets you automatically adjust the speaker output levels and inserts a delay time to match the number and position of occupied seats.

1 Touch POSITION on the sound setting menu.

2 Touch any of the following touch panel keys to select a listening position.

- **FRONT LEFT** – Front seat left
- **FRONT RIGHT** – Front seat right
- **FRONT** – Front seats
- **ALL** – All seats

- To cancel the selected listening position, touch **OFF**.

Note

When you make adjustments to the listening position, the speaker outputs are automatically set for appropriate levels. You can tailor the levels more precisely referring to *Adjusting the speaker output levels* on page 90. 

Recalling equalizer curves

The equalizer lets you adjust the equalization to match car interior acoustic characteristics as desired.

There are eight stored equalizer curves which you can easily recall at any time. Here is a list of the equalizer curves:

Display	Equalizer curve
SUPER BASS (S. BASS)	Super bass
POWERFUL	Powerful
NATURAL	Natural
VOCAL	Vocal
FLAT	Flat
CUSTOM1	Custom 1
CUSTOM2	Custom 2
CUSTOM3	Custom 3

- **CUSTOM1**, **CUSTOM2** and **CUSTOM3** are adjusted equalizer curves.
- When **FLAT** is selected no supplement or correction is made to the sound. This is useful to check the effect of the equalizer curves by switching alternatively between **FLAT** and a set equalizer curve.

When selecting multi-channel mode

- Touch **PARAMETRIC EQ** on the sound setting menu to select the equalizer.

Touch **PARAMETRIC EQ** repeatedly to switch between the following equalizers:

POWERFUL—NATURAL—VOCAL—FLAT—CUSTOM1—CUSTOM2—CUSTOM3—LAST MEMORY—SUPER BASS (S. BASS)

- You can select **LAST MEMORY** only when the adjusted equalizer curve is not memorized in this unit.

When selecting 2-channel mode

- Touch **GRAPHIC EQ** on the sound setting menu to select the equalizer.

Touch **GRAPHIC EQ** repeatedly to switch between the following equalizers:

POWERFUL—NATURAL—VOCAL—FLAT—CUSTOM1—CUSTOM2—CUSTOM3—LAST MEMORY—SUPER BASS (S. BASS)

- You can select **LAST MEMORY** only when the adjusted equalizer curve is not memorized in this unit. 

Adjusting 3-band parametric equalizer

For custom equalizer curves (**CUSTOM1** to **CUSTOM3**), you can adjust the front, rear, front center and rear center equalizer curves separately by selecting a center frequency, an equalizer level, and a Q factor for each band.

- A separate **CUSTOM1** curve can be created for each source.
- **CUSTOM2** and **CUSTOM3** curves can be created common to all sources.

Audio Adjustments

- The center speaker largely determines the sound image and getting the balance right isn't easy. We recommend reproducing a 2-ch. audio (a CD for example) and getting the balance right among the speakers except for the center, and then reproducing a 5.1-ch. audio (Dolby Digital or DTS) and adjusting the center speaker output to the balance you have already got among the other speakers.

1 Touch ADJ. next to PARAMETRIC EQ on the sound setting menu.

2 Touch LR Common/LR Independent to switch the equalizer adjustment method.

- **LR Common** – Adjusts left and right speakers simultaneously.
- **LR Independent** – Adjusts left and right speakers separately.

3 Touch EQ to select the equalizer.

Touch **EQ** repeatedly to switch between the following equalizers:

POWERFUL—NATURAL—VOCAL—FLAT—CUSTOM1—CUSTOM2—CUSTOM3—LAST MEMORY—SUPER BASS (S. BASS)

- You can also select the equalizer by using **EQUALIZER LIST**.
- To close the equalizer curve list, touch **CLOSE**.
- You can select **LAST MEMORY** only when the adjusted equalizer curve is not memorized in this unit.

4 Touch < or > next to SPEAKER to select the speaker to be adjusted.

Touch < or > until the desired speaker appears in the display.

FRONT LEFT (front left speaker)—
FRONT RIGHT (front right speaker)—
REAR LEFT (rear left speaker)—**REAR RIGHT** (rear right speaker)—**FRONT CENTER** (front center speaker)—**REAR CENTER** (rear center speaker)

- You can mute the selected speaker unit by touching . To cancel muting, touch .
- You cannot select speakers whose size is set at **OFF**.

5 Touch BAND to select the equalizer band to be adjusted.

Each time you touch **BAND** it selects equalizer bands in the following order:

LOW (low)—**MID** (mid)—**HIGH** (high)

6 Touch < or > to select the center frequency of selected band.

Touch < or > until the desired frequency appears in the display.

40—50—63—80—100—125—160—200—250—315—400—500—630—800—1k—1.25k—1.6k—2k—2.5k—3.15k—4k—5k—6.3k—8k—10k—12.5k (Hz)

- You can select a center frequency from among 20 frequencies for each band. You can change the center frequency in 1/3-octave steps, but you cannot select frequencies that have intervals shorter than 1 octave among the center frequencies of the three bands.

7 Touch ^ or v to adjust the equalizer level.

Each time you touch ^ or v it increases or decreases the equalizer level. **+12dB -- -12dB** is displayed as the level is increased or decreased.

- When you adjust the speaker loudness with selecting **LR Common**, the equalizer levels of both side speakers are changed simultaneously. Thus, if the equalizer level of one speaker is at maximum or minimum, the level of the other speaker is at full limit in opposite direction.

8 Touch Q.Fac to select the desired Q factor.

Each time you touch **Q.Fac** it switches between the following Q factor:

1.2 (wide)—**3.6** (narrow)

- You can adjust parameters for each band of the other speakers in the same way.

**Note**

You can store the adjusted setting in memory by using **MEMORY**. For details concerning operation, refer to *Storing the adjusted audio settings in memory* on page 91.

Adjusting 13-band graphic equalizer

For custom equalizer curves (**CUSTOM1** to **CUSTOM3**), you can adjust the level of each band.

- A separate **CUSTOM1** curve can be created for each source.
- **CUSTOM2** and **CUSTOM3** curves can be created common to all sources.

1 Touch ADJ. next to GRAPHIC EQ on the sound setting menu.

2 Touch LR Common/LR Independent to switch the equalizer adjustment method.

- **LR Common** – Adjusts left and right speakers simultaneously.
- **LR Independent** – Adjusts left and right speakers separately.

3 Touch EQ to select the equalizer.

Touch **EQ** repeatedly to switch between the following equalizers:

POWERFUL—NATURAL—VOCAL—FLAT—CUSTOM1—CUSTOM2—CUSTOM3—LAST MEMORY—SUPER BASS (S. BASS)

- You can also select the equalizer by using **EQUALIZER LIST**.
 - To close the equalizer curve list, touch **CLOSE**.
 - You can select **LAST MEMORY** only when the adjusted equalizer curve is not memorized in this unit.

4 Touch < or > next to SPEAKER to select the speaker to be adjusted.

Touch **<** or **>** until the desired speaker appears in the display.

LEFT (left speakers)—**RIGHT** (right speakers)

- You can mute the selected speaker units by touching . To cancel muting, touch .

5 Touch < or > to select the equalizer band to be adjusted.

Touch **<** or **>** until the desired equalizer band appears in the display.

50—80—125—200—315—500—800—1.25k—2k—3.15k—5k—8k—12.5k (Hz)

6 Touch ^ or v to adjust the level of the equalizer band.

Each time you touch **^** or **v** it increases or decreases the level of the equalization band. **+12dB** — **-12dB** is displayed as the level is increased or decreased.

- When you adjust the speaker loudness with selecting **LR Common**, the equalizer levels of both side speakers are changed simultaneously. Thus, if the equalizer level of one speaker is at maximum or minimum, the level of the other speaker is at full limit in opposite direction.
 - You can then select another band and adjust the level.

**Note**

You can store the adjusted setting in memory by using **MEMORY**. For details concerning operation, refer to *Storing the adjusted audio settings in memory* on page 91.

Audio Adjustments

Setting the speaker setting

You can make a fine adjustment on each speaker installed in your vehicle. You can change the size of each speaker according to the speaker specification. On a spot at which a speaker is not installed, you can set the adjustment to **OFF**.

The adjustment you made will be memorized into this unit and you can recall it.

Recalling speaker settings

- Touch **SPEAKER SETTING** on the sound setting menu to select the speaker setting.

Touch **SPEAKER SETTING** repeatedly to switch between the following speaker settings:

CUSTOM1—CUSTOM2—CUSTOM3—AUTO—LAST MEMORY

- You can select **LAST MEMORY** only when the adjusted speaker setting is not memorized in this unit.
- You cannot select **AUTO** when **NETWORK** has been selected. (Refer to *Switching the DSP setting mode* on page 104.)
- When **STANDARD** has been selected, you cannot select **AUTO** if auto TA and EQ has not been carried out.

Customizing the speaker setting

You need to make with/without (or yes/no) and size (bass reproducing capacity) selection/adjustments depending on the installed speakers. The size needs to be set to **LARGE** (large) if the speaker is capable of reproducing sounds of about 100 Hz or below. Otherwise select **SMALL** (small).

- Low frequency range is not output if the subwoofer is set to **OFF** and the front and rear speakers set to **SMALL** or **OFF**.
- It is imperative that non-installed speakers be set to **OFF**.

- Set the front or rear speaker to **LARGE** if the speaker is capable of reproducing bass content, or if no subwoofer is installed.

1 Recall the speaker setting you want to adjust.

Refer to *Recalling speaker settings* on this page.

2 Touch **ADJ. next to SPEAKER SETTING** on the sound setting menu.

3 Touch **< or >** to select the correct size for the speaker.

Each time you touch **< or >** it selects the size in the following order:

OFF (off)—**SMALL** (small)—**LARGE** (large)

- You cannot select **OFF** in the front speaker setting.
- You can turn **ON** or **OFF** in the subwoofer setting.
- When the rear speaker setting is set to **OFF**, the rear center speakers switch to **OFF** automatically.

Note

You can store the adjusted setting in memory by using **MEMORY**. For details concerning operation, refer to *Storing the adjusted audio settings in memory* on page 91. 

Using the cut-off frequency

You can adjust the cut-off frequency and slope to match the characteristics of each speaker unit. And then you can store the adjusted cut-off frequency in this unit for later recall.

Recalling cut-off frequency settings

- Touch **CUT OFF** on the sound setting menu to select the cut-off frequency setting.

Touch **CUT OFF** repeatedly to switch between the following cut-off frequency settings:

CUSTOM1—CUSTOM2—CUSTOM3—AUTO—LAST MEMORY

- You can select **LAST MEMORY** only when the adjusted cut-off frequency setting is not memorized in this unit.
- You cannot select **AUTO** when **NETWORK** has been selected. (Refer to *Switching the DSP setting mode* on page 104.)
- When **STANDARD** has been selected, you cannot select **AUTO** if auto TA and EQ has not been carried out.

Selecting a cut-off frequency

You can select a frequency, under which sounds are reproduced through the subwoofer. If the installed speakers include one whose size has been set to **SMALL**, you can select a frequency, under which sounds are reproduced through a **LARGE** speaker or subwoofer.

1 Recall the cut-off frequency setting you want to adjust.

Refer to *Recalling cut-off frequency settings* on this page.

2 Touch **ADJ.** next to **CUT OFF** on the sound setting menu.

3 Touch the speaker to be adjusted.

- You cannot select speakers whose size is set at **OFF** or **LARGE**.

4 Touch < or > to adjust parameters of the selected speaker unit (filter).

Adjustable parameters and ranges are different depending on each speaker unit (filter).

Parameter	What it does
FREQUENCY	Selects cut-off frequencies in the following order: 50—63—80—100—125—160—200 (Hz)
SLOPE	Selects slopes in the following order: +18—+12—+6 (dB/oct.)

When subwoofer is selected

Parameter	What it does
FREQUENCY	Selects cut-off frequencies in the following order: 50—63—80—100—125—160—200 (Hz)
SLOPE	Selects slopes in the following order: -18—-12—-6—0 (pass) (dB/oct.)
PHASE	Switches the phase between NORMAL and REVERSE .

When tweeter is selected in the network mode

Parameter	What it does
FREQUENCY	Selects cut-off frequencies in the following order: 1.25k—1.6k—2k—2.5k—3.15k—4k—5k—6.3k—8k—10k—12.5k (Hz)
SLOPE	Selects slopes in the following order: +12—+6 (dB/oct.)

When front speaker HPF is selected in the network mode

Parameter	What it does
FREQUENCY	Selects cut-off frequencies in the following order: 50—63—80—100—125—160—200 (Hz)
SLOPE	

Audio Adjustments

Parameter

Selects slopes in the following order:
+18—+12—+6 (dB/oct.)

To switch the filter of the front speaker between LPF and HPF, touch **HIGH** or **LOW**.

When front speaker LPF is selected in the network mode

Parameter	What it does
FREQUENCY	Selects cut-off frequencies in the following order: 1.25k—1.6k—2k—2.5k—3.15k—4k—5k—6.3k—8k—10k—12.5k (Hz)
SLOPE	Selects slopes in the following order: -12—-6—0 (pass) (dB/oct.)

- You can mute the selected speaker unit by touching **MUTE OFF**. To cancel muting, touch **MUTE ON**.

Notes

- Selecting cut-off frequencies sets cut-off frequencies of the subwoofer's L.P.F. (low-pass filter) and that of the **SMALL** speaker H.P.F. (high-pass filter). The cut-off frequency setting has no effect if the subwoofer is set to **OFF** and other speakers are set to **LARGE** or **OFF**.
- If trying to boost the bass output of the subwoofer doesn't do much or rather makes you feel that the bass gets more murky, this may indicate that the subwoofer's output and bass content you hear over other speakers cancel each other out. To remove this problem, try changing the phase setting for the subwoofer.
- You can store the adjusted setting in memory by using **MEMORY**. For details concerning operation, refer to *Storing the adjusted audio settings in memory* on page 91. 

Using the time alignment

The time alignment lets you adjust the distance between each speaker and the listening position.

Recalling time alignment settings

- Touch **TIME ALIGNMENT** on the sound setting menu to select the time alignment. Touch **TIME ALIGNMENT** repeatedly to switch between the following time alignment settings:

INITIAL—AUTO—CUSTOM1—CUSTOM2—CUSTOM3—LAST MEMORY—OFF

- You can select **LAST MEMORY** only when the adjusted time alignment setting is not memorized in this unit.
- You cannot select **AUTO** when **NETWORK** has been selected. (Refer to *Switching the DSP setting mode* on page 104.)
- When **STANDARD** has been selected, you cannot select **AUTO** if auto TA and EQ has not been carried out.

Adjusting the time alignment

You can adjust the distance between each speaker and the selected position.

- An adjusted time alignment can be memorized in **CUSTOM1**, **CUSTOM2** or **CUSTOM3**.

1 Recall the time alignment setting you want to adjust.

Refer to *Recalling time alignment settings* on this page.

2 Touch **ADJ.** next to **TIME ALIGNMENT** on the sound setting menu.

- You cannot adjust the time alignment when neither **FRONT LEFT** nor **FRONT RIGHT** is selected in the position selector mode.

3 Touch < or > to adjust the distance between each speaker and the listening position.

Each time you touch < or > it increases or decreases the distance. **0.0cm to 500.0cm** is displayed as the distance is increased or decreased.

- You can mute the selected speaker unit by touching **MUTE**. To cancel muting, touch **MUTE** again.
- You cannot select speakers whose size is set at **OFF**.



Note

You can store the adjusted setting in memory by using **MEMORY**. For details concerning operation, refer to *Storing the adjusted audio settings in memory* on the next page. 

Adjusting the speaker output levels

You can adjust the speaker output level of each speaker unit.

Recalling the speaker output level settings

● Touch **SPEAKER LEVEL** on the sound setting menu to select the speaker output level setting.

Touch **SPEAKER LEVEL** repeatedly to switch between the following speaker output level settings:

CUSTOM1—CUSTOM2—CUSTOM3—AUTO—LAST MEMORY

- You can select **LAST MEMORY** only when the adjusted speaker output level setting is not memorized in this unit.
- You cannot select **AUTO** when **NETWORK** has been selected. (Refer to *Switching the DSP setting mode* on page 104.)

- When **STANDARD** has been selected, you cannot select **AUTO** if auto TA and EQ has not been carried out.

Adjusting the speaker output levels using a test tone

This function allows you to easily get the overall balance right among the speakers.

1 Recall the speaker output level settings you want to adjust.

Refer to *Recalling the speaker output level settings* on this page.

2 Touch **ADJ.** next to **SPEAKER LEVEL** on the sound setting menu and then touch **TEST TONE**.

The test tone is outputted. It rotates from speaker to speaker in the following sequence at intervals of about two seconds. The current settings for the speaker over which you hear the test tone are shown in the display.
Front left speaker—Front center speaker—Front right speaker—Rear right speaker—Rear center speaker—Rear left speaker—Subwoofer

Check each speaker output level. If no adjustments are needed, perform step 4 to stop the test tone.

- Using **TEST TONE**, the tweeters and the front speakers are adjusted same time. To adjust them separately, please refer to *Adjusting the speaker output levels finely* on the next page.
- The settings do not appear for speakers whose size is set **OFF**.

3 Touch < or > to adjust the speaker output level.

Each time you touch < or > it increases or decreases the speaker output level. **-24dB** to **+10dB** is displayed as the level is increased or decreased.

Audio Adjustments

- The test tone rotates to the next speaker after about two seconds from the last operation.

4 Touch STOP to stop the test tone output.

Notes

- If needed, select speakers and adjust their 'absolute' output levels. (Refer to *Adjusting the speaker output levels* on the previous page.)
- You can store the adjusted setting in memory by using **MEMORY**. For details concerning operation, refer to *Storing the adjusted audio settings in memory* on this page.
- The adjusted speaker output level cannot be stored by each listening position. This means, memorizing a speaker output level for custom setting overwrites the levels of all listening positions.

Adjusting the speaker output levels finely

You can readjust the speaker output levels using a test tone while listening to music.

1 Recall the speaker output level settings you want to adjust.

Refer to *Recalling the speaker output level settings* on the previous page.

2 Touch ADJ. next to SPEAKER LEVEL.

3 Touch < or > to adjust the speaker output level.

Each time you touch < or > it increases or decreases the speaker output level. **-24dB** to **+10dB** is displayed as the level is increased or decreased.

- You cannot select speakers whose size is set at **OFF**.

Notes

- You can store the adjusted setting in memory by using **MEMORY**. For details concerning operation, refer to *Storing the adjusted audio settings in memory* on this page.
- The adjusted speaker output level cannot be stored by each listening position. This means, memorizing a speaker output level for custom setting overwrites the levels of all listening positions. 

Using the auto-equalizer

You can use this function only when **STANDARD** has been selected. (Refer to *Switching the DSP setting mode* on page 104.)

The auto-equalizer is the equalizer curve created by auto TA and EQ (refer to *Auto TA and EQ (auto-time alignment and auto-equalizing)* on the next page).

You can turn the auto-equalizer on or off.

1 Touch AUTO EQ on the sound setting menu.

- You cannot use this function if auto TA and EQ has not been carried out.

2 Touch ON to turn the auto-equalizer on.

- To turn auto-equalizer off, touch **OFF**. 

Storing the adjusted audio settings in memory

You can store the adjusted audio settings in this unit for later recall.

1 Touch MEMORY.

2 Touch any of CUSTOM1, CUSTOM2 or CUSTOM3 to store the adjusted setting.

3 Touch **YES** to store the current setting into the selected sound setting.

- To cancel the storage process, touch **NO**. 

Editing the name of sound settings

The name displayed for sound settings (**SETTING1**, **SETTING2** and **SETTING3**) can be changed.

- Each name can be up to 10 characters long.

1 Touch any of **SETTING1**, **SETTING2** or **SETTING3** on the sound setting menu.

2 Touch **NAME EDIT**.

3 Touch the letter you wish to input.

Key	What it does
<	Moves the cursor to the previous character position.
>	Moves the cursor to the next character position.
␣	Inputs the space.
ABC/123	Switches keypad between alphabet and numeric.
⊗	Deletes letter by letter from the end of the text.

4 Touch **MEMORY** to store the entered name in memory. 

Auto TA and EQ (auto-time alignment and auto-equalizing)

*You can use this function only when **STANDARD** has been selected. (Refer to Switching the DSP setting mode on page 104.)*

The auto-time alignment is automatically adjusted for the distance between each speaker and the listening position.

The auto-equalizer automatically measures the car interior acoustic characteristics, and then creates the auto-equalizer curve based on that information.

WARNING

To prevent accidents, never carry out auto TA and EQ while driving. When this function measures the car interior acoustic characteristics to create an auto-equalizer curve, a loud measurement tone (noise) may be outputted from the speakers.

CAUTION

- Carrying out auto TA and EQ under the following conditions may damage the speakers. Be sure to check the conditions thoroughly before carrying out auto TA and EQ.
 - When speakers are incorrectly connected. (e.g., When a rear speaker is connected to a subwoofer output.)
 - When a speaker is connected to a power amp delivering output higher than the speaker's maximum input power capability.
- If the microphone is placed in an unsuitable position the measurement tone may become loud and measurement may take a long time, resulting in a drain on battery power. Be sure to place the microphone in the specified location.

Audio Adjustments

Before operating the auto TA and EQ function

- Carry out auto TA and EQ in as quiet a place as possible, with the car engine and air conditioning switched off. Also cut power to car phones or portable telephones in the car, or remove them from the car before carrying out auto TA and EQ. Sounds other than the measurement tone (surrounding sounds, engine sound, telephones ringing etc.) may prevent correct measurement of the car interior acoustic characteristics.
- Be sure to carry out auto TA and EQ using the supplied microphone. Using another microphone may prevent measurement, or result in incorrect measurement of the car interior acoustic characteristics.
- When front speaker is not connected, auto TA and EQ cannot be carried out.
- When this unit is connected to a power amp with input level control, auto TA and EQ may not be possible if you lower power amp input level. Set the power amp's input level to the standard position.
- When this unit is connected to a power amp with an LPF, turn off the LPF on the power amp before carrying out auto TA and EQ. In addition, the cut-off frequency for built-in LPF of an active subwoofer should be set to the highest frequency.
- The time alignment value calculated by auto TA and EQ may differ from the actual distance in the following circumstances. However, the distance has been calculated by computer to be the optimum delay to give accurate results for the circumstances, so please continue to use this value.
 - When the reflected sound within a vehicle is strong and delays occur.
 - When delays occur for low sounds due to the influence of the LPF on active subwoofers or external amps.

- Auto TA and EQ changes the audio settings as below:
 - The fader/balance settings return to the center position. (Refer to page 78.)
 - The equalizer curve switches to **FLAT**. (Refer to page 84.)
 - It will be adjusted automatically to high pass filter setting for front, center and rear speaker.
- If you carry out auto TA and EQ when a previous setting of this already exists, the setting will be replaced.

Carrying out auto TA and EQ

1 Stop the car in a place that is as quiet as possible, close all doors, windows and the sun roof, and then turn the engine off.

If the engine is left running, engine noise may prevent correct auto TA and EQ.

2 Fix the supplied microphone in the center of the headrest of the driver's seat, facing forward, using the belt (sold separately).

The auto TA and EQ may differ depending on where you place the microphone. If desired, place the microphone on the front passenger seat to carry out auto TA and EQ.

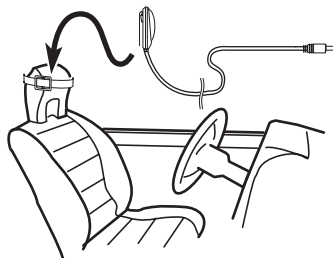

3 Turn the ignition switch to ON or ACC.

If the car's air conditioner or heater is turned on, turn it off. Noise from the fan in the air conditioner or heater may prevent correct auto TA and EQ.

4 Press SOURCE to turn the source off if this unit is turned on.**5 Touch the screen to display the touch panel keys.****6 Touch AV MENU and then touch AUTO EQ&TA to enter the auto TA and EQ measurement mode.****7 Touch either of the following touch panel keys to select the position for the seat on which the microphone is placed.**

- **FRONT LEFT** – Front seat left
- **FRONT RIGHT** – Front seat right

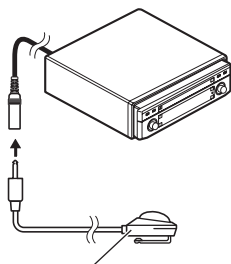
8 Touch NEXT.**9 Plug the AUTO TA&EQ microphone into the microphone/auxiliary input jack on this unit.**

AUTO TA&EQ microphone

10 Touch START to start the auto TA and EQ.**11 Get out of the car and close the door within 10 seconds when the 10-second count-down starts.**

The measurement tone (noise) is outputted from the speakers, and auto TA and EQ begins.

- When all speakers are connected, auto TA and EQ is completed in about 14 minutes.
- To stop auto TA and EQ, touch **STOP**.
- To cancel auto TA and EQ part way through, touch **BACK** or **ESC**.

12 When auto TA and EQ is completed, Complete is displayed.

When correct measurement of car interior acoustic characteristics is not possible, an error message is displayed. (Refer to *Understanding auto TA and EQ error messages* on page 113.)

13 Touch ESC to cancel the auto TA and EQ mode.**14 Store the microphone carefully in the glove compartment.**

Store the microphone carefully in the glove compartment or any other safe place. If the microphone is subjected to direct sunlight for an extended period, high temperatures may cause distortion, color change or malfunction. ■

Setup

Introduction of setup adjustments

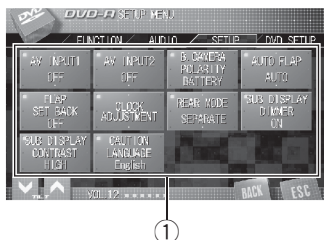

① Setup menu display

Shows the setup function names.

1 Touch AV MENU and then touch SETUP to display the setup function names.

The setup function names are displayed and operable ones are highlighted.

2 Touch ESC to return to the display of each source.

- To return to the previous display, touch **BACK**.

Setting the AV input

You can connect up to two AV components to this unit and display videos either on **AV** source or **S-DVD** source.

Switch the AV input setting depending on the connected AV components.

- Select **VIDEO** to watch video of a connected component as **AV** source.
- Select **S-DVD** to watch video of a connected DVD player as **S-DVD** source.
- Select **B.UP CAMERA** to watch a rear view camera video while you are backing your vehicle.

When AV component is connected to AV input 1

- Touch **AV INPUT 1** on the setup menu to select the AV input 1 setting.

Touch **AV INPUT 1** until the desired setting is selected.

- **OFF** – No video component is connected
- **VIDEO** – External video component (such as portable video player)
- **S-DVD** – DVD player connected with RCA cable
 - When a DVD player is connected with an AV-BUS cable, do not select **S-DVD** otherwise no picture will be displayed even if you select **S-DVD** as a source.

When AV component is connected to AV input 2

- Touch **AV INPUT 2** on the setup menu to select your desired setting.

Touch **AV INPUT 2** until the desired setting is selected.

- **OFF** – No video component is connected
- **VIDEO** – External video component (such as portable video player)
- **B.UP CAMERA** – Rear view camera

When rear view camera is connected to AV input 2

CAUTION

Pioneer recommends the use of a camera which outputs mirror reversed images, otherwise screen image may appear reversed.

You can install a rear view camera onto the AV input 2 and display a rear view camera video. When the gear shift is in **REVERSE (R)** position, the video automatically switches to a rear view camera video. (For more details, consult your dealer.)

- After you set up the rear view camera setting, move the gear shift in **REVERSE (R)** and confirm if a rear view camera video can be shown on the display.
- If the display should be switched to a rear view camera video by error while you are driving forward, change the rear view camera setting.
- To end watching a rear view camera video and return to the source display, press **V.ADJUST**.

1 Touch AV INPUT 2 on the setup menu to select B.UP CAMERA.

2 Touch B. CAMERA POLARITY on the setup menu to select an appropriate setting for polarity.

Each time you touch **B. CAMERA POLARITY** it switches between the following polarity:

- **BATTERY** – When the polarity of the connected lead is positive while the gear shift is in **REVERSE (R)** position
- **GROUND** – When the polarity of the connected lead is negative while the gear shift is in **REVERSE (R)** position 

Setting the automatic open function

To prevent the display from hitting the shift lever of an automatic vehicle when it is in **P** (park) position, or when you do not wish the display to open/close automatically, you can set the automatic open function in the manual mode.

- **Touch AUTO FLAP on the setup menu to select the display to open/close automatically or manually.**

Each time you touch **AUTO FLAP** it switches between the following settings:

- **AUTO** – The LCD panel will be opened or closed automatically with the turning of the ignition switch on or off
- **MANUAL** – You have to press **OPEN/CLOSE** to open/close the LCD panel 

Adjusting the LCD panel slide position

You can adjust the LCD panel slide position so that the panel is set back or forward.

- **Touch FLAP SET BACK on the setup menu to turn the set back on.**

The LCD panel slides to the back.

- Touch **FLAP SET BACK** again to turn the set back off and the LCD panel slides to the front. 

Setting the clock

Use these instructions to set the clock.

1 Touch CLOCK ADJUSTMENT on the setup menu.

2 Touch 0—9 to set the clock.

- To cancel the inputted numbers, touch **C**.

3 Touch ENTER.



Note

Touching **24h/12h** switches the clock display on the sub-display between 12/24-hour formats. 

Setup

Setting the video of rear display

You can select either showing the same source as the front display or showing the video source on rear display independently.

- When selecting **FRONT** and the selected source is an audio source, nothing is displayed on the rear display.
- When selecting **FRONT**, audio is not outputted from **REAR DISPLAY OUT**.

- **Touch REAR MODE on the setup menu to select the video on rear display.**

Each time you touch **REAR MODE** it switches between the following settings:

- **FRONT** – Display the same source as the front display
- **SEPARATE** – Display the video source on rear display independently of front display

Switching the dimmer setting for sub-display

To prevent the sub-display from being too bright at night, the sub-display is automatically dimmed when the car's headlights are turned on. You can turn dimmer on or off.

- **Touch SUB DISPLAY DIMMER on the setup menu to turn dimmer on.**

- To turn dimmer off, touch **SUB DISPLAY DIMMER** again.

Adjusting the contrast for the sub-display

Display contrast adjustment lets you adjust the display for easier viewing when lighting conditions change.

- **Press SUB DISPLAY CONTRAST on the setup menu to switch the contrast setting.**

Each time you touch

SUB DISPLAY CONTRAST it switches between **HIGH** (high contrast) and **LOW** (low contrast).

Changing languages for CAUTION

Some operations on this unit are prohibited while driving or needs to be paid a careful attention when operating. In such case, a caution appears on the display. You can change the language of the cautions at this setting.

- 1 Touch CAUTION LANGUAGE on the setup menu.**

- 2 Touch the desired language.**

The language for CAUTION is set.

Introduction of DVD setup adjustments



You can use this menu to change audio, subtitle, parental lock and other DVD settings.

- When watching a DVD/Video CD on the rear display independently, you cannot operate this menu.

① DVD setup menu display

Shows the DVD setup menu names.

1 While playing a disc, touch AV MENU and then touch DVD SETUP to display the DVD setup function names.

The DVD setup function names are displayed and operable ones are highlighted.

2 Touch ESC to return to the playback display.

- To return to the previous display, touch **BACK**.

Setting the subtitle language

You can set a desired subtitle language. If the selected subtitle language is recorded on the DVD, subtitles are displayed in that language.

1 Touch SUB TITLE LANGUAGE on the DVD setup menu.

A subtitle language menu is displayed.

2 Touch the desired language.

A subtitle language is set.

- If you have selected **Others**, refer to *When you select Others* on this page.



Notes

- If the selected language is not recorded on the disc, the language specified on the disc is displayed.
- You can also switch the subtitle language by touching **SUBTITLE** during playback. (Refer to *Changing the subtitle language during playback (Multi-subtitle)* on page 34.)
- Even if you use **SUBTITLE** during playback to switch the subtitle language, this does not affect the settings here.

When you select Others

When you select **Others**, a language code input display is shown. Refer to *Language code chart for DVD* on page 120 to input the four-digit code of the desired language.

1 Touch 0—9 to input the language code.

- To cancel the inputted numbers, touch **C**.

2 Touch ENTER.

Setting the audio language

You can set the preferred audio language.

1 Touch AUDIO LANGUAGE on the DVD setup menu.

An audio language menu is displayed.

2 Touch the desired language.

The audio language is set.

- If you have selected **Others**, refer to *When you select Others* on this page.

Setting up the DVD player



Notes

- If the selected language is not recorded on the disc, the language specified on the disc is outputted.
- You can also switch the audio language by touching **AUDIO** during playback. (Refer to *Changing audio language during playback (Multi-audio)* on page 34.)
- Even if you use **AUDIO** during playback to switch the audio language, this does not affect the settings here.

Setting the menu language

You can set the preferred language for displays of menus recorded on a disc.

1 Touch MENU LANGUAGE on the DVD setup menu.

A menu language menu is displayed.

2 Touch the desired language.

The menu language is set.

- If you have selected **Others**, refer to *When you select Others* on the previous page.



Note

If the selected language is not recorded on the disc, the language specified on the disc is displayed.

Switching the assist subtitle on or off

If assist subtitles are recorded on a DVD disc, you can display them by turning the assist subtitle function on.

You can turn assist subtitles on or off as desired.

● Touch ASSIST SUB TITLE on the DVD setup menu to turn assist subtitles on.

- To turn the assist subtitle off, touch **ASSIST SUB TITLE** again.

Setting the angle icon display

You can set it up so that the angle icon appears on scenes where the angle can be switched.

● Touch MULTI ANGLE on the DVD setup menu to turn angle icon display on.

- To turn the angle icon display off, touch **MULTI ANGLE** again.

Setting the aspect ratio

There are two kinds of display. A wide screen display has a width-to-height ratio (TV aspect) of 16:9, while a regular display has a TV aspect of 4:3. Be sure to select the correct TV aspect for the display connected to **REAR DISPLAY OUT**.



- When using a regular display, select either **LETTER BOX** or **PAN SCAN**. Selecting **16:9** may result in an unnatural picture.
- If you select the TV aspect, the unit's display changes to the same setting.

● Touch TV ASPECT on the DVD setup menu to select the TV aspect.

Touch **TV ASPECT** repeatedly until the desired TV aspect appears in the display.

- **16:9** – Wide screen picture (16:9) is displayed as it is (initial setting)
- **LETTER BOX** – The picture is the shape of a letterbox with black bands at the top and bottom of the screen
- **PAN SCAN** – The picture is cut short at the right and left of the screen

**Notes**

- When playing discs that do not specify **PAN SCAN**, playback is with **LETTER BOX** even if you select **PAN SCAN** setting. Confirm whether the disc package bears the  mark. (See page 12.)
- Some discs do not enable changing of the TV aspect. For details, refer to the disc's instructions. .

Setting the parental lock

Some DVD video discs let you use parental lock to restrict children from viewing violent and adult-oriented scenes. You can set the parental lock to your desired level.

- When you set a parental lock level and then play a disc featuring parental lock, code number input indications may be displayed. In this case, playback will begin when the correct code number is input.

Setting the code number and level

You need to have registered a code number for playing back discs with parental lock.

1 Touch PARENTAL on the DVD setup menu.

2 Touch 0—9 to input a four digit code number.

- To cancel the inputted numbers, touch **C**.

3 Touch ENTER.

The code number is set, and you can now set the level.

4 Touch any of 1—8 to select the desired level.

The parental lock level is set.

- **8** – Playback of the entire disc is possible (initial setting)

- **7 to 2** – Playback of discs for children and non-adult-oriented discs is possible
- **1** – Playback of discs for children only is possible

**Notes**

- We recommend to keep a record of your code number in case you forget it.
- The parental lock level is recorded on the disc. Look for the level indication written at the disc package, included literature or on the disc itself. Parental lock of this unit is not possible if a parental lock level is not recorded in the disc.
- With some discs, the parental lock may be active only on the scenes with certain levels. The playback of those scenes will be skipped. For details, refer to the instruction manual that came with the discs.

Changing the level

You can change the set parental lock level.

1 Touch PARENTAL on the DVD setup menu.

2 Touch 0—9 to input the registered code number.

3 Touch ENTER.

This enters the code number, and you can now change the level.

- If you input an incorrect code number, the icon  is displayed. Touch **C** and input the correct code number.
- If you forget your code number, refer to *If you forget your code number* on the next page.

4 Touch any of 1—8 to select the desired level.

The new parental lock level is set.

Setting up the DVD player

If you forget your code number

Refer to *Changing the level* on the previous page, and touch **C** 10 times. The registered code number is canceled, letting you register a new one. 

Setting the still picture

The unit uses one of two processes when displaying a still picture from a DVD disc.

● Touch **STILL PICTURE** on the DVD setup menu to select the setting.

Touch **STILL PICTURE** repeatedly until the desired setting appears in the display.

- **AUTO – FIELD** or **FRAME** is selected automatically by this unit.
- **FIELD** – Produces a stable, generally shake-free image.
- **FRAME** – Produces a sharper image, but more prone to shake than field stills. 

To play back bonus groups

Some DVD audio discs have an extra 'bonus' group that requires a four-digit password to access. See the disc packaging for details and the password. When you try and play the bonus group, the password input screen will automatically appear.

- The bonus group can be played back after the password has been entered, until the disc is removed from the unit.

1 Touch **BONUS GROUP** on the DVD setup menu.

2 Touch **0—9** to input a four-digit password.

- If you input an incorrect password, touch **C** and then input the correct password.

3 Touch **ENTER**.

Displaying your DivX® VOD registration code

In order to play DivX VOD (video on demand) content on this unit, you first need to register the unit with your DivX VOD content provider. You do this by generating a DivX VOD registration code, which you submit to your provider.

● Touch **DivX VOD** on the DVD setup menu.

Your 8-digit registration code is displayed.

- Make a note of the code as you will need it when you register with a DivX VOD provider. 

Setting remote control code type

When the remote control operation switch is set to **DVD**, changing the remote control code type enables you to operate the Pioneer DVD player with the supplied remote control. There are three remote codes, code type **A**, code type **B** and code type **AVH**. When operating a multi-DVD player (e.g. **XDV-P90**), select code **A**. When operating this unit, select code **AVH**. 

1 Set the remote control selection switch on the left side of the remote control to the appropriate position with a pen tip or other pointed instrument .

- If you select **AVH** mode, there is no need to take the following procedure.
- If you select **A/B** mode, take the following procedure and change the code type to the appropriate type.

2 Press **7** and **0** on the remote control simultaneously to change the code type.

Initially, the code type is set to **A**. Each time you press **7** and **0** simultaneously on the remote control the code type switches between **A** and **B**. 

Adjusting initial settings

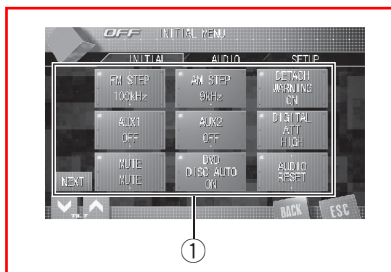

Using the initial settings, you can customize various system settings to achieve optimal performance from this unit.

① Function display

Shows the function names.

1 Touch the source icon and then touch OFF to turn this unit off.

2 Touch the screen to display the touch panel keys.

3 Touch AV MENU to display the function names.

The function names are displayed and operable ones are highlighted.

- To go to the next group of function names, touch **NEXT**.
- To return to the previous group of function names, touch **PREV**.

4 Touch ESC to return to the display of each source.

- To return to the previous display, touch **BACK**.



Note

You can use **AUTO EQ&TA** (auto-time alignment and auto-equalizing), only when **STANDARD** has been selected in **DSP MODE**. (Refer to *Switching the DSP setting mode* on page 104.)

Setting the FM tuning step

The FM tuning step employed by seek tuning can be switched between 100 kHz, the preset step, and 50 kHz.

● Touch FM STEP on the initial menu to select the FM tuning step.

Touching **FM STEP** will switch the FM tuning step between 50 kHz and 100 kHz. The selected FM tuning step will appear in the display.



Note

If seek tuning is performed in 50 kHz steps, stations may be tuned in imprecisely. Tune in the stations with manual tuning or use seek tuning again.

Setting the AM tuning step

The AM tuning step can be switched between 9 kHz, the preset step, and 10 kHz. When using the tuner in North, Central or South America, reset the tuning step from 9 kHz (531 kHz to 1 602 kHz allowable) to 10 kHz (530 kHz to 1 640 kHz allowable).

● Touch AM STEP on the initial menu to select the AM tuning step.

Touching **AM STEP** will switch the AM tuning step between 9 kHz and 10 kHz. The selected AM tuning step will appear in the display.

Switching the warning tone

If the front panel is not detached from the head unit within five seconds of turning off the ignition, a warning tone will sound. You can turn off the warning tone.

Initial Settings

- Touch **DETACH WARNING** on the initial menu to turn warning tone on.

- To turn warning tone off, touch **DETACH WARNING** again. 

Switching the auxiliary setting

Auxiliary equipments connected to this unit can be activated individually. Set each AUX source to ON when using. About connecting or using auxiliary equipments, refer to *Using the AUX source* on page 109.

- Touch **AUX1/AUX2** on the initial menu to turn each auxiliary setting on.

- To turn auxiliary setting off, touch **AUX1/AUX2** again. 

Correcting distorted sound

You can minimize distortion that may be caused by the equalizer curve settings. Setting an equalizer level high can cause distortion. If high sound is crippled or distorted, try switching to **LOW**. Normally, leave the setting at **HIGH** to ensure quality sound.

- Touch **DIGITAL ATT** on the initial menu to switch the digital attenuator setting.

Touch **DIGITAL ATT** repeatedly until the desired setting appears in the display.

- **HIGH** – High quality sound
- **LOW** – Minimize distortion sound 

Switching the sound muting/attenuation

Sound from this system is muted or attenuated automatically when the signal from the equipment with mute function is received.

- Sound from this system returns to normal when the muting or attenuation is canceled.

- Touch **MUTE** on the initial menu to select any of the muting, attenuation or off.

Touch **MUTE** until the desired setting appears in the display.

- **MUTE** – Muting
- **ATT –10dB** – Attenuation
- **ATT –20dB** – Attenuation (**ATT –20dB** has a stronger effect than **ATT –10dB**)
- **OFF** – Turn the sound muting/attenuation off



Notes

- The sound is turned off, **MUTE** is displayed and no audio adjustments are possible.
- The sound is attenuated, **ATT** is displayed and no audio adjustments, except volume control, are possible.
- Operation returns to normal when the phone connection is ended. 

Switching the automatic disc playback

You can turn automatic disc playback on or off when you insert a disc into the disc loading slot. When this function is on, the disc will be automatically played after it is inserted into the disc loading slot.

Initially, this function is set to on.

Initial Settings

- **Touch DVD DISC AUTO on the initial menu to turn automatic disc playback on.**
 - To turn automatic disc playback off, touch **DVD DISC AUTO** again. 

Resetting the audio functions

You can reset all audio functions except volume.

Important

If you perform this operation, audio settings are erased. For this reason, we recommend that you record the settings in the sheet on page 121 after you have completed audio adjustments.

1 Touch AUDIO RESET on the initial menu.

2 Touch RESET.

Proceed with reset? appears and asks you to confirm it.

3 Touch RESET again to reset audio functions.

Reset completed is displayed and the audio settings are reset.

- To cancel resetting the audio functions, touch **CANCEL**. 

Switching the DSP setting mode

This unit features two operation modes: the network mode and the standard mode. You can switch between modes as desired. Initially, the DSP setting is set to the standard mode.

- Switching the DSP mode erases the current adjusting audio settings

(**LAST MEMORY**). If needed, memorize it into custom settings (**CUSTOM1**, **CUSTOM2** or **CUSTOM3**).

1 Touch DSP MODE on the initial menu.

2 Touch either of the following touch panel keys to select the desired mode.

- **STANDARD** – Standard mode
- **NETWORK** – Network mode

3 Touch CHANGE to change the mode.

- To cancel changing the mode, touch **CANCEL**. 

Setting the optical input

When connecting a DVD player, select **S-DVD**.

● **Touch OPTICAL INPUT on the initial menu to select the optical input setting.**

Touch **OPTICAL INPUT** until the desired setting appears in the display.

- **OFF** – No DVD player is connected
- **S-DVD** – DVD player/multi-DVD player 

Setting the TV signal

When this unit is connected to a TV tuner, you need to adjust the TV signal suitable to your country TV signal setting.

- This function is initially set to **AUTO** so that this unit automatically adjusts the TV signal setting.

● **Touch TV FORMAT on the initial menu to select an appropriate TV signal.**

Touching **TV FORMAT** switches TV signal settings in the following order:

AUTO—PAL—NTSC—PAL-M—SECAM

Initial Settings



Note

About your country TV signal, consult with your nearest Pioneer dealer. 

Entering PIN code for Bluetooth wireless connection

With some Bluetooth audio players, you may be required to enter to this unit in advance PIN code of your Bluetooth audio player, in order to set this unit ready for a connection from your Bluetooth audio player.

- Only when Bluetooth adapter (e.g. **CD-BTB100**) is connected to this unit, you can operate this function.

1 Touch PIN EDIT on the initial menu.

PIN code input display appears.

2 Touch 0—9 to input the PIN code of your Bluetooth audio player.

- To cancel the inputted numbers, touch **C**.

3 After inputting PIN code (up to 16 digits), touch ENTER.

The PIN code you entered is stored in this unit. 

Setting the security indicator

The LED indicator (security indicator) will flash when front panel is detached from the head unit. You can turn this indicator on or off.

● Touch SECURITY INDICATOR on the initial menu to turn security indicator on.

- To turn security indicator off, touch **SECURITY INDICATOR** again. 

Switching the display on the sub-display

You can switch between the displays on the sub-display.

- **Press 2ch/MULTI-CH and hold to switch the display.**

Press and hold **2ch/MULTI-CH** repeatedly to switch between the following settings:

Source display—clock display—OFF 

Adjusting the screen

Changing the wide screen mode

You can select a desired mode for enlarging a 4:3 picture to a 16:9 one.

- **Press WIDE to select the desired setting.**

Press **WIDE** repeatedly to switch between the following settings:

FULL (full)—**JUST** (just)—**CINEMA** (cinema)—

ZOOM (zoom)—**NORMAL** (normal)—**AUTO** (auto)

FULL (full)

A 4:3 picture is enlarged in the horizontal direction only, giving you a 4:3 TV picture (normal picture) without any omissions.

JUST (just)

The picture is enlarged slightly at the center and the amount of enlargement increases horizontally to the ends, enabling you to enjoy a 4:3 picture without sensing any disparity even on a wide screen.

CINEMA (cinema)

The picture is enlarged by the same proportion as **FULL** or **ZOOM** in the horizontal direction and by an intermediate proportion between **FULL** and

ZOOM in the vertical direction; ideal for a cinema-sized picture (wide screen picture) where captions lie outside.

ZOOM (zoom)

A 4:3 picture is enlarged in the same proportion both vertically and horizontally; ideal for a cinema-sized picture (wide screen picture).

NORMAL (normal)

A 4:3 picture is displayed as it is, giving you no sense of disparity since its proportions are the same as that of the normal picture.

AUTO (auto)

In this mode, this unit selects the appropriate setting from among **FULL**, **JUST**, **CINEMA**, **ZOOM** or **NORMAL** automatically.



Notes

- Different settings can be memorized for each video source.
- When video is viewed in a wide screen mode that does not match its original aspect ratio, it may appear different.
- Remember that using the wide mode feature of this system for commercial or public viewing purposes may constitute an infringement on the author's rights protected by the Copyright Law.
- Video will appear grainy when viewed in **CINEMA** or **ZOOM** mode.

Changing the picture adjustment

You can adjust **BRIGHT** (brightness), **CONTRAST** (contrast), **COLOR** (color) and **HUE** (hue) for each source and rear view camera.

Other Functions

- The adjustments of **BRIGHT** and **CONTRAST** are stored separately for light ambient (daytime) and dark ambient (nighttime). A sun ☀ or moon 🌙 is displayed to the left of **BRIGHT** and **CONTRAST**, respectively, as the ambient light sensor determines brightness or darkness.
- You cannot adjust **HUE** for PAL video.
- You cannot adjust **COLOR** or **HUE** for the audio source.

1 Press V.ADJUST to display PICTURE ADJUSTMENT.

2 Touch < or > to adjust the following items.

The adjustment function names are displayed and adjustable ones are highlighted.

Each time you touch < or > it increases or decreases the level of selected item. **-24 to +24** is displayed as the level is increased or decreased.

- **BRIGHT** – Adjust the black intensity
- **CONTRAST** – Adjust the contrast
- **COLOR** – Adjust the color saturation
- **HUE** – Adjust the tone of color (red is emphasized or green is emphasized)
- **DIMMER** – Adjust the brightness of display
- **B.Camera/SOURCE** – Switch the picture adjustment modes
 - You can adjust the picture adjustment for rear view camera only when **BACK UP CAMERA IN** is turned on. (Refer to *When rear view camera is connected to AV input 2* on page 95.)
 - If you are viewing image from the rear view camera, you cannot adjust picture adjustment for the selected source.
 - With some rear view cameras, picture adjustment may not be possible.

3 Touch ESC to hide the touch panel keys.

Adjusting the dimmer

The adjustment of **DIMMER** is stored separately for each ambient light; daytime, evening and nighttime. The brightness of LCD screen will be adjusted to optimum level automatically in accordance with the ambient light based on the setting values.

- The icons indicating the current ambient brightness used for adjusting **BRIGHT** and **CONTRAST** may differ from **DIMMER** slightly.

1 Press V.ADJUST to display PICTURE ADJUSTMENT.

The ambient light level used as the standard for adjusting **DIMMER** appears above the level bar.

- Red sun ☀ – Adjust the brightness for bright ambient light (daytime)
- Orange sun 🌅 – Adjust the brightness for intermediate brightness (evening)
- Yellow moon 🌙 – Adjust the brightness for dark ambient light (nighttime)

2 Touch < or > for DIMMER to adjust the brightness.

Each time you touch < or > it moves cursor towards the left or the right.

The level indicates the brightness of the screen being adjusted. The farther cursor moves to the right, the brighter the screen.

3 Touch ESC to hide the touch panel keys. [■]

Selecting the background display

You can display the thumbnails of available background pictures/movies and select one to set your background display. The selection can be made each for the audio source group (playing CD, listening to Tuner, etc.), telephone source and the movie source group (watching DVD, AV, etc.).

1 Press ENTERTAINMENT.

Thumbnails of background pictures/movies appear on the display.

2 Touch one of the thumbnails that you want to display in the background.

The selected picture/movie is displayed at the background.



Note

In the following cases, background images from that source cannot be selected:

- When there is no disc in the unit.
- When the AV (AV input) is not set to **VIDEO** (refer to page 95). 

Adjusting the response positions of the touch panels (Touch Panel Calibration)

If you feel that the touch panel keys on the screen deviate from the actual positions that respond to your touch, adjust the response positions of the touch panel. There are two adjustment methods: 4-point adjustment, in which you touch four corners of the screen; and 16-point adjustment, in which you make fine-adjustments on the entire screen.

- Make sure to use the supplied pen for adjustment, and gently touch the screen. If you press the touch panel forcefully, the touch panel may be damaged. Do not use a sharp pointed tool such as ballpoint pen

or a mechanical pen. Otherwise the screen is damaged.

1 Press V.ADJUST to display PICTURE ADJUSTMENT.

2 Press and hold V.ADJUST.

The 4-point touch panel adjustment screen appears.

3 Touch each of the arrows on the four corners of the screen with the touch panel adjustment pen.

- To cancel the adjustment, press and hold **V.ADJUST**.

4 Press V.ADJUST to complete the 4-point adjustment.

The adjusted position data is saved.

- Do not turn off the engine while saving the adjusted position data.

5 Press V.ADJUST to proceed to the 16-point adjustment.

The 16-point touch panel adjustment screen appears.

- To cancel the adjustment, press and hold **V.ADJUST**.

6 Gently touch the center of the + mark displayed on the screen with the touch panel adjustment pen.

After you touch all the marks, the adjusted position data is saved.

- Do not turn off the engine while saving the adjusted position data.

7 Press and hold V.ADJUST to complete the adjustment.



Note

If touch panel adjustment cannot be performed properly, consult your local Pioneer dealer. 

Other Functions

Using the AUX source

This unit can control an auxiliary equipment such as VCR or portable device (sold separately). When connected, auxiliary equipment is automatically read in as AUX source and assigned to **AUX**.

About AUX connection method

You have two methods to connect auxiliary equipment to this unit.

Stereo mini pin plug cable

When connecting auxiliary equipment using a stereo mini plug cable

- **Insert the stereo mini plug into the microphone/auxiliary input jack on this unit.** For more details, refer to the installation manual.

IP-BUS-RCA interconnector

When connecting auxiliary equipment using an IP-BUS-RCA Interconnector (sold separately)

- **Use an IP-BUS-RCA Interconnector such as the **CD-RB20/CD-RB10** (sold separately) to connect this unit to auxiliary equipment featuring RCA output.** For more details, refer to the IP-BUS-RCA Interconnector owner's manual.
 - You can only make this type of connection if the auxiliary equipment has RCA outputs.

Selecting AUX as the source

- **Touch the source icon and then touch **AUX1/AUX2** to select **AUX** as the source.**
 - If the auxiliary setting is not turned on, **AUX** cannot be selected. For more details, see *Switching the auxiliary setting* on page 103.

Setting the AUX title

The title displayed for the **AUX** source can be changed.

- Each title can be up to 10 characters long.

1 After you have selected **AUX as the source, touch **AV MENU** and **FUNCTION** and then touch **NAME EDIT**.**

2 Touch the letter you wish to input.

For details concerning operation, refer to *Editing the name of sound settings* on page 92. 

Using the PGM button

You can operate the preprogrammed functions for each source by using **PGM**.

- **Press **PGM** to turn pause on when selecting the following sources:**

- **DVD** – Built-in DVD player
- **S-DVD** – DVD player/multi-DVD player
- **M-CD** – Multi-CD player
- **iPod** – iPod
- **BT AUDIO** – Bluetooth Audio
- To turn pause off, press **PGM** again.

- **Press **PGM** and hold to turn **BSM** on when selecting **FM** or **AM** as the source.**

Press **PGM** and hold until the **BSM** turns on.

- To cancel the storage process, press **PGM** again.

- **Press **PGM** and hold to turn **BSSM** on when selecting **TV** as the source.**

Press **PGM** and hold until the **BSSM** turns on.

- To cancel the storage process, press **PGM** again. 



Additional Information

Troubleshooting

Common

Symptom	Cause	Action (See)
Power doesn't turn on. The unit doesn't operate.	Leads and connectors are incorrectly connected.	Confirm once more that all connections are correct.
	The fuse is blown.	Rectify the reason for the fuse blowing, then replace the fuse. Be very sure to install the correct fuse with the same rating.
	Noise and other factors are causing the built-in microprocessor to operate incorrectly.	Press RESET . (Page 12)
Operation with the remote control isn't possible. The unit does not operate correctly even when the appropriate remote control buttons are pressed.	The remote control operation mode is incorrect.	Switch to the correct remote control mode. (Page 19)
	The remote control code is incorrect.	Make sure the remote control selection switch setting and code type setting are the same. (Page 101)
	Battery power is low.	Load new battery. (Page 13)
	Some operations are prohibited with certain discs.	Check by using another disc.
Playback is not possible.	The disc is dirty.	Clean disc. (Page 114)
	The loaded disc is a type this unit cannot play.	Check what type the disc is.
	Non compatible video system disc is loaded.	Change to a disc compatible to your video system.
No sounds are heard. The volume level will not rise.	Cables are not connected correctly.	Connect the cables correctly.
	The unit is performing still, slow motion or frame-by-frame playback.	There is no sound during still, slow motion or frame-by-frame playback.
	The front, rear, left and right speakers are not properly adjusted in level balance.	Adjust the relative levels between the speakers correctly. (Page 78)
Sound is not heard over a specific speaker.	The speaker size is set to OFF .	Make the correct size setting for the speaker. (Page 87)
	The speaker level is set too low.	Increase the speaker level setting to get the balance right with the other speakers. (Page 90)
	The center speaker size is set to SMALL or LARGE whereas no center speaker is installed.	Set the center speaker size to OFF . (Page 87)
There is no picture.	The parking brake cord is not connected.	Connect a parking brake cord, and apply the parking brake.
	The parking brake is not applied.	Connect a parking brake cord, and apply the parking brake.

Additional Information

Symptom	Cause	Action (See)
The icon  is displayed, and operation is not possible.	The operation is prohibited for the disc.	This operation is not possible.
	The operation is not compatible with the disc's organization.	This operation is not possible.
The picture stops (pauses) and the unit cannot be operated.	Reading of data has become impossible during playback.	After pressing  once, start playback once more.
There is no sound. Volume level is low.	The volume level is low.	Adjust the volume level.
	The attenuator is on.	Turn the attenuator off.
There is audio and video skipping.	The unit is not firmly secured.	Secure the unit firmly.
The picture is stretched, the aspect is incorrect.	The aspect setting is incorrect for the display.	Select the appropriate setting for your display. (Page 99)
When the ignition switch is turned ON (or turned to ACC), the motor sounds.	The unit is confirming whether a disc is loaded or not.	This is a normal operation.
Nothing is displayed. The touch panel keys cannot be used.	The rear view camera is not connected. BACK UP CAMERA IN is at incorrect setting.	Connect a rear view camera. Press V.ADJUST to return to the source display and then select the correct setting for BACK UP CAMERA IN . (Page 95)

Problems during DVD playback

Symptom	Cause	Action (See)
Playback is not possible.	The loaded disc has a different region number from this unit.	Replace the disc with one featuring the same region number as this unit. (Page 8, Page 126)
A parental lock message is displayed and playback is not possible.	Parental lock is on.	Turn parental lock off or change the level. (Page 100)
Parental lock cannot be canceled.	The code number is incorrect.	Input the correct code number. (Page 100)
	You have forgotten your code number.	Press CLEAR 10 times to cancel the code number. (Page 101)
Dialog language (and subtitle language) cannot be switched.	The DVD playing does not feature multiple language recordings.	You cannot switch among multiple languages if they are not recorded on the disc.
	You can only switch between items indicated in the disc menu.	Switch using the disc menu.
No subtitles are displayed.	The DVD playing does not feature subtitles.	Subtitles are not displayed if they are not recorded on the disc.
	You can only switch between items indicated in the disc menu.	Switch using the disc menu.
Playback is not with the audio language and subtitle language settings selected in DVD SETUP MENU .	The DVD playing does not feature dialog or subtitles in the language selected in DVD SETUP MENU .	Switching to a selected language is not possible if the language selected in DVD SETUP MENU is not recorded on the disc.

Additional Information

Symptom	Cause	Action (See)
Switching the viewing angle is not possible.	The DVD playing does not feature scenes shot from multiple angles.	You cannot switch between multiple angles if the DVD does not feature scenes recorded from multiple angles.
	You are trying to switch to multiple angle viewing of a scene that is not recorded from multiple angles.	Switch between multiple angles when watching scenes recorded from multiple angles.
The picture is extremely unclear/distorted and dark during playback.	The disc features a signal to prohibit copying. (Some discs may have this.)	Since this unit is compatible with the copy guard analog copy protect system, when playing a disc that has a signal prohibiting copying, the picture may suffer from horizontal stripes or other imperfections when viewed on some displays. This does not mean this unit is malfunctioning.

Problems during Video CD playback

Symptom	Cause	Action (See)
The PBC (playback control) menu display cannot be called up.	The Video CD playing does not feature PBC.	This operation is not possible with Video CDs not featuring PBC.
Repeat play and track/time search are not possible.	The Video CD playing features PBC.	This operation is not possible with Video CDs featuring PBC.



Error messages

When you contact your dealer or your nearest Pioneer Service Center, be sure to record the error message.

Message	Cause	Action (See)
ERROR-02	Dirty disc	Clean disc.
	Scratched disc	Replace disc.
ERROR-05	Electrical or mechanical	Press RESET .
DIFFERENT REGION DISC (REGION ERR)	The disc does not have the same region number as this unit	Replace the DVD video with one bearing the correct region number.
NON PLAYABLE DISC (NON-PLAY)	This type of disc cannot be played by this unit	Replace the disc with one this unit can play.
	The disc is loaded upside down	Check that the disc is loaded correctly.
THERMAL PROTECTION IN MOTION (TEMP)	The temperature of this unit is outside the normal operating range	Wait until the unit's temperature returns to within normal operating limits.
NO AUDIO	The inserted disc does not contain any files that can be played back	Replace disc.

Additional Information

Message	Cause	Action (See)
Track Skipped	The inserted disc contains WMA files that are protected by DRM	Replace disc.
PROTECT	All the files on the inserted disc are secured by DRM	Replace disc.

Understanding auto TA and EQ error messages

When correct measurement of car interior acoustic characteristics is not possible using the auto TA and EQ, an error message may appear on the display. If an error message appears, refer to the table below to see what the problem is and the suggested method of correcting the problem. After checking, try again.

Message	Cause	Action
Error check MIC	Microphone is not connected.	Plug the supplied microphone securely into the jack.
Error check front SP, Error check FL SP, Error check FR SP, Error check center SP, Error check RL SP, Error check RR SP, Error check subwoofer	The microphone cannot pick up the measuring tone of a speaker.	<ul style="list-style-type: none"> • Confirm that the speakers are connected correctly. • Correct the input level setting of the power amp connected to the speakers. • Set the microphone correctly.
Error check noise	The surrounding noise level is too high.	<ul style="list-style-type: none"> • Stop your car in a place that is as quiet as possible, and switch off the engine, air conditioner or heater. • Set the microphone correctly.

Additional Information

DVD player and care

- Use only normal, round discs. If you insert irregular, non-round, shaped discs they may jam in the DVD player or not play properly.

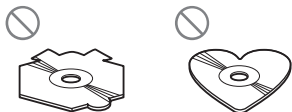

- Check all discs for cracks, scratches or warping before playing. Discs that have cracks, scratches or are warped may not play properly. Do not use such discs.
- Avoid touching the recorded (non-printed) surface when handling the disc.
- Store discs in their cases when not in use.
- Keep discs out of direct sunlight and do not expose the discs to high temperatures.
- Do not attach labels, write on or apply chemicals to the surface of the discs.
- To clean a disc, wipe the disc with a soft cloth outward from the center.



- If the heater is used in cold weather, condensation may form on components inside the DVD player. Condensation may cause the DVD player to not operate properly. If you think that condensation is a problem turn off the DVD player for an hour or so to allow it to dry out and wipe any damp discs with a soft cloth to remove the moisture.
- Road shocks may interrupt disc playback. ■

DVD discs

- With some DVD video discs, it may not be possible to use certain functions.
- It may not be possible to play back some DVD video discs.
- When DVD-R/DVD-RW discs are used, playback is possible only for discs which have been finalized.
- When DVD-R/DVD-RW discs are used, playback is possible only for discs which have been recorded with the Video format (video mode). It is not possible to play back DVD-RW discs which have been recorded with the Video Recording format (VR mode).
- It may not be possible to play back DVD-R/DVD-RW discs which have been recorded with the Video format (video mode), because of disc characteristics, scratches or dirt on the disc, or dirt, condensation, etc. on the lens of this unit.
- It is not possible to play back DVD-ROM/DVD-RAM discs.
- Playback of discs recorded on a personal computer may not be possible, depending on the application settings and the environment. Please record with the correct format. (For details, contact the manufacturer of the application.) ■

CD-R/CD-RW discs

- When CD-R/CD-RW discs are used, playback is possible only for discs which have been finalized.
- It may not be possible to play back CD-R/CD-RW discs recorded on a music CD recorder or a personal computer because of disc characteristics, scratches or dirt on the disc, or dirt, condensation, etc., on the lens of this unit.

Additional Information

- Playback of discs recorded on a personal computer may not be possible, depending on the application settings and the environment. Please record with the correct format. (For details, contact the manufacturer of the application.)
- Playback of CD-R/CD-RW discs may become impossible in case of direct exposure to sunlight, high temperatures, or the storage conditions in the vehicle.
- Titles and other text information recorded on a CD-R/CD-RW disc may not be displayed by this unit (in the case of audio data (CD-DA)).
- Read the precautions with CD-R/CD-RW discs before using them. 

Dual Discs

- Dual Discs are two-sided discs that have a recordable CD for audio on one side and a recordable DVD for video on the other.
- Playback of the DVD side is possible with this unit. However, since the CD side of Dual Discs is not physically compatible with the general CD standard, it may not be possible to play the CD side with this unit.
- Frequent loading and ejecting of a Dual Disc may result in scratches on the disc. Serious scratches can lead to playback problems on this unit. In some cases, a Dual Disc may become stuck in the disc loading slot and will not eject. To prevent this, we recommend you refrain from using Dual Disc with this unit.
- Please refer to the information from the disc manufacturer for more detailed information about Dual Discs. 

MP3, WMA and AAC files

- MP3 is short for MPEG Audio Layer 3 and refers to an audio compression technology standard.
- WMA is short for Windows Media™ Audio and refers to an audio compression technology that is developed by Microsoft Corporation. WMA data can be encoded by using Windows Media Player version 7 or later.
- AAC is short for Advanced Audio Coding and refers to an audio compression technology standard.
- This unit may not operate correctly depending on the application used to encode WMA files.
- Depending on the version of Windows Media Player used to encode WMA files, album names and other text information may not be correctly displayed.
- There may be a slight delay when starting playback of WMA/AAC files encoded with image data.
- This unit allows playback of MP3/WMA/AAC files on CD-R/RW/ROM and DVD-R/RW/ROM discs. Disc recordings compatible with level 1 and level 2 of ISO9660 and with the Romeo and Joliet file system can be played back.
- It is possible to play back multi-session compatible recorded discs.
- MP3/WMA/AAC files are not compatible with packet write data transfer.
- The maximum number of characters which can be displayed for a file name, including the extension (.mp3, .wma or .m4a), is 64, from the first character.
- The maximum number of characters which can be displayed for a folder name is 64.
- In case of files recorded according to the Romeo file system, only the first 64 characters can be displayed.

Additional Information

- The folder selection sequence for playback and other operations becomes the writing sequence used by the writing software. For this reason, the expected sequence at the time of playback may not coincide with the actual playback sequence. However, there also is some writing software which permits setting of the playback order.
- Some audio CDs contain tracks that merge into one another without a pause. When these discs are converted to MP3/WMA/AAC files and burned to a CD-R/RW/ROM or a DVD-R/RW/ROM, the files will be played back on this player with a short pause between each one, regardless of the length of the pause between tracks on the original audio CD.
- There is no compatibility with the MP3i (MP3 interactive) or mp3 PRO formats.
- The sound quality of MP3 files generally becomes better with an increased bit rate. This unit can play recordings with bit rates from 8 kbps to 320 kbps, but in order to be able to enjoy sound of a certain quality, we recommend using only discs recorded with a bit rate of at least 128 kbps.

Important

- When naming an MP3/WMA/AAC file, add the corresponding filename extension (.mp3, .wma or .m4a).
- This unit plays back files with the filename extension (.mp3, .wma or .m4a) as an MP3/WMA/AAC file. To prevent noise and malfunctions, do not use these extensions for files other than MP3/WMA/AAC files.

MP3 additional information

- Files are compatible with the ID3 Tag Ver. 1.0, 1.1, 2.2 and 2.3 formats for display of album (disc title), track (track title), artist (track artist) and comments. Ver. 2.x of ID3 Tag is given priority when both Ver. 1.x and Ver. 2.x exist.
- The emphasis function is valid only when MP3 files of 32, 44.1 and 48 kHz frequencies are played back. (16, 22.05, 24, 32, 44.1, 48 kHz sampling frequencies can be played back.)
- There is no m3u playlist compatibility.

WMA additional information

- This unit plays back WMA files encoded by Windows Media Player version 7, 7.1, 8, 9 and 10.
- You can only play back WMA files in the frequencies 32, 44.1 and 48 kHz.
- The sound quality of WMA files generally becomes better with an increased bit rate. This unit can play recordings with bit rates from 48 kbps to 320 kbps (CBR) or from 48 kbps to 384 kbps (VBR), but in order to be able to enjoy sound of a certain quality, we recommend using discs recorded with a higher bit rate.
- This unit doesn't support the following formats.
 - Windows Media Audio 9 Professional (5.1ch)
 - Windows Media Audio 9 Lossless
 - Windows Media Audio 9 Voice

AAC additional information

- This unit plays back AAC files encoded by iTunes® version 4.6.
- This unit plays back AAC files in the sampling frequencies 11.025, 16, 22.05, 24, 32, 44.1 and 48 kHz.

Additional Information

- The sound quality of AAC files generally becomes better with an increased transmission rate. This unit can play recordings with transmission rates from 16 kbps to 320 kbps, but in order to be able to enjoy sound of a certain quality, we recommend using discs recorded with a higher transmission rate.
- This unit doesn't support the following formats.
 - Apple Lossless

About folders and MP3/WMA/AAC files

- An outline of a disc with MP3/WMA/AAC files on it is shown below. Subfolders are shown as folders in the folder currently selected.

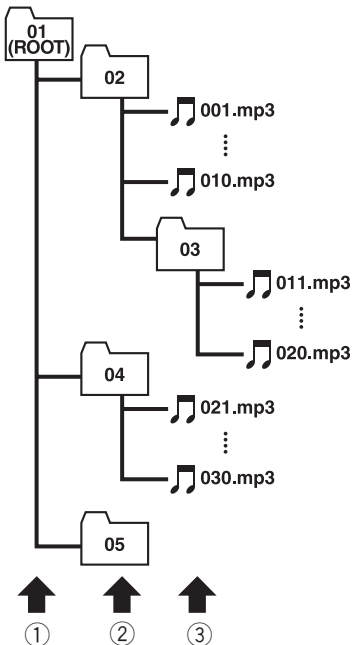

- ① **First level**
- ② **Second level**
- ③ **Third level**

Notes

- This unit assigns folder numbers. The user cannot assign folder numbers.
- It is not possible to check folders that do not include MP3/WMA/AAC files. (These folders will be skipped without displaying the folder number.)
- MP3/WMA/AAC files in up to 8 tiers of folders can be played back. However, there is a delay in the start of playback on discs with numerous tiers. For this reason we recommend creating discs with no more than 2 tiers.
- It is possible to play back up to 255 folders on one disc.

JPEG picture files

- JPEG is short for Joint Photographic Experts Group and refers to a still image compression technology standard.
- Files are compatible with Baseline JPEG and EXIF 2.1 still image up to resolution of 8 192 × 7 680. (EXIF format is used most commonly with digital still cameras.)
- EXIF format that processed by the personal computer may not be played back.
- There is no progressive JPEG compatibility.

Important

- When naming a JPEG picture file, add the corresponding filename extension (.jpg, .jpeg or .jpe).

Additional Information

- This unit plays back files with the filename extension (.jpg, .jpeg or .jpe) as a JPEG picture file. To prevent malfunctions, do not use these extensions for files other than JPEG picture files. 
- Do not disassemble or modify this unit, as there are high-voltage components inside which may cause an electric shock. Be sure to consult your dealer or the nearest authorized PIONEER Service Station for internal inspection, adjustments or repairs.

DivX video files

- Plays all versions of DivX® video (including DivX® 6) with standard playback of DivX® media files
- For more details about DivX, visit the following site:
<http://www.divx.com/>



Important

- When naming a DivX video file, add the corresponding filename extension (.avi or .divx).
- This unit plays back files with the filename extension (.avi or .divx) as a DivX video file. To prevent noise and malfunctions, do not use these extensions for files other than DivX video files. 

Using the display correctly



CAUTION

- If liquid or foreign matter should get inside this unit, turn off the power immediately and consult your dealer or the nearest authorized PIONEER Service Station. Do not use the unit in this condition because doing so may result in a fire, electric shock, or other failure.
- If you notice smoke, a strange noise or smell, or any other abnormal signs from the display, turn off the power immediately and consult your dealer or the nearest authorized PIONEER Service Station. Using this unit in this condition may result in permanent damage to the system.
- When the display is subjected to direct sunlight for a long period of time, it will become very hot resulting in possible damage to the LCD screen. When not using this unit, close the display and avoid exposing it to direct sunlight.
- The display should be used within the temperature ranges shown below.
Storage temperature range: -20°C to $+80^{\circ}\text{C}$
At temperatures higher or lower than the operating temperature range the display may not operate normally.
- The LCD screen of this unit is exposed in order to increase its visibility within the vehicle. Please do not press strongly on it as this may damage it.
- Do not place anything on the display when it is opened. Also, do not attempt to carry out angle adjustment, or open/close the display by hand. Applying strong force to the display may damage it.
- Do not push the LCD screen with much force as this may scratch it.
- Be careful not to place anything between the display and the main body when the display is opening or closing. If an object gets between the display and main body, the display may stop working.

Additional Information

Liquid crystal display (LCD) screen

- If the display is near the vent of an air conditioner when it is opened, make sure that air from the air conditioner is not blowing on it. Heat from the heater may damage the LCD screen, and cool air from the cooler may cause moisture to form inside the display resulting in possible damage. Also, if the display is cooled down by the cooler, the screen may become dark, or the life span of the small fluorescent tube used inside the display may be shortened.
- Small black dots or white dots (bright dots) may appear on the LCD screen. These are due to the characteristics of the LCD screen and do not indicate a problem with the display.
- At low temperatures, the LCD screen may be dark for a while after the power is turned on.
- The LCD screen will be difficult to see if it is exposed to direct sunlight.
- When using a portable phone, keep the antenna of the portable phone away from the display to prevent disruption of the video by the appearance of spots, colored stripes, etc.

Keeping the display in good condition

- When removing dust from the screen or cleaning the display, first turn the system power off, then wipe with the **supplied cloth**.
- When wiping the screen, take care not to scratch the surface. Do not use harsh or abrasive chemical cleaners.

Small fluorescent tube

- A small fluorescent tube is used inside the display to illuminate the LCD screen.

- The fluorescent tube should last for approximately 10 000 hours, depending on operating conditions. (Using the display at low temperatures reduces the service life of the fluorescent tube.)
- When the fluorescent tube reaches the end of its useful life, the screen will be dark and the image will no longer be projected. If this happens, consult your dealer or the nearest authorized PIONEER Service Station. 

Additional Information

Language code chart for DVD

Language (code), input code	Language (code), input code	Language (code), input code
Japanese (ja), 1001	Guarani (gn), 0714	Pashto, Pushto (ps), 1619
English (en), 0514	Gujarati (gu), 0721	Quechua (qu), 1721
French (fr), 0618	Hausa (ha), 0801	Rhaeto-Romance (rm), 1813
Spanish (es), 0519	Hindi (hi), 0809	Kirundi (rn), 1814
German (de), 0405	Croatian (hr), 0818	Romanian (ro), 1815
Italian (it), 0920	Hungarian (hu), 0821	Kinyarwanda (rw), 1823
Chinese (zh), 2608	Armenian (hy), 0825	Sanskrit (sa), 1901
Dutch (nl), 1412	Interlingua (ia), 0901	Sindhi (sd), 1904
Portuguese (pt), 1620	Interlingue (ie), 0905	Sangho (sg), 1907
Swedish (sv), 1922	Inupiak (ik), 0911	Serbo-Croatian (sh), 1908
Russian (ru), 1821	Indonesian (in), 0914	Sinhalese (si), 1909
Korean (ko), 1115	Icelandic (is), 0919	Slovak (sk), 1911
Greek (el), 0512	Hebrew (iw), 0923	Slovenian (sl), 1912
Afar (aa), 0101	Yiddish (ji), 1009	Samoan (sm), 1913
Abkhazian (ab), 0102	Javanese (jw), 1023	Shona (sn), 1914
Afrikaans (af), 0106	Georgian (ka), 1101	Somali (so), 1915
Amharic (am), 0113	Kazakh (kk), 1111	Albanian (sq), 1917
Arabic (ar), 0118	Greenlandic (kl), 1112	Serbian (sr), 1918
Assamese (as), 0119	Cambodian (km), 1113	Siswati (ss), 1919
Aymara (ay), 0125	Kannada (kn), 1114	Sesotho (st), 1920
Azerbaijani (az), 0126	Kashmiri (ks), 1119	Sundanese (su), 1921
Bashkir (ba), 0201	Kurdish (ku), 1121	Swahili (sw), 1923
Byelorussian (be), 0205	Kirghiz (ky), 1125	Tamil (ta), 2001
Bulgarian (bg), 0207	Latin (la), 1201	Telugu (te), 2005
Bihari (bh), 0208	Lingala (ln), 1214	Tajik (tg), 2007
Bislama (bi), 0209	Laothian (lo), 1215	Thai (th), 2008
Bengali (bn), 0214	Lithuanian (lt), 1220	Tigrinya (ti), 2009
Tibetan (bo), 0215	Latvian (lv), 1222	Turkmen (tk), 2011
Breton (br), 0218	Malagasy (mg), 1307	Tagalog (tl), 2012
Catalan (ca), 0301	Maori (mi), 1309	Setswana (tn), 2014
Corsican (co), 0315	Macedonian (mk), 1311	Tonga (to), 2015
Czech (cs), 0319	Malayalam (ml), 1312	Turkish (tr), 2018
Welsh (cy), 0325	Mongolian (mn), 1314	Tsonga (ts), 2019
Danish (da), 0401	Moldavian (mo), 1315	Tatar (tt), 2020
Bhutani (dz), 0426	Marathi (mr), 1318	Twi (tw), 2023
Esperanto (eo), 0515	Malay (ms), 1319	Ukrainian (uk), 2111
Estonian (et), 0520	Maltese (mt), 1320	Urdu (ur), 2118
Basque (eu), 0521	Burmese (my), 1325	Uzbek (uz), 2126
Persian (fa), 0601	Nauru (na), 1401	Vietnamese (vi), 2209
Finnish (fi), 0609	Nepali (ne), 1405	Volapük (vo), 2215
Fiji (fj), 0610	Norwegian (no), 1415	Wolof (wo), 2315
Faroese (fo), 0615	Occitan (oc), 1503	Xhosa (xh), 2408
Frisian (fy), 0625	Oromo (om), 1513	Yoruba (yo), 2515
Irish (ga), 0701	Oriya (or), 1518	Zulu (zu), 2621
Scots-Gaelic (gd), 0704	Panjabi (pa), 1601	
Galician (gl), 0712	Polish (pl), 1612	



Additional Information

DSP adjustment value record sheet

Please make a copy of sheet below as desired.

Parametric equalizer setting (PARAMETRIC EQ) (when selecting multi-channel mode only)

Speaker unit	BAND	Frequency	Level	Q.Fac
FRONT LEFT	LOW			
	MID			
	HIGH			
FRONT RIGHT	LOW			
	MID			
	HIGH			
REAR LEFT	LOW			
	MID			
	HIGH			
REAR RIGHT	LOW			
	MID			
	HIGH			
FRONT CENTER	LOW			
	MID			
	HIGH			
REAR CENTER	LOW			
	MID			
	HIGH			

Graphic equalizer setting (GRAPHIC EQ) (when selecting 2-channel mode only)

Speaker unit	50	80	125	200	315	500	800	1.25k	2k	3.15k	5k	8k	12.5k
LEFT													
RIGHT													

Speaker setting (SPEAKER SETTING)

Speaker unit	Front center	Front	Rear	Rear center	Subwoofer
Setting					

 Cut-off frequency setting (CUT OFF)

Additional Information

Speaker unit	FREQUENCY	SLOPE	PHASE
TWEETER LEFT			—
TWEETER RIGHT			—
FRONT LEFT	LOW		—
	HIGH		—
FRONT RIGHT	LOW		—
	HIGH		—
REAR LEFT			—
REAR RIGHT			—
CENTER			—
REAR CENTER			—
SUBWOOFER			

The following filters (speaker units) are available on the network mode only.

- **TWEETER LEFT**
- **TWEETER RIGHT**
- **LOW** of the front speakers

Time alignment setting (TIME ALIGNMENT) and speaker level setting (SPEAKER LEVEL)

Speaker unit	TIME ALIGNMENT	SPEAKER LEVEL
Tweeter left		
Tweeter right		
Front center		
Front left		
Front right		
Rear left		
Rear right		
Rear center		
Subwoofer		

Tweeters are available on the network mode only.



Additional Information

Terms

AAC

AAC is short for Advanced Audio Coding and refers to an audio compression technology standard used with MPEG 2 and MPEG 4.

Aspect ratio

This is the width-to-height ratio of a TV screen. A regular display has an aspect ratio of 4:3. Wide screen displays have an aspect ratio of 16:9, providing a bigger picture for exceptional presence and atmosphere.

Bit rate

This expresses data volume per second, or bps (bits per second) units. The higher the rate, the more information is available to reproduce the sound. Using the same encoding method (such as MP3), the higher the rate, the better the sound.

Bonus group

An 'extra' group on some DVD audio discs that requires a key number to access.

Browsable pictures

A feature of some DVD audio discs in which you can browse still pictures recorded on the disc while the audio is played back.

Chapter

DVD titles are in turn divided into chapters which are numbered in the same way as the chapters of a book. With DVD video discs featuring chapters, you can quickly find a desired scene with chapter search.

DivX

DivX is a popular media technology created by DivX, Inc. DivX media files contain highly compressed video with high visual quality that maintains a relatively small file size. DivX files can also include advanced media features like menus, subtitles, and alternate audio tracks.

Many DivX media files are available for download online, and you can create your own using your personal content and easy-to-use tools from DivX.com.

DivX Certified

DivX Certified products are officially tested by the creators of DivX and guaranteed to play all versions of DivX video, including DivX 6. Certified products qualify for one of several DivX Profiles that designate the type of video the product supports, from compact portable video to high-definition video.

Dolby Digital

Dolby Digital provides multi-channel audio from up to 5.1 independent channels. This is the same as the Dolby Digital surround sound system used in theaters.

Dolby Digital EX

Dolby Digital EX creates six full-bandwidth output channels from 5.1-channel sources. This is done using a matrix decoder that derives three surround channels from the two in the original recording.

Dolby Pro Logic II

Dolby Pro Logic II can create five full-bandwidth output channels from two-channel sources. This new technology enables a discrete 5-channel playback with 2 front channels, 1 center channel, and 2 rear channels. A music mode is also available for 2-channel sources in addition to the movie mode.

DTS

This stands for Digital Theater Systems. DTS is a surround system delivering multi-channel audio from up to 6 independent channels.

Additional Information

DTS 96/24

DTS 96/24 is an extension of the original DTS Digital Surround which offers high quality 96 kHz/24-bit audio using a DTS 96/24 decoder. This format is also fully backward compatible with all existing decoders. This means that DVD players can play this software using a conventional DTS 5.1 channel decoder.

DTS Neo:6

DTS Neo:6 can generate 6.1 channel surround sound from any matrixed stereo source (such as video or TV) and from 5.1 channel sources. It uses both the channel information already encoded into the source, as well as its own processing to determine channel localization (with two channel sources, the “.1” subwoofer channel is generated by bass management in the receiver). Two modes (Cinema and Music) are available using DTS Neo:6 with two channel sources.

DTS-ES

DTS-ES is a decoder that is capable of decoding both DTS-ES Discrete 6.1 and DTS-ES Matrix 6.1 encoded sources. DTS-ES Discrete 6.1 gives ‘true’ 6.1 channel sound, with a completely separate (discrete) surround back channel. DTS-ES Matrix 6.1 has a surround back channel matrixed into the surround left/right channels. Both sources are also compatible with a conventional DTS 5.1 channel decoder.

Dynamic range control

Dolby Digital has a function for compressing the difference between the loudest and softest sounds: Dynamic range control. This control ensures sounds with an increased dynamic range are heard clearly even at low volume levels.

EXIF (Exchangeable image file)

A file format developed by Fuji Photo Film for digital still cameras. Digital cameras from various manufacturers use this compressed file

format which carries date, time and thumbnail information, as well as the picture data.

Group

A collection of tracks on a DVD audio disc. Equivalent to a DVD video title.

ID3 tag

This is a method of embedding track-related information in an MP3 file. This embedded information can include the track title, the artist’s name, the album title, the music genre, the year of production, comments and other data. The contents can be freely edited using software with ID3 Tag editing functions. Although the tags are restricted as to the number of characters, the information can be viewed when the track is played back.

ISO9660 format

This is the international standard for the format logic of CD-ROM folders and files. For the ISO9660 format, there are regulations for the following two levels.

Level 1:

The file name is in 8.3 format (the name consists of up to 8 characters, half-byte English capital letters and half-byte numerals and the “_” sign, with a file-extension of three characters).

Level 2:

The file name can have up to 31 characters (including the separation mark “.” and a file extension). Each folder contains less than 8 hierarchies.

Extended formats

Joliet:

File names can have up to 64 characters.

Romeo:

File names can have up to 128 characters.

JPEG

This stands for Joint Photographic Experts Group, and is an international still image compression standard.

Additional Information

Linear PCM (LPCM)/Pulse code modulation

This stands for linear pulse code modulation, which is the signal recording system used for music CDs and DVDs. Generally, DVDs are recorded with higher sampling frequency and bit rate than CDs. Therefore, DVDs can provide higher sound quality.

m3u

Playlists created using the "WINAMP" software have a playlist file extension (.m3u).

MP3

MP3 is short for MPEG Audio Layer 3. It is an audio compression standard set by a working group (MPEG) of the ISO (International Standards Organization). MP3 is able to compress audio data to about 1/10th the level of a conventional disc.

MPEG

This stands for Moving Pictures Experts Group, and is an international video image compression standard. Some DVDs feature digital audio compressed and recorded using this system.

MS ADPCM

This stands for Microsoft adaptive differential pulse code modulation, which is the signal recording system used for the multimedia software of Microsoft Corporation.

Multi-angle

With regular TV programs, although multiple cameras are used to simultaneously shoot scenes, only images from one camera at a time are transmitted to your TV. Some DVDs feature scenes shot from multiple angles, letting you choose your viewing angle as desired.

Multi-audio (Multilingual dialog)

Some DVDs feature dialog recorded in multiple languages. Dialog in up to 8 languages

can be recorded on a single disc, letting you choose as desired.

Multi-session

Multi-session is a recording method that allows additional data to be recorded later. When recording data on a CD-ROM, CD-R or CD-RW, etc., all data from beginning to end is treated as a single unit or session. Multi-session is a method of recording more than 2 sessions on one disc.

Multi-subtitle

Subtitles in up to 32 languages can be recorded on a single DVD, letting you choose as desired.

Number of quantization bits

The number of quantization bits is one factor in the overall sound quality; the higher the "bit-depth", the better the sound quality. However, increasing the bit-depth also increases the amount of data and therefore storage space required.

Packed PCM

A lossless compression system that enables more PCM audio to be stored on a DVD audio disc than would otherwise be possible.

Packet write

This is a general term for a method of writing on CD-R, etc., at the time required for a file, just as is done with files on floppy or hard discs.

Parental lock

Some DVD video discs with violent or adult-oriented scenes feature parental lock which prevents children from viewing such scenes. With this kind of disc, if you set the unit's parental lock level, playback of scenes inappropriate for children will be disabled, or these scenes will be skipped.

Additional Information

Playback control (PBC)

This is a playback control signal recorded on Video CDs (Version 2.0). Using menu displays provided by Video CDs with PBC lets you enjoy playback of simple interactive software and software with search functions. You can also enjoy viewing high- and standard-resolution still images.

Region number

DVD players and DVD discs feature region numbers indicating the area in which they were purchased. Playback of a DVD is not possible unless it features the same region number as the DVD player. This unit's region number is displayed on the bottom of the unit.

Slideshow

A feature of some DVD discs in which still pictures recorded on the disc cycle automatically while the audio is played back.

Title

DVD video discs have high data capacity, enabling recording of multiple movies on a single disc. If, for example, one disc contains three separate movies, they are divided into title 1, title 2 and title 3. This lets you enjoy the convenience of title search and other functions.

VBR

VBR is short for variable bit rate. Generally speaking CBR (constant bit rate) is more widely used. But by flexibly adjusting the bit rate according to the needs of audio compression, it is possible to achieve compression-priority sound quality.

WMA

WMA is short for Windows Media™ Audio and refers to an audio compression technology that is developed by Microsoft Corporation. WMA data can be encoded by using Windows Media Player version 7 or later.

Windows Media and the Windows logo are trademarks or registered trademarks of Microsoft Corporation in the United States and/or other countries. ■

Additional Information

Specifications

General

Rated power source 14.4 V DC
(allowable voltage range:
12.0 V to 14.4 V DC)

Grounding system Negative type

Head unit:

Max. current consumption
..... 3.7 A

Dimensions (W × H × D):

DIN
Chassis 178 × 50 × 160 mm
Nose 188 × 58 × 36 mm
D
Chassis 178 × 50 × 165 mm
Nose 170 × 46 × 31 mm

Weight 2.3 kg

Hideaway unit:

Max. current consumption
..... 21.5 A

Dimensions (W × H × D)

..... 280 × 37 × 171 mm

Weight 1.4 kg

Display

Screen size/aspect ratio 7 inch wide/15:9
(effective display area: 152.4
× 91.44 mm)

Pixels 1 152 000 (800 × 480 × 3)

Type TFT active matrix, transmis-
sive type

Color system NTSC/PAL compatible

Storage temperature range
..... -20 °C to +80 °C

Angle adjustment 50° to 110°
(initial settings: 90°)

Audio

Maximum power output 50 W × 8
Continuous power output ... 22 W × 8 (50 Hz to 15 000
Hz, 5% THD, 4 Ω load, both
channels driven)

Load impedance 4 Ω (4 Ω to 8 Ω allowable)

Preout max output level/output impedance
..... 5.0 V × 9/100 Ω

Decoder Linear PCM, Dolby Digital,
Dolby Digital EX, Dolby EX,
Dolby Pro Logic II, DTS,
DTS-CD, DTS-ES (matrix,
discrete), DTS 96/24, DTS
Neo:6, AAC

Sound setting

Position Front left/Front right/Front/
All/Off

Parametric equalizer (multi-channel mode):

Band 3 band
Frequency 40/50/63/80/100/125/160/
200/250/315/400/500/630/
800/1k/1.25k/1.6k/2k/2.5k/
3.15k/4k/5k/6.3k/8k/10k/
12.5k Hz
Q Factor 1.2/3.6
Gain ±12dB (2 dB/step)

Graphic equalizer (2-channel mode):

Band 13 band
Frequency 50/80/125/200/315/500/800/
1.25k/2k/3.15k/5k/8k/12.5k
Hz
Q Factor 5.0
Gain ±12dB (2 dB/step)

Speaker setting:

Front Large/Small
Front center Large/Small/Off
Rear Large/Small/Off
Rear center Large/Small/Off
Subwoofer On/Off

Time alignment 0 cm to 500 cm (2.5 cm/
step)

Speaker level -24 dB to +10 dB (1 dB/
step)

Cut-off frequency

Front (L/R independent) (Standard mode):

HPF:
Frequency 50/63/80/100/125/160/200
Hz
Slope -6/-12/-18 dB/oct
Mute On/Off

Front (L/R independent) (Network mode):

High HPF:
Frequency 1.25/1.6/2/2.5/3.15/4/5/6.3/8/
10/12.5 kHz
Slope -6/-12 dB/oct
Low LPF:
Frequency 1.25/1.6/2/2.5/3.15/4/5/6.3/8/
10/12.5 kHz

Additional Information

Slope	0 (Pass)/-6/-12 dB/oct
Low HPF:	
Frequency	50/63/80/100/125/160/200 Hz
Slope	-6/-12/-18 dB/oct
Mute	On/Off
Front center:	
HPF:	
Frequency	50/63/80/100/125/160/200 Hz
Slope	-6/-12/-18 dB/oct
Mute	On/Off
Rear (L/R independent):	
HPF:	
Frequency	50/63/80/100/125/160/200 Hz
Slope	-6/-12/-18 dB/oct
Mute	On/Off
Rear center:	
HPF:	
Frequency	50/63/80/100/125/160/200 Hz
Slope	-6/-12/-18 dB/oct
Mute	On/Off
Subwoofer:	
LPF:	
Frequency	50/63/80/100/125/160/200 Hz
Slope	0 (Pass)/-6/-12/-18 dB/oct
Phase	Normal/Reverse
Mute	On/Off
DVD Player	
System	DVD audio, DVD video, Video CD, CD, MP3, WMA, AAC, DivX, JPEG system
Usable discs	DVD audio, DVD video, Video CD, dtsCD, CD, CD-R/RW, DVD-R/RW
Region number:	
for Southeast Asian models	3
for South American and Oceanian models	4
for Middle East Asian and South African models	2
Signal format:	
Sampling frequency	16/22.05/24/44.1/48/88.2/96/176.4/192 kHz
Number of quantization bits	16/20/24; linear

Frequency response	5 Hz to 96 000 Hz (with DVD, at sampling frequency 192 kHz)
Signal-to-noise ratio	102 dB (1 kHz) (IEC-A network) (CD: 102 dB (1 kHz) (IEC-A network))
Dynamic range	100 dB (1 kHz) (CD: 98 dB (1 kHz))
Distortion	0.008 % (1 kHz)
Output level:	
Video	1.0 Vp-p/75 Ω (± 0.2 V)
Audio	1.1 V (1 kHz, 0 dB)
Number of channels	2 (stereo), Digital 6 ch
MP3 decoding format	MPEG-1 & 2 Audio Layer 3
WMA decoding format	Ver. 7, 7.1, 8, 9, 10 (2ch audio) (Windows Media Player)
AAC decoding format	iTunes [®] Ver. 4.6

FM tuner

Frequency range	87.5 MHz to 108.0 MHz
Usable sensitivity	8 dBf (0.7 μ V/75 Ω mono, S/N: 30 dB)
50 dB quieting sensitivity	10 dBf (0.9 μ V/75 Ω mono)
Signal-to-noise ratio	75 dB (IEC-A network)
Distortion	0.3 % (at 65 dBf, 1 kHz, stereo) 0.1 % (at 65 dBf, 1 kHz, mono)
Frequency response	30 Hz to 15 000 Hz (± 3 dB)
Stereo separation	45 dB (at 65 dBf, 1 kHz)
Selectivity	80 dB (± 200 kHz)

AM tuner

Frequency range	531 kHz to 1 602 kHz (9 kHz) 530 kHz to 1 640 kHz (10 kHz)
Usable sensitivity	18 μ V (S/N: 20 dB)
Signal-to-noise ratio	65 dB (IEC-A network)

Infrared remote control

Wavelength	945 nm
Output	typ: 10 mw/sr per Infrared LED



Note

Specifications and the design are subject to possible modifications without notice due to improvements. 

- A**
- Angle icon 34, 99
 - Aspect ratio 99, 123
 - Audio language 34, 48, 98
- B**
- Bonus group 123
 - Bookmark 33
 - Brightness 106
 - Browsable pictures 123
- C**
- Chapter 123
 - Code number 100
 - Color 106
 - Contrast 106
- D**
- DivX 123
 - DivX Certified 123
 - Dolby Digital 123
 - Dolby Digital EX 10, 123
 - Dolby Pro Logic II 123
 - DTS 123
 - DTS 96/24 124
 - DTS Neo:6 124
 - DTS-ES 10, 124
 - Dynamic range control 124
- E**
- EXIF 124
- G**
- Group 124
- H**
- Hue 106
- J**
- JPEG 124
- L**
- Language code chart 120
 - Linear PCM (LPCM) 125
- M**
- Menu language 99
 - MPEG 125
 - Multi-angle 34, 125
 - Multi-audio 34, 48, 125
 - Multi-subtitle 34, 48, 125
- P**
- Packed PCM 125
 - Parental lock 100, 125
 - PBC (playback control) 37
 - Playback control (PBC) 126
- R**
- Region number 8, 126
- S**
- Slideshow 126
 - Subtitle language 34, 48, 98
- T**
- Title 126
 - TV aspect 99
- V**
- Video CD 8
- W**
- Wide screen mode 106

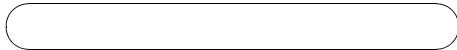
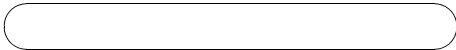

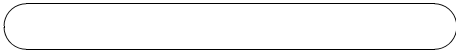

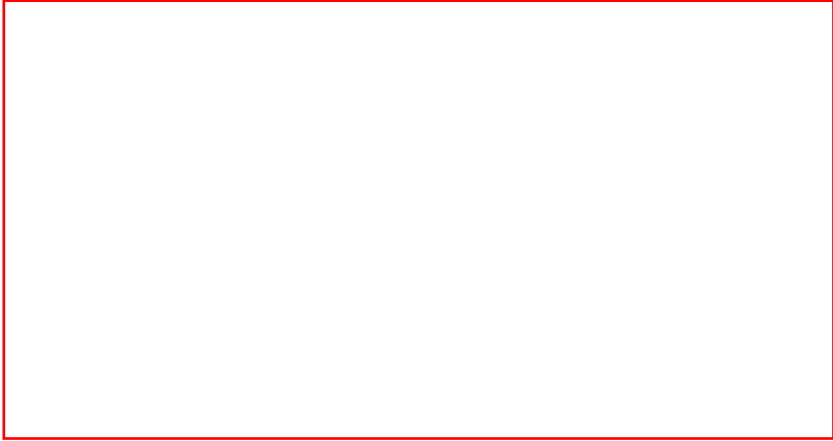

PIONEER CORPORATION

4-1, MEGURO 1-CHOME, MEGURO-KU, TOKYO 153-8654, JAPAN

PIONEER ELECTRONICS (USA) INC.

P.O. Box 1540, Long Beach, California 90801-1540, U.S.A.
TEL: (800) 421-1404

PIONEER EUROPE NV

Haven 1087, Keetberglaan 1, B-9120 Melsele, Belgium
TEL: (0) 3/570.05.11

PIONEER ELECTRONICS ASIACENTRE PTE. LTD.

253 Alexandra Road, #04-01, Singapore 159936
TEL: 65-6472-7555

PIONEER ELECTRONICS AUSTRALIA PTY. LTD.

178-184 Boundary Road, Braeside, Victoria 3195, Australia
TEL: (03) 9586-6300

PIONEER ELECTRONICS OF CANADA, INC.

300 Allstate Parkway, Markham, Ontario L3R OP2, Canada
TEL: 1-877-283-5901

PIONEER ELECTRONICS DE MEXICO, S.A. de C.V.

Bldv.Manuel Avila Camacho 138 10 piso
Col.Lomas de Chapultepec, Mexico, D.F. 11000
TEL: 55-9178-4270

先鋒股份有限公司

總公司：台北市中山北路二段44號13樓
電話：(02) 2521-3588

先鋒電子（香港）有限公司

香港九龍尖沙咀海港城世界商業中心
9樓901-6室
電話：(0852) 2848-6488

Published by Pioneer Corporation.
Copyright © 2006 by Pioneer Corporation.
All rights reserved.

Printed in Japan

<CRB2234-A> RD, RI, RC

<KMMZX> <06E00000>

Free Manuals Download Website

<http://myh66.com>

<http://usermanuals.us>

<http://www.somanuals.com>

<http://www.4manuals.cc>

<http://www.manual-lib.com>

<http://www.404manual.com>

<http://www.luxmanual.com>

<http://aubethermostatmanual.com>

Golf course search by state

<http://golfingnear.com>

Email search by domain

<http://emailbydomain.com>

Auto manuals search

<http://auto.somanuals.com>

TV manuals search

<http://tv.somanuals.com>